

# FSW

## Signal and Spectrum Analyzer

### User Manual



1173941102  
Version 54

**ROHDE & SCHWARZ**  
Make ideas real



This manual applies to the following FSW models with firmware version 6.10 and later:

- R&S®FSW8 (1331.5003K08 / 1312.8000K08)
- R&S®FSW13 (1331.5003K13 / 1312.8000K13)
- R&S®FSW26 (1331.5003K26 / 1312.8000K26)
- R&S®FSW43 (1331.5003K43 / 1312.8000K43)
- R&S®FSW50 (1331.5003K50 / 1312.8000K50)
- R&S®FSW67 (1331.5003K67 / 1312.8000K67)
- R&S®FSW85 (1331.5003K85 / 1312.8000K85)

In addition to the base unit, the following options are described:

- R&S®FSW-B4, OCXO (1313.0703.02)
- R&S®FSW-B10, external generator control (1313.1622.02)
- R&S®FSW-B13, high-pass filter (1313.0761.02)
- R&S®FSW-B21, external mixer (1313.1100.XX)
- R&S®FSW-B24, preamplifier (1313.0832.XX / 1350.7960.XX)
- R&S®FSW-B25, electronic attenuator (1313.0990.02)
- R&S®FSW-B90G, frequency extension 90 GHz (1331.7693.02)
- R&S®FSW-K19 Noise Power Ratio measurement (1331.8283.02)
- R&S®FSW-K54 EMI measurements (1313.1400.02)
- R&S®FSW-K544 frequency response correction (1338.2716.02)
- R&S®FSW-K553 External frontend control (1350.6118.30)
- R&S®FSW-K980 HUMS (1350.6718.xx)

© 2024 Rohde & Schwarz

Muehldorfstr. 15, 81671 Muenchen, Germany

Phone: +49 89 41 29 - 0

Email: [info@rohde-schwarz.com](mailto:info@rohde-schwarz.com)

Internet: [www.rohde-schwarz.com](http://www.rohde-schwarz.com)

Subject to change – data without tolerance limits is not binding.

R&S® is a registered trademark of Rohde & Schwarz GmbH & Co. KG.

All other trademarks are the properties of their respective owners.

1173.9411.02 | Version 54 | FSW

Throughout this manual, R&S® is indicated as R&S.

# Contents

<b>1</b>	<b>Safety and regulatory information.....</b>	<b>17</b>
1.1	Safety instructions.....	17
1.2	Warning messages in the documentation.....	20
1.3	Korea certification class B.....	21
<b>2</b>	<b>Documentation overview.....</b>	<b>22</b>
2.1	Getting started manual.....	22
2.2	User manuals and help.....	22
2.3	Service manual.....	22
2.4	Instrument security procedures.....	23
2.5	Printed safety instructions.....	23
2.6	Specifications and brochures.....	23
2.7	Release notes and open-source acknowledgment (OSA).....	23
2.8	Application notes, application cards, white papers, etc.....	24
2.9	Videos.....	24
<b>3</b>	<b>Welcome to the FSW.....</b>	<b>25</b>
<b>4</b>	<b>Getting Started.....</b>	<b>26</b>
4.1	Key features.....	26
4.2	Preparing for use.....	27
4.2.1	Lifting and carrying.....	27
4.2.2	Unpacking and checking.....	27
4.2.3	Choosing the operating site.....	27
4.2.4	Setting up the product.....	28
4.2.5	Connecting the AC power.....	30
4.2.6	Switching the instrument on and off.....	30
4.2.7	Connecting to LAN.....	32
4.2.8	Connecting a keyboard.....	33
4.2.9	Connecting an external monitor.....	33
4.2.10	Windows operating system.....	34
4.2.11	Logging on.....	36
4.2.12	Checking the supplied options.....	38

4.2.13	Performing a self-alignment.....	38
4.2.14	Considerations for test setup.....	39
4.2.15	Protecting data using the secure user mode.....	39
<b>4.3</b>	<b>Instrument tour.....</b>	<b>41</b>
4.3.1	Front panel view.....	41
4.3.2	Rear panel view.....	52
<b>4.4</b>	<b>Trying out the instrument.....</b>	<b>61</b>
4.4.1	Measuring a basic signal.....	62
4.4.2	Displaying a spectrogram.....	63
4.4.3	Activating additional measurement channels.....	65
4.4.4	Performing sequential measurements.....	68
4.4.5	Setting and moving a marker.....	69
4.4.6	Displaying a marker peak list.....	70
4.4.7	Zooming into the display.....	71
4.4.8	Zooming into the display permanently.....	74
4.4.9	Saving settings.....	77
4.4.10	Printing and saving results.....	78
<b>4.5</b>	<b>Operating the instrument.....</b>	<b>79</b>
4.5.1	Understanding the display information.....	80
4.5.2	Accessing the functionality.....	89
4.5.3	Changing the focus.....	94
4.5.4	Entering data.....	94
4.5.5	Touchscreen gestures.....	97
4.5.6	Displaying results.....	100
4.5.7	Getting help.....	107
<b>5</b>	<b>Applications, measurement channels, and operating modes.....</b>	<b>109</b>
<b>5.1</b>	<b>Available applications.....</b>	<b>111</b>
<b>5.2</b>	<b>R&amp;S multiview.....</b>	<b>119</b>
<b>5.3</b>	<b>Selecting the operating mode and applications.....</b>	<b>120</b>
<b>5.4</b>	<b>Running a sequence of measurements.....</b>	<b>122</b>
5.4.1	The sequencer concept.....	122
5.4.2	Sequencer settings.....	125
5.4.3	How to set up the sequencer.....	126

<b>6</b>	<b>Measurements and results</b>	<b>127</b>
<b>6.1</b>	<b>Basic measurements</b>	<b>128</b>
6.1.1	Basic measurement types	129
6.1.2	How to perform a basic sweep measurement	130
6.1.3	Measurement examples - measuring a sinusoidal signal	131
6.1.4	Measurement example – measuring levels at low S/N ratios	134
6.1.5	Measurement examples - measuring signal spectra with multiple signals	137
6.1.6	Measurement examples in zero span	143
<b>6.2</b>	<b>Channel power and adjacent-channel power (ACLR) measurement</b>	<b>149</b>
6.2.1	About channel power measurements	149
6.2.2	Channel power results	150
6.2.3	Channel power basics	152
6.2.4	Channel power configuration	165
6.2.5	MSR ACLR configuration	175
6.2.6	How to perform channel power measurements	192
6.2.7	Measurement examples	197
6.2.8	Optimizing and troubleshooting the measurement	203
6.2.9	Reference: predefined CP/ACLR standards	204
6.2.10	Reference: predefined ACLR user standard XML files	205
<b>6.3</b>	<b>Carrier-to-noise measurements</b>	<b>206</b>
6.3.1	About the measurement	207
6.3.2	Carrier-to-noise results	207
6.3.3	Carrier-to-noise configuration	208
6.3.4	How to determine the carrier-to-noise ratio	209
<b>6.4</b>	<b>Occupied bandwidth measurement (OBW)</b>	<b>210</b>
6.4.1	About the measurement	210
6.4.2	OBW results	212
6.4.3	OBW configuration	212
6.4.4	How to determine the occupied bandwidth	215
6.4.5	Measurement example	216
<b>6.5</b>	<b>Noise power ratio (NPR) measurement</b>	<b>216</b>
6.5.1	About noise power ratio (NPR) measurements	217
6.5.2	NPR basics	217

6.5.3	NPR results.....	219
6.5.4	NPR configuration.....	220
6.5.5	Generator setup.....	224
6.5.6	Generator frequency coupling.....	229
6.5.7	How to perform NPR measurements.....	231
6.5.8	Measurement example.....	232
<b>6.6</b>	<b>Spectrum emission mask (SEM) measurement.....</b>	<b>233</b>
6.6.1	About the measurement.....	234
6.6.2	Typical applications.....	234
6.6.3	SEM results.....	234
6.6.4	SEM basics.....	237
6.6.5	SEM configuration.....	247
6.6.6	How to perform a spectrum emission mask measurement.....	266
6.6.7	Measurement example: Multi-SEM measurement.....	270
6.6.8	Reference: SEM file descriptions.....	272
<b>6.7</b>	<b>Spurious emissions measurement.....</b>	<b>279</b>
6.7.1	About the measurement.....	279
6.7.2	Spurious emissions measurement results.....	280
6.7.3	Spurious emissions basics.....	281
6.7.4	Spurious emissions measurement configuration.....	283
6.7.5	How to perform a spurious emissions measurement.....	290
6.7.6	Reference: ASCII export file format (spurious).....	292
<b>6.8</b>	<b>Statistical measurements (APD, CCDF).....</b>	<b>293</b>
6.8.1	About the measurements.....	293
6.8.2	Typical applications.....	294
6.8.3	APD and CCDF results.....	294
6.8.4	APD and CCDF basics - gated triggering.....	296
6.8.5	APD and CCDF configuration.....	297
6.8.6	How to perform an APD or CCDF measurement.....	304
6.8.7	Examples.....	305
6.8.8	Optimizing and troubleshooting the measurement.....	308
<b>6.9</b>	<b>Time domain power measurement.....</b>	<b>308</b>
6.9.1	About the measurement.....	308

6.9.2	Time domain power results.....	308
6.9.3	Time domain power basics - range definition using limit lines.....	309
6.9.4	Time domain power configuration.....	310
6.9.5	How to measure powers in the time domain.....	311
6.9.6	Measurement example.....	312
<b>6.10</b>	<b>Harmonic distortion measurement.....</b>	<b>313</b>
6.10.1	About the measurement.....	314
6.10.2	Harmonic distortion basics.....	314
6.10.3	Harmonic distortion results.....	316
6.10.4	Harmonic distortion configuration.....	317
6.10.5	How to determine the harmonic distortion.....	319
<b>6.11</b>	<b>Third order intercept (TOI) measurement.....</b>	<b>319</b>
6.11.1	About the TOI measurement.....	320
6.11.2	TOI basics.....	320
6.11.3	TOI results.....	324
6.11.4	TOI configuration.....	325
6.11.5	How to determine the third order intercept.....	326
6.11.6	Measurement example – measuring the FSW's intrinsic intermodulation.....	327
<b>6.12</b>	<b>AM modulation depth measurement.....</b>	<b>329</b>
6.12.1	About the measurement.....	329
6.12.2	AM modulation depth results.....	330
6.12.3	AM modulation depth configuration.....	330
6.12.4	Optimizing and troubleshooting the measurement.....	331
6.12.5	How to determine the AM modulation depth.....	332
<b>6.13</b>	<b>Electromagnetic interference (EMI) measurement.....</b>	<b>332</b>
6.13.1	About the EMI measurement.....	333
6.13.2	EMI measurement results.....	333
6.13.3	EMI measurement basics.....	335
6.13.4	EMI measurement configuration.....	341
6.13.5	EMI result analysis.....	351
6.13.6	How to perform EMI measurements.....	351
6.13.7	Measurement example: measuring radio frequency interference.....	353
6.13.8	Optimizing and troubleshooting EMI measurements.....	356

<b>7</b>	<b>Common measurement settings</b>	<b>357</b>
7.1	Configuration overview	357
7.2	Data input and output	359
7.2.1	Receiving data input and providing data output	359
7.2.2	Input source settings	362
7.2.3	Power sensors	367
7.2.4	Optional external generator control	375
7.2.5	Probes	403
7.2.6	Optional external mixers	411
7.2.7	External frontend control (R&S FSW-K553)	441
7.2.8	Output settings	466
7.2.9	Trigger input/output settings	468
7.2.10	How to output a trigger signal	470
7.3	Frequency and span configuration	471
7.3.1	Impact of the frequency and span settings	471
7.3.2	Frequency and span settings	473
7.3.3	Keeping the center frequency stable - signal tracking	477
7.3.4	How to define the frequency range	478
7.3.5	How to move the center frequency through the frequency range	478
7.4	Amplitude and vertical axis configuration	479
7.4.1	Impact of the vertical axis settings	479
7.4.2	Amplitude settings	481
7.4.3	Scaling the y-axis	489
7.4.4	How to optimize the amplitude display	491
7.5	Bandwidth, filter and sweep configuration	492
7.5.1	Impact of the bandwidth, filter and sweep settings	492
7.5.2	Bandwidth, filter and sweep settings	498
7.6	Trigger and gate configuration	508
7.6.1	Triggering	508
7.6.2	Gating	520
7.7	Adjusting settings automatically	530
<b>8</b>	<b>Common analysis and display functions</b>	<b>534</b>
8.1	Result display configuration	534



8.1.1	Basic evaluation methods.....	534
8.1.2	Laying out the result display with the smartgrid.....	537
<b>8.2</b>	<b>Zoomed displays.....</b>	<b>541</b>
8.2.1	Single zoom versus multiple zoom.....	541
8.2.2	Zoom functions.....	543
8.2.3	How to zoom into a diagram.....	545
<b>8.3</b>	<b>Marker usage.....</b>	<b>548</b>
8.3.1	Basics on markers.....	548
8.3.2	Marker settings.....	551
8.3.3	Marker search settings and positioning functions.....	557
8.3.4	Marker (measurement) functions.....	565
8.3.5	How to work with markers.....	586
8.3.6	Measurement example: measuring harmonics using marker functions.....	589
<b>8.4</b>	<b>Display and limit lines.....</b>	<b>590</b>
8.4.1	Display lines.....	591
8.4.2	Limit lines.....	593
<b>8.5</b>	<b>Trace configuration.....</b>	<b>609</b>
8.5.1	Standard traces.....	609
8.5.2	Spectrograms.....	629
8.5.3	Trace math.....	646
<b>8.6</b>	<b>Importing and exporting measurement results for evaluation.....</b>	<b>648</b>
8.6.1	Displaying a reference trace - importing trace data.....	649
8.6.2	Trace/data ex/import.....	650
8.6.3	How to import traces.....	655
8.6.4	How to export trace data and numerical results.....	655
8.6.5	How to export a peak list.....	656
8.6.6	Reference: ASCII file export format.....	657
<b>8.7</b>	<b>Event-based actions.....</b>	<b>660</b>
8.7.1	Managing rules.....	661
8.7.2	Defining rules.....	662
8.7.3	Debugging rules with the EBA-Journal.....	669
8.7.4	Reference: overview of available result-events and state-events.....	670
<b>9</b>	<b>Optimizing measurements.....</b>	<b>672</b>

<b>9.1</b>	<b>Minimizing the measurement duration.....</b>	<b>672</b>
<b>9.2</b>	<b>Improving averaging results.....</b>	<b>672</b>
<b>10</b>	<b>Data management.....</b>	<b>674</b>
<b>10.1</b>	<b>Restoring the default instrument configuration (preset).....</b>	<b>674</b>
<b>10.2</b>	<b>Protecting data using the secure user mode.....</b>	<b>675</b>
<b>10.3</b>	<b>Storing and recalling instrument settings and measurement data.....</b>	<b>677</b>
10.3.1	Quick save/quick recall.....	679
10.3.2	Configurable storage and recall.....	681
10.3.3	How to save and load instrument settings.....	687
<b>10.4</b>	<b>Import/export functions.....</b>	<b>689</b>
<b>10.5</b>	<b>Creating screenshots of current measurement results and settings.....</b>	<b>693</b>
10.5.1	Print and screenshot settings.....	694
10.5.2	How to store or print screenshots of the display.....	705
10.5.3	Example for storing multiple measurement results to a PDF file.....	708
<b>10.6</b>	<b>Working with test reports.....</b>	<b>710</b>
10.6.1	Designing a test report template.....	711
10.6.2	Managing templates.....	720
10.6.3	Creating datasets.....	721
10.6.4	Creating a test report.....	722
10.6.5	How to create a test report.....	724
<b>11</b>	<b>General instrument setup.....</b>	<b>726</b>
<b>11.1</b>	<b>Alignment.....</b>	<b>726</b>
11.1.1	Basics on alignment.....	726
11.1.2	Alignment settings.....	728
11.1.3	How to perform a self-test.....	733
11.1.4	How to align the instrument.....	733
11.1.5	How to align the touchscreen.....	734
<b>11.2</b>	<b>Display settings.....</b>	<b>734</b>
11.2.1	Display settings.....	734
11.2.2	How to configure the colors for display and printing.....	745
11.2.3	How to work with the soft front panels.....	746
11.2.4	Reference: Keyboard shortcuts for the mini front panel.....	747
<b>11.3</b>	<b>Application starter.....</b>	<b>749</b>

11.3.1	Application starter functions.....	749
11.3.2	How to work with the application starter.....	753
<b>11.4</b>	<b>Transducers.....</b>	<b>754</b>
11.4.1	Basics on transducer factors.....	754
11.4.2	Transducer settings.....	756
11.4.3	Reference: transducer factor file format.....	762
11.4.4	How to configure the transducer.....	763
<b>11.5</b>	<b>Frequency response correction (R&amp;S FSW-K544).....</b>	<b>767</b>
11.5.1	Basics on frequency response correction.....	767
11.5.2	User-defined frequency response correction settings.....	770
<b>11.6</b>	<b>Reference frequency settings.....</b>	<b>779</b>
<b>11.7</b>	<b>System configuration settings.....</b>	<b>783</b>
11.7.1	Hardware information.....	783
11.7.2	Licensing, versions and options.....	784
11.7.3	System messages.....	789
11.7.4	Firmware updates.....	790
11.7.5	General configuration settings.....	791
11.7.6	Signal generator settings.....	793
11.7.7	AC power loss behavior.....	795
<b>11.8</b>	<b>Service functions.....</b>	<b>796</b>
11.8.1	R&S support information.....	796
11.8.2	Self-test settings and results.....	797
11.8.3	Calibration signal display.....	798
11.8.4	Service functions.....	800
11.8.5	Hardware diagnostics.....	802
<b>11.9</b>	<b>Synchronizing measurement channel configuration.....</b>	<b>803</b>
11.9.1	General parameter coupling.....	804
11.9.2	User-defined parameter coupling.....	806
11.9.3	Generator coupling.....	810
11.9.4	How to synchronize parameters.....	812
11.9.5	Example for a user-defined parameter coupling.....	814
<b>12</b>	<b>Network operation and remote control.....</b>	<b>816</b>
<b>12.1</b>	<b>Remote control interfaces and protocols.....</b>	<b>816</b>

12.1.1	LAN interface.....	817
12.1.2	GPIB interface (IEC 625/IEEE 418 bus interface).....	821
12.1.3	USB interface.....	821
<b>12.2</b>	<b>Status reporting system.....</b>	<b>822</b>
12.2.1	Hierarchy of status registers.....	822
12.2.2	Contents of the status registers.....	823
12.2.3	Reset values of the status reporting system.....	834
<b>12.3</b>	<b>GPIB languages.....</b>	<b>835</b>
<b>12.4</b>	<b>The IECWIN tool.....</b>	<b>837</b>
<b>12.5</b>	<b>Automating tasks with remote command scripts.....</b>	<b>838</b>
12.5.1	The context-sensitive SCPI command menu.....	839
12.5.2	The SCPI recorder.....	841
12.5.3	How to determine the required SCPI command.....	848
12.5.4	How to create and export SCPI scripts.....	848
12.5.5	Example for a recorded SCPI script.....	851
<b>12.6</b>	<b>Network and remote control settings.....</b>	<b>851</b>
12.6.1	General network settings.....	852
12.6.2	GPIB settings.....	854
12.6.3	Compatibility settings.....	857
12.6.4	LAN settings.....	861
12.6.5	HUMS settings.....	862
12.6.6	Remote errors.....	868
12.6.7	Returning to manual mode ("local").....	870
<b>12.7</b>	<b>How to set up a network and remote control.....</b>	<b>870</b>
12.7.1	How to configure a network.....	871
12.7.2	How to operate the instrument without a network.....	877
12.7.3	How to log on to the network.....	877
12.7.4	How to share directories (only with Microsoft networks).....	880
12.7.5	How to control the FSW via the web browser interface.....	881
12.7.6	How to deactivate the web browser interface.....	882
12.7.7	How to set up remote desktop.....	883
12.7.8	How to start a remote control session from a PC.....	889
12.7.9	How to return to manual operation.....	890

<b>13</b>	<b>Remote commands.....</b>	<b>891</b>
13.1	Conventions used in SCPI command descriptions.....	891
13.2	Common suffixes.....	892
13.3	Common commands.....	892
13.4	Selecting the operating mode and application.....	897
13.4.1	Selecting the mode and applications.....	897
13.4.2	Performing a sequence of measurements.....	903
13.4.3	Programming example: performing a sequence of measurements.....	905
13.5	Configuring and performing measurements.....	907
13.5.1	Performing measurements.....	908
13.5.2	Configuring power measurements.....	911
13.5.3	Measuring the channel power and ACLR.....	915
13.5.4	Measuring the carrier-to-noise ratio.....	979
13.5.5	Measuring the occupied bandwidth.....	980
13.5.6	Remote commands for noise power ratio (NPR) measurements.....	982
13.5.7	Measuring the spectrum emission mask.....	998
13.5.8	Measuring spurious emissions.....	1035
13.5.9	Analyzing statistics (APD, CCDF).....	1051
13.5.10	Measuring the time domain power.....	1061
13.5.11	Measuring the harmonic distortion.....	1071
13.5.12	Measuring the third order intercept point.....	1075
13.5.13	Measuring the AM modulation depth.....	1078
13.5.14	Remote commands for EMI measurements.....	1080
13.5.15	List evaluations.....	1089
13.5.16	Measuring the pulse power.....	1093
13.6	Configuring the result display.....	1098
13.6.1	General window commands.....	1098
13.6.2	Working with windows in the display.....	1099
13.6.3	Examples: configuring the result display.....	1106
13.7	Setting basic measurement parameters.....	1109
13.7.1	Configuring the data input and output.....	1109
13.7.2	Defining the frequency and span.....	1190
13.7.3	Configuring bandwidth and sweep settings.....	1197

13.7.4	Configuring the vertical axis (amplitude, scaling).....	1206
13.7.5	Configuring triggered and gated measurements.....	1217
13.7.6	Adjusting settings automatically.....	1232
<b>13.8</b>	<b>Analyzing measurements (basics).....</b>	<b>1236</b>
13.8.1	Zooming into the display.....	1236
13.8.2	Configuring the trace display and retrieving trace data.....	1239
13.8.3	Working with markers.....	1268
13.8.4	Configuring display lines.....	1328
13.8.5	Defining limit checks.....	1330
<b>13.9</b>	<b>Managing settings and results.....</b>	<b>1347</b>
13.9.1	General data storage and loading commands.....	1348
13.9.2	Selecting the items to store.....	1354
13.9.3	Storing and loading instrument settings.....	1357
13.9.4	Storing or printing screenshots.....	1362
13.9.5	Storing measurement results.....	1372
13.9.6	Test reports.....	1375
13.9.7	Examples: managing data.....	1385
<b>13.10</b>	<b>Configuring the FSW.....</b>	<b>1389</b>
13.10.1	Configuring the reference frequency.....	1389
13.10.2	Calibration and checks.....	1393
13.10.3	Working with transducers.....	1402
13.10.4	Compensating for frequency response using touchstone files (R&S FSW-K544)....	1406
13.10.5	Customizing the screen layout.....	1425
13.10.6	Remote commands for language settings.....	1432
13.10.7	Configuring the network and remote control.....	1433
13.10.8	Configuring HUMS.....	1438
13.10.9	Checking the system configuration.....	1444
13.10.10	Signal generator control commands.....	1454
13.10.11	Using service functions.....	1455
13.10.12	Remote commands for synchronizing parameters.....	1458
13.10.13	Configuring the application starter.....	1474
13.10.14	Programming examples for instrument setup.....	1477
<b>13.11</b>	<b>Using the status register.....</b>	<b>1478</b>

13.11.1	General status register commands.....	1478
13.11.2	Reading out the CONDition part.....	1479
13.11.3	Reading out the EVENT part.....	1479
13.11.4	Controlling the ENABLE part.....	1480
13.11.5	Controlling the negative transition part.....	1480
13.11.6	Controlling the positive transition part.....	1481
<b>13.12</b>	<b>Commands for remote instrument operation.....</b>	<b>1482</b>
<b>13.13</b>	<b>Recording SCPI Commands Automatically.....</b>	<b>1482</b>
<b>13.14</b>	<b>Emulating other instruments' commands.....</b>	<b>1487</b>
13.14.1	Setting up instrument emulation.....	1488
13.14.2	Reference: GPIB commands of emulated HP models.....	1491
13.14.3	Reference: command set of emulated PSA models.....	1519
13.14.4	Reference: command set of emulated PXA models.....	1523
13.14.5	Command set for analog demodulation for emulated PXA models.....	1526
13.14.6	Command set for vector signal analysis (VSA) for emulated R&S FSE instruments	1526
<b>13.15</b>	<b>Deprecated commands.....</b>	<b>1527</b>
<b>13.16</b>	<b>Programming examples.....</b>	<b>1531</b>
13.16.1	Programming example: performing a basic frequency sweep.....	1531
13.16.2	Service request.....	1534
<b>14</b>	<b>Troubleshooting.....</b>	<b>1543</b>
<b>14.1</b>	<b>Error information.....</b>	<b>1543</b>
<b>14.2</b>	<b>Error messages in remote control mode.....</b>	<b>1545</b>
<b>14.3</b>	<b>Troubleshooting remote operation.....</b>	<b>1546</b>
<b>14.4</b>	<b>Miscellaneous troubleshooting hints.....</b>	<b>1548</b>
<b>14.5</b>	<b>System recovery.....</b>	<b>1550</b>
<b>14.6</b>	<b>Collecting information for support.....</b>	<b>1550</b>
<b>14.7</b>	<b>Contacting customer support.....</b>	<b>1553</b>
<b>15</b>	<b>Maintenance, storage, transport and disposal.....</b>	<b>1554</b>
<b>15.1</b>	<b>Cleaning.....</b>	<b>1554</b>
<b>15.2</b>	<b>Storage.....</b>	<b>1554</b>
<b>15.3</b>	<b>Transporting.....</b>	<b>1554</b>

15.4 Disposal.....	1555
List of Commands (base unit).....	1556
Index.....	1584



# 1 Safety and regulatory information

The product documentation helps you use the product safely and efficiently. Follow the instructions provided here and in the following sections.

## Intended use

The product is intended for the development, production and verification of electronic components and devices in industrial, administrative, and laboratory environments. Use the product only for its designated purpose. Observe the operating conditions and performance limits stated in the specifications document.

## Target audience

The target audience of this document includes developers and technicians, administrators and maintenance personnel performing RF signal measurements. The required skills and experience of the users depend on the test setup and application of the product.

## Where do I find safety information?

Safety information is part of the product documentation. It warns you of potential dangers and gives instructions on how to prevent personal injury or damage caused by dangerous situations. Safety information is provided as follows:

- In [Chapter 1.1, "Safety instructions"](#), on page 17. The same information is provided in many languages in printed format. The printed "Safety Instructions" for "Mains-Powered Products, Heavy" (document number 1171.1788.99) are delivered with the product.
- Throughout the documentation, safety instructions are provided when you need to take care during setup or operation.

## 1.1 Safety instructions

Products from the Rohde & Schwarz group of companies are manufactured according to the highest technical standards. To use the products safely, follow the instructions provided here and in the product documentation. Keep the product documentation nearby and offer it to other users.

Use the product only for its intended use and within its performance limits. Intended use and limits are described in the product documentation such as the specifications document, manuals and the printed "Safety Instructions" document. If you are unsure about the appropriate use, contact Rohde & Schwarz customer support.

Using the product requires specialists or specially trained personnel. These users also need sound knowledge of at least one of the languages in which the user interfaces and the product documentation are available.

Reconfigure or adjust the product only as described in the product documentation or the specifications document. Any other modifications can affect safety and are not permitted.

Never open the casing of the product. Only service personnel authorized by Rohde & Schwarz are allowed to repair the product. If any part of the product is damaged or broken, stop using the product. Contact Rohde & Schwarz customer support at <https://www.rohde-schwarz.com/support>.

### **Lifting and carrying the product**

The product is heavy. Do not move or carry the product by yourself. A single person can only carry a maximum of 18 kg safely depending on age, gender and physical condition. Look up the maximum weight in the specifications document. Use the product handles to move or carry the product. Do not lift by the accessories mounted on the product. Accessories are not designed to carry the weight of the product.

To move the product safely, you can use lifting or transporting equipment such as lift trucks and forklifts. Follow the instructions provided by the equipment manufacturer.

### **Choosing the operating site**

Only use the product indoors. The product casing is not waterproof. Water that enters can electrically connect the casing with live parts, which can lead to electric shock, serious personal injury or death if you touch the casing.

If Rohde & Schwarz provides accessories designed for outdoor use of your product, e.g. a protective cover, you can use the product outdoors.

You can operate the product up to an altitude of 2000 m above sea level. If a higher altitude is permissible, the value is provided in the specifications document. The product is suitable for pollution degree 2 environments where nonconductive contamination can occur. For more information on environmental conditions such as ambient temperature and humidity, see the specifications document.

### **Setting up the product**

Always place the product on a stable, flat and level surface with the bottom of the product facing down. If the product is designed for different positions, secure the product so that it cannot fall over.

If the product has foldable feet, always fold the feet completely in or out to ensure stability. The feet can collapse if they are not folded out completely or if the product is moved without lifting it. The foldable feet are designed to carry the weight of the product, but not an extra load.

If stacking is possible, keep in mind that a stack of products can fall over and cause injury.

If you mount products in a rack, ensure that the rack has sufficient load capacity and stability. Observe the specifications of the rack manufacturer. Always install the products from the bottom shelf to the top shelf so that the rack stands securely. Secure the product so that it cannot fall off the rack.

### Connecting the product

Before connecting the interfaces and measuring inputs of the product to other products or electrical circuits, make sure that the other products or electrical circuits provide special protection against electric shock. This protection principle is referred to as SELV (safety extra-low voltage) and is based on a low voltage level and increased insulation. Exceptions are indicated by a measurement category on the product and given in the specifications document.

### Connecting to power

The product is an overvoltage category II product. Connect the product to a fixed installation used to supply energy-consuming equipment such as household appliances and similar loads. Keep in mind that electrically powered products have risks, such as electric shock, fire, personal injury or even death. Replace parts that are relevant to safety only by original parts, e.g. power cables or fuses.

Take the following measures for your safety:

- Before switching on the product, ensure that the voltage and frequency indicated on the product match the available power source. If the power adapter does not adjust automatically, set the correct value and check the rating of the fuse.
- Only use the power cable delivered with the product. It complies with country-specific safety requirements. Only insert the plug into an outlet with protective conductor terminal.
- Only use intact cables and route them carefully so that they cannot be damaged. Check the power cables regularly to ensure that they are undamaged. Also ensure that nobody can trip over loose cables.
- Only connect the product to a power source with a fuse protection of maximum 20 A.
- Ensure that you can disconnect the product from the power source at any time. Pull the power plug to disconnect the product. The power plug must be easily accessible. If the product is integrated into a system that does not meet these requirements, provide an easily accessible circuit breaker at the system level.

### Using headphones





Take the following measures to prevent hearing damage. Before using headphones, check the volume and reduce it if necessary. If you monitor varying signal levels, take off the headphones and wait until the signal has settled. Then adjust the volume.

### Cleaning the product

Use a dry, lint-free cloth to clean the product. When cleaning, keep in mind that the casing is not waterproof. Do not use liquid cleaning agents.

### Meaning of safety labels

Safety labels on the product warn against potential hazards.

	<p>Potential hazard</p> <p>Read the product documentation to avoid personal injury or product damage.</p>
	<p>Heavy product</p> <p>Be careful when lifting, moving or carrying the product. Carrying the product requires a sufficient number of persons or transport equipment.</p>
	<p>Electrical hazard</p> <p>Indicates live parts. Risk of electric shock, fire, personal injury or even death.</p>
	<p>Hot surface</p> <p>Do not touch. Risk of skin burns. Risk of fire.</p>
	<p>Protective conductor terminal</p> <p>Connect this terminal to a grounded external conductor or to protective ground. This connection protects you against electric shock if an electric problem occurs.</p>

## 1.2 Warning messages in the documentation

A warning message points out a risk or danger that you need to be aware of. The signal word indicates the severity of the safety hazard and how likely it will occur if you do not follow the safety precautions.

### **WARNING**

Potentially hazardous situation. Could result in death or serious injury if not avoided.

### **CAUTION**

Potentially hazardous situation. Could result in minor or moderate injury if not avoided.

### **NOTICE**

Potential risks of damage. Could result in damage to the supported product or to other property.

### 1.3 Korea certification class B



이 기기는 가정용(B급) 전자파 적합기기로서 주로 가정에서 사용하는 것을 목적으로 하며, 모든 지역에서 사용할 수 있습니다.

## 2 Documentation overview

This section provides an overview of the FSW user documentation. Unless specified otherwise, you find the documents at:

[www.rohde-schwarz.com/manual/FSW](http://www.rohde-schwarz.com/manual/FSW)

Further documents are available at:

[www.rohde-schwarz.com/product/FSW](http://www.rohde-schwarz.com/product/FSW)

### 2.1 Getting started manual

Introduces the FSW and describes how to set up and start working with the product. Includes basic operations, typical measurement examples, and general information, e.g. safety instructions, etc.

A printed version is delivered with the instrument. A PDF version is available for download on the Internet.

### 2.2 User manuals and help

Separate user manuals are provided for the base unit and the firmware applications:

- **Base unit manual**  
Contains the description of all instrument modes and functions. It also provides an introduction to remote control, a complete description of the remote control commands with programming examples, and information on maintenance, instrument interfaces and error messages. Includes the contents of the getting started manual.
- **Firmware application manual**  
Contains the description of the specific functions of a firmware application, including remote control commands. Basic information on operating the FSW is not included.

The contents of the user manuals are available as help in the FSW. The help offers quick, context-sensitive access to the complete information for the base unit and the firmware applications.

All user manuals are also available for download or for immediate display on the Internet.

### 2.3 Service manual

Describes the performance test for checking the rated specifications, module replacement and repair, firmware update, troubleshooting and fault elimination, and contains mechanical drawings and spare part lists.

The service manual is available for registered users on the global Rohde & Schwarz information system (GLORIS):

<https://gloris.rohde-schwarz.com>

## 2.4 Instrument security procedures

Deals with security issues when working with the FSW in secure areas. It is available for download on the internet.

## 2.5 Printed safety instructions

Provides safety information in many languages. The printed document is delivered with the product.

## 2.6 Specifications and brochures

The specifications document, also known as the data sheet, contains the technical specifications of the FSW. It also lists the firmware applications and their order numbers, and optional accessories.

The brochure provides an overview of the instrument and deals with the specific characteristics.

See [www.rohde-schwarz.com/brochure-datasheet/FSW](http://www.rohde-schwarz.com/brochure-datasheet/FSW)

## 2.7 Release notes and open-source acknowledgment (OSA)

The release notes list new features, improvements and known issues of the current software version, and describe the software installation.

The software uses several valuable open source software packages. An open source acknowledgment document provides verbatim license texts of the used open source software.

See [www.rohde-schwarz.com/firmware/FSW](http://www.rohde-schwarz.com/firmware/FSW)

## 2.8 Application notes, application cards, white papers, etc.

These documents deal with special applications or background information on particular topics.

See [www.rohde-schwarz.com/application/FSW](http://www.rohde-schwarz.com/application/FSW)

## 2.9 Videos

Find various videos on Rohde & Schwarz products and test and measurement topics on YouTube: <https://www.youtube.com/@RohdeundSchwarz>



## 3 Welcome to the FSW

The R&S FSW is a new high-performance Rohde & Schwarz signal and spectrum analyzer developed to meet demanding customer requirements. Offering low phase noise, wide analysis bandwidth and straightforward and intuitive operation, the analyzer makes measurements fast and easy.

This user manual contains a description of the functionality that the instrument provides, including remote control operation. The latest version is available for download at the product homepage (<http://www.rohde-schwarz.com/product/FSW.html>).

## 4 Getting Started

**Note:** the following chapters are identical to those in the printed FSW Getting Started manual.

• <a href="#">Key features</a> .....	26
• <a href="#">Preparing for use</a> .....	27
• <a href="#">Instrument tour</a> .....	41
• <a href="#">Trying out the instrument</a> .....	61
• <a href="#">Operating the instrument</a> .....	79

### 4.1 Key features

The FSW Signal and Spectrum Analyzer sets standards in RF performance and usability. The FSW provides the following outstanding key features:

- Unmatched phase noise
- Excellent dynamic range
- Up to 8.3 GHz analysis bandwidth
- 800 MHz real-time analysis bandwidth with 2.4 million FFT/s, 0.46  $\mu$ s POI and 500 MHz I/Q data streaming interface
- High sensitivity even at low frequencies
- High measurement rates and fast sweep times with sweep rates up to 1000 sweeps per second
- Multiple measurement applications can be run and displayed in parallel
- Easy and intuitive to operate via the large touchscreen user interface and optimized user guidance
- SCPI recorder simplifies code generation
- Integrated support of R&S®NRP-Zxx power sensors

For a detailed specification refer to the specifications document.

Due to these features the FSW is ideal for various measurement tasks, for instance:

- Measuring oscillators for radar and communications applications due to the low phase noise
- Identifying and analyzing spurious emissions due to the large spurious-free dynamic range and low DANL
- Measuring harmonics due to integrated highpass filters
- Measuring wide-band modulated or frequency-agile signals due to the large bandwidth
- Detecting errors caused by interaction between signals by measuring multiple standards simultaneously

## 4.2 Preparing for use

Here, you can find basic information about setting up the product for the first time.

• <a href="#">Lifting and carrying</a> .....	27
• <a href="#">Unpacking and checking</a> .....	27
• <a href="#">Choosing the operating site</a> .....	27
• <a href="#">Setting up the product</a> .....	28
• <a href="#">Connecting the AC power</a> .....	30
• <a href="#">Switching the instrument on and off</a> .....	30
• <a href="#">Connecting to LAN</a> .....	32
• <a href="#">Connecting a keyboard</a> .....	33
• <a href="#">Connecting an external monitor</a> .....	33
• <a href="#">Windows operating system</a> .....	34
• <a href="#">Logging on</a> .....	36
• <a href="#">Checking the supplied options</a> .....	38
• <a href="#">Performing a self-alignment</a> .....	38
• <a href="#">Considerations for test setup</a> .....	39
• <a href="#">Protecting data using the secure user mode</a> .....	39

### 4.2.1 Lifting and carrying

The carrying handles are designed to lift or carry the instrument. Do not apply excessive external force to the handles.

See "[Lifting and carrying the product](#)" on page 18.

### 4.2.2 Unpacking and checking

1. Unpack the FSW carefully.
2. Retain the original packing material. Use it when transporting or shipping the FSW later.
3. Using the delivery notes, check the equipment for completeness.
4. Check the equipment for damage.

If the delivery is incomplete or equipment is damaged, contact Rohde & Schwarz.

### 4.2.3 Choosing the operating site

Specific operating conditions ensure proper operation and avoid damage to the product and connected devices. For information on environmental conditions such as ambient temperature and humidity, see the specifications document.

For safety information, see "[Choosing the operating site](#)" on page 18.

### Electromagnetic compatibility classes

The electromagnetic compatibility (EMC) class indicates where you can operate the product. The EMC class of the product is given in the specifications document.

- Class B equipment is suitable for use in:
  - Residential environments
  - Environments that are directly connected to a low-voltage supply network that supplies residential buildings
- Class A equipment is intended for use in industrial environments. It can cause radio disturbances in residential environments due to possible conducted and radiated disturbances. It is therefore not suitable for class B environments. If class A equipment causes radio disturbances, take appropriate measures to eliminate them.

## 4.2.4 Setting up the product

See also:

- ["Setting up the product"](#) on page 18
- ["Intended use"](#) on page 17

### 4.2.4.1 Placing the product on a bench top

#### To place the product on a bench top

1. Place the product on a stable, flat and level surface. Ensure that the surface can support the weight of the product. For information on the weight, see the specifications document.
2. **WARNING!** A stack of products can fall over and cause injury. Never stack more than two products. Otherwise, mount them in a rack.

Stack as follows:

- All products must have the same dimensions (width and length).
- Do not exceed a total load of 50 kg placed on the product at the bottom of the stack.

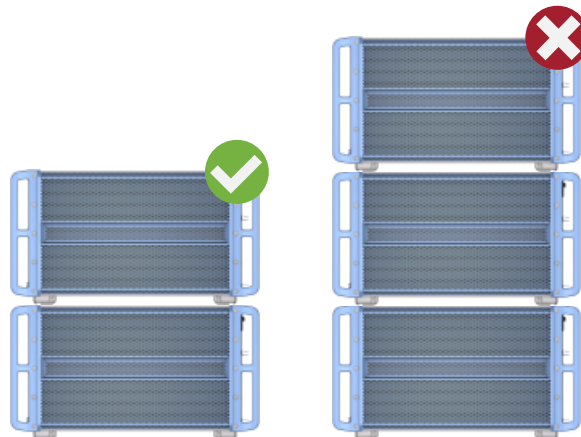

Left = Stacked correctly  
Right = Stacked incorrectly, too many products

3. **NOTICE!** Overheating can damage the product.

Prevent overheating as follows:

- Keep a minimum distance of 10 cm between the fan openings of the product and any object in the vicinity to provide sufficient airflow and ventilation.
- Do not place the product next to heat-generating equipment such as radiators or other products.

#### 4.2.4.2 Mounting the FSW in a rack

##### To prepare the rack

1. Observe the requirements and instructions in "[Setting up the product](#)" on page 18.
2. **NOTICE!** Insufficient airflow can cause overheating and damage the product.  
Design and implement an efficient ventilation concept for the rack.

##### To mount the FSW in a rack

1. Use an adapter kit to prepare the FSW for rack mounting.
  - a) Order the rack adapter kit designed for the FSW. For the order number, see the specifications document.
  - b) Mount the adapter kit. Follow the assembly instructions provided with the adapter kit.
2. Lift the FSW to shelf height.
3. Grab the handles and push the FSW onto the shelf until the rack brackets fit closely to the rack.
4. Tighten all screws in the rack brackets with a tightening torque of 1.2 Nm to secure the FSW in the rack.

**To unmount the FSW from a rack**

1. Loosen the screws at the rack brackets.
2. Remove the FSW from the rack.
3. If placing the FSW on a bench top again, unmount the adapter kit from the FSW. Follow the instructions provided with the adapter kit.

**4.2.5 Connecting the AC power**

In the standard version, the FSW is equipped with an AC power supply connector.

The FSW can be used with different AC power voltages and adapts itself automatically to it. Refer to the specifications document for the requirements of voltage and frequency.

For safety information, see ["Connecting to power"](#) on page 19.

**To connect the AC power**

1. Plug the AC power cable into the AC power connector on the rear panel of the instrument. Only use the AC power cable delivered with the FSW.
2. Plug the AC power cable into a power outlet with ground contact.  
The required ratings are listed next to the AC power connector and in the specifications document.

For details on the connector, refer to [Chapter 4.3.2.2, "AC power supply connection and main power switch"](#), on page 54.

**4.2.6 Switching the instrument on and off**

*Table 4-1: Overview of power states*

Status	LED on Power key	Position of main power switch
Off	● gray	[0]
Standby	● orange	[I]
Ready	● green	[I]

**To switch on the FSW**

Prerequisites:

The FSW is off but connected to power.

No RF input is connected to the instrument.

1. Set the switch on the power supply to position [I].  
See [Chapter 4.3.2.2, "AC power supply connection and main power switch"](#), on page 54.

The LED of the Power key is orange.

See [Chapter 4.3.1.1, "Power key"](#), on page 42.

**Note:** If the FSW was disconnected from power before it was switched off regularly, it automatically switches back on when the power is reconnected.

Using a LAN-controlled power switch, you can take advantage of this behavior to switch the device on and off remotely.

2. Press the Power key.  
See [Table 4-1](#).

The LED changes to green.

The FSW boots.

After booting, the instrument is ready for operation.



#### Warm-up time for OCXO

When the instrument is switched on, the OCXO requires an extended warm-up time.

#### To shut down the product

Prerequisites:

The product is in the ready state.

Any RF input is disconnected from the instrument.

- ▶ Press the [Power] key.

The operating system shuts down. The LED changes to orange.



If the instrument temperature exceeds the limit specified in the specifications document, the FSW automatically shuts down to protect the instrument from damage.

#### To disconnect from power

The FSW is in the standby state.

1. **NOTICE!** Risk of data loss. If you disconnect the product from power when it is in the ready state, you can lose settings and data. Shut it down first.

Set the switch on the power supply to position [O].

See [Chapter 4.3.2.2, "AC power supply connection and main power switch"](#), on page 54.

The LED of the standby key is switched off.

2. Disconnect the FSW from the power source.

## 4.2.7 Connecting to LAN

You can connect the instrument to a LAN for remote operation via a PC.

For details on the connector, see [Chapter 4.3.2.4, "LAN"](#), on page 54.

Provided the network administrator has assigned you the appropriate rights and adapted the Windows firewall configuration, you can use the interface, for example:

- To transfer data between a controlling device and the test device, e.g. to run a remote control program
- To access or control the measurement from a remote computer using the "Remote Desktop" application (or a similar tool)
- To connect external network devices (e.g. printers)
- To transfer data from a remote computer and back, e.g. using network folders

### Network environment

Before connecting the product to a local area network (LAN), consider the following:

- Install the latest firmware to reduce security risks.
- For internet or remote access, use secured connections, if applicable.
- Ensure that the network settings comply with the security policies of your company. Contact your local system administrator or IT department before connecting your product to your company LAN.
- When connected to the LAN, the product may potentially be accessed from the internet, which may be a security risk. For example, attackers might misuse or damage the product. For more information about IT security and how to operate the product in a secure LAN environment, see the Rohde & Schwarz white paper [1EF96: Malware Protection Windows 10](#).

► **NOTICE!** Risk of network failure.

Consult your network administrator before performing the following tasks:

- Connecting the instrument to the network
- Configuring the network
- Changing IP addresses
- Exchanging hardware

Errors can affect the entire network.

Connect the FSW to the LAN via the LAN interface on the rear panel of the instrument.

Windows automatically detects the network connection and activates the required drivers.

By default, the FSW is configured to use DHCP and no static IP address is configured.



The default instrument name is <Type><variant>-<serial\_number>, for example, FSW8-123456. For information on determining the serial number, see [Chapter 4.3.2.21, "Device ID"](#), on page 61.



For more information on LAN configuration, see [Chapter 12.6.4, "LAN settings"](#), on page 861.

### 4.2.8 Connecting a keyboard

The keyboard is detected automatically when it is connected. The default input language is English – US.

However, you can also connect foreign language keyboards; currently the following languages are supported for the FSW:

- German
- Swiss
- French
- Russian

#### To configure the keyboard language

1. To access the Windows operating system, press the Windows key on the external keyboard.
2. Select "Start > Settings > Time & language > Region & language > Add a language" .

### 4.2.9 Connecting an external monitor

You can connect an external monitor (or projector) to the "DVI" or "Display port" connector on the rear panel of the FSW (see also [Chapter 4.3.2.5, "Display port and DVI"](#), on page 55).



#### Screen resolution and format

The touchscreen of the FSW is calibrated for a 16:10 format. If you connect a monitor or projector using a different format (e.g. 4:3), the calibration is not correct and the screen does not react to your touch actions properly.

The touchscreen has a screen resolution of 1280x800 pixels. Usually, the display of the external monitor is a duplicate of the instrument's monitor.

If you configure the external monitor to be used as the *only* display in the Windows configuration dialog box ("Show only on 2"), the maximum screen resolution of the monitor is used. In this case, you can maximize the FSW application window and see even more details. You cannot change the monitor's screen resolution via the standard Windows configuration dialog box.

However, you can restore the default instrument resolution (1280x800) on the monitor using the instrument function "Setup" > "Display" > "Configure Monitor" > "Screen Resolution: Restore to default".

The FSW supports a minimum resolution of 1280x768 pixels.

1. Connect the external monitor to the FSW.

2. Press [Setup].
3. Press "Display".
4. Select the "Configure Monitor" tab in the "Display" dialog box.

The standard Windows "Screen Resolution" dialog box is displayed.

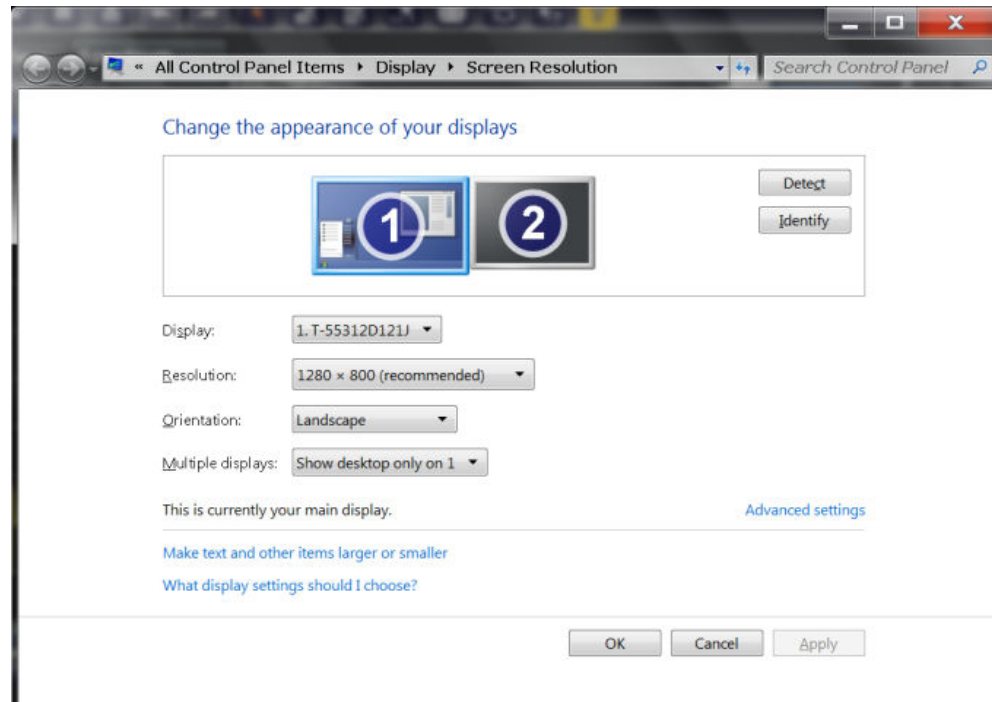

5. Select the instrument for display:
  - "Display 1": internal monitor only
  - "Display 2": external monitor only
  - "Duplicate": both internal and external monitor
6. Tap "Apply" to try out the settings before they are accepted permanently, then you can easily return to the previous settings, if necessary.
7. Select "OK" if the settings are suitable.

#### 4.2.10 Windows operating system

The instrument contains the Windows 10 operating system which has been configured according to the instrument's features and needs. Changes in the system setup are only required when peripherals like a keyboard or a printer are installed or if the network configuration does not comply with the default settings. After the FSW is started, the operating system boots and the instrument firmware is started automatically.

### Tested software

The drivers and programs used on the instrument under Windows 10 are adapted to the instrument. Only install update software released by Rohde & Schwarz to modify existing instrument software.

You can install additional software on the instrument; however, additional software can impair instrument function. Thus, run only programs that Rohde & Schwarz has tested for compatibility with the instrument software.

The following program packages have been tested:

- R&S Power Viewer Plus - virtual power meter for displaying results of the power sensor R&S NRPxx (install only this component!)
- Symantec Endpoint Security – virus-protection software
- FileShredder - for reliable deletion of files on the hard disk

### Service packs and updates

Microsoft regularly creates security updates and other patches to protect Windows-based operating systems. They are released through the Microsoft Update website and associated update server. Update instruments using Windows regularly, especially instruments that connect to a network.

### Firewall settings

A firewall protects an instrument by preventing unauthorized users from gaining access to it through a network. Rohde & Schwarz highly recommends using the firewall on your instrument. Rohde & Schwarz instruments are shipped with the Windows firewall enabled. All ports and connections for remote control are enabled.

Note that changing firewall settings requires administrator rights.

### Virus protection

Take appropriate steps to protect your instruments from infection. Use strong firewall settings and scan any removable storage device used with a Rohde & Schwarz instrument regularly. It is also recommended that you install anti-virus software on the instrument. Rohde & Schwarz does NOT recommend running anti-virus software in the background ("on-access" mode) on Windows-based instruments, due to potentially degrading instrument performance. However, Rohde & Schwarz does recommend running it during non-critical hours.

For details and recommendations, see the following Rohde & Schwarz white paper:

- [1EF96: Malware Protection Windows 10](#)

### To access the "Start" menu

The Windows "Start" menu provides access to the Windows 10 functionality and installed programs.



- ▶ Select the "Windows" icon in the toolbar, or press the "Windows" key or the [CTRL + ESC] key combination on the (external) keyboard.

The "Start" menu and the Windows taskbar are displayed.



The Windows taskbar also provides quick access to commonly used programs, for example Paint or WordPad. IECWIN, the auxiliary remote control tool provided free of charge and installed by Rohde & Schwarz, is also available from the taskbar or "Start" menu.

For details on the IECWIN tool, see [Chapter 12.4, "The IECWIN tool"](#), on page 837.

All necessary system settings can be defined in the "Start > Settings" menu.

For required settings, refer to the Windows 10 documentation and to the hardware description.

### 4.2.11 Logging on

Windows 10 requires that users identify themselves by entering a user name and password in a login window. By default, the FSW provides the following user accounts:

- **"Instrument"**: an administrator account with unrestricted access to the computer/domain
- **"NormalUser"**: a standard user account with limited access

Some administrative tasks require administrator rights (e.g. the configuration of a LAN network). Refer to the description of the basic instrument Setup ([Setup] menu) to find out which functions are affected.



#### Secure user mode

If the secure user mode option (R&S FSW-K33) is installed, an additional account is provided: the **"SecureUser"**.

The "SecureUser" is a standard user account with limited functionality. In particular, administrative tasks such as LAN configuration or general instrument settings are not available. Furthermore, for a "SecureUser", data that the FSW normally stores on the solid-state drive is redirected to volatile memory instead. You can access data that is stored in volatile memory during the current instrument session. However, when the instrument's power is removed, all data in volatile memory is erased.

For details, see [Chapter 4.2.15, "Protecting data using the secure user mode"](#), on page 39.

#### Passwords

For all default user accounts, the initial password is **894129**. Note that this password is very weak, and it is recommended that you change the password for all users after initial login. An administrator can change the password in Windows 10 for any user at any time via "Start > Settings > Account > SignIn Options > Password > Change".

#### Auto-login

When shipped, the instrument automatically logs on the default "Instrument" user to Windows 10 (with full access) using the default password. This function is active until an administrator explicitly deactivates it or changes the password.



### Changing the password and use of auto-login function

Note that when you change the default password, the default auto-login function no longer works!

In this case, you must enter the new password manually to log on.

### Adapting the auto-login function to a new password

If you change the password that is used during auto-login, this function no longer works. Adapt the settings for the auto-login function first.



Changing the password for auto-login requires administrator rights.



1. Select the "Windows" icon in the toolbar to access the operating system of the FSW (see also ["To access the "Start" menu"](#) on page 35).
2. Open the `C:\R_S\INSTR\USER\AUTOLOGIN.REG` file in any text editor (e.g. Notepad).
3. In the line `"DefaultPassword"="894129"`, replace the default password (894129) by the new password for automatic login.
4. Save the changes to the file.
5. In the Windows "Start" menu, select "Run".  
The "Run" dialog box is displayed.
6. Enter the command `C:\R_S\INSTR\USER\AUTOLOGIN.REG`.
7. Press [ENTER] to confirm.  
The auto-login function is reactivated with the changed password. It is applied the next time you switch on the instrument.

### Switching users when using the auto-login function

Which user account is used is defined during login. If auto-login is active, the login window is not displayed. However, you can switch the user account to be used even when the auto-login function is active.



1. Select the "Windows" icon in the toolbar to access the operating system of the FSW (see also ["To access the "Start" menu"](#) on page 35).
2. Press [CTRL] + [ALT] + [DEL], then select "Sign out".  
The "Login" dialog box is displayed, in which you can enter the different user account name and password.

For information on deactivating and reactivating the auto-login function, see ["Deactivating the auto-login function"](#) on page 880.

### 4.2.12 Checking the supplied options

The instrument can be equipped with both hardware and firmware options. To check whether the installed options correspond to the options indicated on the delivery note, proceed as follows.

1. Press [SETUP].
2. Press "System Config".
3. Switch to the "Versions + Options" tab in the "System Configuration" dialog box.  
A list with hardware and firmware information is displayed.
4. Check the availability of the hardware options as indicated in the delivery note.

### 4.2.13 Performing a self-alignment

When temperature changes occur in the environment of the FSW, or after updating the firmware, you have to perform a self-alignment to align the data to a reference source.

During self-alignment, do not connect a signal to the RF input connector. Running a self-alignment with a signal connected to the RF input can lead to false measurement results.

#### Performing a self-alignment

Before performing this alignment, make sure that the instrument has reached its operating temperature (for details, refer to the specifications document).

A message in the status bar ("Instrument warming up...") indicates that the operating temperature has not yet been reached.

Depending on the installation settings, an automatic self-alignment is performed after installation. A dialog box is displayed indicating how much warm-up time is still required before self-alignment can be performed.

1. Press [Setup].
2. Press "Alignment".
3. Select "Start Self Alignment" in the "Alignment" dialog box.

Once the system correction values have been calculated successfully, a message is displayed.



#### To display the alignment results again later

- Press [SETUP].
- Press "Alignment".

## 4.2.14 Considerations for test setup

### Cable selection and electromagnetic interference (EMI)

Electromagnetic interference (EMI) can affect the measurement results.

To suppress electromagnetic radiation during operation:

- Use high-quality shielded cables, for example, double-shielded RF and LAN cables.
- Always terminate open cable ends.
- Ensure that connected external devices comply with EMC regulations.

### Signal input and output levels

Information on signal levels is provided in the specifications document and on the instrument, next to the connector. Keep the signal levels within the specified ranges to avoid damage to the FSW and connected devices.

## 4.2.15 Protecting data using the secure user mode

During normal operation, the FSW uses a solid-state drive to store its operating system, instrument firmware, instrument self-alignment data, and any user data created during operation.

If necessary, the solid-state drive can be removed from the FSW and locked in a secure place to protect any classified data it may contain.

### Redirecting storage to volatile memory

Alternatively, to avoid storing any sensitive data on the FSW permanently, the *secure user mode* was introduced (option R&S FSW-K33). In secure user mode, the instrument's solid-state drive is write-protected so that no information can be written to memory permanently. Data that the FSW normally stores on the solid-state drive is redirected to volatile memory instead, which remains available only until the instrument is switched off. This data includes:

- Windows operating system files
- Firmware shutdown files containing information on last instrument state
- Self-alignment data
- General instrument settings such as the IP address
- Measurement settings
- User data created during operation (see also [Table 10-1](#))
- Any data created by other applications installed on the FSW, for example, text editors (Notepad), the clipboard, or drawing tools.

Users can access data that is stored in volatile memory just as in normal operation. However, when the instrument's power is switched off, all data in this memory is

cleared. Thus, in secure user mode, the instrument always starts in a defined, fixed state when switched on.

To store data such as measurement results permanently, it must be stored to an external storage device, such as a memory stick.



#### Limited storage space

The volatile memory used to store data in secure user mode is restricted to 256 MB. Thus, a "Memory full" error can occur although the hard disk indicates that storage space is still available.

#### Storing required data permanently

Any data that is to be available for subsequent sessions with the FSW must be stored on the instrument permanently, *before activating the secure user mode*. This includes predefined instrument settings, transducer factors and self-alignment data.



#### Self-alignment data

Note that self-alignment data becomes invalid with time and due to temperature changes. Therefore, to achieve optimal accuracy, it can be preferable to perform a new self-alignment at the start of each new session on the FSW.



#### Windows updates

In secure user mode, in rare cases, Windows updates trigger a reboot. We recommend using secure user mode on R&S FSW-K33 only in private LAN without access to the internet or disconnected to LAN to avoid unwanted Windows updates. In preparation for Windows updates, disable secure user mode temporarily.

#### Restricted operation

Since permanent storage is not possible, the following functions are not available in secure user mode:

- Firmware update
- Activating a new option key

Furthermore, since the "SecureUser" used in secure user mode does not have administrator rights, **administrative tasks** such as LAN configuration and some general instrument settings are not available. Refer to the description of the basic instrument setup ([SETUP] menu) to find out which functions are affected.

#### Activating and deactivating secure user mode

Only a user with administrator rights can activate (and deactivate) the secure user mode. Once activated, a restart is required. The special user "SecureUser" is then logged on to the FSW automatically using the auto-login function. While the secure user mode is active, a message is displayed in the status bar at the bottom of the screen.





### Secure passwords

By default, the initial password for both the administrator account and the "Secure-User" account is "894129". When the secure user mode is activated the first time after installation, you are prompted to change the passwords for all user accounts to improve system security. Although it is possible to continue without changing the passwords, it is strongly recommended that you do so.

You can change the password in Windows 10 for any user at any time via:

"Start > Settings > Account > SignIn Options > Password > Change"

To deactivate the secure user mode, the "SecureUser" must log off and a user with administrator rights must log on.



### Switching users when using the auto-login function

In the "Start" menu, select the arrow next to "Shut down" and then "Log off".

The "Login" dialog box is displayed, in which you can enter the different user account name and password.

The secure user mode setting and auto-login is automatically deactivated when another user logs on. The "SecureUser" is no longer available.

For users with administrator rights, the secure user mode setting is available in the general system configuration settings (see "[SecureUser Mode](#)" on page 792).

### Remote control

Initially after installation of the R&S FSW-K33 option, secure user mode must be enabled manually once before remote control is possible.

(See `SYSTEM:SECurity[:STATe].`)

Manual activation is necessary to prompt for a change of passwords.

## 4.3 Instrument tour

### 4.3.1 Front panel view

This chapter describes the front panel, including all function keys and connectors.

(Note: the graphic shows a 26 GHz model of the FSW. Some connectors on the 85 GHz model differ slightly; differences are indicated for the individual connectors.)

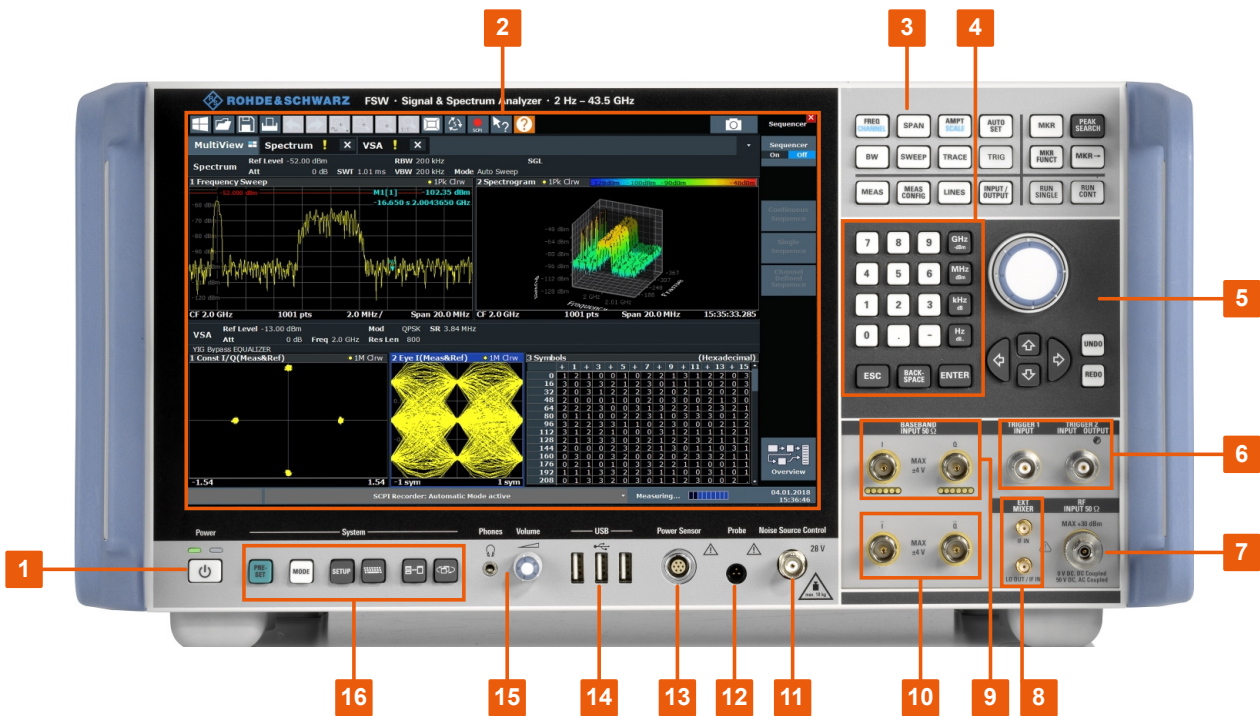

Figure 4-1: Front panel view of FSW26

- 1 = POWER key
- 2 = Touchscreen
- 3 = Function keys
- 4 = Keypad
- 5 = Navigation controls
- 6 = TRIGGER INPUT/OUTPUT connectors
- 7 = RF Input 50  $\Omega$  connector
- 8 = EXT MIXER connector (optional)
- 9 = (Analog) Baseband Input 50 $\Omega$  connectors for I/Q signal or Rohde & Schwarz active probes (optional)
- 10 = (Analog) Baseband Input 50 $\Omega$  connectors for inverse part of differential I/Q signal (optional, not for FSW85)
- 11 = NOISE SOURCE CONTROL
- 12 = PROBE connector
- 13 = POWER SENSOR connector
- 14 = USB connectors
- 15 = Headphones connector and volume control
- 16 = SYSTEM keys

#### 4.3.1.1 Power key



The power key is on the lower left corner of the front panel. It starts up and shuts down the instrument.

See also "[Connecting to power](#)" on page 19.

### 4.3.1.2 Touchscreen

All measurement results are displayed on the screen on the front panel. Additionally, the screen display provides status and setting information and allows you to switch between various measurement tasks. The screen is touch-sensitive, offering an alternative means of user interaction for quick and easy handling of the instrument.

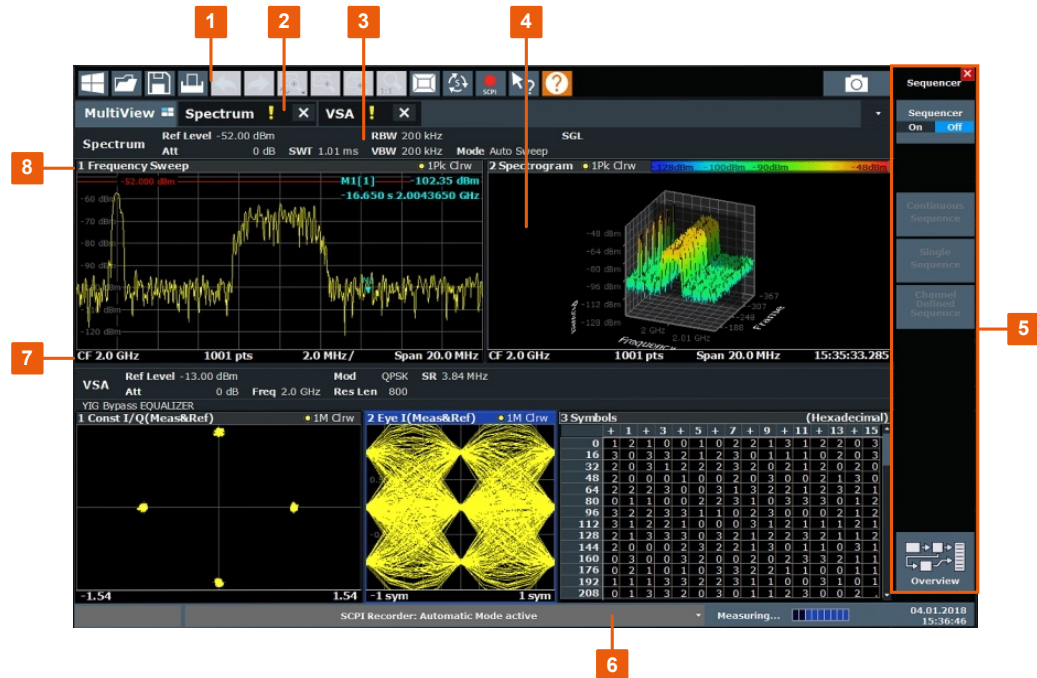

Figure 4-2: Touchscreen elements

- 1 = Toolbar with standard application functions, e.g. print, save/open file etc.
- 2 = Tabs for individual measurement channels
- 3 = Channel bar for firmware and measurement settings
- 4 = Measurement results area
- 5 = Softkeys for function access
- 6 = Instrument status bar with error messages, progress bar and date/time display
- 7 = Diagram footer with diagram-specific information, depending on application
- 8 = Window title bar with diagram-specific (trace) information

Any user interface elements that react to a click by a mouse pointer also react to a tap on the screen, and vice versa. Using touchscreen gestures, you can perform the following tasks (among others, see also [Chapter 4.4, "Trying out the instrument"](#), on page 61):

- Changing a setting
- Changing the display
- Moving a marker
- Zooming into a diagram
- Selecting a new evaluation method
- Scrolling through a result list or table
- Saving or printing results and settings

To imitate a right-click by mouse using the touchscreen, for example to open a context-sensitive menu for a specific item, press the screen for about 1 second.

For details on touchscreen gestures, see [Chapter 4.5.5, "Touchscreen gestures"](#), on page 97.

### 4.3.1.3 Function keys

Function keys provide access to the most common measurement settings and functions.

A detailed description of the corresponding functions is provided in the User Manual.

**Table 4-2: Function keys**

Function key	Assigned functions
<b>Basic measurement settings</b>	
[FREQ]	Sets the center frequency and the start and stop frequencies for the frequency range under consideration. This key is also used to set the frequency offset and the signal track function.
[SPAN]	Sets the frequency span to be analyzed.
[AMPT]	Sets the reference level, the displayed dynamic range, the RF attenuation and the unit for the level display. Sets the level offset and the input impedance. Activates the preamplifier (option RF Preamplifier, R&S FSW-B24).
[AUTO SET]	Enables automatic settings for level, frequency or sweep type mode.
[BW]	Sets the resolution bandwidth and the video bandwidth.
[SWEEP]	Sets the sweep time and the number of measurement points. Selects continuous measurement or single measurement.
[TRACE]	Configures the measured data acquisition and the analysis of the measurement data.
[TRIG]	Sets the trigger mode, the trigger threshold, the trigger delay, and the gate configuration in the case of gated sweep.
<b>Marker functions</b>	
[MKR]	Sets and positions the absolute and relative measurement markers (markers and delta markers).
[PEAK SEARCH]	Performs a peak search for active marker. If no marker is active, normal marker 1 is activated and the peak search is performed for it.
[MKR FUNC]	Provides additional analysis functions of the measurement markers: Frequency counter (Sig Count) Fixed reference point for relative measurement markers (Ref Fixed) Noise marker (Noise Meas) Phase noise (Phase Noise) n dB down function AM/FM audio demodulation Peak list

Function key	Assigned functions
[MKR->]	Used for search functions of the measurement markers (maximum/minimum of the trace). Assigns the marker frequency to the center frequency, and the marker level to the reference level. Restricts the search area (Search Limits) and characterizes the maximum points and minimum points (Peak Excursion).
<b>Measurement and evaluation functions</b>	
[MEAS]	Provides the measurement functions. Measurement of multicarrier adjacent channel power (Ch Power ACLR) Carrier to noise spacing (C/N C/N <sub>0</sub> ) Occupied bandwidth (OBW) Spectrum emission mask measurement (Spectrum Emission Mask) Spurious emissions (Spurious Emissions) Measurement of time domain power (Time Domain Power) Signal statistics: amplitude probability distribution (APD) and cumulative complementary distribution function (CCDF) Third-order intercept point (TOI) AM modulation depth (AM Mod Depth)
[MEAS CONFIG]	Used to define measurement configuration.
[LINES]	Configures display lines and limit lines.
[INPUT/OUTPUT]	Displays softkeys for input/output functions.
<b>Measurement start functions</b>	
[RUN SINGLE]	Starts a single new measurement (Single Sweep Mode).
[RUN CONT]	Starts a continuous measurement (Continuous Sweep Mode).
<b>Function execution</b> (in navigation controls area)	
[UNDO]	Reverts last operation
[REDO]	Repeats previously reverted operation.

#### 4.3.1.4 Navigation controls

The navigation controls include a rotary knob, navigation keys, and Undo / Redo keys. They allow you to navigate within the display or within dialog boxes.



#### Navigating in tables

The easiest way to navigate within tables (both in result tables and configuration tables) is to scroll through the entries with your finger on the touchscreen.

#### Rotary knob



The rotary knob has several functions:

- For numeric entries: increments (clockwise direction) or decrements (counterclockwise direction) the instrument parameter at a defined step width
- In lists: toggles between entries
- For markers, limit lines, and other graphical elements on the screen: moves their position
- For active scroll bars: moves the scroll bar vertically
- For dialog boxes: Same effect as the Enter key when pressed

### Navigation keys

You can use the navigation keys as an alternative to the rotary knob to navigate through dialog boxes, diagrams or tables.

#### Arrow Up/Arrow Down Keys

The <arrow up> or <arrow down> keys do the following:

- For numeric entries: increments (Arrow Up) or decrements (Arrow Down) the instrument parameter at a defined step width
- In a list: scrolls forward and backward through the list entries
- In a table: moves the selection bar vertically
- In windows or dialog boxes with a vertical scroll bar: moves the scroll bar

#### Arrow Left/Arrow Right Keys

The <arrow left> or <arrow right> keys do the following:

- In an alphanumeric edit dialog box, move the cursor.
- In a list, scroll forward and backward through the list entries.
- In a table, move the selection bar horizontally.
- In windows or dialog boxes with horizontal scroll bar, move the scroll bar.

### Undo/redo keys

- [Undo] reverts the previous action, i.e. the state before the previous action is retrieved.  
The undo function is useful, for example, if you accidentally select a different measurement. In this case, many settings are lost. However, if you press [Undo] immediately afterwards, the previous state is retrieved, i.e. the previous measurement and all settings.
- [Redo] repeats the previously reverted action, i.e. the most recent action is repeated.



The [Undo] function is not available after a [Preset] or "Recall" operation. When you use these functions, the history of previous actions is deleted.

### 4.3.1.5 Keypad

The keypad is used to enter alphanumeric parameters, including the corresponding units (see also [Chapter 4.5.4.2, "Entering alphanumeric parameters"](#), on page 95). It contains the following keys:

**Table 4-3: Keys on the keypad**

Type of key	Description
Alphanumeric keys	Enter numbers and (special) characters in edit dialog boxes.
Decimal point	Inserts a decimal point "." at the cursor position.
Sign key	Changes the sign of a numeric parameter. For an alphanumeric parameter, inserts a "-" at the cursor position.
Unit keys (GHz/-dBm MHz/dBm, kHz/dB and Hz/dB)	Adds the selected unit to the entered numeric value and complete the entry.  For level entries (e.g. in dB) or dimensionless values, all units have the value "1" as multiplying factor. Thus, they have the same function as an Enter key.
[Esc] key	Closes all kinds of dialog boxes, if the edit Mode is not active. Quits the edit mode, if the edit mode is active. In dialog boxes that contain a "Cancel" button it activates that button.  For "Edit" dialog boxes the following mechanism is used: <ul style="list-style-type: none"> <li>• If data entry has been started, it retains the original value and closes the dialog box.</li> <li>• If data entry has not been started or has been completed, it closes the dialog box.</li> </ul>
Backspace key	If an alphanumeric entry has already been started, this key deletes the character to the left of the cursor.
Enter key	<ul style="list-style-type: none"> <li>• Concludes the entry of dimensionless entries. The new value is accepted.</li> <li>• With other entries, this key can be used instead of the "Hz/dB" unit key.</li> <li>• In a dialog box, selects the default or focused element.</li> </ul>

### 4.3.1.6 TRIGGER INPUT / OUTPUT

Use the female "TRIGGER INPUT" connector to input an external trigger or gate data. Thus, you can control the measurement using an external signal. The voltage levels can range from 0.5 V to 3.5 V. The default value is 1.4 V. The typical input impedance is 10 k $\Omega$ .

Use the female BNC "TRIGGER INPUT / OUTPUT" connector to receive a second external signal or to provide a signal to another device. The signal is TTL compatible (0 V / 5 V). You control the connector usage in the "Trigger" settings ([TRIG] key).

The trigger output also controls signals by the frequency mask trigger available in Real-Time mode.



The rear panel provides a third "TRIGGER INPUT / OUTPUT" connector, see [Chapter 4.3.2.12, "TRIGGER 3 INPUT/ OUTPUT"](#), on page 57. (Not models 1312.8000Kxx)

For FSW85 models, the second trigger (female BNC "TRIGGER INPUT / OUTPUT" connector) on the front panel is not available due to the second RF input connector (see [Chapter 4.3.1.7, "RF input 50 ohm"](#), on page 48).

#### 4.3.1.7 RF input 50 ohm

Provides RF input from a connected device under test (DUT) to the FSW, which is then analyzed in an RF measurement. Connect the DUT to the "RF Input" connector on the FSW. Do not overload the input. For maximum allowed values, see the specifications document.

The specific connector type depends on the instrument model:

- **FSW26:** APC 3.5 mm male (compatible with R&S SMA)
- **FSW43:** 2.92 mm male (compatible with R&S SMA)
- **FSW50/67:** 1.85 mm male (compatible with 2.4 mm)
- **FSW85:**
  - Input 1: 1.00 mm RF input connector for frequencies up to 85 GHz (90 GHz with option R&S FSW-B90G)
  - Input 2: 1.85 mm RF input connector for frequencies up to 67 GHz

For models 1312.8000Kxx:

1.00 mm RF input connector for frequencies up to 85 GHz (90 GHz with option R&S FSW-B90G)

### NOTICE

#### Risk of instrument damage

Do not fasten the 1.00 mm "RF Input" connector with a torque larger than 0.23 Nm. Rohde & Schwarz offers an appropriate torque wrench (R&S®ZN-ZTW Torque 0.23 Nm; delivered with the instrument).

The RF input can be coupled to the DUT by alternating current (AC) or direct current (DC). AC coupling blocks any DC voltage from the input signal. This is the default setting to prevent damage to the instrument. However, some specifications require DC coupling. In this case, you must protect the instrument from damaging DC input voltages manually. For details, refer to the specifications document.

See also [Chapter 4.2.14, "Considerations for test setup"](#), on page 39.

For FSW85 models, which have two input connectors, you must define which input source is used for each measurement channel.

(See [Chapter 7.2.2.1, "Radio frequency input"](#), on page 362).



#### 4.3.1.8 EXT MIXER connector (optional)

Connect external mixers to the "EXT MIXER LO OUT/IF IN" and "IF IN" female connectors to increase the available frequency range. These connectors are optional and only available with R&S FSW-B21.

If no external mixers are connected to the FSW, cover the two front connectors "LO OUT / IF IN" and "IF IN" with the supplied SMA caps.

#### 4.3.1.9 (Analog) baseband input 50 ohm connectors (optional)

The "Analog Baseband" interface option provides four "Baseband input" BNC connectors on the front panel of the FSW for analog I and Q signals.

(FSW85: two connectors)



The upper BNC connectors BASEBAND INPUT I and BASEBAND INPUT Q are used to input:

- Single-ended signals
- The positive signal input for differential signals
- Input from active Rohde & Schwarz probes (see specifications document)

The lower BNC connectors  $\bar{I}$  and  $\bar{Q}$  are used to input the negative signal for differential signals.



#### FSW85

The FSW85 provides only two connectors; differential input is not supported.



#### Complex signal input (I+jQ)

For complex signal input (I+jQ), always use two identical cables for the I and Q connectors (same length, same type, same manufacturer). Otherwise, time delay or gain imbalance can occur between the different cables, which cannot be calibrated.

All connectors have a fixed impedance of 50 Ω. Do not overload the input. For maximum allowed values, see the specifications document.

Since the Digital I/Q input and the Analog Baseband input use the same digital signal path, both cannot be used simultaneously. When one is activated, established connections for the other are disconnected. When the second input is deactivated, connections to the first are re-established. This can cause a short delay in data transfer after switching the input source.

Input via the "Analog Baseband" interface can be enabled in the I/Q Analyzer or in one of the optional applications that process I/Q data (where available).

#### 4.3.1.10 Noise source control

The noise source control female connector is used to provide the supply voltage for an external noise source. For example, use it to measure the noise figure and gain of amplifiers and frequency converting devices.

Conventional noise sources require a voltage of +28 V to be switched on and 0 V to be switched off. The output supports a maximum load of 100 mA.



For smart noise sources, use the Lemosia [Power sensor](#) connector.

For details on noise source control, see ["Noise Source Control"](#) on page 468.

#### 4.3.1.11 Probe

The FSW provides a connector for supply voltages of +15 V to -12 V and ground for active probes and preamplifiers. A maximum current of 140 mA is available. This connector is suitable as a power supply for high-impedance probes.

For details on configuring and using power sensors, see [Chapter 7.2.3, "Power sensors"](#), on page 367.

#### 4.3.1.12 Power sensor

The "Lemosia" female connector is used to connect Rohde & Schwarz power sensors, but also smart noise sources. For a detailed list of supported sensors and smart noise sources, see the specifications document.

For details on configuring and using power sensors, see [Chapter 7.2.3, "Power sensors"](#), on page 367. For details on noise source control, see ["Noise Source Control"](#) on page 468.

A smart noise source (SNS) provides its own ENR and uncertainty tables and a temperature value from an internal measurement. Thus, accuracy is improved and less configuration efforts are required compared to common noise sources.

Connect the smart noise source to the Lemosia "Power Sensor" connector on the FSW. Then connect the SNS output to the DUT or the "RF Input" connector on the FSW.

When you connect a smart noise source, the FSW automatically loads its ENR table and stores it for future measurements. The ENR table remains stored on the instru-

ment even after the noise source is disconnected. If the table already exists on the FSW, the contents are updated, if necessary. The identification and setup procedure after connecting the R&S FS-SNS can take up to 10 seconds.

For details on Rohde & Schwarz smart noise sources, see the product documentation.

#### 4.3.1.13 USB

The front panel provides three female "USB" connectors ("USB-A") to connect devices like a keyboard or a mouse. In addition, a memory stick can be connected to store and reload instrument settings and measurement data.



The rear panel provides further "USB" connectors, including a male ("USB-B") connector. See [Chapter 4.3.2.3, "USB"](#), on page 54.

All USB connectors support standard 2.0.

#### 4.3.1.14 Phones and volume

You can use headphones to monitor demodulated audio frequencies in time domain measurements acoustically.

Connect headphones equipped with a miniature jack plug to the "PHONES" female connector. Set the output voltage using the "Volume" control to the right of the female connector. The maximum output voltage (volume) is 1 V. If a headphone is plugged into the instrument, the internal loudspeaker is automatically switched off.

The output provided to the "PHONES" connector is the same as the (video) output at the [IF/VIDEO/DEMOD OUTPUT](#) connector.

See also ["Using headphones"](#) on page 19.



#### 4.3.1.15 SYSTEM keys

[SYSTEM] keys set the instrument to a predefined state, change basic settings, and provide print and display functions.

A detailed description of the corresponding functions is provided in the User Manual.

**Table 4-4: SYSTEM keys**

SYSTEM key	Assigned functions
[PRESET]	Resets the instrument to the default state.
[MODE]	Provides the selection between applications
[SETUP]	Provides basic instrument configuration functions, e.g.: <ul style="list-style-type: none"> <li>• Reference frequency (external/internal), noise source</li> <li>• Date, time, display configuration</li> <li>• LAN interface</li> <li>• Self-alignment</li> <li>• Firmware update and enabling of options</li> <li>• Information about instrument configuration incl. firmware version and system error messages</li> <li>• Service support functions (self-test etc.)</li> </ul>

SYSTEM key	Assigned functions
	Switches between the on-screen keyboard display: <ul style="list-style-type: none"> <li>• At the top of the screen</li> <li>• At the bottom of the screen</li> <li>• Off</li> </ul>
	Switches between maximized and split display of focus area.
	Moves focus area from one active window to the next.

### 4.3.2 Rear panel view

This figure shows the rear panel view of the FSW. The individual elements are described in more detail in the subsequent sections.



Figure 4-3: Rear panel view

- 1 = see [Figure 4-4](#)
- 2 = see [Figure 4-5](#)
- 3 = see [Figure 4-6](#)
- 4 = see [Figure 4-7](#)
- 5 = IF OUT 2 GHz connector
- 6 = Device ID with serial number and other labels

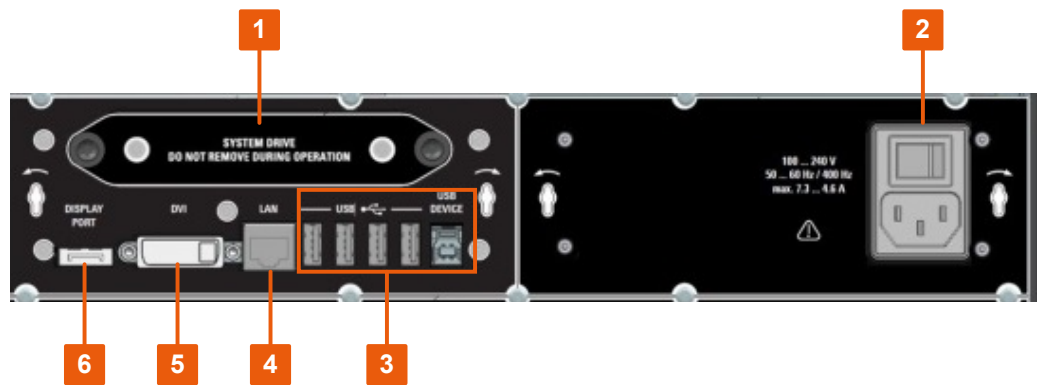

Figure 4-4: Rear panel view - extract 1

- 1 = Removable system hard drive
- 2 = AC Power Supply Connection and Main Power Switch
- 3 = USB (DEVICE) connectors
- 4 = LAN connector
- 5 = DVI connector for external display
- 6 = DISPLAY PORT for external display

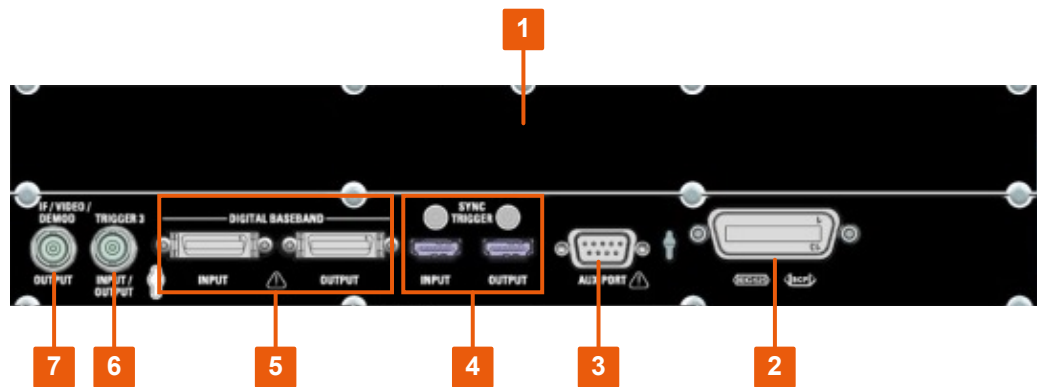

Figure 4-5: Rear panel view - extract 2

- 1 = Bandwidth extension options, with "IF WIDE OUTPUT" connector (option -B160/-B320-B512) and Digital I/Q 40G Streaming Output QSFP+ connector (option B517/B1017)
- 2 = GPIB interface
- 3 = AUX PORT
- 4 = SYNC TRIGGER OUTPUT/INPUT
- 5 = DIGITAL BASEBAND INPUT/OUTPUT connectors (option B17)
- 6 = TRIGGER 3 INPUT/OUTPUT connector
- 7 = IF/VIDEO/DEMODO connector

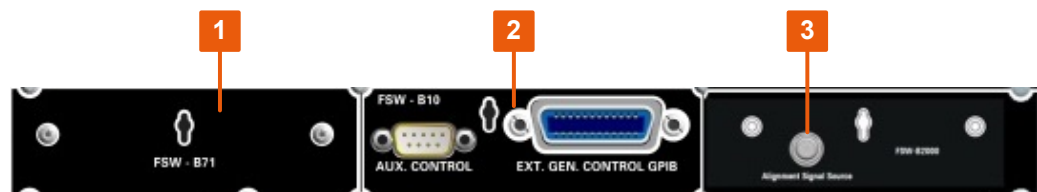

Figure 4-6: Rear panel view - extract 3

- 1 = Analog baseband interface (option B71)
- 2 = External generator control (option B10)
- 3 = Alignment Signal Source (option B2000)



Figure 4-7: Rear panel view - extract 4

- 1 = OCKO external reference (option B4)
- 2 = REF INPUT/OUTPUT connectors

#### 4.3.2.1 Removable system hard drive

The removable system hard drive contains all measurement data from the FSW, allowing you to store the data securely in an external location.

#### 4.3.2.2 AC power supply connection and main power switch

An AC power supply connector and main power switch are located in a unit on the rear panel of the instrument.

Main power switch function:

Position 1: The instrument can be started via the Power key on the front panel.

The (optional) OCKO reference frequency is warmed up.

Position O: The entire instrument is disconnected from the AC power supply.

For details, refer to ["Connecting to power"](#) on page 19 and [Chapter 4.2.5, "Connecting the AC power"](#), on page 30.

#### 4.3.2.3 USB

The rear panel provides four additional female "USB (USB-A)" connectors to connect devices like a keyboard, a mouse or a memory stick (see also [Chapter 4.3.1.13, "USB"](#), on page 51).

Furthermore, a male "USB DEVICE" connector ("USB-B") is provided, for example to connect the FSW to a PC for remote control. (Not available for instruments with CPU board 1206.3874.00 or higher.)

All USB connectors support standard 2.0.

#### 4.3.2.4 LAN

The FSW is equipped with a 1 GBit Ethernet IEEE 802.3u network interface with Auto-MDI(X) functionality. The assignment of the RJ-45 connector supports twisted-pair cat-

egory 5 UTP/STP cables in a star configuration (UTP stands for *unshielded twisted pair*, and STP for *shielded twisted pair*).

For details, see [Chapter 12, "Network operation and remote control"](#), on page 816.

#### 4.3.2.5 Display port and DVI

You can connect an external monitor or other display device to the FSW to provide an enlarged display. Two different types of connectors are provided for this purpose:

- Display Port
- DVI (digital visual interface)

For details, see [Chapter 4.2.9, "Connecting an external monitor"](#), on page 33.

#### 4.3.2.6 Bandwidth extension options and IF WIDE OUTPUT connector

You can extend the signal analysis bandwidth of the FSW by a hardware option (R&S FSW-B160/-B320/-B512/-B1200/-B2001/-B4001/-B8001 or R&S FSW-Uxxx). The bandwidth extension allows for an output sample rate of up to 10 GHz and a linear bandwidth up to:

- 160 MHz (with option B160/U160)
- 320 MHz (with option B320/U320)
- 512 MHz (with option B512/U512)
- 1200 MHz (with option B1200/U1200)
- 2001 MHz (with option B2001/U2001)
- 4001 MHz (with option B4001/U4001)
- 6001 MHz (with option B6001/U6001)
- 8001 MHz (with option B8001/U8001)

While the extension can be activated or deactivated manually in the FSW base unit (I/Q Analyzer application), it is activated automatically in some applications that also support I/Q data analysis. See the application-specific documentation for details.

##### IF WIDE OUTPUT connector

Together with the bandwidth extension options B160/B320/B512, an additional IF output connector is provided ("IF WIDE OUTPUT"). As opposed to the default [IF/VIDEO/DEMOD OUTPUT](#) connector, the IF output frequency of the optional connector cannot be defined manually, but is determined automatically depending on the center frequency. For details on the used frequencies, see the specifications document. The "IF WIDE OUTPUT" connector is used automatically when the bandwidth extension is activated (i.e. for bandwidths > 80 MHz).

#### 4.3.2.7 Digital I/Q 40G streaming output connector (R&S FSW-B517/-B1017)

The Digital I/Q 40G Streaming Output (QSFP+) connector is provided by the hardware of any bandwidth extension option for 512 MHz or more.



If necessary, remove the metal cover from the connector on the rear panel of the FSW.



The output connector provides I/Q data streams with a sample rate of up to 600 MHz, if the R&S FSW-B517 option is installed and active. With R&S FSW-B1017 installed, output rates up to 1200 MHz are available.

Output is activated in the software ([INPUT/OUTPUT] key).

See the FSW I/Q Analyzer and I/Q Input User Manual for details.

#### 4.3.2.8 GPIB interface

The GPIB interface is in compliance with IEEE488 and SCPI. A computer for remote control can be connected via this interface. To set up the connection, a shielded cable is recommended.

For more details, refer to [Chapter 12, "Network operation and remote control"](#), on page 816.

#### 4.3.2.9 Aux. port

A 9-pole SUB-D male connector used to provide low-voltage TTL control signals (max. 5 V). The output signals can be used to control external devices.





#### 4.3.2.10 SYNC TRIGGER OUTPUT/INPUT

Use the "SYNC TRIGGER OUTPUT/INPUT" connectors to synchronize several devices (e.g. two FSWs) to a common trigger signal or reference frequency. The FSW can output a 100 MHz signal as a trigger or reference signal to another device. The FSW can also receive an external trigger or reference signal at the input connector.

#### 4.3.2.11 DIGITAL BASEBAND INPUT / OUTPUT (R&S FSW-B17)

The optional "DIGITAL BASEBAND" connectors allow you to provide digital I/Q data for measurements with the FSW. Using the output connector you can provide RF input from the FSW to a connected device as digital I/Q data. The digital input and output connectors cannot be used simultaneously.

It is recommended that you use the R&S®SMU-Z6 (1415.0201.02) cable to connect other devices to the Digital Baseband Interface of the FSW.



For high output rates, use the Digital I/Q 40G Streaming Output option (R&S FSW-B517), see [Chapter 4.3.2.7, "Digital I/Q 40G streaming output connector \(R&S FSW-B517-B1017\)"](#), on page 55.

#### 4.3.2.12 TRIGGER 3 INPUT/ OUTPUT

The additional female BNC "TRIGGER INPUT / OUTPUT" connector can be used to receive a third external signal or to provide a signal to another device. The signal is TTL compatible (0 V / 5 V). You can control the connector usage in the "Trigger" settings ([TRIG] key).

#### 4.3.2.13 IF/VIDEO/DEMOD OUTPUT

The female BNC connector can be used for various outputs:

- Intermediate frequency (IF) output of approximately 20 MHz
- Video output (1V)

Which output is provided is defined in the software ([INPUT/OUTPUT] key).

For details, see ["Data Output"](#) on page 467.

#### 4.3.2.14 (Analog) baseband input 50 ohm connectors (optional)

The "Analog Baseband" interface option provides four "Baseband input" BNC connectors on the front panel of the FSW for analog I and Q signals.

(FSW85: two connectors)



The upper BNC connectors BASEBAND INPUT I and BASEBAND INPUT Q are used to input:

- Single-ended signals
- The positive signal input for differential signals
- Input from active Rohde & Schwarz probes (see specifications document)

The lower BNC connectors  $\bar{I}$  and  $\bar{Q}$  are used to input the negative signal for differential signals.



#### FSW85

The FSW85 provides only two connectors; differential input is not supported.



#### Complex signal input (I+jQ)

For complex signal input (I+jQ), always use two identical cables for the I and Q connectors (same length, same type, same manufacturer). Otherwise, time delay or gain imbalance can occur between the different cables, which cannot be calibrated.

All connectors have a fixed impedance of 50  $\Omega$ . Do not overload the input. For maximum allowed values, see the specifications document.

Since the Digital I/Q input and the Analog Baseband input use the same digital signal path, both cannot be used simultaneously. When one is activated, established connections for the other are disconnected. When the second input is deactivated, connections to the first are re-established. This can cause a short delay in data transfer after switching the input source.

Input via the "Analog Baseband" interface can be enabled in the I/Q Analyzer or in one of the optional applications that process I/Q data (where available).

#### 4.3.2.15 External generator control option (R&S FSW-B10)

The external generator control option provides an additional GPIB and an "AUX control" connector.

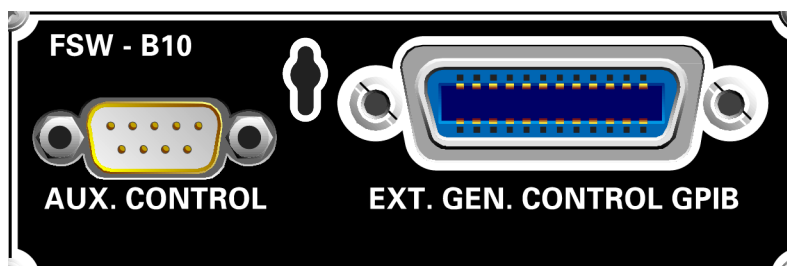

The GPIB connector can be used to connect the external generator to the FSW.

The 9-pole SUB-D female "AUX control" connector is required for TTL synchronization, if supported by the generator.

For details on connecting an external generator, see ["External generator connections"](#) on page 376.

#### 4.3.2.16 Alignment signal source (option R&S FSW-B2000)

The alignment signal source is required to align the connected oscilloscope and the oscilloscope ADC for the optional 2 GHz bandwidth extension (R&S FSW-B2000).

For details, see the FSW I/Q Analyzer and I/Q Input User Manual.

#### 4.3.2.17 REF INPUT / REF OUTPUT

The "REF INPUT" connectors are used to provide an external reference signal to the FSW.

The "REF OUTPUT" connectors can be used to provide an external reference signal (or the optional OCXO reference signal) from the FSW to other devices that are connected to this instrument.

Various connectors are provided for different reference signals:

Connector	Reference signal	Usage
"REF INPUT"	1...50 MHz 0...10 dBm	To provide an external reference signal on the FSW.
"REF OUTPUT"	1...50 MHz 0...10 dBm	To provide the same external reference signal received by the "REF INPUT 1...50 MHz" connector to another device, when available.
"REF OUTPUT"	10 MHz 10 dBm	To provide the internal reference signal from the FSW to another device continuously. Also used to provide OCXO reference signal to another device.
"REF INPUT"	100 MHz / 1 GHz 0...10 dBm	To provide an external reference signal on the FSW.

Connector	Reference signal	Usage
"REF OUTPUT"	100 MHz 6 dBm	To provide a 100 MHz reference signal from the FSW to another device.
"REF OUTPUT"	640 MHz 16 dBm	To provide a 640 MHz reference signal from the FSW to another device.



### SYNC TRIGGER

The "SYNC TRIGGER" connector can also be used to synchronize the reference frequency on several devices (see [Chapter 4.3.2.10, "SYNC TRIGGER OUTPUT/INPUT"](#), on page 57).

#### 4.3.2.18 OCXO option (R&S FSW-B4)

This option generates a 10 MHz reference signal with a very precise frequency. If installed, and if no external signal is used, this signal is used as an internal reference. It can also be used to synchronize other connected devices via the "REF OUTPUT 10 MHz" connector.



### Warm-up time for OCXO

When the instrument is switched on, the OCXO requires an extended warm-up time. For details, refer to the specifications document.

#### 4.3.2.19 IF OUT 2 GHz / 5 GHz connector

The female SMA connector is only available for instrument models FSW26/43/50/67/85. It can be used to provide intermediate frequency (IF) output of approximately 2 GHz at a frequency of 2 GHz.

Output is activated in the software ([INPUT/OUTPUT] key).

For details, see the FSW I/Q Analyzer and I/Q Input User Manual.

#### 4.3.2.20 Labels on FSW

Labels on the casing inform about:

- Personal safety, see ["Meaning of safety labels"](#) on page 19
- Product and environment safety, see [Table 4-5](#)
- Identification of the product, see [Chapter 4.3.2.21, "Device ID"](#), on page 61

**Table 4-5: Labels regarding FSW and environment safety**

	<p>Labeling in line with EN 50419 for disposal of electrical and electronic equipment after the product has come to the end of its service life.</p> <p>For more information, see <a href="#">"Disposing of electrical and electronic equipment"</a> on page 1555.</p>
--	--

### 4.3.2.21 Device ID

The unique device identifier is provided as a barcode sticker on the rear panel of the FSW.

It consists of the device order number and a serial number.



The serial number is used to define the **default instrument name**, which is:

<Type><variant>-<serial\_number>

For example, FSW8-123456.

The instrument name is required to establish a connection to the instrument in a LAN.

## 4.4 Trying out the instrument

This chapter introduces the most important functions and settings of the FSW step by step. The complete description of the functionality and its usage is given in the FSW User Manual. Basic instrument operation is described in [Chapter 4.5, "Operating the instrument"](#), on page 79.

### Prerequisites

- The instrument is set up, connected to the mains system, and started up as described in [Chapter 4.2, "Preparing for use"](#), on page 27.

For these first measurements, you use the internal calibration signal, so you do not need any additional signal source or instruments. Try out the following:

- [Measuring a basic signal](#).....62
- [Displaying a spectrogram](#).....63
- [Activating additional measurement channels](#).....65
- [Performing sequential measurements](#)..... 68
- [Setting and moving a marker](#)..... 69
- [Displaying a marker peak list](#)..... 70
- [Zooming into the display](#)..... 71
- [Zooming into the display permanently](#)..... 74
- [Saving settings](#).....77
- [Printing and saving results](#)..... 78

### 4.4.1 Measuring a basic signal

We will start out by measuring a basic signal, using the internal calibration signal as the input.

#### To display the internal 64 MHz calibration signal

1. Press [PRESET] to start out in a defined instrument configuration.
2. Press [Setup] on the front panel.
3. Tap "Service + Support".
4. Tap the "Calibration Signal" tab.
5. Tap the "Calibration Frequency RF" option. Leave the frequency at the default 64 MHz, with a narrowband spectrum.

The calibration signal is now sent to the RF input of the FSW. By default, a continuous frequency sweep is performed, so that the spectrum of the calibration signal is now displayed in the standard level versus frequency diagram.

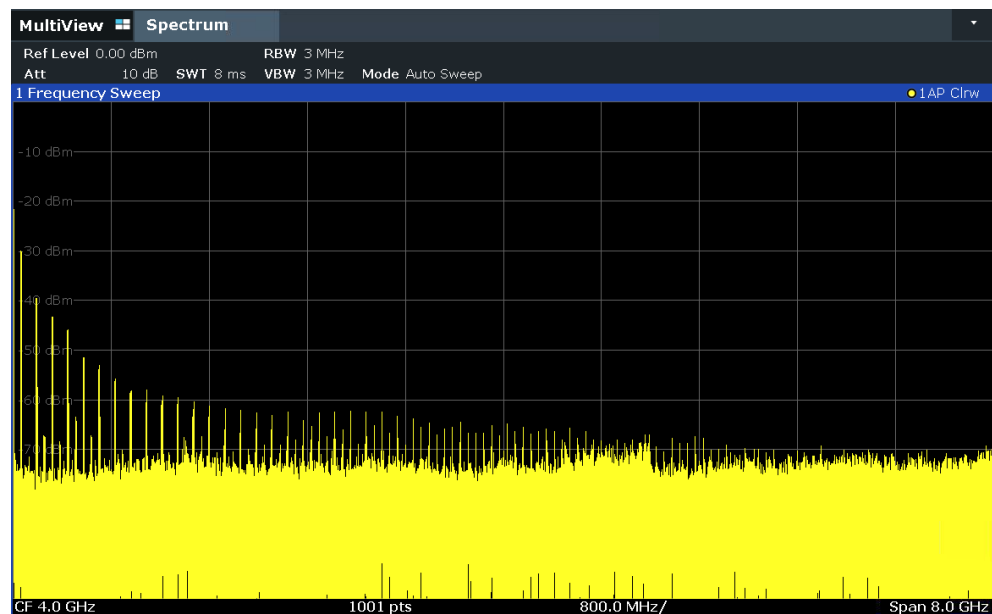

Figure 4-8: Calibration signal as RF input



#### Instrument warmup time

Note that the instrument requires an initial warmup time after switching it on. A message in the status bar ("Instrument warming up...") indicates that the operating temperature has not yet been reached. Wait until this message is no longer displayed before you start a measurement to obtain accurate results.

### To optimize the display

To optimize the display for the calibration signal, we will adjust the main measurement settings.

1. Set the center frequency to the calibration frequency:
  - a) Tap "Overview" to display the configuration "Overview".
  - b) Tap "Frequency".
  - c) In the "Center" field, enter 64 on the number pad on the front panel.
  - d) Press "MHz" next to the number pad.
2. Reduce the span to 20 MHz:
  - a) In the "Span" field of the "Frequency" dialog box, enter 20 MHz.
  - b) Close the "Frequency" dialog box.
3. Set the reference level to -25 dBm:
  - a) In the configuration "Overview", tap "Amplitude".
  - b) In the "Value" field of the "Amplitude" dialog box, enter -25 dBm.

The display of the calibration signal is now improved. The maximum at the center frequency (=calibration frequency) of 64 MHz becomes visible.

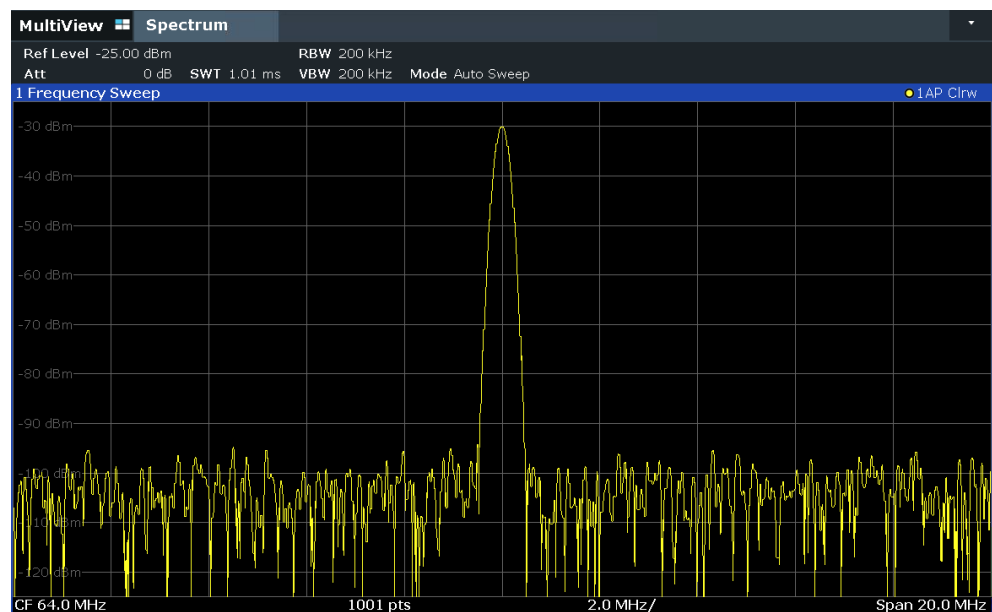

Figure 4-9: Calibration signal with optimized display settings

### 4.4.2 Displaying a spectrogram

In addition to the standard "level versus frequency" spectrum display, the FSW also provides a spectrogram display of the measured data. A spectrogram shows how the spectral density of a signal varies over time. The x-axis shows the frequency, the y-axis shows the time. A third dimension, the power level, is indicated by different colors.

Thus you can see how the strength of the signal varies over time for different frequencies.

1. Tap "Overview" to display the general configuration dialog box.
2. Tap "Display Config".

The SmartGrid mode is activated, and the evaluation bar with the available evaluation methods is displayed.

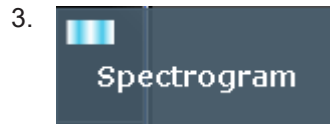

Drag the "Spectrogram" icon from the evaluation bar to the diagram area. The blue area indicates that the new diagram would replace the previous spectrum display. Since we do not want to replace the spectrum, drag the icon to the lower half of the display to add an additional window instead.

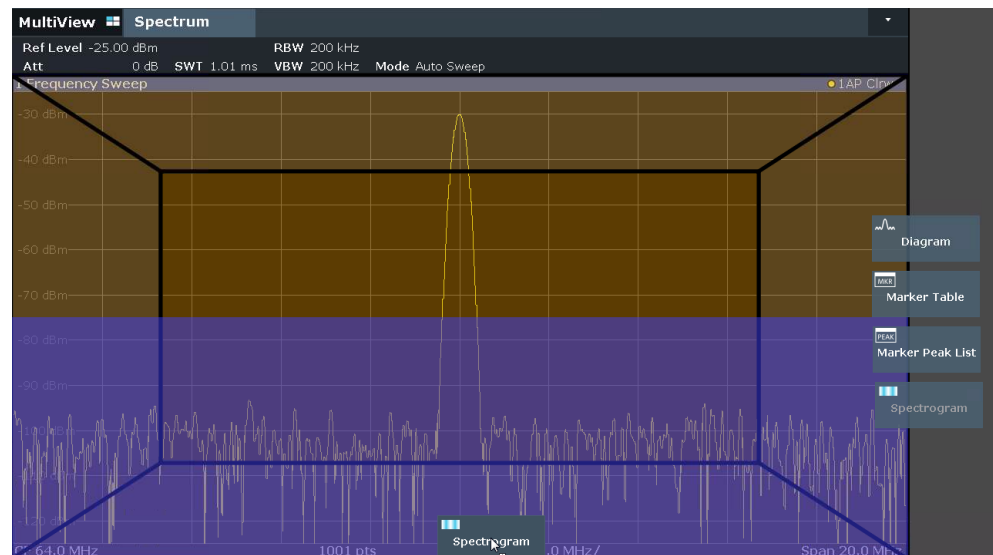

**Figure 4-10: Adding a Spectrogram to the display**

Drop the icon.

4. Close the SmartGrid mode by tapping the "Close" icon at the top right corner of the toolbar.



You see the spectrogram compared to the standard spectrum display. Since the calibration signal does not change over time, the color of the frequency levels does not change over time, i.e. vertically. The legend at the top of the spectrogram window describes the power levels the colors represent.



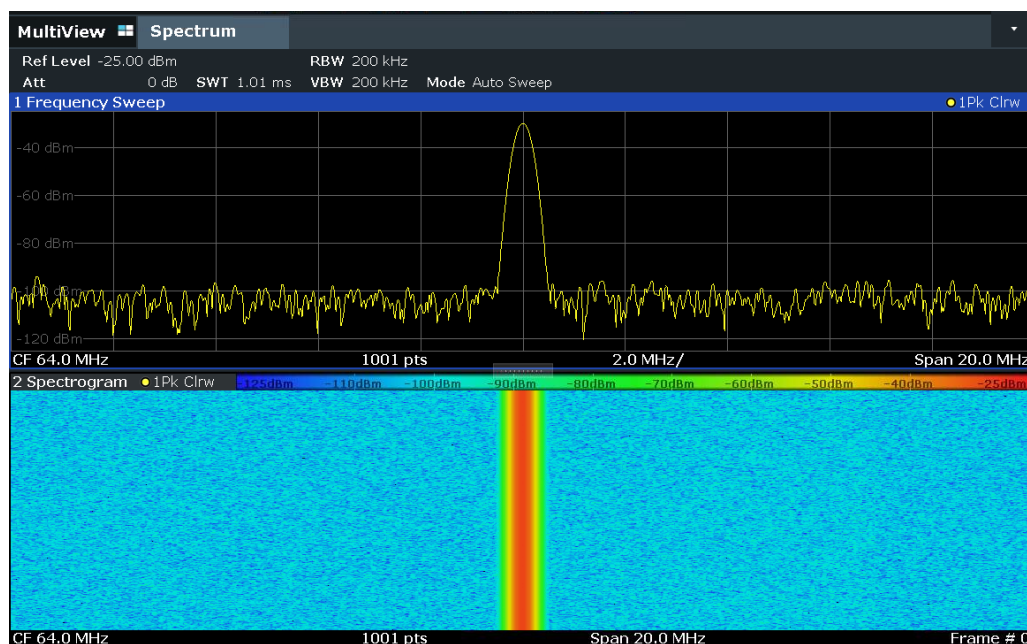

Figure 4-11: Spectrogram of the calibration signal

### 4.4.3 Activating additional measurement channels

The FSW features multiple measurement channels, i.e. you can define several measurement configurations in parallel and then switch between the channels automatically to perform the measurements sequentially. We will demonstrate this feature by activating additional measurement channels for a different frequency range, a zero span measurement, and an I/Q analysis.

#### To activate additional measurement channels

1. Press [Mode] on the front panel.
2. On the "New Channel" tab of the "Signal + Spectrum Mode" dialog box, tap "Spectrum".

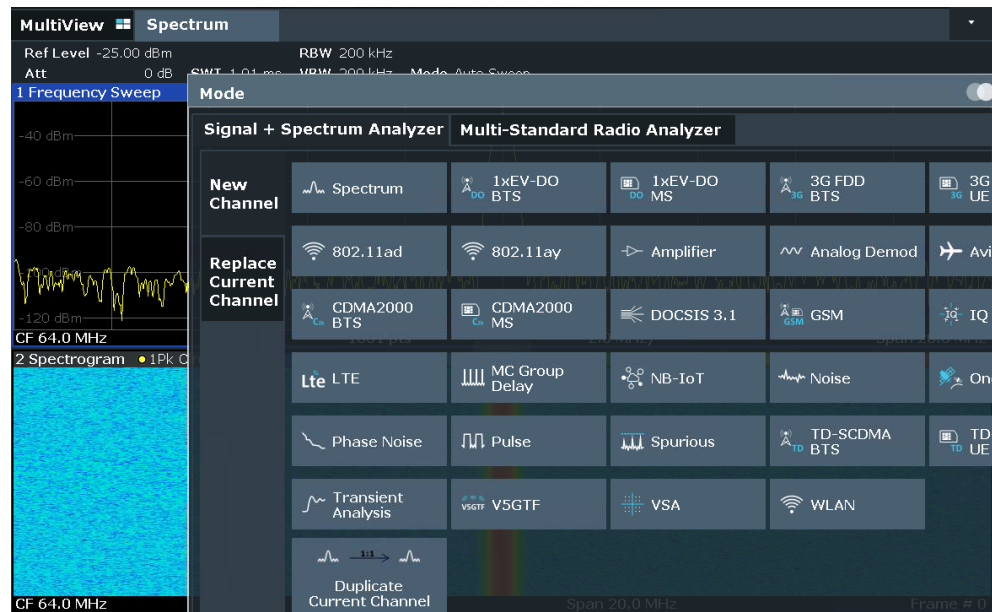

Figure 4-12: Adding a new measurement channel

- Change the frequency range for this spectrum display:  
In the "Frequency" dialog box, set the **center frequency** to *500 MHz* and the **span** to *1 GHz*.

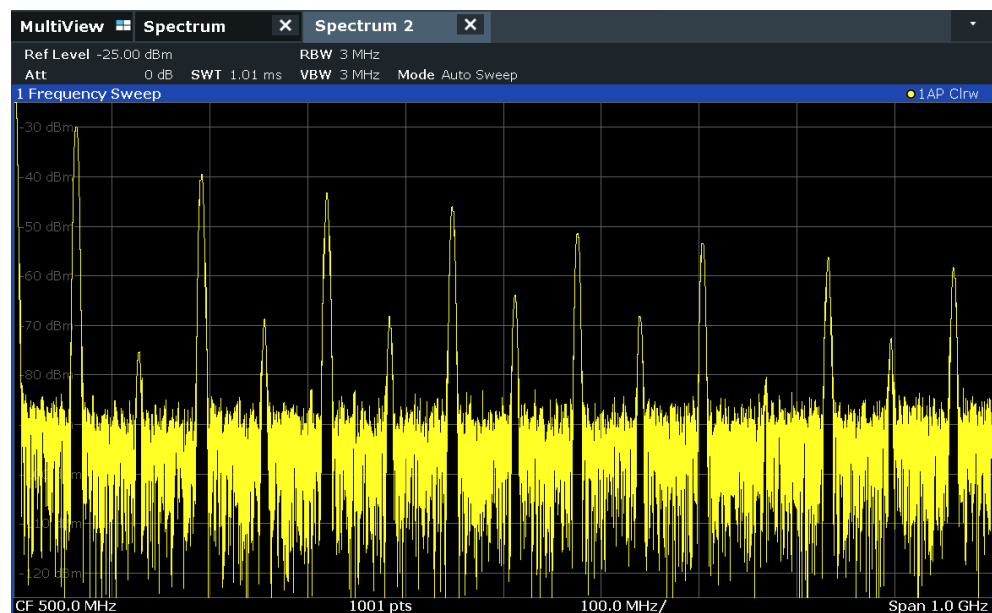

Figure 4-13: Frequency spectrum of the calibration signal with a larger span

- Repeat the previous steps to activate a third Spectrum window.  
Change the frequency range for this spectrum display:  
In the "Frequency" dialog box, set the **center frequency** to *64 MHz* and tap "Zero Span".

As the calibration signal does not vary over time, the level versus time diagram displays a straight line.



Figure 4-14: Time domain display of the calibration signal

5. Create a new channel for I/Q analysis:
  - a) Press [Mode].
  - b) Tap "IQ Analyzer" to activate a channel for the I/Q Analyzer application.
  - c) Tap "Display Config" to activate the SmartGrid mode.
  - d) Drag the "Real/Imag (I/Q)" icon from the evaluation bar to the SmartGrid.

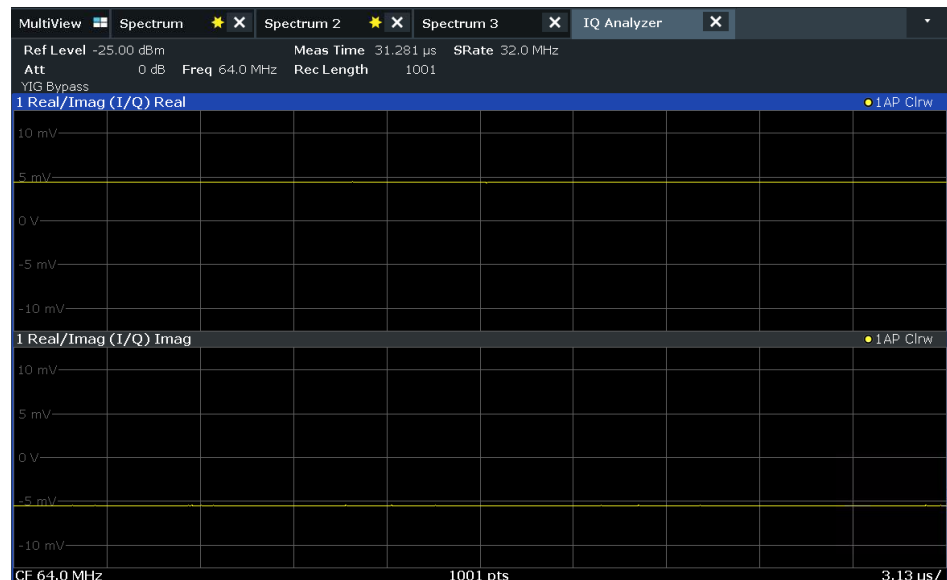

Figure 4-15: Inserting a Real/Imag diagram for I/Q analysis

- e) Close the SmartGrid mode.

The "IQ Analyzer" channel displays the real and imaginary signal parts in separate windows.

### To display the MultiView tab

An overview of all active channels is provided in the "MultiView" tab. This tab is always displayed and cannot be closed.

- ▶ Tap the "MultiView" tab.



Figure 4-16: The "MultiView" tab

#### 4.4.4 Performing sequential measurements

Although only one measurement can be performed at any one time, the measurements configured in the active channels can be performed sequentially, that means: one after the other, automatically, either once or continuously.



1. Tap the "Sequencer" icon in the toolbar.
2. Toggle "Sequencer" in the "Sequencer" menu to "On".

A continuous sequence is started, i.e. each channel measurement is performed one after the other until the Sequencer is stopped.



Figure 4-17: "MultiView" tab with active Sequencer



In Figure 4-17, the "Spectrum 2" measurement is currently active (indicated by the "channel active" icon in the tab label).

3. Stop the Sequencer by tapping "Sequencer" again.

#### 4.4.5 Setting and moving a marker

Markers are useful to determine the position of particular effects in the trace. The most common use is to determine a peak, which is the default setting when you activate a marker. We will set a marker on the peak in our first Spectrum measurement.

1. In the "MultiView" tab, double-tap the "Spectrum" window (frequency sweep with spectrogram display) to return to the "Spectrum" channel.
2. Tap the spectrum display to set the focus on that window.
3. Press "Split/Maximize" on the front panel to maximize the spectrum window, as we currently do not need the spectrogram display.
4. Press "RUN SINGLE" on the front panel to perform a single sweep so we have a fixed trace to set a marker on.
5. Press [MKR] on the front panel to display the "Marker" menu.

Marker 1 is activated and automatically set to the maximum of trace 1. The marker position and value is indicated in the diagram area as M1[1].



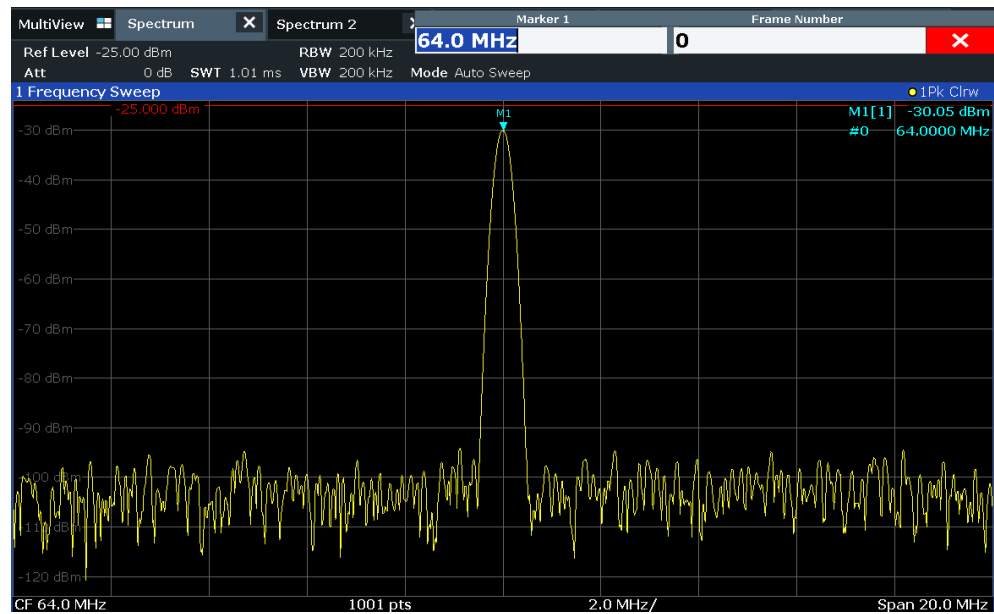

- Now you can move the marker by tapping and dragging it to a different position. The current position is indicated by a dotted blue line. Notice how the position and value change in the marker area of the diagram.

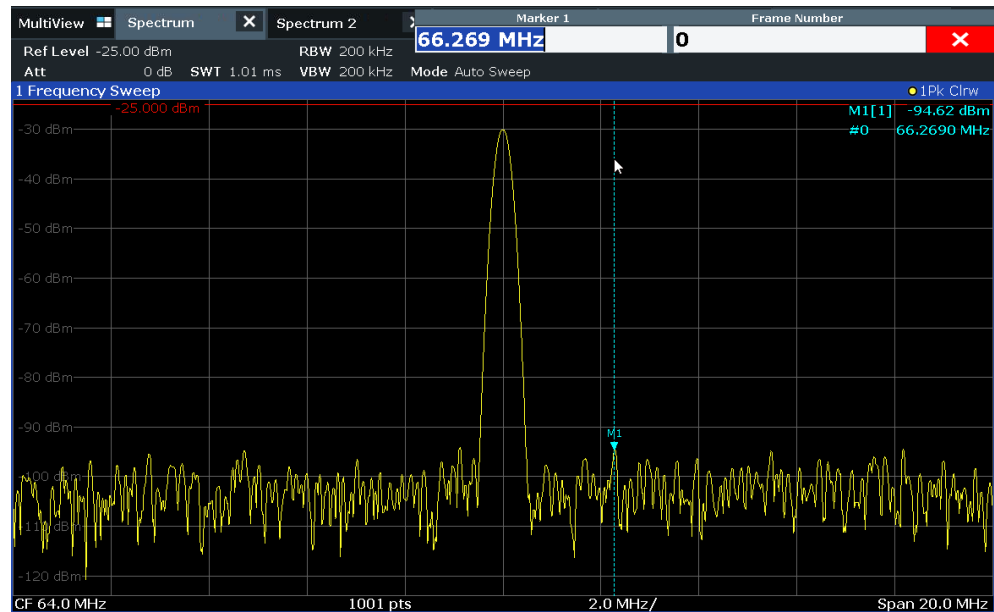

#### 4.4.6 Displaying a marker peak list

The marker peak list determines the frequencies and levels of peaks in the spectrum automatically. We will display a marker peak list for the Spectrum 2 channel.

- Tap the "Spectrum 2" tab.

- Press "RUN SINGLE" on the front panel to perform a single sweep for which we will determine the peaks.



- Tap the "SmartGrid" icon in the toolbar to activate SmartGrid mode.
- Drag the "Marker Peak List" icon from the evaluation bar to the lower half of the display to add a new window for the peak list.
- Close the SmartGrid mode.
- To obtain a more conclusive peak list that does not contain noise peaks, for example, define a threshold that is higher than the noise floor:
  - Press [MKR] on the front panel.
  - Tap "Marker Config" in the "Marker" menu.
  - Tap the "Search" tab in the "Marker" dialog box.
  - In the "Threshold" field, enter *-68 dBm*.
  - Tap the "State" box for "Threshold" to activate its use.  
Only peaks that are larger than -68 dBm will be included in the peak list.

The marker peak list displays the determined peaks that are above the defined threshold.

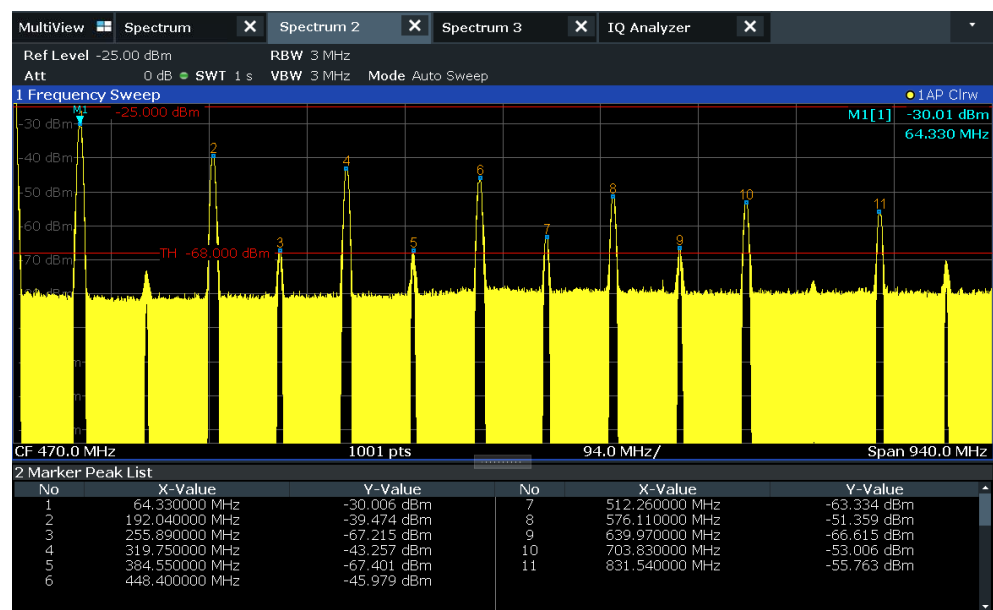

Figure 4-18: Marker Peak List

#### 4.4.7 Zooming into the display

To analyze the areas around the peak levels in more detail, we will zoom into the top 3 peaks.



1. Tap the "Multiple Zoom" icon in the toolbar.  
The icon is highlighted orange to indicate that multiple zoom mode is active.
2. Tap the diagram near the first peak and drag your finger to the opposite corner of the zoom area. A white rectangle is displayed from the point where you tapped to the current position.

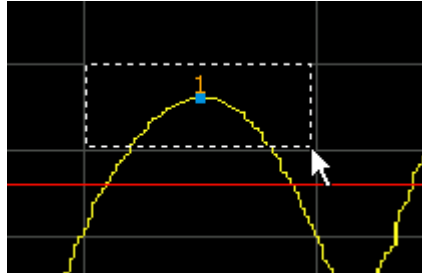

Figure 4-19: Defining the zoom area

When you remove your finger, the zoom area is enlarged in a second (sub-)window.

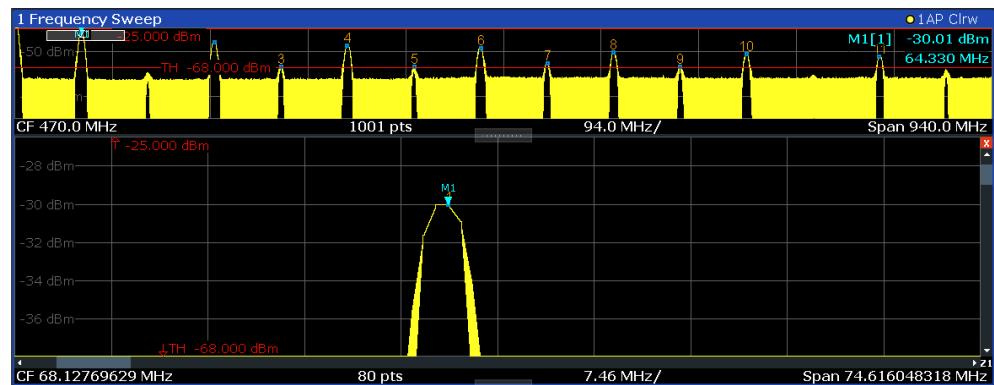

Figure 4-20: Zoomed display around a peak



3. In Figure 4-20, the enlarged peak is represented by a very thick trace. This is due to the insufficient number of sweep points. The missing sweep points for the zoomed display are interpolated, which provides poor results. To optimize the results, we will increase the number of sweep points from the default 1001 to 32001.
  - a) Press [Sweep] on the front panel.
  - b) Tap "Sweep Config" in the "Sweep" menu.
  - c) In the "Sweep Points" field, enter 32001.
  - d) Press RUN SINGLE on the front panel to perform a new sweep with the increased number of sweep points.



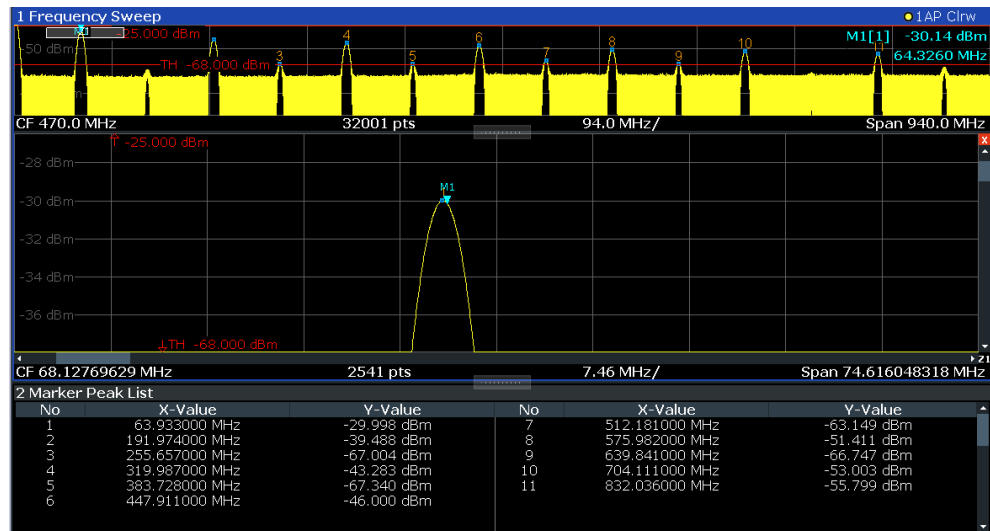

Figure 4-21: Zoomed peak with increased number of sweep points

Note that the trace becomes much more precise.



- Tap the "Multiple Zoom" icon in the toolbar again and define a zoom area around markers M4, M5 and M6.

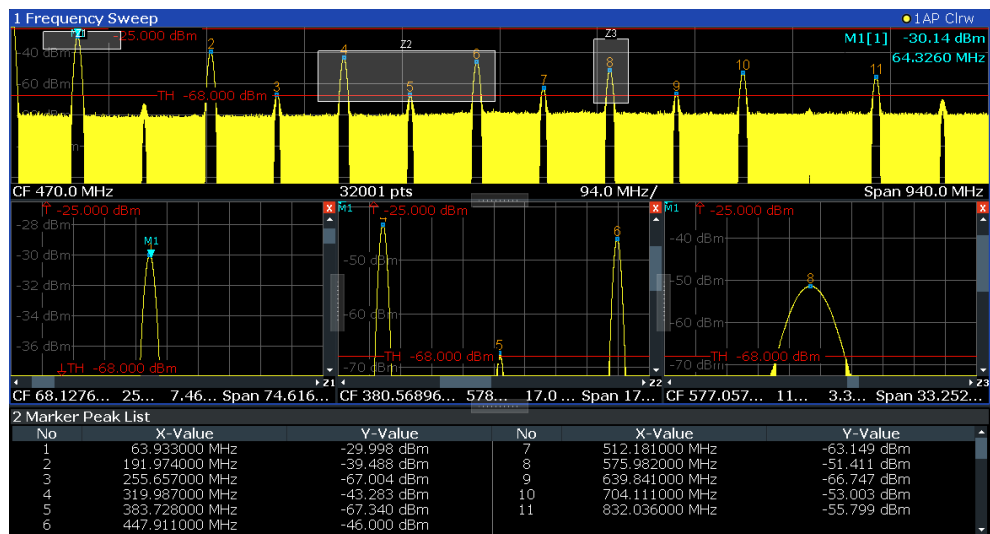

Figure 4-22: Multiple zoom windows



- Tap the "Multiple Zoom" icon in the toolbar again and define a zoom area around marker M8.
- To increase the size of the third zoom window, drag the "splitter" between the windows to the left or right or up or down.

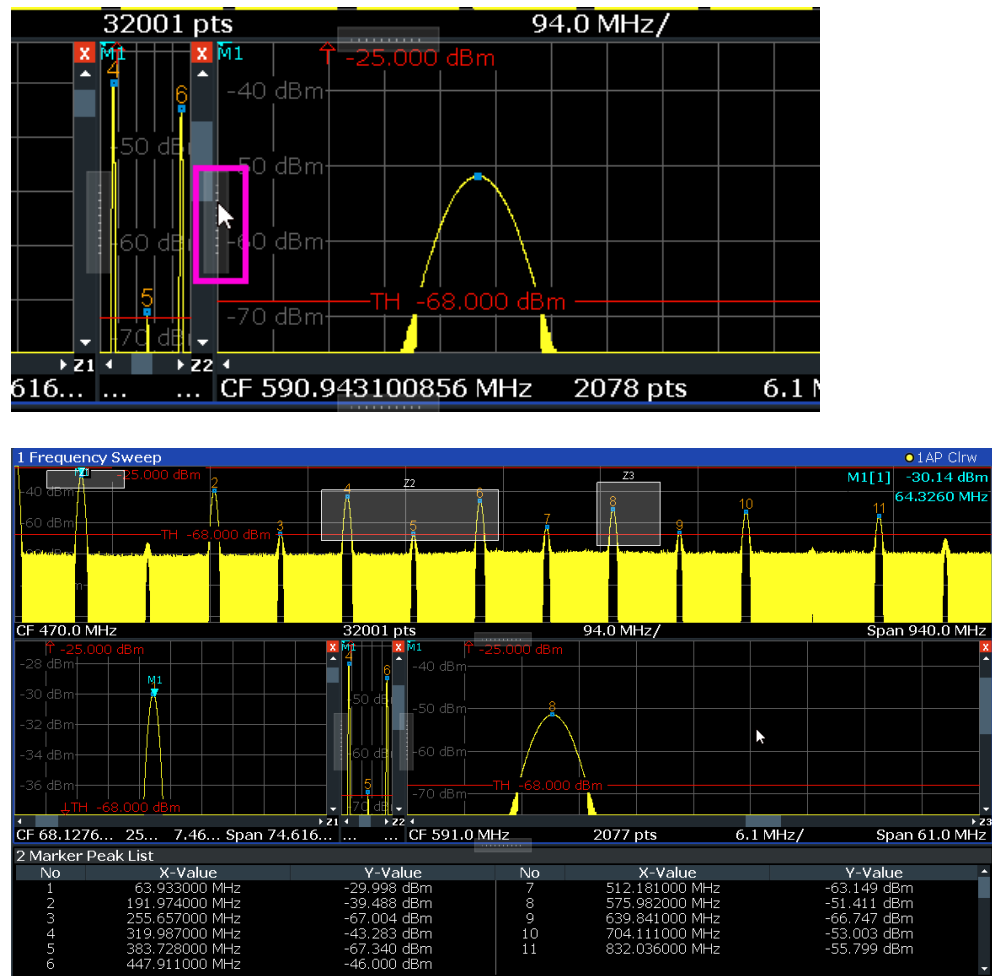

Figure 4-23: Enlarged zoom window

#### 4.4.8 Zooming into the display permanently

The zoomed results from [Chapter 4.4.7, "Zooming into the display"](#), on page 71 were only graphical changes to the display. Now we would like to change the measurement settings such that the zoomed result is maintained permanently. We will demonstrate this in the Spectrum channel.

1. Tap the "Spectrum" tab.
2. Double-tap the diagram close to the peak of the measurement.

A peak marker (M1) is inserted at the detected peak.

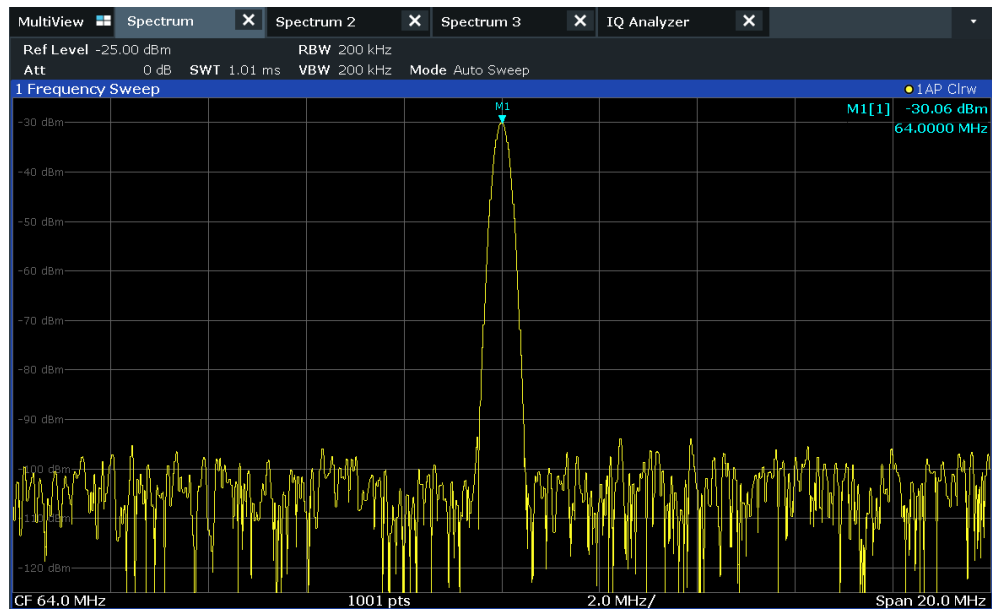

3. Select the (graphical) zoom icon on the toolbar.  
Any subsequent touch gestures define the zoom area for the zoom display.
4. Place two fingers on the diagram, to the left and right of the marker, and stretch them apart.

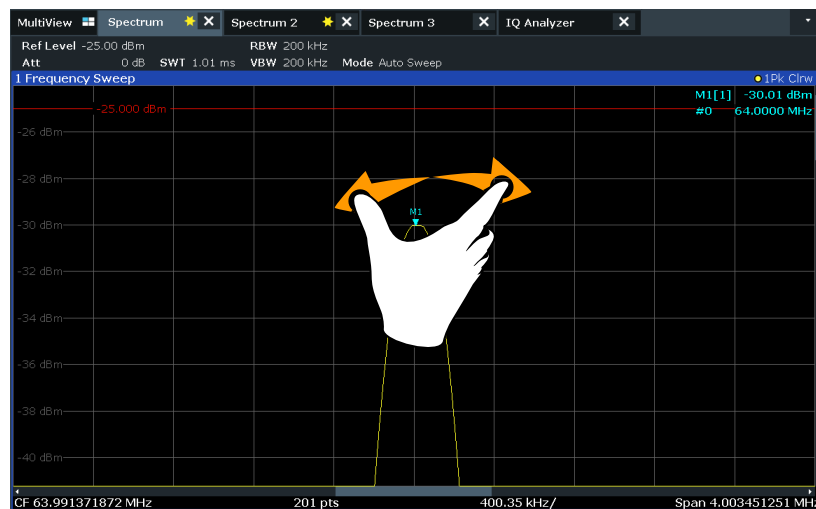

The area around the marker is enlarged in the result display.

5. When the area has the size you require, remove your fingers from the display.  
The displayed span and the number of displayed sweep points is smaller than before, all other measurement settings remain unchanged.



- Tap the "Measurement Zoom" icon on the toolbar for a second or so. A context menu with further options is displayed.
- Select "Adapt Hardware to Zoom (selected diagram)".

The span of the measurement is changed, and due to the automatic coupling of the span to the sweep time, RBW and VBW, those values are also changed. The number of sweep points is restored to the default 1001. The range of the trace is the same as in the graphical zoom. However, due to the smaller RBW filter, the peak is narrower.



#### 4.4.9 Saving settings

To restore the results of our measurements later, we will store the instrument settings to a file.

##### To save the instrument settings to a file



1. Tap the "Save" icon in the toolbar.
2. Press the keyboard key on the front panel to display the on-screen keyboard, as you will have to enter text in the next step.
3. In the "Save" dialog box, tap the "File Name" field and enter *MyMultiViewSetup* using the external or onscreen keyboard.  
Keep the default "File Type" setting "Instrument with all Channels" to store the configuration of all channels.

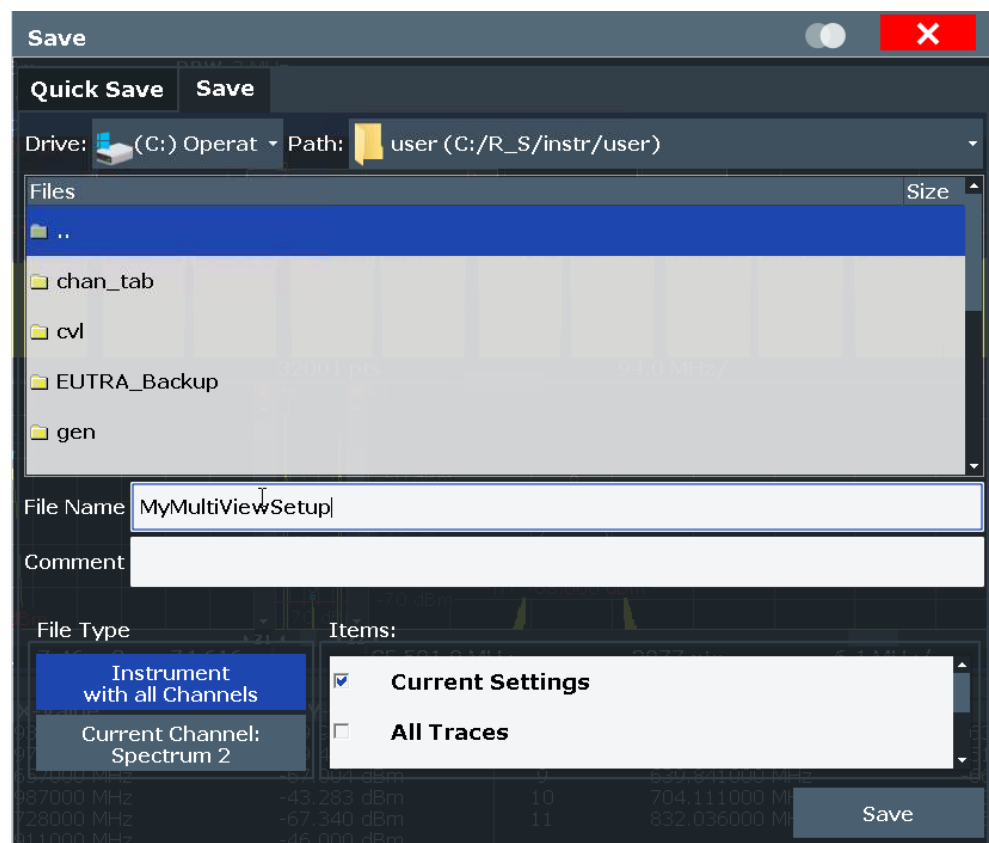

Figure 4-24: Saving the instrument settings to a file

4. Tap "Save".  
The file *MyMultiViewSetup.dfl* is stored in the default directory *C:/R\_S/instr/user*.

### To load stored instrument settings

You can restore the settings to the instrument at any time using the settings file.

1. Press [PRESET] to restore the default instrument settings so you can check that the stored user settings are actually restored afterwards.



2. Tap the "Load" icon in the toolbar.
3. In the "Load" dialog box, select the `MyMultiViewSetup.dfl` file in the default directory `C:/R_S/instr/user`.
4. Tap the "Load" button.

All instrument settings are restored and the display should resemble [Figure 4-23](#), which shows the instrument display right before the settings were stored.

## 4.4.10 Printing and saving results

Finally, after a successful measurement, we will document our results. First we will export the numeric trace data, then we will create a screenshot of the graphical display.

### To export the trace data

1. Press [TRACE] on the front panel.
2. Tap "Trace Config".
3. Tap the "Trace Export" tab.
4. Tap "Export Trace to ASCII File".
5. Enter the file name *MyPeakResults* using the external or onscreen keyboard.

The trace data is stored to `MyPeakResults.DAT`

### To create a screenshot of the display



1. Tap the "Print immediately" icon in the toolbar.  
A screenshot of the current display is created. Note that the colors on the screen are inverted in the screenshot to improve printout results.
2. In the "Save Hardcopy as Portable Network Graphics (PNG)" dialog box, enter a file name, e.g. *MyPeakDisplay*.

The screenshot is stored to `MyPeakDisplay.png`.

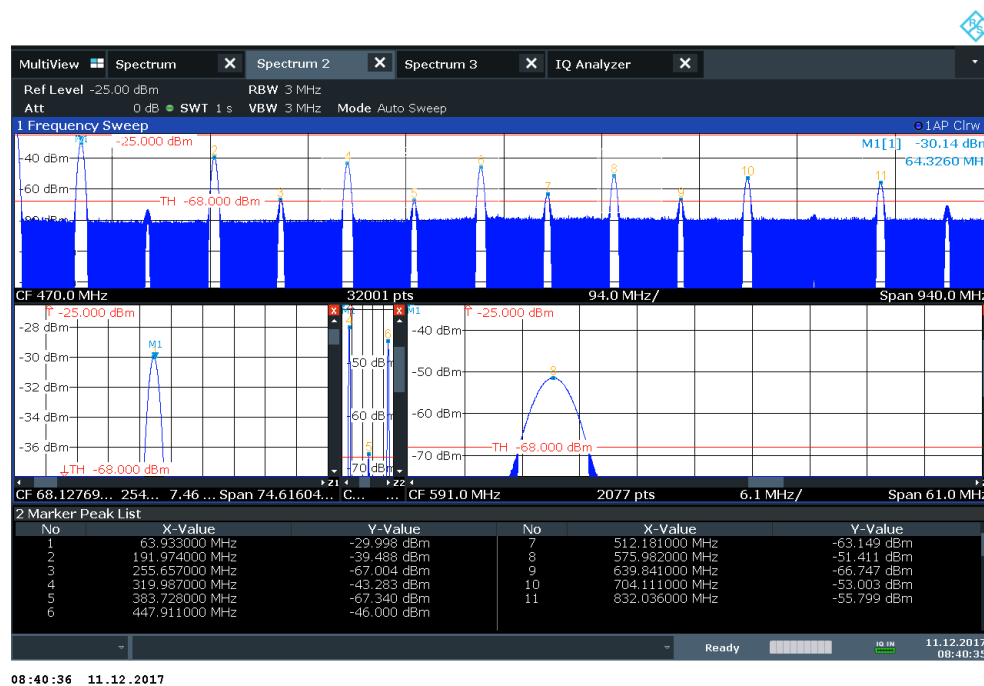

Figure 4-25: Screenshot of the current display

## 4.5 Operating the instrument

This chapter provides an overview on how to work with the FSW.



### Remote control

In addition to working with the FSW interactively, located directly at the instrument, it is also possible to operate and control it from a remote PC. Various methods for remote control are supported:

- Connecting the instrument to a (LAN) network
- Using the web browser interface in a LAN network
- Using the Windows Remote Desktop application in a LAN network
- Connecting a PC via the GPIB interface

How to configure the remote control interfaces is described in the FSW user manual.

- [Understanding the display information](#).....80
- [Accessing the functionality](#).....89
- [Changing the focus](#).....94
- [Entering data](#).....94
- [Touchscreen gestures](#).....97
- [Displaying results](#).....100
- [Getting help](#).....107

### 4.5.1 Understanding the display information

The following figure shows a measurement diagram in Spectrum mode. All different information areas are labeled. They are explained in more detail in the following sections.

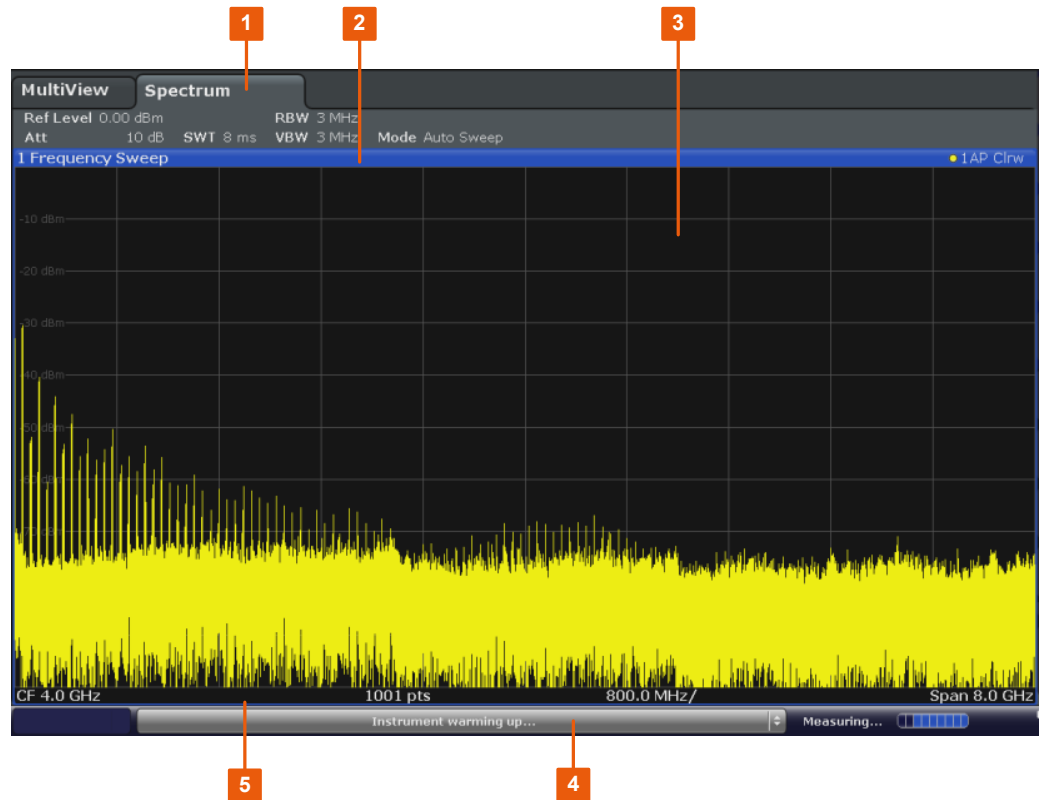

- 1 = Channel bar for firmware and measurement settings
- 2 = Window title bar with diagram-specific (trace) information
- 3 = Diagram area with marker information
- 4 = Instrument status bar with error messages, progress bar and date/time display
- 5 = Diagram footer with diagram-specific information, depending on measurement application



#### Hiding elements in the display

You can hide some of the elements in the display, for example the status bar or channel bar, to enlarge the display area for the measurement results. ("Setup > Display > Displayed Items")

For details, see the FSW User Manual.

- [Channel bar](#).....81
- [Window title bar](#).....85
- [Marker information](#)..... 86
- [Frequency and span information in diagram footer](#).....87
- [Instrument and status information](#).....87
- [Error information](#)..... 88



#### 4.5.1.1 Channel bar

Using the FSW you can handle several different measurement tasks (channels) at the same time, although they can only be performed asynchronously. For each channel, a separate tab is displayed on the screen. To switch from one channel display to another, simply select the corresponding tab.

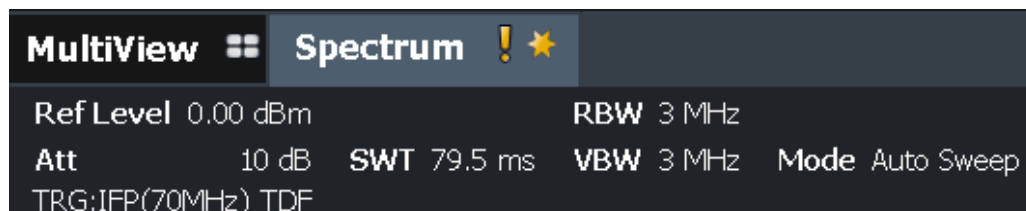

If many tabs are displayed, select the tab selection list icon at the right end of the channel bar. Select the channel you want to switch to from the list.

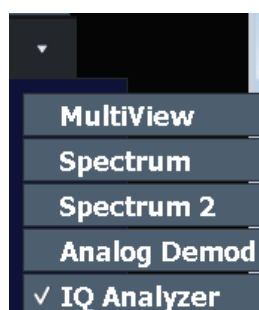



#### MultiView tab

An additional tab labeled "MultiView" provides an overview of all active channels at a glance. In the "MultiView" tab, each individual window contains its own channel bar with an additional button. Tap this button, or double-tap in any window, to switch to the corresponding channel display quickly.



#### Icons in the channel bar

The  yellow star icon on the tab label (sometimes referred to as a "dirty flag") indicates that invalid or inconsistent data is displayed, that is: the trace no longer matches the displayed instrument settings. For example, after you change the measurement bandwidth, the displayed trace is still based on the old bandwidth. As soon as a new measurement is performed or the display is updated, the icon disappears.

The  icon indicates that an error or warning is available for that measurement channel. This is particularly useful if the MultiView tab is displayed.

"IQ" in the channel tab indicates that the results for the channel no longer match the data currently in the capture buffer.

In MSRA mode, the results in an MSRA secondary application no longer match the data captured by the MSRA primary application. The "IQ" disappears after you refresh the results in the outdated application.

For applications using a long capture buffer, this icon appears if you switch channels. The icon disappears after you switch back to the application and perform a new measurement.

The  icon indicates the currently active channel during an automatic measurement sequence ("Sequencer" functionality).

### Channel-specific settings

Beneath the channel name, information on channel-specific settings for the measurement is displayed in the "channel bar". Channel information varies depending on the active application.

In the Spectrum application, the FSW shows the following settings:

**Table 4-6: Channel settings displayed in the channel bar in the Spectrum application**

"Ref Level"	Reference level
"m.+el.Att"	Mechanical and electronic RF attenuation
"SAN: Att"	Analyzer attenuation when using an (optional) external frontend
"ExtFE: Att"	External frontend attenuation when measuring external frontend input.
"Ref Offset"	Reference level offset
"SWT"	Sweep time If the sweep time does not correspond to the value for automatic coupling, a bullet is displayed in front of the field. The color of the bullet turns red if the sweep time is set below the value for automatic coupling. In addition, the UNCAL flag is shown. In this case, the sweep time must be increased. For FFT sweeps, an estimated duration for data capture <i>and processing</i> is indicated behind the sweep time in the channel bar.
"Meas Time"/"AQT"	Measurement (acquisition) time, calculated from analysis bandwidth and number of samples (for statistics measurements)
"RBW"	Resolution bandwidth that has been set. (CISPR) indicates that a CISPR bandwidth filter is being used, e.g. due to an active CISPR trace detector. For details, see <a href="#">Chapter 6.13.3.1, "Resolution bandwidth and filter types"</a> , on page 335. If the bandwidth does not correspond to the value for automatic coupling, a green bullet appears in front of the field.
"VBW"	Video bandwidth that has been set. If the bandwidth does not correspond to the value for automatic coupling, a green bullet is displayed in front of the field.
"AnBW"	Analysis bandwidth (for statistics measurements)

"Compatible"	Compatible device mode (FSP, FSU, default; default not displayed)
"Mode"	Indicates which sweep mode type is selected: <ul style="list-style-type: none"> <li>• "Auto FFT": automatically selected FFT sweep mode</li> <li>• "Auto sweep": automatically selected swept sweep mode</li> <li>• "Sweep": manually selected frequency sweep mode</li> <li>• "FFT": manually selected FFT sweep mode</li> </ul>

### Icons for individual settings

A bullet next to the setting indicates that user-defined settings are used, not automatic settings. A green bullet indicates this setting is valid and the measurement is correct. A red bullet indicates an invalid setting that does not provide useful results.

### Common settings

The channel bar above the diagram not only displays the channel-specific settings. It also displays information on instrument settings that affect the measurement results even though it is not immediately apparent from the display of the measured values. This information is displayed in gray font and only when applicable for the current measurement, as opposed to the channel-specific settings that are always displayed.

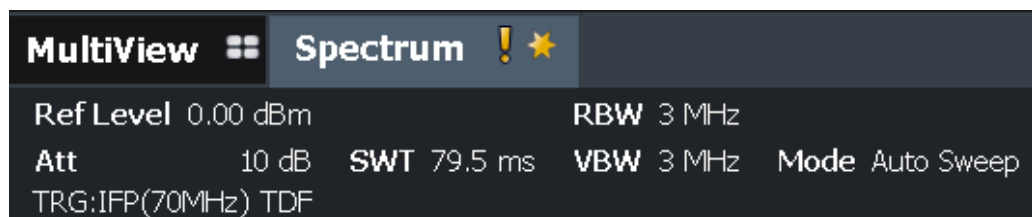

The following types of information are displayed, if applicable.

**Table 4-7: Common settings displayed in the channel bar**

"SGL"	The sweep is set to single sweep mode.
"Sweep Count"	The current signal count for measurement tasks that involve a specific number of subsequent sweeps (see "Sweep Count" setting in "Sweep settings" in the User Manual)
"TRG"	Trigger source (for details see "Trigger settings" in the User Manual) <ul style="list-style-type: none"> <li>• "BBP": Baseband power (with Digital Baseband Interface R&amp;S FSW-B17 only)</li> <li>• "EXT": External</li> <li>• "GP_0": General purpose bit (with Digital Baseband Interface R&amp;S FSW-B17 only)</li> <li>• "IFP": IF power (+trigger bandwidth)</li> <li>• "PSE": Power sensor</li> <li>• "RFP": RF power</li> <li>• "SQL": Squelch</li> <li>• "TIM": Time</li> <li>• "VID": Video</li> </ul>
"6dB"/"RRC"/"CHN"	Filter type for sweep bandwidth See " <a href="#">Filter Type</a> " on page 346
"PA"/"Ext PA"	The preamplifier is activated. / Data compensation is performed using data from the (optional) external preamplifier.
"GAT"	The frequency sweep is controlled via the TRIGGER INPUT connector.

"TDF"	The specified transducer factor is activated.
"75 Ω"	The input impedance of the instrument is set to 75 Ω.
"FRQ"	A frequency offset ≠ 0 Hz is set.
"DC/AC"	DC or AC coupling is used for the input.
"ExtMix" <band>	An external mixer is activated for input (requires option R&S FSW-B21); the used band is also indicated
"Ext. Gen" <"NOR"   "APX">	The FSW is controlling an external generator (requires option R&S FSW-B10). "NOR": the measurements are normalized with the results of the external generator calibration "APX" (approximation): the measurements are normalized with the results of the external generator calibration; however, the measurement settings have been changed since calibration If neither label is displayed, no calibration has been performed yet or normalization is not active. For details, see <a href="#">Chapter 7.2.4, "Optional external generator control"</a> , on page 375.
"Inp:ExtFe" "IF High" / "IF Low" / "Spur optimized" / "EVM opti- mized" / <IF frequency range> / "Shared LO"	An external frontend is active (requires option R&S FSW-K553); the used frequency band configuration is indicated for reference. See " <a href="#">Frequency Band Configuration</a> " on page 452.
"LO EXT"	The frontend uses an external LO signal.
"LO EXT"	The frontend uses an external LO signal.
"IFCorr"	IF cable correction for an active external frontend is enabled and a valid correction file is available.
"LVL"	A level offset is applied to the external generator signal (only if external generator control is active).
"Inp: Input 2"	For FSW85 models with two RF input connectors only: the second input connector "RF2" is the current input source for the channel
"B2000"	A connected oscilloscope is being used to acquire data with up to 2 GHz bandwidth (requires bandwidth extension option R&S FSW-B2000)
"B5000"	A connected oscilloscope is being used to acquire data with up to 5 GHz bandwidth (requires bandwidth extension option R&S FSW-B5000)

### Changing the Channel Name

The measurement channels are labeled with their default name. If that name already exists, a sequential number is added. You can change the name of the measurement channel by double-tapping the name in the channel bar and entering a new name.

For an overview of default names, see [INSTrument:LIST?](#) on page 899.

**Note:** Channel name restrictions. Channel names can have a maximum of 31 characters, and must be compatible with the Windows conventions for file names. In particular, they must not contain special characters such as ":", "\*", "?".

Remote command:

`INSTrument:REName` on page 902

#### 4.5.1.2 Window title bar

Each channel in the FSW display can contain several windows. Each window can display either a graph or a table as a result of the channel measurement. Which type of result evaluation is displayed in which window is defined in the display configuration (see [Chapter 4.5.6, "Displaying results"](#), on page 100). The window title bar indicates which type of evaluation is displayed.



Double-tap the window title bar to enlarge the window temporarily. Double-tap it again to restore the original size.

See also [Chapter 4.5.6.4, "Switching between a split and maximized window display"](#), on page 106.

#### Trace information in window title bar

Information on the displayed traces is indicated in the window title bar.



(1) Trace color		Color of trace display in diagram
(2) Trace no.		Trace number (1 to 6)
(3) Detector		Selected detector:
	AP	AUTOPEAK detector
	Pk	MAX PEAK detector
	Mi	MIN PEAK detector
	Sa	SAMPLE detector
	Av	AVERAGE detector
	Rm	RMS detector
	QP	QUASIPeAK detector
(4) Trace Mode		<b>Sweep mode:</b>
	Clrw	CLEAR/WRITE
	Max	MAX HOLD
	Min	MIN HOLD

	Avg	AVERAGE (Lin/Log/Pwr)
	View	VIEW
(5) Smoothing factor	Smth	Smoothing factor, if enabled. (See "Smoothing" on page 625)
Norm/NCor		Correction data is not used.

#### 4.5.1.3 Marker information

Marker information is provided either in the diagram grid or in a separate marker table, depending on the configuration.

##### Marker information in diagram grid

Within the diagram grid, the x-axis and y-axis positions of the last two markers or delta markers that were set are displayed, if available, as well as their index. The value in the square brackets after the index indicates the trace to which the marker is assigned. (Example: M2[1] defines marker 2 on trace 1.) For more than two markers, a separate marker table is displayed beneath the diagram by default.

##### Marker information in marker table

In addition to the marker information displayed within the diagram grid, a separate marker table may be displayed beneath the diagram. This table provides the following information for all active markers:

<b>Type</b>	Marker type: N (normal), D (delta), T (temporary, internal), PWR (power sensor)
<b>Ref</b>	Reference (for delta markers)
<b>Trc</b>	Trace to which the marker is assigned
<b>X-value</b>	X-value of the marker
<b>Y-value</b>	Y-value of the marker
<b>Func</b>	Activated marker or measurement function
<b>Func .Result</b>	Result of the active marker or measurement function

The functions are indicated with the following abbreviations:

<b>FXD</b>	Fixed reference marker
<b>PHNoise</b>	Phase noise measurement
<b>CNT</b>	Signal count
<b>TRK</b>	Signal tracking
<b>NOise</b>	Noise measurement
<b>MDepth</b>	AM modulation depth
<b>TOI</b>	Third order intercept measurement

#### 4.5.1.4 Frequency and span information in diagram footer

The information in the diagram footer (beneath the diagram) depends on the current application, measurement, and result display.

For a default measurement in the "Spectrum" mode, the "Diagram" result display contains the following information, for example:

**Table 4-8: Frequency domain display**

Label	Information
CF / Span or none (first / last value)	Center frequency / Frequency span or Start frequency / Stop frequency (Depending on how the range was defined)
Pts	Number of sweep points or (rounded) number of currently displayed points in zoom mode
MHz/	Span per division

**Table 4-9: Time domain display**

Label	Information
CF	Center frequency
Pts	Number of sweep points or (rounded) number of currently displayed points in zoom mode
ms/	Time per division

#### 4.5.1.5 Instrument and status information



Global instrument settings and functions, the instrument status and any irregularities are indicated in the status bar beneath the diagram.





In the MultiView tab, the status bar always displays the information for the currently selected measurement.

The following information is displayed:

##### Instrument status

	The instrument is configured for operation with an external reference.
	The optional Digital Baseband Interface (R&S FSW-B17) is being used for digital input For details on the Digital Baseband Interface (R&S FSW-B17), see the FSW I/Q Analyzer User Manual.

	<p>The optional Digital Baseband Interface (R&amp;S FSW-B17) is being used to provide digital output.</p> <p>For details on the Digital Baseband Interface (R&amp;S FSW-B17), see the FSW I/Q Analyzer User Manual.</p>
	<p>The optional Digital I/Q 40G Streaming Output Connector (R&amp;S FSW-B517) is being used to provide digital output.</p> <p>For details on the Digital I/Q 40G Streaming Output Connector, see the FSW I/Q Analyzer User Manual.</p>

**Progress**

The progress of the current operation is displayed in the status bar.



In the MultiView tab, the progress bar indicates the status of the currently selected measurement, not the measurement a Sequencer is currently performing, for example.

**Date and time**

The date and time settings of the instrument are displayed in the status bar.



**4.5.1.6 Error information**

If errors or irregularities are detected, a keyword and an error message, if available, are displayed in the status bar.



Depending on the type of message, the status message is indicated in varying colors.

**Table 4-10: Status bar information - color coding**

Color	Type	Description
Red	Error	An error occurred at the start or during a measurement, e.g. due to missing data or wrong settings, so that the measurement cannot be started or completed correctly.
Orange	Warning	An irregular situation occurred during measurement, e.g. the settings no longer match the displayed results, or the connection to an external device was interrupted temporarily.
Gray	Information	Information on the status of individual processing steps.
No color	No errors	No message displayed - normal operation.
Green	Measurement successful	Some applications visualize that the measurement was successful by showing a message.





If any error information is available for a channel, an exclamation mark is displayed next to the channel name (■). This is particularly useful when the MultiView tab is displayed, as the status bar in the MultiView tab always displays the information for the currently selected channel only.

For a description of possible errors, see the FSW user manual.

### 4.5.2 Accessing the functionality

You can operate all instrument functions using this user interface.

For most tasks, there are at least 2 alternative methods to perform them:

- Using the touchscreen
- Using other elements provided by the front panel, e.g. the keypad, rotary knob, or arrow and position keys.

The measurement and instrument functions and settings can be accessed by selecting one of the following elements:

- System and function keys on the front panel of the instrument
- Softkeys on the touchscreen
- Context menus for specific elements on the touchscreen
- Icons on the tool bar in the touchscreen
- Displayed setting on the touchscreen

#### 4.5.2.1 Toolbar

Standard functions can be performed via the icons in the toolbar at the top of the screen.















You can hide the toolbar display, e.g. when using remote control, to enlarge the display area for the measurement results ("Setup > Display > Displayed Items"). See the FSW User Manual for details.



The following functions are available by default:

**Table 4-11: Standard Application Functions in the Toolbar**

Icon	Description
	Windows: displays the Windows "Start" menu and task bar
	Open: opens a file from the instrument ("Save/Recall" menu)

Icon	Description
	Store: stores data on the instrument ("Save/Recall" menu)
	Print: defines print settings ("Print" menu)
	Report Menu: Displays the "Report" menu to configure a report. See <a href="#">Chapter 10.6, "Working with test reports"</a> , on page 710.
	Undo: reverts last operation
	Redo: repeats previously reverted operation
	Selection mode: the cursor can be used to select (and move) markers in a zoomed display (This function is only available and required for older instruments that do not support multi-touch gestures.)
	Measurement zoom: applies to the next display you select; Displays a dotted rectangle in the diagram that can be expanded to define the zoom area; the selected diagram is replaced by a new diagram with adapted measurement settings which displays the selected extract of the trace.  Also provides a context menu to determine the firmware behavior for touch gestures: <ul style="list-style-type: none"> <li>• "Level Lock" (Default:) The reference level (and thus the attenuation) remains unchanged during touch gestures on the screen.</li> <li>• "X-Lock" The x-axis of the diagram is not changed during subsequent touch gestures.</li> <li>• "Y-Lock" The y-axis of the diagram is not changed during subsequent touch gestures.</li> <li>• "Adapt Measurement to Zoom (selected diagram)" Automatically adapts the measurement settings to the currently zoomed display</li> </ul>
	(Graphical) Zoom mode: applies to the next display you select; Displays a dotted rectangle in the diagram that can be expanded to define the zoom area; the selected diagram is replaced by a new diagram which displays an enlarged extract of the trace.  This function changes the behavior of finger gestures such as dragging or stretching a finger (see also <a href="#">"Touch gestures in diagrams change measurement settings"</a> on page 99)
	Multiple (graphical) zoom mode: applies to the next display you select; Allows you to enlarge several different areas of the trace simultaneously.  Displays a dotted rectangle in the diagram that can be expanded to define the zoom area; a subwindow is added to display an enlarged extract of the trace  This function changes the behavior of finger gestures such as dragging or stretching a finger (see also <a href="#">"Touch gestures in diagrams change measurement settings"</a> on page 99)
	Zoom off: displays the diagram in its original size  This function only restores graphically zoomed displays. Measurement zooms, for which measurement settings were adapted, remain untouched.

Icon	Description
	Data shift: Shifts the data to be evaluated in the result display and re-evaluates the new data. Currently, this function is only available in the Transient Analysis application.
	Data zoom: Decreases the amount of data to be evaluated in the result display and re-evaluates the new data, thus enlarging the display of the remaining data. Currently, this function is only available in the Transient Analysis application.
	SmartGrid: activates "SmartGrid" mode to configure the screen layout
	Sequencer: opens the "Sequencer" menu to perform consecutive measurements
	SCPI Recorder: opens a dialog to record SCPI commands during operation
	Event based actions manager: opens a dialog to configure actions based on specific events For details see <a href="#">Chapter 8.7, "Event-based actions"</a> , on page 660.
	Application starter: opens a dialog to start an external application directly from the FSW firmware. For details see <a href="#">Chapter 11.3, "Application starter"</a> , on page 749. To return to the FSW window, use the [Alt]+[Tab] keys.
	Help (+ Select): allows you to select an object for which context-specific help is displayed
	Help: displays context-sensitive help topic for currently selected element
	Report New: Deletes all currently stored datasets and creates a new one. See <a href="#">Chapter 10.6, "Working with test reports"</a> , on page 710.
	Report Append: Adds a new dataset to the existing ones for the next test report. See <a href="#">Chapter 10.6, "Working with test reports"</a> , on page 710.
	Print immediately: prints the current display (screenshot) as configured
In "SmartGrid" mode only:	
	Exit "SmartGrid" mode

#### 4.5.2.2 Softkeys

Softkeys are virtual keys provided by the software. Thus, more functions can be provided than those that can be accessed directly via the function keys on the instrument.

Softkeys are dynamic, i.e. depending on the selected function key, a different list of softkeys is displayed on the right side of the screen.

A list of softkeys for a certain function key is also called a menu. Softkeys can either perform a specific function or open a dialog box.

The "More" softkey indicates that the menu contains more softkeys than can be displayed at once on the screen. When pressed, it displays the next set of softkeys.

### Recognizing the softkey status by color

Color	Meaning
Orange	Associated dialog box is open
Blue	Associated function is active; for toggle keys: currently active state
Gray	Instrument function is temporarily not available due to a specific setting or missing option



You can hide the softkey display, e.g. when using remote control, to enlarge the display area for the measurement results ("Setup > Display > Displayed Items"). See the User Manual for details.

#### 4.5.2.3 Context menus

Several items in the diagram area have context menus, such as traces, markers, softkeys, or settings in the channel bar. If you right-click on one of these items (or tap it for about 1 second), a menu is displayed with context-specific menu items for the selected item.

If SCPI Recording is available, the context menu contains a link to the SCPI recorder functions and a link to a help topic for the specific item.

For details, see [Chapter 12.5.1, "The context-sensitive SCPI command menu"](#), on page 839.

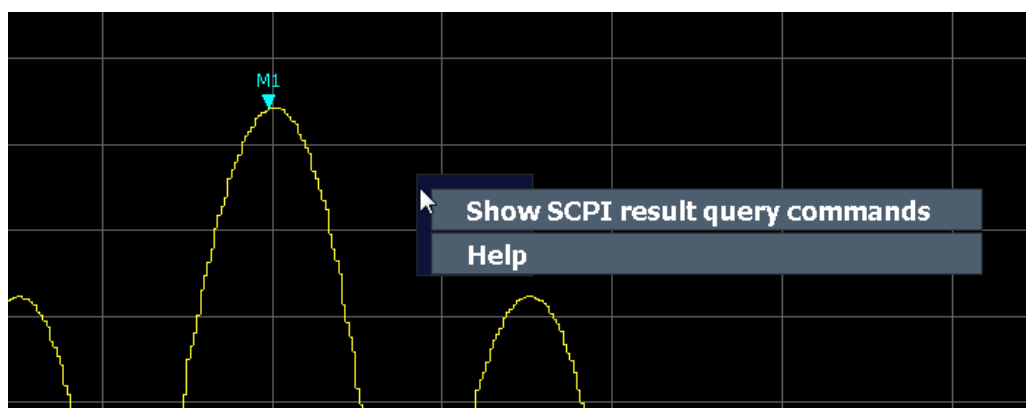

Figure 4-26: Context menu for a result display with SCPI Recorder functions

If SCPI Recorder functions are not available, for example for channel bar settings or in some applications, the context menu contains functions for the selected item. These

functions correspond to the functions also provided for the item in softkey menus. This is useful, for example, when the softkey display is hidden.

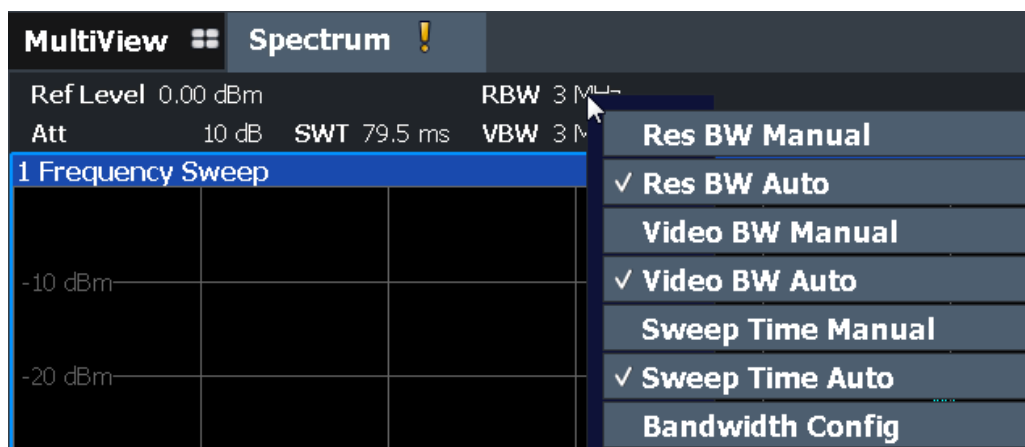
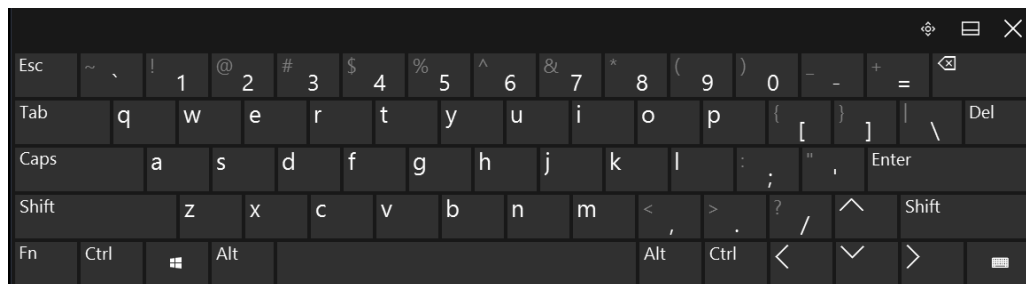

Figure 4-27: Context menu for channel bar setting

#### 4.5.2.4 On-screen keyboard

The on-screen keyboard is an additional means of interacting with the instrument without having to connect an external keyboard.



The on-screen keyboard display can be switched on and off as desired using the "On-Screen Keyboard" function key beneath the screen.



When you press this key, the display switches between the following options:

- Keyboard displayed at the top of the screen
- Keyboard displayed at the bottom of the screen
- No keyboard displayed



You can use the TAB key on the on-screen keyboard to move the focus from one field to another in dialog boxes.

### 4.5.3 Changing the focus

Any interaction using the keypad, scrollbar or knobs always affects the currently focused element in the display, e.g. a dialog field, diagram, or table row. The currently focused element is indicated by a blue frame (diagram, window, table) or is otherwise highlighted (softkey, marker etc.). To move the focus, select the element on the touchscreen.



To move the focus between any displayed diagrams or tables in a window, press "Change focus" on the front panel. The focus moves from the diagram to the first table to the next table etc. and then back to the diagram, within the same window.

In fullscreen mode, where a single window is displayed in full size on the screen, this key switches the focus (and the display) from one active window to the next.

### 4.5.4 Entering data

You can enter data in dialog boxes using any of the following methods:

- Using the touchscreen, via the on-screen keyboard
- Using other elements provided by the front panel, e.g. the keypad, rotary knob, or navigation keys  
The rotary knob acts like the [ENTER] key when it is pressed.
- Using a connected external keyboard



#### Transparent dialog boxes

You can change the transparency of the dialog boxes to see the results in the windows behind the dialog box. Thus, you can see the effects that the changes you make to the settings have on the results immediately.

To change the transparency, select the transparency icon at the top of the dialog box. A slider is displayed. To hide the slider, select the transparency icon again.



(The title bar of the dialog box is always slightly transparent and is not affected by the slider.)



#### Particularities in Windows dialog boxes

In some cases, e.g. if you want to install a printer, original Windows dialog boxes are used. In these dialog boxes, the rotary knob and function keys do not work. Use the touchscreen instead.

#### 4.5.4.1 Entering numeric parameters

If a field requires numeric input, the keypad provides only numbers.

1. Enter the parameter value using the keypad, or change the currently used parameter value by using the rotary knob (small steps) or the [UP] or [DOWN] keys (large steps).
2. After entering the numeric value via keypad, press the corresponding unit key. The unit is added to the entry.
3. If the parameter does not require a unit, confirm the entered value by pressing [ENTER] or any of the unit keys. The editing line is highlighted to confirm the entry.

### Digit-based data entry

By default, when you enter a numeric value in an input field, you overwrite the existing value. If you edit the value using the arrow keys or rotary knob, the value is increased or decreased linearly. An extended digit-based data entry mode allows you to edit individual digits and change the unit quickly.



1. In the input field for a numeric value, select the pencil icon to switch to extended data entry mode.
2. Use the left and right arrow keys to scroll through the individual digits of the indicated value.
3. Change the required digit using the up and down arrow keys or the rotary knob to scroll through the values 0 to 9.  
The new value is applied immediately, without further confirmation.

#### Note:

- If you enter a digit using the keypad, the entire value is overwritten, as in normal data entry mode.
- To add a digit to the existing value, you must return to normal data entry mode. Select the pencil icon to toggle between entry modes.

4. To change the unit:
  - a) Press the right arrow key and scroll past the last digit to select the unit list.
  - b) Use the up and down arrow keys to scroll through the available units.
  - c) Press the left arrow key to return to the last digit of the numeric value.  
The new unit is applied immediately, without further confirmation.



5. Select the "X" to close the input field.

#### 4.5.4.2 Entering alphanumeric parameters

If a field requires alphanumeric input, you can use the on-screen keyboard to enter numbers and (special) characters (see [Chapter 4.5.2.4, "On-screen keyboard"](#), on page 93).

Alternatively, you can use the keypad. Every alphanumeric key represents several characters and one number. The decimal point key (.) represents special characters, and the sign key (-) toggles between capital and small letters. For the assignment, refer to [Table 4-12](#).



You can change the default behavior of the keypad for text input. This is useful if you frequently enter numeric values in text fields, for example to define file names consisting of numbers.

For details, see "[Number block behavior](#)" on page 793.

### To enter numbers and (special) characters via the keypad

1. Press the key once to enter the first possible value.
2. All characters available via this key are displayed.
3. To choose another value provided by this key, press the key again, until your desired value is displayed.
4. With every key stroke, the next possible value of this key is displayed. If all possible values have been displayed, the series starts with the first value again. For information on the series, refer to [Table 4-12](#).
5. To change from capital to small letters and vice versa, press the sign key (-).
6. When you have chosen the desired value, wait for 2 seconds (to use the same key again), or start the next entry by pressing another key.

### To enter a blank

- ▶ Press the "Space" bar, or press "0" and wait 2 seconds.

### To correct an entry

1. Using the arrow keys, move the cursor to the right of the entry you want to delete.
2. Press [BACKSPACE].  
The entry to the left of the cursor is deleted.
3. Enter your correction.

### To complete the entry

- ▶ Press [ENTER] or the rotary knob.

### To abort the entry

- ▶ Press [ESC].  
The dialog box is closed without changing the settings.



Table 4-12: Keys for alphanumeric parameters

Key name (upper inscription)	Series of (special) characters and number provided
7	7 μ Ω ° € ¥ \$ ¢
8	A B C 8 Ä Æ Å Ç
9	D E F 9 É
4	G H I 4
5	J K L 5
6	M N O 6 Ñ Ö
1	P Q R S 1
2	T U V 2 Ü
3	W X Y Z 3
0	<blank> 0 – @ + / \ < > = % &
.	. * : _ , ; " ' ? ( ) #
–	<toggles between capital and small letters>

### 4.5.5 Touchscreen gestures

A touchscreen allows you to interact with the software using various finger gestures on the screen. The basic gestures supported by the software and most applications are described here. Further actions using the same gestures may be possible.



#### Tapping

Touch the screen quickly, usually on a specific element.

You can tap most elements on the screen; in particular, any elements you can also click on with a mouse pointer.

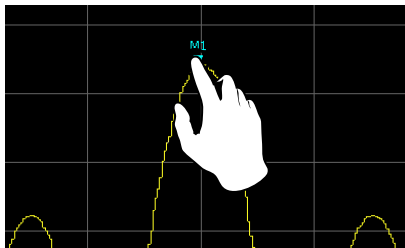
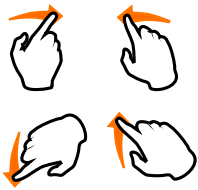

Figure 4-28: Tapping

#### Double-tapping

Tap the screen twice, in quick succession.

Double-tap a diagram or the window title bar to maximize a window in the display, or to restore the original size.



**Dragging**

Move your finger from one position to another on the display, keeping your finger on the display the whole time.

By dragging your finger over a table or diagram you can pan the displayed area of the table or diagram to show results that were previously out of view.

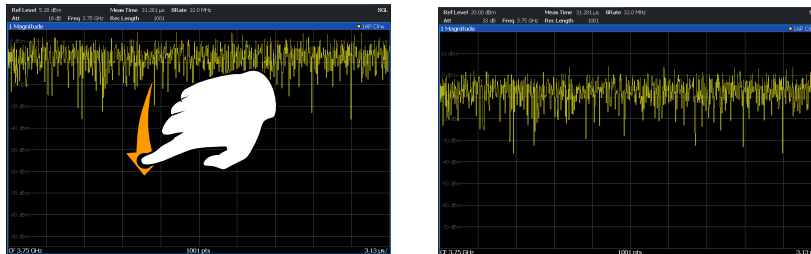

*Figure 4-29: Dragging*

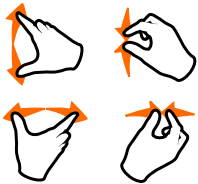

**Pinching and spreading two fingers**

Move two fingers together on the display (pinch) or move two fingers apart on the display (spread).

When you pinch two fingers in the display, you decrease the size of the currently displayed area, showing the surrounding areas previously out of view.

When you spread two fingers in the display, you increase the size of the currently displayed area, showing more details.

You can pinch or spread your fingers vertically, horizontally, or diagonally. The direction in which you move your fingers determines which dimension of the display is changed.

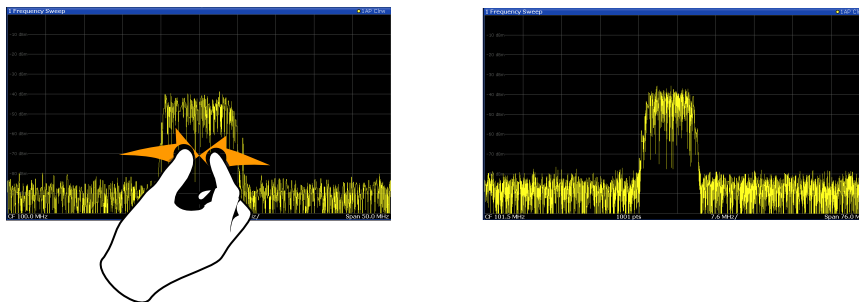

*Figure 4-30: Pinching*

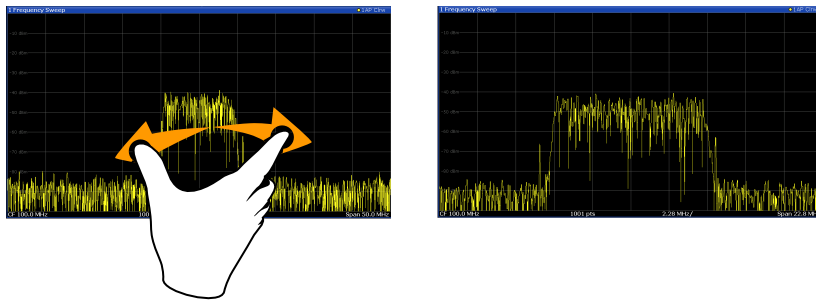

Figure 4-31: Spreading



### Touch gestures in diagrams change measurement settings

When you change the display using touch gestures, the corresponding measurement settings are adapted. This is different to selecting an area on the screen in zoom mode, where merely the resolution of the displayed trace points is changed temporarily (graphical zoom).

For example:

- Dragging horizontally in a spectrum display changes the center frequency.
- Dragging vertically in a power vs frequency (spectrum) or power vs. time display changes the reference level (for absolute scaling) or the min and max power values (for relative scaling).
- Dragging horizontally in a time domain display changes the trigger offset value (if available, not in free run).
- Spreading or pinching a spectrum display changes the center frequency and span (horizontal) or reference level and range (vertical), or a combination of these settings (diagonal).
- Spreading or pinching a time domain display changes the sweep time and trigger offset (horizontal) or reference level position and range (vertical), or a combination of these settings (diagonal).

You can prevent the firmware from changing specific settings using the options in the context menu for the measurement zoom icon. By default, the reference level is locked and thus not changed automatically due to touch gestures.

(See "[Measurement Zoom](#)" on page 543).

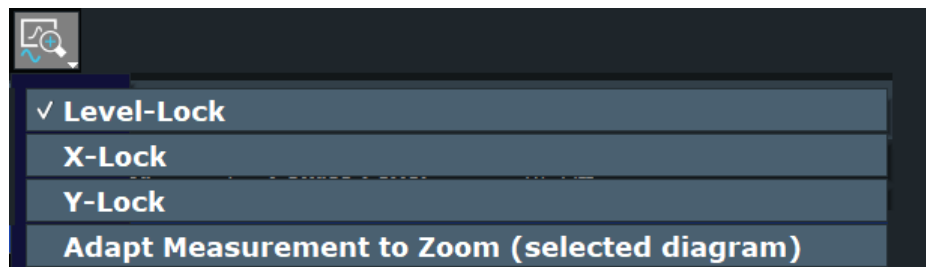

### Mouse vs. touch actions

Any user interface elements that react to actions by a mouse pointer also react to finger gestures on the screen, and vice versa. The following touch actions correspond to mouse actions:

**Table 4-13: Correlation of mouse and touch actions**

Mouse operation	Touch operation
Click	Tap
Double-click	Double-tap
Click and hold	Touch and hold
Right-click	Touch, hold for 1 second and release
Drag-&-drop (= click and hold, then drag and release)	Touch, then drag and release
n.a. (Change hardware settings)	Spread and pinch two fingers
Mouse wheel to scroll up or down	Swipe
Dragging scrollbars to scroll up or down, left or right	Swipe
In (graphical) Zoom mode only: dragging the borders of the displayed rectangle to change its size	Touch, then drag and release

#### Example:

You can scroll through a long table in conventional mouse operation by clicking in the table's scrollbar repeatedly. In touch operation, you would scroll through the table by dragging the table up and down with your finger.

## 4.5.6 Displaying results

The FSW provides several instrument applications for different analysis tasks and different types of signals, e.g. 3G FDD, I/Q analysis or basic spectrum analysis. For each application, a new measurement channel is created and displayed in a separate tab on the screen.

The results of a measurement channel can be evaluated in many different ways, both graphically and numerically. For each evaluation method the results are displayed in a separate window in the tab.

The FSW allows you to configure the display to suit your specific requirements and optimize analysis.

### 4.5.6.1 Activating and deactivating channels

When you activate an application, a new measurement channel is created which determines the measurement settings for that application. The same application can be activated with different measurement settings by creating several channels for the same

application. Whenever you switch channels, the corresponding measurement settings are restored. Each channel is displayed in a separate tab on the screen.

An additional tab ("MultiView") provides an overview of all currently active channels at once.

Only one measurement can be performed at any time, namely the one in the currently active channel. However, in order to perform the configured measurements consecutively, a Sequencer function is provided.

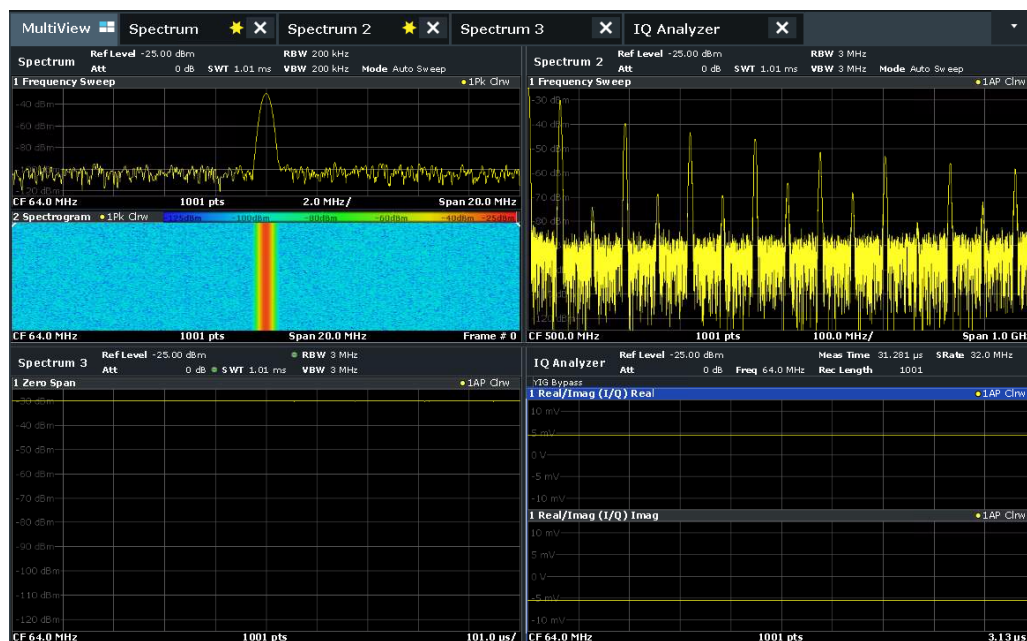

### To start a new channel

1. Select [Mode].
2. In the "Mode" dialog box, select the required application on the "New Channel" tab. A new tab is displayed for the new channel.

### Remote command:

[INSTrument:CREate\[:NEW\]](#) on page 898/ [INSTrument:CREate:DUPLicate](#) on page 898

### To change the application in an active channel

1. Select the tab of the channel you want to change.
2. Select [Mode].
3. In the "Mode" dialog box, select the new application to be displayed on the "Replace Current Channel" tab. The selected application is displayed in the current channel.

**Remote command:**

[INSTRUMENT:CREate:REPLace](#) on page 899

**To close a measurement channel**

Select the "Close" icon on the tab of the measurement channel.

The tab is closed, any running measurements are aborted, and all results for that channel are deleted.

**Remote command:**

[INSTRUMENT:DELeTe](#) on page 899

**4.5.6.2 Laying out the result display with the smartgrid**

Measurement results can be evaluated in many different ways, for example graphically, as summary tables, statistical evaluations etc. Each type of evaluation is displayed in a separate window in the channel tab. Up to 16 individual windows can be displayed per channel (i.e. per tab). To arrange the diagrams and tables on the screen, the Rohde & Schwarz SmartGrid function helps you find the target position simply and quickly.

Principally, the layout of the windows on the screen is based on an underlying grid, the SmartGrid. However, the SmartGrid is dynamic and flexible, allowing for many different layout possibilities. The SmartGrid functionality provides the following basic features:

- Windows can be arranged in columns or in rows, or in a combination of both.
  - Windows can be arranged in up to four rows and four columns.
  - Windows are moved simply by dragging them to a new position on the screen, possibly changing the layout of the other windows, as well.
  - All evaluation methods available for the currently selected measurement are displayed as icons in the evaluation bar. If the evaluation bar contains more icons than can be displayed at once on the screen, it can be scrolled vertically. The same evaluation method can be displayed in multiple windows simultaneously.
  - New windows are added by dragging an evaluation icon from the evaluation bar to the screen. The position of each new window depends on where you drop the evaluation icon in relation to the existing windows.
  - All display configuration actions are only possible in SmartGrid mode. When SmartGrid mode is activated, the evaluation bar replaces the current softkey menu display. When the SmartGrid mode is deactivated again, the previous softkey menu display is restored.
- [Background information: the smartgrid principle](#)..... 103
  - [How to activate smartgrid mode](#)..... 104
  - [How to add a new result window](#)..... 104
  - [How to close a result window](#)..... 105
  - [How to arrange the result windows](#)..... 105

## Background information: the smartgrid principle

### SmartGrid display

During any positioning action, the underlying SmartGrid is displayed. Different colors and frames indicate the possible new positions. The position in the SmartGrid where you drop the window determines its position on the screen.

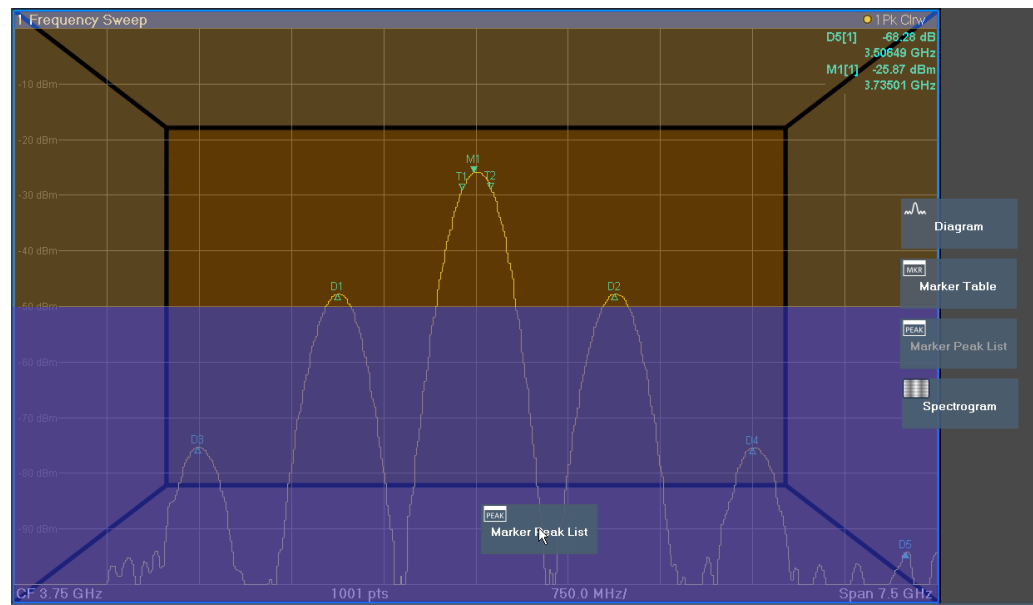
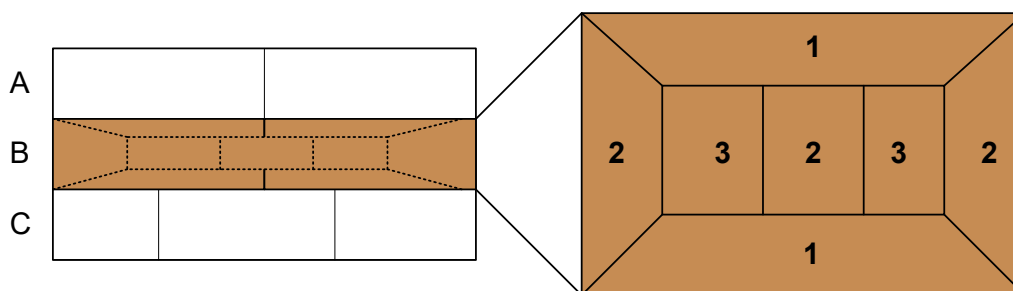

Figure 4-32: Moving a window in SmartGrid mode

The brown area indicates the possible "drop area" for the window, i.e. the area in which the window can be placed. A blue area indicates the (approximate) layout of the window as it would be if the icon were dropped at the current position. The frames indicate the possible destinations of the new window with respect to the existing windows: above/below, right/left or replacement (as illustrated in Figure 4-33). If an existing window would be replaced, the drop area is highlighted in a darker color shade.

### Positioning the window

The screen can be divided into up to four rows. Each row can be split into up to four columns, where each row can have a different number of columns. However, rows always span the entire width of the screen and may not be interrupted by a column. A single row is available as the drop area for the window in the SmartGrid. The row can be split into columns, or a new row can be inserted above or below the existing row (if the maximum of 4 has not yet been reached).



**Figure 4-33: SmartGrid window positions**

- 1 = Insert row above or below the existing row
- 2 = Create a new column in the existing row
- 3 = Replace a window in the existing row

### SmartGrid functions

Once the evaluation icon has been dropped, icons in each window provide delete and move functions.



The "Move" icon allows you to move the position of the window, possibly changing the size and position of the other displayed windows.



The "Delete" icon allows you to close the window, enlarging the display of the remaining windows.

### How to activate smartgrid mode

All display configuration actions are only possible in SmartGrid mode. In SmartGrid mode the evaluation bar replaces the current softkey menu display. When the SmartGrid mode is deactivated again, the previous softkey menu display is restored.

- ▶ To activate SmartGrid mode, do one of the following:



Select the "SmartGrid" icon from the toolbar.

- Select "Display Config" in the configuration "Overview".
- Select "Display Config" from the [Meas Config] menu.

The SmartGrid functions and the evaluation bar are displayed.



To close the SmartGrid mode and restore the previous softkey menu, select the "Close" icon, or press any key.

### How to add a new result window

Each type of evaluation is displayed in a separate window. Up to 16 individual windows can be displayed per channel (i.e. per tab).



1. Activate SmartGrid mode.  
All evaluation methods available for the currently selected measurement are displayed as icons in the evaluation bar.
2. Select the icon for the required evaluation method from the evaluation bar.  
If the evaluation bar contains more icons than can be displayed at once on the screen, it can be scrolled vertically. Touch the evaluation bar between the icons and move it up or down until the required icon appears.
3. Drag the required icon from the evaluation bar to the SmartGrid, which is displayed in the diagram area, and drop it at the required position. (See "[How to arrange the result windows](#)" on page 105 for more information on positioning the window).

**Remote command:**

[LAYout:ADD\[:WINDow\]?](#) on page 1100 / [LAYout:WINDow<n>:ADD?](#) on page 1104

**How to close a result window**

- ▶ To close a window, activate SmartGrid mode and select the "Delete" icon for the window.

**Remote command:**

[LAYout:REMOve\[:WINDow\]](#) on page 1102 / [LAYout:WINDow<n>:REMOve](#) on page 1105

**How to arrange the result windows**

1. Select an icon from the evaluation bar or the "Move" icon for an existing evaluation window.



2. Drag the evaluation over the SmartGrid.  
A blue area shows where the window will be placed.
3. Move the window until a suitable area is indicated in blue.
4. Drop the window in the target area.  
The windows are rearranged to the selected layout, and "Delete" and "Move" icons are displayed in each window.
5. To close a window, select the corresponding "Delete" icon.



#### Remote command:

`LAYout:REPLace[:WINDow]` on page 1102 / `LAYout:WINDow<n>:REPLace` on page 1105

`LAYout:MOVE[:WINDow]` on page 1102

#### 4.5.6.3 Changing the size of windows

Each channel tab may contain several windows to evaluate the measurement results using different methods. A "splitter" allows you to change the size of neighboring windows.

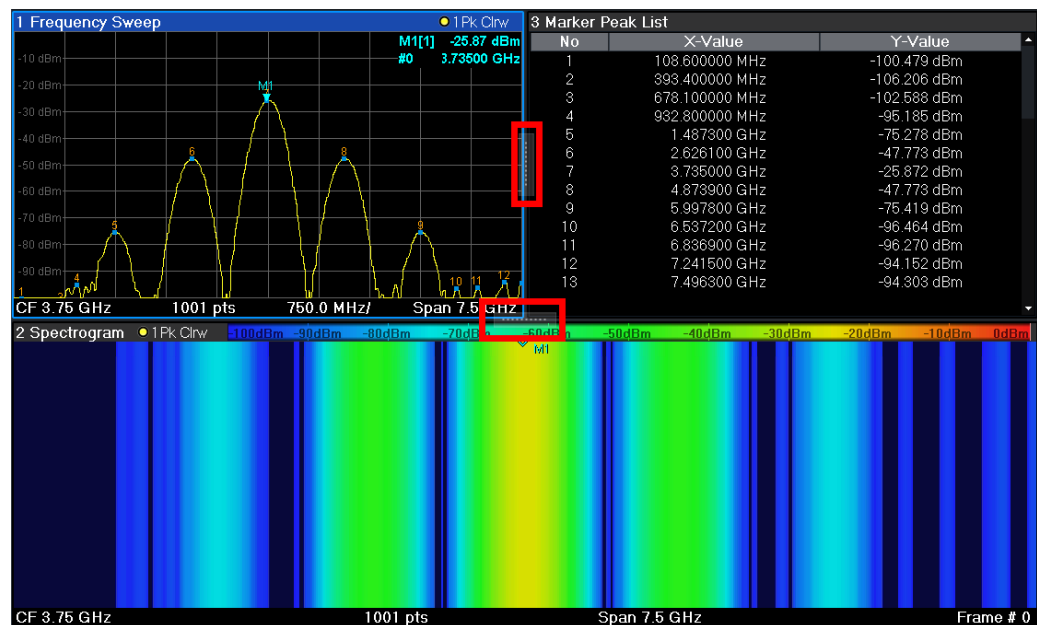

The splitters are not available in SmartGrid mode.

- To change the size of two neighboring windows, drag the splitter between the windows in either direction.

#### 4.5.6.4 Switching between a split and maximized window display

To get an overview of the results, displaying several windows at the same time may be helpful. However, the individual windows may become rather small. In this case it is useful to maximize an individual window to the entire screen temporarily in order to analyze the results in more detail.



To switch between a split and a maximized display without having to close and re-open windows, press [SPLIT/MAXIMIZE] on the front panel. In maximized display, the currently focused window is maximized. In split display, all active windows are displayed.

Alternatively, double-tap the title bar of a window to maximize it.

#### 4.5.6.5 Changing the display

The display can be optimized for your individual needs. The following display functions are available and are described in detail in [Chapter 11.2, "Display settings"](#), on page 734 and [Chapter 8, "Common analysis and display functions"](#), on page 534.

- Displaying a simulation of the entire front panel of the instrument on the screen ("Front Panel")
- Displaying the main function hardkeys in a separate window on the screen ("Mini Front Panel")
- Hiding or showing various screen elements
- Selecting a display theme and colors
- Changing the display update rate
- Activating or deactivating the touch-sensitivity of the screen
- Zooming into the diagram

#### 4.5.7 Getting help

If any questions or problems concerning the FSW arise, an extensive online help system is provided on the instrument and can be consulted at any time. The help system is context-sensitive and provides information specifically for the current operation or setting to be performed. In addition, general topics provide an overview on complete tasks or function groups as well as background information.

The online help can be opened at any time by selecting one of the "Help" icons on the toolbar or by pressing [F1] on an external or the on-screen keyboard.

##### To call context-sensitive help

- ▶ To display the "Help" dialog box for the currently focused screen element, e.g. a softkey or a setting in an opened dialog box, select the "Help" icon on the toolbar.



The "Help" dialog box "View" tab is displayed. A topic containing information about the focused screen element is displayed.

If no context-specific help topic is available, a more general topic or the "Content" tab is displayed.



For standard Windows dialog boxes (e.g. File Properties, Print dialog etc.), no context-sensitive help is available.

**To display a help topic for a screen element not currently focused**

1. Select the "Help pointer" icon on the toolbar.



The pointer changes its shape to a "?" and an arrow.

2. Select the screen element to change the focus.

A topic containing information about the selected (now focused) screen element is displayed.

## 5 Applications, measurement channels, and operating modes

The FSW allows you to perform all sorts of different analysis tasks on different types of signals, e.g. W-CDMA, I/Q analysis or basic spectrum analysis. Depending on the task or type of signal, a different set of measurement functions and parameters are required. Therefore, the FSW provides various applications - some of which are included in the base unit, others are optional. The default application when you start the FSW is "Spectrum", for basic spectrum analysis measurements on any type of signal.

For each application, a separate measurement channel is created, which determines the measurement settings for that application. The same application can be activated with different measurement settings by creating several channels for the same application. Each channel is displayed in a separate tab on the screen.



The maximum number of measurement channels may be limited by the available memory on the instrument.

### Measurements

Depending on the task, the application can provide different measurement functions. The measurement function determines which settings, functions and evaluation methods are available in the FSW. Only one measurement can be performed at the same time within the same application instance. You select the measurement for an application via the [MEAS] key.

In the Spectrum application, for example, the FSW provides a variety of different measurement functions, including:

- Frequency sweep or zero span measurement
- **Basic measurements** - measure the spectrum of your signal or watch your signal in time domain
- **Power measurements** - calculate the powers involved in modulated carrier signals
- **Emission measurements** - detect unwanted signal emission
- **Statistic measurements** - evaluate the spectral distribution of the signal
- **Further measurements** - provide characteristic values of the signal
- **EMI measurements** - detect electromagnetic interference in the signal

The individual functions are described in detail in [Chapter 6, "Measurements and results"](#), on page 127.

### Operating modes

By default, each application operates independently of the others, measuring and analyzing its own distinct data. However, the FSW also provides other operating modes, in which the individual applications are correlated and analyze the same set of data.

### Signal and Spectrum Analyzer Mode

With the **conventional FSW Signal and Spectrum Analyzer** mode, you can perform several different measurements almost simultaneously. However, the individual measurements are independent of each other - **each application captures and evaluates its own set of data**, regardless of what the other applications do.

In some cases it may be useful to **analyze the exact same input data using different applications**. For example, imagine capturing data from a base station and analyzing the RF spectrum in the Analog Demodulation application. If a spur or an unexpected peak occurs, you may want to analyze the same data in the I/Q Analyzer to see the real and imaginary components of the signal and thus detect the reason for the irregular signal. Normally when you switch to a different application, evaluation is performed on the data that was captured by that application, and not the previous one. In our example that would mean the irregular signal would be lost. Therefore, a second operating mode is available in the FSW: Multi-Standard Radio Analyzer (MSRA) mode.

### Multi-Standard Radio Analyzer mode

In **Multi-Standard Radio Analyzer (MSRA) mode**, data acquisition is performed once as an I/Q measurement in a primary application, and the captured data is then evaluated by any number of secondary applications for different radio standards. Data acquisition and global configuration settings are controlled globally, while the evaluation and display settings can be configured individually for each secondary application. Using the Multi-Standard Radio Analyzer, unwanted correlations between different signal components using different transmission standards can be detected. Thus, for example, an irregularity in a GSM burst can be examined closer in the FSW 3G FDD BTS (W-CDMA) secondary application to reveal dependencies like a change in the EVM value.

### Multi-Standard Real-Time mode

In order to combine the advantages of the MSRA mode with its correlated measurements and the gapless results and frequency mask provided by real-time measurements, a third operating mode has been introduced: the **Multi-Standard Real-Time (MSRT) mode**. This operating mode is only available if one of the real-time options (R&S FSW-K160RE/-B160R/-B512R/-U160R/-U512R) is installed.

In this operating mode, data acquisition is performed once as a real-time measurement, and the captured data is then evaluated by any number of secondary applications. Thus, a real-time measurement triggered with a frequency mask can be performed, and the results can be evaluated in the VSA secondary application, for example, to detect the cause of a frequency exception.

### Distinct operating modes

Although the applications themselves are identical in all operating modes, the handling of the data between applications is not. Thus, the operating mode determines which secondary applications are available and active. Whenever you change the operating mode, the currently active measurement channels are closed. The default operating mode is "Signal and Spectrum Analyzer" mode; however, the presetting can be changed.

**Remote command:**

INST:MODE SAN, see [INSTrument:MODE](#) on page 901

**Switching between secondary applications**

When you switch to a new secondary application, a set of parameters is passed on from the current secondary application to the new one:

- center frequency and frequency offset
- reference level and reference level offset
- attenuation

After initial setup, the parameters for the measurement channel are stored upon exiting and restored upon re-entering the channel. Thus, you can switch between secondary applications quickly and easily.

## 5.1 Available applications

**Access:** [MODE]

The FSW provides some applications in the base unit while others are available only if the corresponding firmware options are installed. Not all FSW applications are supported in MSRA/MSRT mode.

For details on the MSRT operating mode, see the [R&S®FSW Real-Time Measurements User Manual](#).

**Spectrogram application**

Spectrogram measurements are not a separate application, but rather a trace evaluation method, thus they are available as an evaluation method for the Display Configuration, not by creating a new channel. Spectrograms are configured and activated in the "Trace" settings. See [Chapter 8.5.2.1, "Working with spectrograms"](#), on page 629 for details.



### Trial licenses

The trial license allows you to use further optional applications that require a separate license from Rohde & Schwarz. It is pre-installed at the factory on request. If enabled, you can use additional applications for a limited period of time (90 days from factory installation).

Applications with trial licenses are indicated by a special tag:

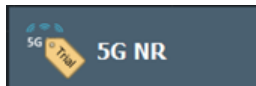

Currently, the following options are included in the trial license:

- R&S FSW-K6: "Pulse Measurements" on page 118
- R&S FSW-K7: "AM/FM/PM Modulation Analysis" on page 115
- R&S FSW-K17: "(Multi-Carrier) Group Delay" on page 116
- R&S FSW-K18: "Amplifier" on page 115
- R&S FSW-K19: Chapter 6.5, "Noise power ratio (NPR) measurement", on page 216 (no separate application, part of Spectrum application)
- R&S FSW-K30: "Noise Figure" on page 117
- R&S FSW-K40: "Phase Noise" on page 117
- R&S FSW-K50: "Fast Spur Search" on page 116
- R&S FSW-K54: Chapter 6.13, "Electromagnetic interference (EMI) measurement", on page 332 (no separate application, part of Spectrum application)
- R&S FSW-K60: "Transient Analysis" on page 118
- R&S FSW-K70: "Vector Signal Analysis (VSA)" on page 119
- R&S FSW-K96: "OFDM Vector Signal Analysis (OFDM VSA)" on page 117
- R&S FSW-K544: Chapter 11.5, "Frequency response correction (R&S FSW-K544)", on page 767 (no separate application, available in several applications)

For more information on the trial license see "Trial license" on page 785.

Spectrum.....	113
1xEV-DO BTS.....	113
1xEV-DO MS.....	113
3G FDD BTS.....	114
3G FDD UE.....	114
5G NR.....	114
802.11ad.....	114
802.11ay.....	114
Amplifier.....	115
AM/FM/PM Modulation Analysis.....	115
Avionics.....	115
Bluetooth.....	115
cdma2000 BTS.....	115
cdma2000 MS.....	116
Fast Spur Search.....	116
(Multi-Carrier) Group Delay.....	116



GSM.....	116
HRP UWB.....	116
I/Q Analyzer.....	116
LTE.....	117
NB-IoT.....	117
Noise Figure.....	117
OFDM Vector Signal Analysis (OFDM VSA).....	117
OneWeb.....	117
Phase Noise.....	117
Pulse Measurements.....	118
Real-Time Spectrum.....	118
TD-SCDMA BTS.....	118
TD-SCDMA UE.....	118
Transient Analysis.....	118
Verizon 5GTF Measurement Application (V5GTF).....	119
Vector Signal Analysis (VSA).....	119
WLAN.....	119
DOCSIS 3.1.....	119

### Spectrum

In the Spectrum application the provided functions correspond to those of a conventional spectrum analyzer. The analyzer measures the frequency spectrum of the RF input signal over the selected frequency range with the selected resolution and sweep time, or, for a fixed frequency, displays the waveform of the video signal. This application is used in the initial configuration.

For details see [Chapter 6, "Measurements and results"](#), on page 127.

Remote command:

INST:SEL SAN, see [INSTrument\[:SElect\]](#) on page 902

### 1xEV-DO BTS

The 1xEV-DO BTS application requires an instrument equipped with the 1xEV-DO BTS Measurements option, R&S FSW-K84. This application provides test measurements for 1xEV-DO BTS downlink signals (base station signals) according to the test specification.

For details see the R&S FSW-K84/-K85 User Manual.

For details see the R&S FSW-K84 User Manual.

Remote command:

INST:SEL BDO, see [INSTrument\[:SElect\]](#) on page 902

### 1xEV-DO MS

The 1xEV-DO MS application requires an instrument equipped with the 1xEV-DO MS Measurements option, R&S FSW-K85. This application provides test measurements for 1xEV-DO MS uplink signals (mobile signals) according to the test specification.

For details see the R&S FSW-K84/-K85 User Manual.

Remote command:

INST:SEL MDO, see [INSTrument\[:SElect\]](#) on page 902

### 3G FDD BTS

The 3G FDD BTS application requires an instrument equipped with the 3GPP Base Station Measurements option, R&S FSW-K72. This application provides test measurements for W-CDMA downlink signals (base station signals) according to the test specification.

For details see the R&S FSW-K72/-K73 User Manual.

For details see the R&S FSW-K72 User Manual.

Remote command:

INST:SEL BWCD, see [INSTrument\[:SElect\]](#) on page 902

### 3G FDD UE

The 3G FDD UE application requires an instrument equipped with the 3GPP User Equipment Measurements option, R&S FSW-K73. This application provides test measurements for W-CDMA uplink signals (mobile signals) according to the test specification.

For details see the R&S FSW-K72/-K73 User Manual.

Remote command:

INST:SEL MWCD, see [INSTrument\[:SElect\]](#) on page 902

### 5G NR

The 5G NR application requires an instrument equipped with one of the 5G NR Measurements options.

The R&S FSW-K144 application provides 5G NR measurements on the downlink.

The R&S FSW-K145 application provides 5G NR measurements on the uplink.

For details see the user manuals for the 5G NR downlink and uplink measurement application.

Remote command:

INST:SEL NR5G, see [INSTrument\[:SElect\]](#) on page 902

### 802.11ad

The 802.11ad application requires an instrument equipped with the 802.11ad option, R&S FSW-K95. This application provides measurements and evaluations according to the IEEE 802.11 ad standard.

For details see the R&S FSW-K95/-K97 User Manual.

Remote command:

INST:SEL WIGIG, see [INSTrument\[:SElect\]](#) on page 902

### 802.11ay

The 802.11ay application requires an instrument equipped with the 802.11ay option, R&S FSW-K97. This application provides measurements and evaluations according to the IEEE 802.11 ay standard.

For details see the R&S FSW-K95/-K97 User Manual.

Remote command:

INST:SEL EDMG, see [INSTrument\[:SElect\]](#) on page 902

**Amplifier**

The Amplifier Measurement application requires an instrument equipped with the Amplifier Measurement option R&S FSW-K18. This application provides measurements to measure the efficiency of traditional amplifiers and amplifiers that support envelope tracking with the FSW.

Also available is option R&S FSW-K18D, which provides direct DPD functionality. For details see the R&S FSW-K18 User Manual (also contains information about R&S FSW-K18D).

Remote command:

INST:SEL AMPL, see [INSTrument\[:SElect\]](#) on page 902

**AM/FM/PM Modulation Analysis**

The AM/FM/PM Modulation Analysis application requires an instrument equipped with the corresponding optional software. This application provides measurement functions for demodulating AM, FM, or PM signals.

For details see the R&S FSW-K7 User Manual.

Remote command:

INST:SEL ADEM, see [INSTrument\[:SElect\]](#) on page 902

**Avionics**

The Avionics application requires an instrument equipped with the corresponding optional software. This application provides measurement functions for measuring avionics (ILS/VOR) signals.

For details see the R&S FSW-K15 User Manual.

Remote command:

INST:SEL AVIONICS, see [INSTrument\[:SElect\]](#) on page 902

**Bluetooth**

The Bluetooth application requires an instrument equipped with the Bluetooth Measurements option R&S FSW-K8. This application provides Bluetooth measurements.

For details see the R&S FSW-K8 User Manual.

Remote command:

INST:SEL BTO, see [INSTrument\[:SElect\]](#) on page 902

**cdma2000 BTS**

The cdma2000 BTS application requires an instrument equipped with the cdma2000 BTS Measurements option, R&S FSW-K82. This application provides test measurements for cdma2000 BTS downlink signals (base station signals) according to the test specification.

For details see the R&S FSW-K82/-K83 User Manual.

For details see the R&S FSW-K82 User Manual.

Remote command:

INST:SEL BC2K, see [INSTrument\[:SElect\]](#) on page 902

**cdma2000 MS**

The cdma2000 MS application requires an instrument equipped with the cdma2000 MS Measurements option, R&S FSW-K83. This application provides test measurements for cdma2000 MS uplink signals (mobile signals) according to the test specification.

For details see the R&S FSW-K82/-K83 User Manual.

Remote command:

INST:SEL MC2K, see [INSTrument\[:SElect\]](#) on page 902

**Fast Spur Search**

The Fast Spur Search application requires an instrument equipped with the Fast Spur Search option, R&S FSW-K50. This application provides measurements and evaluations for spurious signal effects.

For details see the R&S FSW-K50 User Manual.

Remote command:

INST:SEL SPUR, see [INSTrument\[:SElect\]](#) on page 902

**(Multi-Carrier) Group Delay**

The Group Delay application requires an instrument equipped with the Multi-Carrier Group Delay Measurements option R&S FSW-K17. This application provides a Multi-Carrier Group Delay measurement.

For details see the R&S FSW-K17 User Manual.

Remote command:

INST:SEL MCGD, see [INSTrument\[:SElect\]](#) on page 902

**GSM**

The GSM application requires an instrument equipped with the GSM Measurements option R&S FSW-K10. This application provides GSM measurements.

For details see the R&S FSW-K10 User Manual.

Remote command:

INST:SEL GSM, see [INSTrument\[:SElect\]](#) on page 902

**HRP UWB**

The HRP UWB application requires an instrument equipped with the HRP UWB Measurements option R&S FSW-K149. This application provides HRP UWB measurements.

For details see the R&S FSW-K149 User Manual.

Remote command:

INST:SEL UWB, see [INSTrument\[:SElect\]](#) on page 902

**I/Q Analyzer**

The I/Q Analyzer application provides measurement and display functions for I/Q data.

For details see the R&S FSW I/Q Analyzer User Manual.

Remote command:

INST:SEL IQ, see [INSTrument\[:SElect\]](#) on page 902

**LTE**

The LTE application requires an instrument equipped with the LTE Measurements option R&S FSW-K10x. This application provides LTE measurements.

For details see the user manuals for the LTE downlink and uplink measurement application.

Remote command:

INST:SEL LTE, see [INSTrument\[:SElect\]](#) on page 902

**NB-IoT**

The NB-IoT application requires an instrument equipped with the NB-IoT measurements option R&S FSW-K106. This application provides NB-IoT measurements in the downlink.

For details see the R&S FSW-K106 (NB-IoT Downlink) User Manual.

Remote command:

INST:SEL NIOT, see [INSTrument\[:SElect\]](#) on page 902

**Noise Figure**

The Noise Figure application requires an instrument equipped with the Noise Figure Measurements option R&S FSW-K30. This application provides noise figure measurements.

For details see the R&S FSW-K30 User Manual.

Remote command:

INST:SEL NOISE, see [INSTrument\[:SElect\]](#) on page 902

**OFDM Vector Signal Analysis (OFDM VSA)**

The OFDM VSA application requires the OFDM Vector Signal Analysis option, R&S FSW-K96, to be installed. This application provides measurements and evaluations for OFDM Vector Signal Analysis.

For details see the R&S FSW-K96 User Manual.

Remote command:

INST:SEL OFDMVSA, see [INSTrument\[:SElect\]](#) on page 902

**OneWeb**

The OneWeb application requires an instrument equipped with the OneWeb measurements option R&S FSW-K201. This application provides OneWeb reverse link measurements.

For details see the R&S FSW-K201 (OneWeb Reverse Link Measurements) User Manual.

Remote command:

INST:SEL OWEB, see [INSTrument\[:SElect\]](#) on page 902

**Phase Noise**

The Phase Noise application requires an instrument equipped with the Phase Noise Measurements option, R&S FSW-K40. This application provides measurements for phase noise tests.

For details see the R&S FSW-K40 User Manual.

Remote command:

INST:SEL PNOISE, see [INSTrument\[:SElect\]](#) on page 902

### Pulse Measurements

The Pulse application requires an instrument equipped with the Pulse Measurements option, R&S FSW-K6. This application provides measurement functions for pulsed signals.

For details see the R&S FSW-K6 User Manual.

Remote command:

INST:SEL PULSE, see [INSTrument\[:SElect\]](#) on page 902

### Real-Time Spectrum

The Real-Time Spectrum application requires an instrument equipped with the Real-Time Spectrum option (R&S FSW-B160R/-K160RE/-U160R). This application provides real-time measurement functions.

For details see the R&S FSW Real-Time User Manual.

Remote command:

INST:SEL RTIM, see [INSTrument\[:SElect\]](#) on page 902

### TD-SCDMA BTS

The TD-SCDMA BTS application requires an instrument equipped with the TD-SCDMA Base Station Measurements option, R&S FSW-K76. This application provides test measurements for TD-SCDMA downlink signals (base station signals) according to the test specification.

For details see the R&S FSW-K76/-K77 User Manual.

For details see the R&S FSW-K76 User Manual.

Remote command:

INST:SEL BTDS, see [INSTrument\[:SElect\]](#) on page 902

### TD-SCDMA UE

The TD-SCDMA UE application requires an instrument equipped with the TD-SCDMA User Equipment Measurements option, R&S FSW-K77. This application provides test measurements for TD-SCDMA uplink signals (mobile signals) according to the test specification.

For details see the R&S FSW-K76/-K77 User Manual.

Remote command:

INST:SEL MTDS, see [INSTrument\[:SElect\]](#) on page 902

### Transient Analysis

The Transient Analysis application requires an instrument equipped with the Transient Analysis option, R&S FSW-K60. This application provides measurements and evaluations for Transient Analysis.

For details see the R&S FSW-K60 User Manual.

Remote command:

INST:SEL TA, see [INSTrument\[:SElect\]](#) on page 902

**Verizon 5GTF Measurement Application (V5GTF)**

The Verizon 5GTF measurement application requires an instrument equipped with the V5GTF option, R&S FSW-K118/K119. This application provides measurements and evaluations for uplink and downlink signals according to the Verizon 5G technical forum (TS V5G.211 standard).

For details see the R&S FSW-K118/-K119 User Manual.

Remote command:

INST:SEL V5GT, see [INSTrument\[:SElect\]](#) on page 902

**Vector Signal Analysis (VSA)**

The VSA application requires an instrument equipped with the Vector Signal Analysis option, R&S FSW-K70. This application provides measurements and evaluations for single-carrier digitally modulated signals.

For details see the R&S FSW-K70 User Manual.

Remote command:

INST:SEL DDEM, see [INSTrument\[:SElect\]](#) on page 902

**WLAN**

The WLAN application requires an instrument equipped with the WLAN option, R&S FSW-K91/91n. This application provides measurements and evaluations according to the WLAN IEEE 802.11 standards.

For details see the R&S FSW-K91 User Manual.

Remote command:

INST:SEL WLAN, see [INSTrument\[:SElect\]](#) on page 902

**DOCSIS 3.1**

The DOCSIS 3.1 application requires an instrument equipped with the DOCSIS 3.1 option, R&S FSW-K192. This application provides measurements and evaluations according to the DOCSIS 3.1 standard.

For details see the R&S FSW-K192 User Manual.

Remote command:

INST:SEL DOCS, see [INSTrument\[:SElect\]](#) on page 902

## 5.2 R&S multiview

Each application is displayed in a separate tab. An additional tab ("MultiView") provides an overview of all currently active channels at a glance. In the "MultiView" tab, each individual window contains its own channel bar with an additional button. Select this button to switch to the corresponding channel display quickly.



Remote command:

DISPlay:FORMat on page 1099

### 5.3 Selecting the operating mode and applications

Access: [MODE]

The default operating mode is Signal and Spectrum Analyzer mode, however, the pre-setting can be changed.

See "Preset Mode" on page 791.

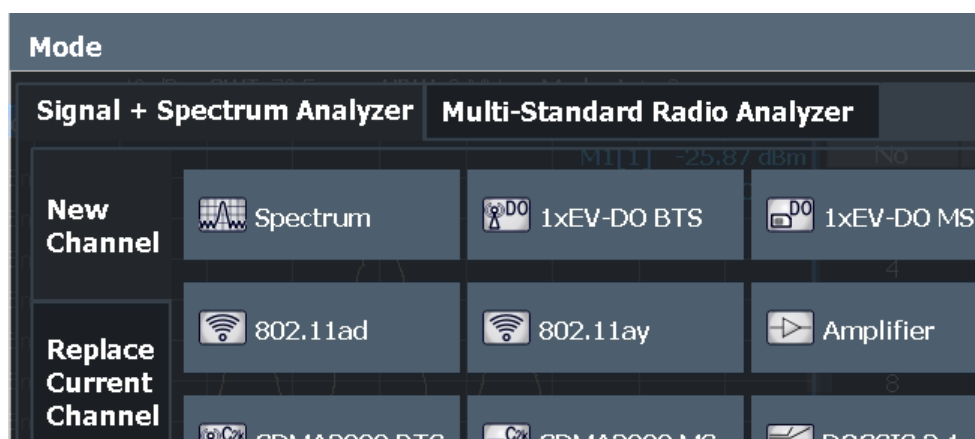

The default application in Signal and Spectrum Analyzer mode is a Spectrum measurement.





Optional applications require additional licenses. The application selection in the "Mode" dialog box depends on which licenses are available. If the predefined number of available licenses for a particular option are currently occupied by other users, you cannot open a further instance of the optional application until a license is returned. Per option, you only require a single license for any number of channels.

For more information, see [Chapter 11.7.2, "Licensing, versions and options"](#), on page 784.

### Switching between applications

When you switch to a new application, a set of parameters is passed on from the current application to the new one:

- center frequency and frequency offset
- reference level and reference level offset
- attenuation

After initial setup, the parameters for the measurement channel are stored upon exiting and restored upon re-entering the channel. Thus, you can switch between applications quickly and easily.

<a href="#">Switching the operating mode</a> .....	121
<a href="#">Selecting an application</a> .....	121
L <a href="#">New Channel</a> .....	121
L <a href="#">Replace Current Channel</a> .....	122
L <a href="#">Duplicate Current Channel</a> .....	122
<a href="#">Closing an application</a> .....	122

### Switching the operating mode

To switch the operating mode, select the corresponding tab.

Remote command:

[INSTRument:MODE](#) on page 901

### Selecting an application

To start a new or replace an existing application, select the corresponding button in the correct tab.

**Note:** The measurement channels are labeled with their default name. If that name already exists, a sequential number is added. You can change the name of the measurement channel by double-tapping the name in the channel bar and entering a new name.

For an overview of default names see [INSTRument:LIST?](#) on page 899.

Remote command:

[INSTRument\[:SElect\]](#) on page 902

### New Channel ← Selecting an application

The applications selected on this tab are started in a new measurement channel, i.e. a new tab in the display.

Remote command:

`INSTRUMENT:CREate[:NEW]` on page 898

`INSTRUMENT[:SElect]` on page 902

#### Replace Current Channel ← Selecting an application

The applications selected on this tab are started in the currently displayed measurement channel, replacing the current application.

Remote command:

`INSTRUMENT:CREate:REPLace` on page 899

#### Duplicate Current Channel ← Selecting an application

The currently active channel can be duplicated, i.e. a new channel of the same type and with the identical measurement settings is started. The name of the new channel is the same as the copied channel, extended by a consecutive number (e.g. "Spectrum" -> "Spectrum 2").

This command is not available if the MSRA primary channel is selected.

Remote command:

`INSTRUMENT:CREate:DUPLicate` on page 898

#### Closing an application

To close an application, simply close the corresponding tab by selecting the "x" next to the channel name.

Remote command:

`INSTRUMENT:DELeTe` on page 899

## 5.4 Running a sequence of measurements

Only one measurement can be performed at any time, namely the one in the currently active channel. However, in order to perform the configured measurements consecutively, a Sequencer function is provided.



The Sequencer function is slightly different in MSRA or MSRT operating mode. For details see the FSW MSRA User Manual or the FSW Real-Time Spectrum Application and MSRT Operating Mode User Manual.

- [The sequencer concept](#).....122
- [Sequencer settings](#)..... 125
- [How to set up the sequencer](#)..... 126

### 5.4.1 The sequencer concept

The instrument can only activate one specific channel at any time. Thus, only one measurement can be performed at any time, namely the one in the currently active channel. However, in order to perform the configured measurements consecutively, a Sequencer function is provided, which changes the channel of the instrument as

required. If activated, the measurements configured in the currently defined "Channel"s are performed one after the other in the order of the tabs.

For each individual measurement, the sweep count is considered. Thus, each measurement may consist of several sweeps. The currently active measurement is indicated by a  symbol in the tab label.

The result displays of the individual channels are updated in the tabs as the measurements are performed. Sequential operation itself is independent of the currently *displayed* tab.

### Sequencer modes

Three different Sequencer modes are available:

- **Single Sequence**  
Similar to single sweep mode; each measurement is performed once, until all measurements in all defined "Channel"s have been performed.
- **Continuous Sequence**  
Similar to continuous sweep mode; the measurements in each defined "Channel" are performed one after the other, repeatedly, in the same order, until sequential operation is stopped. This is the default Sequencer mode.
- **Channel-defined Sequence**  
First, a single sequence is performed. Then, only "Channel"s in continuous sweep mode are repeated continuously.

**Example: Sequencer procedure**

Assume the following active channel definition:



Tab name	Application	Sweep mode	Sweep count
Spectrum	Spectrum	Cont. Sweep	5
Spectrum 2	Spectrum	Single Sweep	6
Spectrum 3	Spectrum	Cont. Sweep	2
IQ Analyzer	IQ Analyzer	Single Sweep	7

For **Single Sequence**, the following sweeps will be performed:

5x Spectrum, 6x Spectrum 2, 2 x Spectrum 3, 7x IQ Analyzer

For **Continuous Sequence**, the following sweeps will be performed:

5x Spectrum, 6x Spectrum 2, 2 x Spectrum 3, 7x IQ Analyzer,

5x Spectrum, 6x Spectrum 2, 2 x Spectrum 3, 7x IQ Analyzer,

...

For **Channel-defined Sequence**, the following sweeps will be performed:

5x Spectrum, 6x Spectrum 2, 2 x Spectrum 3, 7x IQ Analyzer,

5x Spectrum, 2 x Spectrum 3,

5x Spectrum, 2 x Spectrum 3,

...

**Run Single/Run Cont and Single Sweep/Sweep Continuous keys**

While the Sequencer is active, the [Run Single] and [Run Cont] keys control the Sequencer, not individual sweeps. [Run Single] starts the Sequencer in single mode, while [Run Cont] starts the Sequencer in continuous mode.

The "Single Sweep" and "Continuous Sweep" *softkeys* control the sweep mode for the currently selected channel only; the sweep mode only has an effect the next time the Sequencer activates that channel, and only for a channel-defined sequence. In this case, a channel in single sweep mode is swept only once by the Sequencer. A channel in continuous sweep mode is swept repeatedly.

## 5.4.2 Sequencer settings



The "Sequencer" menu is available from the toolbar.



### Sequencer in MSRA/MSRT mode

In MSRA/MSRT operating mode and in the Real-Time Spectrum Application, the Sequencer behaves slightly differently.

For details on the MSRA operating mode see the FSW MSRA User Manual. For details on the MSRT operating mode and the Real-Time Spectrum application see the FSW Real-Time Spectrum Application and MSRT Operating Mode User Manual.

Sequencer State.....	125
Sequencer Mode.....	125

### Sequencer State

Activates or deactivates the Sequencer. If activated, sequential operation according to the selected Sequencer mode is started immediately.

Remote command:

`SYSTem:SEQuencer` on page 905

`INITiate:SEQuencer:IMMediate` on page 904

`INITiate:SEQuencer:ABORt` on page 904

### Sequencer Mode

Defines how often which measurements are performed. The currently selected mode softkey is highlighted blue. During an active Sequencer process, the selected mode softkey is highlighted orange.

#### "Single Sequence"

Each measurement is performed once, until all measurements in all active channels have been performed.

#### "Continuous Sequence"

The measurements in each active channel are performed one after the other, repeatedly, in the same order, until sequential operation is stopped.

This is the default Sequencer mode.

#### "Channel Defined Sequence"

First, a single sequence is performed. Then, only channels in continuous sweep mode are repeated.

Channel-defined sequence is not available in Multi-Standard Real-Time (MSRT) operating mode.

Remote command:

`INITiate:SEQuencer:MODE` on page 904

### 5.4.3 How to set up the sequencer

In order to perform the configured measurements consecutively, a Sequencer function is provided.

1. Configure a channel for each measurement configuration as required, including the sweep mode.
2. In the toolbar, select the "Sequencer" icon.



The "Sequencer" menu is displayed.

3. Toggle the "Sequencer" softkey to "On".  
A continuous sequence is started immediately.
4. To change the Sequencer mode and start a new sequence immediately, select the corresponding mode softkey, or press the [Run Single] or [Run Cont] key.

The measurements configured in the currently active channels are performed one after the other in the order of the tabs until the Sequencer is stopped.

The result displays in the individual channels are updated as the measurements are performed.

#### To stop the sequencer

- ▶ To stop the Sequencer temporarily, press the highlighted [Run Single] or [Run Cont] key (not for a channel-defined sequence). To continue the Sequencer, press the key again.  
To stop the Sequencer permanently, select the "Sequencer" icon in the toolbar and toggle the "Sequencer" softkey to "Off".

## 6 Measurements and results

**Access:** "Overview" > "Select Measurement"

**Or:** [MEAS]

In the Spectrum application, the FSW provides a variety of different measurement functions.

- **Basic measurements** - measure the spectrum of your signal or watch your signal in time domain
- **Power measurements** - calculate the powers involved in modulated carrier signals
- **Emission measurements** - detect unwanted signal emission
- **Statistic measurements** - evaluate the spectral distribution of the signal
- **Further measurements** - provide characteristic values of the signal
- **EMI measurements** - detect electromagnetic interference in the signal

The individual functions are described in detail in the following chapters.



### Trial licenses

The trial license allows you to use further optional measurements that require a separate license from Rohde & Schwarz. It is pre-installed at the factory on request. If enabled, you can use additional measurements for a limited period of time (90 days from factory installation).

Measurements with trial licenses are indicated by a special tag:

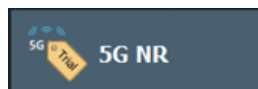

Currently, the following measurements are included in the trial license:

- R&S FSW-K19: [Chapter 6.5, "Noise power ratio \(NPR\) measurement"](#), on page 216
- R&S FSW-K54: [Chapter 6.13, "Electromagnetic interference \(EMI\) measurement"](#), on page 332

For more information on the trial license see ["Trial license"](#) on page 785.

The measurement function determines which settings, functions and evaluation methods are available in the FSW. The various measurement functions are described in detail here.

When you select a measurement function, the measurement is started with its default settings immediately and the corresponding measurement configuration menu is displayed. The measurement configuration menu can be displayed at any time by pressing [MEAS CONFIG].

The easiest way to configure measurements is using the configuration "Overview", see [Chapter 7.1, "Configuration overview"](#), on page 357.

In addition to the measurement-specific parameters, the general parameters can be configured as usual, see [Chapter 7, "Common measurement settings"](#), on page 357. Many measurement functions provide special result displays or evaluation methods; however, in most cases the general evaluation methods are also available, see [Chapter 8, "Common analysis and display functions"](#), on page 534.

After a preset, and when all other functions are switched off ("All Functions Off" in the "Select Measurement" dialog) the FSW performs a basic frequency sweep.

The remote commands required to retrieve measurement results are described in [Chapter 13.8.2.4, "Retrieving trace results"](#), on page 1257.



### Measurements on I/Q-based data

The I/Q Analyzer secondary application (*not primary*) in **MSRA mode** can also perform measurements on the captured I/Q data in the time and frequency domain.

The measurements are configured using the same settings as described here for the Spectrum application.

The results, however, may differ slightly as hardware settings are not adapted automatically as for the Spectrum application. Additionally, the analysis interval used for the measurement is indicated as in all MSRA applications.

For more information see the FSW MSRA User Manual.

• <a href="#">Basic measurements</a> .....	128
• <a href="#">Channel power and adjacent-channel power (ACLR) measurement</a> .....	149
• <a href="#">Carrier-to-noise measurements</a> .....	206
• <a href="#">Occupied bandwidth measurement (OBW)</a> .....	210
• <a href="#">Noise power ratio (NPR) measurement</a> .....	216
• <a href="#">Spectrum emission mask (SEM) measurement</a> .....	233
• <a href="#">Spurious emissions measurement</a> .....	279
• <a href="#">Statistical measurements (APD, CCDF)</a> .....	293
• <a href="#">Time domain power measurement</a> .....	308
• <a href="#">Harmonic distortion measurement</a> .....	313
• <a href="#">Third order intercept (TOI) measurement</a> .....	319
• <a href="#">AM modulation depth measurement</a> .....	329
• <a href="#">Electromagnetic interference (EMI) measurement</a> .....	332

## 6.1 Basic measurements

Basic measurements are common sweeps in the time or frequency domain which provide an overview of the basic input signal characteristics.

If no other measurement function is selected, or if all measurement functions are switched off, the FSW performs a basic frequency or time sweep.

After a preset, a frequency sweep is performed.

Use the general measurement settings to configure the measurement, e.g. via the "Overview" (see [Chapter 7, "Common measurement settings"](#), on page 357).



### 6.1.1 Basic measurement types

Frequency Sweep.....	129
Zero Span.....	129
All Functions Off.....	130

#### Frequency Sweep

A common frequency sweep of the input signal over a specified span. Can be used for general purposes to obtain basic measurement results such as peak levels and spectrum traces. The "Frequency" menu is displayed. This is the default measurement if no other function is selected.

Various other measurements are based on the common frequency sweep, but require additional configuration of sweep spans or amplitude limits, for example.

Examples for frequency sweep measurements are:

- Adjacent channel power (ACP)
- Carrier-to-noise (C/N)
- Occupied bandwidth (OBW)
- Noise power ratio (NPR)
- Spectrum emission mask (SEM)
- Spurious emissions
- Third order intercept (TOI)
- AM modulation depth
- Electromagnetic interference (EMI)

Use the general measurement settings to configure the measurement, e.g. via the "Overview" (see [Chapter 7, "Common measurement settings"](#), on page 357).

Remote command:

`[SENSe:]FREQuency:START` on page 1195, `[SENSe:]FREQuency:STOP` on page 1195

`INITiate<n>[:IMMediate]` on page 910

`INITiate<n>:CONTInuous` on page 909

#### Zero Span

A sweep in the time domain at the specified (center) frequency, i.e. the frequency span is set to zero. The display shows the time on the x-axis and the signal level on the y-axis, as on an oscilloscope. On the time axis, the grid lines correspond to 1/10 of the current sweep time.

Use the general measurement settings to configure the measurement, e.g. via the "Overview" (see [Chapter 7, "Common measurement settings"](#), on page 357).

Most result evaluations can also be used for zero span measurements, although some functions (e.g. markers) may work slightly differently and some may not be available. If so, this will be indicated in the function descriptions (see [Chapter 8, "Common analysis and display functions"](#), on page 534).

Remote command:

`[SENSe:]FREQuency:SPAN` on page 1194

`INITiate<n>[:IMMediate]` on page 910

`INITiate<n>:CONTInuous` on page 909

### All Functions Off

Switches off all measurement functions and returns to a basic frequency sweep.

Selecting "Frequency Sweep" has the same effect.

## 6.1.2 How to perform a basic sweep measurement

The following step-by-step instructions demonstrate how to perform basic sweep measurements.



For remote operation, see [Chapter 13.16.1, "Programming example: performing a basic frequency sweep"](#), on page 1531.

### To perform one or more single sweeps

1. Configure the frequency and span to be measured ("Frequency" dialog box, see [Chapter 7.3, "Frequency and span configuration"](#), on page 471).
2. Configure the number of sweeps to be performed in a single measurement ("Sweep Config" dialog box, see ["Sweep/Average Count"](#) on page 504).
3. If necessary, configure how the signal is processed internally ("Bandwidth" dialog box, see ["Sweep Type"](#) on page 505).
4. If necessary, configure a trigger for the measurement ("Trigger/ Gate Config" dialog box.  
See [Chapter 7.6, "Trigger and gate configuration"](#), on page 508
5. Define how the results are evaluated for display ("Trace" dialog box, see [Chapter 8.5.1.2, "Trace settings"](#), on page 622).
6. If necessary, configure the vertical axis of the display ("Amplitude" dialog box, see [Chapter 7.4, "Amplitude and vertical axis configuration"](#), on page 479).
7. To start the measurement, select one of the following:
  - [RUN SINGLE]
  - "Single Sweep" in the "Sweep" menu

The defined number of sweeps are performed, then the measurement is stopped. While the measurement is running, the [RUN SINGLE] key is highlighted. To abort the measurement, press [RUN SINGLE] again. The key is no longer highlighted. The results are not deleted until a new measurement is started.

8. To repeat the same number of sweeps without deleting the last trace, select "Continue Single Sweep" in the "Sweep" menu.

### To start continuous sweeping

1. If you want to average the trace or search for a maximum over more (or less) than 10 sweeps, configure the "Sweep/Average Count" ("Sweep Config" dialog box, see ["Sweep/Average Count"](#) on page 504).

2. To start the measurement, select one of the following:
  - [RUN CONT]
  - "Continuous Sweep" in the "Sweep" menu

After each sweep is completed, a new one is started automatically. While the measurement is running, the [RUN CONT] key is highlighted. To stop the measurement, press [RUN CONT] again. The key is no longer highlighted. The results are not deleted until a new measurement is started.

### 6.1.3 Measurement examples - measuring a sinusoidal signal

One of the most common measurement tasks that can be handled using a signal analyzer is determining the level and frequency of a signal. When measuring an unknown signal, you can usually start with the presets.

#### Test setup

1. Configure the signal generator (e.g. R&S SMW):
    - **Frequency:** 128 MHz
    - **Level:** -30 dBm
  2. **NOTICE!** Signal levels exceeding 30 dBm can damage the RF attenuator or the input mixer. When calculating the expected power level, consider the total power of all occurring signals.
 

If you measure signals higher than +30 dBm (=1 W), insert a power attenuator before the RF input of the analyzer.
  3. Connect the RF output of the signal generator to the RF input of the FSW.
- [Measuring the level and frequency using markers](#).....131
  - [Measuring the signal frequency using the signal counter](#)..... 133

#### 6.1.3.1 Measuring the level and frequency using markers

The level and frequency of a sinusoidal signal can be measured easily using the marker function. The FSW always displays its amplitude and frequency at the marker position. The frequency measurement uncertainty is determined by the reference frequency of the FSW, the resolution of the marker frequency display and the number of sweep points.

1. Select [PRESET] to reset the instrument.
2. Connect the signal to be measured to the "RF INPUT" connector on the FSW.
3. Set the center frequency to 128 MHz.
4. Reduce the frequency span to 1 MHz.

**Note:** Coupled settings. When the frequency span is defined, the resolution bandwidth, the video bandwidth and the sweep time are automatically adjusted, because these functions are defined as coupled functions in the presets.

5. Select [MKR] to activate marker 1 and automatically set it to the maximum of the trace.

The level and frequency values measured by the marker are displayed in the marker information at the top of the display.

**Note:** Performing a peak search. When a marker is initially activated, it automatically performs the peak search function (as shown in the example).

If a marker was already active, select [Peak Search] or the "Peak" softkey in the [MKR >] menu in order to set the currently active marker to the maximum of the displayed signal.

### Increasing the frequency resolution

The frequency resolution of the marker is determined by the resolution of the trace. A trace consists of 1001 trace points, i.e. if the frequency span is 1 MHz, each trace point represents a span of approximately 1 kHz. This corresponds to a maximum uncertainty of +/- 0.5 kHz.

You can increase the resolution of the trace by reducing the frequency span or by using more sweep points.

### Reducing the frequency span to 10 kHz

- ▶ Reduce the frequency span to *10 kHz*.

The resolution of the trace is now approximately 10 Hz (10 kHz span / 1001 trace points), thus, the precision of the marker frequency display increases to approximately  $\pm 5$  Hz.

### Setting the reference level

The reference level is the level at the upper limit of the diagram. To achieve the widest dynamic range possible for a spectrum measurement, use the entire level span of the FSW. In other words, the highest level that occurs in the signal should be located at the top edge of the diagram (= reference level) or immediately below it.



### Low Reference Levels

If the selected reference level is lower than the highest signal that occurs in the spectrum, the signal path in the FSW is overloaded.

In this case, the message "IFOVL" is displayed in the error message field.

In the presets, the value of the reference level is 0 dBm. If the input signal is -30 dBm, the reference level can be reduced by 30 dB without causing the signal path to be overloaded.

### Reducing the reference level by 30 dB

- ▶ Set the reference level to  $-30\text{ dBm}$ .

The maximum of the trace is near the maximum of the measurement diagram. The increase in the displayed noise is not substantial. Thus, the distance between the signal maximum and the noise display (=dynamic range) has increased.

### Setting the reference level with the help of a marker

You can also use a marker to shift the maximum value of the trace directly to the top edge of the diagram. If the marker is located at the maximum level of the trace (as in this example), the reference level can be moved to the marker level as follows:

1. Press [MKR ->].
2. Select "Ref Lvl = Mkr Lvl".

The reference level is set to the current marker level.

### 6.1.3.2 Measuring the signal frequency using the signal counter

The built-in signal counter allows you to measure the frequency more accurately than measuring it with the marker. The frequency sweep is stopped at the marker, and the FSW measures the frequency of the signal at the marker position (see also [Chapter 8.3.4.1, "Precise frequency \(signal count\) marker"](#), on page 566).

In the following example, the frequency of the generator at 128 MHz is shown using the marker.

#### Prerequisite

Precise frequency measurements require a precise reference frequency. Therefore, an external reference frequency from the signal generator is used. Connect the signal generator's "Ref OUT" connector to the analyzer's "Ref IN" connector.

1. Select [PRESET] to reset the instrument.
2. Set the center frequency to  $128\text{ MHz}$ .
3. Set the frequency span to  $1\text{ MHz}$ .
4. Select "Setup" > "Reference" > "External Reference 10 MHz" to activate the external reference frequency.
5. Select [MKR] to activate marker 1 and automatically set it to the maximum of the trace.

The level and the frequency of the marker are displayed in the marker results in the diagram or the marker table.

6. Select [MKR FUNC] > "Signal Count" to activate the signal counter.

The result of the signal counter is displayed in the marker results.

- If necessary, increase the resolution of the signal counter by selecting "Signal Count Resolution" (in the "Signal Count" menu).



#### Prerequisites for using the internal signal counter

In order to obtain a correct result when measuring the frequency with the internal signal counter, an RF sinusoidal signal or a spectral line must be available. The marker must be located more than 25 dB above the noise level to ensure that the specified measurement accuracy is adhered to.

### 6.1.4 Measurement example – measuring levels at low S/N ratios

The minimum signal level a signal analyzer can measure is limited by its intrinsic noise. Small signals can be swamped by noise and therefore cannot be measured. For signals that are just above the intrinsic noise, the accuracy of the level measurement is influenced by the intrinsic noise of the FSW.

The displayed noise level of a signal analyzer depends on its noise figure, the selected RF attenuation, the selected reference level, the selected resolution and video bandwidth and the detector.

For details see:

- Chapter 7.4.1.2, "RF attenuation", on page 480
- Chapter 7.4.1.1, "Reference level", on page 479
- Chapter 7.5.1.1, "Separating signals by selecting an appropriate resolution bandwidth", on page 492
- Chapter 7.5.1.2, "Smoothing the trace using the video bandwidth", on page 493
- "Mapping samples to sweep points with the trace detector" on page 609

This measurement example shows the different factors influencing the S/N ratio.

**Table 6-1: Signal generator settings (e.g. R&S SMW)**

Frequency	128 MHz
Level	-95 dBm

- Preset the FSW.
- Set the center frequency to *128 MHz*.
- Set the span to *100 MHz*.
- Set the reference level to *-30 dBm*.

The signal is measured with the auto peak detector and is completely hidden in the intrinsic noise of the FSW.

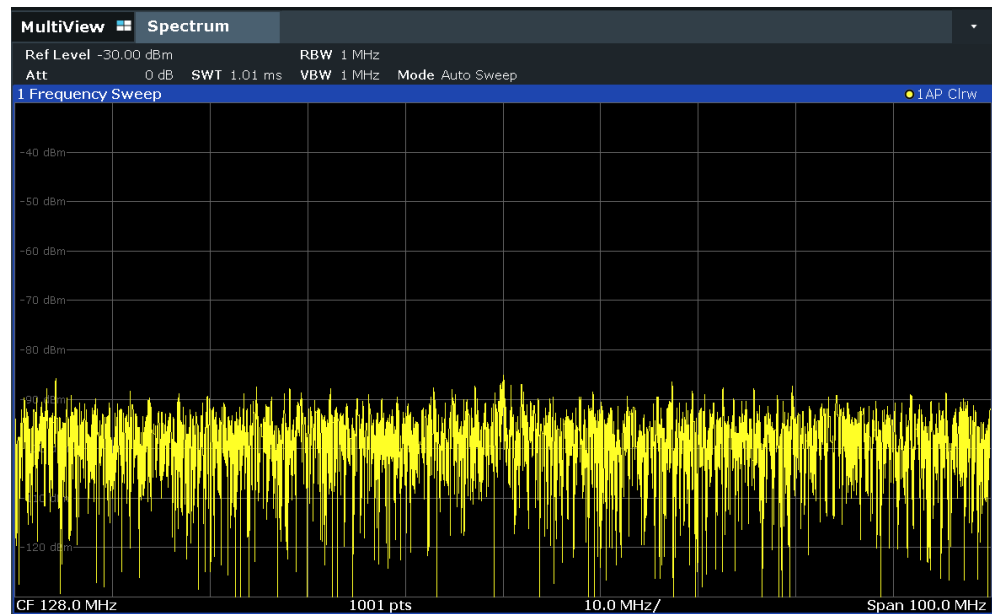

Figure 6-1: Sine wave signal with low S/N ratio

- To suppress noise spikes, average the trace. In the "Traces" configuration dialog, set the "Trace Mode" to "Average" (see "Trace Mode" on page 623).

The traces of consecutive sweeps are averaged. To perform averaging, the FSW automatically switches on the sample detector. The RF signal, therefore, can be more clearly distinguished from noise.

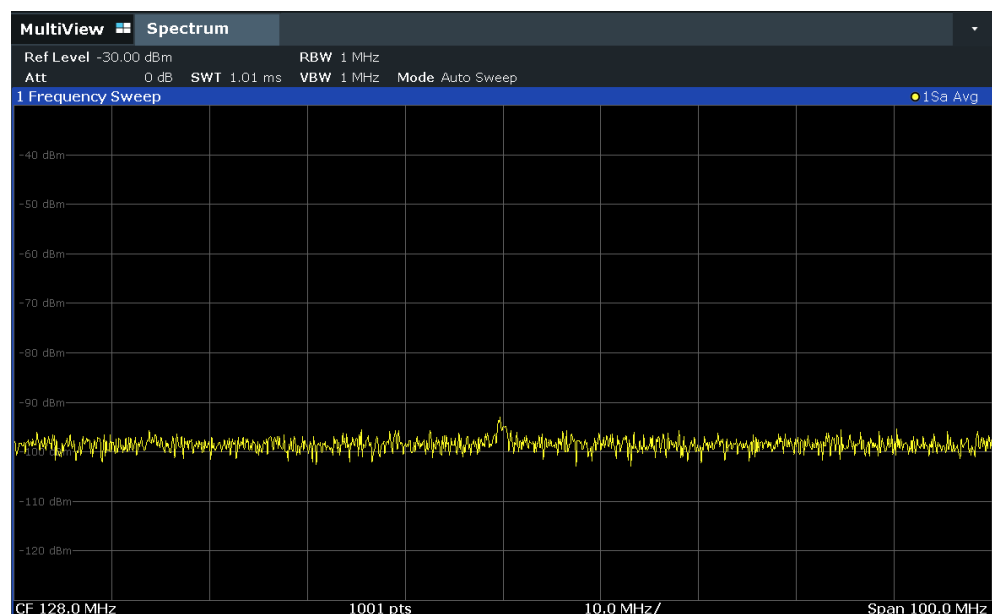
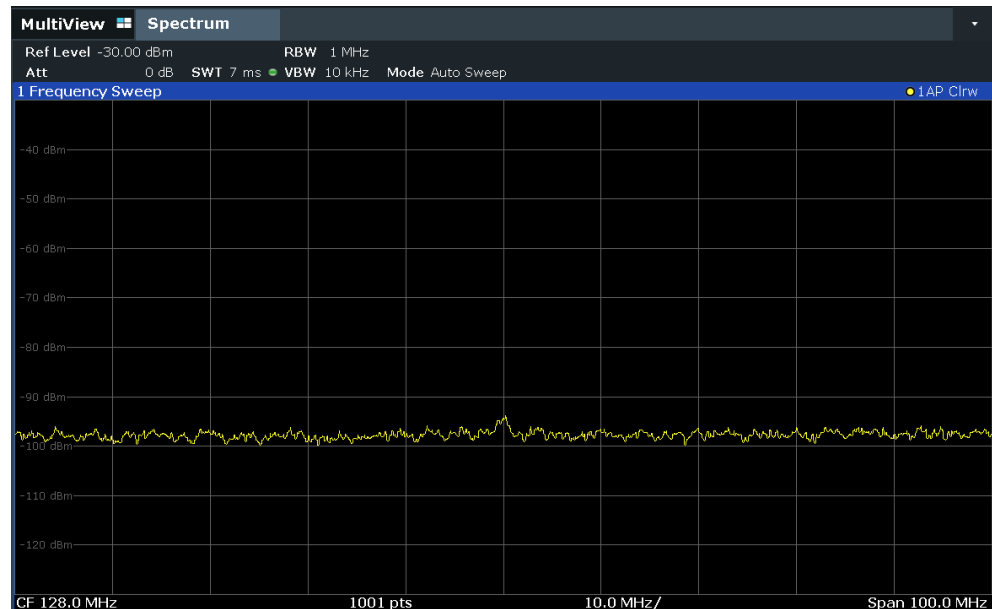

Figure 6-2: RF sine wave signal with low S/N ratio with an averaged trace

6. Instead of trace averaging, you can select a video filter that is narrower than the resolution bandwidth. Set the trace mode back to "Clear/ Write", then set the VBW to 10 kHz manually in the "Bandwidth" configuration dialog.

The RF signal can be distinguished from noise more clearly.



**Figure 6-3: RF sine wave signal with low S/N ratio with a smaller video bandwidth**

7. By reducing the resolution bandwidth by a factor of 10, the noise is reduced by 10 dB. Set the RBW to 100 kHz.

The displayed noise is reduced by approximately 10 dB. The signal, therefore, emerges from noise by about 10 dB. Compared to the previous setting, the video bandwidth has remained the same, i.e. it has increased relative to the smaller resolution bandwidth. The averaging effect of the video bandwidth is therefore reduced. The trace will be noisier.



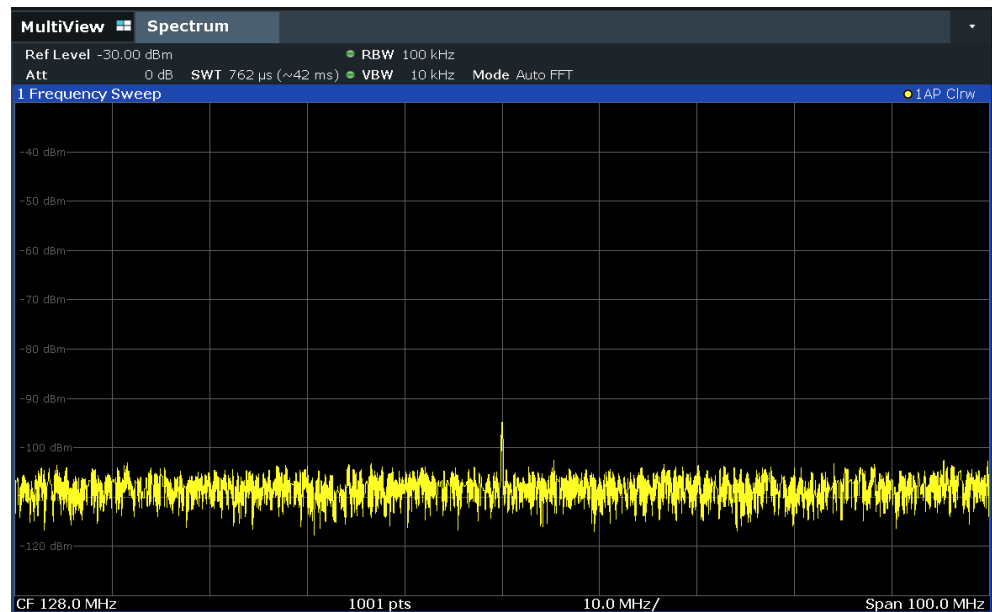

Figure 6-4: Reference signal at a smaller resolution bandwidth

### 6.1.5 Measurement examples - measuring signal spectra with multiple signals

- [Separating signals by selecting the resolution bandwidth](#)..... 137
- [Measuring the modulation depth of an AM-modulated carrier in the frequency domain](#)..... 140
- [Measuring AM-modulated signals](#)..... 141

#### 6.1.5.1 Separating signals by selecting the resolution bandwidth

A basic feature of a Signal and Spectrum Analyzer is the ability to separate the spectral components of a mixture of signals. The resolution at which the individual components can be separated is determined by the resolution bandwidth. Selecting a resolution bandwidth that is too large may make it impossible to distinguish between spectral components, i.e. they are displayed as a single component (see also [Chapter 7.5.1.1, "Separating signals by selecting an appropriate resolution bandwidth"](#), on page 492).

Two signals with the same amplitude can be resolved if the resolution bandwidth is smaller than or equal to the frequency spacing of the signal. If the resolution bandwidth is equal to the frequency spacing, the spectrum display shows a level drop of 3 dB precisely in the center of the two signals. Decreasing the resolution bandwidth makes the level drop larger, which thus makes the individual signals clearer.

In this measurement example we will analyze two signals with a level of -30 dBm each and a frequency spacing of 30 kHz.

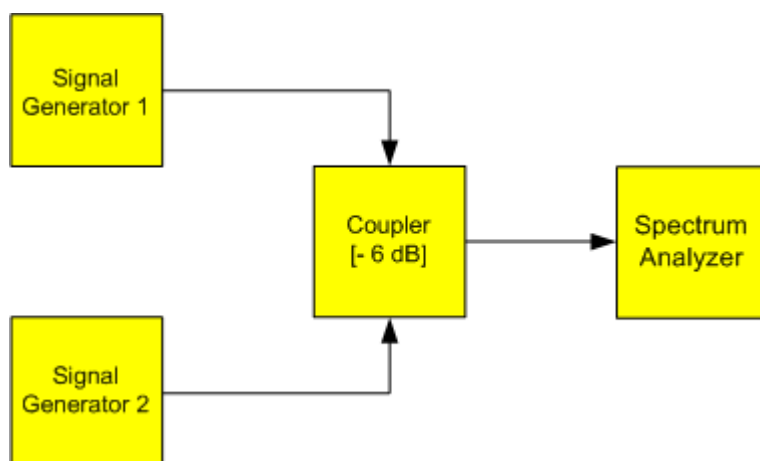

Figure 6-5: Test setup

Table 6-2: Signal generator settings (e.g. R&S SMW)

	Level	Frequency
Signal generator 1	-30 dBm	128,00 MHz
Signal generator 2	-30 dBm	128,03 MHz

1. Select [PRESET] to reset the instrument.
2. Set the center frequency to *128.015 MHz*.
3. Set the frequency span to *300 kHz*.
4. Set the resolution bandwidth to *30 kHz* and the video bandwidth to *1 kHz*.

**Note:** Larger video bandwidths. The video bandwidth is set to 1 kHz in order to make the level drop in the center of the two signals clearly visible. At larger video bandwidths, the video voltage that results from envelope detection is not sufficiently suppressed. This produces additional voltages, which are visible in the trace, in the transition area between the two signals.

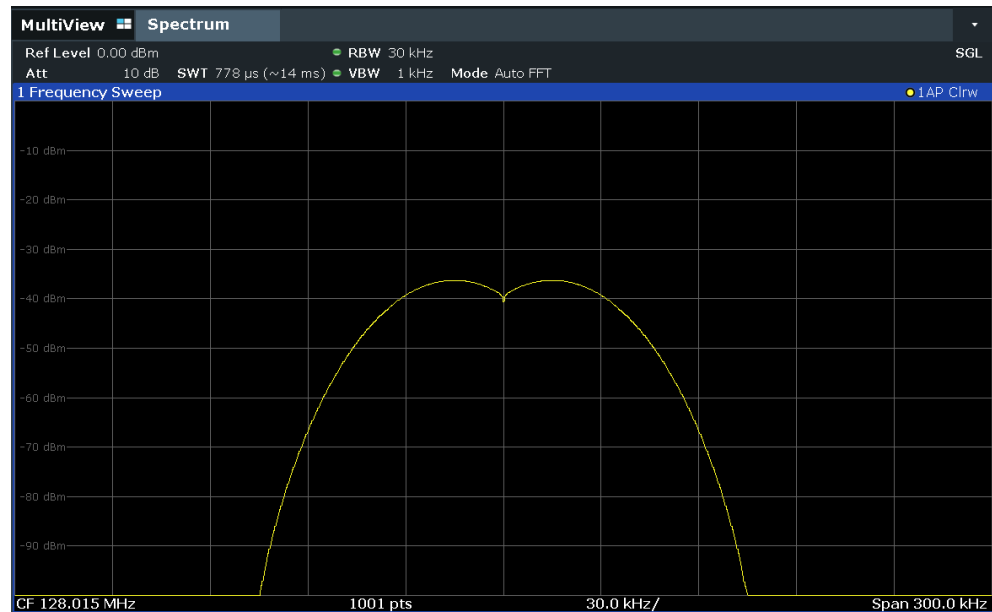

Figure 6-6: Measurement of two equally-leveled RF sinusoidal signals with the resolution bandwidth which corresponds to the frequency spacing of the signals

### Matching generator and FSW frequencies

The level drop is located exactly in the center of the display only if the generator frequencies match the frequency display of the FSW exactly. To achieve exact matching, the frequencies of the generators and the FSW must be synchronized.

- Set the resolution bandwidth to 100 kHz.

It is no longer possible to clearly distinguish the two generator signals.

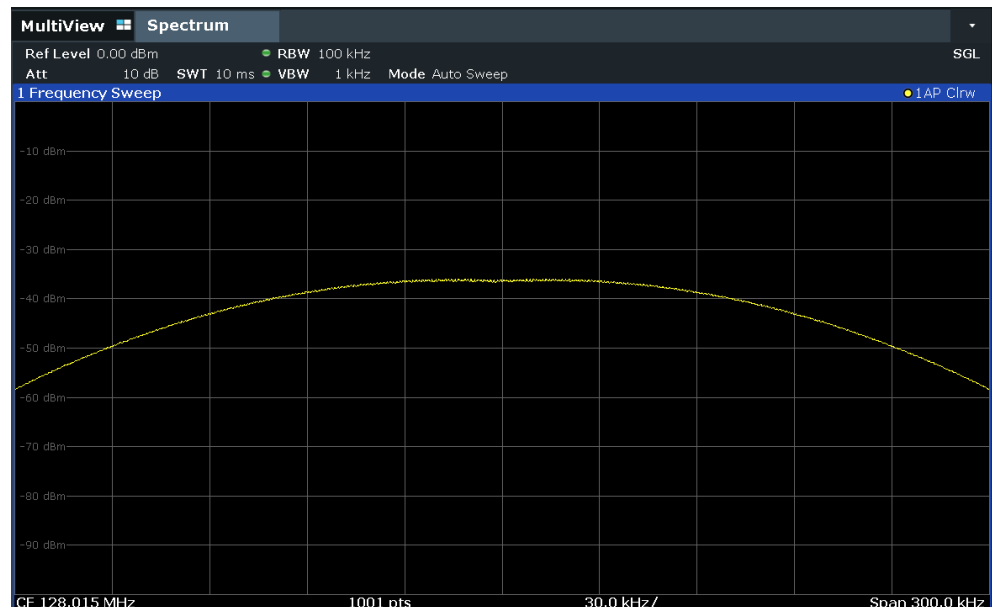

Figure 6-7: Measurement of two equally-leveled RF sinusoidal signals with a resolution bandwidth which is larger than their frequency spacing

6. Set the resolution bandwidth to 1 kHz.

The two generator signals are shown with high resolution. However, the sweep time becomes longer. At smaller bandwidths, the noise display decreases simultaneously (10 dB decrease in noise floor for a decrease in bandwidth by a factor of 10).

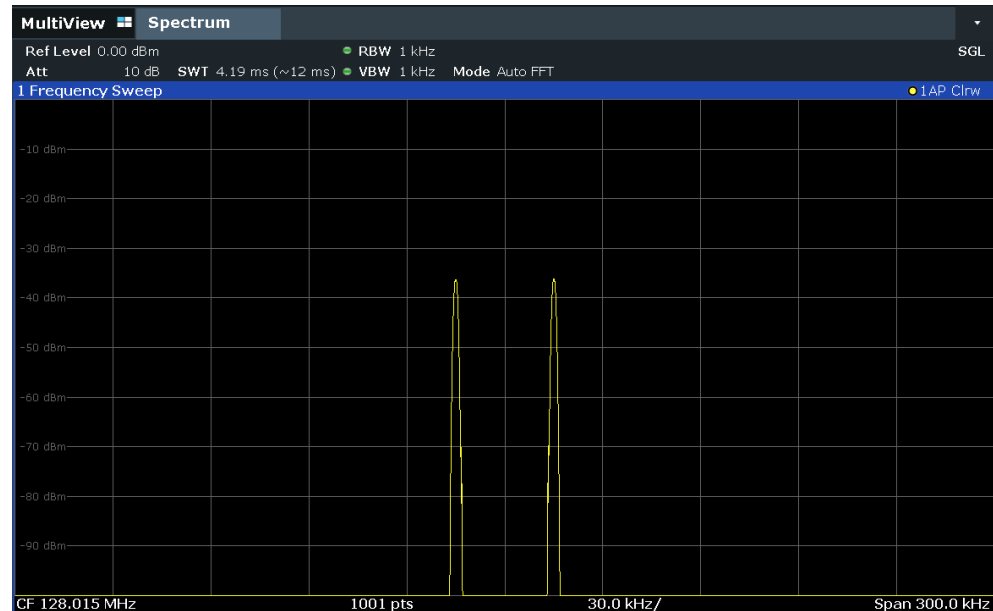

Figure 6-8: Measurement of two equally-leveled RF sinusoidal signals with a resolution bandwidth (1 kHz) which is significantly smaller than their frequency spacing

### 6.1.5.2 Measuring the modulation depth of an AM-modulated carrier in the frequency domain

In the frequency range display, the AM side bands can be resolved with a narrow bandwidth and measured separately. The modulation depth of a carrier modulated with a sinusoidal signal can then be measured. Since the dynamic range of a signal analyzer is very large, extremely small modulation depths can also be measured precisely. For this purpose, the FSW provides measurement routines that output the modulation depth numerically in percent directly.

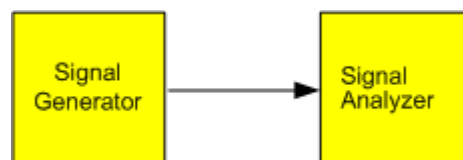

Figure 6-9: Test setup

Table 6-3: Signal generator settings (e.g. R&amp;S SMW)

Frequency	128 MHz
Level	-30 dBm
Modulation	50 % AM, 10 kHz AF

1. Select [PRESET] to reset the instrument.
2. Set the center frequency to *128 MHz*.
3. Set the frequency span to *50 kHz*.
4. Select [MEAS] > "AM Modulation Depth" to activate the modulation depth measurement.

The FSW automatically sets a marker to the carrier signal in the center of the diagram and one delta marker each to the upper and lower AM sidebands. The FSW calculates the AM modulation depth from the level differences of the delta markers to the main marker and outputs the numeric value in the marker information.

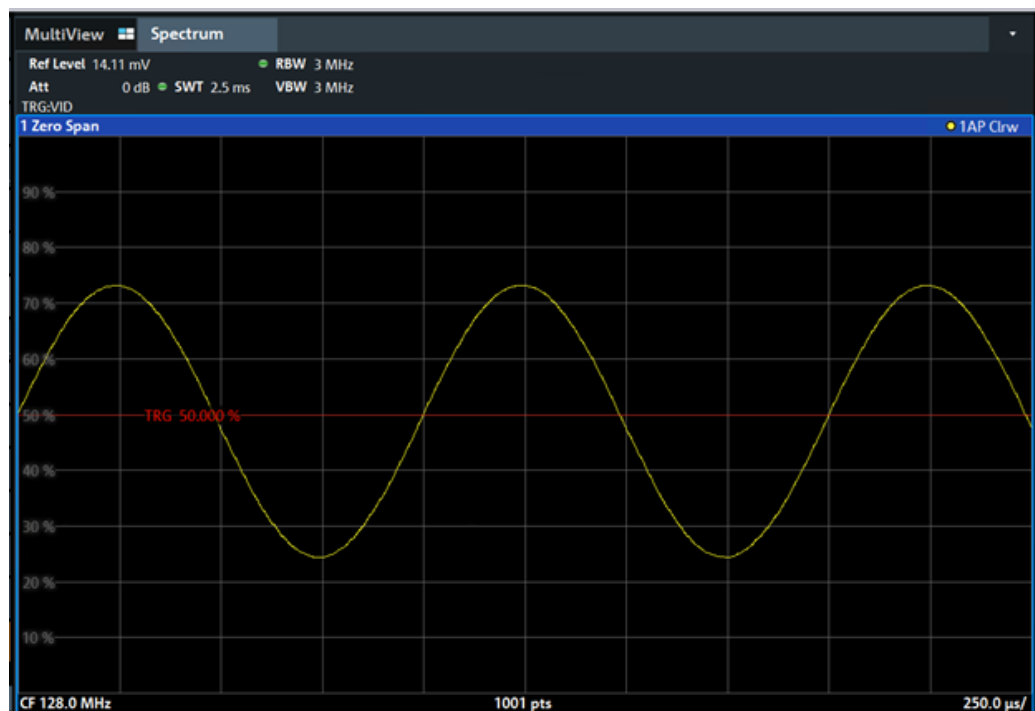

Figure 6-10: Measurement of the AM modulation depth

The modulation depth is displayed as "MDepth". The frequency of the AF signal can be obtained from the frequency display of the delta marker.

### 6.1.5.3 Measuring AM-modulated signals

The FSW rectifies the RF input signal (that is, removes the negative parts) and displays it as a magnitude spectrum. The rectification also demodulates AM-modulated

signals. The AF voltage can be displayed in zero span if the modulation sidebands fall within the resolution bandwidth.

### Displaying the AF of an AM-modulated signal (Zero Span)

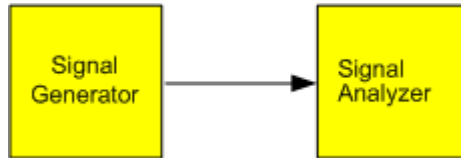

Figure 6-11: Test setup

Table 6-4: Signal generator settings (e.g. R&S SMW)

Frequency	128 MHz
Level	-30 dBm
Modulation	50 % AM, 1 kHz AF

1. Select [PRESET] to reset the instrument.
2. Set the center frequency to *128 MHz*.
3. Set the frequency span to *0 Hz* or select "Zero Span".
4. Set the sweep time to *2.5 ms*.
5. Set the RBW to *3 MHz*.
6. Set the reference level to *-24 dBm* and the display range to linear ([AMPT] > "Scale Config" > "Scaling": "Linear Percent").
7. Set the scaling unit to Volt ([AMPT] > "Amplitude Config" > "Unit": "V").
8. Define triggering in response to the AF signal using the video trigger to produce a static image.
  - a) Press [TRIG].
  - b) Select "Video".
  - c) Set the "Trg/Gate Level" to *50%*.

The trigger level is displayed as a horizontal line across the entire measurement diagram. The FSW displays the 1 kHz AF signal as a static image in zero span.

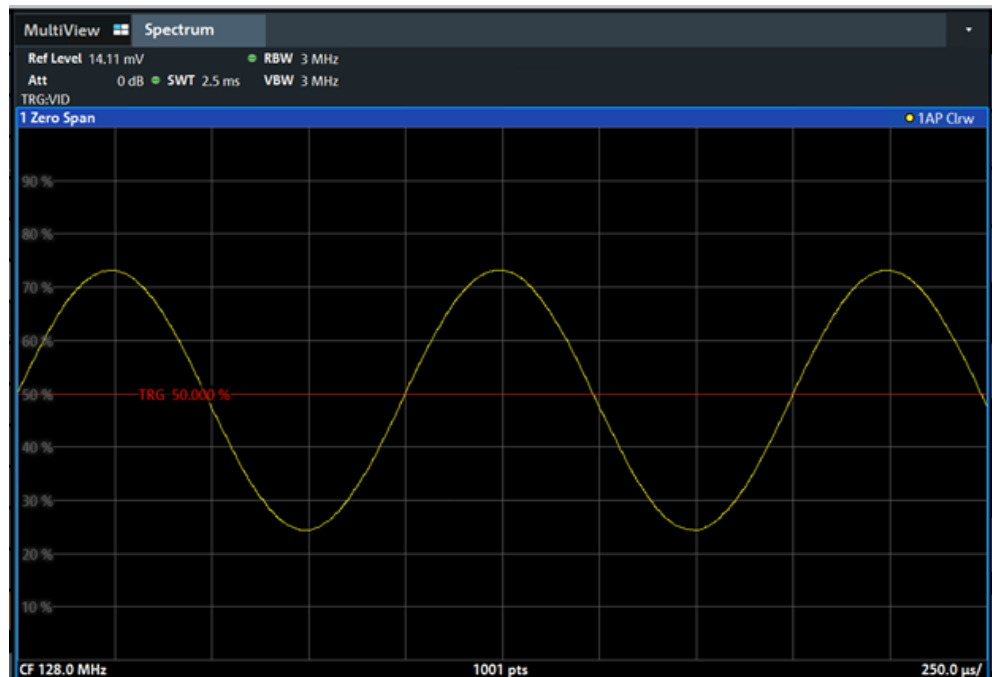

Figure 6-12: Measurement of the AF signal of a carrier that is AM-modulated with 1 kHz

9. Activate the internal AM demodulator to output the audio signal.
  - a) Press [MKR FUNC].
  - b) Select "Marker Demodulation".  
 The FSW automatically switches on the AM audio demodulator. A 1 kHz tone can be heard over headset (via the PHONES connector). If necessary, use the volume control to turn up the volume.

### 6.1.6 Measurement examples in zero span

For radio transmission systems that use the TDMA method (for example, GSM), transmission quality is determined not only by spectral characteristics but also by characteristics in zero span. A timeslot is assigned to each user since several users share the same frequency. Smooth operation is ensured only if all users adhere exactly to their assigned timeslots.

Both the power during the send phase as well as the timing and duration of the TDMA burst, and rise and fall times of the burst, are important.

- [Measuring the power characteristic of burst signals](#)..... 143
- [Measuring the signal-to-noise ratio of burst signals](#)..... 147

#### 6.1.6.1 Measuring the power characteristic of burst signals

To measure power in zero span, the FSW offers easy-to-use functions that measure the power over a predefined time.

### Measuring the power of a GSM burst during the activation phase

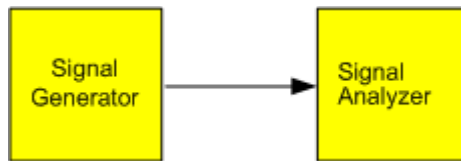

Figure 6-13: Test setup

Table 6-5: Signal generator settings (e.g. R&S SMW)

Frequency	890 MHz
Level	0 dBm
Modulation	GSM, one timeslot activated

1. Select [PRESET] to reset the instrument.
2. Set the center frequency to *890 MHz* ([FREQ]).
3. Set the frequency span to *0 Hz* ([SPAN] > "Zero Span").
4. Set the reference level to *10 dBm* (= level of the signal generator +10 dB) (AMPT).
5. Set the attenuation to *20 dB* ([AMPT] > "RF Atten Manual").
6. Set the resolution bandwidth to *1 MHz* ([BW] > "Res BW").
7. Set the sweep time to *1 ms* ([SWEEP] > "Sweep Time Manual").  
The FSW shows the GSM burst continuously across the display.
8. Using the video trigger, set triggering on the rising edge of the burst.
  - a) Press [TRIG].
  - b) Set the "Trg Source" to "Video".
  - c) Set the "Trg/Gate Level" to *70%*.

The FSW shows a static image with the GSM burst at the start of the trace. The trigger level is displayed as a horizontal line labeled with the absolute level for the trigger threshold in the measurement diagram.
9. Activate power measurement within the activation phase of the burst in zero span.
  - a) Press [MEAS].
  - b) Select "Time Domain Power".
  - c) Select "Time Dom Power Config".
  - d) Set the "Limits" state to "On".
  - e) Select the "Left Limit" input field.
  - f) By turning the rotary knob clockwise, move the vertical line "S1" to the start of the burst.
  - g) Select the "Right Limit" input field.



h) By turning the rotary knob clockwise, move the vertical line "S2" to the end of the burst.

The FSW displays the average (mean) power during the activation phase of the burst.

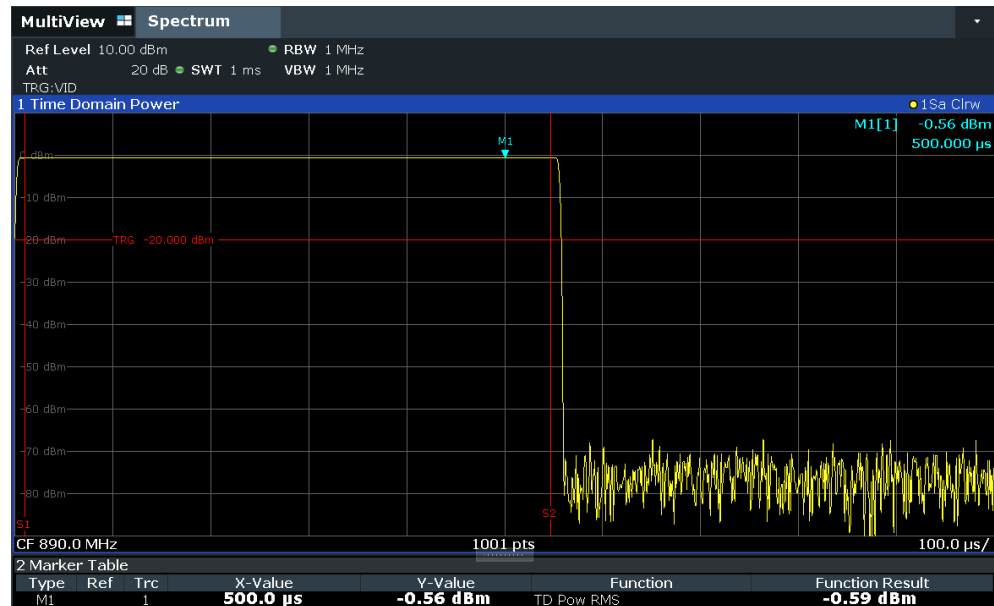

Figure 6-14: Measurement of the average power during the burst of a GSM signal

### Measuring the edges of a GSM burst with high time resolution

Due to the high time resolution of the FSW at the 0 Hz display range, the edges of TDMA bursts can be measured precisely. The edges can be shifted to the display area using the trigger offset.

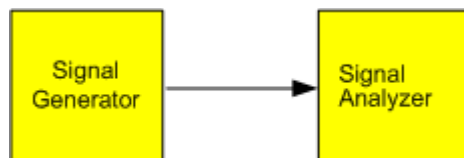

Figure 6-15: Test setup

Table 6-6: Signal generator settings (e.g. R&S SMW)

Frequency	890 MHz
Level	0 dBm
Modulation	GSM, one timeslot activated

The measurement is based on the example "Measuring the power of a GSM burst during the activation phase" on page 144.

1. Switch off the power measurement.
  - a) Press [MEAS].

- b) Select "Zero Span".
2. Increase the time resolution by setting the sweep time to  $100\ \mu\text{s}$  ([SWEEP] > "Sweep Time Manual").
3. Shift the rising edge of the GSM burst to the center of the display by defining a trigger offset.
  - a) Press [TRIG].
  - b) Select "Trigger Offset".
  - c) By turning the rotary knob counterclockwise, reduce the trigger offset until the burst edge is displayed in the center of the display, or enter  $-50\ \mu\text{s}$ .  
The FSW displays the rising edge of the GSM burst.

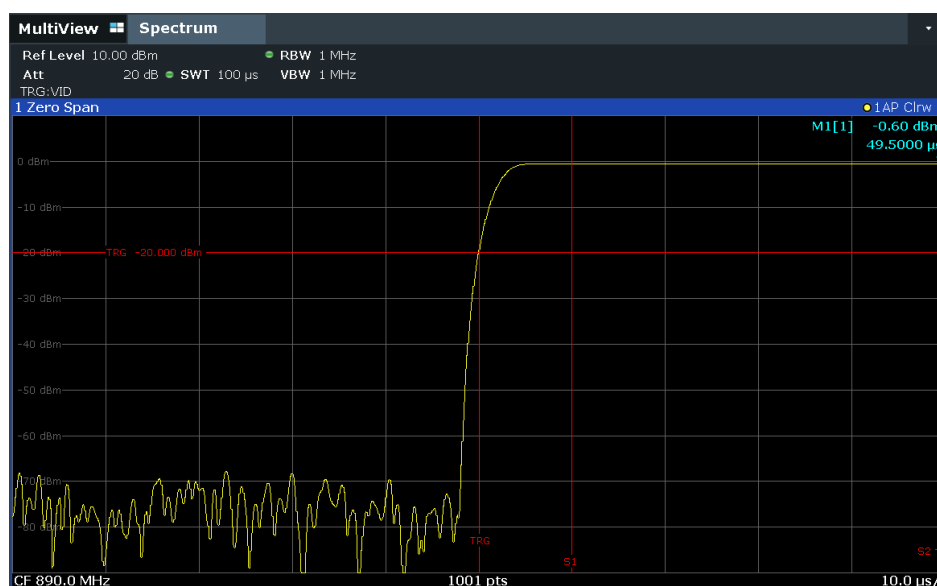

Figure 6-16: Rising edge of the GSM burst displayed with high time resolution

4. Move the falling edge of the burst to the center of the display. To do so, switch the trigger "Slope" to "Falling" ([TRIG] > "Trigger/ Gate Config").  
The FSW displays the falling edge of the GSM burst.

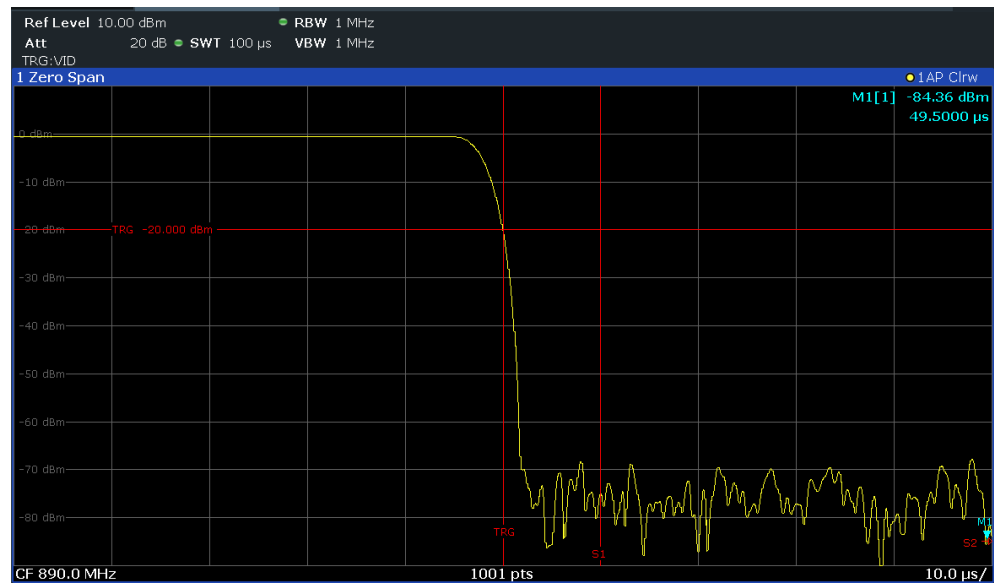

Figure 6-17: Falling edge of the GSM burst displayed with high time resolution

### 6.1.6.2 Measuring the signal-to-noise ratio of burst signals

When TDMA transmission methods are used, the signal-to-noise ratio or the dynamic range for deactivation can be measured by comparing the power values during the activation phase and the deactivation phase of the transmission burst. Therefore, the FSW provides a measurement for absolute and relative power in zero span. In the following example, the measurement is performed using a GSM burst.

#### Signal-to-Noise Ratio of a GSM Signal

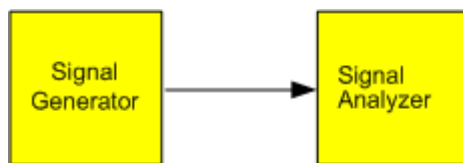

Figure 6-18: Test setup

Table 6-7: Signal generator settings (e.g. R&S SMW)

Frequency	890 MHz
Level	0 dBm
Modulation	GSM, one time slot is switched on

1. Select [PRESET] to reset the instrument.
2. Set the center frequency to 890 MHz.
3. Set the frequency span to 0 Hz.
4. Set the resolution bandwidth to 1 MHz.

5. Set the reference level to 0 dBm (= level of the signal generator).
6. Set the sweep time to 2 ms ([SWEEP] > "Sweep Time Manual").  
The FSW shows the GSM burst continuously across the display.
7. Use the trigger source "Video" and the trigger slope "Rising" to trigger on the rising edge of the burst and shift the start of the burst to the center of the display (see [step 3](#) in "[Measuring the edges of a GSM burst with high time resolution](#)" on page 145).

8. Activate power measurement within the activation phase of the burst in zero span.
  - a) Press [MEAS].
  - b) Select "Time Domain Power".
  - c) Select "Time Dom Power Config".
  - d) Set the "Limits" state to "On".
  - e) Select the "Left Limit" input field.
  - f) By turning the rotary knob clockwise, move the vertical line "S1" to the start of the burst.
  - g) Select the "Right Limit" input field.
  - h) By turning the rotary knob clockwise, move the vertical line "S2" to the end of the burst.
  - i) Note down the power result for the burst, indicated by the "TD Pow RMS" result in the marker table.

9. Measure the power during the deactivation phase of the burst by switching the trigger slope to "Falling" ([TRIG] > "Trigger/ Gate Config").

The FSW initiates triggering in response to the falling edge of the burst. This shifts the burst to the left-hand side of the measurement diagram. The power is measured in the deactivation phase.

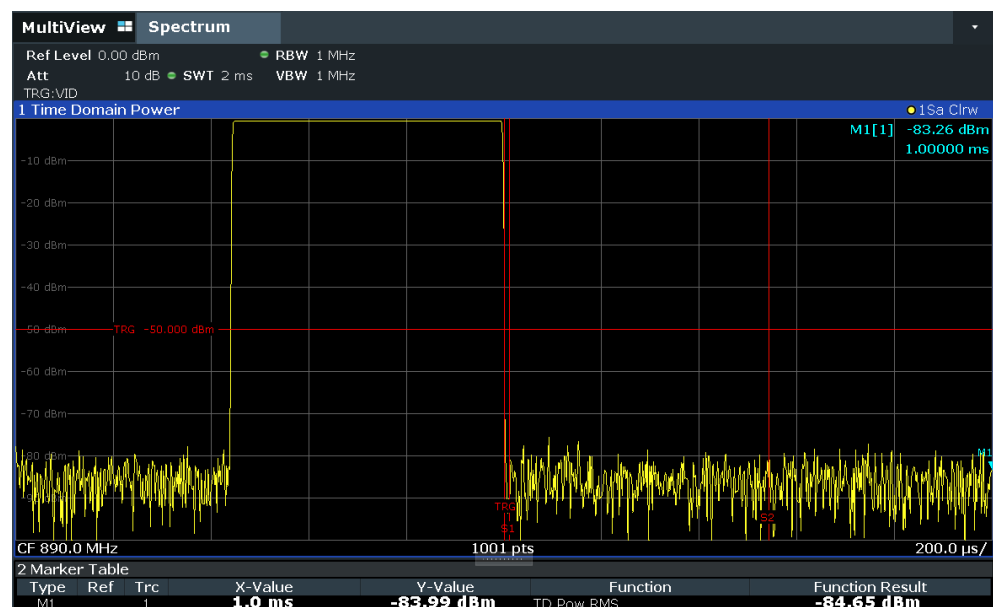

Figure 6-19: Measurement of the signal-to-noise ratio of a GSM burst signal in zero span

## Channel power and adjacent-channel power (ACLR) measurement

10. Note down the power result for the measured noise, indicated by the "TD Pow RMS" result in the marker table.

Subtract the measured noise power from the burst power to obtain the signal-to-noise ratio of the burst signal.

## 6.2 Channel power and adjacent-channel power (ACLR) measurement

Measuring the power in channels adjacent to the carrier or transmission channel is useful to detect interference. The results are displayed as a bar chart for the individual channels.

- [About channel power measurements](#)..... 149
- [Channel power results](#)..... 150
- [Channel power basics](#)..... 152
- [Channel power configuration](#)..... 165
- [MSR ACLR configuration](#)..... 175
- [How to perform channel power measurements](#)..... 192
- [Measurement examples](#)..... 197
- [Optimizing and troubleshooting the measurement](#)..... 203
- [Reference: predefined CP/ACLR standards](#)..... 204
- [Reference: predefined ACLR user standard XML files](#)..... 205

### 6.2.1 About channel power measurements

Measuring channel power and adjacent channel power is one of the most important tasks during signal analysis with the necessary test routines in the field of digital transmission. Theoretically, a power meter could be used to measure channel power at highest accuracy. However, its low selectivity means that it is not suitable for measuring adjacent channel power as an absolute value or relative to the transmit channel power. Only a selective power meter can measure the power in the adjacent channels.

A signal analyzer cannot be classified as a true power meter, because it displays the IF envelope voltage. However, it is calibrated such as to display the power of a pure sine wave signal correctly, irrespective of the selected detector. This calibration cannot be applied for non-sinusoidal signals. Assuming that the digitally modulated signal has a Gaussian amplitude distribution, the signal power within the selected resolution bandwidth can be obtained using correction factors. The internal power measurement routines in a signal analyzer normally use these correction factors to determine the signal power from IF envelope measurements. These factors apply if and only if the assumption of a Gaussian amplitude distribution is correct.

Apart from this common method, the FSW also has a true power detector, i.e. an RMS detector. It displays the power of the test signal within the selected resolution bandwidth correctly, irrespective of the amplitude distribution, without additional correction factors being required.

## Channel power and adjacent-channel power (ACLR) measurement

The FSW software allows you to perform ACLR measurements on input containing multiple signals for different communication standards. A measurement standard is provided that allows you to define multiple discontinuous transmit channels at specified frequencies, independent from the selected center frequency. The ACLR measurement determines the power levels of the individual transmit, adjacent, and gap channels, as well as the total power for each sub block of transmit channels.

A detailed measurement example is provided in [Chapter 6.2.7, "Measurement examples"](#), on page 197.

## 6.2.2 Channel power results

For channel or adjacent-channel power measurements, the individual channels are indicated by different colored bars in the diagram. The height of each bar corresponds to the measured power of that channel. In addition, the name of the channel ("Adj", "Alt %1", "Tx %1", etc., or a user-defined name) is indicated above the bar (separated by a line which has no further meaning).

For "Fast ACLR" measurements, which are performed in the time domain, the power versus time is shown for each channel.



### Multi-standard radio (MSR) channel power results

The channel power results for MSR signals are described in [Chapter 6.2.3.4, "Measurement on multi-standard radio \(MSR\) signals"](#), on page 159.

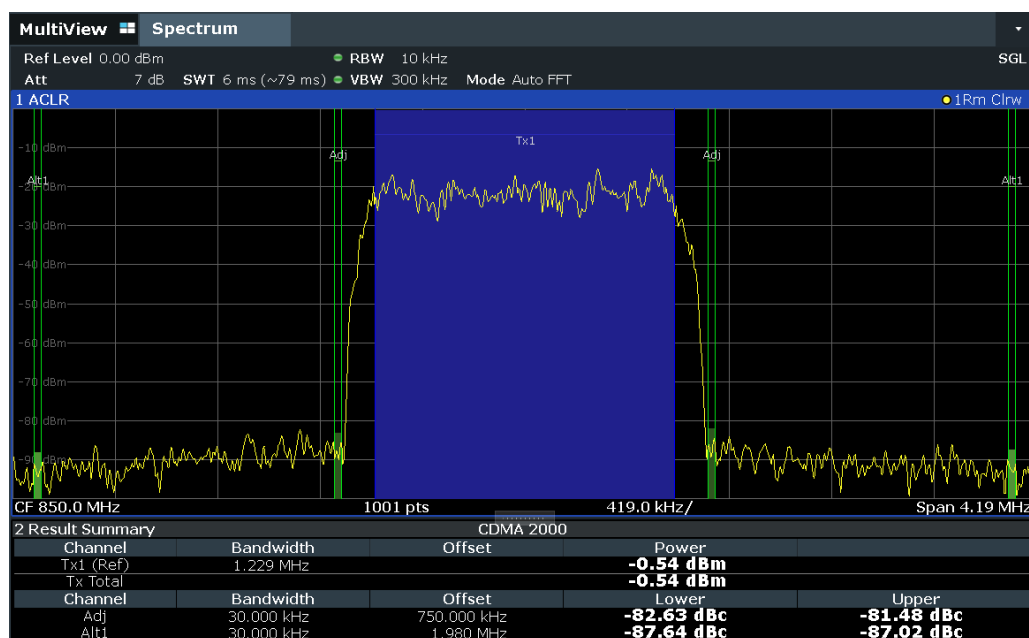

Results are provided for the TX channel and the number of defined adjacent channels *above and below* the TX channel. If more than one TX channel is defined, you must specify the channel to which the relative adjacent-channel power values refer. By default, it is the TX channel with the maximum power.

## Channel power and adjacent-channel power (ACLR) measurement

**Table 6-8: Measurements performed depending on the number of adjacent channels**

Number of adj. chan.	Measurement results
0	Channel powers
1	<ul style="list-style-type: none"> <li>Channel powers</li> <li>Power of the upper and lower adjacent channel</li> </ul>
2	<ul style="list-style-type: none"> <li>Channel powers</li> <li>Power of the upper and lower adjacent channel</li> <li>Power of the next higher and lower channel (alternate channel 1)</li> </ul>
3	<ul style="list-style-type: none"> <li>Channel powers</li> <li>Power of the upper and lower adjacent channel</li> <li>Power of the next higher and lower channel (alternate channel 1)</li> <li>Power of the second next higher and lower adjacent channel (alternate channel 2)</li> </ul>
...	...
12	<ul style="list-style-type: none"> <li>Channel powers</li> <li>Power of the upper and lower adjacent channel</li> <li>Power of all the higher and lower channels (alternate channels 1 to 11)</li> </ul>



In the FSW display, only the first neighboring channel of the carrier (TX) channel is labeled "Adj" (adjacent) channel; all others are labeled "Alt" (alternate) channels. In this manual, "Adjacent" refers to both adjacent and alternate channels.

The measured power values for the TX and adjacent channels are also output as a table in the Result Summary window. Which powers are measured depends on the number of configured channels.

For each channel, the following values are displayed:

Label	Description
Channel	Channel name as specified in the "Channel Settings" (see <a href="#">"Channel Names"</a> on page 175).
Bandwidth	Configured channel bandwidth (see <a href="#">"Channel Bandwidth"</a> on page 172)
Offset	Offset of the channel to the TX channel (configured channel spacing, see <a href="#">"Channel Bandwidth"</a> on page 172)
Power (Lower/Upper)	The measured power values for the TX and lower and upper adjacent channels. The powers of the transmission channels are output in dBm or dBm/Hz, or in dBc, relative to the specified reference TX channel.

### Retrieving Results via Remote Control

All or specific channel power measurement results can be retrieved using the `CALC:MARK:FUNC:POW:RES?` command from a remote computer (see [CALCulate<n>:MARKer<m>:FUNCTION:POWER<sb>:RESULT?](#) on page 912). Alternatively, the results can be output as channel power density, i.e. in reference to the measurement bandwidth.

Furthermore, the measured power values of the displayed trace can be retrieved as usual using the `TRAC:DATA?` commands (see [TRACe<n>\[:DATA\]](#) on page 1258). In

## Channel power and adjacent-channel power (ACLR) measurement

this case, the measured power value for each sweep point (by default 1001) is returned.

For a full list of remote commands for ACLR measurements, see [Chapter 13.5.3.10, "Retrieving and analyzing measurement results"](#), on page 968.

### 6.2.3 Channel power basics

Some background knowledge on basic terms and principles used in channel power measurements is provided here for a better understanding of the required configuration settings.

- [Measurement methods](#)..... 152
- [Measurement repeatability](#)..... 154
- [Recommended common measurement parameters](#)..... 155
- [Measurement on multi-standard radio \(MSR\) signals](#)..... 159

#### 6.2.3.1 Measurement methods

The channel power is defined as the integration of the power across the channel bandwidth.

The **Adjacent Channel Leakage Power Ratio (ACLR)** is also known as the **Adjacent Channel Power Ratio (ACPR)**. It is defined as the ratio between the total power of the adjacent channel to the power of the carrier channel. An ACLR measurement with several carrier channels (also known as transmission or TX channels) is also possible and is referred to as a *multicarrier ACLR measurement*.

There are two possible methods for measuring channel and adjacent channel power with a signal analyzer:

- **IBW method** (Integration **B**and**W**idth method)
- **Fast ACLR** (Zero-span method ), i.e. using a channel filter

##### IBW method

When measuring the channel power, the FSW integrates the linear power which corresponds to the levels of the measurement points within the selected channel. The signal analyzer uses a resolution bandwidth which is far smaller than the channel bandwidth. When sweeping over the channel, the channel filter is formed by the passband characteristics of the resolution bandwidth.



## Channel power and adjacent-channel power (ACLR) measurement

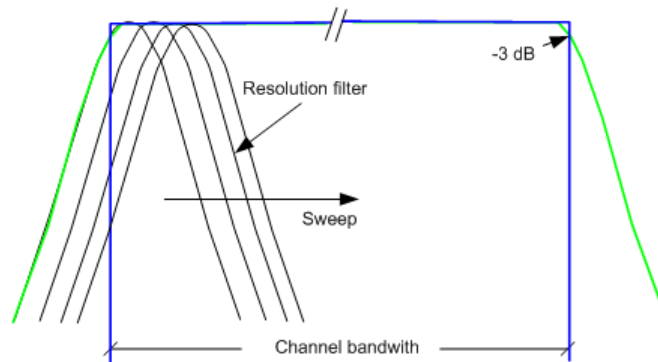

Figure 6-20: Approximating the channel filter by sweeping with a small resolution bandwidth

The following steps are performed:

1. The linear power of all the trace points within the channel is calculated.
 
$$P_i = 10^{(L_i/10)}$$
 Where  $P_i$  = power of the trace pixel  $i$   
 $L_i$  = displayed level of trace point  $i$
2. The powers of all trace points within the channel are summed up and the sum is divided by the number of trace points in the channel.
3. The result is multiplied by the quotient of the selected channel bandwidth and the noise bandwidth of the resolution filter (RBW).

Since the power calculation is performed by integrating the trace within the channel bandwidth, this method is called the IBW method (Integration Bandwidth method).

### Fast ACLR

The integrated bandwidth method (IBW) calculates channel power and ACLR from the trace data obtained during a continuous sweep over the selected span. Most parts of this sweep are not part of the channel itself or the defined adjacent channels. Therefore, most of the samples taken during the sweep time cannot be used for channel power or ACLR calculation.

To decrease the measurement times, the FSW offers a "Fast ACLR" mode. In Fast ACLR mode, the power of the frequency range between the channels of interest is not measured, because it is not required for channel power or ACLR calculation. The measurement time per channel is set with the sweep time. It is equal to the selected measurement time divided by the selected number of channels.

In the "Fast ACLR" mode, the FSW measures the power of each channel in the time domain, with the defined channel bandwidth, at the center frequency of the channel in question. The digital implementation of the resolution bandwidths makes it possible to select filter characteristics that are precisely tailored to the signal. For CDMA2000, for example, the power in the useful channel is measured with a bandwidth of 1.23 MHz. The power of the adjacent channels is measured with a bandwidth of 30 kHz. Therefore the FSW changes from one channel to the other and measures the power at a bandwidth of 1.23 MHz or 30 kHz using the RMS detector.

## Channel power and adjacent-channel power (ACLR) measurement

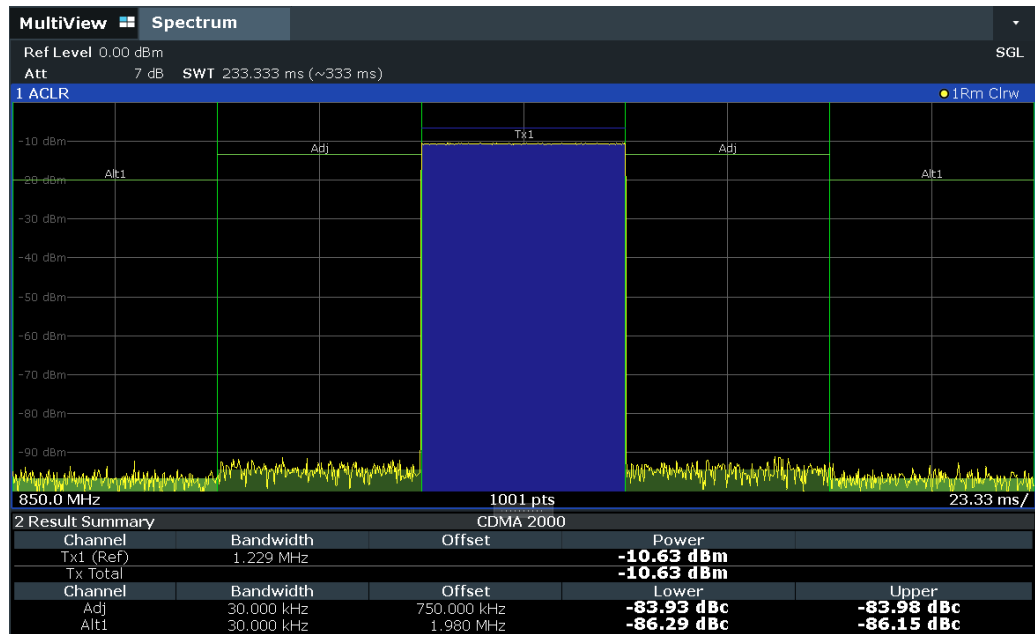

Figure 6-21: Measuring the channel power and adjacent channel power ratio for CDMA2000 signals with zero span (Fast ACLR)

### 6.2.3.2 Measurement repeatability

The repeatability of the results, especially in the narrow adjacent channels, strongly depends on the measurement time for a given resolution bandwidth. A longer sweep time can increase the probability that the measured value converges to the true value of the adjacent channel power, but obviously increases measurement time.

Assume a measurement with five channels (1 channel plus 2 lower and 2 upper adjacent channels) and a sweep time of 100 ms. This measurement requires a measurement time per channel of 20 ms. To calculate the power in one channel, the analyzer considers the following number of effective samples:

$$\langle \text{sweep time in channel} \rangle * \langle \text{selected resolution bandwidth} \rangle$$

For example, for a sweep time of 100 ms the analyzer considers  $(30 \text{ kHz} / 4.19 \text{ MHz}) * 100 \text{ ms} * 10 \text{ kHz} \approx 7$  samples. Whereas in Fast ACLR mode, it considers  $(100 \text{ ms} / 5) * 30 \text{ kHz} \approx 600$  samples. If you compare these numbers, you understand the increase of repeatability with a 95 % confidence level ( $2\sigma$ ). It rises from  $\pm 2.8 \text{ dB}$  in normal mode to  $\pm 0.34 \text{ dB}$  in Fast ACLR mode for a sweep time of 100 ms.

For the same repeatability, the integration method requires a sweep time of 8.5 s. The [Figure 6-22](#) shows the standard deviation of the results as a function of the sweep time.

Channel power and adjacent-channel power (ACLR) measurement

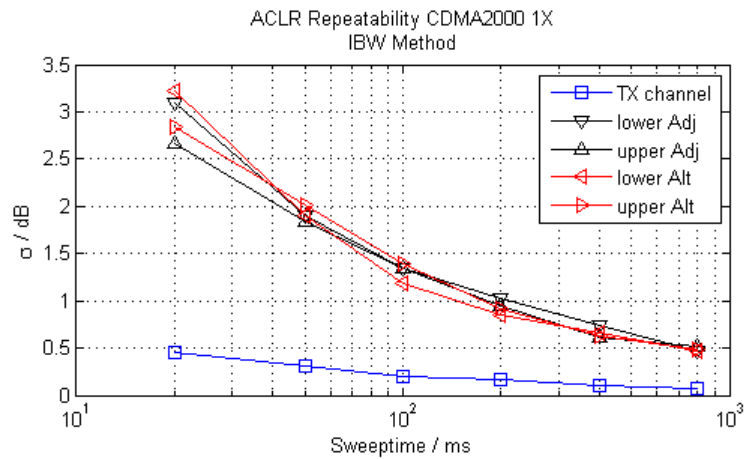

Figure 6-22: Repeatability of adjacent channel power measurement on CDMA2000 standard signals if the integration bandwidth method is used

The Figure 6-23 shows the repeatability of power measurements in the transmit channel and of relative power measurements in the adjacent channels as a function of sweep time. The standard deviation of measurement results is calculated from 100 consecutive measurements. Consider the scaling when you compare power values.

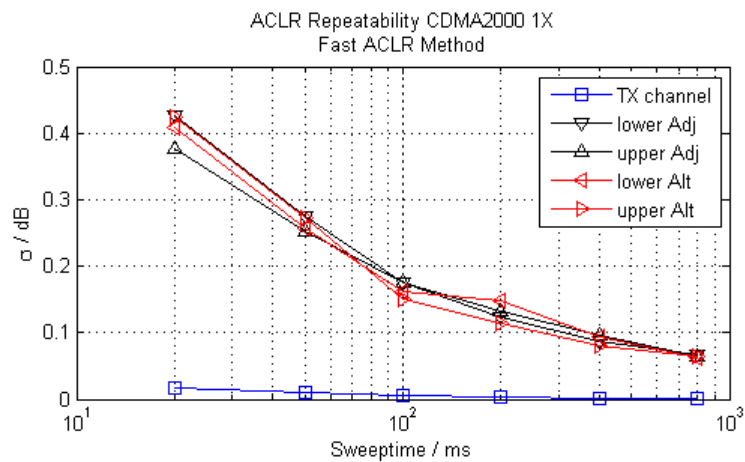

Figure 6-23: Repeatability of adjacent channel power measurements on CDMA2000 signals in the fast ACLR mode

6.2.3.3 Recommended common measurement parameters

The following sections provide recommendations on the most important measurement parameters for channel power measurements.



All instrument settings for the selected channel setup (channel bandwidth, channel spacing) can be optimized automatically using the "Adjust Settings" function (see "[Optimized Settings \(Adjust Settings\)](#)" on page 170).

The easiest way to configure a measurement is using the configuration "Overview", see [Chapter 7.1, "Configuration overview"](#), on page 357.

• <a href="#">Sweep Time</a> .....	156
• <a href="#">Frequency span</a> .....	157
• <a href="#">Resolution bandwidth (RBW)</a> .....	157
• <a href="#">Video bandwidth (VBW)</a> .....	158
• <a href="#">Detector</a> .....	158
• <a href="#">Trace averaging</a> .....	159
• <a href="#">Reference level</a> .....	159

### Sweep Time

The "Sweep Time" is selected depending on the desired reproducibility of results. Reproducibility increases with "Sweep Time" since power measurement is then performed over a longer time period. As a general approach, approximately 500 non-correlated measured values are required for a reproducibility of 0.5 dB. (That means: 95 % of the measurements are within 0.5 dB of the true measured value). Approximately 5000 measured values are required for a reproducibility of 0.1 dB (99 %). These values are valid for white noise. The measured values are considered as non-correlated if their time interval corresponds to the reciprocal of the measured bandwidth.

The number of A/D converter values, N, used to calculate the power, is defined by the "Sweep Time". The time per trace pixel for power measurements is directly proportional to the selected "Sweep Time".

If the sample detector is used, it is best to select the smallest "Sweep Time" possible for a given span and resolution bandwidth. The minimum time is obtained if the setting is coupled, that is: the time per measurement is minimal. Extending the measurement time does not have any advantages. The number of samples for calculating the power is defined by the number of trace points in the channel.

If the RMS detector is used, the selection of "Sweep Time"s can affect the repeatability of the measurement results. Repeatability is increased at longer "Sweep Time"s.

If the RMS detector is used, the number of samples can be estimated as follows:

Since only uncorrelated samples contribute to the RMS value, the number of samples can be calculated from the "Sweep Time" and the resolution bandwidth.

Samples can be assumed to be uncorrelated if sampling is performed at intervals of 1/RBW. The number of uncorrelated samples is calculated as follows:

$$N_{\text{decorr}} = \text{SWT} * \text{RBW}$$

( $N_{\text{decorr}}$  means uncorrelated samples)

The number of uncorrelated samples per trace pixel is obtained by dividing  $N_{\text{decorr}}$  by 1001 (= pixels per trace).

## Channel power and adjacent-channel power (ACLR) measurement

The "Sweep Time" can be defined using the softkey in the "Ch Power" menu or in the "Sweep" configuration dialog box (see ["Sweep Time"](#) on page 170).

### Frequency span

The frequency span must cover at least the channels to be measured plus a measurement margin of approximately 10 %.

If the frequency span is large in comparison to the channel bandwidth (or the adjacent-channel bandwidths) being analyzed, only a few points on the trace are available per channel. The calculated waveform for the used channel filter is less accurate, which has a negative effect on the measurement accuracy. It is therefore strongly recommended that you consider the described formulas when you select the frequency span.

The frequency span for the defined channel settings can be optimized. Use the "Adjust Settings" function in the "Ch Power" menu or the "General Settings" tab of the "ACLR Setup" dialog box (see ["Optimized Settings \(Adjust Settings\)"](#) on page 170). You can set the frequency span manually in the "Frequency" configuration dialog box.

(See [Chapter 7.3.4, "How to define the frequency range"](#), on page 478.)

For channel power measurements the "Adjust Settings" function sets the frequency span as follows:

*(No. of transmission channels – 1) x transmission channel spacing + 2 x transmission channel bandwidth + measurement margin*

For adjacent-channel power measurements, the "Adjust Settings" function sets the frequency span as a function of the following parameters:

- Number of transmission channels
- Transmission channel spacing
- Adjacent-channel spacing
- Bandwidth of one of adjacent-channels ADJ, ALT1 or ALT2, whichever is furthest away from the transmission channels

*(No. of transmission channels – 1) \* (transmission channel spacing + 2) \* (adjacent-channel spacing + adjacent-channel bandwidth) + measurement margin*

The measurement margin is approximately 10 % of the value obtained by adding the channel spacing and the channel bandwidth.

### Resolution bandwidth (RBW)

It is important to suppress spectral components outside the channel to be measured, especially of the adjacent channels. At the same time, you expect an acceptable measurement speed. To fulfill both these requirements, the appropriate resolution bandwidth is essential. As a general approach, set the resolution bandwidth to values between 1 % and 4 % of the channel bandwidth.

If the spectrum within the channel to be measured and the spectrum around the channel has a flat characteristic, you can select a larger resolution bandwidth. In the standard setting, e.g. for standard IS95A REV at an adjacent channel bandwidth of 30 kHz, a resolution bandwidth of 30 kHz is used. This yields correct results since the spectrum near the adjacent channels normally has a constant level.

## Channel power and adjacent-channel power (ACLR) measurement

You can optimize the resolution bandwidth for the defined channel settings. Use the "Adjust Settings" function in the "Ch Power" menu or the "General Settings" tab of the "ACLR Setup" dialog box (see ["Optimized Settings \(Adjust Settings\)"](#) on page 170). You can set the RBW manually in the "Bandwidth" configuration dialog box, see ["RBW"](#) on page 347.

Except for the IS95 CDMA standards, the "Adjust Settings" function sets the resolution bandwidth (RBW) as a function of the channel bandwidth:

$$\text{"RBW"} \leq 1/40 \text{ of "Channel Bandwidth"}$$

The maximum resolution bandwidth (concerning the requirement  $\text{RBW} \leq 1/40$ ) resulting from the available RBW steps (1, 3) is selected.

### Video bandwidth (VBW)

For a correct power measurement, the video signal must not be limited in bandwidth. A restricted bandwidth of the logarithmic video signal causes signal averaging and thus results in a too low indication of the power (-2.51 dB at very low video bandwidths). Thus, select the video bandwidth at least three times the resolution bandwidth:

$$\text{VBW} \geq 3 * \text{RBW}$$

For FFT sweeps, instead of increasing the VBW, you can also select the trace average mode "Power" to ensure correct power measurements (see ["Average Mode"](#) on page 625). Note that in power measurements this setting affects the VBW regardless of whether or not a trace is actually averaged.

The video bandwidth for the defined channel settings can be optimized. Use the "Adjust Settings" function in the "Ch Power" menu or the "General Settings" tab of the "ACLR Setup" dialog box (see ["Optimized Settings \(Adjust Settings\)"](#) on page 170). You can set the VBW manually in the "Bandwidth" configuration dialog box, see ["VBW"](#) on page 501.

The video bandwidth (VBW) is set as a function of the channel bandwidth (see formula above) and the smallest possible VBW with regard to the available step size is selected.

### Detector

The RMS detector correctly indicates the power irrespective of the characteristics of the signal to be measured.

For details, see ["RMS average detector"](#) on page 616.

In principle, the sample detector is also possible. However, due to the limited number of measurement points used to calculate the power in the channel, the sample detector yields less stable results.

You can set the RMS detector for the defined channel settings automatically. Use the "Adjust Settings" function in the "Ch Power" menu or the "General Settings" tab of the "ACLR Setup" dialog box (see ["Optimized Settings \(Adjust Settings\)"](#) on page 170).

You can set the detector manually in the "Traces" configuration dialog box, see ["Detector"](#) on page 624.

### Trace averaging

Avoid averaging, which is often performed to stabilize the measurement results but leads to a level indication that is too low. The reduction in the displayed power depends on the number of averages and the signal characteristics in the channel to be measured.

The "Adjust Settings" function switches off trace averaging. You can deactivate the trace averaging manually in the "Traces" configuration dialog box, see ["Average Mode"](#) on page 625.

### Reference level

To achieve an optimum dynamic range, set the reference level so that the signal is as close to the reference level as possible without forcing an overload message. However, if the signal-to-noise ratio becomes too small, the dynamic range is also limited. The measurement bandwidth for channel power measurements is significantly smaller than the signal bandwidth. Thus, the signal path can be overloaded although the trace is still significantly below the reference level.



Selecting a predefined standard or automatically adjusting settings does not affect the reference level. The reference level can be set automatically using the "Auto Level" function in the [Auto Set] menu, or manually in the "Amplitude" menu.

#### 6.2.3.4 Measurement on multi-standard radio (MSR) signals

Modern base stations can contain multiple signals for different communication standards. A new measurement standard is provided for the FSW ACLR measurement that allows you to measure such MSR signals, including non-contiguous setups. Multiple (also non-) contiguous transmit channels can be specified at absolute frequencies, independent from the common center frequency selected for display.

#### Signal structure

Up to 18 transmit channels can be grouped in a maximum of 8 *sub blocks*. Between two sub blocks, two gaps are defined: a *lower gap* and an *upper gap*. Each gap in turn contains two channels (*gap channels*). The channels in the upper gap are identical to those in the lower gap, but inverted. To either side of the outermost transmit channels, lower and upper adjacent channels can be defined as in common ACLR measurement setups.

Channel power and adjacent-channel power (ACLR) measurement

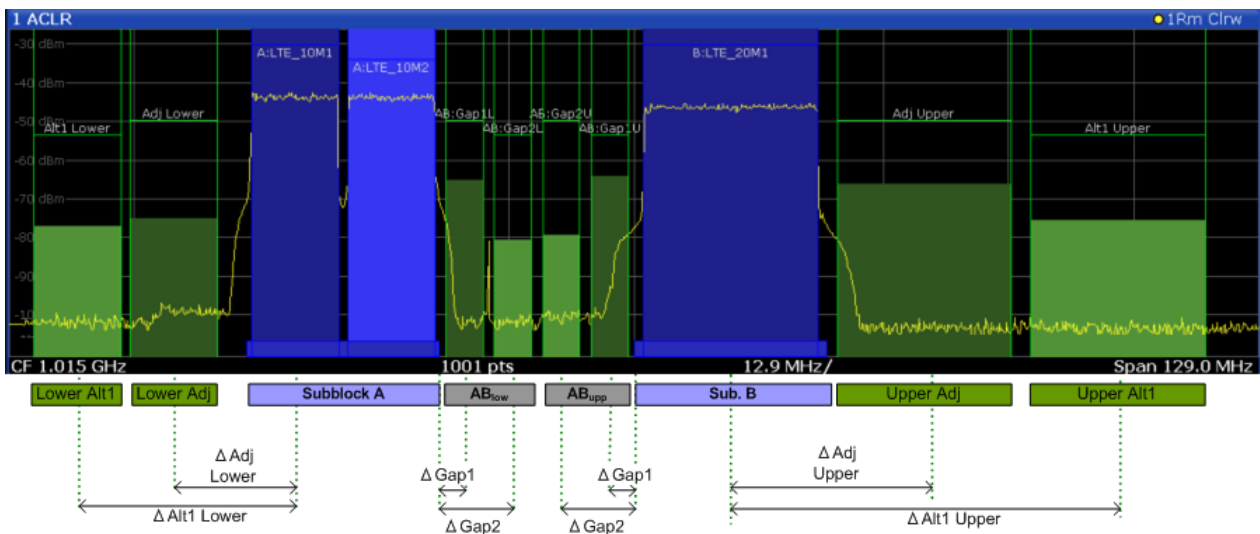

Figure 6-24: MSR signal structure

Asymmetrical gap channels

Gap channels between sub blocks can now also be asymmetrical, that is: channels in the lower and upper gaps are not identical. For example, in Figure 6-25, the gap between sub blocks A and B contains one lower channel (AB:Gap1L), but two upper channels (AB:Gap1U, AB:Gap2U). Furthermore, the gaps between different sub blocks need not be identical. For example, the gap between sub blocks A and B contains 3 gap channels, while the gap between sub blocks B and C contains only two gap channels (BC:Gap1L, BC:Gap2L, which are not identical to the lower gap channels in gap AB).

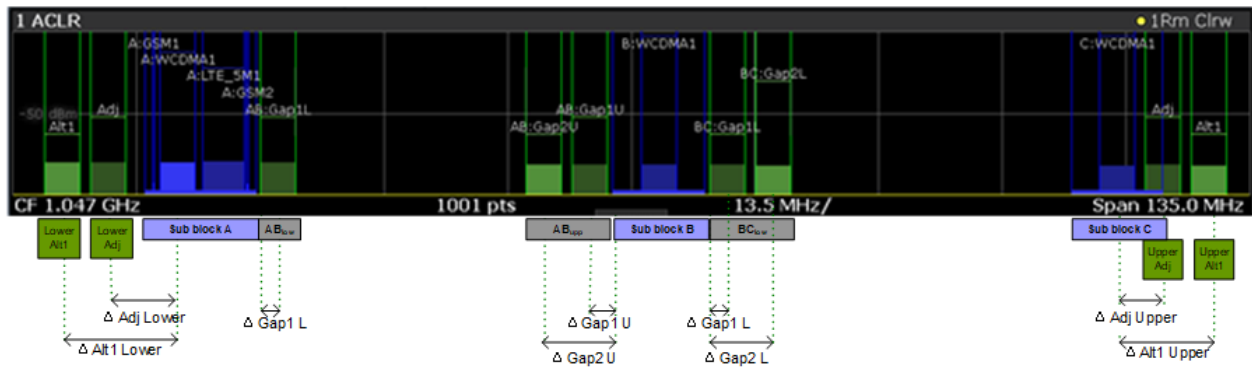

Figure 6-25: Asymmetrical MSR signal structure

Sub block and channel definition

The sub blocks are defined by a specified center frequency, RF bandwidth, and number of transmit channels.



## Channel power and adjacent-channel power (ACLR) measurement

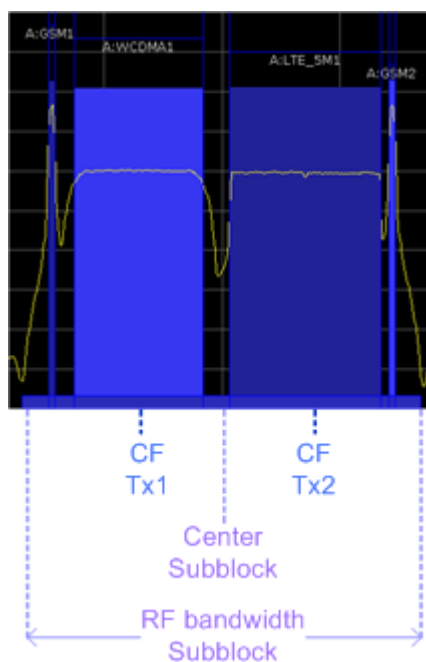

Figure 6-26: Sub block definition

As opposed to common ACLR channel definitions, the TX channels are defined at absolute frequencies, rather than by a spacing relative to the (common) center frequency. Each transmit channel can be assigned a different technology, used to predefine the required bandwidth.

#### Gap channels and CACLR

If two or more sub blocks are defined, the power in the gaps between the sub blocks must also be measured. Gap channels are defined using bandwidths and spacings, relative to the outer edges of the surrounding sub blocks.

If the upper and lower gap channels are symmetrical, only two gap channels must be configured. The required spacing can be determined according to the following formula (indicated for lower channels):

$$\text{Spacing} = [\text{CF of gap channel}] - [\text{left sub block CF}] + ([\text{RF bandwidth of left sub block}] / 2)$$

## Channel power and adjacent-channel power (ACLR) measurement

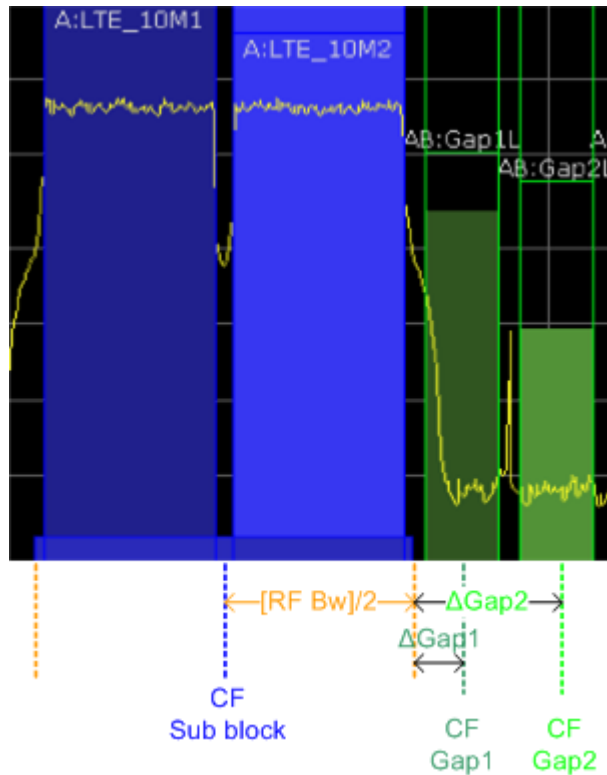

Figure 6-27: Gap channel definition for lower gap

If the gap channels are not symmetrical, you must configure up to four channels individually. The formula indicated above applies for the lower channels. For the upper channels, the spacing is defined as:

$$\text{Spacing} = [\text{right sub block CF}] - [\text{CF of gap channel}] - ([\text{RF bandwidth of right sub block}] / 2)$$

According to the MSR standard, the **Cumulative Adjacent Channel Leakage Ratio (CACLR)** power must be determined for the gap channels. The CACLR power is measured in the two gap channels for the upper and lower gap. The power in the gap channels is then set in relation to the power of the two closest transmission channels to either side of the gap. The CACLR power for the gap channels is indicated in the Result Summary.

In addition, the ACLR power for the individual gap channels is indicated in the Result Summary. The ACLR power of the lower gap channels refers to the TX channel to the left of the gap. The ACLR power of the upper gap channels refers to the TX channel to the right of the gap. A separate relative limit value can be defined for the ACLR power.

### Adjacent channels

Adjacent channels are defined as in common ACLR measurements using bandwidths and spacings, relative to the uppermost or lowermost transmit channels in the sub blocks (see also [Figure 6-24](#)):

- The spacing of the lower adjacent channels refers to the CF of the first TX channel in the first sub block.

## Channel power and adjacent-channel power (ACLR) measurement

- The spacing of the upper adjacent channels refers to the CF of the last TX channel in the last sub block.



The upper and lower adjacent channels can also be defined asymmetrically (see "[Symmetrical Adjacent Setup](#)" on page 180). This is particularly useful if the lowest TX channel and highest TX channel use different standards and thus require different bandwidths for adjacent channel power measurement.

### Channel display for MSR signals

As in common ACLR measurements, the individual channels are indicated by different colored bars in the diagram. The height of each bar corresponds to the measured power of that channel. In addition, the name of the channel is indicated above the bar. Sub blocks are named A,B,C,D,E,F,G,H and are also indicated by a slim blue bar along the frequency axis.

TX channel names correspond to the specified technology (for LTE including the bandwidth), followed by a consecutive number. (If the channel is too narrow to display the channel name, "..." is displayed instead.) The assigned sub block is indicated with the channel name, e.g. "B: LTE\_5M1" for the first TX channel in sub block B that uses the LTE 5 MHz bandwidth technology.

Adjacent and alternate channels are displayed as in common ACLR measurements.

Gap channels are indicated using the following syntax:

- The names of the surrounding sub blocks (e.g. "AB" for the gap between sub blocks A and B),
- The channel name ("Gap1" or "Gap2")
- "L" (for lower) or "U" (for upper)

For example: "ABGap1L" indicates the first lower gap channel between sub blocks A and B.

Both the lower and upper gap channels are displayed.



For symmetrical configuration, gap channels can be hidden if they do not reach a minimum size.

For asymmetrical configuration, you can define the number of upper or lower gap channels to be displayed.

In both cases, you can deactivate all gap channels. This enhances the result display, as fewer lines and bars are displayed. If gap channels are deactivated, the power results are not calculated and thus are not shown in the Result Summary table.

Furthermore, channel names for all TX, adjacent, and alternate channels are user-definable (not gap channels).

### Channel power results

The Result Summary for MSR signal measurements is similar to the table for common signals (see [Chapter 6.2.2, "Channel power results"](#), on page 150). However, the TX channel results are grouped by sub blocks, and sub block totals are provided instead

## Channel power and adjacent-channel power (ACLR) measurement

of a total TX channel power. Instead of the individual channel frequency offsets, the absolute center frequencies are indicated for the transmit channels.

The CACLR and ACLR power results for each gap channel are appended at the end of the table. The CACLR results are calculated as the power in the gap channel divided by the power sum of the two closest transmission channels to either side of it.

2 Result Summary		USER(MSR_ACLR_Example)		
Channel	Bandwidth	Frequency	Power	
A:GSM1	200.000 kHz	994.900 MHz	<b>-92.97 dBm</b>	
A:WCDMA1	3.840 MHz	997.500 MHz	<b>-80.45 dBm</b>	
A:LTE_SM1 (Ref)	4.515 MHz	1.002 GHz	<b>-79.65 dBm</b>	
A:GSM2	200.000 kHz	1.005 GHz	<b>-93.46 dBm</b>	
Sub Block A Total			<b>-76.82 dBm</b>	
Channel	Bandwidth	Frequency	Power	
B:WCDMA1	3.840 MHz	1.050 GHz	<b>-81.98 dBm</b>	
Sub Block B Total			<b>-81.98 dBm</b>	
Channel	Bandwidth	Frequency	Power	
C:WCDMA1	3.840 MHz	1.100 GHz	<b>-82.10 dBm</b>	
Sub Block C Total			<b>-82.10 dBm</b>	
Adj Channels	Bandwidth	Offset	ACLR Lower	ACLR Upper
Adj	3.840 MHz	5.000 MHz	<b>-0.74 dBc</b>	<b>-2.33 dBc</b>
Alt1	3.840 MHz	10.000 MHz	<b>-0.83 dBc</b>	<b>-2.44 dBc</b>
Gap Channels ACLR	Bandwidth	Offset	ACLR Lower	ACLR Upper
AB:Gap1	3.840 MHz	2.500 MHz	<b>13.19 dBc</b>	<b>0.04 dBc</b>
AB:Gap2	3.840 MHz	7.500 MHz	<b>13.29 dBc</b>	<b>0.05 dBc</b>
BC:Gap1	3.840 MHz	2.500 MHz	<b>-0.02 dBc</b>	<b>-0.02 dBc</b>
BC:Gap2	3.840 MHz	7.500 MHz	<b>-0.11 dBc</b>	<b>0.08 dBc</b>
Gap Channels CACLR	Bandwidth	Offset	CACLR Lower	CACLR Upper
AB:Gap1	3.840 MHz	2.500 MHz	<b>1.41 dBc</b>	<b>-0.26 dBc</b>
AB:Gap2	3.840 MHz	7.500 MHz	<b>1.52 dBc</b>	<b>-0.25 dBc</b>
BC:Gap1	3.840 MHz	2.500 MHz	<b>-2.97 dBc</b>	<b>-3.10 dBc</b>
BC:Gap2	3.840 MHz	7.500 MHz	<b>-3.06 dBc</b>	<b>-2.99 dBc</b>

Figure 6-28: Result summary for symmetrical channel definition

2 Result Summary		USER(MSR_ACLR_Example)		
Channel	Bandwidth	Frequency	Power	
A:GSM1	200.000 kHz	994.900 MHz	<b>-92.92 dBm</b>	
A:WCDMA1	3.840 MHz	997.500 MHz	<b>-80.41 dBm</b>	
A:LTE_SM1 (Ref)	4.515 MHz	1.002 GHz	<b>-79.61 dBm</b>	
A:GSM2	200.000 kHz	1.005 GHz	<b>-93.37 dBm</b>	
Sub Block A Total			<b>-76.78 dBm</b>	
Channel	Bandwidth	Frequency	Power	
B:WCDMA1	3.840 MHz	1.050 GHz	<b>-82.01 dBm</b>	
Sub Block B Total			<b>-82.01 dBm</b>	
Channel	Bandwidth	Frequency	Power	
C:WCDMA1	3.840 MHz	1.100 GHz	<b>-82.10 dBm</b>	
Sub Block C Total			<b>-82.10 dBm</b>	
Adj Channels	Bandwidth	Offset	ACLR Lower	ACLR Upper
Adj	3.840 MHz	5.000 MHz	<b>-0.77 dBc</b>	<b>-2.35 dBc</b>
Alt1	3.840 MHz	10.000 MHz	<b>-0.89 dBc</b>	<b>-2.42 dBc</b>
Gap Channels	Bandwidth	Offset	ACLR Power	CACLR Power
AB:Gap1L	3.840 MHz	2.500 MHz	<b>13.08 dBc</b>	<b>1.41 dBc</b>
AB:Gap1U	3.840 MHz	2.500 MHz	<b>0.09 dBc</b>	<b>-0.22 dBc</b>
AB:Gap2U	3.840 MHz	7.500 MHz	<b>0.09 dBc</b>	<b>-0.22 dBc</b>
BC:Gap1L	3.840 MHz	2.500 MHz	<b>0.01 dBc</b>	<b>-2.95 dBc</b>
BC:Gap2L	3.840 MHz	7.500 MHz	<b>-0.03 dBc</b>	<b>-3.00 dBc</b>

Figure 6-29: Result summary for asymmetrical channel definition

#### Remote command:

CALCulate:MARKer:FUNCTION:POWER<sb>:RESult? GACLR or  
 CALCulate:MARKer:FUNCTION:POWER<sb>:RESult? MACM, see  
[CALCulate<n>:MARKer<m>:FUNCTION:POWER<sb>:RESult?](#) on page 912

#### Restrictions and dependencies

As the signal structure in multi-standard radio signals can vary considerably, you can define the channels very flexibly for the ACLR measurement with the FSW. No checks or limitations are implemented concerning the channel definitions, apart from the maximum number of channels to be defined. Thus, you are not notified if transmit channels for a specific sub block lie outside the defined frequency range for the sub block, or if transmit and gap channels overlap.

### 6.2.4 Channel power configuration

**Access:** "Overview" > "Select Measurement" > "Channel Power ACLR" > "CP / ACLR Config"

Both Channel Power (CP) and Adjacent-Channel Power (ACLR) measurements are available.



If the "Multi-Standard Radio" standard is selected (see "Standard" on page 166), the "ACLR Setup" dialog box is replaced by the "MSR ACLR Setup" dialog box. See [Chapter 6.2.5, "MSR ACLR configuration"](#), on page 175 for a description of these settings.

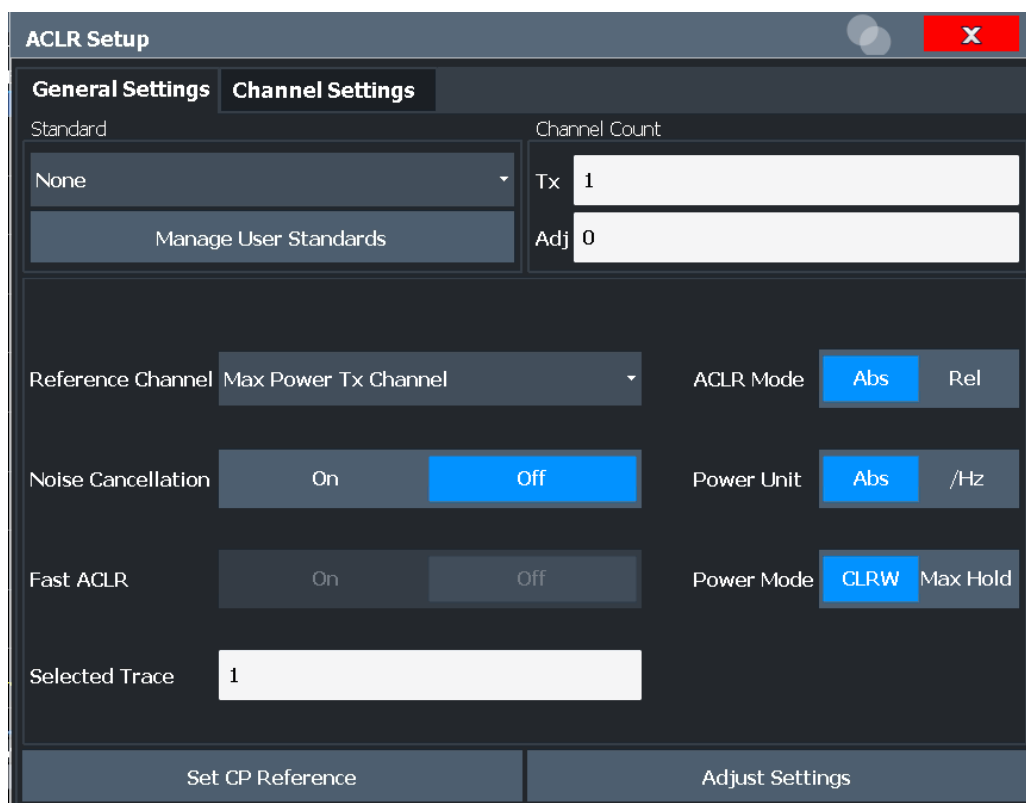

The remote commands required to perform these tasks are described in [Chapter 13.5.3, "Measuring the channel power and ACLR"](#), on page 915.

- [General CP/ACLR measurement settings](#)..... 165
- [Channel setup](#)..... 171

#### 6.2.4.1 General CP/ACLR measurement settings

General measurement settings are defined in the "ACLR Setup" dialog, in the "General Settings" tab.

- [Standard](#).....166
  - └ [Predefined Standards](#)..... 166
  - └ [User Standards](#)..... 166

## Channel power and adjacent-channel power (ACLR) measurement

Number of channels: Tx, Adj.....	167
Reference Channel.....	168
Noise Cancellation.....	168
Fast ACLR.....	169
Selected Trace.....	169
Absolute and Relative Values (ACLR Mode).....	169
Channel power level and density (Power Unit).....	169
Power Mode.....	170
Setting a fixed reference for Channel Power measurements (Set CP Reference).....	170
Optimized Settings (Adjust Settings).....	170
Sweep Time.....	170

**Standard**

The main measurement settings can be stored as a standard file. When such a standard is loaded, the required channel and general measurement settings are automatically set on the FSW. However, the settings can be changed. Predefined standards are available for standard measurements, but standard files with user-defined configurations can also be created.

**Note:** If the "Multi-Standard Radio" standard is selected, the "ACLR Setup" dialog box is replaced by the "MSR ACLR Setup" dialog box (see [Chapter 6.2.5, "MSR ACLR configuration"](#), on page 175).

If any other predefined standard (or "NONE") is selected, the "ACLR Setup" dialog box is restored (see [Chapter 6.2.4, "Channel power configuration"](#), on page 165).

Note that changes in the configuration are not stored when the dialog boxes are exchanged.

**Predefined Standards ← Standard**

Predefined standards contain the main measurement settings for standard measurements. When such a standard is loaded, the required channel settings are automatically set on the FSW. However, you can change the settings.

The predefined standards contain the following settings:

- Channel bandwidths
- Channel spacings
- Detector
- Trace Average setting
- Resolution Bandwidth (RBW)
- Weighting Filter

For details on the available standards, see [Chapter 6.2.9, "Reference: predefined CP/ACLR standards"](#), on page 204.

Remote command:

`CALCulate<n>:MARKer<m>:FUNCTION:POWer<sb>:PRESet` on page 916

**User Standards ← Standard**

**Access:** "CP / ACLR Config" > "General Settings" tab > "Manage User Standards"

## Channel power and adjacent-channel power (ACLR) measurement

In addition to the predefined standards, you can save your own standards with your specific measurement settings in an XML file so you can use them again later. User-defined standards are stored on the instrument in the

C:\Program Files (x86)\Rohde-Schwarz\FSW\<version>\acp\_std directory.

A sample file is provided for an MSR ACLR measurement (MSR\_ACLRExample.xml). It sets up the measurement for the MSR signal generator waveform described in the file C:\R\_S\INSTR\USER\waveform\MSRA\_GSM\_WCDMA\_LTE\_GSM.wv.

Note that ACLR user standards are not supported for Fast ACLR measurements.

**Note:** User standards created on an analyzer of the R&S FSP family are compatible to the FSW. User standards created on an FSW, however, are not necessarily compatible to the analyzers of the R&S FSP family and may not work there.

The following parameter definitions are saved in a user-defined standard:

- Number of adjacent channels
- Channel bandwidth of transmission (Tx), adjacent (Adj) and alternate (Alt) channels
- Channel spacings
- Weighting filters
- Resolution bandwidth
- Video bandwidth
- Detector
- ACLR limits and their state
- "Sweep Time" and "Sweep Time" coupling
- Trace and power mode
- (MSR only: sub block and gap channel definition)

Save the current measurement settings as a user-defined standard, load a stored measurement configuration, or delete an existing configuration file.

For details see [Chapter 6.2.6.4, "How to manage user-defined configurations"](#), on page 196.

Remote command:

To query all available standards:

`CALCulate<n>:MARKer<m>:FUNCTION:POWer<sb>:STANdard:CATalog?`  
on page 916

To load a standard:

`CALCulate<n>:MARKer<m>:FUNCTION:POWer<sb>:PRESet` on page 916

To save a standard:

`CALCulate<n>:MARKer<m>:FUNCTION:POWer<sb>:STANdard:SAVE`  
on page 917

To delete a standard:

`CALCulate<n>:MARKer<m>:FUNCTION:POWer<sb>:STANdard:DELeTe`  
on page 917

#### Number of channels: Tx, Adj

Up to 18 carrier channels and up to 12 adjacent channels can be defined.

## Channel power and adjacent-channel power (ACLR) measurement

Results are provided for the Tx channel and the number of defined adjacent channels *above and below* the Tx channel. If more than one Tx channel is defined, the carrier channel to which the relative adjacent-channel power values should be referenced must be defined (see ["Reference Channel"](#) on page 168).

**Note:** If several carriers (Tx channels) are activated for the measurement, the number of sweep points is increased to ensure that adjacent-channel powers are measured with adequate accuracy.

For more information on how the number of channels affects the measured powers, see [Chapter 6.2.2, "Channel power results"](#), on page 150.

Remote command:

Number of Tx channels:

[\[SENSe:\]POWer:ACHannel:TXChannel:COUNT](#) on page 922

Number of Adjacent channels:

[\[SENSe:\]POWer:ACHannel:ACPairs](#) on page 918

### Reference Channel

The measured power values in the adjacent channels can be displayed relative to the transmission channel. If more than one Tx channel is defined, define which one is used as a reference channel.

Tx Channel 1	Transmission channel 1 is used. (Not available for MSR ACLR)
Min Power Tx Channel	The transmission channel with the lowest power is used as a reference channel.
Max Power Tx Channel	The transmission channel with the highest power is used as a reference channel (Default).
Lowest & Highest Channel	The outer left-hand transmission channel is the reference channel for the lower adjacent channels, the outer right-hand transmission channel that for the upper adjacent channels.

Remote command:

[\[SENSe:\]POWer:ACHannel:REference:TXChannel:MANual](#) on page 925

[\[SENSe:\]POWer:ACHannel:REference:TXChannel:AUTO](#) on page 925

### Noise Cancellation

The FSW can correct the results by removing the inherent noise of the analyzer, which increases the dynamic range.

In this case, a reference measurement of the inherent noise of the analyzer is carried out. The measured noise power is then subtracted from the power in the channel that is being analyzed (first active trace only).

The inherent noise of the instrument depends on the selected center frequency, resolution bandwidth and level setting. Therefore, the correction function is disabled whenever one of these parameters is changed. A disable message is displayed on the screen. To enable the correction function after changing one of these settings, activate it again. A new reference measurement is carried out.

Noise cancellation is also available in zero span.

For an active external frontend, noise cancellation is not available. See ["External Frontend Connection State"](#) on page 450.



## Channel power and adjacent-channel power (ACLR) measurement

Currently, noise cancellation is only available for the following trace detectors (see "Detector" on page 624):

- RMS
- Average
- Sample
- Positive peak

Remote command:

[\[SENSe:\] POWER:NCORrection](#) on page 1208

### Fast ACLR

If activated, instead of using the IBW method, the FSW sets the center frequency to the different channel center frequencies consecutively and measures the power with the selected measurement time (= sweep time/number of channels).

Remote command:

[\[SENSe:\] POWER:HSPeed](#) on page 937

### Selected Trace

The CP/ACLR measurement can be performed on any active trace.

Remote command:

[\[SENSe:\] POWER:TRACe](#) on page 915

### Absolute and Relative Values (ACLR Mode)

The powers of the adjacent channels are output in dBm or dBm/Hz (absolute values), or in dBc, relative to the specified reference Tx channel.

"Abs"                    The absolute power in the adjacent channels is displayed in the unit of the y-axis, e.g. in dBm, dBμV.

"Rel"                    The level of the adjacent channels is displayed relative to the level of the transmission channel in dBc.

Remote command:

[\[SENSe:\] POWER:ACHannel:MODE](#) on page 971

### Channel power level and density (Power Unit)

By default, the channel power is displayed in absolute values. If "/Hz" or "/MHz" is activated, the channel power density is displayed instead. Thus, the absolute unit of the channel power is switched from dBm to dBm/Hz or dBm/MHz.

**Note:** The channel power density in dBm/Hz corresponds to the power inside a bandwidth of 1 Hz and is calculated as follows:

"channel power density = channel power – log<sub>10</sub>(channel bandwidth)"

Thus you can measure the signal/noise power density, for example, or use the additional functions [Absolute and Relative Values \(ACLR Mode\)](#) and [Reference Channel](#) to obtain the signal to noise ratio.

Remote command:

[CALCulate<n>:MARKer<m>:FUNCTION:POWER<sb>:RESULT:PHZ](#) on page 970

[CALCulate<n>:MARKer<m>:FUNCTION:POWER<sb>:RESULT:UNIT](#) on page 970

## Channel power and adjacent-channel power (ACLR) measurement

**Power Mode**

The measured power values can be displayed directly for each trace ("Clear/ Write"), or only the maximum values over a series of measurements can be displayed ("Max Hold"). In the latter case, the power values are calculated from the current trace and compared with the previous power value using a maximum algorithm. The higher value is retained. If "Max Hold" mode is activated, "Pwr Max" is indicated in the table header. Note that the *trace* mode remains unaffected by this setting.

Remote command:

`CALCulate<n>:MARKer<m>:FUNCTION:POWER<sb>:MODE` on page 911

**Setting a fixed reference for Channel Power measurements (Set CP Reference)**

If only one TX channel and no adjacent channels are defined, the currently measured channel power can be used as a fixed reference value for subsequent channel power measurements.

When you select this button, the channel power currently measured on the TX channel is stored as a fixed reference power. In the following channel power measurements, the power is indicated relative to the fixed reference power. The reference value is displayed in the "Reference" field (in relative ACLR mode); the default value is 0 dBm.

**Note:** In adjacent-channel power measurement, the power is always referenced to a transmission channel (see "Reference Channel" on page 168), thus, this function is not available.

Remote command:

`[SENSe:]POWER:ACHannel:REFERENCE:AUTO ONCE` on page 924

**Optimized Settings (Adjust Settings)**

All instrument settings for the selected channel setup (channel bandwidth, channel spacing) can be optimized automatically.

The adjustment is carried out only once. If necessary, the instrument settings can be changed later.

The following settings are optimized by "Adjust Settings":

- "Frequency span" on page 157
- "Resolution bandwidth (RBW)" on page 157
- "Video bandwidth (VBW)" on page 158
- "Detector" on page 158
- "Trace averaging" on page 159

**Note:** The reference level is not affected by this function. To adjust the reference level automatically, use the [Setting the Reference Level Automatically \(Auto Level\)](#) function in the [Auto Set] menu.

Remote command:

`[SENSe:]POWER:ACHannel:PRESet` on page 914

**Sweep Time**

With the RMS detector, a longer "Sweep Time" increases the stability of the measurement results. For recommendations on setting this parameter, see ["Sweep Time"](#) on page 156.

The "Sweep Time" can be set via the softkey in the "Ch Power" menu and is identical to the general setting in the "Sweep" configuration dialog box.

## Channel power and adjacent-channel power (ACLR) measurement

Remote command:

[SENSe:] SWEep:TIME on page 1204

#### 6.2.4.2 Channel setup

The "Channel Settings" tab in the "ACLR Setup" dialog box provides all the channel settings to configure the channel power or ACLR measurement. You can define the channel settings for all channels, independent of the defined number of *used* TX or adjacent channels (see "Number of channels: Tx, Adj" on page 167).

For details on setting up channels, see Chapter 6.2.6.2, "How to set up the channels", on page 193.



In addition to the specific channel settings, the general settings "Standard" on page 166 and "Number of channels: Tx, Adj" on page 167 are also available in this tab.

The following settings are available in individual subtabs of the "Channel Settings" tab.

Channel Bandwidth.....	172
Channel Spacings.....	172
Limit Check.....	173
Total Limit Pass Mode.....	174
Weighting Filters.....	175
Channel Names.....	175

## Channel power and adjacent-channel power (ACLR) measurement

## Channel Bandwidth

**ACLR Setup**

**General Settings** | **Channel Settings**

Standard: EUTRA/LTE Square  
 Channel Count: Tx 1, Adj 2

Manage User Standards

**Bandwidths** | Spacing | Limits | Weighting Filters | Names

Tx Channels		Adjacent Channels	
Tx 1	9.015 MHz	Adj	9.015 MHz
Tx 2	9.015 MHz	Alt 1	9.015 MHz
Tx 3	9.015 MHz	Alt 2	9.015 MHz
Tx 4	9.015 MHz	Alt 3	9.015 MHz
Tx 5	9.015 MHz	Alt 4	9.015 MHz
Tx 6	9.015 MHz	Alt 5	9.015 MHz
Tx 7	9.015 MHz	Alt 6	9.015 MHz
Tx 8	9.015 MHz	Alt 7	9.015 MHz

The Tx channel bandwidth is normally defined by the transmission standard.

The correct bandwidth is set automatically for the selected standard. The bandwidth for each channel is indicated by a colored bar in the display.

For measurements that require channel bandwidths which deviate from those defined in the selected standard, use the IBW method ("Fast ACLR" "Off"). With the IBW method, the channel bandwidth borders are right and left of the channel center frequency. Thus, you can visually check whether the entire power of the signal under test is within the selected channel bandwidth.

The value entered for any Tx channel is automatically also defined for all subsequent Tx channels. Thus, only enter one value if all Tx channels have the same bandwidth.

The value entered for any ADJ or ALT channel is automatically also defined for all alternate (ALT) channels. Thus, only enter one value if all adjacent channels have the same bandwidth.

Remote command:

[\[SENSe:\] POWER:ACHannel:BANDwidth\[:CHANnel<ch>\]](#) on page 919

[\[SENSe:\] POWER:ACHannel:BANDwidth:ACHannel](#) on page 918

[\[SENSe:\] POWER:ACHannel:BANDwidth:ALternate<ch>](#) on page 919

### Channel Spacings

Channel spacings are normally defined by the transmission standard but can be changed.

## Channel power and adjacent-channel power (ACLR) measurement

If the spacings are not equal, the channel distribution in relation to the center frequency is as follows:

Odd number of Tx channels	The middle Tx channel is centered to center frequency.
Even number of Tx channels	The two Tx channels in the middle are used to calculate the frequency between those two channels. This frequency is aligned to the center frequency.

The spacings between all Tx channels can be defined individually. When you change the spacing for one channel, the value is automatically also defined for all subsequent Tx channels. This allows you to set up a system with equal Tx channel spacing quickly. For different spacings, set up the channels from top to bottom.

Tx1-2	Spacing between the first and the second carrier
Tx2-3	Spacing between the second and the third carrier
...	...

If you change the adjacent-channel spacing (ADJ), all higher adjacent channel spacings (ALT1, ALT2, ...) are multiplied by the same factor (new spacing value/old spacing value). Again, only enter one value for equal channel spacing. For different spacing, configure the spacings from top to bottom.

For details, see [Chapter 6.2.6.2, "How to set up the channels"](#), on page 193

Remote command:

[SENSe:] POWER:ACHannel:SPACing:CHANnel<ch> on page 921

[SENSe:] POWER:ACHannel:SPACing[:ACHannel] on page 920

[SENSe:] POWER:ACHannel:SPACing:ALternate<ch> on page 921

### Limit Check

During an ACLR measurement, the power values can be checked whether they exceed user-defined or standard-defined limits. A relative or absolute limit can be defined, or both. Both limit types are considered, regardless whether the measured levels are absolute or relative values. The check of both limit values can be activated independently. If any active limit value is exceeded, the measured value is displayed in red and marked by a preceding asterisk in the result table.

2 Result Summary			Tx Power 30.54 dBm		Tx Bandwidth 3.840 MHz		W-CDMA 3GPP DL	
Range Low	Range Up	RBW	Frequency	Power Abs	Power Rel	ΔLimit		
-12.750 MHz	-8.000 MHz	1.000 MHz	2.09053 GHz	-40.68 dBm	-71.22 dB	-17.18 dB		
-8.000 MHz	-4.000 MHz	1.000 MHz	2.09268 GHz	-40.13 dBm	-70.67 dB	-20.63 dB		
-4.000 MHz	-3.515 MHz	30.000 kHz	2.09647 GHz	-52.60 dBm	-83.14 dB	-20.10 dB		
-3.515 MHz	-2.715 MHz	30.000 kHz	2.09652 GHz	-54.30 dBm	-84.84 dB	-22.38 dB		
-2.715 MHz	-2.515 MHz	30.000 kHz	2.09728 GHz	-51.51 dBm	-82.05 dB	-31.01 dB		
-2.515 MHz	2.715 MHz	30.000 kHz	2.10270 GHz	-54.13 dBm	-84.67 dB	-33.63 dB		
2.715 MHz	3.515 MHz	30.000 kHz	2.10290 GHz*	-47.29 dBm*	-67.83 dB*	7.27 dB*		
3.515 MHz	4.000 MHz	30.000 kHz	2.10355 GHz	-51.94 dBm	-82.48 dB	-19.44 dB		
4.000 MHz	8.000 MHz	1.000 MHz	2.10725 GHz	-40.01 dBm	-70.55 dB	-20.51 dB		
8.000 MHz	12.750 MHz	1.000 MHz	2.10911 GHz	-40.26 dBm	-70.82 dB	-16.78 dB		

The results of the power limit checks are also indicated in the STAT:QUES:ACPL status registry (see [Chapter 12.2.2.6, "STATus:QUESTIONable:ACPLimit register"](#), on page 829).

Remote command:

CALCulate<n>:LIMit<li>:ACPower[:STATe] on page 932

CALCulate<n>:LIMit<li>:ACPower:ACHannel:ABSolute:STATe on page 926

## Channel power and adjacent-channel power (ACLR) measurement

[CALCulate<n>:LIMit<li>:ACPoweR:ACHannel:ABSolute](#) on page 926

[CALCulate<n>:LIMit<li>:ACPoweR:ACHannel\[:RELative\]:STATE](#)  
on page 928

[CALCulate<n>:LIMit<li>:ACPoweR:ACHannel\[:RELative\]](#) on page 927

[CALCulate<n>:LIMit<li>:ACPoweR:ALTernate<ch>:ABSolute:STATE](#)  
on page 929

[CALCulate<n>:LIMit<li>:ACPoweR:ALTernate<ch>:ABSolute](#) on page 929

[CALCulate<n>:LIMit<li>:ACPoweR:ALTernate<ch>\[:RELative\]:STATE](#)  
on page 931

[CALCulate<n>:LIMit<li>:ACPoweR:ALTernate<ch>\[:RELative\]](#)  
on page 930

[CALCulate<n>:LIMit<li>:ACPoweR:ACHannel:RESult?](#) on page 927

### Total Limit Pass Mode

Supported only by the LTE and 5G application.

**Access** (ACLR measurement): "Meas Config" > "CP / ACLR Config" > "Channel Settings" > "Limits"

**Access** (multi-carrier ACLR measurement): "Meas Config" > "CP / ACLR Config" > "MSR General Settings"

The "Total Limit Pass Mode" selects the logic the ACLR limits are evaluated with if you define both absolute limits and relative limits.

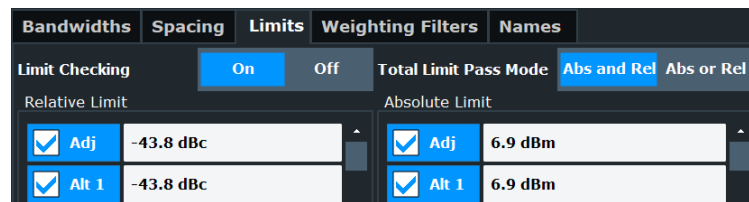

Figure 6-30: Evaluate both absolute and relative limits

If you define only relative or absolute limits, the FSW only evaluates the corresponding limits.

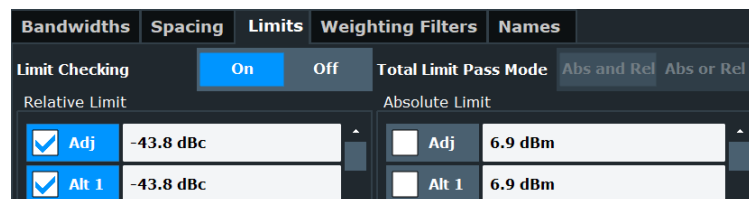

Figure 6-31: Evaluate only relative limits

If you change the limit evaluation method after the measurement, you have to refresh the measurement.

The selected method adjusts the contents of the following result displays.

- ACLR result summary

The default value is according to 3GPP 38.141-1/2.

"Absolute" Checks the absolute limits defined for the ACLR. The limit check passes when the signal level is within the absolute limits.

## Channel power and adjacent-channel power (ACLR) measurement

"Relative"	Checks the relative limits defined for the ACLR. The limit check passes when the signal level is within the relative limits.
"Absolute and Relative"	The limit check for both, the absolute and the relative limits, must pass to get an overall pass.
"Absolute or Relative"	The limit check for either the absolute or the relative limits must pass to get an overall pass.

Remote command:

[CALCulate<n>:LIMit<li>:ACPower:PMODE](#) on page 931

### Weighting Filters

Weighting filters allow you to determine the influence of individual channels on the total measurement result. For each channel you can activate or deactivate the use of the weighting filter and define an individual weighting factor ("Alpha:" value).

Weighting filters are not available for all supported standards and cannot always be defined manually where they are available.

Remote command:

Activating/Deactivating:

[\[SENSe:\] POWER:ACHannel:FILTer\[:STATe\]:CHANnel<ch>](#) on page 924

[\[SENSe:\] POWER:ACHannel:FILTer\[:STATe\]:ACHannel](#) on page 923

[\[SENSe:\] POWER:ACHannel:FILTer\[:STATe\]:ALternate<ch>](#) on page 924

Alpha value:

[\[SENSe:\] POWER:ACHannel:FILTer:ALPHa:CHANnel<ch>](#) on page 923

[\[SENSe:\] POWER:ACHannel:FILTer:ALPHa:ACHannel](#) on page 922

[\[SENSe:\] POWER:ACHannel:FILTer:ALPHa:ALternate<ch>](#) on page 922

### Channel Names

In the FSW's display, carrier channels are labeled "Tx" by default; the first neighboring channel is labeled "Adj" (adjacent) channel; all others are labeled "Alt" (alternate) channels. You can define user-specific channel names for each channel which are displayed in the result diagram and result table.

Remote command:

[\[SENSe:\] POWER:ACHannel:NAME:ACHannel](#) on page 919

[\[SENSe:\] POWER:ACHannel:NAME:ALternate<ch>](#) on page 920

[\[SENSe:\] POWER:ACHannel:NAME:CHANnel<ch>](#) on page 920

## 6.2.5 MSR ACLR configuration

**Access:** "Overview" > "Select Measurement" > "Channel Power ACLR" > "CP / ACLR Standard" > "Standard": "Multi-Standard Radio" > "CP / ACLR Config"

ACLR measurements can also be performed on input containing multiple signals for different communication standards. A new measurement standard is provided that allows you to define multiple discontinuous transmit channels at specified frequencies, independent from the selected center frequency. If the "Multi-Standard Radio" standard is selected (see "[Standard](#)" on page 166), the "ACLR Setup" dialog box is replaced by the "MSR ACLR Setup" dialog box.

## Channel power and adjacent-channel power (ACLR) measurement

For more information, see [Chapter 6.2.3.4, "Measurement on multi-standard radio \(MSR\) signals"](#), on page 159.

The remote commands required to perform these tasks are described in [Chapter 13.5.3, "Measuring the channel power and ACLR"](#), on page 915.

- [General MSR ACLR measurement settings](#)..... 176
- [MSR sub block and TX channel definition](#)..... 181
- [MSR adjacent channel setup](#)..... 184
- [MSR gap channel setup](#)..... 187
- [MSR channel names](#)..... 191

### 6.2.5.1 General MSR ACLR measurement settings

**Access:** "Overview" > "Select Measurement" > "Channel Power ACLR" > "CP / ACLR Standard" > "Standard": "Multi-Standard Radio" > "CP / ACLR Config" > "MSR General Settings" tab

Standard.....	177
L Predefined Standards.....	177
L User Standards.....	177
Number of Sub Blocks.....	178
Reference Channel.....	178
Noise Cancellation.....	179
Selected Trace.....	179
Absolute and Relative Values (ACLR Mode).....	179
Channel power level and density (Power Unit).....	180
Power Mode.....	180
Optimized Settings (Adjust Settings).....	180
Symmetrical Adjacent Setup.....	180
Limit Checking.....	181



## Channel power and adjacent-channel power (ACLR) measurement

**Standard**

The main measurement settings can be stored as a standard file. When such a standard is loaded, the required channel and general measurement settings are automatically set on the FSW. However, the settings can be changed. Predefined standards are available for standard measurements, but standard files with user-defined configurations can also be created.

**Note:** If the "Multi-Standard Radio" standard is selected, the "ACLR Setup" dialog box is replaced by the "MSR ACLR Setup" dialog box (see [Chapter 6.2.5, "MSR ACLR configuration"](#), on page 175).

If any other predefined standard (or "NONE") is selected, the "ACLR Setup" dialog box is restored (see [Chapter 6.2.4, "Channel power configuration"](#), on page 165).

Note that changes in the configuration are not stored when the dialog boxes are exchanged.

**Predefined Standards ← Standard**

Predefined standards contain the main measurement settings for standard measurements. When such a standard is loaded, the required channel settings are automatically set on the FSW. However, you can change the settings.

The predefined standards contain the following settings:

- Channel bandwidths
- Channel spacings
- Detector
- Trace Average setting
- Resolution Bandwidth (RBW)
- Weighting Filter

For details on the available standards, see [Chapter 6.2.9, "Reference: predefined CP/ACLR standards"](#), on page 204.

Remote command:

`CALCulate<n>:MARKer<m>:FUNCTION:POWER<sb>:PRESet` on page 916

**User Standards ← Standard**

**Access:** "CP / ACLR Config" > "General Settings" tab > "Manage User Standards"

In addition to the predefined standards, you can save your own standards with your specific measurement settings in an XML file so you can use them again later. User-defined standards are stored on the instrument in the

`C:\Program Files (x86)\Rohde-Schwarz\FSW\<version>\acp_std` directory.

A sample file is provided for an MSR ACLR measurement (`MSR_ACLRExample.xml`). It sets up the measurement for the MSR signal generator waveform described in the file `C:\R_S\INSTR\USER\waveform\MSRA_GSM_WCDMA_LTE_GSM.wv`.

Note that ACLR user standards are not supported for Fast ACLR measurements.

**Note:** User standards created on an analyzer of the R&S FSP family are compatible to the FSW. User standards created on an FSW, however, are not necessarily compatible to the analyzers of the R&S FSP family and may not work there.

The following parameter definitions are saved in a user-defined standard:

- Number of adjacent channels

## Channel power and adjacent-channel power (ACLR) measurement

- Channel bandwidth of transmission (Tx), adjacent (Adj) and alternate (Alt) channels
- Channel spacings
- Weighting filters
- Resolution bandwidth
- Video bandwidth
- Detector
- ACLR limits and their state
- "Sweep Time" and "Sweep Time" coupling
- Trace and power mode
- (MSR only: sub block and gap channel definition)

Save the current measurement settings as a user-defined standard, load a stored measurement configuration, or delete an existing configuration file.

For details see [Chapter 6.2.6.4, "How to manage user-defined configurations"](#), on page 196.

Remote command:

To query all available standards:

`CALCulate<n>:MARKer<m>:FUNCTION:POWER<sb>:STANDARD:CATALOG?`

on page 916

To load a standard:

`CALCulate<n>:MARKer<m>:FUNCTION:POWER<sb>:PRESet` on page 916

To save a standard:

`CALCulate<n>:MARKer<m>:FUNCTION:POWER<sb>:STANDARD:SAVE`

on page 917

To delete a standard:

`CALCulate<n>:MARKer<m>:FUNCTION:POWER<sb>:STANDARD:DELETE`

on page 917

### Number of Sub Blocks

Defines the number of sub blocks, i.e. groups of transmission channels in an MSR signal.

For more information, see [Chapter 6.2.3.4, "Measurement on multi-standard radio \(MSR\) signals"](#), on page 159.

Remote command:

`[SENSE:] POWER:ACHannel:SBCount` on page 939

### Reference Channel

The measured power values in the adjacent channels can be displayed relative to the transmission channel. If more than one Tx channel is defined, define which one is used as a reference channel.

Tx Channel 1	Transmission channel 1 is used. (Not available for MSR ACLR)
Min Power Tx Channel	The transmission channel with the lowest power is used as a reference channel.

## Channel power and adjacent-channel power (ACLR) measurement

Max Power Tx Channel	The transmission channel with the highest power is used as a reference channel (Default).
Lowest & Highest Channel	The outer left-hand transmission channel is the reference channel for the lower adjacent channels, the outer right-hand transmission channel that for the upper adjacent channels.

Remote command:

[\[SENSe:\]POWER:ACHannel:REference:TXChannel:MANual](#) on page 925

[\[SENSe:\]POWER:ACHannel:REference:TXChannel:AUTO](#) on page 925

### Noise Cancellation

The FSW can correct the results by removing the inherent noise of the analyzer, which increases the dynamic range.

In this case, a reference measurement of the inherent noise of the analyzer is carried out. The measured noise power is then subtracted from the power in the channel that is being analyzed (first active trace only).

The inherent noise of the instrument depends on the selected center frequency, resolution bandwidth and level setting. Therefore, the correction function is disabled whenever one of these parameters is changed. A disable message is displayed on the screen. To enable the correction function after changing one of these settings, activate it again. A new reference measurement is carried out.

Noise cancellation is also available in zero span.

For an active external frontend, noise cancellation is not available. See "[External Frontend Connection State](#)" on page 450.

Currently, noise cancellation is only available for the following trace detectors (see "[Detector](#)" on page 624):

- RMS
- Average
- Sample
- Positive peak

Remote command:

[\[SENSe:\]POWER:NCORrection](#) on page 1208

### Selected Trace

The CP/ACLR measurement can be performed on any active trace.

Remote command:

[\[SENSe:\]POWER:TRACe](#) on page 915

### Absolute and Relative Values (ACLR Mode)

The powers of the adjacent channels are output in dBm or dBm/Hz (absolute values), or in dBc, relative to the specified reference Tx channel.

"Abs"                    The absolute power in the adjacent channels is displayed in the unit of the y-axis, e.g. in dBm, dB $\mu$ V.

"Rel"                    The level of the adjacent channels is displayed relative to the level of the transmission channel in dBc.

## Channel power and adjacent-channel power (ACLR) measurement

Remote command:

[\[SENSe:\] POWER:ACHannel:MODE](#) on page 971

### Channel power level and density (Power Unit)

By default, the channel power is displayed in absolute values. If "/Hz" or "/MHz" is activated, the channel power density is displayed instead. Thus, the absolute unit of the channel power is switched from dBm to dBm/Hz or dBm/MHz.

**Note:** The channel power density in dBm/Hz corresponds to the power inside a bandwidth of 1 Hz and is calculated as follows:

"channel power density = channel power – log<sub>10</sub>(channel bandwidth)"

Thus you can measure the signal/noise power density, for example, or use the additional functions [Absolute and Relative Values \(ACLR Mode\)](#) and [Reference Channel](#) to obtain the signal to noise ratio.

Remote command:

[CALCulate<n>:MARKer<m>:FUNCTION:POWER<sb>:RESULT:PHZ](#) on page 970

[CALCulate<n>:MARKer<m>:FUNCTION:POWER<sb>:RESULT:UNIT](#) on page 970

### Power Mode

The measured power values can be displayed directly for each trace ("Clear/ Write"), or only the maximum values over a series of measurements can be displayed ("Max Hold"). In the latter case, the power values are calculated from the current trace and compared with the previous power value using a maximum algorithm. The higher value is retained. If "Max Hold" mode is activated, "Pwr Max" is indicated in the table header. Note that the *trace* mode remains unaffected by this setting.

Remote command:

[CALCulate<n>:MARKer<m>:FUNCTION:POWER<sb>:MODE](#) on page 911

### Optimized Settings (Adjust Settings)

All instrument settings for the selected channel setup (channel bandwidth, channel spacing) can be optimized automatically.

The adjustment is carried out only once. If necessary, the instrument settings can be changed later.

The following settings are optimized by "Adjust Settings":

- ["Frequency span"](#) on page 157
- ["Resolution bandwidth \(RBW\)"](#) on page 157
- ["Video bandwidth \(VBW\)"](#) on page 158
- ["Detector"](#) on page 158
- ["Trace averaging"](#) on page 159

**Note:** The reference level is not affected by this function. To adjust the reference level automatically, use the [Setting the Reference Level Automatically \(Auto Level\)](#) function in the [Auto Set] menu.

Remote command:

[\[SENSe:\] POWER:ACHannel:PRESet](#) on page 914

### Symmetrical Adjacent Setup

If enabled, the upper and lower adjacent and alternate channels are defined symmetrically. This is the default behavior.

## Channel power and adjacent-channel power (ACLR) measurement

If disabled, the upper and lower channels can be configured differently. This is particularly useful if the lowest TX channel and highest TX channel use different standards and thus require different bandwidths for adjacent channel power measurement.

Remote command:

[SENSe:]POWER:ACHannel:SSETup on page 943

### Limit Checking

Activates or deactivates limit checks globally for all adjacent and gap channels. In addition to this setting, limits must be defined and activated individually for each channel.

The results of the power limit checks are also indicated in the STAT:QUES:ACPL status registry (see [Chapter 12.2.2.6, "STATus:QUESTIONable:ACPLimit register"](#), on page 829).

Remote command:

CALCulate<n>:LIMit<li>:ACPower[:STATe] on page 932

### 6.2.5.2 MSR sub block and TX channel definition

**Access:** "Overview" > "Select Measurement" > "Channel Power ACLR" > "CP / ACLR Standard" > "Standard": "Multi-Standard Radio" > "CP / ACLR Config" > "Tx Channels" tab

The "Tx Channels" tab provides all the channel settings to configure sub blocks and TX channels in MSR ACLR measurements.

	Center	Technology	Bandwidth	Weighting Filter
Tx 1	980.0 MHz	LTE_10_00	9.015 MHz	<input type="checkbox"/>
Tx 2	990.0 MHz	LTE_10_00	9.015 MHz	<input type="checkbox"/>
Tx 3	1.96 GHz	WCDMA	3.84 MHz	<input checked="" type="checkbox"/>
Tx 4	1.96 GHz	WCDMA	3.84 MHz	<input checked="" type="checkbox"/>
Tx 5	1.96 GHz	WCDMA	3.84 MHz	<input checked="" type="checkbox"/>
Tx 6	1.96 GHz	WCDMA	3.84 MHz	<input checked="" type="checkbox"/>
Tx 7	1.96 GHz	WCDMA	3.84 MHz	<input checked="" type="checkbox"/>
Tx 8	1.96 GHz	WCDMA	3.84 MHz	<input checked="" type="checkbox"/>
Tx 9	1.96 GHz	WCDMA	3.84 MHz	<input checked="" type="checkbox"/>

## Channel power and adjacent-channel power (ACLR) measurement

For details on MSR signals, see [Chapter 6.2.3.4, "Measurement on multi-standard radio \(MSR\) signals"](#), on page 159.

For details on setting up channels, see [Chapter 6.2.6.3, "How to configure an MSR ACLR measurement"](#), on page 194.

The TX channel settings for the individual sub blocks are configured in individual sub-tabs of the "Tx Channel Settings" tab.

Sub Block Definition.....	182
L Sub Block / Center Freq.....	182
L RF Bandwidth.....	182
L Number of Tx Channels (Tx Count).....	182
Tx Channel Definition.....	182
L Tx Center Frequency.....	183
L Technology Used for Transmission.....	183
L Tx Channel Bandwidth.....	183
L Weighting Filters.....	183

### Sub Block Definition

Sub blocks are groups of transmit channels in an MSR signal. Up to 8 sub blocks can be defined. They are defined as an RF bandwidth around a center frequency with a specific number of transmit channels (max. 18).

Sub blocks are named A,B,C,D,E,F,G,H and are indicated by a slim blue bar along the frequency axis.

#### Sub Block / Center Freq ← Sub Block Definition

Defines the center of an MSR sub block. Note that the position of the sub block also affects the position of the adjacent gap channels.

Remote command:

`[SENSe:] POWER:ACHannel:SBLOCK<sb>:FREQUENCY:CENTer` on page 941

#### RF Bandwidth ← Sub Block Definition

Defines the bandwidth of the individual MSR sub block. Note that sub block ranges also affect the position of the adjacent gap channels.

Remote command:

`[SENSe:] POWER:ACHannel:SBLOCK<sb>:RFBWidth` on page 941

#### Number of Tx Channels (Tx Count) ← Sub Block Definition

Defines the number of transmit channels the specific sub block contains. The maximum is 18 TX channels.

Remote command:

`[SENSe:] POWER:ACHannel:SBLOCK<sb>:TXChannel:COUNT` on page 942

### Tx Channel Definition

As opposed to common ACLR channel definitions, the TX channels are defined at absolute frequencies, rather than by a spacing relative to the (common) center frequency. Each transmit channel can be assigned a different technology, used to pre-define the required bandwidth.

## Channel power and adjacent-channel power (ACLR) measurement

The TX channel settings for the individual sub blocks are configured in individual sub-tabs of the "Tx Channel Settings" tab.

For details on configuring MSR TX channels, see [Chapter 6.2.6.3, "How to configure an MSR ACLR measurement"](#), on page 194.

Remote command:

`[SENSe:] POWER:ACHannel:SBLOCK<sb>:NAME[:CHANnel<ch>]` on page 967

#### **Tx Center Frequency ← Tx Channel Definition**

Defines the (absolute) center frequency of an MSR TX channel. Each TX channel is defined independently of the others; automatic spacing as in common ACLR measurements is not performed.

Note that the position of the adjacent channels is also affected by:

- The position of the first TX channel in the first sub block
- The position of last TX channel in the last sub block

Remote command:

`[SENSe:] POWER:ACHannel:SBLOCK<sb>:CENTer[:CHANnel<ch>]` on page 940

#### **Technology Used for Transmission ← Tx Channel Definition**

The technology used for transmission by the individual channel can be defined for each channel. The required channel bandwidth and use of a weighting filter are pre-configured automatically according to the selected technology standard.

"GSM"	Transmission according to GSM standard
"W-CDMA"	Transmission according to W-CDMA standard
"LTE_xxx"	Transmission according to LTE standard for different channel bandwidths
"USER"	User-defined transmission; no automatic preconfiguration possible

Remote command:

`[SENSe:] POWER:ACHannel:SBLOCK<sb>:TECHnology[:CHANnel<ch>]`  
on page 942

#### **Tx Channel Bandwidth ← Tx Channel Definition**

The TX channel bandwidth is normally defined by the transmission technology standard. The correct bandwidth is predefined automatically for the selected technology. Each TX channel is defined independently of the others; automatic bandwidth configuration for subsequent channels as in common ACLR measurements is not performed.

The bandwidth for each channel is indicated by a colored bar in the display.

Remote command:

`[SENSe:] POWER:ACHannel:SBLOCK<sb>:BANDwidth[:CHANnel<ch>]`  
on page 940

#### **Weighting Filters ← Tx Channel Definition**

Weighting filters allow you to determine the influence of individual channels on the total measurement result. For each channel, you can activate or deactivate the use of the weighting filter and define an individual weighting factor ("Alpha:" value).

## Channel power and adjacent-channel power (ACLR) measurement

Remote command:

Activating/Deactivating:

[SENSe:] POWer:ACHannel:FILTer[:STATe]:SBLock<sb>:CHANnel<ch>

on page 939

Alpha value:

[SENSe:] POWer:ACHannel:FILTer:ALPHa:SBLock<sb>:CHANnel<ch>

on page 939

### 6.2.5.3 MSR adjacent channel setup

**Access:** "Overview" > "Select Measurement" > "Channel Power ACLR" > "CP / ACLR Standard" > "Standard": "Multi-Standard Radio" > "CP / ACLR Config" > "Adjacent Channels" tab

The "Adjacent Channels" tab provides all the channel settings to configure adjacent and gap channels in MSR ACLR measurements.



For symmetrical channel definition (see "[Symmetrical Adjacent Setup](#)" on page 180), the dialog box is reduced as the upper and lower channels are identical.

	Spacing	Bandwidth	Weighting Filter	Relative Limit	Absolute Limit
<b>Adjacent</b>					
Lower	5.0 MHz	3.84 MHz	<input checked="" type="checkbox"/>	220.0 m	<input checked="" type="checkbox"/> -44.2 dBc
Upper	5.0 MHz	3.84 MHz	<input checked="" type="checkbox"/>	220.0 m	<input checked="" type="checkbox"/> -44.2 dBc
<b>Alternate 1</b>					
Lower	10.0 MHz	3.84 MHz	<input checked="" type="checkbox"/>	220.0 m	<input checked="" type="checkbox"/> -49.2 dBc
Upper	10.0 MHz	3.84 MHz	<input checked="" type="checkbox"/>	220.0 m	<input checked="" type="checkbox"/> -49.2 dBc
<b>Alternate 2</b>					
Lower	15.0 MHz	3.84 MHz	<input checked="" type="checkbox"/>	220.0 m	<input type="checkbox"/> 0.0 dBc
Upper	15.0 MHz	3.84 MHz	<input checked="" type="checkbox"/>	220.0 m	<input type="checkbox"/> 0.0 dBc

Figure 6-32: Asymmetrical adjacent channel definition

For details on setting up channels, see [Chapter 6.2.6.3, "How to configure an MSR ACLR measurement"](#), on page 194.



## Channel power and adjacent-channel power (ACLR) measurement

Number of Adjacent Channels (Adj Count).....	185
Adjacent Channel Definition.....	185
L Adjacent Channel Spacings.....	185
L Adjacent Channel Bandwidths.....	185
L Weighting Filters.....	186
L Limit Checking.....	186

**Number of Adjacent Channels (Adj Count)**

Defines the number of adjacent channels *above and below* the TX channel block in an MSR signal. You must define the carrier channel to which the relative adjacent-channel power values refer (see "[Reference Channel](#)" on page 168).

Remote command:

`[SENSe:]POWer:ACHannel:ACPairs` on page 918

**Adjacent Channel Definition**

Defines the channels adjacent to the transmission channel block in MSR signals. A maximum of 12 adjacent channels can be defined.

For MSR signals, adjacent channels are defined in relation to the center frequency of the first and last transmission channel in the entire block, i.e.:

- The lower adjacent channels are defined in relation to the CF of the first TX channel in the first sub block.
- The upper adjacent channels are defined in relation to the CF of the last TX channel in the last sub block.

Adjacent channels are named "Adj" and "Alt1" to "Alt11" by default; the names can be changed manually (see [Chapter 6.2.5.5, "MSR channel names"](#), on page 191).

In all other respects, channel definition is identical to common ACLR measurements.

**Adjacent Channel Spacings ← Adjacent Channel Definition**

Channel spacings are normally predefined by the selected technology but can be changed.

For MSR signals, adjacent channels are defined in relation to the center frequency of the first and last transmission channel in the entire block, i.e.:

- The spacing of the lower adjacent channels refers to the CF of the first TX channel in the first sub block.
- The spacing of the upper adjacent channels refers to the CF of the last TX channel in the last sub block.

For details, see [Chapter 6.2.6.3, "How to configure an MSR ACLR measurement"](#), on page 194

Remote command:

`[SENSe:]POWer:ACHannel:SPACing[:ACHannel]` on page 920

`[SENSe:]POWer:ACHannel:SPACing:ALTernate<ch>` on page 921

`[SENSe:]POWer:ACHannel:SPACing:UACHannel` on page 943

`[SENSe:]POWer:ACHannel:SPACing:UALTernate<ch>` on page 943

**Adjacent Channel Bandwidths ← Adjacent Channel Definition**

The adjacent channel bandwidth is normally predefined by the transmission technology standard. The correct bandwidth is set automatically for the selected technology. The bandwidth for each channel is indicated by a colored bar in the display.

## Channel power and adjacent-channel power (ACLR) measurement

Remote command:

[SENSe:] POWER:ACHannel:BANDwidth:ACHannel on page 918  
 [SENSe:] POWER:ACHannel:BANDwidth:ALternate<ch> on page 919  
 [SENSe:] POWER:ACHannel:BANDwidth:UACHannel on page 944  
 [SENSe:] POWER:ACHannel:BANDwidth:UALternate<ch> on page 944

**Weighting Filters ← Adjacent Channel Definition**

Weighting filters allow you to determine the influence of individual channels on the total measurement result. For each channel, you can activate or deactivate the use of the weighting filter and define an individual weighting factor ("Alpha:" value).

Remote command:

Activating/Deactivating:

[SENSe:] POWER:ACHannel:FILTer[:STATe]:ACHannel on page 923  
 [SENSe:] POWER:ACHannel:FILTer[:STATe]:ALternate<ch> on page 924  
 [SENSe:] POWER:ACHannel:FILTer[:STATe]:UACHannel on page 945  
 [SENSe:] POWER:ACHannel:FILTer[:STATe]:UALternate<ch> on page 945

Alpha value:

[SENSe:] POWER:ACHannel:FILTer:ALPHa:ACHannel on page 922  
 [SENSe:] POWER:ACHannel:FILTer:ALPHa:ALternate<ch> on page 922  
 [SENSe:] POWER:ACHannel:FILTer:ALPHa:UACHannel on page 945  
 [SENSe:] POWER:ACHannel:FILTer:ALPHa:UALternate<ch> on page 945

**Limit Checking ← Adjacent Channel Definition**

During an ACLR measurement, the power values can be checked whether they exceed user-defined or standard-defined limits. A relative or absolute limit can be defined, or both, for each individual adjacent channel. Both limit types are considered, regardless whether the measured levels are absolute or relative values. The check of both limit values can be activated independently. If any active limit value is exceeded, the measured value is displayed in red and marked by a preceding asterisk in the result table.

Note that in addition to activating limit checking for individual channels, limit checking must also be activated globally for the MSR ACLR measurement (see "Limit Checking" on page 181).

2 Result Summary		Multi-Standard Radio		
Channel	Bandwidth	Frequency	Power	
B:GSM2	200.000 kHz	1.020 GHz	<b>-80.44 dBm</b>	
Sub Block 8 Total			<b>-29.15 dBm</b>	
Channel	Bandwidth	Offset	Lower	Upper
Adj*	3.840 MHz	5.000 MHz	<b>-33.27 dB *</b>	<b>-32.63 dB *</b>
Alt1	3.840 MHz	10.000 MHz	<b>-49.76 dB</b>	<b>-50.37 dB</b>

Remote command:

CALCulate<n>:LIMit<li>:ACPoweR[:STATe] on page 932  
 CALCulate<n>:LIMit<li>:ACPoweR:ACHannel:ABSolute:STATe on page 926  
 CALCulate<n>:LIMit<li>:ACPoweR:ACHannel:ABSolute on page 926  
 CALCulate<n>:LIMit<li>:ACPoweR:ACHannel[:RELative]:STATe on page 928  
 CALCulate<n>:LIMit<li>:ACPoweR:ACHannel[:RELative] on page 927  
 CALCulate<n>:LIMit<li>:ACPoweR:ALternate<ch>:ABSolute:STATe on page 929  
 CALCulate<n>:LIMit<li>:ACPoweR:ALternate<ch>:ABSolute on page 929

## Channel power and adjacent-channel power (ACLR) measurement

[CALCulate<n>:LIMit<li>:ACPower:ALternate<ch>\[:RELative\]:STATE](#)  
on page 931

[CALCulate<n>:LIMit<li>:ACPower:ALternate<ch>\[:RELative\]](#)  
on page 930

[CALCulate<n>:LIMit<li>:ACPower:ACHannel:RESult?](#) on page 927

#### 6.2.5.4 MSR gap channel setup

**Access:** "Overview" > "Select Measurement" > "Channel Power ACLR" > "CP / ACLR Standard" > "Standard": "Multi-Standard Radio" > "CP / ACLR Config" > "Gap Channels" tab

The "Gap Channels" tab provides all the channel settings to configure gap channels in MSR ACLR measurements.

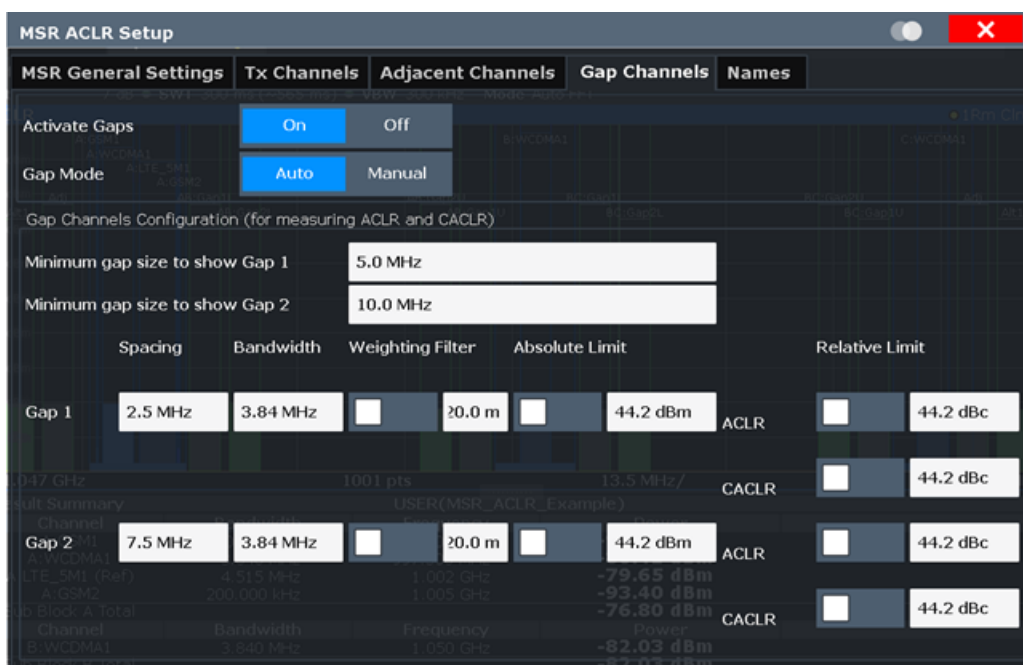

Figure 6-33: Symmetrical (auto) gap channel configuration

Channel power and adjacent-channel power (ACLR) measurement

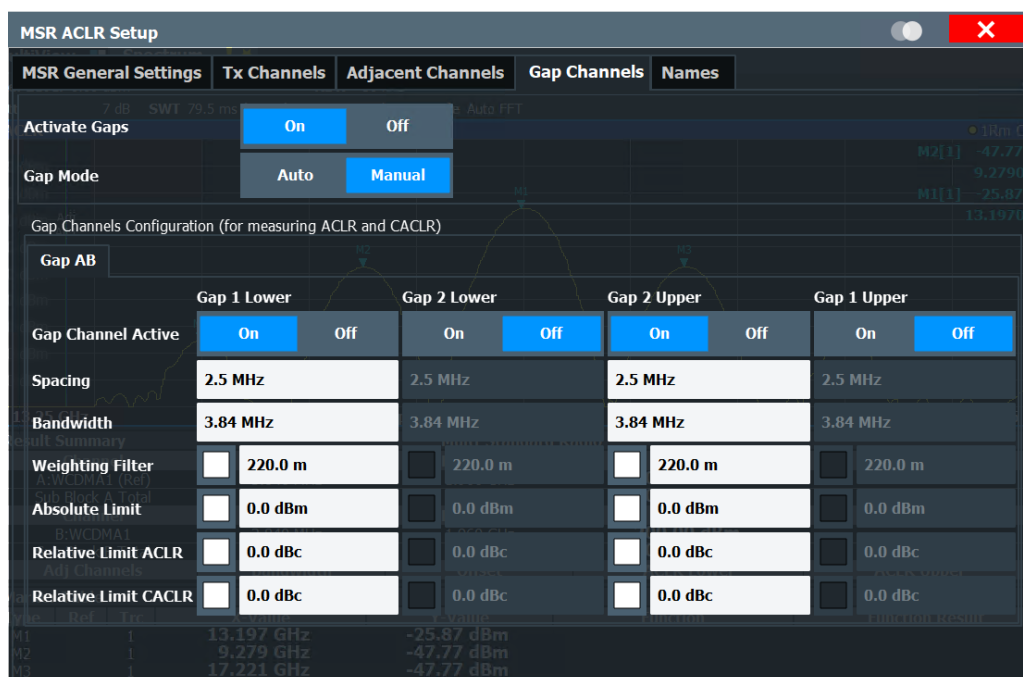

Figure 6-34: Asymmetrical (manual) gap channel configuration

For details on MSR signals, see [Chapter 6.2.3.4, "Measurement on multi-standard radio \(MSR\) signals"](#), on page 159.

For details on setting up channels, see [Chapter 6.2.6.3, "How to configure an MSR ACLR measurement"](#), on page 194.

- Activate Gaps..... 188
- Gap Mode..... 188
- Gap Channel Definition..... 189
  - └ Minimum gap size to show Gap 1/ Minimum gap size to show Gap 2..... 189
  - └ Gap Channel Active..... 189
  - └ Gap Channel Spacing..... 189
  - └ Gap Channel Bandwidths..... 190
  - └ Weighting Filters..... 191
  - └ Limit Checking..... 191

**Activate Gaps**

If enabled, the gap channels are displayed and channel power results are calculated and displayed in the Result Summary.

Remote command:

`[SENSe:] POWer:ACHannel:AGChannels` on page 946

**Gap Mode**

In "Auto" mode, upper and lower gap channels are configured identically, so only two channels need to be configured (gap 1, gap 2). Gap channels are configured identically for all gaps, if more than two sub blocks are defined. Depending on the defined minimum gap size, the actual number of evaluated gap channels is determined automatically.

## Channel power and adjacent-channel power (ACLR) measurement

In "Manual" mode, up to four channels can be configured individually for each gap. If enabled, the configured gap channels are always evaluated, regardless of the gap size.

Remote command:

`[SENSe:] POWER:ACHannel:GAP<gap>:MODE` on page 946

### Gap Channel Definition

Between two sub blocks in an MSR signal, two gaps are defined: a *lower gap* and an *upper gap*. Each gap in turn can contain two channels, the *gap channels*.

By default ("Auto" gap mode, see "Gap Mode" on page 188), the channels in the upper gap are assumed to be identical to those in the lower gap, but inverted. Thus, you only have to configure two gap channels in the FSW MSR ACLR measurement. All other gap channels are configured automatically.

In manual gap mode, you can define up to four different gap channels per gap individually. Each gap is configured on a separate subtab. Only gaps between defined sub blocks are available. If only one sub block is defined, gap channels cannot be defined manually.

Gap channels are indicated using the following syntax:

- The names of the surrounding sub blocks (e.g. "AB" for the gap between sub blocks A and B)
- The channel name ("Gap1" or "Gap2")
- "L" (for lower) or "U" (for upper)

### Minimum gap size to show Gap 1/ Minimum gap size to show Gap 2 ← Gap Channel Definition

If the gap between the sub blocks does not exceed the specified bandwidth, the gap channels are not displayed in the diagram. The gap channel results are not calculated in the result summary.

This command is only available for symmetrical gap channels in "Auto" gap mode (see "Gap Mode" on page 188).

Remote command:

`[SENSe:] POWER:ACHannel:GAP<gap>[:AUTO]:MSIZE` on page 951

### Gap Channel Active ← Gap Channel Definition

Defines which gap channels are active in the specified gap for asymmetrical (manual) configuration of gap channels.

Remote command:

`[SENSe:] POWER:ACHannel:GChannel[:STATE]:GAP<gap>:MANual:LOWer`  
on page 964

`[SENSe:] POWER:ACHannel:GChannel[:STATE]:GAP<gap>:MANual:UPPer`  
on page 964

### Gap Channel Spacing ← Gap Channel Definition

Gap channel spacings are normally predefined by the MSR standard but can be changed.

Gap channels are defined using bandwidths and spacings, relative to the outer edges of the surrounding sub blocks.

## Channel power and adjacent-channel power (ACLR) measurement

The required spacing can be determined according to the following formula (indicated for lower channels):

$$\text{Spacing} = [\text{CF of gap channel}] - [\text{left sub block CF}] + ([\text{RF bandwidth of left sub block}] / 2)$$

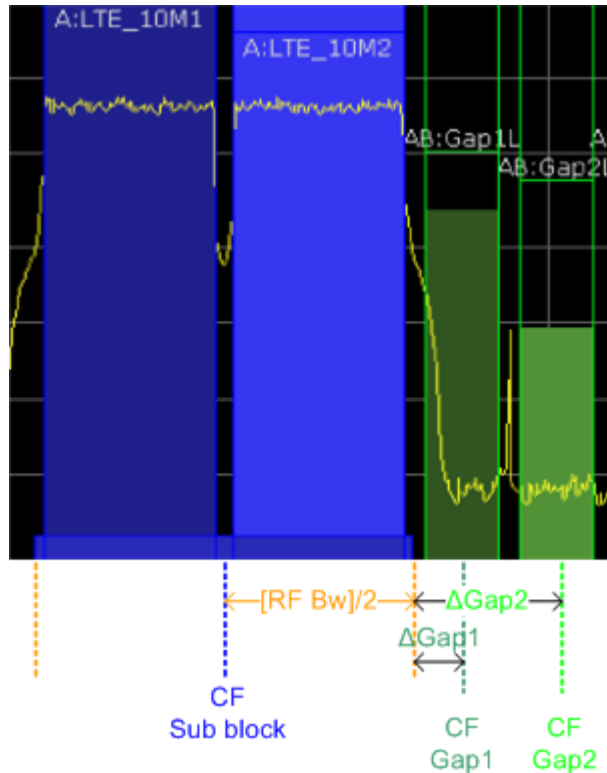

Figure 6-35: Gap channel definition for lower gap

For details, see [Chapter 6.2.6.3, "How to configure an MSR ACLR measurement"](#), on page 194.

Remote command:

`[SENSe:]POWer:ACHannel:SPACing:GAP<gap>[:AUTO]` on page 951

For manual (asymmetrical) configuration:

`[SENSe:]POWer:ACHannel:SPACing:GAP<gap>:MANual:LOWer` on page 965

`[SENSe:]POWer:ACHannel:SPACing:GAP<gap>:MANual:UPPer` on page 965

### Gap Channel Bandwidths ← Gap Channel Definition

The gap channel bandwidth is normally predefined by the transmission technology standard. The correct bandwidth is set automatically for the selected technology. The bandwidth for each channel is indicated by a colored bar in the display (if the gap is not too narrow, see ["Channel display for MSR signals"](#) on page 163).

Remote command:

`[SENSe:]POWer:ACHannel:BANDwidth:GAP<gap>[:AUTO]` on page 950

For manual (asymmetrical) configuration:

`[SENSe:]POWer:ACHannel:BANDwidth:GAP<gap>:MANual:LOWer` on page 960

`[SENSe:]POWer:ACHannel:BANDwidth:GAP<gap>:MANual:UPPer` on page 961

## Channel power and adjacent-channel power (ACLR) measurement

**Weighting Filters ← Gap Channel Definition**

Weighting filters allow you to determine the influence of individual channels on the total measurement result. For each channel, you can activate or deactivate the use of the weighting filter and define an individual weighting factor ("Alpha:" value).

Remote command:

`[SENSe:]POWer:ACHannel:FILTer[:STATe]:GAP<gap>[:AUTO]` on page 951

`[SENSe:]POWer:ACHannel:FILTer:ALPHa:GAP<gap>[:AUTO]` on page 950

For manual (asymmetrical) configuration:

`[SENSe:]POWer:ACHannel:FILTer[:STATe]:GAP<gap>:MANual:LOWer`  
on page 961

`[SENSe:]POWer:ACHannel:FILTer[:STATe]:GAP<gap>:MANual:UPPer`  
on page 962

`[SENSe:]POWer:ACHannel:FILTer:ALPHa:GAP<gap>:MANual:LOWer`  
on page 963

`[SENSe:]POWer:ACHannel:FILTer:ALPHa:GAP<gap>:MANual:UPPer`  
on page 963

**Limit Checking ← Gap Channel Definition**

During an ACLR measurement, the power values can be checked whether they exceed user-defined or standard-defined limits. A relative or absolute limit can be defined, or both, for each individual gap channel. Both limit types are considered, regardless whether the measured levels are absolute or relative values. The check of both limit values can be activated independently. Furthermore, relative limits can be defined and activated individually for ACLR or CACLR power levels.

If any active limit value is exceeded, the measured value is displayed in red and marked by a preceding asterisk in the result table.

Note that in addition to activating limit checking for individual channels, limit checking must also be activated globally for the MSR ACLR measurement (see "[Limit Checking](#)" on page 181).

Remote command:

["Automatic \(symmetrical\) configuration"](#) on page 947

**6.2.5.5 MSR channel names**

**Access:** "Overview" > "Select Measurement" > "Channel Power ACLR" > "CP / ACLR Standard" > "Standard": "Multi-Standard Radio" > "CP / ACLR Config" > "Names" tab

Channel names for all TX, adjacent, and alternate channels are user-definable.

In the "Names" tab, you can define a customized name for each channel in each sub block. Note that the names are not checked for uniqueness.

## Channel power and adjacent-channel power (ACLR) measurement

Tx	SB A	SB B
Tx 1	A:LTE_10M1	
Tx 2	A:LTE_10M2	
Tx 3	A:WCDMA1	
Tx 4	A:WCDMA2	
Tx 5	A:WCDMA3	
Tx 6	A:WCDMA4	
Tx 7	A:WCDMA5	
Tx 8	A:WCDMA6	
Tx 9	A:WCDMA7	
Tx 10	A:WCDMA8	
Tx 11	A:WCDMA9	
Tx 12	A:WCDMA10	

Adjacent	Lower	Upper
Adjacent	Adj Lower	Adj Upper
Alternate 1	Alt1 Lower	Alt1 Upper
Alternate 2	Alt2 Lower	Alt2 Upper
Alternate 3	Alt3 Lower	Alt3 Upper
Alternate 4		

Figure 6-36: Channel name definition for asymmetric adjacent channels

#### Remote command:

[SENSe:] POWER:ACHannel:SBLock<sb>:NAME[:CHANnel<ch>] on page 967

[SENSe:] POWER:ACHannel:NAME:ACHannel on page 919

[SENSe:] POWER:ACHannel:NAME:ALternate<ch> on page 920

[SENSe:] POWER:ACHannel:NAME:UACHannel on page 966

[SENSe:] POWER:ACHannel:NAME:UALternate<ch> on page 967

### 6.2.6 How to perform channel power measurements

The following step-by-step instructions demonstrate the most common tasks when performing channel power measurements.



For remote operation, see [Chapter 13.5.3.11, "Programming examples for channel power measurements"](#), on page 971.



## Channel power and adjacent-channel power (ACLR) measurement

- [How to perform a standard channel power measurement](#)..... 193
- [How to set up the channels](#)..... 193
- [How to configure an MSR ACLR measurement](#)..... 194
- [How to manage user-defined configurations](#)..... 196
- [How to compare the TX channel power in successive measurements](#)..... 197

### 6.2.6.1 How to perform a standard channel power measurement

Performing a channel power or ACLR measurement according to common standards is a very easy and straightforward task with the FSW.

1. Press [MEAS] or select "Select Measurement" in the "Overview".
2. Select "Channel Power ACLR".  
The measurement is started immediately with the default settings.
3. Select "CP / ACLR Standard".
4. Select a standard from the list.  
The measurement is restarted with the predefined settings for the selected standard.
5. If necessary, edit the settings for your specific measurement as described in [Chapter 6.2.6.2, "How to set up the channels"](#), on page 193, or load a user-defined configuration (see ["To load a user-defined configuration"](#) on page 196).

### 6.2.6.2 How to set up the channels

Channel definition is the basis for measuring power levels in certain frequency ranges. Usually, the power levels in one or more carrier (TX) channels and possibly the adjacent channels are of interest. Up to 18 carrier channels and up to 12 adjacent channels can be defined.

When a measurement standard is selected, all settings including the channel bandwidths and channel spacings are set according to the selected standard. Select a standard in the "Ch Power" menu or the "ACLR Setup" dialog box. You can adjust the settings afterwards.

Channel setup consists of the following settings:

- The number of transmission (TX) and adjacent channels
- The bandwidth of each channel
- For multicarrier ACLR measurements: which TX channel is used as a reference
- The spacing between the individual channels
- Optionally: the names of the channels displayed in the diagram and result table
- Optionally: the influence of individual channels on the total measurement result ("Weighting Filter")
- Optionally: limits for a limit check on the measured power levels

## Channel power and adjacent-channel power (ACLR) measurement



Changes to an existing standard can be stored as a user-defined standard, see [Chapter 6.2.6.4, "How to manage user-defined configurations"](#), on page 196.

- ▶ To configure the channels in the "Ch Power" dialog box, select "Ch Power" > "CP / ACLR Config" > "Channel Settings" tab.



In the "Channel Setup" dialog box, you can define the channel settings for all channels, independent of the defined number of *used* TX or adjacent channels.

### To define channel spacings

Channel spacings are normally defined by the selected standard but can be changed.

- ▶ In the "Channel Settings" tab of the "ACLR Setup" dialog box, select the "Spacing" subtab.

The value entered for any TX channel is automatically also defined for all subsequent TX channels. Thus, only enter one value if all TX channels have the same spacing.

If the channel spacing for the adjacent or an alternate channel is changed, all higher alternate channel spacings are multiplied by the same factor (new spacing value/old spacing value). The lower adjacent-channel spacings remain unchanged. Only enter one value for equal channel spacing.

### Example: Defining channel spacing

In the default setting, the adjacent channels have the following spacing: 20 kHz ("ADJ"), 40 kHz ("ALT1"), 60 kHz ("ALT2"), 80 kHz ("ALT3"), 100 kHz ("ALT4"), ...

Set the spacing of the first adjacent channel ("ADJ") to *40 kHz*. For all other adjacent channels, the spacing is multiplied by factor 2: 80 kHz ("ALT1"), 120 kHz ("ALT2"), 160 kHz ("ALT3"), ...

Starting from the default setting, set the spacing of the fifth adjacent channel ("ALT4") to *150 kHz*. For all higher adjacent channels, the spacing is multiplied by factor 1.5: 180 kHz ("ALT5"), 210 kHz ("ALT6"), 240 kHz ("ALT7"), ...

### 6.2.6.3 How to configure an MSR ACLR measurement

You configure ACLR measurements on MSR signals in a special configuration dialog box on the FSW.

1. Press [MEAS] or select "Select Measurement" in the "Overview".
2. Select "Channel Power ACLR".

The measurement is started immediately with the default settings.

3. Select "CP / ACLR Standard".
4. Select the "Multi-Standard Radio" standard from the list.

## Channel power and adjacent-channel power (ACLR) measurement

5. Select "CP / ACLR Config" to configure general MSR settings, including the number of sub blocks (up to 8).  
To configure asymmetric adjacent channels, deactivate the "Symmetrical" option in the general MSR settings.
6. Select the "Tx Channels" tab to configure the sub blocks and transmission channels.  
For each sub block:
  - a) Define the (center frequency) position and bandwidth of the sub block, as well as the number of transmission channels it contains.
  - b) For each transmission channel in the sub block:
    - Define the center frequency.
    - Select the technology used for transmission.
    - Check the bandwidth.
    - If necessary, define the use of a weighting filter for the channel.
7. Select the "Adjacent Channels" tab to configure the adjacent channels.
8. Define the number of adjacent channels and the settings for each channel:
  - The spacing, defined as the distance of the center frequency from the center frequency of the first transmission channel in the first sub block.  
For asymmetrical channels, define the upper adjacent channel spacing as the distance from the center frequency of the last transmission channel in the last sub block.
  - The bandwidth
  - If necessary, a weighting filter
  - Optionally, define *and activate* relative or absolute limits, or both, against which the power levels of the channel are to be checked.
9. Select the "Gap Channels" tab to configure the gap channels.
10. Define the following settings for the two (upper or lower) gap channels. Since the upper and lower channels are identical, it is only necessary to configure two channels.
  - The spacing, defined as the distance of the center frequency from the outer edge of the sub block to the left or right of the gap. You can determine the required spacing as follows:  
Spacing = [CF of the gap channel] - [left sub block center] + ([RF bandwidth of left sub block] / 2)
  - The bandwidth
  - If necessary, a weighting filter
  - Optionally, define *and activate* relative or absolute limits, or both, against which the power levels of the channel are to be checked.
11. If power limits are defined and activated, activate global limit checking for the measurement on the "MSR General Settings" tab.

12. Optionally, store the settings for the MSR ACLR measurement as a user-defined standard as described in ["To store a user-defined configuration"](#) on page 196. Otherwise the configuration is lost when you select a different measurement standard.

#### 6.2.6.4 How to manage user-defined configurations

You can define measurement configurations independently of a predefined standard and save the current ACLR configuration as a "user standard" in an XML file. You can then load the file and thus the settings again later.

User-defined standards are not supported for "Fast ACLR" and multicarrier ACLR measurements.



##### Compatibility to R&S FSP

User standards created on an analyzer of the R&S FSP family are compatible to the FSW. User standards created on an FSW, however, are not necessarily compatible to the analyzers of the R&S FSP family and may not work there.

##### To store a user-defined configuration

1. In the "Ch Power" menu, select "CP / ACLR Config" to display the "ACLR Setup" dialog box.
2. Configure the measurement as required (see also [Chapter 6.2.6.2, "How to set up the channels"](#), on page 193).
3. In the "General Settings" tab, select "Manage User Standards" to display the "Manage" dialog box.
4. Define a filename and storage location for the user standard.  
By default, the XML file is stored in  
`C:\Program Files (x86)\Rohde-Schwarz\FSW\<version>\acp_std\.`  
However, you can define any other storage location.
5. Select "Save".

##### To load a user-defined configuration

1. In the "General Settings" tab of the "ACLR Setup" dialog box, select "Manage User Standards" to display the "Manage" dialog box.
2. Select the user standard file.
3. Select "Load".

The stored settings are automatically set on the FSW and the measurement is restarted with the new parameters.

### 6.2.6.5 How to compare the TX channel power in successive measurements

For power measurements with only one TX channel and no adjacent channels, you can define a fixed reference power and compare subsequent measurement results to the stored reference power.

1. Configure a measurement with only one TX channel and no adjacent channels (see also [Chapter 6.2.6.2, "How to set up the channels"](#), on page 193).
2. In the "ACLR Setup" dialog box, select "Set CP Reference".  
The channel power currently measured on the TX channel is stored as a fixed reference power. The reference value is displayed in the "Reference" field of the result table (in relative ACLR mode).
3. Start a new measurement.  
The resulting power is indicated relative to the fixed reference power.
4. Repeat this for any number of measurements.
5. To start a new measurement without the fixed reference, temporarily define a second channel or preset the instrument.

## 6.2.7 Measurement examples

The FSW has test routines for simple channel and adjacent channel power measurements. These routines give quick results without any complex or tedious setting procedures.



A programming example demonstrating an ACLR measurement in a remote environment is provided in [Chapter 13.5.3.11, "Programming examples for channel power measurements"](#), on page 971.

- [Measurement example 1 – ACPR measurement on a CDMA2000 signal](#)..... 197
- [Measurement example 2 – measuring adjacent channel power of a W-CDMA uplink signal](#)..... 199
- [Measurement example 3 – measuring the intrinsic noise of the FSW with the channel power function](#)..... 202

### 6.2.7.1 Measurement example 1 – ACPR measurement on a CDMA2000 signal

Test setup:

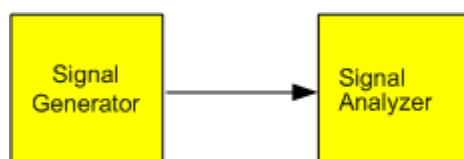

## Channel power and adjacent-channel power (ACLR) measurement

**Signal generator settings (e.g. R&S SMW):**

Frequency:	850 MHz
Level:	0 dBm
Modulation:	CDMA2000

**Procedure:**

1. Preset the FSW.
2. Set the center frequency to *850 MHz*.
3. Set the span to *4 MHz*.
4. Set the reference level to *+10 dBm*.
5. Press [MEAS] or select "Select Measurement" in the "Overview".
6. Select the "Channel Power ACLR" measurement function.
7. Set the "CDMA2000" standard for adjacent channel power measurement in the "ACLR Setup" dialog box.

The FSW sets the channel configuration according to the 2000 standard with two adjacent channels above and 2 below the transmit channel. The spectrum is displayed in the upper part of the screen, the numeric values of the results and the channel configuration in the lower part of the screen. The various channels are represented by vertical lines on the graph.

The frequency span, resolution bandwidth, video bandwidth and detector are selected automatically to give correct results. To obtain stable results – especially in the adjacent channels (30 kHz bandwidth) which are narrow in comparison with the transmission channel bandwidth (1.23 MHz) – the RMS detector is used.

8. Set the optimal reference level and RF attenuation for the applied signal level using the "Auto Level" function in the [Auto Set] menu.

The FSW sets the optimal RF attenuation and the reference level based on the transmission channel power to obtain the maximum dynamic range.

The [Figure 6-37](#) shows the result of the measurement.

Channel power and adjacent-channel power (ACLR) measurement

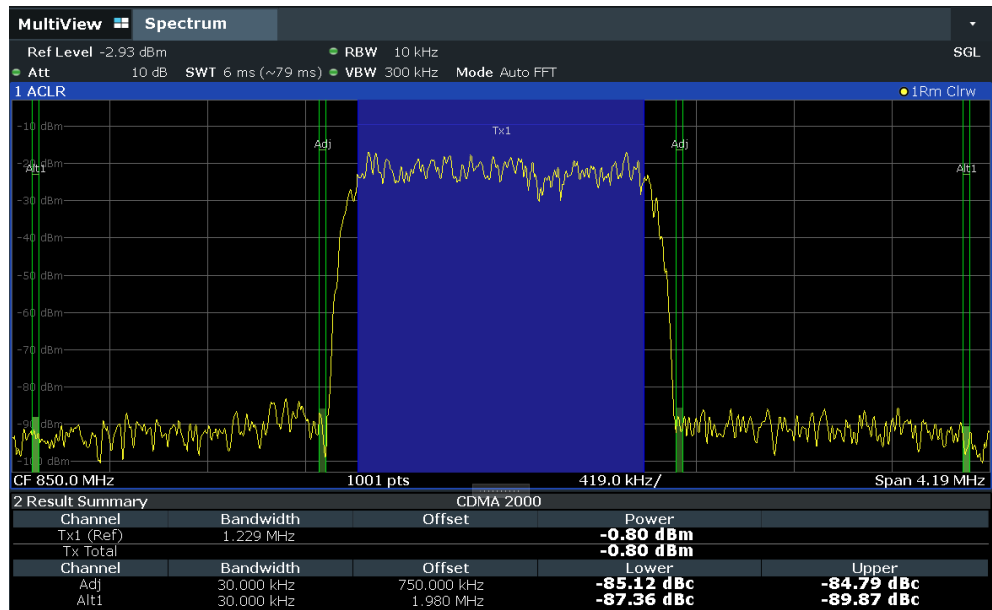
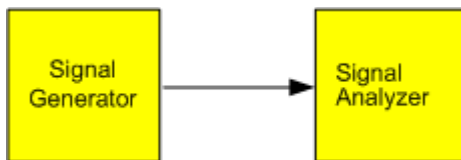

Figure 6-37: Adjacent channel power measurement on a CDMA2000 signal

6.2.7.2 Measurement example 2 – measuring adjacent channel power of a W-CDMA uplink signal

Test setup:



Signal generator settings (e.g. R&S SMW):

Frequency:	1950 MHz
Level:	4 dBm
Modulation:	3GPP W-CDMA Reverse Link

Procedure:

1. Preset the FSW.
2. Enter the Spectrum application via [MODE].
3. Set the center frequency to 1950 MHz.
4. Select the "Channel Power ACLR" measurement function from the "Select Measurement" dialog box.

## Channel power and adjacent-channel power (ACLR) measurement

- Set the "W-CDMA 3GPP REV" standard for adjacent channel power measurement in the "ACLR Setup" dialog box.

The FSW sets the channel configuration to the W-CDMA standard for mobiles with two adjacent channels above and below the transmit channel. The frequency span, the resolution and video bandwidth and the detector are automatically set to the correct values. The spectrum is displayed in the upper window and the channel power, the level ratios of the adjacent channel powers and the channel configuration in the lower window. The individual channels are displayed as bars in the graph.

- Set the optimal reference level and RF attenuation for the applied signal level using the "Auto Level" function.

The FSW sets the optimum RF attenuation and the reference level for the power in the transmission channel to obtain the maximum dynamic range. The following figure shows the result of the measurement.

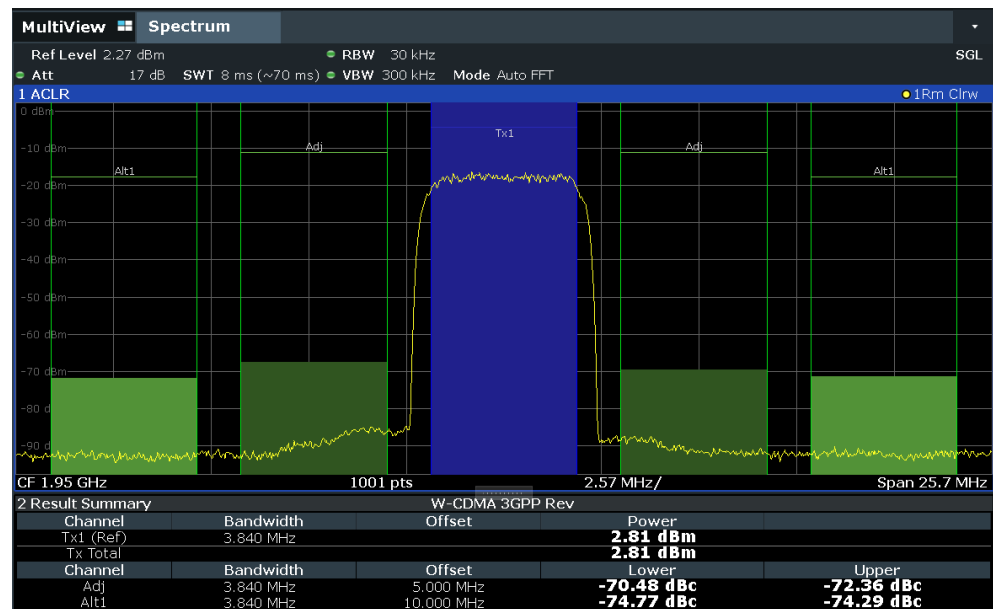

Figure 6-38: Measuring the relative adjacent channel power on a W-CDMA uplink signal

The FSW measures the power of the individual channels. A root raised cosine filter with the parameters  $\alpha = 0.22$  and chip rate 3.84 Mcps (= receive filter for W-CDMA) is used as channel filter.

### Optimum Level Setting for ACLR Measurements on W-CDMA Signals

The dynamic range for ACLR measurements is limited by the thermal noise floor, the phase noise and the intermodulation (spectral regrowth) of the signal analyzer. The power values produced by the FSW due to these factors accumulate linearly. They depend on the applied level at the input mixer. The three factors are shown in the figure below for the adjacent channel (5 MHz carrier offset).



## Channel power and adjacent-channel power (ACLR) measurement

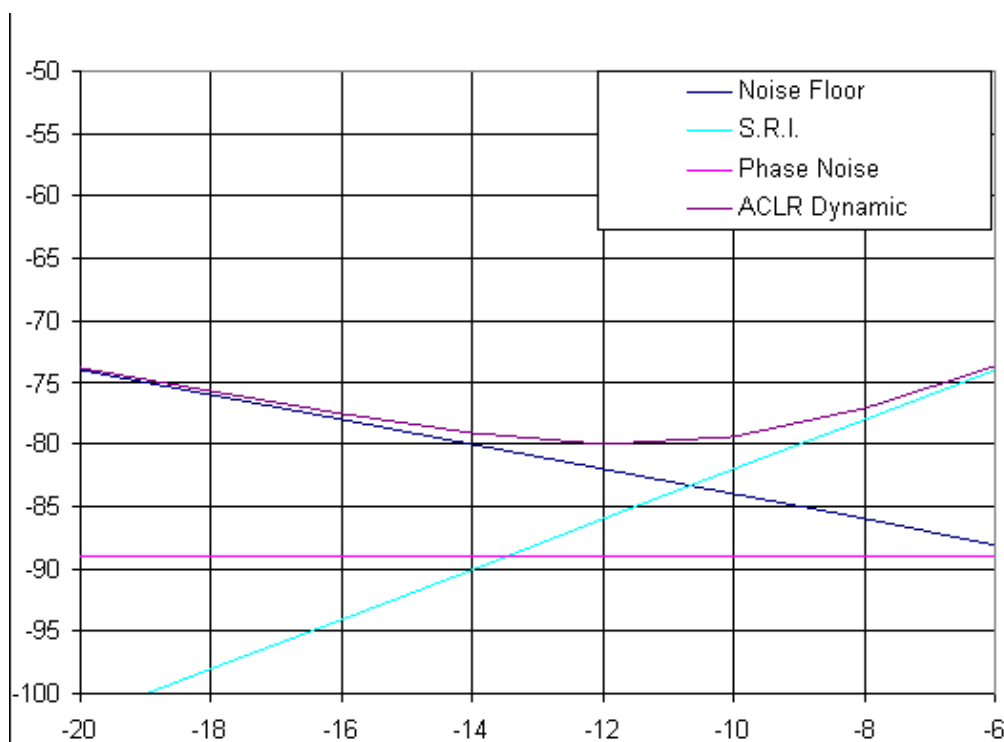

Figure 6-39: Dynamic range for ACLR measurements on W-CDMA uplink signals as a function of the mixer level

The level of the W-CDMA signal at the input mixer is shown on the horizontal axis, i.e. the measured signal level minus the selected RF attenuation. The individual components which contribute to the power in the adjacent channel and the resulting relative level (total ACPR) in the adjacent channel are displayed on the vertical axis. The optimum mixer level is -12 dBm. The relative adjacent channel power (ACPR) at an optimum mixer level is -77 dBc. At a given signal level, the mixer level is set in 1 dB steps with the 1 dB RF attenuator. Thus, the optimum range spreads from -10 dBm to -14 dBm.

To set the attenuation parameter manually, the following method is recommended:

- ▶ Set the RF attenuation so that the mixer level (= measured channel power – RF attenuation) is between -10 dBm and -14 dBm.

This method is automated with the "Auto Level" function. Especially in remote control mode, e.g. in production environments, set the attenuation parameters correctly before the measurement. That saves the time required for automatic setting.



To measure the FSW's intrinsic dynamic range for W-CDMA adjacent channel power measurements, a filter which suppresses the adjacent channel power is required at the output of the transmitter. A SAW filter with a bandwidth of 4 MHz, for example, can be used.

### 6.2.7.3 Measurement example 3 – measuring the intrinsic noise of the FSW with the channel power function

Noise in any bandwidth can be measured with the channel power measurement functions. Thus the noise power in a communication channel can be determined, for example.

If the noise spectrum within the channel bandwidth is flat, the noise marker can be used to determine the noise power in the channel by considering the channel bandwidth. However, in the following cases, the channel power measurement method must be used to obtain correct measurement results:

- If phase noise and noise that normally increases towards the carrier is dominant in the channel to be measured
- If there are discrete spurious signals in the channel

#### Test setup:

- ▶ Leave the RF input of the FSW open-circuited or terminate it with 50  $\Omega$ .

#### Procedure:

1. Preset the FSW.
2. Set the center frequency to 1 GHz and the span to 1 MHz.
3. To obtain maximum sensitivity, set RF attenuation to 0 dB and the reference level to -40 dBm.
4. Select the "Channel Power ACLR" measurement function from the "Select Measurement" dialog box.
5. In the "ACLR Setup" dialog box, set up a single TX channel with the channel bandwidth 1.23 MHz.
6. Select "Adjust Settings".  
The settings for the frequency span, the bandwidth (RBW and VBW) and the detector are automatically set to the optimum values required for the measurement.
7. Stabilize the measurement result by increasing the "Sweep Time".  
Set the "Sweep Time" to 1 s.

The trace becomes much smoother because of the RMS detector and the channel power measurement display is much more stable.

## Channel power and adjacent-channel power (ACLR) measurement

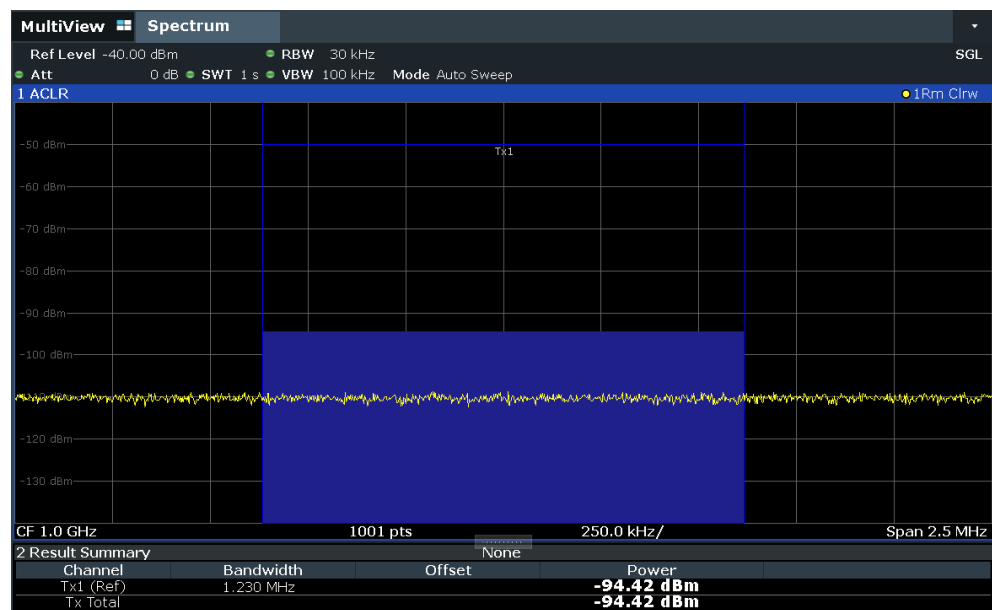

Figure 6-40: Measurement of the FSW's intrinsic noise power in a 1.23 MHz channel bandwidth.

## 6.2.8 Optimizing and troubleshooting the measurement

If the results do not meet your expectations, or if you want to minimize the measurement duration, try the following methods to optimize the measurement:

- Only activate as many **adjacent channels** as necessary to minimize the required span and thus the required measurement time for the measurement.
- Increase the **RBW** to minimize the measurement time; however, consider the requirements of the standard if you need to measure according to standard! The automatic settings are always according to standard.
- Take advantage of the **speed optimization mode** in the "Sweep" settings if you do not require the larger dynamic range (see "[Optimization](#)" on page 504).
- Reduce the **"Sweep Time"** and thus the amount of data to be captured and calculated; however, consider the requirements regarding the standard deviation.
- To improve the **stability of the measured results**, increase the "Sweep Time", which also leads to more averaging steps.
- Instead of **trace averaging**, use an RMS detector with a higher "Sweep Time" to obtain better average power results in less time.
- To determine a **channel power level** quickly, use the **Time domain power measurement** (TDP) rather than a Channel Power measurement. The TDP measurement is a zero span measurement where the sweep time determines the measurement time. Due to the FFT measurement, duplicate averaging is performed, providing very stable results very quickly.

Note, however, that for TDP measurements, channel filters are not available and a fixed RBW is used. Thus, the measurement may not be according to standard for some test cases.

## 6.2.9 Reference: predefined CP/ACLR standards

When using predefined standards for ACLR measurement, the test parameters for the channel and adjacent-channel measurements are configured automatically.

You can select a predefined standard via "CP / ACLR Standard" in the "Ch Power" menu or the selection list in the "General Settings" tab of the "ACLR Setup" dialog box (see "Standard" on page 166).

**Table 6-9: Predefined CP / ACLR standards with remote command parameters**

Standard	Remote parameter
None	NONE
Multi-Standard Radio	MSR
EUTRA/LTE Square	EUTRa
EUTRA/LTE Square/RRC	REUTra
5G NR DL FR1 20MHz	F1D20nr5g
5G NR DL FR1 100MHz	F1D100nr5g
5G NR UL FR1 20MHz	F1U20nr5g
5G NR UL FR1 100MHz	F1U100nr5g
5G NR DL FR2 100MHz	F2D100nr5g
5G NR DL FR2 200MHz	F2D200nr5g
5G NR UL FR2 100MHz	F2U100nr5g
5G NR UL FR2 200MHz	F2U200nr5g
W-CDMA 3GPP FWD	FW3Gppcdma
W-CDMA 3GPP REV	RW3Gppcdma
CDMA IS95A FWD	F8CDma
CDMA IS95A REV	R8CDma
CDMA IS95C Class 0 FWD*)	FIS95c0
CDMA IS95C Class 0 REV*)	RIS95c0
CDMA J-STD008 FWD	F19Cdma
CDMA J-STD008 REV	R19Cdma
CDMA IS95C Class 1 FWD*)	FIS95c1
CDMA IS95C Class 1 REV*)	RIS95c1
CDMA2000	S2CDma
TD-SCDMA FWD	FTCDma
TD-SCDMA REV	TRCDma
WLAN 802.11A	AWLAN
WLAN 802.11B	BWLAN

## Channel power and adjacent-channel power (ACLR) measurement

Standard	Remote parameter
WIMAX	WIMax
WIBRO	WIBRo
GSM	GSM
RFID 14443	RFID14443
TETRA	TETRa
PDC	PDC
PHS	PHS
CDPD	CDPD
APCO-25 P2	PAPCo25
User Standard	USER
Customized Standard	<string>



For the FSW, the channel spacing is defined as the distance between the center frequency of the adjacent channel and the center frequency of the transmission channel. The definition of the adjacent-channel spacing in standards IS95C and CDMA 2000 is different. These standards define the adjacent-channel spacing from the center of the transmission channel to the closest border of the adjacent channel. This definition is also used by the FSW for the standards marked with an asterisk \*).

### 6.2.10 Reference: predefined ACLR user standard XML files

In addition to the predefined standards, some user standards with specific measurement settings for common ACLR measurements are provided in XML files on the instrument in the

C:\Program Files (x86)\Rohde-Schwarz\FSW\<version>\acp\_std directory.

In particular, a sample file (MSR\_ACLRExample.xml) is provided for an MSR ACLR measurement. It sets up the measurement for the MSR signal generator waveform described in the file

C:\R\_S\INSTR\USER\waveform\MSRA\_GSM\_WCDMA\_LTE\_GSM.wv.

Furthermore, the following XML files are provided:

#### 5GNR\DL

- 5GNR\DL\5GNR\_DL\_FR1\_20MHz
- 5GNR\DL\5GNR\_DL\_FR1\_100MHz
- 5GNR\DL\5GNR\_DL\_FR2\_100MHz
- 5GNR\DL\5GNR\_DL\_FR2\_200MHz

#### 5GNR\UL

- 5GNR\UL\5GNR\_UL\_FR1\_20MHz

- 5GNR\UL\5GNR\_UL\_FR1\_100MHz
- 5GNR\UL\5GNR\_UL\_FR2\_100MHz
- 5GNR\UL\5GNR\_UL\_FR2\_200MHz

#### LTE\DL

- LTE\DL\LTE\_DL\_5MHZ.XML
- LTE\DL\LTE\_DL\_10MHZ.XML
- LTE\DL\LTE\_DL\_15MHZ.XML
- LTE\DL\LTE\_DL\_20MHZ.XML

#### LTE\UL

- LTE\UL\LTE\_UL\_5MHZ.XML
- LTE\UL\LTE\_UL\_10MHZ.XML
- LTE\UL\LTE\_UL\_15MHZ.XML
- LTE\UL\LTE\_UL\_20MHZ.XML

#### WLAN

- WLAN\802\_11ac\802\_11ac\_20MHZ.XML
- WLAN\802\_11ac\802\_11ac\_40MHZ.XML
- WLAN\802\_11ac\802\_11ac\_80MHZ.XML
- WLAN\802\_11ac\802\_11ac\_160MHZ.XML



To load a stored measurement configuration, in the "General Settings" tab of the "ACLR Setup" dialog box, select "Manage User Standards" to display the "Manage" dialog box. Select the user standard file, then "Load".

The stored settings are automatically set on the FSW and the measurement is restarted with the new parameters.

For details, see [Chapter 6.2.6.4, "How to manage user-defined configurations"](#), on page 196.

## 6.3 Carrier-to-noise measurements

Measures the carrier-to-noise ratio. C/No measurements normalize the ratio to a 1 Hz bandwidth.

- [About the measurement](#).....207
- [Carrier-to-noise results](#).....207
- [Carrier-to-noise configuration](#).....208
- [How to determine the carrier-to-noise ratio](#).....209

### 6.3.1 About the measurement

The largest signal in the frequency span is the carrier. When you activate the C/N or C/N<sub>0</sub> function, the FSW searches the (unmodulated) carrier using a peak detector. The carrier is marked using a fixed reference marker ("FXD").

To determine the noise power, the FSW analyzes a channel with a defined bandwidth at the defined center frequency. The FSW integrates the power within this channel to obtain the noise power level. If the carrier is within this channel, you have to switch off the carrier to determine the correct noise power level. To determine the noise power, the FSW requires an RMS detector. To switch detectors, you must adjust the settings between the two measurements (see "Adjust Settings" on page 209).

The FSW subtracts the noise power of the channel from the maximum carrier signal level. For a C/N<sub>0</sub> measurement, the FSW normalizes the result to a 1 Hz bandwidth.



The carrier-to-noise measurements are only available in the frequency domain (span >0).

#### Frequency Span

To measure the carrier-to-noise ratio correctly, set the frequency span to approximately twice the channel bandwidth. The "Adjust Settings" function automatically uses that value.

### 6.3.2 Carrier-to-noise results

As a result of the carrier-to-noise measurement, the evaluated bandwidth and the calculated C/N ratio are displayed in the result window. The fixed reference marker for the (unmodulated) carrier is indicated in the diagram.

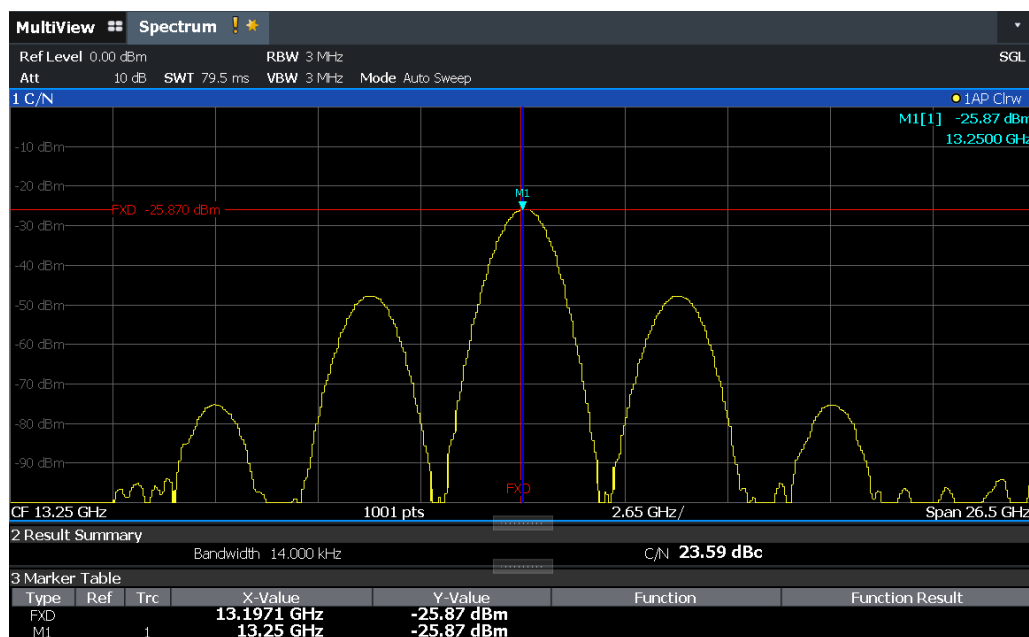

**Remote command:**

```
CALC:MARK:FUNC:POW:RES? CN
```

```
CALC:MARK:FUNC:POW:RES? CN0
```

See [CALCulate<n>:MARKer<m>:FUNction:POWer<sb>:RESult?](#) on page 912.

### 6.3.3 Carrier-to-noise configuration

**Access:** "Overview" > "Select Measurement" > "C/N"/"C/N0" > "Carrier Noise Config"

Both a carrier-to-noise ratio (C/N) and a carrier-to-noise ratio in relation to the bandwidth (C/N<sub>0</sub>) measurement are available.

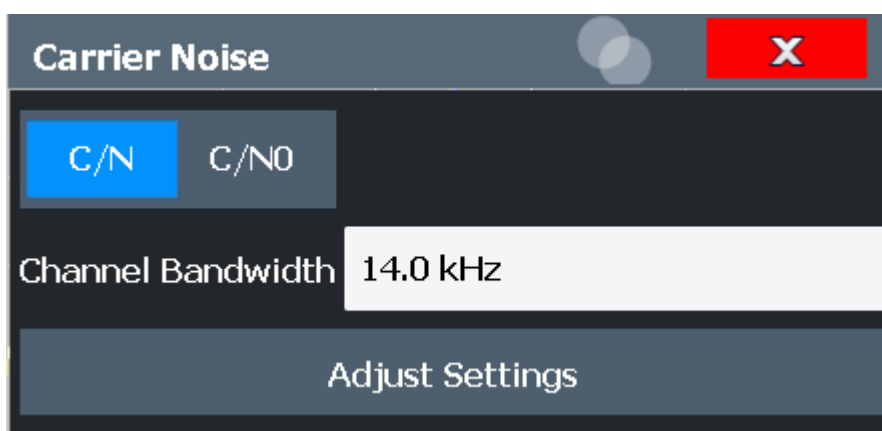

Carrier-to-noise measurements are not available in zero span mode.



The easiest way to configure a measurement is using the configuration "Overview", see [Chapter 7.1, "Configuration overview"](#), on page 357.

The remote commands required to perform these tasks are described in [Chapter 13.5.4, "Measuring the carrier-to-noise ratio"](#), on page 979.

<a href="#">C/N</a> .....	208
<a href="#">C/N0</a> .....	209
<a href="#">Channel Bandwidth</a> .....	209
<a href="#">Adjust Settings</a> .....	209

**C/N**

Switches the measurement of the carrier/noise ratio on or off. If no marker is active, marker 1 is activated.

The measurement is performed on the trace that marker 1 is assigned to. To shift marker 1 and measure another Trace, use "Marker To Trace" in the "Marker" menu (see ["Assigning the Marker to a Trace"](#) on page 344).



Remote command:

[CALCulate<n>:MARKer<m>:FUNCTION:POWER<sb>:SElect](#) on page 913

[CALCulate<n>:MARKer<m>:FUNCTION:POWER<sb>:RESult?](#) on page 912

[CALCulate<n>:MARKer<m>:FUNCTION:POWER<sb>\[:STATe\]](#) on page 914

### C/NO

Switches the measurement of the carrier/noise ratio with reference to a 1 Hz bandwidth on or off. If no marker is active, marker 1 is activated.

The measurement is performed on the trace that marker 1 is assigned to. To shift marker 1 and measure another trace, use "Marker To Trace" in the "Marker" menu (see ["Assigning the Marker to a Trace"](#) on page 344).

Remote command:

[CALCulate<n>:MARKer<m>:FUNCTION:POWER<sb>:SElect](#) on page 913

[CALCulate<n>:MARKer<m>:FUNCTION:POWER<sb>:RESult?](#) on page 912

[CALCulate<n>:MARKer<m>:FUNCTION:POWER<sb>\[:STATe\]](#) on page 914

### Channel Bandwidth

Defines the channel bandwidth.

The default setting is 14 kHz.

Remote command:

[\[SENSe:\] POWER:ACHannel: BANDwidth\[:CHANnel<ch>\]](#) on page 919

### Adjust Settings

Enables the RMS detector and adjusts the span to the selected channel bandwidth according to:

$2 * \text{channel bandwidth}$

The adjustment is performed once. If necessary, you can change the setting later.

Remote command:

[\[SENSe:\] POWER:ACHannel: PRESet](#) on page 914

## 6.3.4 How to determine the carrier-to-noise ratio

The following step-by-step instructions demonstrate how to determine the carrier-to-noise ratio.



For remote operation, see ["Programming example: Measuring the carrier-to-noise ratio"](#) on page 979.

1. Select [MEAS].
2. To configure the measurement without reference to the bandwidth, select "C/N".  
To configure the measurement with reference to the bandwidth, select "C/N<sub>0</sub>".
3. To change the channel bandwidth to be analyzed, select "Channel Bandwidth".
4. Select [RUN SINGLE].

The fixed reference marker for the (unmodulated) carrier is indicated in the diagram.

5. If the carrier signal is located within the analyzed channel bandwidth, switch off the carrier signal so that only the noise is displayed in the channel.
6. To optimize the settings for the selected channel configuration and use the RMS detector, select "Adjust Settings".
7. Select [RUN SINGLE] to perform a second measurement.

The carrier-to-noise ratio is displayed after the measurement has been completed.

## 6.4 Occupied bandwidth measurement (OBW)

An important characteristic of a modulated signal is its occupied bandwidth, that is: the bandwidth which must contain a defined percentage of the power. In a radio communications system, for instance, the occupied bandwidth must be limited to enable distortion-free transmission in adjacent channels.

- [About the measurement](#).....210
- [OBW results](#).....212
- [OBW configuration](#).....212
- [How to determine the occupied bandwidth](#).....215
- [Measurement example](#).....216

### 6.4.1 About the measurement

The occupied bandwidth is defined as the bandwidth containing a defined percentage of the total transmitted power. A percentage between 10 % and 99.9 % can be set.

#### Measurement principle

The bandwidth containing 99% of the signal power is to be determined, for example. The algorithm first calculates the total power of all displayed points of the trace. In the next step, the points from the right edge of the trace are summed up until 0.5 % of the total power is reached. Auxiliary marker 1 is positioned at the corresponding frequency. Then the points from the left edge of the trace are summed up until 0.5 % of the power is reached. Auxiliary marker 2 is positioned at this point. 99 % of the power is now between the two markers. The distance between the two frequency markers is the occupied bandwidth which is displayed in the marker field.



### OBW within defined search limits - multicarrier OBW measurement in one sweep

The occupied bandwidth of the signal can also be determined within defined search limits instead of for the entire signal. Thus, only a single sweep is required to determine the OBW for a multicarrier signal. To do so, search limits are defined for an individual carrier and the OBW measurement is restricted to the frequency range contained within those limits. Then the search limits are adapted for the next carrier and the OBW is automatically recalculated for the new range.

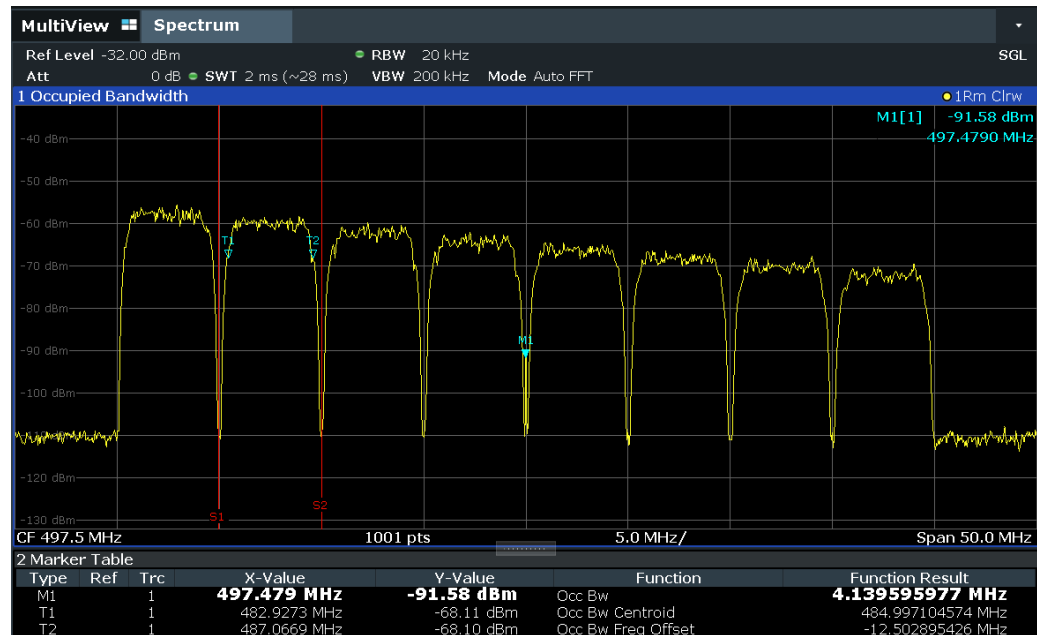

For step-by-step instructions, see ["How to determine the OBW for a multicarrier signal using search limits"](#) on page 215.

### Prerequisites

To ensure correct power measurement, especially for noise signals, and to obtain the correct occupied bandwidth, the following prerequisites and settings are necessary:

- Only the signal to be measured is displayed in the window, or search limits are defined to include only one (carrier) signal. An additional signal would falsify the measurement.
- $RBW \ll$  occupied bandwidth (approx. 1/20 of occupied bandwidth, for voice communication type: 300 Hz or 1 kHz)
- $VBW \geq 3 \times RBW$
- RMS detector
- $Span \geq 2$  to  $3 \times$  occupied bandwidth

Some of the measurement specifications (e.g. PDC, RCR STD-27B) require measurement of the occupied bandwidth using a peak detector. The detector setting of the FSW has to be changed accordingly then.

### 6.4.2 OBW results

As a result of the OBW measurement the occupied bandwidth ("Occ Bw") is indicated in the marker results. Furthermore, the marker at the center frequency and the temporary markers are indicated.

The measurement is performed on the trace with marker 1. In order to evaluate another trace, marker 1 must be placed on another trace (see [Assigning the Marker to a Trace](#)).



The OBW calculation is repeated if the [Search Limits](#) are changed, without performing a new sweep. Thus, the OBW for a multicarrier signal can be determined using only one sweep.

#### Centroid frequency

The centroid frequency is defined as the point in the center of the occupied bandwidth, calculated using the temporary OBW markers T1 and T2. This frequency is indicated as a function result ("Occ Bw Centroid") in the marker table.

#### Frequency offset

The offset of the calculated centroid frequency to the defined center frequency of the FSW is indicated as a function result ("Occ Bw Freq Offset") in the marker table.

#### Remote command:

The determined occupied bandwidth can also be queried using the remote command `CALC:MARK:FUNC:POW:RES? OBW` or `CALC:MARK:FUNC:POW:RES? AOBW`. While the `OBW` parameter returns only the occupied bandwidth, the `AOBW` parameter also returns the position and level of the temporary markers T1 and T2 used to calculate the occupied bandwidth.

`CALC:MARK:FUNC:POW:SEL OBW`, see [CALCulate<n>:MARKer<m>:FUNCTION:POWer<sb>:SElect](#) on page 913

[CALCulate<n>:MARKer<m>:FUNCTION:POWer<sb>\[:STATe\]](#) on page 914

`CALC:MARK:FUNC:POW:RES? OBW`, see [CALCulate<n>:MARKer<m>:FUNCTION:POWer<sb>:RESult?](#) on page 912

`CALC:MARK:FUNC:POW:RES? COBW`, see [CALCulate<n>:MARKer<m>:FUNCTION:POWer<sb>:RESult?](#) on page 912

### 6.4.3 OBW configuration

**Access:** "Overview" > "Select Measurement" > "OBW" > "OBW Config"

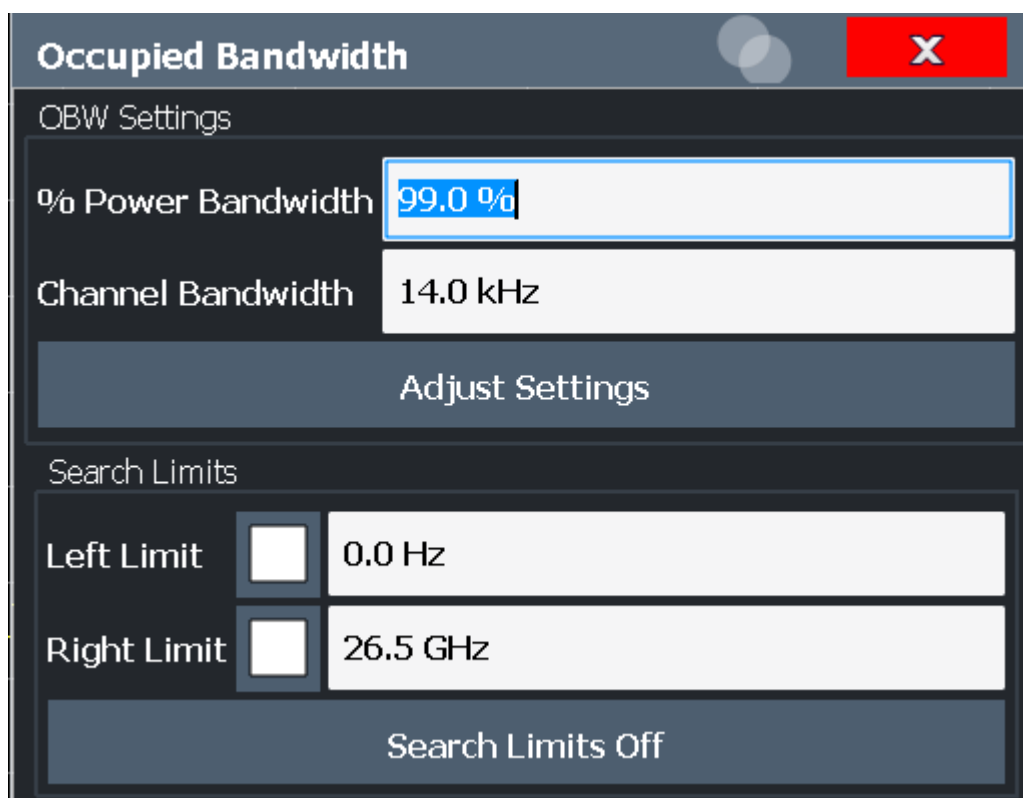

This measurement is not available in zero span.



**Configuring search limits for OBW measurement**

The OBW measurement uses the same search limits as defined for marker search (see "Search Limits" on page 559). However, only the left and right limits are considered.

The remote commands required to perform these tasks are described in Chapter 13.5.5, "Measuring the occupied bandwidth", on page 980.

<a href="#">% Power Bandwidth</a> .....	213
<a href="#">Channel Bandwidth</a> .....	214
<a href="#">Adjust Settings</a> .....	214
<a href="#">Search Limits (Left / Right)</a> .....	214
<a href="#">Search Limits Off</a> .....	214

**% Power Bandwidth**

Defines the percentage of total power in the displayed frequency range which defines the occupied bandwidth. Values from 10 % to 99.9 % are allowed.

Remote command:

`[SENSe:] PWeR:BAWdth` on page 981

## Occupied bandwidth measurement (OBW)

**Channel Bandwidth**

Defines the channel bandwidth for the transmission channel in single-carrier measurements. This bandwidth is used to optimize the test parameters (for details see "[Adjust Settings](#)" on page 214). The default setting is 14 kHz.

For measurements according to a specific transmission standard, define the bandwidth specified by the standard for the transmission channel.

For multicarrier measurements, this setting is irrelevant.

Remote command:

`[SENSe:] POWER:ACHannel:BANDwidth[:CHANnel<ch>]` on page 919

**Adjust Settings**

Optimizes the instrument settings for the measurement of the occupied bandwidth according to the specified channel bandwidth.

This function is only useful for single carrier measurements.

All instrument settings relevant for power measurement within a specific frequency range are optimized:

- Frequency span:  $3 \times$  channel bandwidth
- RBW  $\leq$  1/40 of channel bandwidth
- VBW  $\geq$   $3 \times$  RBW
- Detector: RMS

The reference level is not affected by "Adjust Settings". For an optimum dynamic range, select the reference level such that the signal maximum is close to the reference level.

(See "[Setting the Reference Level Automatically \(Auto Level\)](#)" on page 486).

The adjustment is carried out only once. If necessary, the instrument settings can be changed later.

Remote command:

`[SENSe:] POWER:ACHannel:PRESet` on page 914

**Search Limits (Left / Right)**

If activated, limit lines are defined and displayed for the search. Only results within the limited search range are considered.

For details on limit lines for searches, see "[Peak search limits](#)" on page 582.

Remote command:

`CALCulate<n>:MARKer<m>:X:SLIMits[:STATe]` on page 1278

`CALCulate<n>:MARKer<m>:X:SLIMits:LEFT` on page 1278

`CALCulate<n>:MARKer<m>:X:SLIMits:RIGHT` on page 1279

**Search Limits Off**

Deactivates the search range limits.

Remote command:

`CALCulate<n>:MARKer<m>:X:SLIMits[:STATe]` on page 1278

`CALCulate<n>:THReshold:STATe` on page 1280

#### 6.4.4 How to determine the occupied bandwidth

The following step-by-step instructions demonstrate how to determine the occupied bandwidth.



For remote operation, see [Chapter 13.5.5.2, "Programming example: OBW measurement"](#), on page 981.

##### How to determine the OBW for a single signal

1. Press [MEAS] or select "Select Measurement" in the "Overview".
2. Select the "OBW" measurement function.  
The measurement is started immediately with the default settings.
3. Select "OBW Config".  
The "Occupied Bandwidth" configuration dialog box is displayed.
4. Define the percentage of power ("% Power Bandwidth") that defines the bandwidth to be determined.
5. If necessary, change the channel bandwidth for the transmission channel.
6. To optimize the settings for the selected channel configuration, select "Adjust Settings".
7. Start a sweep.  
The result is displayed as OBW in the marker results.

##### How to determine the OBW for a multicarrier signal using search limits

1. Press [MEAS] or select "Select Measurement" in the "Overview".
2. Select the "OBW" measurement function.
3. Select "OBW Config".
4. Define the percentage of power ("% Power Bandwidth") that defines the bandwidth to be determined.
5. Define search limits so the search area contains only the first carrier signal:
  - a) Enter values for the left or right limits, or both.
  - b) Enable the use of the required limits.
6. Start a sweep.  
The result for the first carrier is displayed as OBW in the marker results.
7. Change the search limits so the search area contains the next carrier signal as described in [step 5](#).  
The OBW is recalculated and the result for the next carrier is displayed. A new sweep is not necessary!

8. Continue in this way until all carriers have been measured.

### 6.4.5 Measurement example

In the following example, the bandwidth that occupies 99 % of the total power of a PDC signal at 800 MHz, level 0 dBm is measured.



A programming example demonstrating an OBW measurement in a remote environment is provided in [Chapter 13.5.5.2, "Programming example: OBW measurement"](#), on page 981.

1. Preset the FSW.
2. Set the "Center Frequency" to *800 MHz*.
3. Set the "Reference Level" to *-10 dBm*.
4. Press [MEAS] or select "Select Measurement" in the "Overview".
5. Select the "OBW" measurement function.
6. Select "OBW Config".
7. Set the "% Power Bandwidth" to *99 %*.
8. Set the "Channel Bandwidth" to *21 kHz* as specified by the PDC standard.
9. Optimize the settings for the selected channel configuration by selecting "Adjust Settings".
10. Adjust the reference level to the measured total power by selecting "Auto Level" in the [Auto set] menu.
11. The PDC standard requires the peak detector for OBW measurement. In the "Traces" configuration dialog, set the trace detector to "PositivePeak".
12. Start a sweep.

The result is displayed as OBW in the marker results.

## 6.5 Noise power ratio (NPR) measurement

The FSW noise power ratio measurement is similar to the common adjacent channel power (ACP) measurement, but less sophisticated and therefore easier to configure.

This measurement requires the Noise Power Ratio (NPR) Measurement firmware option R&S FSW-K19.

- [About noise power ratio \(NPR\) measurements](#).....217
- [NPR basics](#)..... 217
- [NPR results](#).....219
- [NPR configuration](#).....220



- [Generator setup](#)..... 224
- [Generator frequency coupling](#)..... 229
- [How to perform NPR measurements](#)..... 231
- [Measurement example](#)..... 232

### 6.5.1 About noise power ratio (NPR) measurements

The noise power ratio is defined as the relationship between the total power density in a channel and the noise power density. The noise power ratio is commonly used to describe the distortion caused by in-band multi-carrier intermodulation in a wideband satellite channel. A satellite can be considered to be a "transparent transponder". It receives the uplink signal, amplifies it, translates the frequency, amplifies it more, and finally retransmits it. Typically, the signal contains a large number of carriers. To measure the in-band distortions of specific carriers in a satellite DUT, notch filters are inserted inside the channel. Notch filters remove the effects of the underlying subcarriers from the signal. Thus, the distortion of these carriers caused by the others can be determined.

The FSW noise power ratio measurement allows you to specify your satellite channel and up to 25 notch filters in your measurement setup. For a more general measurement, the bandwidth on which the total power density is based can be selected freely. As a result, the channel power density, the notch power density, and the noise power ratio are calculated.

### 6.5.2 NPR basics

Some background knowledge on basic terms and principles used in noise power ratio measurements is provided here for a better understanding of the required configuration settings.

#### Channel bandwidth, integration bandwidth and notch bandwidth

The [Channel Bandwidth](#) defines the width of the channel, or general measurement range. The displayed span usually depends on the channel bandwidth (span = channel bandwidth \* 1.1)

The [Integration Bandwidth](#) defines the frequency range over which measurement results are actually calculated. By default, it is the same as the channel bandwidth, but you can define any other value, smaller or larger, as well.

The [Notch Bandwidth \(Absolute / Relative to Channel BW\)](#) defines the width of the notches, if you define any.

#### Notches and their effects on the measurement results

You can select from an automatic measurement mode that selects the integration bandwidth automatically, and a manual measurement mode that allows you to define a custom integration bandwidth.

In automatic measurement mode, the power within the notches is deducted from the total noise power density.

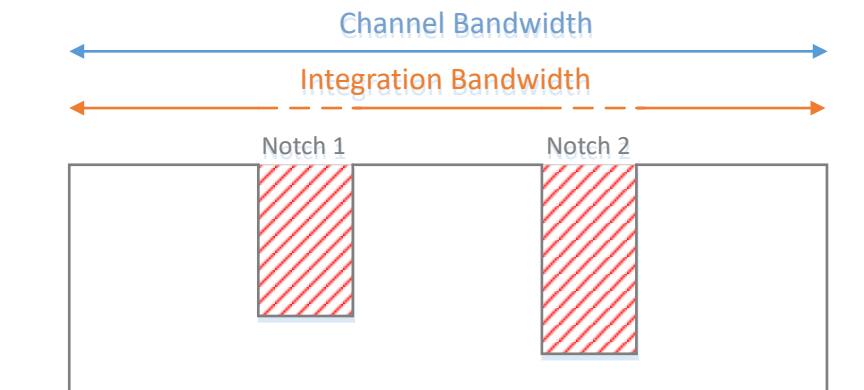

Figure 6-41: Auto mode: Integration bandwidth = channel bandwidth (notches deducted)

In manual measurement, however, the notch power is not deducted. In manual mode, the application simply integrates all measured powered levels over the integration bandwidth, including the power levels measured within the notches.

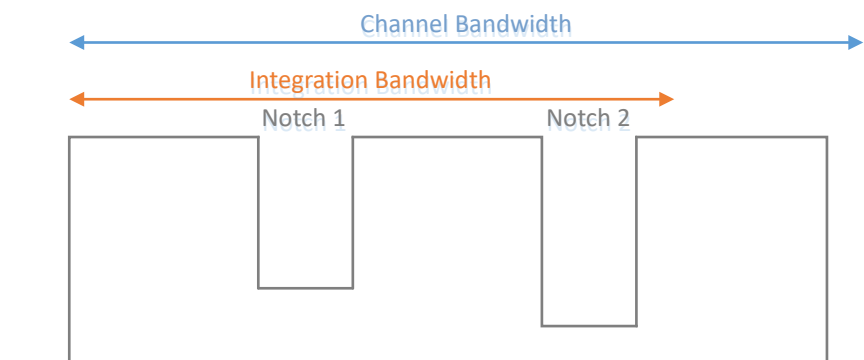

Figure 6-42: Manual mode: Integration bandwidth  $\neq$  channel bandwidth (notches not deducted)



### Overlapping notches or notches outside the channel bandwidth

Note that measurement results can become inaccurate when notches overlap or lie outside of the channel bandwidth.

### NPR measurements with signal generator control

To test the NPR of a satellite channel with multiple notch filters using a signal generator, you must configure the same settings on the analyzer and on the generator. The FSW can now take control of the connected generator, so that you only need to configure the notches once. The analyzer can then automatically set the generator to the same settings.

Generator control by the FSW has the following preconditions on the signal generator:

- R&S SMW
- Notched Noise option (R&S SMW-K811) installed
- Either ARB waveforms or one of the standards supported by the K811 option active on the generator

### Frequency-coupled NPR measurements

For NPR measurements, configuring and re-configuring the carrier frequencies and notches first on the analyzer, and then on the generator, can become very tedious. Therefore, frequency coupling is now provided in which the analyzer takes control of the generator. The frequency on the generator is automatically set to the analyzer frequency, possibly with a fixed factor or offset applied.

### 6.5.3 NPR results

The FSW shows the measurement results in a diagram and a table in numerical form.

The diagram consists of several elements.

- A horizontal blue bar at the bottom of the diagram indicates the channel bandwidth.
- Two vertical blue lines indicate the integration range or integration bandwidth. It is the same as the channel bandwidth by default (it is labeled "channel bandwidth" in that case).
- Vertical green lines indicate notches and their bandwidth. The number of displayed notches is variable.

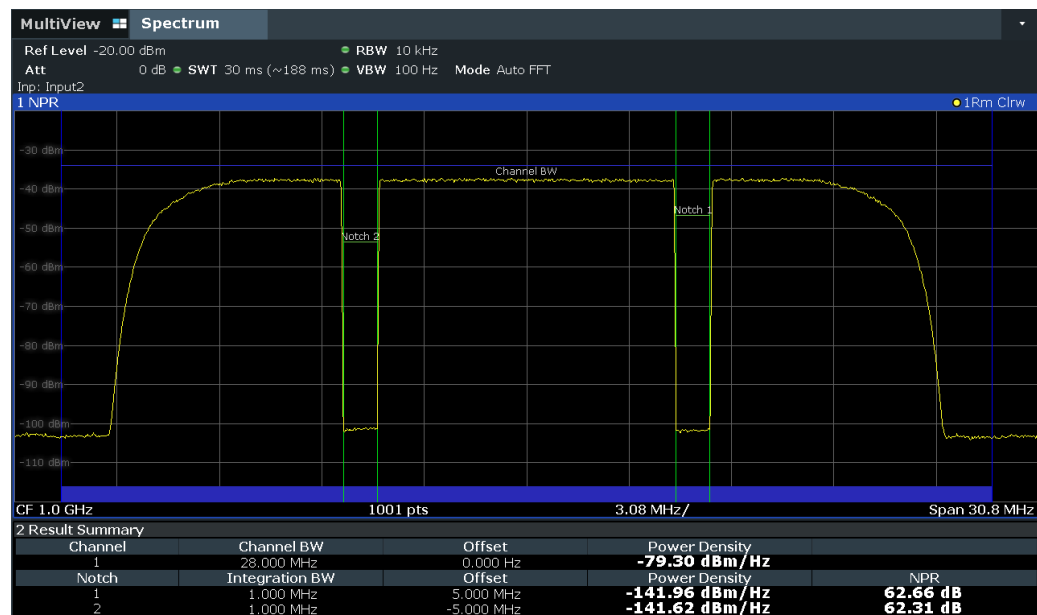

In the result summary, the following results are provided for the specified channel and individual notches:

**Table 6-10: Noise Power Ratio result summary parameters**

Parameter	Description
"Channel" / "Notch"	Channel or notch number
"Channel BW" (auto mode) / "Integration BW"	Specified channel bandwidth or manually defined integration bandwidth used as basis for power density calculation in total channel or notch
"Offset"	Frequency offset of notch or integration bandwidth to center frequency

Noise power ratio (NPR) measurement

Parameter	Description
"Channel Power" / "Power density"	Power measured in channel or notch - absolute value or density (= power divided by the "Channel BW"/"Integration BW" in dBm/Hz)
"NPR"	(Notches only:) Ratio of total channel power density to notch power density in dB

**Remote command:**

Channel power (density), notch power density, power ratio:

CALCulate<n>:NPRatio:RESult? on page 996

Measured power values for each sweep point (by default 1001):

TRAC:DATA? TRACe1 (see TRACe<n>[:DATA] on page 1258).

### 6.5.4 NPR configuration

**Access:** "Overview" > "Select Measurement" > "Noise Power Measurement" > "NPR Config" > "Noise Power Ratio" tab

The FSW noise power ratio measurement allows you to specify your satellite channel and up to 25 notch filters in your measurement setup. For a more general measurement, the bandwidth on which the total power density is based can be selected freely.

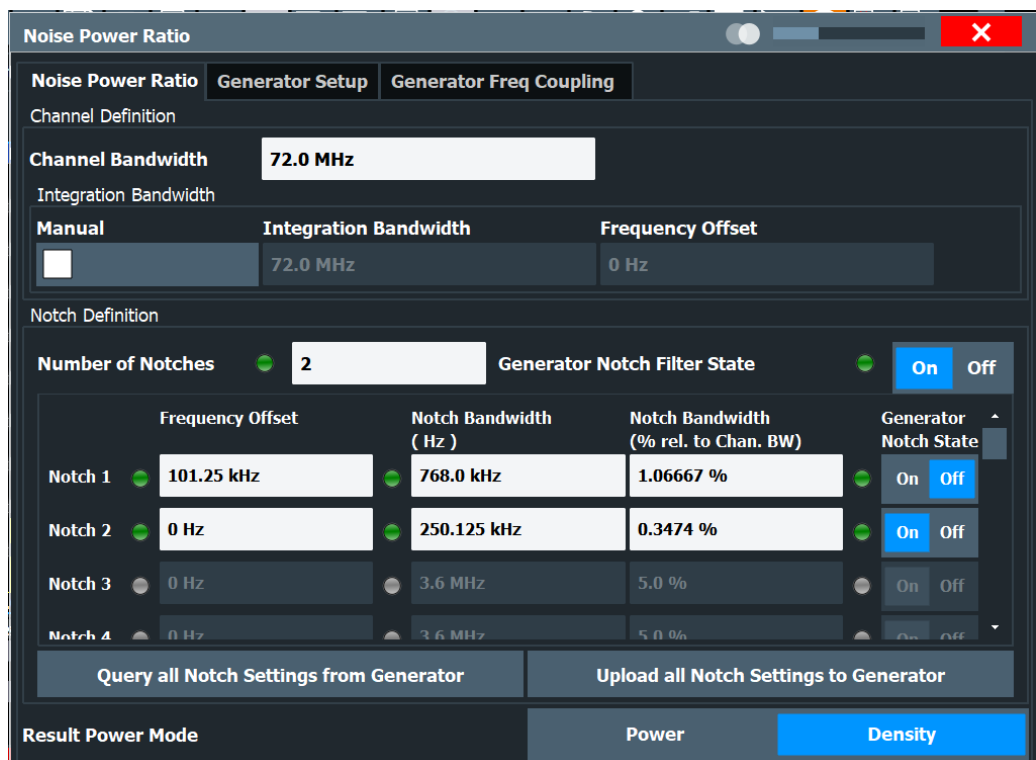

Figure 6-43: Noise Power Ratio configuration dialog with a signal generator connected



An LED next to a setting indicates whether the setting was adjusted on the connected generator successfully. They are only available if a valid generator IP address is detected (see "IP Address" on page 226).

The LED indicates the following states:

- **green:** setting on the FSW is valid and was successfully applied on the signal generator
- **red:** control error, for example because the specified value cannot be applied on the signal generator
- **gray:** signal generator control off

Note that if you change the setting on the generator manually, the analyzer does not adapt the setting automatically. The green LED for a previous successful transmission does not change.

Channel Bandwidth.....	221
Integration Bandwidth.....	221
Number of Notches.....	222
Generator Notch Filter State.....	222
Frequency Offset per Notch.....	222
Notch Bandwidth (Absolute / Relative to Channel BW).....	222
Generator Notch State.....	223
Upload all Notch Settings to Generator.....	223
Query all Notch Settings from Generator.....	223
Result Power Mode.....	224

### Channel Bandwidth

Defines the channel bandwidth on which the total power density is based. The bandwidth is positioned around the currently defined [Center Frequency](#).

To specify a different bandwidth for total power density calculation, or to shift the bandwidth, define an [Integration Bandwidth](#) manually.

Remote command:

`[SENSe:]NPRatio:CHANnel:BWIDth` on page 982

### Integration Bandwidth

Defines a bandwidth other than the channel bandwidth to be used for total power density calculation. Select the "Manual" option and define the bandwidth manually.

In auto mode, the integration bandwidth is the same as the channel bandwidth.

Notches are deducted from the results.

In manual mode, you can customize the integration bandwidth. The results include the power levels measured within notches, however.

A "Frequency Offset" shifts the bandwidth away from the currently defined [Center Frequency](#).

Remote command:

`[SENSe:]NPRatio:CHANnel:INTEgration:BWIDth` on page 983

`[SENSe:]NPRatio:CHANnel:INTEgration:AUTO` on page 983

`[SENSe:]NPRatio:CHANnel:INTEgration:FREQuency:OFFSet` on page 984

**Number of Notches**

Defines the number of notches for which results are determined. A maximum of 25 notches can be defined. Note that even if bandwidths for further notches are defined, only the number specified here are actually calculated and displayed.

If [Generator Control State](#) is enabled in the generator settings, the specified number of notches is sent to the generator on upload. An LED next to the setting indicates whether the setting was adjusted on the connected instrument successfully.

See [Chapter 6.5.3, "NPR results"](#), on page 219 for more information about how notches are treated in the measurement.

Remote command:

[\[SENSe:\]NPRatio:NOTCh<notch>:COUNT](#) on page 985

[CONFigure:GENerator:NPRatio:NOTCh<notch>:COUNT:CSTate?](#) on page 992

**Generator Notch Filter State**

Activates or deactivates a notch filter on the signal generator.

This setting is only available if [Generator Control State](#) is enabled. Its value is only sent to the signal generator when you select [Upload all Generator Setup Settings to Generator](#). An LED next to the setting indicates whether the setting was adjusted on the connected instrument successfully.

Remote command:

[CONFigure:GENerator:NPRatio\[:STATe\]](#) on page 994

[CONFigure:GENerator:NPRatio:STATe:CSTate?](#) on page 994

**Frequency Offset per Notch**

Defines the center position of the notch in relation to the currently defined [Center Frequency](#).

If [Generator Control State](#) is enabled, the frequency offset for the notch is sent to the generator on upload. An LED next to the setting indicates whether the setting was adjusted on the connected instrument successfully.

If a variable frequency definition is used (see [Chapter 6.5.6, "Generator frequency coupling"](#), on page 229), the defined factor ([Numerator](#) / [Denominator](#)) is also applied to the frequency offset per notch.

$\text{FreqOffset}_{\text{Gen}} = \text{Numerator} / \text{Denominator} * \text{FreqOffset}_{\text{Analyzer}}$

Remote command:

[\[SENSe:\]NPRatio:NOTCh<notch>:FREQUENCY:OFFSet](#) on page 985

[CONFigure:GENerator:NPRatio:NOTCh<notch>:FREQUENCY:OFFSet:CSTate?](#) on page 990

**Notch Bandwidth (Absolute / Relative to Channel BW)**

Defines the bandwidth of the individual notch either as an absolute value, or as a percentage of the defined [Channel Bandwidth](#).

If [Generator Control State](#) is enabled, the absolute notch bandwidth is sent to the generator on upload. An LED next to the setting indicates whether the setting was adjusted on the connected instrument successfully.

## Noise power ratio (NPR) measurement

If a variable frequency definition is used (see [Chapter 6.5.6, "Generator frequency coupling"](#), on page 229), the defined factor ([Numerator](#) / [Denominator](#)) is also applied to the absolute notch bandwidth.

$$\text{Notch\_BW}_{\text{Gen}} = \text{Numerator} / \text{Denominator} * \text{Notch\_BW}_{\text{Analyzer}}$$

Remote command:

[\[SENSe:\]NPRatio:NOTCh<notch>:BWIDth\[:ABSolute\]](#) on page 985

[\[SENSe:\]NPRatio:NOTCh<notch>:BWIDth:RELative](#) on page 984

[CONFigure:GENerator:NPRatio:NOTCh<notch>:BWIDth:ABSolute:CState?](#) on page 990

### Generator Notch State

If enabled, the notch is considered for signal generation on the connected signal generator.

This setting is only available if [Generator Control State](#) is enabled. Its value is only sent to the signal generator when you select [Upload all Generator Setup Settings to Generator](#). An LED next to the setting indicates whether the setting was adjusted on the connected instrument successfully.

Note: on the FSW, all notches are always active. The "Generator Notch State" parameter determines whether the individual notch is considered by the generator or not.

Remote command:

[CONFigure:GENerator:NPRatio:NOTCh<notch>\[:STATE\]](#) on page 991

[CONFigure:GENerator:NPRatio:NOTCh<notch>:STATE:CState?](#) on page 991

### Upload all Notch Settings to Generator

Transmits the notch settings defined on this tab from the FSW to the connected signal generator. The signal generator uses the settings to create an ARB waveform, which in turn is used as the input signal for the measurement.

In particular, the following settings are transmitted to the generator:

- [Generator Notch Filter State](#)
- [Number of Notches](#)

Per notch:

- [Frequency Offset per Notch](#)
- [Notch bandwidth \(absolute\)](#)
- [Generator Notch State](#)

As opposed to the general generator settings, changes to the notch settings are not applied to the generator immediately. Since creating the waveform can take some time, it is best done after all notch settings have been defined, rather than after each individual setting.

Remote command:

[CONFigure:GENerator:NPRatio:SETTings:NOTCh:UPDate](#) on page 994

### Query all Notch Settings from Generator

Queries all currently defined notch settings on the connected signal generator and applies the settings to the FSW.

This is useful directly after activating generator control, for example, or after making changes to the notch settings on the generator.

In particular, the following settings are transmitted to the analyzer:

- [Generator Notch Filter State](#)
- [Number of Notches](#)

Per notch:

- [Frequency Offset per Notch](#)
- [Notch bandwidth \(absolute\)](#)
- [Generator Notch State](#)

Remote command:

[CONFigure:SETTings:NPRatio:NOTCh](#) on page 996

### Result Power Mode

Determines whether the power measured in a channel or notch is indicated as a power or a density value.

"Power" Absolute power measured in channel or notch in current amplitude unit

"Density" Power measured in channel or notch divided by the "Channel BW"/"Integration BW" in dBm/Hz

Remote command:

[\[SENSe:\]NPRatio:MODE](#) on page 984

## 6.5.5 Generator setup

**Access:** "Overview" > "Select Measurement" > "Noise Power Measurement" > "NPR Config" > "Generator Setup" tab

The general settings required to control a connected signal generator by the FSW are defined here. The control settings are only available if a connection to a signal generator has been established.

The individual settings are only available if generator control is enabled.



Noise power ratio (NPR) measurement

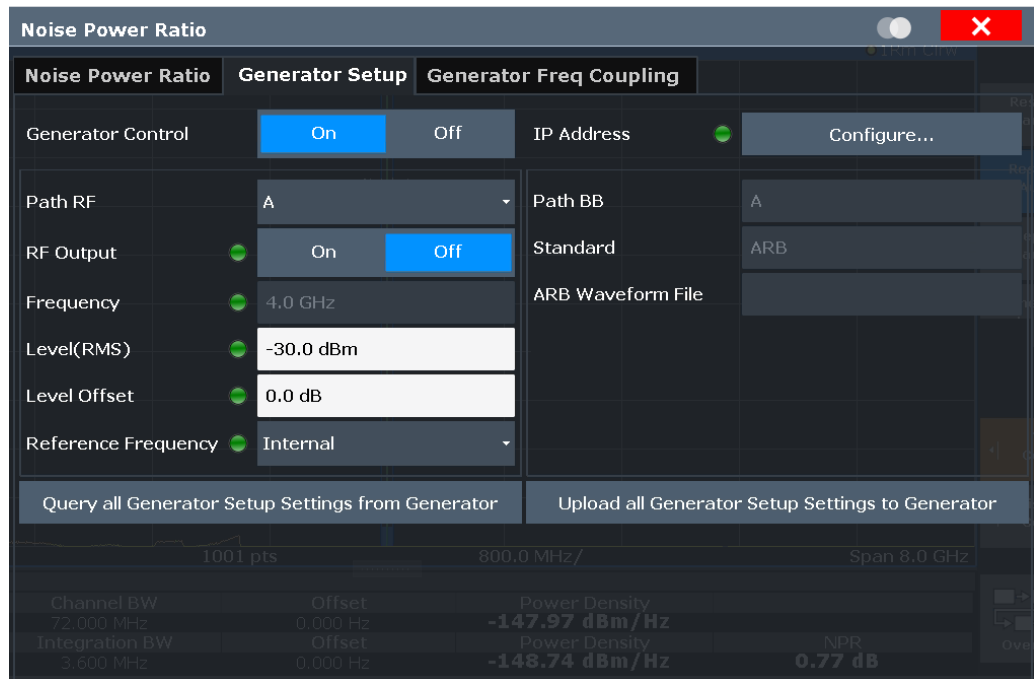

For each setting, an LED indicates whether the setting was adjusted on the connected generator successfully. Thus, you can quickly detect the cause of possible errors.

The LED indicates the following states:

- **green:** connection established and all settings valid
- **red:** control error, for example because a specified value cannot be applied on the signal generator
- **gray:** signal generator control off

If you change the setting on the generator manually after an automatic setting, the LED might not indicate the correct state.

**Remote command:**

[CONFigure:GENerator:NPRatio:STATE:CState?](#) on page 994

<a href="#">IP Address</a> .....	226
L <a href="#">IP Address / Computer Name</a> .....	226
L <a href="#">Connect/Disconnect</a> .....	226
<a href="#">Generator Control State</a> .....	227
<a href="#">Path RF/ Path BB</a> .....	227
<a href="#">RF Output State</a> .....	227
<a href="#">Frequency</a> .....	228
<a href="#">Level (RMS)</a> .....	228
<a href="#">Level Offset</a> .....	228
<a href="#">Reference Frequency</a> .....	228
<a href="#">Standard</a> .....	228

<a href="#">ARB Waveform File</a> .....	228
<a href="#">Upload all Generator Setup Settings to Generator</a> .....	229
<a href="#">Query all Generator Setup Settings from Generator</a> .....	229

### IP Address

Indicates the state and address of a connected signal generator.

The LED indicates the following connection states:

- **green:** connection established to compatible generator
- **red:** connection could not be established, possibly due to an incompatible instrument
- **gray:** no signal generator connected

Select the TCPIP address or "Configure" to define the connection information for the connected signal generator.

Remote command:

[CONFigure:GENerator:CONNECTION:CState?](#) on page 1454

### IP Address / Computer Name ← IP Address

The IP address or computer name of the signal generator connected to the FSW via LAN.

By default, the IP address is expected. To enter the computer name, toggle the "123"/"ABC" button to "ABC".

Select [Connect/Disconnect](#) to establish a connection from the FSW to the specified signal generator.

**Note:** While a connection to a signal generator is established, you cannot change the connection information.

The IP address / computer name is maintained after a [PRESET], and is transferred between applications. However, when you switch applications, the control is disabled in the other applications. Only one application can control a generator at any time.

Remote command:

[CONFigure:GENerator:IPConnection:ADDRESS](#) on page 1455

### Connect/Disconnect ← IP Address

The FSW attempts to establish a connection to the signal generator, or disconnects it.

If an instrument is connected, the following information is displayed:

- Device type
- Name and serial number
- Connection state

Remote command:

[CONFigure:GENerator:CONNECTION\[:STATe\]](#) on page 1454

[CONFigure:GENerator:CONNECTION:CSTate?](#) on page 1454

### Generator Control State

Activates or disables control of the signal generator by the FSW.

If a connection was defined in another measurement channel, the connection is maintained when you switch to the Spectrum application. However, generator control is disabled to protect the DUT from possibly erroneous or damaging settings. Check the settings, then enable the control state.

**Note:** While generator control is active, you cannot change the connection information. Only one channel can control a generator at any time. If you switch on generator control while it is still active in another channel, for example for parameter coupling with a generator, the control is disabled in the other channel.

Exception: The SCPI Recorder maintains control of the generator even if you switch channels.

For details on parameter coupling, see [Chapter 11.9, "Synchronizing measurement channel configuration"](#), on page 803.

As long as the FSW controls the signal generator, any (general) generator settings you define on the FSW are automatically adapted on the generator. The opposite does not apply, that is: changes you make on the generator are not automatically applied to the FSW. The green LED for a previous successful transmission does not change. Use the [Query all Generator Setup Settings from Generator](#) function to apply the generator settings on the FSW.

Remote command:

[CONFigure:GENerator:NPRatio:CONTRol\[:STATe\]](#) on page 988

### Path RF/ Path BB

Selects the RF signal path and indicates the BB signal path of the generator to be used for signal generation.

Remote command:

[CONFigure:GENerator:TARGet:PATH:RF](#) on page 996

[CONFigure:GENerator:TARGet:PATH:BB?](#) on page 995

### RF Output State

To protect the instrument from possibly erroneous or damaging settings, you must manually activate the RF output on the signal generator to start providing a signal. Check all settings on the signal generator, in particular the level settings, before activating the RF output.

A red LED on the "Generator Control" tab indicates a setting error on the generator.

Remote command:

[CONFigure:GENerator:RFOutput\[:STATe\]](#) on page 995

[CONFigure:GENerator:NPRatio:RFOutput:STATe:CSTate?](#) on page 993

**Frequency**

Defines the frequency of the signal provided by the signal generator.

If the [Generator Frequency Coupling State](#) is active, this value is read-only and indicates the resulting frequency setting on the generator.

Remote command:

[CONFigure:GENerator:FREQuency:CENTer](#) on page 987

[CONFigure:GENerator:NPRatio:FREQuency:CENTer:CState?](#) on page 988

**Level (RMS)**

(Default:) The specified power level is used for the output power by the connected signal generator.

Remote command:

[CONFigure:GENerator:POWer:LEVel](#) on page 995

[CONFigure:GENerator:NPRatio:POWer:LEVel:CState?](#) on page 992

**Level Offset**

Defines a fixed offset in the power level used by the generator, for example due to a gain from the DUT.

Remote command:

[CONFigure:GENerator:POWer:LEVel:OFFSet](#) on page 995

[CONFigure:GENerator:NPRatio:POWer:LEVel:OFFSet:CState?](#) on page 993

**Reference Frequency**

Selects the source of the generator reference frequency.

The internal reference is that of the signal generator itself.

An external reference is provided via the EXT connectors on the generator, for example by the FSW.

Remote command:

[CONFigure:GENerator:EXTernal:ROSCillator](#) on page 986

[CONFigure:GENerator:NPRatio:EXTernal:ROSCillator:CState?](#)  
on page 988

**Standard**

For reference only: the standard currently used by the signal generator. If no standard is defined on the generator, notched signals are not available (see "[Generator Notch Filter State](#)" on page 222).

Remote command:

[CONFigure:GENerator:NPRatio:BB:STANdard?](#) on page 987

**ARB Waveform File**

For reference only: the ARB waveform file currently used by the signal generator.

Remote command:

[CONFigure:GENerator:NPRatio:BB:ARBbitrary:WAVEform:SElect?](#)  
on page 987

### Upload all Generator Setup Settings to Generator

Applies all generator setup settings defined on this tab to the connected signal generator once.

This is useful directly after activating generator control, for example, or when you change settings on the generator. As soon as generator control is active, any changes to the general settings on the FSW are immediately applied to the generator automatically.

In particular, the following settings are transmitted to the generator:

- [RF Output State](#)
- [Frequency](#)
- [Level \(RMS\)](#)
- [Level Offset](#)
- [Reference Frequency](#)

Remote command:

`CONFigure:GENerator:NPRatio:SETTings:UPDate` on page 994

### Query all Generator Setup Settings from Generator

Queries all currently defined generator setup settings on the connected signal generator and applies the settings to the FSW.

This is useful directly after activating generator control, for example, or when you change settings on the generator. The FSW does *not* automatically adapt its settings when you make changes on the generator.

In particular, the following settings are transmitted to the analyzer:

- [RF Output State](#)
- [Frequency](#)
- [Level \(RMS\)](#)
- [Level Offset](#)
- [Reference Frequency](#)

Remote command:

`CONFigure:SETTings:NPRatio` on page 996

## 6.5.6 Generator frequency coupling

**Access:** "Overview" > "Select Measurement" > "Noise Power Measurement" > "NPR Config" > "Generator Freq Coupling" tab

These settings are only available if generator control is enabled (see "[Generator Control State](#)" on page 227).

Instead of defining a fixed frequency to be used by the signal generator, you can couple the frequency of the generator to the analyzer using a variable frequency definition.

Note that the frequency definition also affects the (absolute) [Notch Bandwidth \(Absolute / Relative to Channel BW\)](#) and the "[Frequency Offset per Notch](#)" on page 222.

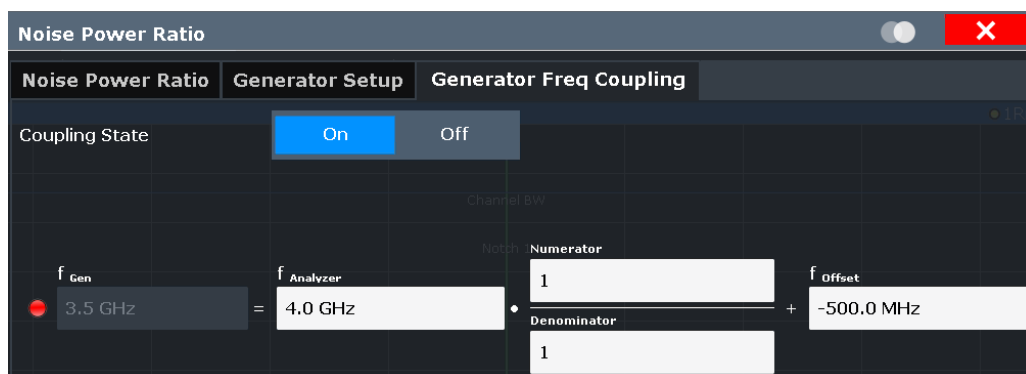

The overall status of the frequency coupling is indicated by an LED next to the frequency definition.

The LED indicates the following states:

- **green:** frequency setting valid
- **red:** frequency value cannot be applied on the signal generator
- **gray:** signal generator control or coupling off

Generator Frequency Coupling State.....	230
$f_{Gen}$ .....	230
$f_{Analyzer}$ .....	231
Numerator.....	231
Denominator.....	231
Frequency Offset.....	231

### Generator Frequency Coupling State

Enables or disables frequency coupling between the FSW and the connected generator.

If disabled, a fixed frequency is used by the generator.

Remote command:

[CONFigure:GENerator:NPRatio:FREQUENCY:COUPLing\[:STATe\]](#) on page 989

### $f_{Gen}$

Indicates the resulting frequency setting on the generator, depending on the other frequency parameters.

The generator frequency is defined as:

$$f_{Gen} = [f_{Analyzer} * \text{Numerator} / \text{Denominator}] + \text{Frequency Offset}$$

Any changes to one of the interdependent parameters automatically affect the calculated signal levels on the connected generator.

If [Generator Frequency Coupling State](#) is disabled, define a fixed frequency to be used by the generator.

Remote command:

[CONFigure:GENerator:FREQUENCY:CENTer](#) on page 987

[CONFigure:GENerator:NPRatio:FREQUENCY:CENTer:CSTate?](#) on page 988

**$f_{\text{Analyzer}}$** 

Sets the analyzer (center) frequency, which is used as a basis for the variable frequency definition.

Remote command:

`[SENSe:]FREQuency:CENTer` on page 1192

**Numerator**

Defines the numerator of the frequency-defining factor.

Note that this factor also affects the (absolute) [Notch Bandwidth \(Absolute / Relative to Channel BW\)](#) and the ["Frequency Offset per Notch"](#) on page 222.

Remote command:

`CONFigure:GENerator:NPRatio:FREQuency[:FACTor]:NUMerator`  
on page 990

**Denominator**

Defines the denominator of the frequency-defining factor.

Note that this factor also affects the (absolute) [Notch Bandwidth \(Absolute / Relative to Channel BW\)](#) and the ["Frequency Offset per Notch"](#) on page 222.

Remote command:

`CONFigure:GENerator:NPRatio:FREQuency[:FACTor]:DENominator`  
on page 989

**Frequency Offset**

Defines a fixed offset to be applied to the generator frequency.

Remote command:

`CONFigure:GENerator:NPRatio:FREQuency:OFFSet` on page 989

### 6.5.7 How to perform NPR measurements

Measuring the noise power ratio is a very easy and straightforward task with the FSW.

1. From the "Overview", select "Frequency".
2. Define the "Center Frequency" of your channel.
3. From the "Overview", select "Select Measurement".
4. Select "Noise Power Measurement".  
The measurement is started immediately with the default settings.
5. Select "NPR Config".
6. Specify the "Channel Bandwidth" of your entire channel.
7. If necessary, define an appropriate span.
8. Enter the "Number of notches" in your signal.

- For each notch, define the bandwidth (absolute or relative to the channel bandwidth) and its position (relative to the center frequency).

The channel and notches are indicated in the spectrum diagram, and the power results are indicated in the result summary.

### 6.5.8 Measurement example

Assume a satellite channel with a bandwidth of 72 MHz at a center frequency of 500 MHz. Notch filters are located around the subcarrier frequencies 487.8 MHz and 512.2 MHz, with a bandwidth of 3.6 MHz.

We will demonstrate how to determine the distortion caused by each subcarrier on the other, defined as the noise power ratio for each notch.



How to perform this measurement in a remote environment is described in [Chapter 13.5.6.5, "Programming example: measuring the noise power ratio"](#), on page 997.

	Frequency Offset	Notch Bandwidth (Hz)	Notch Bandwidth (% rel. to Chan. BW)	Generator Notch State
Notch 1	101.25 kHz	768.0 kHz	1.06667 %	On
Notch 2	0 Hz	250.125 kHz	0.3474 %	On
Notch 3	0 Hz	3.6 MHz	5.0 %	On
Notch 4	0 Hz	3.6 MHz	5.0 %	On

Buttons: Query all Notch Settings from Generator, Upload all Notch Settings to Generator

Result Power Mode: Power, Density

- From the "Overview", select "Frequency".
- Define the "Center Frequency" = 500 MHz.
- Define a "Span" = 80 MHz.
- From the "Overview", select "Select Measurement".
- Select "Noise Power Measurement".



Spectrum emission mask (SEM) measurement

6. Select "NPR Config".
7. Specify the "Channel Bandwidth" = 72 MHz.
8. Enter the "Number of notches" = 2.
9. For notch 1, define:
  - "Frequency Offset" = -12.2 MHz
  - "Notch Bandwidth Absolute" = 3.6 MHz
10. For notch 2, define:
  - "Frequency Offset" = +12.2 MHz
  - "Notch Bandwidth Relative" = 5 % (for demonstration purposes; the effect is the same as "Notch Bandwidth Absolute" = 3.6 MHz)

The channel and two notches are indicated in the spectrum diagram, and the noise power ratio for each notch is indicated in the result summary.

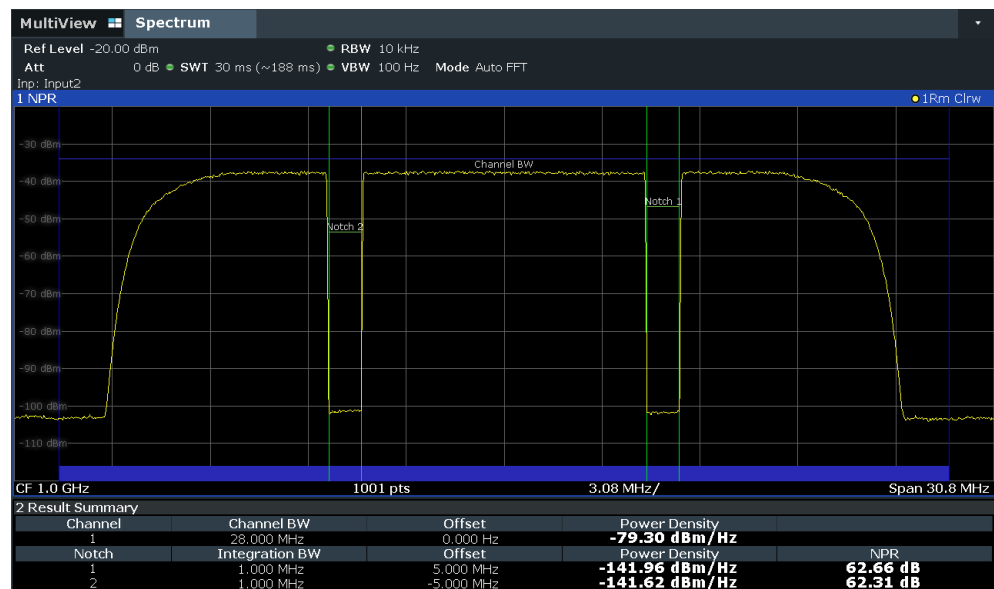

## 6.6 Spectrum emission mask (SEM) measurement

Spectrum Emission Mask (SEM) measurements monitor compliance with a spectral mask.

- [About the measurement](#).....234
- [Typical applications](#).....234
- [SEM results](#).....234
- [SEM basics](#).....237
- [SEM configuration](#).....247
- [How to perform a spectrum emission mask measurement](#).....266
- [Measurement example: Multi-SEM measurement](#).....270
- [Reference: SEM file descriptions](#).....272

### 6.6.1 About the measurement

The Spectrum Emission Mask (SEM) measurement defines a measurement that monitors compliance with a spectral mask. The mask is defined with reference to the input signal power. The FSW allows for a flexible definition of all parameters in the SEM measurement. The analyzer performs measurements in predefined frequency ranges with settings that can be specified individually for each of these ranges.

In the basic Spectrum application, spectrum emissions can be measured for multiple sub blocks of channels, where the sub blocks can include gaps or overlap, and define separate masks. Radio signals using multiple standards can also be analyzed.

SEM measurement configurations can be saved to an XML file which can then be exported to another application or loaded on the FSW again later. Some predefined XML files are provided that contain ranges and parameters according to the selected standard.

To improve the performance of the FSW for spectrum emission mask measurements, a "Fast SEM" mode is available.

A special limit check for SEM measurements allows for monitoring compliance of the spectrum.

### 6.6.2 Typical applications

Spectrum Emission Mask measurements are typically performed to ensure that modulated signals remain within the valid signal level ranges. These ranges are defined by a particular transmission standard, both in the transmission channel and neighboring channels. Any violations of the mask can interfere with other transmissions.

The 3GPP TS 34.122 standard, for example, defines a mask for emissions outside the transmission channel. This mask is defined relative to the input signal power. Three frequency ranges to each side of the transmission channel are defined.

### 6.6.3 SEM results

As a result of the Spectrum Emission Mask measurement, the following results are displayed in a diagram (see also [Chapter 6.6.4.2, "Limit lines in SEM measurements"](#), on page 240):

- The measured signal levels
- The result of the limit check (mask monitoring)
- The defined limit lines
- TX channel power "P"
- The used power class

Spectrum emission mask (SEM) measurement



**Multi-SEM measurements**

Multi-SEM measurements are SEM measurements with more than one sub block. In these measurements, each sub block has its own power class definitions. In this case, the power class is not indicated in the graphical result displays.

**Example:**

For example, in [Figure 6-44](#), "31 < P < 39" is indicated as the used power class is defined from 31 to 39.

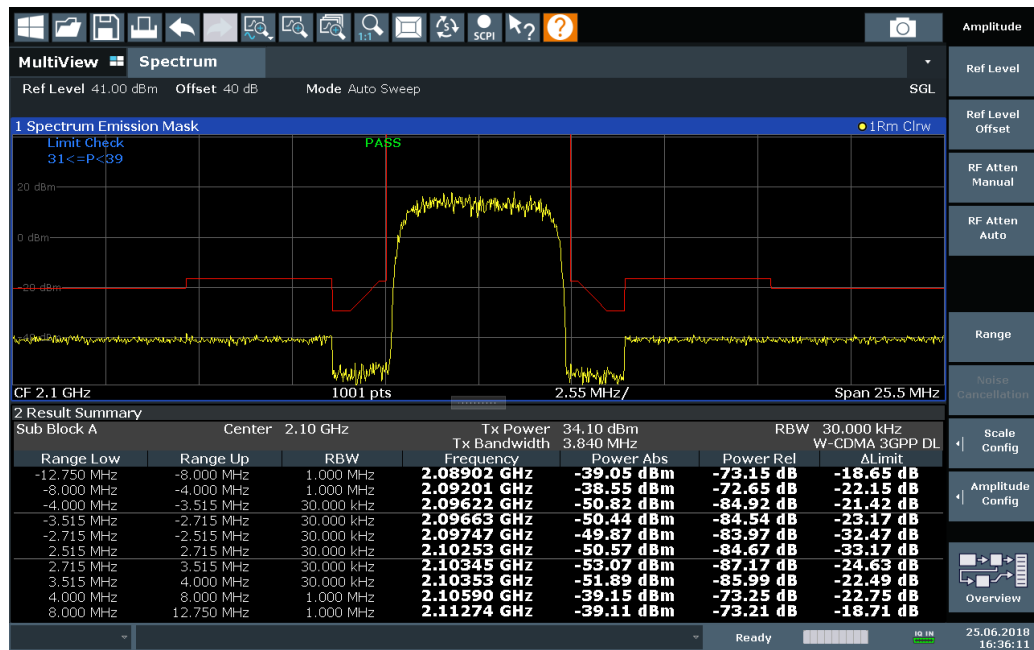

Figure 6-44: Spectrum Emission Mask result displays

In addition to the graphical results of the SEM measurement displayed in the diagram, a result summary is displayed to evaluate the limit check results (see also [Chapter 6.6.4.2, "Limit lines in SEM measurements"](#), on page 240).

The following information is provided in the result summary:

Label	Description
<b>General information</b>	
"Standard"	Loaded standard settings
"Tx Power"	Power of the reference range
"Tx Bandwidth"	Tx bandwidth used by the reference range
"RBW"	RBW used by the reference range
<b>Range results</b>	
"Range Low"	Start of the frequency range the peak value was found in
"Range Up"	Frequency range end the peak value was found in

## Spectrum emission mask (SEM) measurement

Label	Description
"RBW"	RBW of the range
"Frequency"	Frequency of the peak power level
"Power Abs"	Absolute peak power level within the range
"Power Rel"	Peak power level within the range, relative to the "Tx Power"
"ΔLimit"	Deviation of the peak power level from the limit line

You can define in which detail the data is displayed in the result summary in the "List Evaluation" settings (see [Chapter 6.6.5.7, "List evaluation \(results configuration\)"](#), on page 264). By default, one peak per range is displayed. However, you can change the settings to display only peaks that exceed a threshold ("Margin").

Detected peaks are not only listed in the Result Summary, they are also indicated by colored squares in the diagram (optionally, see [Show Peaks](#) in the "List Evaluation" settings).



Figure 6-45: Detected peak display in SEM measurement

Furthermore, you can export the results of the result summary to a file which can be exported to another application for further analysis.

### Results for SEM with multiple sub blocks

In the Spectrum application only, spectrum emissions can be measured for multiple sub blocks of channels (see [Chapter 6.6.4.5, "SEM with multiple sub blocks \("Multi-SEM"\)"](#), on page 244 for details). Up to 8 sub blocks (with 7 gaps) can be defined. For each sub block and each gap, the results described above are provided individually in the result summary.

## Spectrum emission mask (SEM) measurement

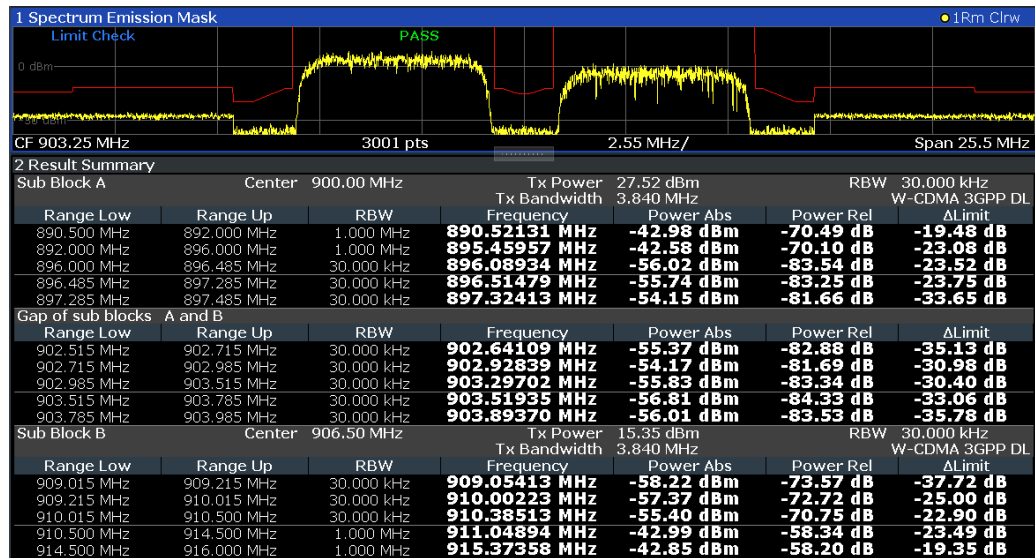

Figure 6-46: SEM results for multiple sub blocks

## Retrieving results via remote control

The measurement results of the spectrum emission mask *test* can be retrieved using the `CALC:LIM:FAIL?` command from a remote computer; see `CALCulate<n>`:  
`LIMit<li>:FAIL?` on page 1344 for a detailed description.

The *power* result for the reference range can be queried using  
`CALC:MARK:FUNC:POW:RES? CPOW`;

The *peak* power for the reference range can be queried using  
`CALC:MARK:FUNC:POW:RES? PPOW`, see `CALCulate<n>:MARKer<m>:FUNCTION:`  
`POWer<sb>:RESult?` on page 912.

The measured *power trace* can be queried using `TRAC:DATA?` and `TRAC:DATA:X?`,  
see `TRACe<n>[:DATA]` on page 1258 and `TRACe<n>[:DATA]:X?` on page 1261:

The measured *peak power list* can be queried using `TRAC:DATA? LIST`, see  
`TRACe<n>[:DATA]` on page 1258.

## 6.6.4 SEM basics

Some background knowledge on basic terms and principles used in SEM measurements is provided here for a better understanding of the required configuration settings.

- [Ranges and range settings](#)..... 238
- [Limit lines in SEM measurements](#)..... 240
- [Fast SEM measurements](#)..... 242
- [Multi-standard radio \(MSR\) SEM measurements](#)..... 243
- [SEM with multiple sub blocks \("Multi-SEM"\)](#)..... 244

### 6.6.4.1 Ranges and range settings

In the Spectrum Emission Mask measurements, a range defines a segment for which you can define the following parameters separately:

- Start and stop frequency
- RBW
- VBW
- "Sweep Time"
- "Sweep Points"
- Reference level
- Attenuator settings
- Preamplifier settings
- Transducer settings
- Limit values

Via the sweep list, you define the ranges and their settings. For details on settings, refer to [Chapter 6.6.5.1, "Sweep List"](#), on page 248.

For details on defining the limits (masks), see [Chapter 6.6.4.2, "Limit lines in SEM measurements"](#), on page 240.

#### Range definition

After a preset, the sweep list contains a set of default ranges and parameters. For each range, you can change the parameters listed above. You can insert or delete ranges.

The changes of the sweep list are only kept until you load another parameter set (by pressing [PRESET] or by loading an XML file). If you want a parameter set to be available permanently, create an XML file for this configuration (for details refer to ["How to save a user-defined SEM settings file"](#) on page 269).

If you load one of the provided XML files, the sweep list contains ranges and parameters according to the selected standard.

#### Reference range

The range containing the center frequency is defined as the reference range for all other ranges in the sweep list. All range limits are defined in relation to the reference range. The TX power used as a reference for all power level results in the result summary is also calculated for this reference range. You can define whether the power used for reference is the peak power level or the integrated power of the reference range. In the "Sweep List", the reference range is highlighted in blue and cannot be deleted.

#### Rules

The following rules apply to ranges:

- The minimum span of a range is 20 Hz.
- The individual ranges must not overlap (but can have gaps).

- The maximum number of ranges is 30.
- The minimum number of ranges is 3.
- The reference range cannot be deleted.
- Center the reference range on the center frequency.
- The current "Tx Bandwidth" defines the minimum span of the reference range (see ["Channel Power Settings"](#) on page 257).
- Define frequency values for each range relative to the center frequency.



### Changing the frequency range of the measurement using external mixers

If you change the used frequency range of the measurement by activating or deactivating an external mixer, the FSW automatically adapts the span to full span. Thus, the ranges for the SEM measurement can change, as well.

### Sweep points

You can define a minimum number of sweep points for each range. The total number of available sweep points is then distributed among the ranges in consideration of the minimum values. If the total number of sweep points is not enough to satisfy the minimum sweep point requirements in all ranges, the FSW adjusts the global number of [Sweep Points](#) accordingly. By default, each range has a minimum of one sweep point.

This allows you to increase the resolution within a specific range for detailed analysis. You do not have to increase the overall number of sweep points and thus the measurement time for the SEM measurement.

### Symmetrical ranges

You can easily define a sweep list with symmetrical range settings, i.e. the ranges to the left and right of the reference range are defined symmetrically. When symmetrical setup is activated, the current sweep list configuration is changed to define a symmetrical setup regarding the reference range. The number of ranges to the left of the reference range is reflected to the right, i.e. any missing ranges on the right are inserted, while superfluous ranges are removed. The values in the ranges to the right of the reference range are adapted symmetrically to those in the left ranges.

Symmetrical ranges fulfill the conditions required for "Fast SEM" mode (see [Chapter 6.6.4.3, "Fast SEM measurements"](#), on page 242).

### Power classes

If the signal power level to be monitored varies and the limits vary accordingly, you can define power classes, which can then be assigned to the frequency ranges. Thus, the limits for the signal levels can be defined differently for varying input levels. For instance, for higher input levels a transmission standard can allow for higher power levels in adjacent channels, whereas for lower input levels the allowed deviation can be stricter. Up to four different power classes can be defined.

## Spectrum emission mask (SEM) measurement

## 6.6.4.2 Limit lines in SEM measurements

For the FSW, the spectrum emission mask is defined using limit lines. Limit lines allow you to check the measured data (that is, the trace results) against specified limit values. Generally, it is possible to define limit lines for any measurement in the Spectrum application using the [Lines] function. For SEM measurements, however, special limit lines are available via the "Sweep List", and it is strongly recommended that you use only these limit line definitions.

In the "Sweep List", you can define a limit line for each power class that varies its level according to the specified frequency ranges. Special limit lines are automatically defined for each power class according to the current "Sweep List" settings every time the settings change. These limit lines are labeled "\_SEM\_LINE\_<xxx>\_ABS<0...3>" and "\_SEM\_LINE\_<xxx>\_REL<0...3>", where <xxx> is an index to distinguish limit lines between different channels.

The limit line defined for the currently used power class is indicated by a red line in the display. The result of the limit check is indicated at the top of the diagram. Note that only "Pass" or "Fail" is indicated; a "Margin" function as for general limit lines is not available.

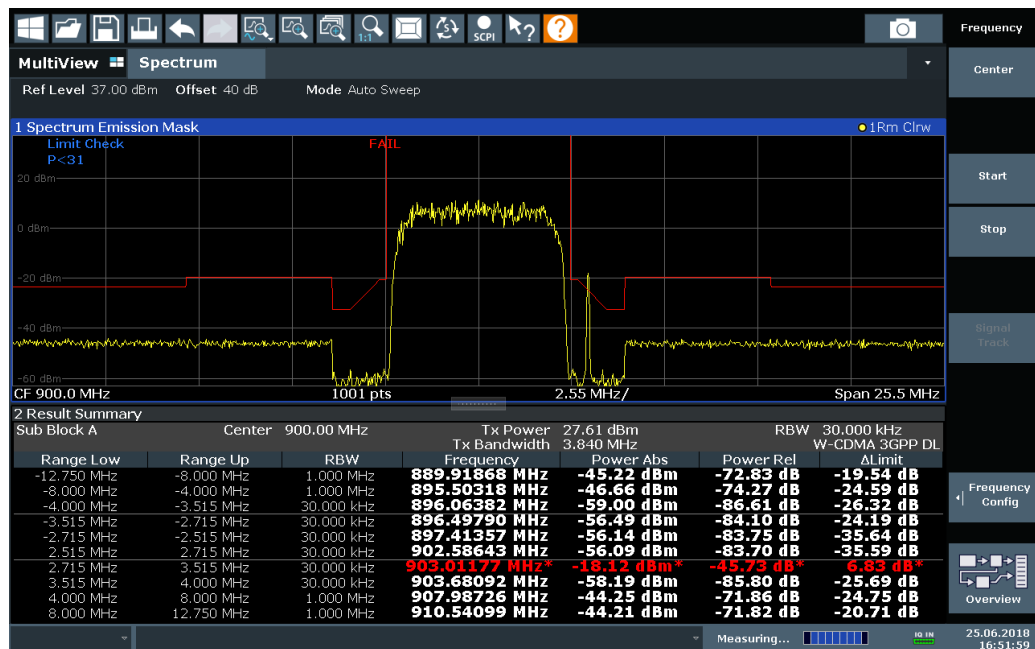

The indicated limit line depends on the settings in the "Sweep List". Several types of limit checks are possible:

Table 6-11: Limit check types

Limit check type	Pass/fail criteria	Limit line definition
"Absolute"	Absolute power levels must not exceed limit line	Defined by the "Abs Limit Start"/ "Abs Limit Stop" values for each range
"Relative"	Power deviations relative to the TX channel power must not exceed limit line	Defined by the "Rel Limit Start"/ "Rel Limit Stop" values (relative to the TX channel power), fixed for each range.



## Spectrum emission mask (SEM) measurement

Limit check type	Pass/fail criteria	Limit line definition
"Relative with function f(x)"	If the power exceeds <b>both</b> the absolute <b>and</b> the relative limits, the check fails (see <a href="#">Relative limit line functions</a> below)	Defined by the maximum of the absolute or relative start and stop limit values for each range. Thus, the start or stop point of the limit range, or both, are variable (since the maximum can vary).
"Abs and Rel"	If the power exceeds <b>both</b> the absolute <b>and</b> the relative limits, the check fails.	The less strict (higher) limit line is displayed for each range.  If you use a function to define the relative limit start or stop value, the signal is checked against an additional condition: the power must exceed the absolute limit, as well as the absolute and relative function values.
"Abs or Rel"	If the power exceeds <b>either</b> the absolute <b>or</b> the relative limits, the check fails.	The stricter (lower) limit line is displayed for each range.  If you use a function to define the relative limit start or stop value, the signal is checked against an additional condition: if the power exceeds the absolute limit, or the higher of the absolute and relative function values, the check fails.

**Relative limit line functions**

A new function allows you to define limit lines whose start or end points (or both) are variable, depending on the carrier power. Thus, the resulting limit line can change its slope within the range, depending on the carrier power. Common relative limit lines are calculated once for the defined start and end points and maintain a constant slope.

If the relative limit value function is used in combination with the "Abs and Rel" or "Abs or Rel" limit check types, an additional condition is considered for the limit check (see [Table 6-11](#)).

**Limit check results in the result summary**

For each range, the peak measured value and the deviation of these values from the limit line are displayed in the result summary. If the limit check is passed for the range, the deviation represents the closest value to the limit line. If the limit check is passed for the range, the deviation represents the closest value to the limit line. If the limit check for the range fails, the deviation represents the maximum violation against the limit line. Furthermore, the absolute power levels and the relative deviation of the peaks from the TX channel power are displayed. Values that exceed the limit are indicated in red and by an asterisk (\*).

A2 Spectrum Emission Mask				W-CDMA 3GPP (31,39)dBm DL		
Tx Power -28.10 dBm		Tx Bandwidth 3.840 MHz		RBW 1.000 MHz		
Range Low	Range Up	RBW	Frequency	Power Abs	Power Rel	ΔLimit
-12.750 MHz	-8.000 MHz	1.000 MHz	13.24173 GHz*	-47.08 dBm*	-18.98 dB*	35.52 dB*
-8.000 MHz	-4.000 MHz	1.000 MHz	13.24364 GHz*	-25.01 dBm*	3.09 dB*	53.59 dB*
-4.000 MHz	-3.515 MHz	30.000 kHz	13.24619 GHz	-100.18 dBm	-72.08 dB	-8.58 dB
-3.515 MHz	-2.715 MHz	30.000 kHz	13.24668 GHz	-105.92 dBm	-77.83 dB	-17.23 dB



Although a margin functionality is not available for the limit check, a margin (threshold) for the peak values to be displayed in the Result Summary can be defined. (In the "List Evaluation" settings, see [Chapter 6.6.5.7, "List evaluation \(results configuration\)"](#), on page 264).

### 6.6.4.3 Fast SEM measurements

To improve the performance of the FSW for spectrum emission mask measurements, a "Fast SEM" mode is available. If this mode is activated, several consecutive ranges with identical sweep settings are combined to one sweep internally, which makes the measurement considerably faster. The displayed results remain unchanged and still consist of several ranges. Thus, measurement settings that apply only to the results, such as limits, can nevertheless be defined individually for each range.

#### Prerequisites

"Fast SEM" mode is available if the following criteria apply:

- The frequency ranges are consecutive, without frequency gaps
- The following sweep settings are identical (for details see [Chapter 6.6.5.1, "Sweep List"](#), on page 248):
  - "Filter Type"
  - "RBW"
  - "VBW"
  - "Sweep Time Mode"
  - "Reference Level"
  - "RF Attenuation Mode"
  - "RF Attenuation"
  - "Preamplifier"

#### Activating Fast SEM mode

"Fast SEM" mode is activated in the sweep list (see [Chapter 6.6.5.1, "Sweep List"](#), on page 248) or using a remote command. Activating the mode for one range automatically activates it for all ranges in the sweep list.

#### Remote command:

`[SENSe:]ESpectrum<sb>:HSPEED` on page 1002



#### Fast SEM not supported for multiple sub blocks

For SEM with multiple sub blocks, fast SEM is not available. If more than one sub block is defined and a standard is loaded which contains an active fast SEM setting, this setting is disabled.

For more information on multi-SEM measurements, see [Chapter 6.6.4.5, "SEM with multiple sub blocks \("Multi-SEM\)"](#), on page 244.

## Spectrum emission mask (SEM) measurement

## Consequences

When the "Fast SEM" mode is activated, the ranges for which these criteria apply are displayed as one single range. The sweep time is defined as the sum of the individual sweep times, initially, but can be changed.



If "Symmetrical Setup" mode is active when "Fast SEM" mode is activated, not all sweep list settings can be configured symmetrically automatically (see also "Symmetrical Setup" on page 254).

Any other changes to the sweep settings of the combined range are applied to each included range and remain changed even after deactivating "Fast SEM" mode.

## Example

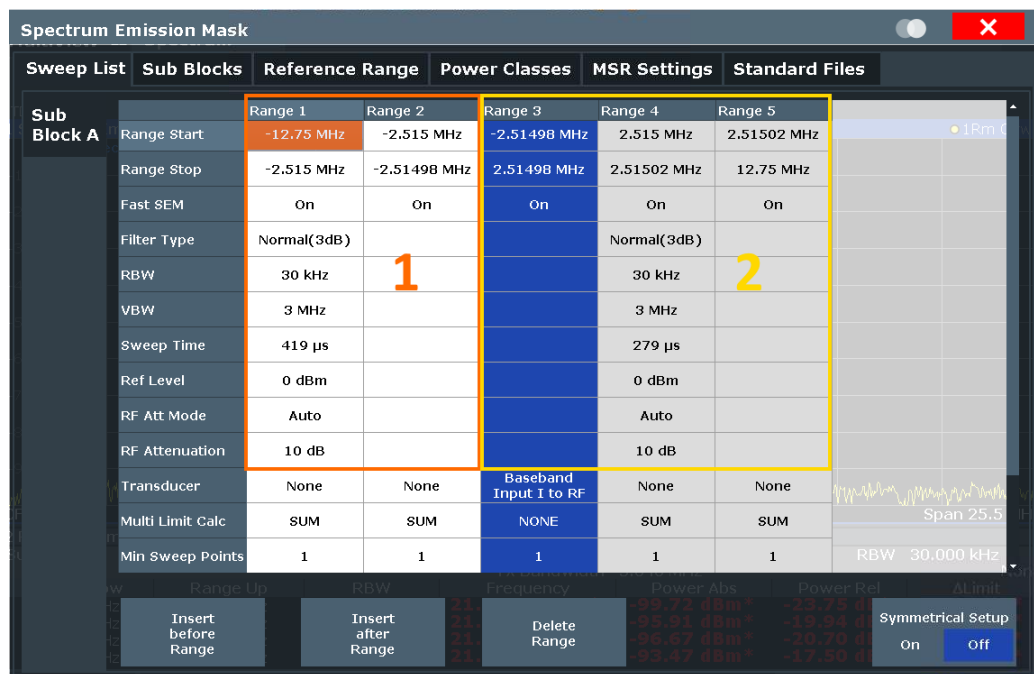

Figure 6-47: Sweep list using Fast SEM mode

In Figure 6-47, a sweep list is shown for which Fast SEM is activated. The formerly five separately defined ranges are combined to two sweep ranges internally.

#### 6.6.4.4 Multi-standard radio (MSR) SEM measurements

Multi-standard radio (MSR) measurements allow you to perform SEM tests on signals with multiple carriers using different digital standards. MSR measurements are described in the specification 3GPP TS 37.141. Various typical combinations of standards for base station tests are described, e.g. LTE FDD and W-CDMA carriers. By performing an MSR SEM measurement you can determine if or how the different carriers affect each other, i.e. if unwanted emissions occur. On the FSW, the MSR SEM measurement is a standard measurement as for single carriers. The MSR settings merely pro-

vide a convenient way of configuring the sweep list for all required ranges according to the specification quickly.

Refined settings allow the FSW to calculate the SEM limits according to standard 3GPP 37.141 V12.2.0, which distinguishes between base station configurations and power values.

#### 6.6.4.5 SEM with multiple sub blocks ("Multi-SEM")

In the Spectrum application application only, spectrum emissions can be measured for multiple sub blocks of channels (also referred to as a "Multi-SEM" measurement). Sub blocks are a set of multiple ranges around a defined center frequency (carrier). Multiple sub blocks can include gaps or overlap, and each sub block defines a separate mask. In the overlapping masks, multi-limit lines are calculated. Up to 8 sub blocks (with 7 gaps) can be defined. For each sub block, the familiar configuration settings concerning ranges, limit lines etc. can be defined individually.

##### Comparison to "traditional" SEM measurement

The default SEM measurement is simply a special case of "*Multi-SEM*" - consisting of one single block. Only if the number of sub blocks in the basic SEM configuration is larger than 1, multiple sub blocks are inserted in the configuration settings and result tables.

##### Particular features of configuring multiple sub blocks

The sub blocks are independent of the global start, stop, center and span frequencies for the complete SEM measurement. Thus, there can be gaps that can even include other carrier ranges, but are not configured for the SEM measurement.

For each sub block, you define:

- The center frequency of the reference range of the sub block; center frequencies must be defined in ascending order for sub blocks A,B,C
- The reference range; note that although individual ranges of different sub blocks can overlap, reference ranges for different sub blocks *cannot*; they must define distinct frequency ranges
- The sweep list, including the limit lines
- Optionally: a standard file *or* MSR settings to be used for measurement (if one is selected, the other is disabled)



##### Fast SEM not supported for multiple sub blocks

For SEM with multiple sub blocks, fast SEM is not available. If more than one sub block is defined and a standard is loaded which contains an active fast SEM setting, this setting is disabled.

##### Absolute vs relative frequencies

In the default configuration with only one sub block, frequencies are defined relative to the center frequency; this is the familiar configuration.

For setups with more than one sub block, frequencies are defined relative to the center frequency of the reference ranges for the individual sub blocks. However, in the result summary, frequencies are indicated as absolute values. Relative frequencies that refer to different reference ranges would be inconvenient and difficult to analyze.

### Limit check behavior for overlapping masks

Since spectrum emission masks are defined individually for each sub block, and sub blocks can overlap, the question arises what happens during the limit check in the overlapping regions? To answer this question, we must distinguish the following cases:

- For the reference range, no limit checking is performed, as the reference range contains the carrier
- For other ranges, only the limit lines defined for ranges between the carriers, that is the reference ranges to either side, are significant. In other words: if a limit line definition covers the frequency area of several carriers, only the limit lines for ranges between the corresponding reference range and the next closest reference range are significant.

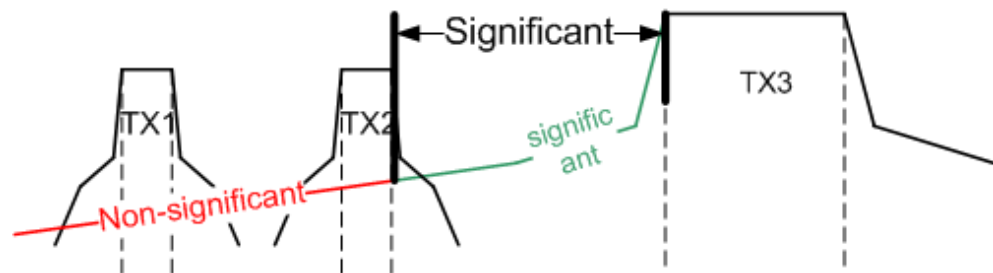

Figure 6-48: Behavior for overlapping masks

- For the ranges in which multiple limit lines are significant, a range-specific function determines the behavior of the limit check

### Limit calculation for individual ranges

For each range a function can be defined that determines the behavior of the limit check if there are multiple limit lines:

- **"NONE"**: In reference ranges no limit check is performed; Reference ranges always use the function "NONE". For other ranges, see the combinations for overlapping ranges below.
- **"SUM"**: sum of the two limit lines (calculated for linear powers) is used
- **"MAX"**: maximum of the two limit lines is used

This leads to the following **combinations for overlapping ranges**:

- **"MAX"+"MAX"**: maximum of the two limit lines is used
- **"MAX"+"SUM"**: maximum of the two limit lines is used
- **"SUM"+"SUM"**: sum of the two limit lines (calculated for linear powers) is used
- **"NONE"+"MAX"/"NONE"+"SUM"**: limit line (and parameters) of the "NONE" range are ignored
- **"NONE"+"NONE"**: depends on the position of the overlapping ranges in relation to the mid-frequency between the two neighboring sub blocks:

Spectrum emission mask (SEM) measurement

- Overlap is completely *below* the mid-frequency: limits and parameters of the left sub block are used
- Overlap is completely *above* the mid-frequency: limits and parameters of the right sub block are used
- Overlap crosses the mid-frequency: new subranges are created: one to the left of the mid-frequency, one to the right of the mid-frequency. The left subrange uses the limits and parameters of the left sub block, the right subrange uses the limits and parameters of the right sub block.



**Different RBWs in overlapping ranges**

If different RBWs are defined for the overlapping ranges, the following parameters from the range with the smaller RBW are considered for both ranges:

- RBW
- VBW
- Attenuation
- Reference level
- Transducer
- Filter type
- (proportional) sweep time

In the range with the higher RBW, the following offset is applied to the limit line:

$$-10 \cdot \log(RBW_{large} / RBW_{small})$$

Table 6-12: Limit lines in overlapping ranges crossing the mid-frequency

<p><b>Initial situation:</b> overlapping ranges Range 4 ("None") + Range 5 ("None") overlap and cross the mid-frequency between sub blocks 1 and 2</p>	<p><b>Result:</b> Subranges 4a and 5a are created left and right of the mid-frequency; For subrange 4a: limit line and parameters of range 4 apply For subrange 5a: limit line and parameters of range 5 apply</p>

## Spectrum emission mask (SEM) measurement

**Global SEM limit check**

For the complete SEM measurement, which can consist of multiple sub blocks, only one single limit check is performed. A single limit line is calculated according to the individual range limit lines and the defined functions for overlapping ranges. The measured values are then compared with this single limit line. If the limit is exceeded in any range, the result of the limit check is ." failed!"

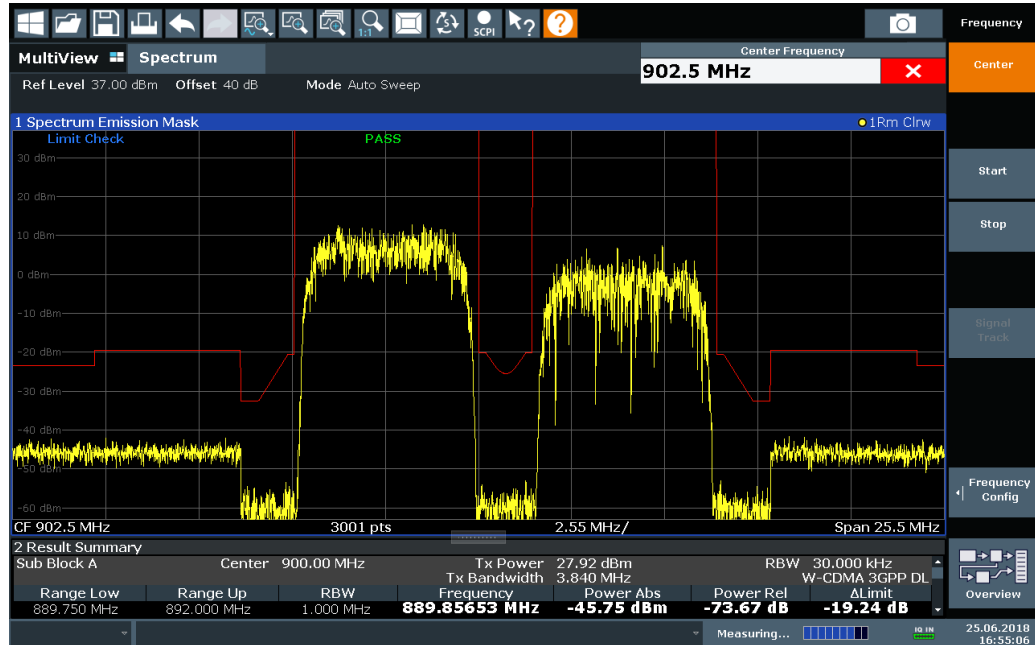

Figure 6-49: Summarized limit line for multiple sub blocks

### 6.6.5 SEM configuration

**Access:** "Overview" > "Select Measurement" > "Spectrum Emission Mask"

The SEM measurement is started immediately with the default settings.

The remote commands required to perform these tasks are described in [Chapter 13.5.7, "Measuring the spectrum emission mask"](#), on page 998.



#### Global span settings

The span of the signal to be monitored is configured in the general span settings (see [Chapter 7.3.2, "Frequency and span settings"](#), on page 473). Only ranges within this global span are considered for the SEM measurement.



### Multi-SEM configuration

In the Spectrum application application only, spectrum emissions can be measured for multiple sub blocks of channels (see [Chapter 6.6.4.5, "SEM with multiple sub blocks \("Multi-SEM"\)](#), on page 244). Up to 8 sub blocks (with 7 gaps) can be defined. For each sub block, the familiar configuration settings concerning ranges, limit lines etc. can be defined in individual tabs. In addition, settings on the sub blocks themselves must be configured in the "Sub Block" tab of the "Spectrum Emission Mask" configuration dialog box (see [Chapter 6.6.5.2, "Multi-SEM \(sub block\) settings"](#), on page 255).

The following settings are available in individual tabs of the "Spectrum Emission Mask" configuration dialog box.

- [Sweep List](#).....248
- [Multi-SEM \(sub block\) settings](#).....255
- [Reference range](#)..... 256
- [Power classes](#).....257
- [MSR settings](#).....259
- [Standard files](#)..... 262
- [List evaluation \(results configuration\)](#).....264

#### 6.6.5.1 Sweep List

**Access:** "Overview" > "Select Measurement" > "Spectrum Emission Mask" > "Sweep List"

For SEM measurements, the input signal is split into several frequency ranges which are swept individually and for which different limitations apply. You configure the individual frequency ranges and mask limits in the "Sweep List".



If you edit the sweep list, always follow the rules and consider the limitations described in [Chapter 6.6.4.1, "Ranges and range settings"](#), on page 238.



Spectrum emission mask (SEM) measurement

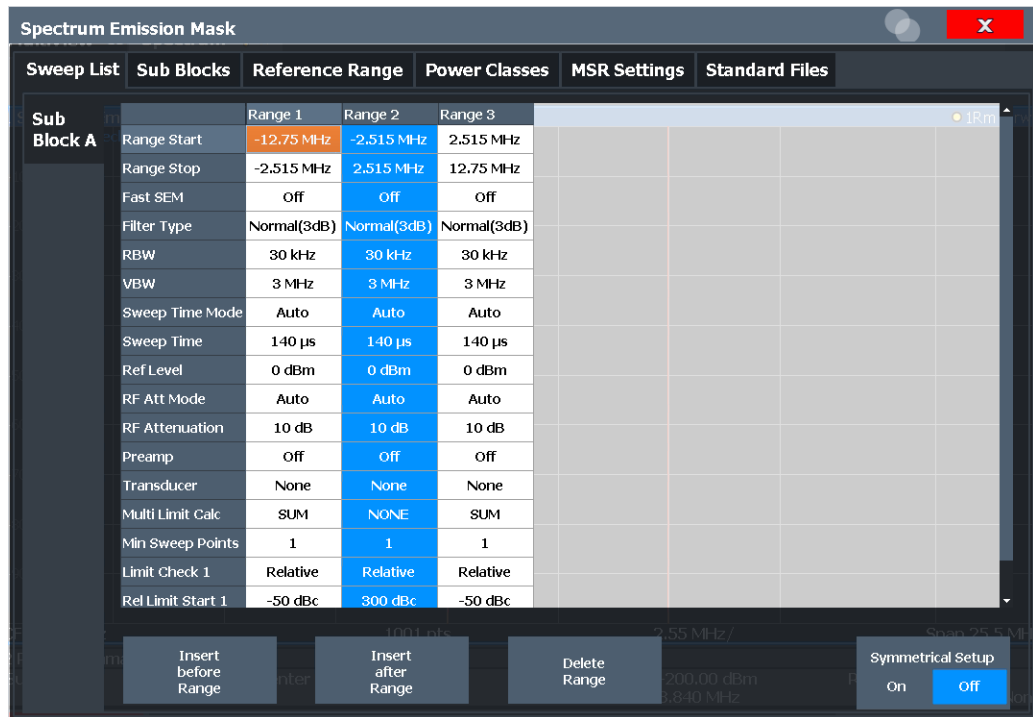

Range Start / Range Stop..... 249

Fast SEM..... 250

Filter Type..... 250

RBW..... 250

VBW..... 250

Sweep Time Mode..... 250

Sweep Time..... 251

Ref Level..... 251

RF Att Mode..... 251

RF Attenuation..... 251

SPA: RF Attenuation Mode / SPA: RF Attenuation..... 251

Preamp..... 252

Transducer Factor..... 252

Limit Check <n>..... 252

Abs Limit Start / Stop <n>..... 253

Rel Limit Start / Stop <n>..... 253

Multi-Limit Calc <n>..... 253

Min Sweep Points..... 254

Insert before Range / Insert after Range..... 254

Delete Range..... 254

Symmetrical Setup..... 254

**Range Start / Range Stop**

Sets the start frequency/stop frequency of the selected range.

## Spectrum emission mask (SEM) measurement

To change the start/stop frequency of the first or last range, respectively, select the appropriate span in the [SPAN] configuration dialog. You can set a span that is smaller than the overall span of the ranges. In this case, the measurement includes only the ranges that lie within the defined span and have a minimum span of 20 Hz. The first and last ranges are adapted to the given span as long as the minimum span of 20 Hz is not violated.

Define frequency values for each range relative to the center frequency. Center the reference range on the center frequency. The current "Tx Bandwidth" defines the minimum span of the reference range (see ["Channel Power Settings"](#) on page 257).

Remote command:

`[SENSe:]ESpectrum<sb>:RANGe<ri>[:FREQuency]:STArT` on page 1005

`[SENSe:]ESpectrum<sb>:RANGe<ri>[:FREQuency]:STOP` on page 1006

### Fast SEM

Activates "Fast SEM" mode for all ranges in the sweep list. For details, see [Chapter 6.6.4.3, "Fast SEM measurements"](#), on page 242.

**Note:** If you deactivate "Fast SEM" mode while "Symmetrical Setup" mode is on, "Symmetrical Setup" mode is automatically also deactivated.

If you activate "Fast SEM" mode while "Symmetrical Setup" mode is on, not all range settings can be configured symmetrically automatically.

Remote command:

`[SENSe:]ESpectrum<sb>:HSPEed` on page 1002

### Filter Type

Sets the filter type for this range.

For details on filter types, see [Chapter 7.5.1.6, "Which data may pass: filter types"](#), on page 496.

Remote command:

`[SENSe:]ESpectrum<sb>:RANGe<ri>:FILTer:TYPE` on page 1004

### RBW

Sets the resolution bandwidth for this range.

For details on the RBW, see [Chapter 7.5.1.1, "Separating signals by selecting an appropriate resolution bandwidth"](#), on page 492.

Remote command:

`[SENSe:]ESpectrum<sb>:RANGe<ri>:BANDwidth:RESolution` on page 1003

### VBW

Sets the video bandwidth for this range.

For details on the VBW, see [Chapter 7.5.1.2, "Smoothing the trace using the video bandwidth"](#), on page 493.

Remote command:

`[SENSe:]ESpectrum<sb>:RANGe<ri>:BANDwidth:VIDeo` on page 1003

### Sweep Time Mode

Activates or deactivates the auto mode for the sweep time.

## Spectrum emission mask (SEM) measurement

For details on the sweep time mode, see [Chapter 7.5.1.7, "How long the data is measured: Sweep Time"](#), on page 497

Remote command:

`[SENSe:]ESpectrum<sb>:RANGe<ri>:SWEep:TIME:AUTO` on page 1016

**Sweep Time**

Sets the sweep time value for the range.

For details on the sweep time, see [Chapter 7.5.1.7, "How long the data is measured: Sweep Time"](#), on page 497

Remote command:

`[SENSe:]ESpectrum<sb>:RANGe<ri>:SWEep:TIME` on page 1016

**Ref Level**

Sets the reference level for the range.

For details on the reference level, see [Chapter 7.4.1.1, "Reference level"](#), on page 479.

Remote command:

`[SENSe:]ESpectrum<sb>:RANGe<ri>:RLEVel` on page 1015

**RF Att Mode**

Activates or deactivates the auto mode for RF attenuation.

For details on attenuation, see [Chapter 7.4.1.2, "RF attenuation"](#), on page 480.

**Note:** If an external frontend is active (see [External frontend settings](#)), the required attenuation is applied to the input of the external frontend, not the FSW. However, you can configure additional attenuation for the analyzer (see [SPA: RF Attenuation Mode / SPA: RF Attenuation](#)). When using an external frontend, only mechanical attenuation is available.

For more information, see ["External frontend attenuation vs. analyzer attenuation"](#) on page 446.

Remote command:

`[SENSe:]ESpectrum<sb>:RANGe<ri>:INPut:ATTenuation:AUTO` on page 1006

**RF Attenuation**

Sets the attenuation value for the range.

For details on attenuation, see [Chapter 7.4.1.2, "RF attenuation"](#), on page 480.

Remote command:

`[SENSe:]ESpectrum<sb>:RANGe<ri>:INPut:ATTenuation` on page 1006

**SPA: RF Attenuation Mode / SPA: RF Attenuation**

If an external frontend is active (see [External frontend settings](#)), you can configure attenuation settings for the external frontend and the analyzer separately. This setting defines the attenuation for the analyzer.

For more information, see ["External frontend attenuation vs. analyzer attenuation"](#) on page 446.

When using an external frontend, only mechanical attenuation is available.

## Spectrum emission mask (SEM) measurement

The RF attenuation can be set automatically as a function of the selected reference level (Auto mode). Automatic attenuation ensures that no overload occurs at the RF Input connector for the current reference level. It is the default setting.

In "Manual" mode, you can set the RF attenuation in 1 dB steps (down to 0 dB). Other entries are rounded to the next integer value. The range is specified in the specifications document. If the defined reference level cannot be set for the defined RF attenuation, the reference level is adjusted accordingly and the warning "limit reached" is displayed.

**NOTICE!** Risk of hardware damage due to high power levels. When decreasing the attenuation manually, ensure that the power level does not exceed the maximum level allowed at the RF input, as an overload can lead to hardware damage.

Remote command:

`[SENSe:]ESpectrum<sb>:RANGe<ri>:INPut:SANalyzer:ATTenuation`  
on page 1008

`[SENSe:]ESpectrum<sb>:RANGe<ri>:INPut:SANalyzer:ATTenuation:AUTO`  
on page 1008

### Preamp

Switches the preamplifier on or off.

For details on the preamplifier, see "Preamplifier" on page 488.

Remote command:

`[SENSe:]ESpectrum<sb>:RANGe<ri>:INPut:GAIN:STATe` on page 1007

### Transducer Factor

Sets a transducer for the specified range. You can only choose a transducer that fulfills the following conditions:

- The transducer overlaps or equals the span of the range.
- The x-axis is linear.
- The unit is dB.

For details on transducers, see [Chapter 11.4.1, "Basics on transducer factors"](#), on page 754.

Remote command:

`[SENSe:]ESpectrum<sb>:RANGe<ri>:TRANsducer` on page 1017

### Limit Check <n>

Sets the type of limit check for the n-th power class in the range. Up to four limits are possible.

For details on limit checks, see [Chapter 6.6.4.2, "Limit lines in SEM measurements"](#), on page 240.

The limit state affects the availability of all limit settings.

Remote command:

`[SENSe:]ESpectrum<sb>:RANGe<ri>:LIMit<li>:STATe` on page 1014

`CALCulate<n>:LIMit<li>:FAIL?` on page 1344

**Abs Limit Start / Stop <n>**

Sets an absolute limit value for the n-th power class at the start or stop frequency of the range [dBm].

Remote command:

[SENSe:]ESpectrum<sb>:RANGe<ri>:LIMit<li>:ABSolute:START

on page 1009

[SENSe:]ESpectrum<sb>:RANGe<ri>:LIMit<li>:ABSolute:STOP

on page 1010

**Rel Limit Start / Stop <n>**

Sets a relative limit value for the n-th power class at the start or stop frequency of the range [dBc].

By default, this value is a fixed relative limit, i.e. no function is defined. To define a function for the relative limit, select the input field for "Rel Limit Start" or "Rel Limit Stop" and then the "f(x)" icon that appears.

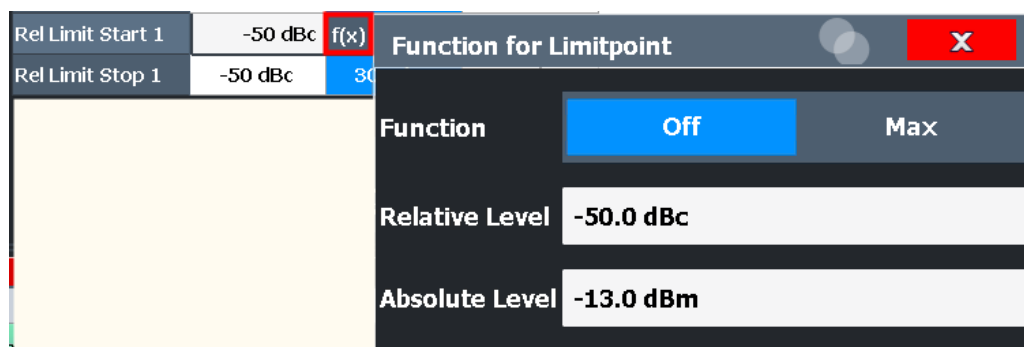

If the function is set to "Max", you can define a relative *and* an absolute limit level. In this case, the maximum of the two values is used as the limit level.

For more information, see ["Relative limit line functions"](#) on page 241.

Remote command:

[SENSe:]ESpectrum<sb>:RANGe<ri>:LIMit<li>:RELative:START

on page 1010

[SENSe:]ESpectrum<sb>:RANGe<ri>:LIMit<li>:RELative:STOP

on page 1012

[SENSe:]ESpectrum<sb>:RANGe<ri>:LIMit<li>:RELative:START:

FUNcTion on page 1011

[SENSe:]ESpectrum<sb>:RANGe<ri>:LIMit<li>:RELative:STOP:FUNcTion

on page 1013

[SENSe:]ESpectrum<sb>:RANGe<ri>:LIMit<li>:RELative:START:ABS

on page 1011

[SENSe:]ESpectrum<sb>:RANGe<ri>:LIMit<li>:RELative:STOP:ABS

on page 1013

**Multi-Limit Calc <n>**

Defines the function used to calculate the limit line for the n-th power class for overlapping ranges in Multi-SEM measurements. For details, see ["Limit calculation for individual ranges"](#) on page 245.

"NONE"	(reference ranges only:) the limit of the reference range is used
"SUM"	Sum of the two limit lines (calculated for linear powers) is used
"MAX"	Maximum of the two limit lines is used

Remote command:

[\[SENSe:\]ESpectrum<sb>:RANGe<ri>:MLCalc](#) on page 1015

### Min Sweep Points

Defines the minimum number of sweep points for the range.

If necessary to fulfill all minimum sweep point requirements in all ranges, the global [Sweep Points](#) setting is increased. By default, each range is supplied with a minimum of one sweep point.

For details, see ["Sweep points"](#) on page 239

Remote command:

[\[SENSe:\]ESpectrum<sb>:RANGe<ri>:POINts:MINimum\[:VALue\]](#) on page 1015

### Insert before Range / Insert after Range

Inserts a new range to the left (before) or to the right (after) of the range in which the cursor is currently displayed. The range numbers of the currently focused range and all higher ranges are increased accordingly. The maximum number of ranges is 30.

Remote command:

[\[SENSe:\]ESpectrum<sb>:RANGe<ri>:INSert](#) on page 1009

### Delete Range

Deletes the currently focused range, if possible. (The reference range cannot be deleted. A minimum of three ranges is required.) The range numbers are updated accordingly.

Remote command:

[\[SENSe:\]ESpectrum<sb>:RANGe<ri>:DELete](#) on page 1004

### Symmetrical Setup

Any changes to the range settings in active "Symmetrical Setup" mode lead to symmetrical changes in the other ranges (where possible). In particular, this means:

- Inserting ranges: a symmetrical range is inserted on the other side of the reference range
- Deleting ranges: the symmetrical range on the other side of the reference range is also deleted
- Editing range settings: the settings in the symmetrical range are adapted accordingly

**Note:** If "Fast SEM" mode is deactivated while "Symmetrical Setup" mode is on, "Sym Setup" mode is automatically also deactivated.

If "Fast SEM" mode is activated while "Symmetrical Setup" mode is on, not all range settings can be set automatically.

Remote command:

[\[SENSe:\]ESpectrum<sb>:SSETup](#) on page 1017

### 6.6.5.2 Multi-SEM (sub block) settings

**Access:** "Overview" > "Select Measurement" > "Spectrum Emission Mask" > "Sub Blocks"

In the Spectrum application application only, spectrum emissions can be measured for multiple sub blocks of channels (see [Chapter 6.6.4.5, "SEM with multiple sub blocks \("Multi-SEM"\)](#)", on page 244). Sub blocks are a set of multiple ranges around a defined center frequency (carrier).

By default, a single sub block is assumed. If more than one sub blocks are defined, additional tabs are inserted for each sub block in the individual tabs of the "Spectrum Emission Mask" configuration dialog box.

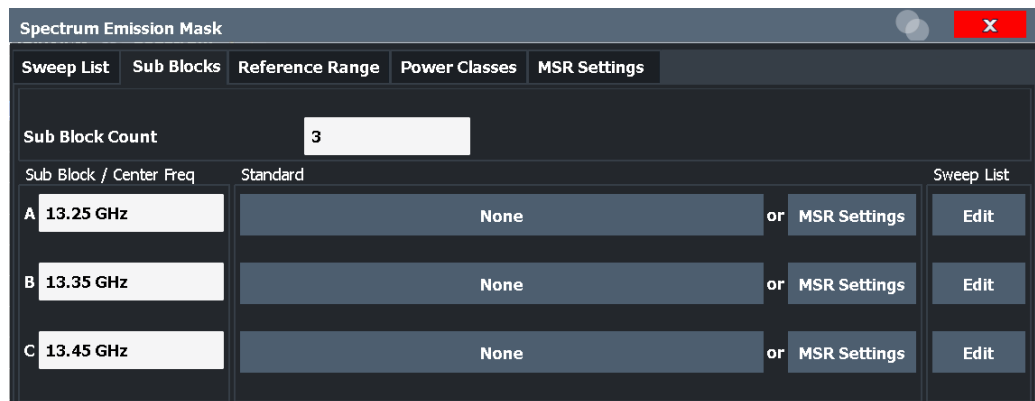

Sub Block Count.....	255
Sub Block / Center Freq.....	255
Standard / MSR Settings.....	255
Edit Sweep List.....	256

#### Sub Block Count

Defines the number of sub blocks. By default, the familiar SEM measurement with just one single block of ranges is configured.

Remote command:

[SENSe:]ESpectrum<sb>:SCount on page 1001

#### Sub Block / Center Freq

Defines the center frequency for an individual sub block. The center frequency determines the reference range used for each block.

For measurements with only one sub block, this setting corresponds to the global setting in the "Frequency" settings (see [Center Frequency](#)).

Remote command:

[SENSe:]ESpectrum<sb>:SCENter on page 1001

#### Standard / MSR Settings

Defines the use of a standard settings file or a multi-standard radio configuration for a particular sub block. For details, see [Chapter 6.6.5.6, "Standard files"](#), on page 262 and [Chapter 6.6.5.5, "MSR settings"](#), on page 259.

Note that *either* a standard *or* an MSR setting can be selected; if one is selected, the other is disabled.

Remote command:

[SENSe:]ESpectrum<sb>:PRESet[:STANdard] on page 999

Chapter 13.5.7.3, "Configuring a multi-sem measurement", on page 1000

**Edit Sweep List**

Switches to the "Sweep List" tab of the "Spectrum Emission Mask" dialog box to configure the individual frequency ranges and mask limits for the corresponding sub block. See Chapter 6.6.5.1, "Sweep List", on page 248.

**6.6.5.3 Reference range**

**Access:** "Overview" > "Select Measurement" > "Spectrum Emission Mask" > "Reference Range"

The range around the center frequency is defined as the reference range for all other ranges in the sweep list.

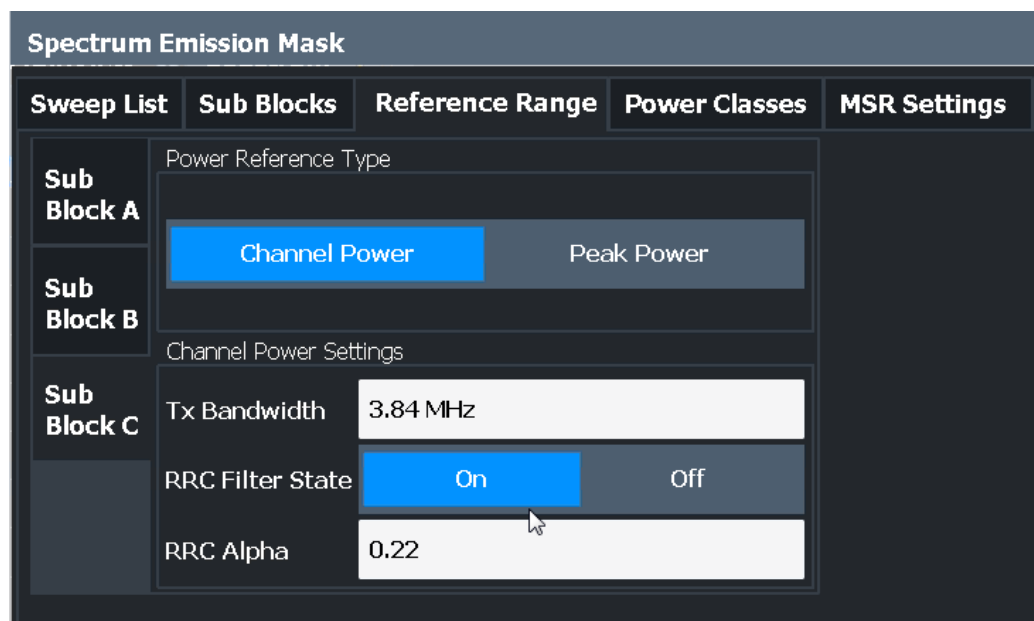

Power Reference Type.....256  
 Channel Power Settings.....257  
     L Tx Bandwidth.....257  
     L RRC Filter State.....257  
     L Alpha:.....257

**Power Reference Type**

Defines how the reference power is calculated.



**"Channel Power"**

Measures the channel power within the reference range using the integration bandwidth method. Additional settings can be configured for this method.

(See also ["IBW method"](#) on page 152)

**"Peak Power"**

Determines the peak power within the reference range.

Remote command:

[\[SENSe:\]ESpectrum<sb>:RTYPE](#) on page 1019

**Channel Power Settings**

If the "Power Reference Type:" "Channel Power" was selected, additional parameters can be configured.

**Tx Bandwidth ← Channel Power Settings**

Defines the bandwidth used for measuring the channel power, with:

Minimum span ≤ "Tx Bandwidth" ≤ of reference range

Remote command:

[\[SENSe:\]ESpectrum<sb>:BWID](#) on page 1018

**RRC Filter State ← Channel Power Settings**

Activates or deactivates the use of an RRC filter.

Remote command:

[\[SENSe:\]ESpectrum<sb>:FILTer\[:RRC\]\[:STATe\]](#) on page 1018

**Alpha: ← Channel Power Settings**

Sets the alpha value of the RRC filter (if activated).

Remote command:

[\[SENSe:\]ESpectrum<sb>:FILTer\[:RRC\]:ALPHa](#) on page 1018

**6.6.5.4 Power classes**

**Access:** "Overview" > "Select Measurement" > "Spectrum Emission Mask" > "Power Classes"

You can configure power classes which you can then assign to sweep list ranges. For details, see ["Power classes"](#) on page 239.

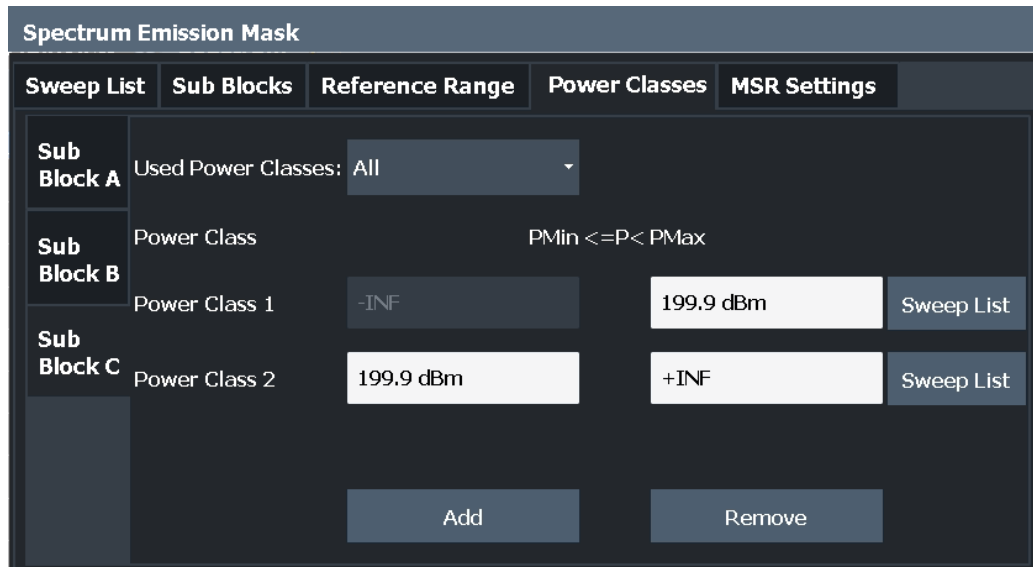

Used Power Classes:.....258  
 PMin/ PMax.....258  
 Sweep List.....259  
 Adding or Removing a Power Class..... 259

**Used Power Classes:**

Defines which power classes are considered for the SEM measurement. Limits can be defined only for used power classes. It is only possible to select either one specific power class or all the defined power classes.

If "All" is selected, the power class that corresponds to the currently measured power in the reference range is used for monitoring. The limits assigned to that power class are applied (see "Abs Limit Start / Stop <n>" on page 253 and "Rel Limit Start / Stop <n>" on page 253).

Remote command:

```
CALCulate<n>:LIMit<li>:ESpectrum<sb>:PCLass<pc>[:EXCLusive]
on page 1022
```

To define all limits in one step:

```
CALCulate<n>:LIMit<li>:ESpectrum<sb>:PCLass<pc>:LIMit[:STATe]
on page 1023
```

**PMin/ PMax**

Defines the power limits for each power class. The first range always starts at -200 dBm (-INF) and the last range always stops at 200 dBm (+INF). These fields cannot be modified. If more than one power class is defined, the value of "PMin" must be equal to the value of "PMax" of the previous power class and vice versa.

Note that the power level can be equal to the lower limit(s), but must be lower than the upper limit(s):

$$P_{min} \leq P < P_{max}$$

Otherwise the ranges are corrected automatically.

Remote command:

[CALCulate<n>:LIMit<li>:ESpectrum<sb>:PCLass<pc>:MINimum](#)  
on page 1024

[CALCulate<n>:LIMit<li>:ESpectrum<sb>:PCLass<pc>:MAXimum](#)  
on page 1023

### Sweep List

Switches to the "Sweep List" tab of the "Spectrum Emission Mask" dialog box and focuses the "Limit Check" setting for the corresponding power class (1-4) in the reference range (see "[Limit Check <n>](#)" on page 252).

### Adding or Removing a Power Class

Adds a new power class at the end of the list or removes the last power class. After adding or removing, the last power class is adapted to end at "+INF". Note that a maximum of four power classes are available.

Remote command:

[CALCulate<n>:LIMit<li>:ESpectrum<sb>:PCLass<pc>:COUNT](#) on page 1022

## 6.6.5.5 MSR settings

**Access:** "Overview" > "Select Measurement" > "Spectrum Emission Mask" > "MSR Settings"

Multi-standard radio (MSR) measurements allow you to perform SEM tests on multiple carriers using different digital standards.

For details, see [Chapter 6.6.4.4, "Multi-standard radio \(MSR\) SEM measurements"](#), on page 243.

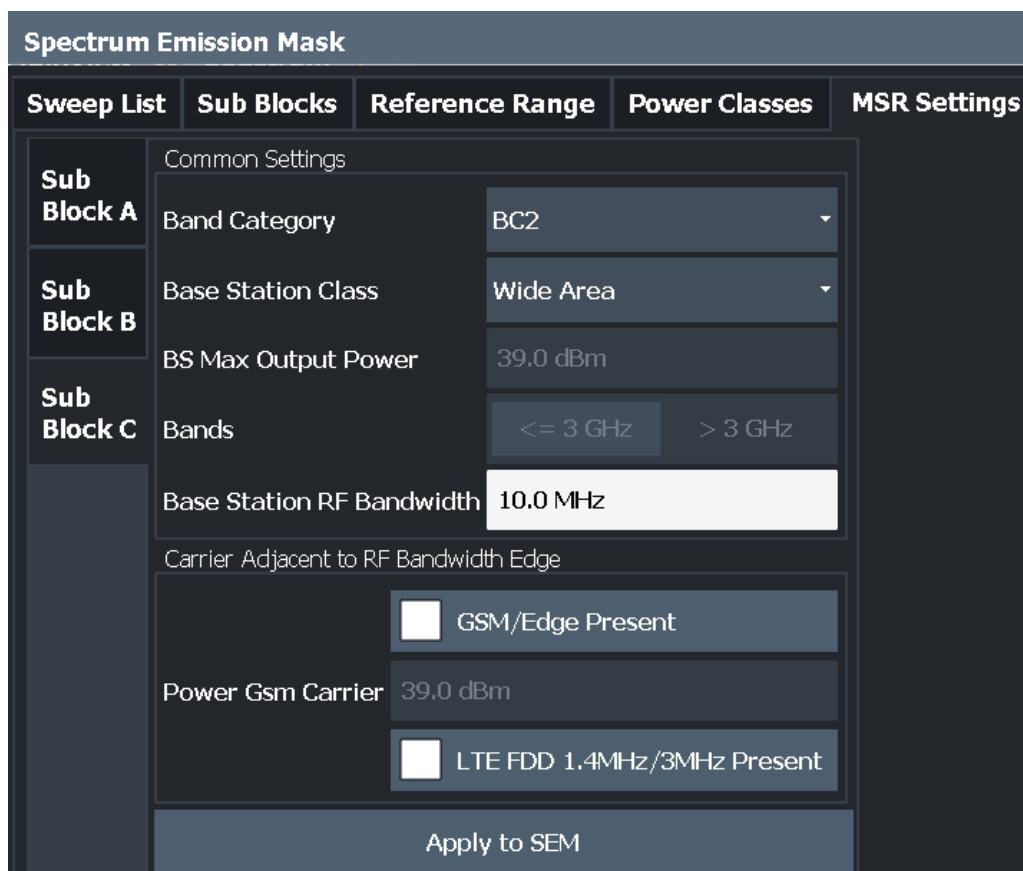

Band Category..... 260  
 Base Station Class..... 260  
 Base Station Maximum Output Power..... 261  
 Bands..... 261  
 Base Station RF Bandwidth..... 261  
 Carrier Adjacent to RF Bandwidth Edge..... 261  
 Power Gsm Carrier..... 261  
 Apply to SEM..... 262

**Band Category**

Defines the band category for MSR measurements, i.e. the combination of available carriers to measure.

- "BC1"            LTE FDD and W-CDMA
- "BC2"            LTE FDD, W-CDMA and GSM/EDGE
- "BC3"            LTE TDD and TD-SCDMA

Remote command:

[SENSe:]ESpectrum<sb>:MSR:BCATegory on page 1026

**Base Station Class**

Defines the class of the base station according to its sending range.

This setting is required to calculate the SEM limits according to standard 3GPP 37.141 V12.2.0.

Remote command:

[SENSe:]ESpectrum<sb>:MSR:CLASs on page 1027

### Base Station Maximum Output Power

Defines the maximum output power of the base station. Possible values are from 0 dBm to 100 dBm in 1 dB steps.

This setting is only available for base stations with a medium range [Base Station Class](#).

This value is required to calculate the SEM limits according to standard 3GPP 37.141 V12.2.0.

Remote command:

[SENSe:]ESpectrum<sb>:MSR:MPOWer on page 1029

### Bands

Defines the frequency range of the bands used by the base station.

This setting is only available for [Band Category](#) 1 or 3.

This setting is required to calculate the SEM limits according to standard 3GPP 37.141 V12.2.0.

Remote command:

[SENSe:]ESpectrum<sb>:MSR:BAND on page 1025

### Base Station RF Bandwidth

Defines the relevant RF bandwidth (span) required to measure all available carriers in MSR SEM measurements.

Remote command:

[SENSe:]ESpectrum<sb>:MSR:RFBWidth on page 1030

### Carrier Adjacent to RF Bandwidth Edge

For particular measurement setups, the specification demands specific limits for the SEM ranges.

These settings are only available for [Band Category](#) 2.

"GSM/Edge Present"

A GSM/EDGE carrier is located at the edge of the RF band.

In this case, the power of the GSM carrier must be specified (see ["Power Gsm Carrier"](#) on page 261).

"LTE FDD 1.4MHz/3MHz Present"

An LTE FDD 1.4 MHz or 3 MHz carrier is located at the edge of the RF band.

Remote command:

[SENSe:]ESpectrum<sb>:MSR:GSM:CPResent on page 1028

[SENSe:]ESpectrum<sb>:MSR:LTE:CPResent on page 1029

### Power Gsm Carrier

Defines the power of the GSM carrier (if available, see ["Carrier Adjacent to RF Bandwidth Edge"](#) on page 261). Possible values are from 0 dBm to 100 dBm in 1 dB steps.

This setting is only available for [Band Category](#)2.

## Spectrum emission mask (SEM) measurement

This setting is required to calculate the SEM limits according to standard 3GPP 37.141 V12.2.0.

Remote command:

[SENSe:]ESpectrum<sb>:MSR:GSM:CARRier on page 1027

### Apply to SEM

Configures the SEM sweep list according to the specified MSR settings.

Remote command:

[SENSe:]ESpectrum<sb>:MSR:APPLY on page 1025

#### 6.6.5.6 Standard files

**Access:** "Overview" > "Select Measurement" > "Spectrum Emission Mask" > "Standard Files"

You can save the current measurement settings as a user-defined standard (XML file), or load stored measurement settings. Furthermore, you can delete an existing settings file.

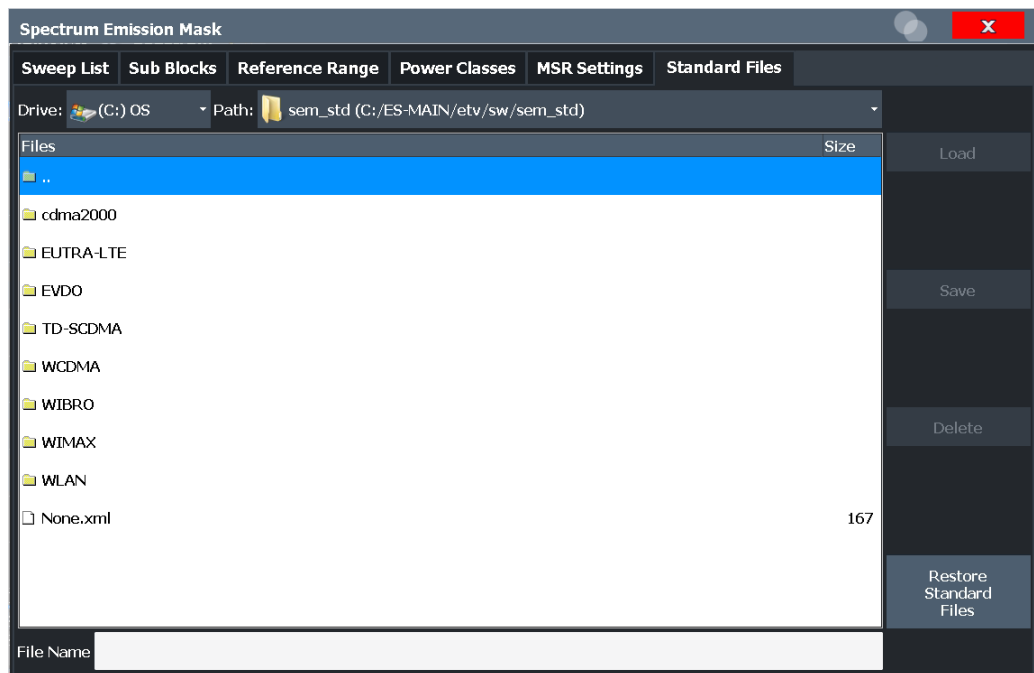

For details, see [Chapter 6.6.6.1, "How to manage SEM settings files"](#), on page 269.



#### Standard files for sub blocks (Multi-SEM measurements)

If more than one sub blocks are defined, the "Standard Files" tab and softkey are not available. To load a standard file for an individual sub block, use the [Standard / MSR Settings](#) setting in the "Sub Blocks" tab.

Selecting Storage Location - Drive/ Path/ Files.....	263
File Name.....	263
Load Standard.....	263
File Explorer.....	263
Save Standard.....	263
Delete Standard.....	264
Restore Standard Files.....	264

### Selecting Storage Location - Drive/ Path/ Files

Select the storage location of the file on the instrument or an external drive.

The default storage location for the SEM settings files is:

C:\Program Files (x86)\Rohde-Schwarz\FSW\\sem\_std.

**Note:** Saving instrument settings in secure user mode.

In secure user mode, settings that are stored on the instrument are stored to volatile memory, which is restricted to 256 MB. Thus, a "memory limit reached" error can occur although the hard disk indicates that storage space is still available.

To store data permanently, select an external storage location such as a USB memory device.

For details, see [Chapter 4.2.15, "Protecting data using the secure user mode"](#), on page 39.

Remote command:

[MMEMory:CATalog](#) on page 1349

### File Name

Contains the name of the data file without the path or extension.

By default, the name of a user file consists of a base name followed by an underscore. Multiple files with the same base name are extended by three numbers, e.g.

limit\_lines\_005.

File names must be compatible with the Windows conventions for file names. In particular, they must not contain special characters such as ":", "\*", "?".

For details on the filename and location, see [Chapter 10.3.2.2, "Storage location and filename"](#), on page 682.

### Load Standard

Loads the selected measurement settings file.

Remote command:

[\[SENSe:\]ESpectrum<sb>:PRESet\[:STANdard\]](#) on page 999

### File Explorer

Opens the Microsoft Windows File Explorer.

Remote command:

not supported

### Save Standard

Saves the current measurement settings for a specific standard as a file with the defined name.

Remote command:

[SENSe:]ESpectrum<sb>:PRESet:STORe on page 999

#### Delete Standard

Deletes the selected standard. Standards predefined by Rohde & Schwarz can also be deleted. A confirmation query is displayed to avoid unintentional deletion of the standard.

**Note:** Restoring predefined standard files. The standards predefined by Rohde & Schwarz available at the time of delivery can be restored using the "Restore Standard Files" function (see "Restore Standard Files" on page 264).

#### Restore Standard Files

Restores the standards predefined by Rohde & Schwarz available at the time of delivery.

The XML files from the

C:\Program Files (x86)\Rohde-Schwarz\FSW\<version>\sem\_backup folder are copied to the

C:\Program Files (x86)\Rohde-Schwarz\FSW\<version>\sem\_std folder.

Note that this function overwrites customized standards that have the same name as predefined standards.

Remote command:

[SENSe:]ESpectrum<sb>:PRESet:RESTore on page 999

### 6.6.5.7 List evaluation (results configuration)

**Access:** "Overview" > "Select Measurement" > "Spectrum Emission Mask" > "List Evaluation"

In the "List Evaluation" dialog box, you configure the contents and display of the SEM results.



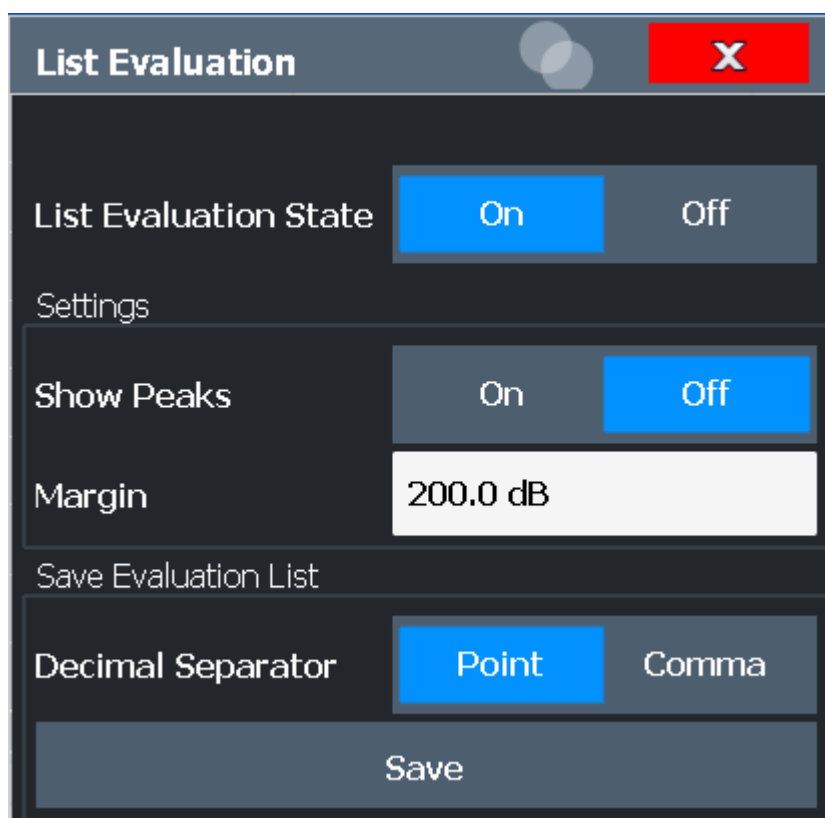

List Evaluation State (result summary).....	265
Show Peaks.....	265
Margin.....	265
Saving the Result Summary (Evaluation List) to a File.....	266

### List Evaluation State (result summary)

Activates or deactivates the Result Summary.

Remote command:

[CALCulate<n>:ESpectrum:PEAKsearch:AUTO](#) on page 1031

[TRACe<n>\[:DATA\]](#) on page 1258

### Show Peaks

If activated, all peaks that have been detected during an active SEM measurement are marked with blue squares in the Spectrum diagram.

Remote command:

[CALCulate<n>:ESpectrum:PEAKsearch:PSHow](#) on page 1032

### Margin

Although a margin functionality is not available for the limit check, you can define a margin (or: *threshold*) for the peak values to be displayed in the result summary. Only peaks that exceed the margin value are displayed (also in the diagram, if activated).

Remote command:

[CALCulate<n>:ESpectrum:PEAKsearch:MARGIN](#) on page 1031

### **Saving the Result Summary (Evaluation List) to a File**

Exports the Result Summary of the SEM measurement to an ASCII file for evaluation in an external application. If necessary, change the decimal separator for evaluation in other languages.

Define the filename and storage location in the file selection dialog box that is displayed when you select the "Save" function.

For details, see [Chapter 6.6.8.2, "ASCII file export format \(spectrum emission mask\)"](#), on page 278.

Remote command:

`MMEMoRY:STORe<n>:LIST` on page 1373

`FORMat:DEXPort:DSEParator` on page 1348

## **6.6.6 How to perform a spectrum emission mask measurement**

SEM measurements can be performed according to a specific standard or freely configured. Configuration for signals with a regular channel definition can be configured quickly and easily. Selecting the SEM measurement is a prerequisite for all other tasks.

For signals with multiple carriers, also in non-contiguous ranges, an SEM measurement with multiple sub blocks can be configured.

For multi-standard radio SEM measurements, configuration for specified scenarios can be done automatically.

The following tasks are described:

- ["To select an SEM measurement"](#) on page 266
- ["To perform an SEM measurement according to a standard"](#) on page 266
- ["To configure a user-defined SEM measurement"](#) on page 266
- ["To perform an MSR SEM measurement"](#) on page 268
- ["To perform a Multi-SEM measurement"](#) on page 268



For remote operation, see [Chapter 13.5.7.11, "Example: SEM measurement"](#), on page 1032.

### **To select an SEM measurement**

- ▶ Press [MEAS], then select the "Spectrum Emission Mask" measurement.

### **To perform an SEM measurement according to a standard**

- ▶ Load the settings file as described in ["How to load an SEM settings file"](#) on page 269 and start a measurement.

### **To configure a user-defined SEM measurement**

1. Define the span of the signal you want to monitor in the general span settings.
2. Split the frequency span of the measurement into ranges for signal parts with similar characteristics.

## Spectrum emission mask (SEM) measurement

Starting from the center frequency, determine which sections of the signal to the left and right can be swept and monitored using the same parameters. Criteria for such a range definition may be, for example:

- The signal power level
- The required resolution bandwidth or sweep time
- Transducer factors
- Permitted deviation from the defined signal level, i.e. the required limit values for monitoring

If the signal consists of a transmission channel and adjacent channels, the channel ranges can usually be used for the range definition.

3. If the signal power level to be monitored varies and the limits vary, define power classes. For each range of levels that can be monitored in the same way, define a power class.
  - a) Select "Overview".
  - b) Select "SEM Setup".
  - c) Switch to the "Power Classes" tab.
  - d) To add a power class, select "Add".
  - e) Enter the start and stop power levels to define the class.
  - f) Select the power classes to be used for the current measurement:
    - a specific class
    - all classes, to have the required class selected automatically according to the input level measured in the reference range
4. Select the "Sweep List" tab of the "Spectrum Emission Mask" dialog box.
5. Insert the required ranges using "Insert before Range" and "Insert after Range", which refer to the currently selected range (the reference range by default). If the signal trace is symmetric to the center frequency, activate the "Sym Setup" option to make setup easier and quicker.
6. Define the measurement parameters for each range as required. If symmetrical setup is activated, you only have to configure the ranges to one side of the center range.

In particular, define the limits for each range of the signal, i.e. the area in which the signal level can deviate without failing the limit check. If several power classes were defined (see [step 3](#)), define limits for each power class.

  - a) Define the type of limit check, i.e. whether absolute values or relative values are checked, or both. The type of limit check is identical for all power classes.
  - b) Define the limit start and stop values.
7. If the sweep list settings - other than the limit and transducer values - are identical for several adjacent ranges, activate "Fast SEM" mode to speed up the measurement. You only have to activate the mode for one range, the others are adapted automatically.
8. If necessary, change the settings for the reference power to which all SEM results refer in the "Reference Range" tab.

9. To indicate the determined peaks in the display during an SEM measurement, select "Overview" > "Analysis" > "Show Peaks".
10. To save the current SEM measurement settings to a file to re-use them later, save a settings file as described in ["How to save a user-defined SEM settings file"](#) on page 269.
11. Start a sweep.  
The determined powers and limit deviations for each range are indicated in the Result Summary. If activated, the peak power levels for each range are also indicated in the Spectrum diagram.
12. To save the Result Summary, export the results to a file as described in [Chapter 6.6.6.2, "How to save SEM result files"](#), on page 270.

#### To perform an MSR SEM measurement

1. Select "MSR Config".
2. Select the band category that determines the digital standards used in the measurement setup (see ["Band Category"](#) on page 260).
3. Define the bandwidth that contains all relevant carrier signals to be measured.
4. For measurements with GSM/EDGE, LTE FDD and W-CDMA carriers (BC2), define whether a GSM/EDGE or an LTE FDD carrier, or both, are located at the edge of the bandwidth.
5. Select "Apply to SEM".  
The sweep list is configured according to the MSR specification, with the required number of ranges and defined limits.
6. Start a sweep.  
The determined powers and limit deviations for each range are indicated in the Result Summary. If activated, the peak power levels for each range are also indicated in the Spectrum diagram.
7. To save the Result Summary, export the results to a file as described in [Chapter 6.6.6.2, "How to save SEM result files"](#), on page 270.

#### To perform a Multi-SEM measurement

1. Define the span of the signal to be monitored in the general span settings.
2. Select "Multi-SEM Config".
3. Define the number of sub blocks (up to 8) that contain the relevant carriers.
4. For each sub block, define the center frequency, that is, the frequency of the TX carrier or a frequency in the dedicated reference range.
5. For each sub block, do one of the following:
  - Select a standard settings file to be used.

- Select "MSR Settings" and define the MSR configuration as described in ["To perform an MSR SEM measurement"](#) on page 268.
  - Select "Edit" and configure the sweep list manually as defined in ["To configure a user-defined SEM measurement"](#) on page 266. Be sure to select the correct vertical tab for the corresponding sub block within each subtab of the "Spectrum Emission Mask" configuration dialog.  
Define a function to be used for overlapping ranges in the "Multi-Limit Calc" field of the sweep list.
6. Start a sweep.  
  
The determined powers and limit deviations for each sub block, each gap, and each range are indicated in the Result Summary. If activated, the peak power levels for each range are also indicated in the Spectrum diagram.
  7. To save the Result Summary, export the results to a file as described in [Chapter 6.6.6.2, "How to save SEM result files"](#), on page 270.

#### 6.6.6.1 How to manage SEM settings files

SEM measurement settings can be saved to an XML file which can then be exported to another application or loaded on the FSW again later. Some predefined XML files are provided that contain ranges and parameters according to the selected standard. All XML files are stored under

```
C:\Program Files (x86)\Rohde-Schwarz\FSW\<version>\sem_std.
```

For details on the file format of the SEM settings file, see [Chapter 6.6.8.1, "Format description of SEM XML files"](#), on page 272.

SEM settings or standard files are managed in the "Standard" tab of the "Spectrum Emission Mask" dialog box. To display this dialog box, select "Overview" and then "SEM Setup".

##### How to load an SEM settings file

1. From the file selection dialog box, select the settings file (with a `.xml` extension).
2. Select "Load".

The settings from the selected file are restored to the FSW and you can repeat the SEM measurement with the stored settings.

##### How to save a user-defined SEM settings file

1. Configure the SEM measurement as required (see [Chapter 6.6.6, "How to perform a spectrum emission mask measurement"](#), on page 266).
2. In the "Standard Files" tab of the "Spectrum Emission Mask" dialog box, define a filename and storage location for the settings file.
3. Select "Save".

The settings are stored to a file with the extension `.xml` as specified.

### How to delete an SEM settings file

1. In the "Standard Files" tab of the "Spectrum Emission Mask" dialog box, select the file you want to delete.
2. Select "Delete".
3. Confirm the message.

The settings file is removed from the FSW.

### How to restore default SEM settings files

The FSW is delivered with predefined settings files which can be edited and overwritten. However, you can restore the original files.

- ▶ In the "Standard Files" tab of the "Spectrum Emission Mask" dialog box, select "Restore Standard Files".

The original predefined settings files are available for selection on the FSW.

#### 6.6.6.2 How to save SEM result files

The Result Summary from an SEM measurement can be saved to a file, which can be exported to another application for further analysis, for example.

For details on the file format of the SEM export file, see [Chapter 6.6.8.2, "ASCII file export format \(spectrum emission mask\)"](#), on page 278.

1. Configure and perform an SEM measurement as described in [Chapter 6.6.6, "How to perform a spectrum emission mask measurement"](#), on page 266.
2. In the "Overview", select "Analysis".
3. If necessary, change the "Decimal Separator" to "COMMA" for evaluation in other languages.
4. Select "Save".
5. In the file selection dialog box, select a storage location and filename for the result file.
6. Select "Save".

The file with the specified name and the extension `.dat` is stored in the defined storage location.

#### 6.6.7 Measurement example: Multi-SEM measurement

The following measurement example demonstrates an SEM measurement for a signal with multiple sub blocks.



A programming example demonstrating a SEM measurement in a remote environment is provided in [Chapter 13.5.7.11, "Example: SEM measurement"](#), on page 1032.

#### Test setup:

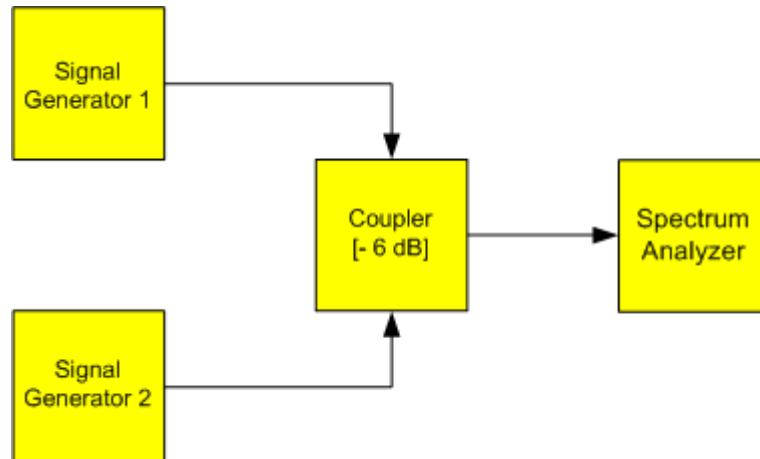

#### Signal generator settings (e.g. FSW SMW):

Device	Standard	Center frequency	Level	Test model
SigGen 1	3GPP/FDD	900 MHz	0 dBm	1-16
SigGen 2	EUTRA/LTE	906.5 MHz	0 dBm	1_1_5MHz

#### Setting up the measurement

1. Preset the FSW.
2. Set the center frequency to *903.25 MHz*.
3. Set the reference level to *10 dBm* with an offset of *30 dB*.
4. Press [MEAS] or select "Select Measurement" in the "Overview".
5. Select the "SEM" measurement function.
6. Select "Sub Blocks" and enter "Sub Block Count" of 2.
7. For "Sub Block A", define the settings for the 3GPP/FDD signal:
  - Set the "Center Frequency" to *900 MHz*
  - Select "MSR Settings".
  - Set the "Base Station RF Bandwidth" to *5 MHz*.
  - Select "Apply to SEM".
8. For "Sub Block B", define the settings for the EUTRA/LTE signal:
  - Set the "Center Frequency" to *906.5 MHz*
  - Select "MSR Settings".
  - Set the "Base Station RF Bandwidth" to *5 MHz*.
  - Select "Apply to SEM".

Spectrum emission mask (SEM) measurement

- Select [RUN SINGLE] to perform a measurement with the new settings.

The results of the measurement for each sub block are displayed in the Result Summary. The summarized limit line is indicated in the Spectrum graph.

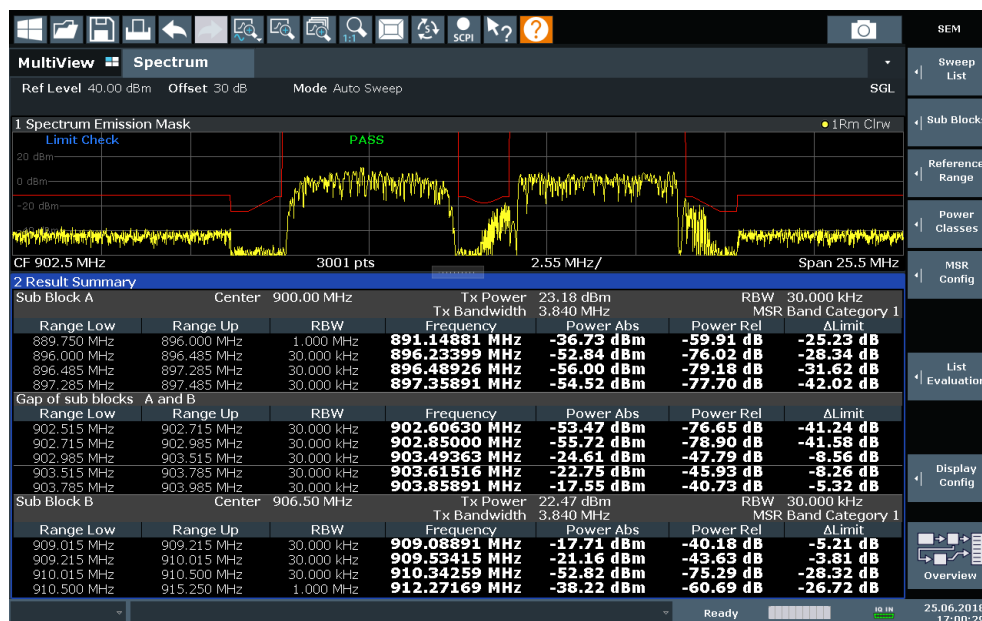

Figure 6-50: Multi-SEM measurement: results of the measurement for each sub block

### 6.6.8 Reference: SEM file descriptions

This reference provides details on the format of the SEM settings and result files.

- [Format description of SEM XML files](#).....272
- [ASCII file export format \(spectrum emission mask\)](#).....278

#### 6.6.8.1 Format description of SEM XML files

The SEM XML files offer a quick way to change the measurement settings. A set of predefined XML files for different standards is already provided. You can also create and use your own XML files. Alternatively, edit the settings directly in the "Spectrum Emission Mask" dialog box and save the XML file afterwards. This way, you do not have to modify the XML file itself.

In addition to saving the current settings to a file, settings files can also be created independently of the FSW, in an external application. When creating your own XML files, be sure to comply with the following conventions because the FSW can only interpret XML files of a known structure. For sample files, see the

C:\Program Files (x86)\Rohde-Schwarz\FSW\<version>\sem\_std directory of the FSW.

To load a settings file, use the "Load" function in the "Standard Files" tab of the "Spectrum Emission Mask" dialog box (see ["How to load an SEM settings file"](#) on page 269).



All XML files are stored under

C:\Program Files (x86)\Rohde-Schwarz\FSW\<version>\sem\_std.

The files for importing range settings obey the rules of the XML standard. The child nodes, attributes, and structure defined for the data import are described here.



Be sure to follow the structure exactly as shown below or else the FSW is not able to interpret the XML file and error messages are shown on the screen. It is recommended that you make a copy of an existing file and edit the copy of the file.

Basically, the file consists of three elements that can be defined:

- The `BaseFormat` element
- The `PowerClass` element
- The `Range` element

### The "BaseFormat" element

It carries information about basic settings. In this element, only the `ReferencePower` child node has any effects on the measurement itself. The other attributes and child nodes are used to display information about the Spectrum Emission Mask standard on the measurement screen. The child nodes and attributes of this element are shown in [Table 6-13](#).

#### Example:

In the sample file `PowerClass_39_43.xml` under

C:\Program Files (x86)\Rohde-Schwarz\FSW\<version>\sem\_std\  
WCDMA\3GPP, these attributes are defined as follows:

- `Standard="W-CDMA 3GPP"`
- `LinkDirection="DL"`
- `PowerClass="(39,43)dBm"`

### The "PowerClass" element

It is embedded in the `BaseFormat` element and contains settings information about the power classes. Up to four different power classes can be defined. For details, refer to [Chapter 6.6.5.4, "Power classes"](#), on page 257. The child nodes and attributes of this element are shown in [Table 6-14](#).

### The "Range" element

This element is embedded in the `PowerClass` element. It contains the settings information of the range. There have to be at least three defined ranges: one reference range and at least one range to either side of the reference range. The maximum number of ranges is 30. Note that the FSW uses the same ranges in each power class. Therefore, the contents of the ranges of each defined power class have to be identical to the first power class. The `Start` and `Stop` values of the two `Limit` nodes that are used to determine the power class are an exception. Note also that you must define

two limit nodes: one that defines the limit in absolute values and one in relative values. Make sure units for the `Start` and `Stop` nodes are identical for each `Limit` node.

For details, refer to [Chapter 6.6.5.1, "Sweep List"](#), on page 248. The child nodes and attributes of this element are shown in [Table 6-15](#).

The following tables show the child nodes and attributes of each element and show if a child node or attribute is mandatory for the FSW to interpret the file or not. The hierarchy of the XML cannot be seen in the tables. View one of the predefined files already stored on the FSW in the "C:\Program Files (x86)\Rohde-Schwarz\FSW\`<version>`\sem\_std" directory, or check the structure as shown below.

Below, a basic example of the structure of the file is shown, containing all mandatory attributes and child nodes. Note that the `PowerClass` element and the `Range` element are themselves elements of the `BaseFormat` element. They must be inserted where noted. They are separated here simply to provide a better overview. Also, no example values are given here to allow a quick reference to the tables above. Italic font shows the placeholders for the values.

- The `BaseFormat` element is structured as follows:
  - ```
<RS_SEM_ACP_FileFormat Version="1.0.0.0">
  <Name>"Standard"</Name>
  <Instrument>
  <Type>"Instrument Type"</Type>
  <Application>"Application"</Application>
  </Instrument>
  <LinkDirection Name="Name">
  <ReferencePower>
  <Method>"Method"</Method>
  </ReferencePower>
  <PowerClass Index="n">
  <!-- For contents of the PowerClass node, see Table 6-14 -->
  <!-- Define up to four PowerClass nodes -->
  </PowerClass>
  </LinkDirection>
</RS_SEM_ACP_File>
```
- The "PowerClass" element is structured as follows:
  - ```
<PowerClass Index="n">
  <StartPower Unit="dBm" InclusiveFlag="true" Value="StartPowerValue"/>
  <StopPower Unit="dBm" InclusiveFlag="false" Value="StopPowerValue"/>
  <DefaultLimitFailMode>"Limit Fail Mode"</DefaultLimitFailMode>
  <Range Index="n">
  <!-- For contents of the Range node, see Table 6-15 -->
  <!-- Define up to twenty Range nodes -->
  </Range>
  ...
</PowerClass>
```
- The "Range" element is structured as follows:
  - ```
<Range Index="n">
```

## Spectrum emission mask (SEM) measurement

```

<Name="Name">
<ChannelType>"Channel Type"</Channel Type>
<WeightingFilter>
<Type>"FilterType"</Type>
<RollOffFactor>"Factor"</RollOffFactor>
<Bandwidth>"Bandwidth"</Bandwidth>
</WeightingFilter>
<FrequencyRange>
<Start>"RangeStart"</Start>
<Stop>"RangeStop"</Stop>
</FrequencyRange>
<Limit>
<Start Unit="Unit" Value="Value"/>
<Stop Unit="Unit" Value="Value"/>
</Limit>
<Limit>
<Start Unit="Unit" Value="Value"/>
<Stop Unit="Unit" Value="Value"/>
</Limit>
<RBW Bandwidth="Bandwidth" Type="FilterType"/>
<VBW Bandwidth="Bandwidth"/>
<Detector>"Detector"</Detector>
<Sweep Mode="SweepMode" Time="SweepTime"/>
<Amplitude>
<ReferenceLevel Unit="dBm" Value="Value"/>
<RFAttenuation Mode="Auto" Unit="dB" Value="Value"/>
<Preamplifier State="State"/>
</Amplitude>
<MeasPointsMin>1</MeasPointsMin>
<CalcRuleMulti>Sum</CalcRuleMulti>
</Range>

```

Table 6-13: Attributes and child nodes of the BaseFormat element

Child Node	Attribute	Value	Parameter Description	Mand.
	FileFormatVersion	1.0.0.0		Yes
	Date	YYYY-MM-DD HH:MM:SS	Date in ISO 8601 format	No
Name		<string>	Name of the standard	Yes
Instrument	Type	FSL	Name of the instrument	No
	Application	SA   K72   K82	Name of the application	No
LinkDirection	Name	Downlink   Uplink   None		Yes
	ShortName	DL   UL		No
Reference-Power				Yes

## Spectrum emission mask (SEM) measurement

Child Node	Attribute	Value	Parameter Description	Mand.
Method	TX Channel Power   TX Channel Peak Power			Yes
Reference-Channel	<string>			No

Table 6-14: Attributes and child nodes of the PowerClass element

Child Node	Attribute	Value	Parameter description	Mand.
StartPower	Value	<power in dBm>	The start power must be equal to the stop power of the previous power class. The StartPower value of the first range is -200	Yes
	Unit	dBm		Yes
	InclusiveFlag	true		Yes
StopPower	Value	<power in dBm>	The stop power must be equal to the start power of the next power class. The StopPower value of the last range is 200	Yes
	Unit	dBm		
	InclusiveFlag	false		Yes
DefaultLimitFailMode		Absolute   Relative   Absolute and Relative   Absolute or Relative		Yes

Table 6-15: Attributes and child nodes of the Range element (normal ranges)

Child node	Attribute	Value	Parameter description	Mand.
	Index	0...19	Indices are continuous and have to start with 0	Yes
	Name	<string>	Name of the range	Only if ReferenceChannel contains a name and the range is the reference range
	Short-Name	<string>	Short name of the range	No
ChannelType		TX   Adjacent		Yes
WeightingFilter				Only if ReferencePower method is TX Channel Power and the range is the reference range
Type		RRC   CFilter	Type of the weighting filter	Yes

## Spectrum emission mask (SEM) measurement

Child node	Attribute	Value	Parameter description	Mand.
Roll Off Factor		0...1	Excess bandwidth of the filter	Only if the filter type is RRC
Bandwidth		<bandwidth in Hz>	Filter bandwidth	Only if the filter type is RRC
FrequencyRange				Yes
Start		<frequency in Hz>	Start value of the range	Yes
Stop		<frequency in Hz>	Stop value of the range	Yes
Limit		dBm/Hz   dBm   dBc   dBr   dB	A Range must contain exactly two limit nodes; one of the limit nodes has to have a relative unit (e.g. dBc), the other one must have an absolute unit (e.g. dBm)	Yes
Start	Value	<numeric_value>	Power limit at start frequency	Yes
	Unit	dBm/Hz   dBm   dBc   dBr   dB	Sets the unit of the start value	
Stop	Value	<numeric_value>	Power limit at stop frequency	
	Unit	dBm/Hz   dBm   dBc   dBr   dB	Sets the unit of the stop value	
LimitFailMode		Absolute   Relative   Absolute and Relative   Absolute or Relative	If used, it has to be identical to DefaultLimitFailMode	No
RBW	Bandwidth	<bandwidth in Hz>	"RBW" on page 250	Yes
	Type	NORM   PULS   CFIL   RRC		No
VBW	Bandwidth	<bandwidth in Hz>	"VBW" on page 250	Yes
Detector		NEG   POS   SAMP   RMS   AVER   QUAS	If used, it has to be identical in all ranges.	No
Sweep	Mode	Manual   Auto	"Sweep Time Mode" on page 250	Yes
	Time	<time in sec>	"Sweep Time" on page 251	No
Amplitude				No
ReferenceLevel	Value	<power in dBm>	"Ref Level" on page 251	Yes, if the ReferenceLevel child node is used
	Unit	dBm	Defines dBm as unit	Yes, if the ReferenceLevel node is used

## Spectrum emission mask (SEM) measurement

Child node	Attribute	Value	Parameter description	Mand.
RFAttenuation	Mode	Manual   Auto	"RF Att Mode" on page 251	Yes, if the ReferenceLevel child node is used
Preamplifier		ON   OFF   1   0	"Preamplifier" on page 488	Yes

### 6.6.8.2 ASCII file export format (spectrum emission mask)

When trace data from an SEM measurement is exported, the data is stored in ASCII format as described below. The first part of the file lists information about the signal analyzer and the general setup.

File contents	Explanation
<b>File header</b>	
Type;FSW-26;	Model
Version;1.00;	Firmware version
Date;31.Mar 17;	Storage date of data set
Mode;ANALYZER;SEM;	Operating mode and measurement function
Center Freq;13250000000.000000;Hz	X-axis settings
Freq Offset;0.000000;Hz	
Span;25500000.000000;Hz	
x-Axis;LIN;	
Start;13237250000.000000;Hz	
Stop;13262750000.000000;Hz	
Level Offset;0.000000;dB	Y-axis settings
Ref Position;100.000000;%	
y-Axis;LOG;	
Level Range;100.000000;dB	
<b>Trace settings</b>	
Trace Mode;CLR/WRITE;	
Detector;RMS;	
Sweep Count;0;	
Trace 1.;	
x-Unit;Hz;	
y-Unit;dBm;	
<b>List evaluation settings</b>	
Margin;200;	Peak List margin

File contents	Explanation
<b>Reference range settings</b>	
RefType; CPOWER;	Reference power type
TxBandwidth;3840000;;Hz	Channel power settings
Filter State; ON;	
Alpha;0.22;	
PeaksPerRange;1;	Max. number of peaks per range to be detected
Values;2;	Number of detected peaks
<b>File data section</b>	
0;-12750000;-2515000;30000;13242367500;-43.844722747802734;-0.33028793334960938;49.669712066650391;FAIL;	Measured peak values: <range number>; <start frequency>; <stop frequency>; <resolution bandwidth of range>; <frequency of peak>; <absolute power in dBm of peak>; <relative power in dBc of peak>; (related to the channel power) <distance to the limit line in dB>; (positive value means above the limit) <limit fail (pass = 0, fail =1)>;
2;2515000;12750000;30000;13257632500;-43.844722747802734;-0.33028793334960938;49.669712066650391;FAIL;	

## 6.7 Spurious emissions measurement

Spurious Emissions measurements monitor unwanted RF products outside the assigned frequency band generated by an amplifier.

- [About the measurement](#).....279
- [Spurious emissions measurement results](#)..... 280
- [Spurious emissions basics](#).....281
- [Spurious emissions measurement configuration](#)..... 283
- [How to perform a spurious emissions measurement](#).....290
- [Reference: ASCII export file format \(spurious\)](#)..... 292

### 6.7.1 About the measurement

The Spurious Emissions measurement monitors unwanted RF products outside the assigned frequency band generated by an amplifier. The spurious emissions are usually measured across a wide frequency range. The Spurious Emissions measurement allows a flexible definition of all parameters. A result table indicates the largest deviations of the absolute power from the limit line for each range, and the results can be checked against defined limits automatically.

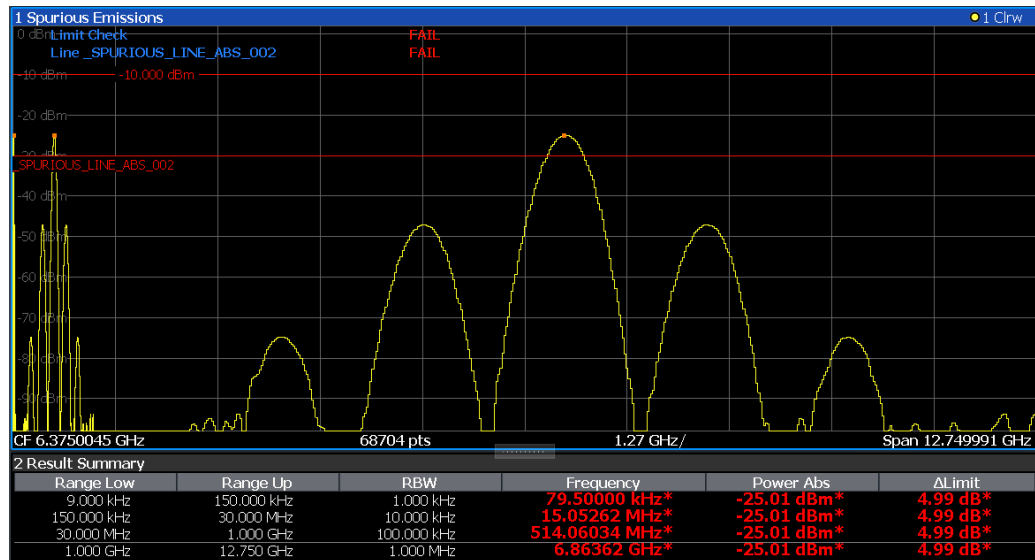

## 6.7.2 Spurious emissions measurement results

The measured signal, including any spurious emissions, and optionally the detected peaks are displayed in the Spurious Emissions measurement diagram. If defined, the limit lines and the limit check results are also indicated. In addition to the graphical results, a result table can be displayed to evaluate the measured powers and limit check results (see also [Chapter 6.7.3.2, "Limit lines in spurious measurements"](#), on page 282). The details of the evaluation list can be configured.

Range Low	Range Up	RBW	Frequency	Power Abs	ΔLimit
9,000 kHz	150,000 kHz	1,000 kHz	79,50000 kHz*	-25,01 dBm*	4,99 dB*
150,000 kHz	30,000 MHz	10,000 kHz	15,05262 MHz*	-25,01 dBm*	4,99 dB*
30,000 MHz	1,000 GHz	100,000 kHz	514,06034 MHz*	-25,01 dBm*	4,99 dB*
1,000 GHz	12,750 GHz	1,000 MHz	6,86362 GHz*	-25,01 dBm*	4,99 dB*

The following information is provided in the evaluation list for each range:

Column	Description
Range Low	Frequency range start for the range the peak value belongs to
Range Up	Frequency range end for the range the peak value belongs to
RBW	RBW of the range
Frequency	Frequency at the peak value
Power Abs	Absolute power level at the peak value
ΔLimit	Deviation of the absolute power level from the defined limit for the peak value

By default, one peak per range is displayed. However, you can change the settings to:

- Display all peaks
- Display a certain number of peaks per range
- Display only peaks that exceed a threshold ("Margin")



- Display detected peaks as blue squares in the diagram, as well as in the peak list

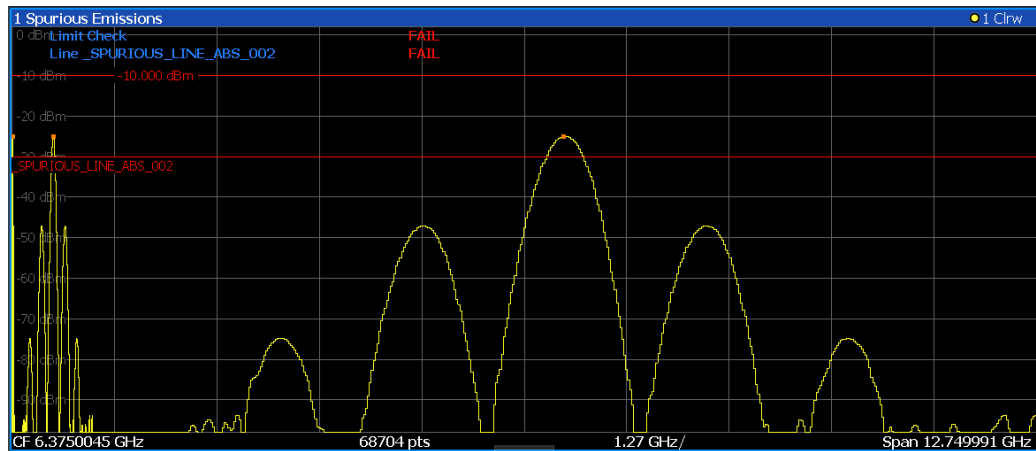

Furthermore, you can save the evaluation list to a file.

### Retrieving Results via Remote Control

The measured spurious values of the displayed trace can be retrieved using the TRAC:DATA? SPUR command (see TRACe<n> [:DATA] on page 1258).

## 6.7.3 Spurious emissions basics

Some background knowledge on basic terms and principles used in Spurious Emissions measurements is provided here for a better understanding of the required configuration settings.

- [Ranges and range settings](#)..... 281
- [Limit lines in spurious measurements](#)..... 282

### 6.7.3.1 Ranges and range settings

#### Conditions for ranges

The following rules apply to ranges:

- The minimum span of a range is 20 Hz.
- The individual ranges must not overlap (but can have gaps).
- The maximum number of ranges is 30
- The maximum number of sweep points in all ranges is limited to 100001.

You can define a span that is smaller than the combined span of the ranges. In this case, the measurement includes only the ranges that lie within the defined span and have a minimum span of 20 Hz.



### Defining ranges by remote control

In Spurious Emissions measurements, there are no remote commands to insert new ranges between existing ranges directly. However, you can delete or redefine the existing ranges to create the required order.

A remote command example for defining parameters and ranges in Spurious Emissions measurements is described in [Chapter 13.5.8.7, "Programming example: spurious emissions measurement"](#), on page 1048.

### 6.7.3.2 Limit lines in spurious measurements

Limit lines allow you to check the measured data against specified limit values. Generally, it is possible to define limit lines for any measurement in the Spectrum application using [Lines]. For Spurious measurements, however, a special limit line is available via the "Sweep List", and it is strongly recommended that you use only this limit line definition.

In the "Sweep List", you can define a limit line that varies its level according to the specified frequency ranges. A distinguished limit line is automatically defined according to the current "Sweep List" settings every time the settings change. This limit line is labeled "\_SPURIOUS\_LINE\_ABS\_<xxx>", where <xxx> is an index to distinguish limit lines between different channels.

If a limit check is activated in the "Sweep List", the "\_SPURIOUS\_LINE\_ABS\_<xxx>" limit line is indicated by a red line in the display. The result of the limit check is indicated at the top of the diagram. Note that only "Pass" or "Fail" is indicated; a margin function as for general limit lines is not available. Also, only absolute limits can be checked, not relative ones.

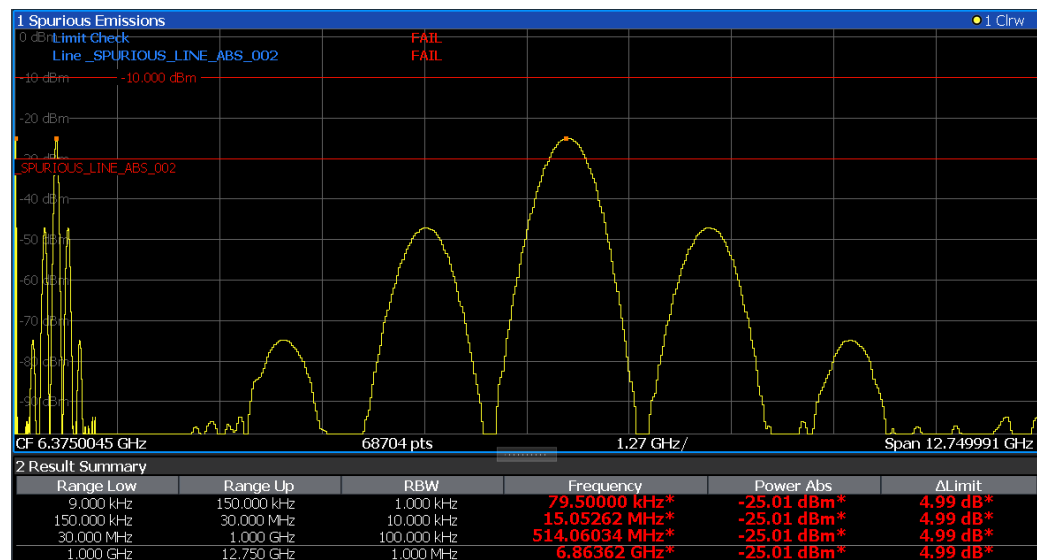

As for general limit lines, the results of each limit line check are displayed (here: "\_SPURIOUS\_LINE\_ABS\_<xxx>"), as well as the combined result for all defined limit lines ("Limit Check").

The limit check is considered to be "failed!" if any signal level outside the absolute limits is measured.

If the limit check is activated, the limit line values for each range are displayed in the evaluation list. Furthermore, the largest deviations of the absolute power from the limit line for each range are displayed. Values that exceed the limit are indicated in red and by an asterisk (\*).



Although a margin functionality is not available for the limit check, a margin (threshold) for the peak values to be displayed in the evaluation list can be defined. Furthermore, you can define how many peaks per range are listed. For details, see [Chapter 6.7.4.3, "List evaluation"](#), on page 288.

## 6.7.4 Spurious emissions measurement configuration

**Access:** "Overview" > "Select Measurement" > "Spurious Emissions"

The spurious emissions measurement is started immediately with the default settings.

The remote commands required to perform these tasks are described in [Chapter 13.5.8, "Measuring spurious emissions"](#), on page 1035.

- [Sweep list](#).....283
- [Adjusting the X-Axis to the range definitions](#).....288
- [List evaluation](#)..... 288

### 6.7.4.1 Sweep list

**Access:** "Overview" > "Select Measurement" > "Spurious Emissions" > "Sweep List"

For Spurious Emissions measurements, the input signal is split into several frequency ranges which are swept individually and for which different limitations apply.



If you edit the sweep list, always follow the rules and consider the limitations described in [Chapter 6.7.3.1, "Ranges and range settings"](#), on page 281.

Spurious Emissions				
	Range 1	Range 2	Range 3	Range 4
Range Start	9 kHz	150 kHz	30 MHz	1 GHz
Range Stop	150 kHz	30 MHz	1 GHz	12.75 GHz
Filter Type	Normal(3dB)	Normal(3dB)	Normal(3dB)	Normal(3dB)
RBW	1 kHz	10 kHz	100 kHz	1 MHz
VBW	3 kHz	30 kHz	300 kHz	3 MHz
Sweep Time Mode	Auto	Auto	Auto	Auto
Sweep Time	14.1 ms	29.9 ms	32.1 ms	35.3 ms
Detector	RMS	RMS	RMS	RMS
Ref Level	-10 dBm	-10 dBm	-10 dBm	-10 dBm
RF Att Mode	Auto	Auto	Auto	Auto
RF Attenuation	0 dB	0 dB	0 dB	0 dB
Preamp	Off	Off	Off	Off
Sweep Points	701	4001	32001	32001
Stop After Sweep				
Transducer	None	None	None	None
Limit Check	Absolute	Absolute	Absolute	Absolute
Abs Limit Start	-30 dBm	-30 dBm	-30 dBm	-30 dBm
Abs Limit Stop	-30 dBm	-30 dBm	-30 dBm	-30 dBm

Insert before Range
Insert after Range
Delete Range
Adjust X-Axis

Range Start / Range Stop..... 284

Filter Type..... 285

RBW..... 285

VBW..... 285

Sweep Time Mode..... 285

Sweep Time..... 285

Detector..... 285

Reference Level..... 286

RF Attenuation Mode..... 286

RF Attenuation..... 286

SPA: RF Attenuation Mode / SPA: RF Attenuation..... 286

Preamp..... 287

Sweep Points..... 287

Stop After Sweep..... 287

Transducer..... 287

Limit Check..... 287

Abs Limit Start/ Abs Limit Stop..... 288

Insert before Range/ Insert after Range..... 288

Delete Range..... 288

**Range Start / Range Stop**

Sets the start frequency/stop frequency of the selected range.

You can define a span that is smaller than the overall span of the ranges. In this case, the measurement includes only the ranges that lie within the defined span and have a minimum span of 20 Hz.

Remote command:

`[SENSe:]LIST:RANGe<ri>[:FREQuency]:START` on page 1039

`[SENSe:]LIST:RANGe<ri>[:FREQuency]:STOP` on page 1039

### Filter Type

Sets the filter type for this range.

For details on filter types, see [Chapter 7.5.1.6, "Which data may pass: filter types"](#), on page 496.

Remote command:

`[SENSe:]LIST:RANGe<ri>:FILTer:TYPE` on page 1040

### RBW

Sets the RBW value for this range.

For details on the RBW, see [Chapter 7.5.1.1, "Separating signals by selecting an appropriate resolution bandwidth"](#), on page 492.

Remote command:

`[SENSe:]LIST:RANGe<ri>:BANDwidth:RESolution` on page 1037

### VBW

Sets the VBW value for this range.

For details on the VBW, see [Chapter 7.5.1.2, "Smoothing the trace using the video bandwidth"](#), on page 493.

Remote command:

`[SENSe:]LIST:RANGe<ri>:BANDwidth:VIDeo` on page 1037

### Sweep Time Mode

Activates or deactivates the auto mode for the sweep time.

For details on the sweep time mode, see [Chapter 7.5.1.7, "How long the data is measured: Sweep Time"](#), on page 497

Remote command:

`[SENSe:]LIST:RANGe<ri>:SWEep:TIME:AUTO` on page 1045

### Sweep Time

Sets the sweep time value for the range.

For details on the sweep time, see [Chapter 7.5.1.7, "How long the data is measured: Sweep Time"](#), on page 497

Remote command:

`[SENSe:]LIST:RANGe<ri>:SWEep:TIME` on page 1045

### Detector

Sets the detector for the range.

For details, refer to ["Mapping samples to sweep points with the trace detector"](#) on page 609.

Remote command:

`[SENSe:]LIST:RANGe<ri>:DETEctor` on page 1038

**Reference Level**

Sets the reference level for the range.

For details on the reference level, see [Chapter 7.4.1.1, "Reference level"](#), on page 479.

Remote command:

`[SENSe:]LIST:RANGe<ri>:RLEVel` on page 1044

**RF Attenuation Mode**

Activates or deactivates the auto mode for RF attenuation.

For details on attenuation, see [Chapter 7.4.1.2, "RF attenuation"](#), on page 480.

**Note:** If an external frontend is active (see [External frontend settings](#)), you can configure attenuation settings for the external frontend and the analyzer separately. This setting defines the attenuation for the external frontend.

When using an external frontend, only mechanical attenuation is available.

For more information, see ["External frontend attenuation vs. analyzer attenuation"](#) on page 446.

Remote command:

`[SENSe:]LIST:RANGe<ri>:INPut:ATTenuation:AUTO` on page 1041

**RF Attenuation**

Sets the attenuation value for that range.

For details on attenuation, see [Chapter 7.4.1.2, "RF attenuation"](#), on page 480.

Remote command:

`[SENSe:]LIST:RANGe<ri>:INPut:ATTenuation` on page 1041

**SPA: RF Attenuation Mode / SPA: RF Attenuation**

If an external frontend is active (see [External frontend settings](#)), you can configure attenuation settings for the external frontend and the analyzer separately. This setting defines the attenuation for the analyzer.

For more information, see ["External frontend attenuation vs. analyzer attenuation"](#) on page 446.

When using an external frontend, only mechanical attenuation is available.

The RF attenuation can be set automatically as a function of the selected reference level (Auto mode). Automatic attenuation ensures that no overload occurs at the RF Input connector for the current reference level. It is the default setting.

In "Manual" mode, you can set the RF attenuation in 1 dB steps (down to 0 dB). Other entries are rounded to the next integer value. The range is specified in the specifications document. If the defined reference level cannot be set for the defined RF attenuation, the reference level is adjusted accordingly and the warning "limit reached" is displayed.

**NOTICE!** Risk of hardware damage due to high power levels. When decreasing the attenuation manually, ensure that the power level does not exceed the maximum level allowed at the RF input, as an overload can lead to hardware damage.

Remote command:

[\[SENSe:\]LIST:RANGe<ri>:INPut:SANalyzer:ATTenuation](#) on page 1042

[\[SENSe:\]LIST:RANGe<ri>:INPut:SANalyzer:ATTenuation:AUTO](#)

on page 1042

### Preamp

Switches the preamplifier on or off.

For details on the preamplifier, see ["Preamplifier"](#) on page 488.

Remote command:

[\[SENSe:\]LIST:RANGe<ri>:INPut:GAIN:STATe](#) on page 1041

### Sweep Points

Sets the number of sweep points for the specified range.

For details on sweep points, see [Chapter 7.5.1.8, "How much data is measured: sweep points and sweep count"](#), on page 497.

Remote command:

[\[SENSe:\]LIST:RANGe<ri>:POINTs\[:VALue\]](#) on page 1044

### Stop After Sweep

This command configures the sweep behavior.

"On"                    The FSW stops after one range is swept and continues only if you confirm (a message box is displayed).

"Off"                   The FSW sweeps all ranges in one go.

Remote command:

[\[SENSe:\]LIST:RANGe<ri>:BREak](#) on page 1037

### Transducer

Sets a transducer for the specified range. You can only choose a transducer that fulfills the following conditions:

- The transducer overlaps or equals the span of the range.
- The x-axis is linear.
- The unit is dB.

For details on transducers, see [Chapter 11.4.1, "Basics on transducer factors"](#), on page 754.

Remote command:

[\[SENSe:\]LIST:RANGe<ri>:TRANsducer](#) on page 1045

### Limit Check

Activates or deactivates the limit check for all ranges.

For details on limit checks, see [Chapter 6.7.3.2, "Limit lines in spurious measurements"](#), on page 282.

"ABSOLUTE"        Signal is checked against absolute limit values

"NONE"             No limit check is performed.

Remote command:

[\[SENSe:\]LIST:RANGe<ri>:LIMit:STATe](#) on page 1043

[CALCulate<n>:LIMit<li>:FAIL?](#) on page 1344

#### **Abs Limit Start/ Abs Limit Stop**

Sets an absolute limit value at the start or stop frequency of the range [dBm].

Remote command:

[\[SENSe:\]LIST:RANGe<ri>:LIMit:START](#) on page 1043

[\[SENSe:\]LIST:RANGe<ri>:LIMit:STOP](#) on page 1044

#### **Insert before Range/ Insert after Range**

Inserts a new range to the left of the currently focused range (before) or to the right (after). The range numbers of the currently focused range and all higher ranges are increased accordingly. The maximum number of ranges is 30.

#### **Delete Range**

Deletes the currently focused range. The range numbers are updated accordingly.

### **6.7.4.2 Adjusting the X-Axis to the range definitions**

**Access:** "Overview" > "Select Measurement" > "Spurious Emissions" > "Adjust X-Axis"

The frequency axis of the measurement diagram can be adjusted automatically so that the span of all sweep list ranges corresponds to the displayed span. Thus, the x-axis range is set from the start frequency of the first sweep range to the stop frequency of the last sweep range.

**Remote command:**

[\[SENSe:\]LIST:XADJust](#) on page 1048

### **6.7.4.3 List evaluation**

**Access:** "Overview" > "Select Measurement" > "Spurious Emissions" > "List Evaluation"

Configure the contents and display of the result list.



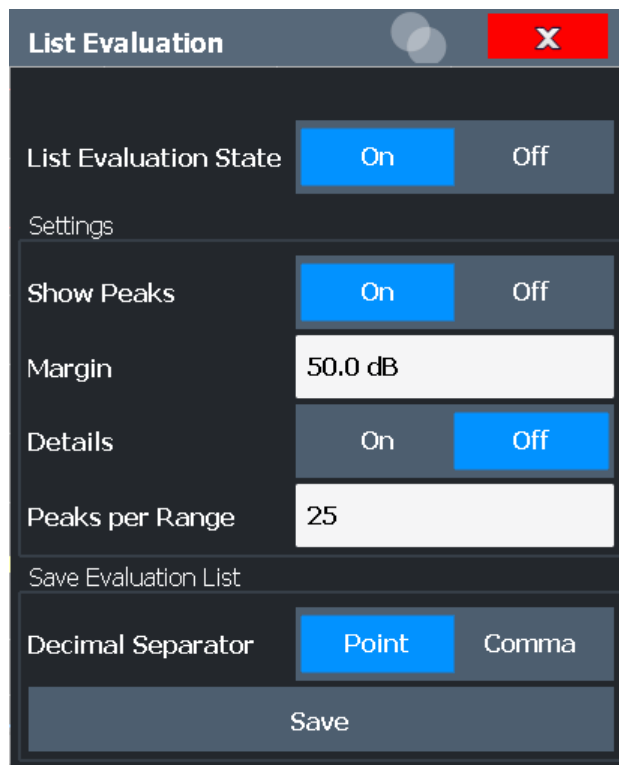

List Evaluation State.....	289
Show Peaks.....	289
Margin.....	289
Details.....	290
Peaks per Range.....	290
Save Evaluation List.....	290

### List Evaluation State

Activates or deactivates the list evaluation.

Remote command:

[CALCulate<n>:PEAKsearch:AUTO](#) on page 1046

### Show Peaks

If activated, all peaks that have been detected during an active list evaluation are marked with blue squares in the diagram.

Remote command:

[CALCulate<n>:PEAKsearch:PSHow](#) on page 1047

### Margin

A margin functionality is not available for the limit check. However, you can define a margin (=threshold) for the peak values to be displayed in the evaluation list. Only peaks that exceed the margin value are displayed (also in the diagram, if activated).

Remote command:

[CALCulate<n>:PEAKsearch:MARGIN](#) on page 1047

**Details**

Configures how detailed the list in the Result Summary is.

On	Includes all detected peaks (up to a maximum defined by "Peaks per Range").
Off	Includes only one peak per range.

Remote command:

[CALCulate<n>:ESpectrum:PEAKsearch:DEtails](#) on page 1046

**Peaks per Range**

Defines the maximum number of peaks per range that are stored in the list. Once the selected number of peaks has been reached, the peak search is stopped in the current range and continued in the next range. The maximum value is 50.

Remote command:

[CALCulate<n>:PEAKsearch:SUBRanges](#) on page 1047

**Save Evaluation List**

Exports the evaluation list of the Spurious Emissions measurement to an ASCII file for evaluation in an external application. If necessary, change the decimal separator for evaluation in other languages.

Define the file name and storage location in the file selection dialog box that is displayed when you select the "Save" function.

For details, see ["How to Save the Spurious Emissions Evaluation List"](#) on page 291.

Remote command:

[MMEMory:STORe<n>:LIST](#) on page 1373

[FORMat:DEXPort:DSEPARATOR](#) on page 1348

**6.7.5 How to perform a spurious emissions measurement**

The following step-by-step instructions demonstrate how to perform spurious emissions measurements.



For remote operation, see [Chapter 13.5.8.7, "Programming example: spurious emissions measurement"](#), on page 1048.

1. Press [MEAS], then select the "Spurious Emissions" measurement.
2. Define the span of the signal to be monitored in the general span settings.
3. Select "Overview", then select "Spurious Setup".  
The "Spurious Emissions" dialog box is displayed.
4. Split the frequency span of the measurement into ranges for signal parts with similar characteristics.  
Define the required ranges in the "Sweep List" using "Insert before Range" and "Insert after Range", which refer to the currently selected range.

5. Define the measurement parameters for each range as required.
6. Optionally, define a limit check.
  - a) Activate the limit check by setting "Limit Check" to "ABSOLUTE". The limit check is always activated or deactivated for all ranges simultaneously.
  - b) Define the limit line's start and stop values for each range of the signal. If a signal level higher than the defined limit is measured, the limit check fails, which may indicate a spurious emission.
7. Configure the peak detection during a Spurious Emissions measurement: select "Evaluations" in the "Overview".
  - To indicate the determined peaks in the display, activate the "Show Peaks" option.
  - To restrict peak detection, define a "Margin". Only peaks that exceed this value are detected.
  - To allow for more peaks per range to be detected than the default 1, increase the "Peaks per Range" value and set "Details" to "On".
8. Start a sweep.

The determined powers and limit deviations for each range are indicated in the evaluation list. If activated, the peak power levels for each range are also indicated in the diagram.
9. To save the evaluation list, export the results to a file as described in ["How to Save the Spurious Emissions Evaluation List"](#) on page 291.

#### How to Save the Spurious Emissions Evaluation List

The evaluation list from a Spurious Emissions measurement can be saved to a file, which can be exported to another application for further analysis, for example.

1. Configure and perform a Spurious Emissions measurement as described in [Chapter 6.7.5, "How to perform a spurious emissions measurement"](#), on page 290.
2. Select "Evaluations" in the "Overview".
3. If necessary, change the "Decimal Separator" to "COMMA" for evaluation in other languages.
4. Select "Save".
5. In the file selection dialog box, select a storage location and file name for the result file.
6. Select "Save".

The file with the specified name and the extension `.dat` is stored in the defined storage location.

### 6.7.6 Reference: ASCII export file format (spurious)

The file has a header containing important parameters for scaling, several data sections containing the sweep settings per range, and a data section containing the peak list.

The header data is made up of three columns, separated by ';', with the syntax:

Parameter name; numeric value; basic unit

File contents	Explanation
<b>File header</b>	
Type;FSW-26	Model
Version;1.00;	Firmware version
Date;31.Mar 11;	Storage date of data set
Mode;ANALYZER; SPURIOUS;	Operating mode and measurement function
Center Freq;1325000000.000000;Hz	X-axis settings
Freq Offset;0.000000;Hz	
Span;26499982000.000000;Hz	
x-Axis;LIN;	
Start;9000.000000;Hz	
Stop;8000000000.000000;Hz	
Level Offset;0.000000;dB	Y-axis settings
Ref Position;100.000000;%	
y-Axis;LOG;	
Level Range;100.000000;dB	
<b>Trace settings</b>	
Trace Mode;CLR/WRITE;	
Sweep Count;1;	
TRACE 1:	
Trace Mode;CLR/WRITE;	
x-Unit;Hz;	
y-Unit;dBm;	
<b>List evaluation settings</b>	
Margin;6.000000;s	Peak List margin
PeaksPerRange;25;	Max. number of peaks per range to be detected
Values;3;	Number of detected peaks

File contents	Explanation
<b>File data section</b>	
0;9000;150000;1000;79500;-25.006643295288086;-12.006643295288086;PASS;	Measured peak values: <range number>; <start frequency>; <stop frequency>; <resolution bandwidth of range>; <frequency of peak>; <absolute power in dBm of peak>; <distance to the limit line in dB>; (positive value means above the limit) <limit fail (pass = 0, fail =1)>;
0;9000;150000;1000;101022.11126961483;-47.075111389160156;-34.075111389160156;PASS;	
0;9000;150000;1000;58380.171184022824;-47.079341888427734;-34.079341888427734;PASS;	

## 6.8 Statistical measurements (APD, CCDF)

To measure the amplitude distribution, the FSW has simple measurement functions to determine both the Amplitude Probability Distribution (APD) and the Complementary Cumulative Distribution Function (CCDF). Only one of the signal statistic functions can be switched on at a time.

- [About the measurements](#).....293
- [Typical applications](#).....294
- [APD and CCDF results](#).....294
- [APD and CCDF basics - gated triggering](#).....296
- [APD and CCDF configuration](#).....297
- [How to perform an APD or CCDF measurement](#).....304
- [Examples](#).....305
- [Optimizing and troubleshooting the measurement](#).....308

### 6.8.1 About the measurements

The probability of amplitude values can be measured with the Amplitude Probability Distribution function (APD). During a selectable measurement time all occurring amplitude values are assigned to an amplitude range. The number of amplitude values in the individual ranges is counted and the result is displayed as a histogram.

Alternatively, the Complementary Cumulative Distribution Function (CCDF) can be displayed. It shows the probability that the mean signal power amplitude will be exceeded in percent.

Only one of the signal statistic functions can be switched on at a time. When a statistic function is switched on, the FSW is set into zero span mode automatically. The FSW measures the statistics of the signal applied to the RF input with the defined analysis bandwidth. To avoid affecting the peak amplitudes the video bandwidth is automatically set to 10 times the analysis bandwidth. The sample detector is used for detecting the video voltage.

Statistic measurements on pulsed signals can be performed using a gated trigger. For details see [Chapter 6.8.4, "APD and CCDF basics - gated triggering"](#), on page 296.

## 6.8.2 Typical applications

Digital modulated signals are similar to white noise within the transmit channel, but are different in their amplitude distribution. In order to transmit the modulated signal without distortion, all amplitudes of the signal have to be transmitted linearly from the output power amplifier. Most critical are the peak amplitude values. Degradation in transmit quality caused by a transmitter two port network is dependent on the amplitude of the peak values as well as on their probability.

If modulation types are used that do not have a constant envelope in zero span, the transmitter has to handle peak amplitudes that are greater than the average power. This includes all modulation types that involve amplitude modulation, QPSK for example. CDMA transmission modes in particular may have power peaks that are large compared to the average power.

For signals of this kind, the transmitter must provide large reserves for the peak power to prevent signal compression and thus an increase of the bit error rate at the receiver. The peak power or the crest factor of a signal is therefore an important transmitter design criterion. The crest factor is defined as the peak power to mean power ratio or, logarithmically, as the peak level minus the average level of the signal. To reduce power consumption and cut costs, transmitters are not designed for the largest power that could ever occur, but for a power that has a specified probability of being exceeded (e.g. 0.01 %).

The statistical functions provide information on such signal criteria.

## 6.8.3 APD and CCDF results

### Amplitude Probability Distribution (APD)

As a result of the Amplitude Probability Distribution (APD) function, the probability of measured amplitude values is displayed. During a selectable measurement time all measured amplitude values are assigned to an amplitude range (*bin*). The number of amplitude values in the individual ranges is counted and the result is displayed as a histogram. Each bar of the histogram represents the percentage of measured amplitudes within the specific amplitude range. The x-axis represents the amplitude values and is scaled in absolute values (dBm).



The size of each amplitude range (bin) determines the resolution of the histogram and is indicated in the channel bar, for example / 0.10 dB. In this case, a single bar in the histogram represents an amplitude range of 0.10 dB.

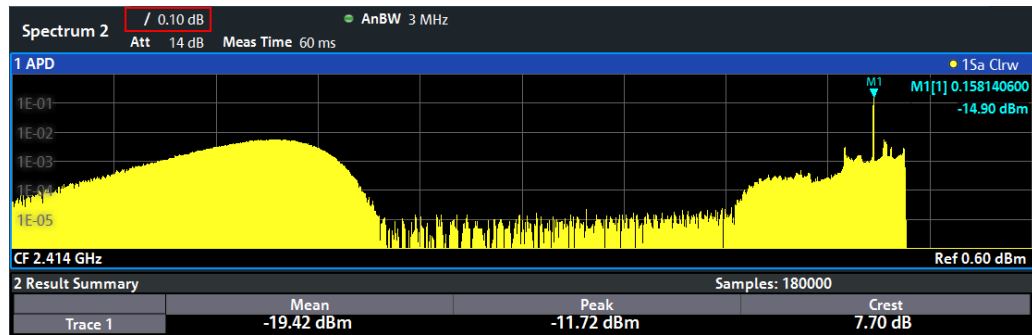

In addition to the histogram, a result table is displayed containing the following information:

- Number of samples used for calculation
- For each displayed trace:
  - Mean amplitude
  - Peak amplitude
  - Crest factor
    - The crest factor is defined as the peak power to mean power ratio or, logarithmically, as the peak level minus the average level of the signal.

### Complementary Cumulative Distribution Function (CCDF)

The Complementary Cumulative Distribution Function (CCDF) shows the probability that the signal power amplitude exceeds the mean value in percent. The level above the mean power is plotted along the x-axis of the graph. The origin of the axis corresponds to the mean power level. The probability that a level will be exceeded is plotted along the y-axis.

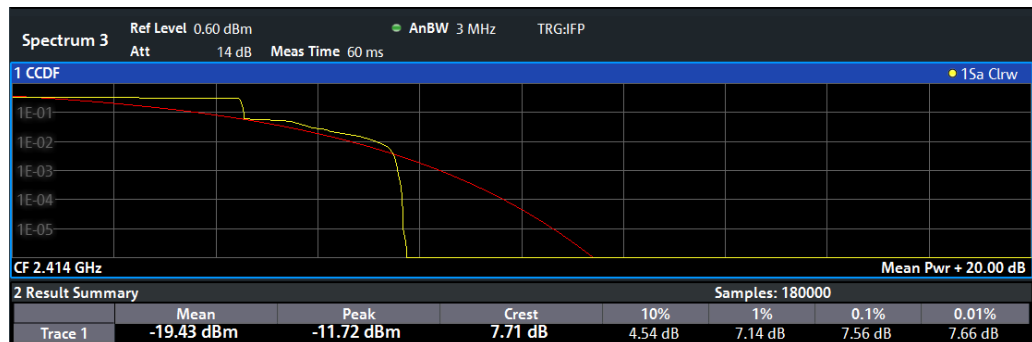

A red line indicates the ideal Gaussian (normal) distribution for the measured amplitude range.

The displayed amplitude range is indicated as "Mean Pwr" + "<x dB>"

In addition to the histogram, a result table is displayed containing the following information:

- Number of samples used for calculation

- For each displayed trace:

<b>Mean</b>	Mean power
<b>Peak</b>	Peak power
<b>Crest</b>	Crest factor (peak power – mean power)
<b>10 %</b>	10 % probability that the level exceeds mean power + [x] dB
<b>1 %</b>	1 % probability that the level exceeds mean power + [x] dB
<b>0,1 %</b>	0,1 % probability that the level exceeds mean power + [x] dB
<b>0,01 %</b>	0,01 % probability that the level exceeds mean power + [x] dB

### Percent marker

In addition to the results for specific percentages in the table, a percent marker can be activated for a freely selectable percentage. This marker indicates how many level values are over <x> % above the mean power.



### Percent marker

As all markers, the percent marker can be moved simply by selecting it with a finger or mouse cursor and dragging it to the desired position.

### Diagram Scaling

The scaling for both the x-axis and y-axis of the statistics diagram can be configured. In particular, you can restrict the range of amplitudes to be evaluated and the probabilities to be displayed.

### Remote commands:

[CALCulate<n>:STATistics:CCDF:X<t>?](#) on page 1059

[CALCulate<n>:STATistics:RESult<res>?](#) on page 1059

## 6.8.4 APD and CCDF basics - gated triggering

Statistic measurements on pulsed signals can be performed using a gated trigger. An external or power trigger is required as a time (frame) reference.

The gate ranges define the part of the measured data taken into account for the statistics calculation. These ranges are defined relative to a reference point T=0. The gate interval is repeated for each period until the end of the capture buffer.

The reference point T=0 is defined by the external trigger event and the instrument's trigger offset.

For each trace you can define up to 3 separate ranges of a single period to be traced.



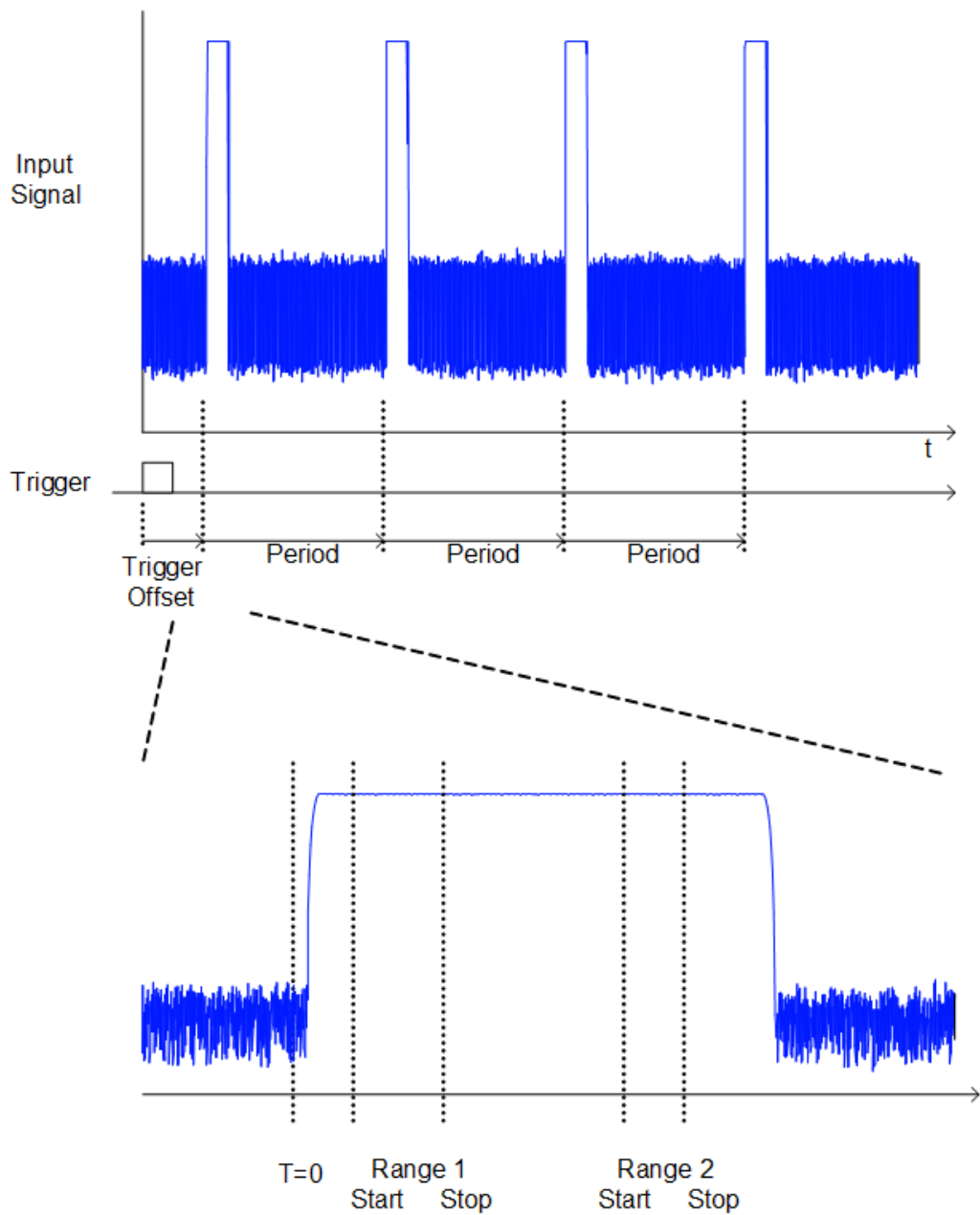

### 6.8.5 APD and CCDF configuration

Configuration consists of the following settings:

- Make sure the specified reference level is higher than the measured peak value (see "Reference Level" on page 484).
- [Basic settings](#).....298
- [Gate range definition for APD and CCDF](#).....300
- [Scaling for statistics diagrams](#).....301

### 6.8.5.1 Basic settings

**Access:** "Overview" > "Select Measurement" > "APD"/"CCDF" > "APD Config"/ "CCDF Config"

The remote commands required to perform these tasks are described in [Chapter 13.5.9, "Analyzing statistics \(APD, CCDF\)"](#), on page 1051.

CCDF	
Percent Marker	0.0 %
Analysis Bandwidth	80.0 MHz
Number of Samples	100 000
Gated Trigger	On Off
Normal Distribution	On Off
Edit Gate Ranges	
Adjust Settings	

Both dialog boxes are identical except for the "Percent Marker" setting, which is only available for CCDF measurements.

Percent Marker (CCDF only).....	298
Analysis Bandwidth.....	298
Number of Samples.....	299
Gated Trigger.....	299
Normal Distribution.....	299
Edit Gate Ranges.....	299
Adjust Settings.....	299

#### Percent Marker (CCDF only)

Defines a probability value. Thus, the power which is exceeded with a given probability can be determined very easily. If marker 1 is deactivated, it is switched on automatically.

Remote command:

`CALCulate<n>:MARKer<m>:Y:PERCent` on page 1052

#### Analysis Bandwidth

Defines the analysis bandwidth.

For correct measurement of the signal statistics, the analysis bandwidth has to be wider than the signal bandwidth in order to measure the peaks of the signal amplitude correctly. To avoid influencing the peak amplitudes, the video bandwidth is automatically set to 10 MHz. The sample detector is used for detecting the video voltage.

If a B4001/B6001/B8001 bandwidth extension option is installed, APD and CCDF measurements are only available up to a bandwidth of 80 MHz.

The calculated measurement time is displayed for reference only.

Remote command:

[\[SENSe:\]BANDwidth\[:RESolution\]](#) on page 1198

### Number of Samples

Defines the number of power measurements that are taken into account for the statistics.

For statistics measurements with the FSW, the number of samples to be measured is defined instead of the sweep time. Since only statistically independent samples contribute to statistics, the sweep or measurement time is calculated automatically and displayed in the channel bar ("Meas Time"). The samples are statistically independent if the time difference is at least 1/RBW. The measurement time is, therefore, expressed as follows:

$$\text{Meas Time} = N_{\text{Samples}}/\text{RBW}$$

The maximum number of samples is limited by the hardware capability. For gated triggered APD or CCDF measurements, the maximum number is limited further, if necessary, to accommodate for very small ranges within a relatively long period. In this case, the smallest gate/period ratio is considered, and the number is adapted to capture full periods of data. If the defined number of samples exceeds the limit, it is automatically reduced to the maximum value.

Remote command:

[CALCulate<n>:STATistics:NSAMples](#) on page 1053

### Gated Trigger

Activates and deactivates gating for statistics functions for the ACP and the CCDF measurements. The gate ranges are defined using the [Edit Gate Ranges](#) function.

Remote command:

[\[SENSe:\]SWEep:EGATe](#) on page 1224

### Normal Distribution

Enables or disables the red trace in the CCDF display indicating the normal distribution.

Remote command:

[DISPlay\[:WINDow<n>\]:STATistics:CCDF:GAUSS](#) on page 1053

### Edit Gate Ranges

Opens a dialog box to configure up to 3 gate ranges for each trace. For details see [Chapter 6.8.5.2, "Gate range definition for APD and CCDF"](#), on page 300.

### Adjust Settings

Adjusts the level settings according to the measured difference between peak and minimum power for APD measurement or peak and mean power for CCDF measurement in order to obtain maximum power resolution. Adjusts the reference level to the current input signal.

Note this function is not available when using an external frontend.

Remote command:

CALCulate<n>:STATistics:SCALE:AUtO ONCE on page 1056

### 6.8.5.2 Gate range definition for APD and CCDF

**Access:** "Overview" > "Select Measurement" > "APD"/"CCDF" > "APD Config"/ "CCDF Config" > "Edit Gate Ranges"

You can configure gate ranges for gated triggering in statistical measurements.

For background information on defining gate ranges see [Chapter 6.8.4, "APD and CCDF basics - gated triggering"](#), on page 296.

The remote commands required to perform these tasks are described in [Chapter 13.5.9.3, "Using gate ranges for statistical measurements"](#), on page 1053.

Gate Ranges						
	Trace 1	Trace 2	Trace 3	Trace 4	Trace 5	Trace 6
Comment						
Period	2 ms	2 ms	2 ms	2 ms	2 ms	2 ms
Range 1 Use	On	Off	Off	Off	Off	Off
Range 1 Start	0 s	0 s	0 s	0 s	0 s	0 s
Range 1 Stop	1 ms	1 ms	1 ms	1 ms	1 ms	1 ms
Range 2 Use	Off	Off	Off	Off	Off	Off
Range 2 Start	2 ms	2 ms	2 ms	2 ms	2 ms	2 ms
Range 2 Stop	3 ms	3 ms	3 ms	3 ms	3 ms	3 ms
Range 3 Use	Off	Off	Off	Off	Off	Off
Range 3 Start	4 ms	4 ms	4 ms	4 ms	4 ms	4 ms
Range 3 Stop	5 ms	5 ms	5 ms	5 ms	5 ms	5 ms

Up to three ranges can be defined for each of the six available traces.

Comment.....300  
 Period.....300  
 Range <x> Use..... 301  
 Range <x> Start/Stop.....301

#### Comment

An optional comment can be defined for the gate range settings of each trace.

Remote command:

[SENSe:]SWEep:EGATe:TRACe<t>:COMMeNt on page 1053

#### Period

Length of the period to be traced. The period is the same for all traces. If you change the period for one trace, it is automatically changed for all traces.

Make sure the defined period is not longer than the total measurement time of the current measurement. Keep in mind that the measurement time depends on the bandwidth and the number of samples (see ["Number of Samples"](#) on page 299). The current measurement time is indicated as "Meas Time" in the channel bar.

Remote command:

[\[SENSe:\] SWEep:EGATe:TRACe<t>:PERiod](#) on page 1054

#### **Range <x> Use**

Activates tracing of the defined range during a gated measurement.

Remote command:

[\[SENSe:\] SWEep:EGATe:TRACe<t>\[:STATe<gr>\]](#) on page 1055

#### **Range <x> Start/Stop**

Defines the start and stop points of the range within the tracing period. Make sure the value for the stopping time is smaller than the length of the period.

**Note:** You can define the time values with a greater numerical resolution than is displayed; the values are only rounded for display.

Remote command:

[\[SENSe:\] SWEep:EGATe:TRACe<t>:START<gr>](#) on page 1054

[\[SENSe:\] SWEep:EGATe:TRACe<t>:STOP<gr>](#) on page 1055

### **6.8.5.3 Scaling for statistics diagrams**

**Access:** "Overview" > "Amplitude" > "Scale" tab

**Or:** [AMPT] > "Scale Config"

For statistics displays, scale settings are available for both the y-axis and the x-axis.

The remote commands required to perform these tasks are described in [Chapter 13.5.9.4, "Scaling the diagram"](#), on page 1056.

Amplitude		Scale	
X-Axis		Y-Axis	
Range	20 dB	Y-Unit	Pct <b>Abs</b>
Ref Level	0.0 dBm	Y-Max	1.0
Offset	0.0 dB	Y-Min	1.0E-06
Adjust Settings		Default Settings	

Figure 6-51: Scale settings for CCDF diagram



In statistical diagrams, the x-axis displays the signal level values (= y-axis in standard display), while the y-axis displays the probability of the values.

X-Axis.....	302
L Ref Level.....	302
L Range.....	302
L Shifting the Display (Offset).....	303
Y-Axis.....	303
L Y-Unit.....	303
L Y-Max/ Y-Min.....	303
Default Settings.....	303
Adjust Settings.....	304

### X-Axis

Defines the scaling settings for signal level values.

#### Ref Level ← X-Axis

Defines the reference level for the signal levels in the currently active unit (dBm, dBμV, etc.).

For the APD function this value corresponds to the right diagram border. For the CCDF function there is no direct representation of this value on the diagram as the x-axis is scaled relatively to the measured mean power.

Remote command:

`CALCulate<n>:STATistics:SCALE:X:RLEVel` on page 1057

#### Range ← X-Axis

Defines the level range in dB to be evaluated by the statistics measurement.

Remote command:

[CALCulate<n>:STATistics:SCALE:X:RANGE](#) on page 1057

### Shifting the Display (Offset) ← X-Axis

Defines an arithmetic level offset. This offset is added to the measured level irrespective of the selected unit. The scaling of the x-axis is changed accordingly. The setting range is  $\pm 200$  dB in 0.1 dB steps.

Remote command:

[DISPlay\[:WINDow<n>\]\[:SUBWindow<w>\]:TRACe<t>:Y\[:SCALE\]:RLEVEL:OFFSET](#) on page 1208

### Y-Axis

Defines the scaling settings for the probability distribution.

#### Y-Unit ← Y-Axis

Defines the scaling type of the y-axis as either percentage or absolute. The default value is absolute scaling.

Remote command:

[CALCulate<n>:STATistics:SCALE:Y:UNIT](#) on page 1058

#### Y-Max/ Y-Min ← Y-Axis

Defines the upper (max) and lower (min) limit of the displayed probability range. Values on the y-axis are normalized which means that the maximum value is 1.0. The minimum value must be in the range:

$$1E-9 < Y\text{-Min} < 0.1$$

The distance between "Y-Max" and "Y-Min" must be at least one decade.

Remote command:

[CALCulate<n>:STATistics:SCALE:Y:UPPER](#) on page 1058

[CALCulate<n>:STATistics:SCALE:Y:LOWER](#) on page 1057

### Default Settings

Resets the x- and y-axis scalings to their preset values.

X-axis ref level:	0 dBm
X-axis range APD:	100 dB
X-axis range CCDF:	20 dB
Y-axis upper limit:	1.0
Y-axis lower limit:	1E-6

Remote command:

[CALCulate<n>:STATistics:PRESet](#) on page 1056

**Adjust Settings**

Adjusts the level settings according to the measured difference between peak and minimum power for APD measurement or peak and mean power for CCDF measurement in order to obtain maximum power resolution. Adjusts the reference level to the current input signal.

Note this function is not available when using an external frontend.

Remote command:

`CALCulate<n>:STATistics:SCALE:AUTO ONCE` on page 1056

**6.8.6 How to perform an APD or CCDF measurement**

The following step-by-step instructions demonstrate how to perform basic statistic measurements.



For remote operation, see [Chapter 13.5.9.7, "Programming example: measuring statistics"](#), on page 1060.

**To start a basic statistic measurement**

1. Press [MEAS], then select the "APD" or "CCDF" measurement.
2. Start a sweep.

As soon as the defined number of samples have been measured, the statistical evaluation is displayed.

**To perform a statistic measurement using gate ranges**

For pulsed signals, the transmission intervals should not be included in the statistical evaluation. Thus, you must define gate ranges to be included in the measurement.

1. Press [MEAS Config], then select "APD Config" or "CCDF Config".  
The "APD""APD" or "CCDF" dialog box is displayed.
2. Select "Edit Gate Ranges".
3. Define the time period for which the input signal is to be analyzed, for example the duration of 3 signal pulses.
4. For each active trace, define up to three ranges within the time period to be measured. In the example covering 3 pulses, you could define one range for each pulse.
  - a) Assuming the external trigger determines  $T=0$  as the start of the first pulse, define the start time of range 1 at 0 s.
  - b) Define the stop time of range 1 at the duration of the first pulse.
  - c) Activate range 1 by setting "Range 1 Use" to *On*.
  - d) Define the start time of range 2 as (duration of pulse 1 + duration of interval)
  - e) Define the stop time of range 2 as (start time of range 2 + duration of pulse 2)
  - f) Activate range 2 by setting "Range 2 Use" to *On*.



- g) Define the third range in the same way.
- 5. Start a sweep.

As soon as the defined number of samples have been measured, the statistical evaluation is displayed. Only the signal levels within the pulse periods are considered.

### 6.8.7 Examples

#### 6.8.7.1 Configuration example: gated statistics

A statistics evaluation has to be done over the useful part of the signal between t3 and t4. The period of the GSM signal is 4.61536 ms.

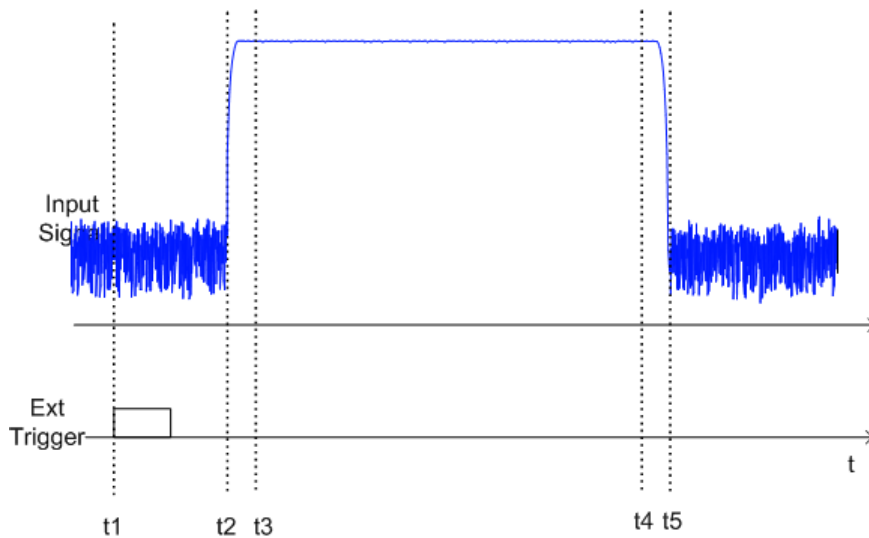

- t1: External positive trigger slope
- t2: Begin of burst (after 25  $\mu$ s)
- t3: Begin of useful part, to be used for statistics (after 40  $\mu$ s)
- t4: End of useful part, to be used for statistics (after 578  $\mu$ s)
- t5: End of burst (after 602  $\mu$ s)

The instrument has to be configured as follows:

Trigger Offset	$t2 - t1 = 25 \mu$ s	now the gate ranges are relative to t2
Range1 Start	$t3 - t2 = 15 \mu$ s	start of range 1 relative to t2
Range1 End	$t4 - t2 = 553 \mu$ s	end of range 1 relative to t2

### 6.8.7.2 Measurement example – measuring the APD and CCDF of white noise generated by the FSW



#### Setting the analysis bandwidth

When the amplitude distribution is measured, the analysis bandwidth must be set so that the complete spectrum of the signal to be measured falls within the bandwidth. This is the only way of ensuring that all the amplitudes will pass through the IF filter without being distorted. If the selected bandwidth is too small for a digitally modulated signal, the amplitude distribution at the output of the IF filter becomes a Gaussian distribution according to the central limit theorem and thus corresponds to a white noise signal. The true amplitude distribution of the signal therefore cannot be determined.



A programming example demonstrating a statistics measurement in a remote environment is provided in [Chapter 13.5.9.7, "Programming example: measuring statistics"](#), on page 1060.

1. Preset the FSW.
2. Set the reference level to *-60 dBm*.  
The FSW's intrinsic noise is displayed at the top of the screen.
3. Select the "APD" measurement function from the "Select Measurement" dialog box.

The FSW sets the frequency span to 0 Hz and measures the amplitude probability distribution (APD). The number of uncorrelated level measurements used for the measurement is 100000. The mean power and the peak power are displayed in dBm. The crest factor (peak power – mean power) is output as well.

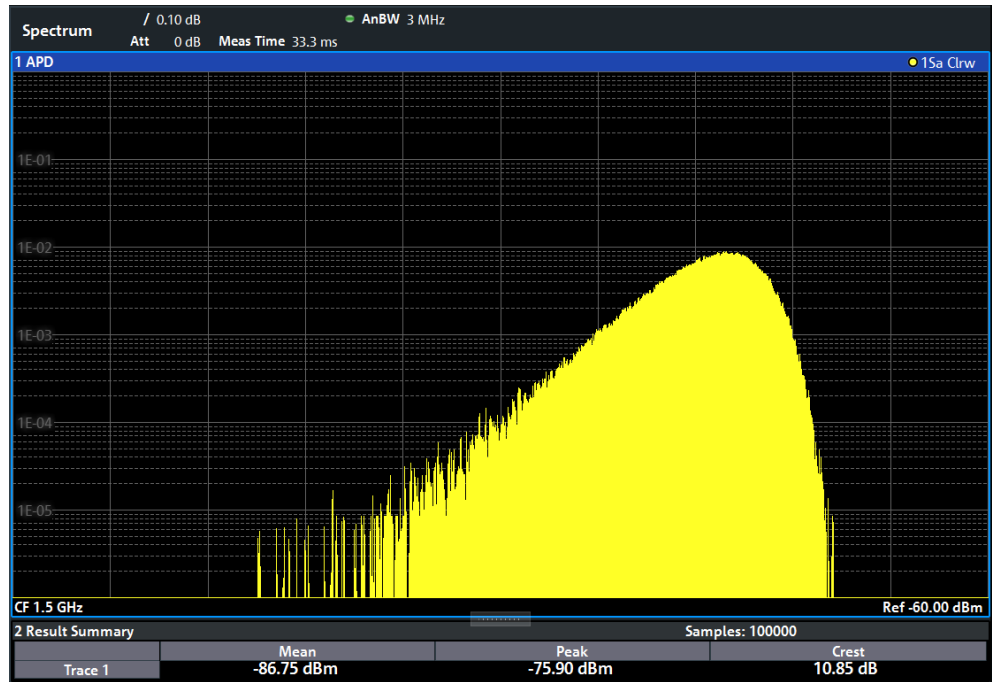

Figure 6-52: Amplitude probability distribution of white noise

- Now select the "CCDF" measurement function from the "Select Measurement" dialog box.

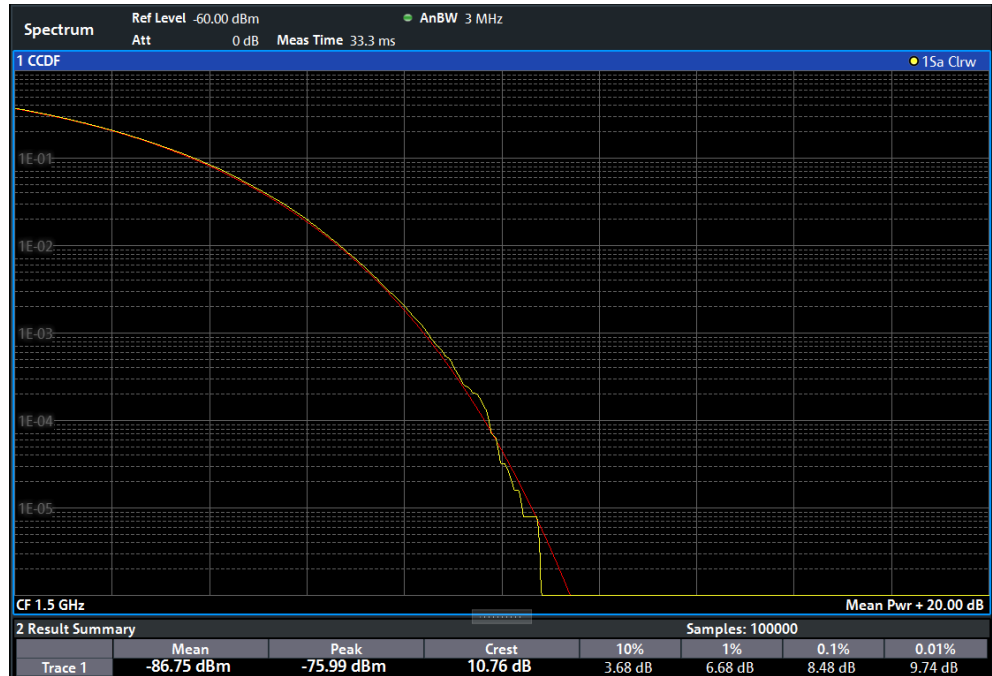

Figure 6-53: CCDF of white noise

The CCDF trace indicates the probability that a level will exceed the mean power. The level above the mean power is plotted along the x-axis of the graph. The origin of the axis corresponds to the mean power level. The probability that a level will be exceeded is plotted along the y-axis.

### 6.8.8 Optimizing and troubleshooting the measurement

If the results do not meet your expectations, try the following methods to optimize the measurement:

- Make sure the defined bandwidth is wide enough for the signal bandwidth of the device under test to be fully analyzed (see ["Analysis Bandwidth"](#) on page 298).
- If the complete signal is to be measured, increase the number of samples so that the resulting measurement time is longer than one period of a bursted signal.
- If only parts of the signal are to be examined, define a trigger source and a gate.

## 6.9 Time domain power measurement

The Time Domain Power measurement determines the power of a signal in the time domain.

A time domain power measurement is only possible for zero span.

- [About the measurement](#).....308
- [Time domain power results](#)..... 308
- [Time domain power basics - range definition using limit lines](#)..... 309
- [Time domain power configuration](#)..... 310
- [How to measure powers in the time domain](#)..... 311
- [Measurement example](#).....312

### 6.9.1 About the measurement

Using the Time Domain Power measurement function, the FSW determines the power of the signal in zero span by summing up the power at the individual measurement points and dividing the result by the number of measurement points. Thus it is possible to measure the power of TDMA signals during transmission, for example, or during the muting phase. Both the mean power and the RMS power can be measured.

For this measurement, the sample detector is recommended. The sample detector is activated automatically if the detector is in auto mode.

### 6.9.2 Time domain power results

Several different power results can be determined simultaneously:

Mode	Description
Peak	Peak value from the points of the displayed trace or a segment thereof.
RMS	RMS value from the points of the displayed trace or a segment thereof.
Mean	Mean value from the points of the displayed trace or a segment thereof. The linear mean value of the equivalent voltages is calculated. For example to measure the mean power during a GSM burst
Std Dev	The standard deviation of the measurement points from the mean value.

The result is displayed in the marker results, indicated by "Power" and the selected power mode, e.g. "RMS". The measured values are updated after each sweep or averaged over a user-defined number of sweeps (trace averaging).

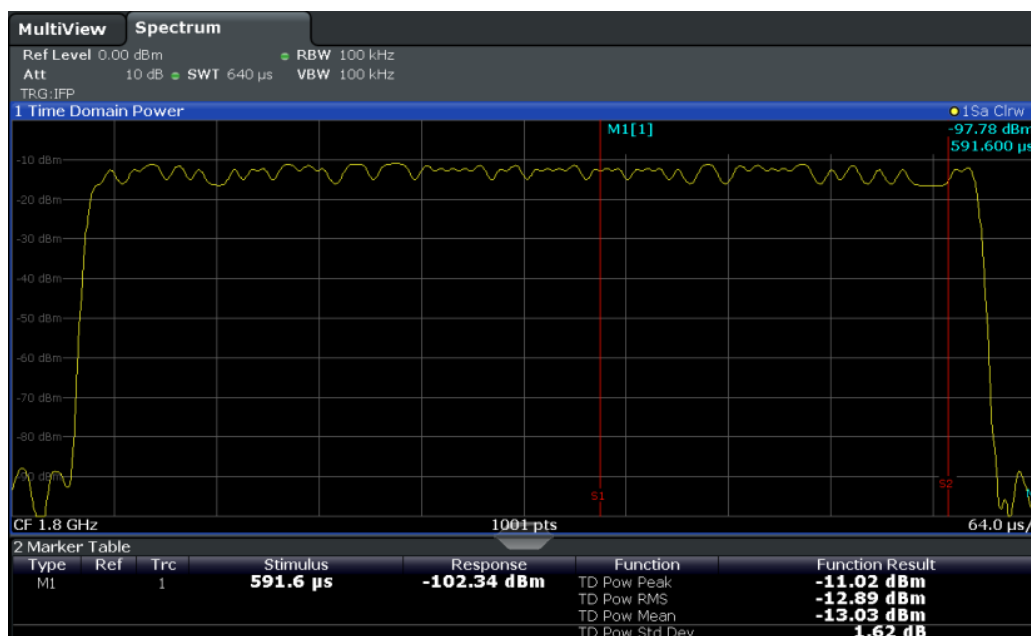

The results can also be queried using the remote commands described in [Chapter 13.5.10, "Measuring the time domain power"](#), on page 1061.

### 6.9.3 Time domain power basics - range definition using limit lines

The range of the measured signal to be evaluated for the power measurement can be restricted using limit lines. The left and right limit lines (S1, S2) define the evaluation range and are indicated by vertical red lines in the diagram. If activated, the power results are only calculated from the levels within the limit lines.

For example, if both the on and off phase of a burst signal are displayed, the measurement range can be limited to the transmission or to the muting phase. The ratio

between signal and noise power of a TDMA signal for instance can be measured by using a measurement as a reference value and then varying the measurement range.



In order to get stable measurement results for a limited evaluation range, usually a trigger is required.

#### 6.9.4 Time domain power configuration

**Access:** "Overview" > "Select Measurement" > "Time Domain Power" > "Time Dom Power Config"

Time Domain Power		
Results		
Peak	On	Off
RMS	On	Off
Mean	On	Off
Std Dev	On	Off
Limits		
State	On	Off
Left	-----	
Right	-----	

The remote commands required to perform these tasks are described in [Chapter 13.5.10, "Measuring the time domain power"](#), on page 1061.

<a href="#">Results</a> .....	311
<a href="#">Limit State</a> .....	311
<a href="#">Left Limit / Right Limit</a> .....	311

**Results**

Activates the power results to be evaluated from the displayed trace or a limited area of the trace.

"Peak"	Peak power over several measurements (uses trace averaging, Max Hold)
"RMS"	RMS value from the points of the displayed trace or a segment thereof.
"Mean"	Mean value from the points of the displayed trace or a segment thereof. The linear mean value of the equivalent voltages is calculated.
"Std Dev"	The standard deviation of the measurement points from the mean value. The measurement of the mean power is automatically switched on at the same time.

Remote command:

[CALCulate<n>:MARKer<m>:FUNCTION:SUMMARY:PPEak\[:STATE\]](#) on page 1064  
[CALCulate<n>:MARKer<m>:FUNCTION:SUMMARY:PPEak:RESult?](#) on page 1067  
[CALCulate<n>:MARKer<m>:FUNCTION:SUMMARY:RMS\[:STATE\]](#) on page 1064  
[CALCulate<n>:MARKer<m>:FUNCTION:SUMMARY:RMS:RESult?](#) on page 1068  
[CALCulate<n>:MARKer<m>:FUNCTION:SUMMARY:MEAN\[:STATE\]](#) on page 1063  
[CALCulate<n>:MARKer<m>:FUNCTION:SUMMARY:MEAN:RESult?](#) on page 1066

**Limit State**

Switches the limitation of the evaluation range on or off. Default setting is off.

If deactivated, the entire sweep time is evaluated. If switched on, the evaluation range is defined by the left and right limit. If only one limit is set, it corresponds to the left limit and the right limit is defined by the stop frequency. If the second limit is also set, it defines the right limit.

Remote command:

[CALCulate<n>:MARKer<m>:X:SLIMits\[:STATE\]](#) on page 1278

**Left Limit / Right Limit**

Defines a power level limit for line S1 (left) or S2 (right).

Remote command:

[CALCulate<n>:MARKer<m>:X:SLIMits:LEFT](#) on page 1278

[CALCulate<n>:MARKer<m>:X:SLIMits:RIGHT](#) on page 1279

**6.9.5 How to measure powers in the time domain**

The step-by-step procedure to measure powers in the time domain is described here in detail.

**To measure the power in the time domain**

1. Select [MEAS].

2. From the "Select Measurement" dialog box, select the "Time Domain Power" measurement function.
3. Select the type of power measurement results to be determined by selecting the corresponding softkeys.
4. To restrict the power evaluation range, define limits:
  - a) Select "Time Dom Power Config" to display the "Time Domain Power" configuration dialog box.
  - b) Switch on the limits by setting the "Limit State" to "On".  
The limit lines S1 and S2 are displayed.
  - c) Define the left limit (limit line S1), the right limit (S2), or both.
5. Start a sweep.  
The measured powers are displayed in the marker results.

### 6.9.6 Measurement example

This measurement example demonstrates the time domain power calculation for a GSM burst.



For remote operation, see [Chapter 13.5.10.4, "Programming example: time domain power"](#), on page 1070.

#### Test setup:

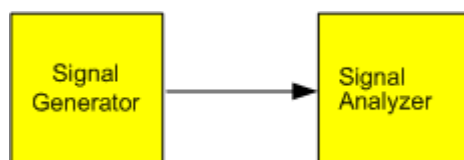

#### Signal generator settings (e.g. R&S SMW):

Frequency:	1.8 GHz
Level:	-10 dBm
Modulation:	GSM/EDGE

#### Procedure:

1. Preset the FSW.
2. Set the center frequency to *1.8 GHz*.
3. Set the RBW to *100 kHz*.
4. Set the sweep time to *640 μs*.
5. Set the trigger source to "IF Power".



## Harmonic distortion measurement

6. Define a trigger offset of  $-50 \mu\text{s}$ .
7. Select the "Time Domain Power" measurement function from the "Select Measurement" dialog box.
8. In the Time Domain Power configuration dialog box, set all four results to "On".
9. Set the "Limit State" to "On".
10. Define the left limit at  $326 \mu\text{s}$  and the right limit at  $538 \mu\text{s}$ .  
This range corresponds to the useful part of the GSM burst.

The mean power of the useful part of the GSM burst is calculated to be  $-13 \text{ dBm}$ .

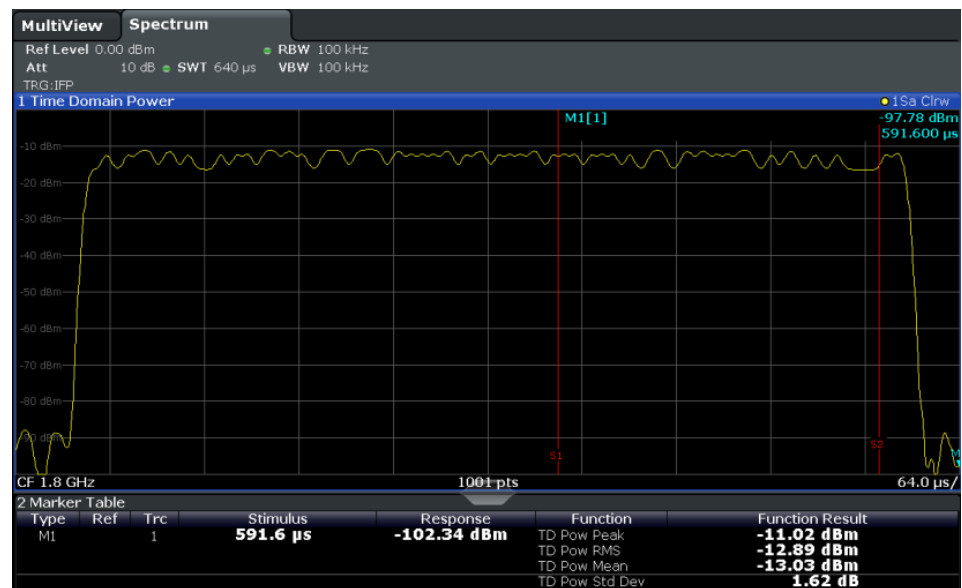

## 6.10 Harmonic distortion measurement

The "Harmonic Distortion" measurement measures harmonics and their distortion, including the total harmonic distortion.



Harmonic distortion measurement is not available if an external frontend is active.

- [About the measurement](#).....314
- [Harmonic distortion basics](#).....314
- [Harmonic distortion results](#).....316
- [Harmonic distortion configuration](#).....317
- [How to determine the harmonic distortion](#).....319

### 6.10.1 About the measurement

With this measurement it is possible to measure the harmonics easily, for example from a VCO. In addition, the total harmonic distortion (THD) is calculated.

For measurements in the frequency domain, the Harmonic Distortion measurement starts with an automatic search for the first harmonic (= peak) within the set frequency range. The center frequency is set to this frequency and the reference level is adjusted accordingly.

For measurements in zero span, the center frequency remains unchanged.

The Harmonic Distortion measurement then performs zero span sweeps at the center frequency and at each harmonic, i.e. at frequencies that are a multiple of the center frequency.

As a result, the zero span sweeps on all harmonics are shown, as well as the RMS values and the total harmonic distortion (THD).



An application note discussing harmonics measurement is available from the Rohde & Schwarz website:

[1EF78: Measurement of Harmonics using Spectrum Analyzers](#)

### 6.10.2 Harmonic distortion basics

Measuring the harmonics of a signal is a frequent problem which can be solved best using a signal analyzer. In general, every signal contains harmonics. Harmonics are generated by nonlinear characteristics, which add frequencies to a pure sinewave. They can often be reduced by low pass filters. Since the signal analyzer itself has a nonlinear characteristic, for example in its first mixer, measures must be taken to ensure that harmonics produced in the signal analyzer do not cause spurious results. If necessary, the fundamental wave must be attenuated selectively with respect to the other harmonics with a high pass filter. Harmonics are particularly critical regarding high-power transmitters such as transceivers because large harmonics can interfere with other radio services.

Harmonic distortion can be determined as the level of the individual components, or as the root mean square of all components together, the total harmonic distortion (THD). The THD is set in relation to the power of the fundamental frequency (= center frequency).

#### Obtainable dynamic range

When harmonics are being measured, the obtainable dynamic range depends on the second harmonic intercept of the signal analyzer. The second harmonic intercept is the virtual input level at the RF input mixer at which the level of the 2nd harmonic becomes equal to the level of the fundamental wave. In practice, however, applying a level of this magnitude would damage the mixer. Nevertheless the available dynamic range for measuring the harmonic distance of a DUT can be calculated relatively easily using the second harmonic intercept.

As shown in Figure 6-54, the level of the 2<sup>nd</sup> harmonic drops by 20 dB if the level of the fundamental wave is reduced by 10 dB.

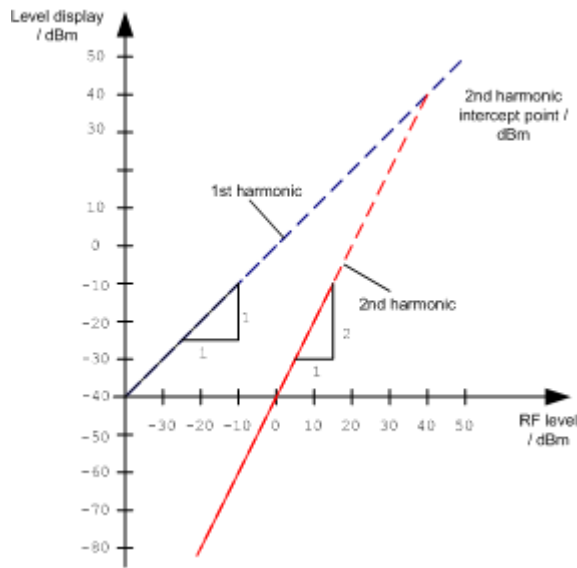

Figure 6-54: Extrapolation of the 1st and 2nd harmonics to the 2nd harmonic intercept at 40 dBm

The following formula for the obtainable harmonic distortion  $d_2$  in dB is derived from the straight-line equations and the given intercept point:

$$d_2 = \text{S.H.I} - P_1 (1)$$

where:

$d_2$	=	harmonic distortion
S.H.I.	=	second harmonic intercept
$P_1$	=	mixer level/dBm



The mixer level is the RF level applied to the RF input minus the set RF attenuation.

The formula for the internally generated level  $P_1$  at the 2<sup>nd</sup> harmonic in dBm is:

$$P_1 = 2 * P_1 - \text{S.H.I.} (2)$$

The lower measurement limit for the harmonic is the noise floor of the signal analyzer. The harmonic of the measured DUT should – if sufficiently averaged by means of a video filter – be at least 4 dB above the noise floor so that the measurement error due to the input noise is less than 1 dB.

**Rules for measuring high harmonic ratios**

The following rules for measuring high harmonic ratios can be derived:

- Select the smallest possible IF bandwidth for a minimal noise floor.

- Select an RF attenuation which is high enough to measure the harmonic ratio only.

The maximum harmonic distortion is obtained if the level of the harmonic equals the intrinsic noise level of the receiver. The level applied to the mixer, according to (2), is:

$$P_1 = \frac{P_{noise} / dBm + IP2}{2}$$

At a resolution bandwidth of 10 Hz (noise level -143 dBm, S.H.I. = 40 dBm), the optimum mixer level is – 51.5 dBm. According to (1) a maximum measurable harmonic distortion of 91.5 dB minus a minimum S/N ratio of 4 dB is obtained.



#### Detecting the origin of harmonics

If the harmonic emerges from noise sufficiently (approx. >15 dB), it is easy to check (by changing the RF attenuation) whether the harmonics originate from the DUT or are generated internally by the signal analyzer. If a harmonic originates from the DUT, its level remains constant if the RF attenuation is increased by 10 dB. Only the displayed noise is increased by 10 dB due to the additional attenuation. If the harmonic is exclusively generated by the signal analyzer, the level of the harmonic is reduced by 20 dB or is lost in noise. If both – the DUT and the signal analyzer – contribute to the harmonic, the reduction in the harmonic level is correspondingly smaller.

#### High-sensitivity harmonics measurements

If harmonics have very small levels, the resolution bandwidth required to measure them must be reduced considerably. The sweep time is, therefore, also increased considerably. In this case, the measurement of individual harmonics is carried out with the FSW set to a small span. Only the frequency range around the harmonics will then be measured with a small resolution bandwidth.

#### Required measurement time

During the harmonics measurement, zero span sweeps are performed at the center frequency and at each harmonic. The duration of each sweep ("Harmonic Sweep Time", **SWT**) and the "Number of Harmonics" (n) are defined in the "Harmonic Distortion" configuration dialog box. Thus, the required measurement time for the harmonic distortion measurement (*Cumulated Measurement Time*, **CMT**) is:

$$CMT = n * SWT$$

The required measurement time is indicated as "CMT" in the channel bar.

### 6.10.3 Harmonic distortion results

As a result of the harmonics distortion measurement, the zero span sweeps of all detected harmonics are shown in the diagram, separated by red display lines. This provides a very good overview of the measurement.

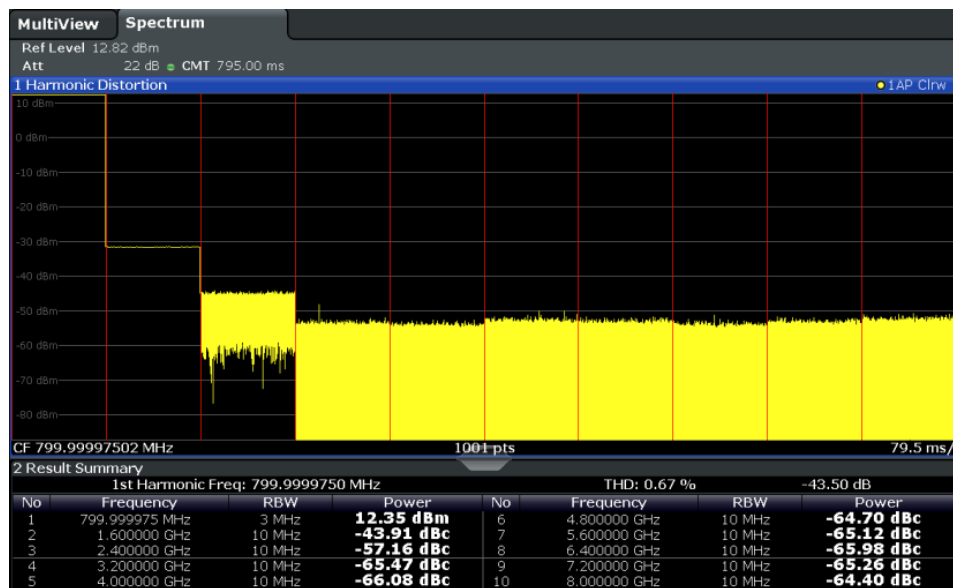

In addition, a result table is displayed providing the following information:

- First harmonic frequency
- THD (total harmonic distortion), relative and absolute values
- For each detected harmonic:
  - Frequency
  - RBW
  - Power

#### Remote commands

The results can also be queried using remote commands.

The first harmonic frequency can be read out via the general center frequency command `[SENSE:]FREQUENCY:CENTer` on page 1192.

THD: `CALCulate<n>:MARKer<m>:FUNCTION:HARMonics:DISTortion?`  
on page 1073

List of harmonics: `CALCulate<n>:MARKer<m>:FUNCTION:HARMonics:LIST`  
on page 1074

### 6.10.4 Harmonic distortion configuration

**Access:** "Overview" > "Select Measurement" > "Harmonic Distortion" > "Harmonic Distortion Config"

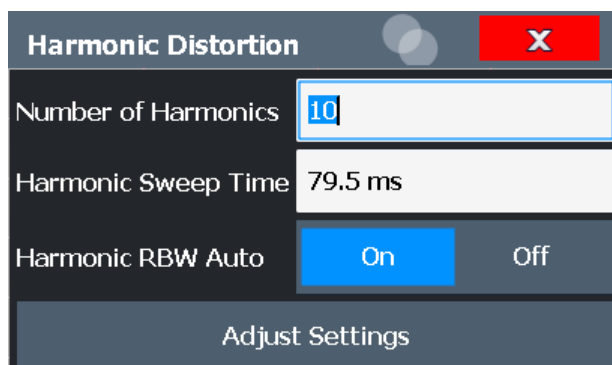

The remote commands required to perform these tasks are described in [Chapter 13.5.11, "Measuring the harmonic distortion"](#), on page 1071.

<a href="#">Number of Harmonics</a> .....	318
<a href="#">Harmonic Sweep Time</a> .....	318
<a href="#">Harmonic RBW Auto</a> .....	318
<a href="#">Adjust Settings</a> .....	318

### Number of Harmonics

Defines the number of harmonics to be measured. The range is from 1 to 26. Default is 10.

Remote command:

`CALCulate<n>:MARKer<m>:FUNction:HARMonics:NHARmonics` on page 1072

### Harmonic Sweep Time

Defines the sweep time for the zero span measurement on each harmonic frequency. This setting is identical to the normal sweep time for zero span, see also "[Sweep Time](#)" on page 502.

Remote command:

`[SENSe:] SWEep:TIME:AUTO` on page 1205

### Harmonic RBW Auto

Enables/disables the automatic adjustment of the resolution bandwidth for Normal (3dB) (Gaussian) and 5-Pole filter types.

The automatic adjustment is carried out according to:

$$"RBW_n = RBW_1 * n"$$

If  $RBW_n$  is not available, the next higher value is used.

Remote command:

`CALCulate<n>:MARKer<m>:FUNction:HARMonics:BANDwidth:AUTO`  
on page 1072

### Adjust Settings

If harmonic measurement was performed in the frequency domain, a new peak search is started in the frequency range that was set before starting the harmonic measurement. The center frequency is set to this frequency and the reference level is adjusted accordingly.

If harmonic measurement was performed in the time domain, this function adjusts the reference level only.

Remote command:

`CALCulate<n>:MARKer<m>:FUNction:HARMonics:PRESet` on page 1073

### 6.10.5 How to determine the harmonic distortion



In [Chapter 8.3.6, "Measurement example: measuring harmonics using marker functions"](#), on page 589, measuring harmonics was described using marker functions. This task can be performed much simpler using the Harmonic Distortion measurement, as described in the following procedure.

For remote operation, see [Chapter 13.5.11.5, "Example: measuring the harmonic distortion"](#), on page 1074.

1. Select the "Harmonic Distortion" measurement function from the "Select Measurement" dialog box.
2. Define the number of harmonics to be determined using "Number of Harmonics".
3. Perform a sweep.

The trace for the determined harmonics are displayed in the diagram, separated by red display lines. The measured power for each harmonic in relation to the fundamental is indicated in the result table.

4. If the signal changes significantly during or after the harmonics measurement, use the "Adjust Settings" function to adjust the settings automatically and restart the measurement.

## 6.11 Third order intercept (TOI) measurement

The third order intercept point of the FSW can be determined if a two-tone signal with equal carrier levels is applied to the input.

`CALCulate<n>:MARKer<m>:FUNction:TOI:RESult?` on page 1076

- [About the TOI measurement](#)..... 320
- [TOI basics](#)..... 320
- [TOI results](#)..... 324
- [TOI configuration](#)..... 325
- [How to determine the third order intercept](#)..... 326
- [Measurement example – measuring the FSW's intrinsic intermodulation](#)..... 327

### 6.11.1 About the TOI measurement

If several signals are applied to a two-port transmission device with nonlinear characteristic, intermodulation products appear at its output at the sums and differences of the signals. The nonlinear characteristic produces harmonics of the useful signals, which intermodulate at the characteristic. The intermodulation products of lower order have a special effect, since their level is largest and they are near the useful signals. The intermodulation product of third order causes the highest interference. It is the intermodulation product generated from one of the useful signals and the 2nd harmonic of the second useful signal for two-tone modulation.

To measure the third order intercept point (TOI), a two-tone signal with equal carrier levels is expected at the FSW input. Marker 1 and marker 2 (both normal markers) are set to the maximum of the two signals. Marker 3 and marker 4 are placed on the intermodulation products.

The FSW calculates the third order intercept point from the level difference between the first 2 markers and the markers 3 and 4, and displays it in the marker table.

### 6.11.2 TOI basics

If several signals are applied to a two-port transmission device with nonlinear characteristic, intermodulation products appear at its output at the sums and differences of the signals. The nonlinear characteristic produces harmonics of the useful signals, which intermodulate at the characteristic.

The frequencies of the intermodulation products are above and below the useful signals. [Figure 6-55](#) shows intermodulation products  $P_{S1}$  and  $P_{S2}$ , generated by the two useful signals  $P_{U1}$  and  $P_{U2}$ .



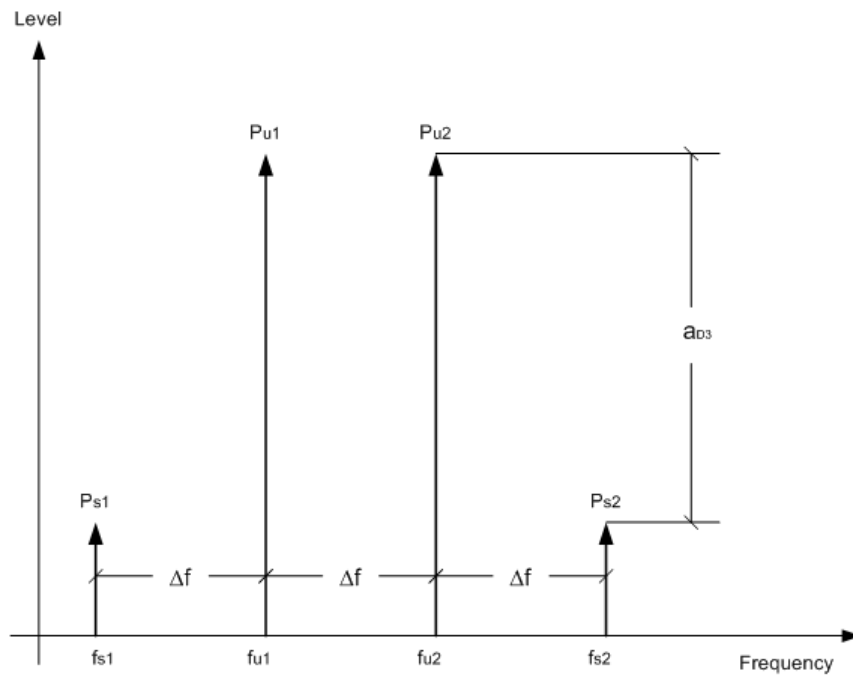

**Figure 6-55: Intermodulation products  $P_{s1}$  and  $P_{s2}$**

The intermodulation product at  $f_{i2}$  is generated by mixing the 2nd harmonic of useful signal  $P_{u2}$  and useful signal  $P_{u1}$ .

The intermodulation product at  $f_{i1}$  is generated by mixing the 2nd harmonic of useful signal  $P_{u1}$  and useful signal  $P_{u2}$ .

$$f_{i1} = 2 \times f_{u1} - f_{u2} \quad (1)$$

$$f_{i2} = 2 \times f_{u2} - f_{u1} \quad (2)$$

#### Dependency on level of useful signals

The level of the intermodulation products depends on the level of the useful signals. If the two useful signals are increased by 1 dB, the level of the intermodulation products increases by 3 dB. Thus, the spacing  $a_{D3}$  between intermodulation signals and useful signals is reduced by 2 dB, as shown in [Figure 6-56](#).

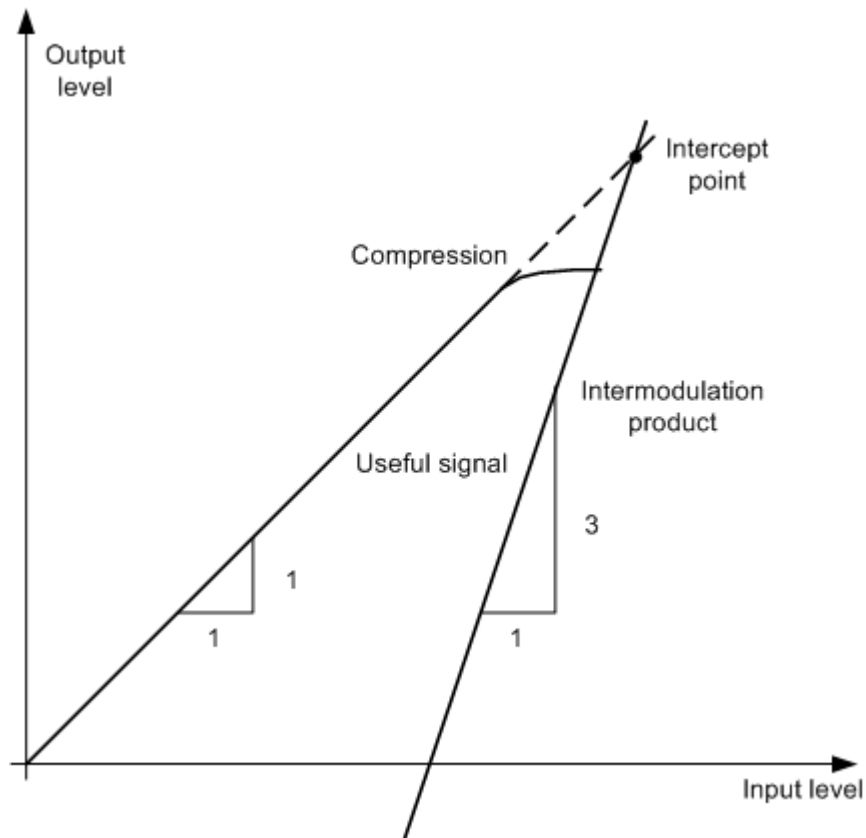

Figure 6-56: Dependency of intermodulation products on level of useful signals

The useful signals at the two-port output increase proportionally with the input level as long as the two-port is in the linear range. A level change of 1 dB at the input causes a level change of 1 dB at the output. Beyond a certain input level, the two-port goes into compression and the output level stops increasing. The intermodulation products of the third order increase three times as quickly as the useful signals. The intercept point is the fictitious level where the two lines intersect. It cannot be measured directly, since the useful level is limited by the maximum two-port output power.

#### Calculation method

However, the intercept point can be calculated from the known line slopes and the measured spacing  $a_{D3}$  between intermodulation signals and useful signals at a given level  $P_u$  according to the following formula:

$$IP3 = \frac{a_{D3}}{2} + P_u$$

#### Example:

Assume that the measured spacing between intermodulation and useful signal is 60 dB at the input level  $P_u = -20$  dBm. Then the third order intercept point (TOI) is calculated according to the following formula:

$$IP3 = \frac{60}{2} + (-20dBm) = 10dBm$$

### Intermodulation-free dynamic range

The "Intermodulation-free dynamic range" is the level range in which no internal intermodulation products are generated if two-tone signals are measured. It is determined by the third order intercept point, the phase noise and the thermal noise of the signal analyzer. At high signal levels, the range is determined by intermodulation products. At low signal levels, intermodulation products disappear below the noise floor, i.e. the noise floor and the phase noise of the signal analyzer determine the range. The noise floor and the phase noise depend on the resolution bandwidth that has been selected. At the smallest resolution bandwidth, the noise floor and phase noise are at a minimum and so the maximum range is obtained. However, a large increase in sweep time is required for small resolution bandwidths. It is therefore best to select the largest resolution bandwidth possible to obtain the range that is required. Since phase noise decreases as the carrier-offset increases, its influence decreases with increasing frequency offset from the useful signals.

The following diagrams illustrate the intermodulation-free dynamic range as a function of the selected bandwidth and of the level at the input mixer (= signal level – set RF attenuation) at different useful signal offsets.



For typical values for your instrument, see the specifications document.

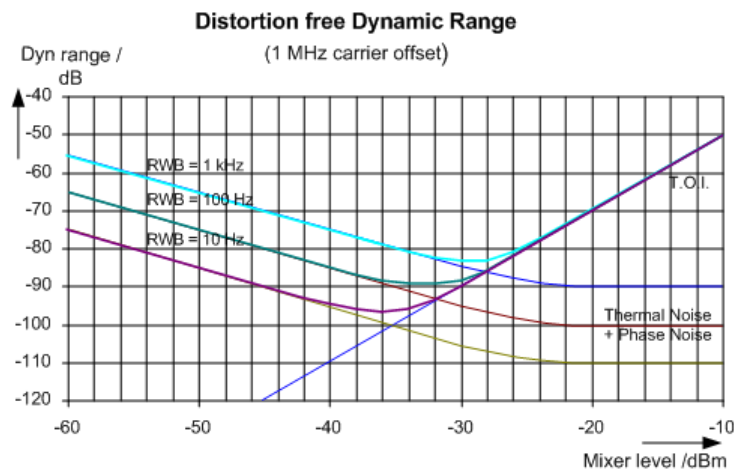

**Figure 6-57: Intermodulation-free range as a function of level at the input mixer and the set resolution bandwidth**

Sample values at 2 GHz:

- Useful signal offset = 1 MHz
- DANL = -145 dBm/Hz
- TOI = 15 dBm

The optimum mixer level, i.e. the level at which the intermodulation distance is at its maximum, depends on the bandwidth. At a resolution bandwidth of 10 Hz, it is approx. -35 dBm. At 1 kHz, it increases to approx. -30 dBm.

Phase noise has a considerable influence on the intermodulation-free range at carrier offsets between 10 kHz and 100 kHz ( see [Figure 6-58](#)). At greater bandwidths, the influence of the phase noise is greater than it would be with small bandwidths. The optimum mixer level at the bandwidths under consideration becomes almost independent of bandwidth and is approx. -40 dBm.

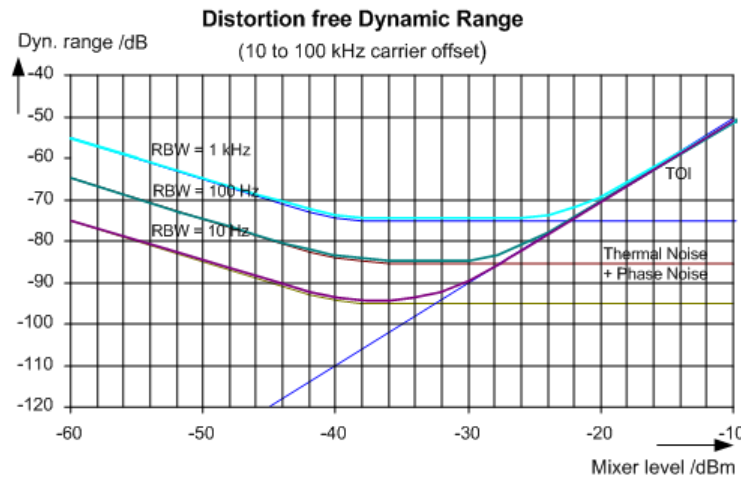

**Figure 6-58:** Intermodulation-free dynamic range as a function of level at the input mixer and of the selected resolution bandwidth

Sample values at 2 GHz:

- Useful signal offset = 10 kHz to 100 kHz
- DANL = -145 dBm/Hz
- TOI = 15 dBm



When you measure the intermodulation products of a DUT with a very high dynamic range, the used resolution bandwidth is usually very small. In this case, it is best to measure the levels of the useful signals and those of the intermodulation products separately, using a small span. The measurement time is reduced, in particular if the offset of the useful signals is large. To find signals reliably when the frequency span is small, it is best to synchronize the signal sources and the FSW.

### 6.11.3 TOI results

As a result of the TOI measurement, the following values are displayed in the marker area of the diagram:

## Third order intercept (TOI) measurement

Label	Description
TOI	Third-order intercept point for averaged levels (see also <a href="#">Chapter 6.11.3, "TOI results"</a> , on page 324 and <a href="#">Figure 6-55</a> ): $P_{U-AVG} + (P_{U-AVG} - P_{S-AVG})/2$
TOI (max)	$P_{U-MAX} + (P_{U-MAX} - P_{S-MIN})/2$
TOI (min)	$P_{U-MIN} + (P_{U-MIN} - P_{S-MAX})/2$
M1	Maximum of first useful signal
M2	Maximum of second useful signal
M3	First intermodulation product
M4	Second intermodulation product

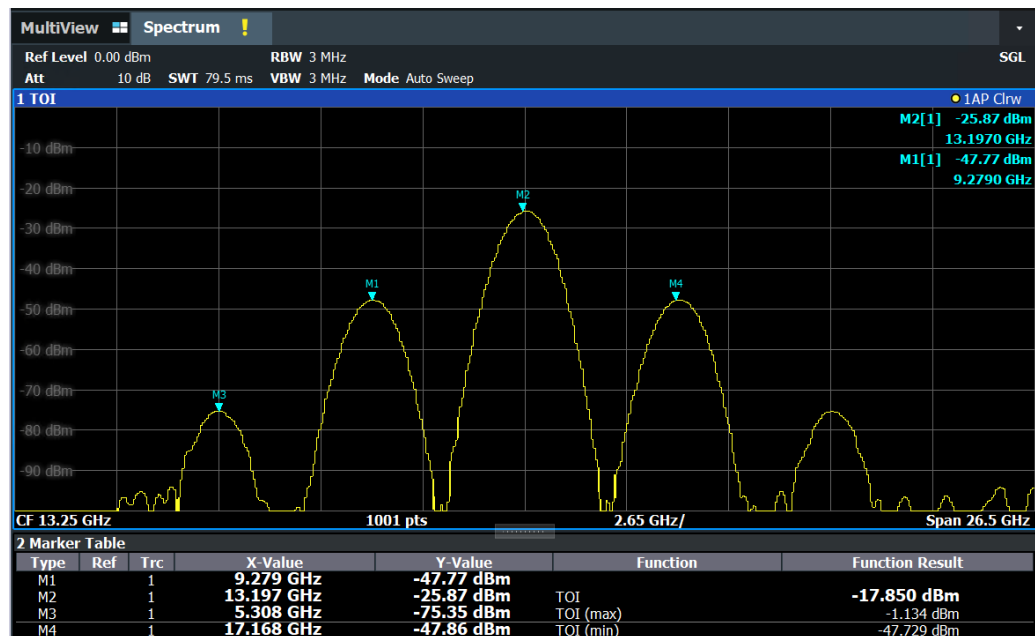

## Remote command

The TOI can also be queried using the remote commands:

[CALCulate<n>:MARKer<m>:FUNCTION:TOI:RESult?](#) on page 1076.

[CALCulate<n>:MARKer<m>:FUNCTION:TOI:RESult:MAXimum?](#) on page 1076

[CALCulate<n>:MARKer<m>:FUNCTION:TOI:RESult:MINimum?](#) on page 1077

## 6.11.4 TOI configuration

Access: "Overview" > "Select Measurement" > "Third Order Intercept" > "TOI Config"

Third Order Intercept	
Marker 1	2.634 GHz
Marker 2	5.281 GHz
Marker 3	2.634 GHz
Marker 4	7.929 GHz
Search Signals	

The remote commands required to perform these tasks are described in [Chapter 13.5.12, "Measuring the third order intercept point"](#), on page 1075.

<a href="#">Marker 1/Marker 2/Marker 3/Marker 4</a> .....	326
<a href="#">Search Signals</a> .....	326

#### Marker 1/Marker 2/Marker 3/Marker 4

Indicates the detected characteristic values as determined by the TOI measurement (see [Chapter 6.11.3, "TOI results"](#), on page 324).

The marker positions can be edited; the TOI is then recalculated according to the new marker values.

To reset all marker positions automatically, use the [Search Signals](#) function.

Remote command:

[CALCulate<n>:MARKer<m>:X](#) on page 1275

[CALCulate<n>:DELTaMarker<m>:X](#) on page 1272

[CALCulate<n>:DELTaMarker<m>:X:RELative?](#) on page 1288

#### Search Signals

Performs a new search on the input signals and recalculates the TOI according to the measured values.

Remote command:

[CALCulate<n>:MARKer<m>:FUNCTION:TOI:SEARChsignal ONCE](#) on page 1076

### 6.11.5 How to determine the third order intercept



The precise TOI for the FSW in relation to the input signals is provided in the specifications document.

For remote operation, see [Chapter 13.5.12.2, "Programming example: measuring the TOI"](#), on page 1078.

1. Apply a two-tone signal with equal carrier levels to the FSW input.
2. On the FSW, press [MEAS].

3. Select the "Third Order Intercept" measurement function from the "Select Measurement" dialog box.

The calculated TOI is indicated in the marker information. The markers required for calculation are displayed in the marker table.

4. If the signal changes significantly during or after the TOI measurement, use the "Search Signals" function to start a new signal search automatically and restart the calculation of the TOI.

### 6.11.6 Measurement example – measuring the FSW's intrinsic intermodulation



A programming example demonstrating a TOI measurement in a remote environment is provided in [Chapter 13.5.12.2, "Programming example: measuring the TOI"](#), on page 1078.

#### Test setup:

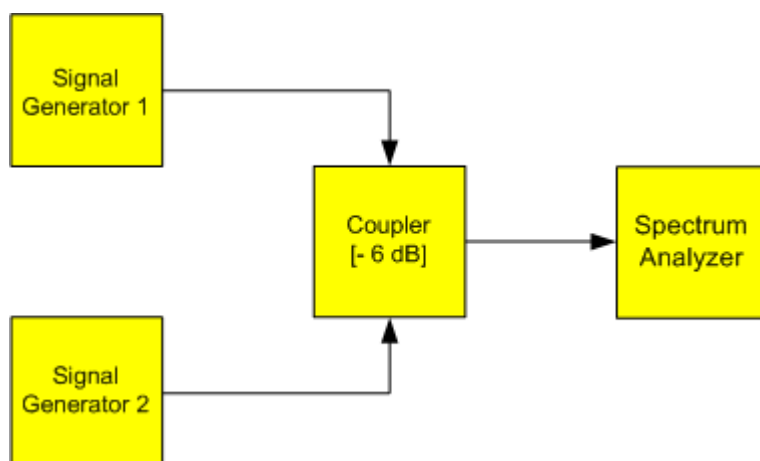

#### Signal generator settings (e.g. R&S SMW):

Device	Level	Frequency
Signal generator 1	-4 dBm	799.6 MHz
Signal generator 2	-4 dBm	800.4 MHz

#### Setting up the measurement

1. Preset the FSW.
2. Set the center frequency to *800 MHz* and the frequency span to *3 MHz*.
3. Set the reference level to *-10 dBm* and RF attenuation to *0 dB*.
4. Set the resolution bandwidth to *10 kHz*.

## Third order intercept (TOI) measurement

The noise is reduced, the trace is smoothed further and the intermodulation products can be seen clearly.

- Set the VBW to 1 kHz.

### Measuring intermodulation using the Third Order Intercept (TOI) measurement function

- Select [MEAS] > "Third Order Intercept".

The FSW activates four markers to measure the intermodulation distance. Two markers are positioned on the useful signals and two on the intermodulation products. The TOI is calculated from the level difference between the useful signals and the intermodulation products. It is then displayed on the screen:

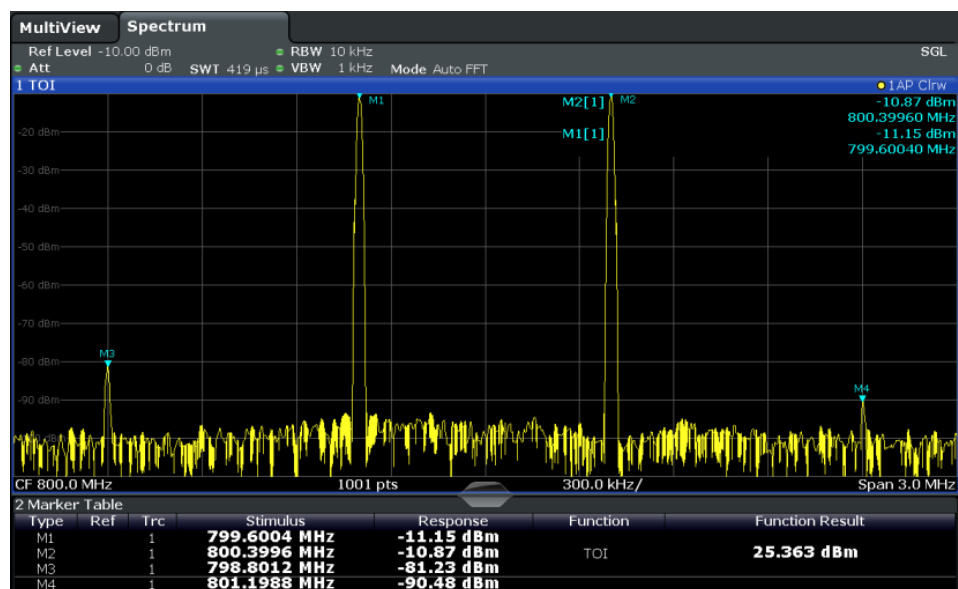

The third order intercept (TOI) is displayed in the marker information.

- The level of a signal analyzer's intrinsic intermodulation products depends on the RF level of the useful signals at the input mixer. When the RF attenuation is added, the mixer level is reduced and the intermodulation distance is increased. With an additional RF attenuation of 10 dB, the levels of the intermodulation products are reduced by 20 dB. The noise level is, however, increased by 10 dB. Increase the RF attenuation to 20 dB to reduce intermodulation products. The FSW's intrinsic intermodulation products disappear below the noise floor.



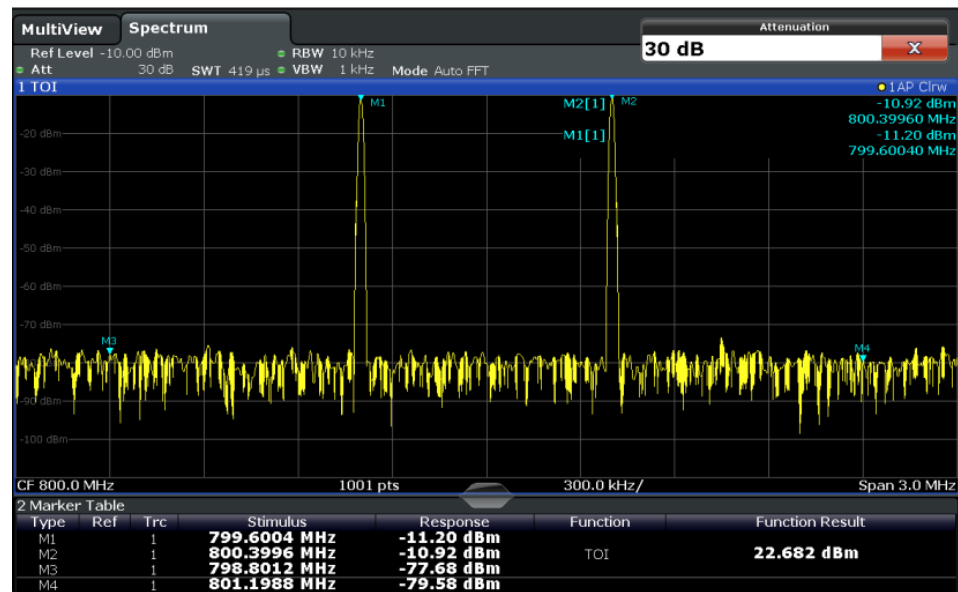

## 6.12 AM modulation depth measurement

This measurement determines the AM modulation depth of an AM-modulated carrier.

- [About the measurement](#).....329
- [AM modulation depth results](#).....330
- [AM modulation depth configuration](#).....330
- [Optimizing and troubleshooting the measurement](#).....331
- [How to determine the AM modulation depth](#).....332

### 6.12.1 About the measurement

The AM modulation depth, also known as a modulation index, indicates how much the modulated signal varies around the carrier amplitude. It is defined as:

$$M_{\text{Depth}} = \text{peak signal amplitude} / \text{unmodulated carrier amplitude}$$

So for  $M_{\text{Depth}} = 0.5$ , for example, the carrier amplitude varies by 50% above and below its unmodulated level, and for  $M_{\text{Depth}} = 1.0$  it varies by 100%.

When this measurement is activated, marker 1 is set to the peak level, which is considered to be the carrier level. Delta markers 2 and 3 are automatically set symmetrically to the carrier on the adjacent peak values of the trace. The markers can be adjusted manually, if necessary.

The FSW calculates the power at the marker positions from the measured levels. The AM modulation depth is calculated as the ratio between the power values at the reference marker and at the delta markers. If the powers of the two AM side bands are unequal, the mean value of the two power values is used for AM modulation depth calculation.

### 6.12.2 AM modulation depth results

As a result of the AM Modulation Depth measurement, the following values are displayed in the marker area of the diagram:

Label	Description
MDepth	AM modulation depth in percent
M1	Maximum of the signal (= carrier level)
D2	Offset of next peak to the right of the carrier
D3	Offset of the next peak to the left of the carrier

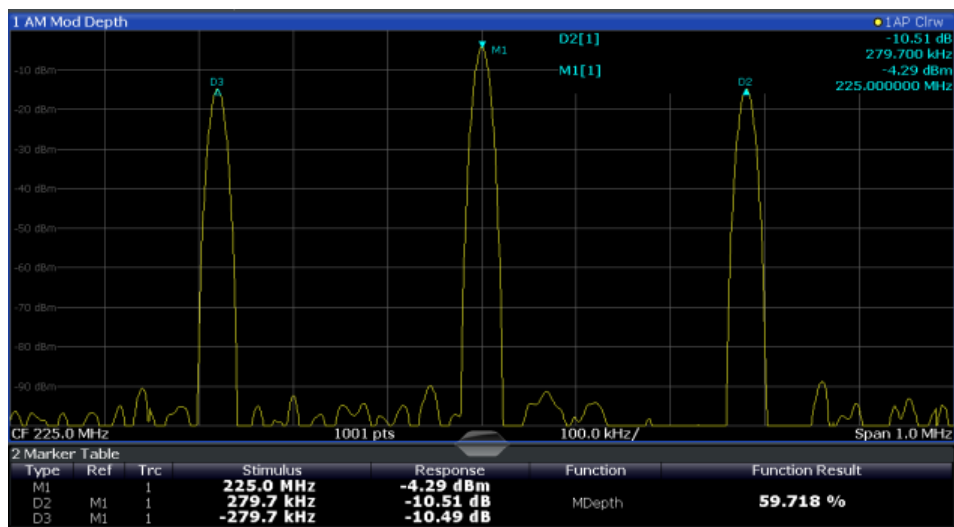

Remote command:

The AM modulation depth can also be queried using the remote command `CALCulate<n>:MARKer<m>:FUNCTION:MDEPth:RESult<t>?` on page 1079.

### 6.12.3 AM modulation depth configuration

Access: "Overview" > "Select Measurement" > "AM Modulation Depth" > "AM Mod Depth Config"

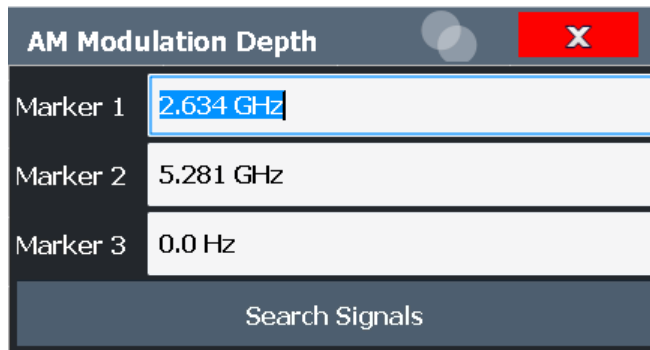

The remote commands required to perform these tasks are described in [Chapter 13.5.13, "Measuring the AM modulation depth"](#), on page 1078.

<a href="#">Marker 1/Marker 2/Marker 3</a> .....	331
<a href="#">Search Signals</a> .....	331

### Marker 1/Marker 2/Marker 3

Indicates the detected characteristic values as determined by the AM Modulation Depth measurement:

Marker	Description
M1	Maximum of the signal (= carrier level)
D2	Offset of next peak to the right of the carrier
D3	Offset of the next peak to the left of the carrier

The marker positions can be edited; the modulation depth is then recalculated according to the new marker values.

To reset all marker positions automatically, use the [Search Signals](#) function.

**Note:** Moving the marker positions manually. When the position of delta marker 2 is changed, delta marker 3 is moved symmetrically with respect to the reference marker 1.

Delta marker 3, on the other hand, can be moved for fine adjustment independently of marker 2.

Marker 1 can also be moved manually for re-adjustment without affecting the position of the delta markers.

Remote command:

[CALCulate<n>:MARKer<m>:X](#) on page 1275

[CALCulate<n>:DELTAmarker<m>:X](#) on page 1272

[CALCulate<n>:DELTAmarker<m>:X:RELative?](#) on page 1288

### Search Signals

Performs a new search on the input signal and recalculates the AM Modulation Depth according to the measured values.

Remote command:

[CALCulate<n>:MARKer<m>:FUNCTION:MDEPth:SEARChsignal ONCE](#)

on page 1079

## 6.12.4 Optimizing and troubleshooting the measurement

If the results do not meet your expectations, try the following methods to optimize the measurement:

- Set the center frequency to the frequency of the device under test.
- Adjust the span so the peaks to the left and right of the carrier, produced by the AM modulated signal, are clearly visible.  
If the span is too wide, these signals may fall together with the carrier and the measurement can not be performed.

If the span is too narrow, these signals are outside of the measured span and the delta markers can not find these peaks.

The rule of thumb is to set the span to three times the value of the AM modulation frequency.

### 6.12.5 How to determine the AM modulation depth

The following step-by-step instructions demonstrate how to determine the AM modulation depth.



For remote operation, see [Chapter 13.5.13.2, "Example: measuring the AM modulation depth"](#), on page 1079.

1. Apply a modulated carrier signal to the FSW input.
2. On the FSW, press [MEAS].
3. Select the "AM Modulation Depth" measurement function from the "Select Measurement" dialog box.  
The calculated AM Modulation Depth is indicated in the marker information. The markers required for calculation are displayed in the marker table.
4. If the signal changes significantly during or after the AM Modulation Depth measurement, use the "Search Signals" function to start a new peak search automatically and restart the calculation of the AM Modulation Depth.

## 6.13 Electromagnetic interference (EMI) measurement

The electromagnetic interference (EMI) measurement is suitable for measurements according to commercial and military electromagnetic compatibility (EMC) standards. The functionality of the measurement is particularly useful in research and development.

The EMI measurement requires the R&S FSW-K54 option.

The EMI measurement features:

- EMI marker functionality
- Marker demodulation
- Measurement bandwidths and detectors for EMI measurements
- Logarithmic scaling of the frequency axis
- Additional predefined limit lines for EMC standards
- Predefined transducer factors
- Additional amplitude units, normalized to 1 MHz
- LISN control

• <a href="#">About the EMI measurement</a> .....	333
• <a href="#">EMI measurement results</a> .....	333
• <a href="#">EMI measurement basics</a> .....	335
• <a href="#">EMI measurement configuration</a> .....	341
• <a href="#">EMI result analysis</a> .....	351
• <a href="#">How to perform EMI measurements</a> .....	351
• <a href="#">Measurement example: measuring radio frequency interference</a> .....	353
• <a href="#">Optimizing and troubleshooting EMI measurements</a> .....	356

### 6.13.1 About the EMI measurement

EMI measurements can be very time-consuming, especially if weighting detectors are required for the measurement. In addition, EMC testing often requires various procedures to locate local EMI maxima. Such procedures are, for example, movements of an absorbing clamp, variations in the height of the test antenna or the rotation of the DUT.

Covering all test setups with one of the (slow) EMI weighting detectors over the required frequency range can lead to very long measurement times.

Splitting the measurement procedure into several stages, however, can eliminate this problem.

The first stage is a peak search, used to get a rough idea about the location of peak levels that can indicate interference over the required frequency range. This stage uses a detector that allows for a fast sweep time, e.g. the peak detector.

During the second stage, or final test, the FSW performs the actual EMC test, a refined measurement with detectors designed for and required by EMC standards. To keep measurement times brief, the FSW performs a final measurement only on frequencies you have marked with a marker or delta marker. You can assign a different detector to every marker and thus test a particular frequency easily for compliance.

Optionally, you can activate continuous demodulation of the signal during the initial measurement and at the peak marker positions during the final test.

After the final measurement, you can check the signal levels against specified limits.

### 6.13.2 EMI measurement results

As the result of an EMI measurement, the measured signal levels and active markers are displayed in a Spectrum diagram.

## Electromagnetic interference (EMI) measurement

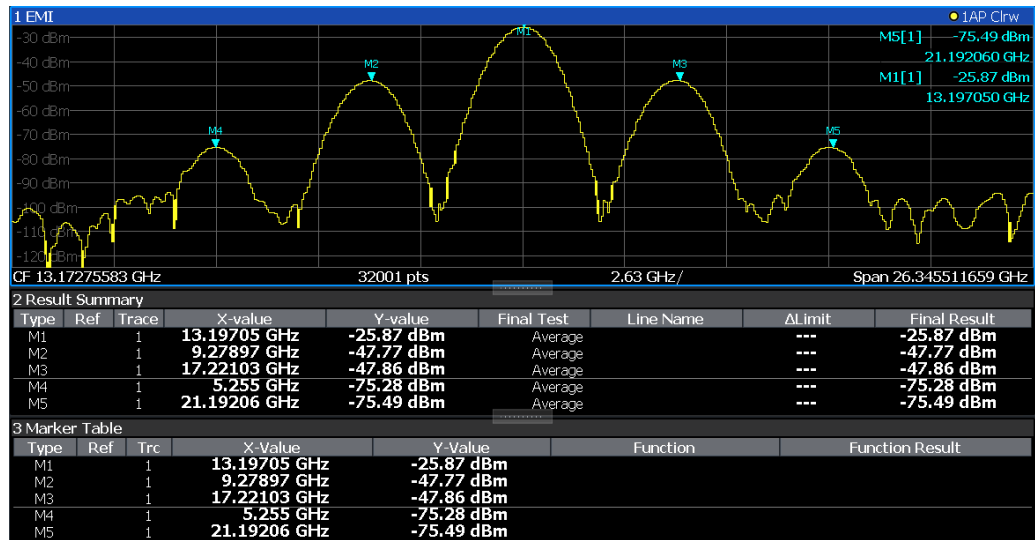

Figure 6-59: EMI measurement results

## Initial peak search results - Marker Table

As a result of the initial peak search, the active markers are set to the positive peaks of the measured signal.

If **auto peak search** and **limit lines** are active, the active markers are set to the peak *delta* values between the measured signal and the limit lines.

The active marker levels and positions are displayed in the **Marker Table**.



The marker results are also displayed in the Result Summary; in addition, the Marker Table contains the marker results for those markers for which no final EMI test is performed.

## Final test results - Result Summary

The results of the final EMI tests at the active marker frequencies are displayed in the **Result Summary**.

The Result Summary provides the following information:

Label	Description
Type	Marker name
Ref	Reference marker for delta markers
Trace	Assigned trace
X-value	Marker x-value (frequency for final test)
Y-value	Marker y-value (level during initial measurement)
Final Test	Detector used for final EMI test
Line name	Line activated for limit check

Label	Description
$\Delta$ Limit	Delta between measured level and limit line (if active) The value is colored to indicate the following states: <ul style="list-style-type: none"> <li>• <b>green</b>: does not exceed limit</li> <li>• <b>yellow</b>: within margin</li> <li>• <b>red</b>: exceeds limit</li> </ul>
Final Result	Value measured during final EMI test using specified detector at marker frequency

### 6.13.3 EMI measurement basics

Some background knowledge on basic terms and principles used in EMI measurements is provided here for a better understanding of the required configuration settings.

- [Resolution bandwidth and filter types](#)..... 335
- [Detectors and dwell time](#)..... 336
- [Frequency resolution - sweep points and scaling](#)..... 337
- [Controlling V-Networks \(LISN\)](#)..... 338
- [Using transducer factors](#)..... 338
- [Initial measurement - peak search](#)..... 339
- [Final measurement at the marker position](#)..... 340
- [Limit checks](#)..... 340

#### 6.13.3.1 Resolution bandwidth and filter types

EMI testing requires resolution filters with a 6 dB bandwidth. The EMI measurement adds the following bandwidths, which comply to commercial and military standards, to those already available with the base unit:

Commercial (CISPR, FFC etc.)

- 200 Hz
- 9 kHz
- 120 kHz
- 1 MHz (not with quasi-peak detector, see "[Quasi-peak detector \(CISPR filter only\)](#)" on page 336)

Military (MIL Std)

- 10 Hz
- 100 Hz
- 1 kHz
- 10 kHz
- 100 kHz
- 1 MHz

If you select a CISPR or MIL filter type, the corresponding RBW that is closest to the currently selected RBW value is used. In this case, the channel bar indicates "RBW (CISPR)".

For the quasi-peak, CISPR Average, or RMS Average detector, the bandwidth is fixed depending on the frequency. For more information, see [Chapter 6.13.3.2, "Detectors and dwell time"](#), on page 336.

### 6.13.3.2 Detectors and dwell time

The EMI measurement adds new detectors to those already available with the base unit. The additional detectors are especially designed for and required by EMI applications.

The additional detectors are available only if the EMI (R&S FSW-K54) measurement option is installed. However, the EMI measurement need not be active.

See:

- ["Quasipeak detector"](#) on page 614
- ["CISPR average detector"](#) on page 615
- ["RMS average detector"](#) on page 616

The detector to be used for the initial peak search is configured in the trace settings (see [Chapter 8.5.1.2, "Trace settings"](#), on page 622). The detector for the final test is configured in the EMI marker settings, see [Chapter 6.13.4.1, "EMI marker configuration"](#), on page 341.

#### Dwell time

EMC tests often require a specific *dwell time* for an EMI measurement. The dwell time defines how long the FSW measures the signal at the individual frequencies. Each detector needs a different period of time to fully charge and discharge. For details on defining the dwell time for an EMI measurement, see ["Defining a dwell time for the final measurement"](#) on page 340.

#### RMS detector

The RMS detector displays the root mean square (RMS) value over the specified dwell time. The integration time is the specified dwell time.

See ["RMS detector"](#) on page 612

#### Sample detector

The sample detector displays the last value from the samples allocated to a pixel.

The sample detector is used for noise or phase noise marker calculation. However, it is unreliable if the displayed span is much greater than the resolution bandwidth or if the tuning steps of the local oscillator are too large. The sample detector is not recommended for EMI tests.

See ["Sample detector"](#) on page 614

#### Quasi-peak detector (CISPR filter only)

See ["Quasipeak detector"](#) on page 614



**CISPR Average detector (CISPR filter only)**

See ["CISPR average detector"](#) on page 615

**RMS Average detector (CISPR filter only)**

See ["RMS average detector"](#) on page 616

**6.13.3.3 Frequency resolution - sweep points and scaling**

The number of sweep points defines the number of measurement values collected during one sweep. Thus, increasing the sweep points also increases the accuracy of the results regarding the frequency resolution.

Because EMI measurements often cover a large frequency range, be sure to define an adequate number of sweep points, especially when performing the measurement on a logarithmic axis. As on a linear axis, the distance from one sweep point to the next is calculated graphically on a logarithmic axis, and is not based on the frequency itself. Thus, the frequency resolution between two sweep points deteriorates with higher frequencies.

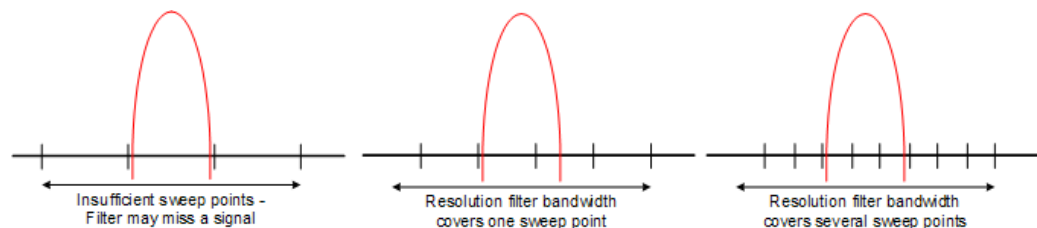

The resolution bandwidth should cover at least one sweep point (more is better). If this condition is not met, signals or interferences can be missed during refined measurement of narrowband interferers. If the distance between two sweep points is larger than  $RBW/2$ , a warning is displayed in the status bar ("Increase Sweep Points"). If possible for the selected RBW and span, the minimum required number of sweep points to fulfill this condition is indicated. If the number of sweep points exceeds the limit, reduce the span or increase the RBW.

The FSW supports a maximum of 200001 sweep points for EMI measurements.

**Example:**

Linear axis:

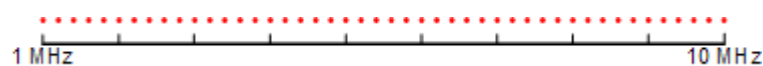

With a linear axis, the distance between the sweep points is equal, e.g. 200 kHz.

Logarithmic axis:

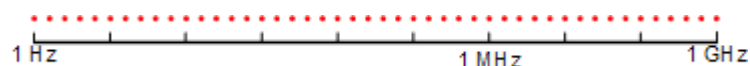

With a logarithmic axis, the distance between sweep points is variable. In the spectrum from 10 Hz to 100 Hz, the distance is a few Hz. Between 100 MHz and 1 GHz, the distance is several MHz.

This number is based on typical bands measured with a single resolution bandwidth. There are sufficient sweep points to make sure that a signal is found during the refined measurement, even when covering 30 MHz to 1 GHz with logarithmic scaling and 120 kHz RBW.

#### 6.13.3.4 Controlling V-Networks (LISN)

For measurements on power lines, EMI measurement adds functionality to the R&S FSW to control a line impedance stabilization network (LISN) directly. Thus you can determine the interference caused by power supplies and cables.

You can connect the LISN to the user port of the FSW. Control cables for the various LISNs are available as accessories. The FSW then controls which phase of the LISN is to be tested and outputs the information to the user port.

The EMI measurement supports several V-networks. For each type of network, you can define the phase you want to test for interferences. The EMI measurement allows you to test one phase at a time.

*Table 6-16: Supported networks and phases*

Network type	Phases
<b>Two-line V-networks</b>	
ESH3-Z5	N, L1
ENV216 / AMN6500	N, L1
<b>Four-line V-networks</b>	
ESH2-Z5	N, L1, L2, L3
ENV4200	N, L1, L2, L3
ENV432	N, L1, L2, L3

For the ENV216 / AMN6500 network, a 150 kHz highpass filter is available to protect the input of the FSW.

#### 6.13.3.5 Using transducer factors

The FSW EMI measurement provides functionality to include transducer factors in the test setup. Transducers are devices like antennas, probes or current probes that are connected to the FSW to measure interferences or wanted signals. The transducer converts the measured value such as field strength, current or RFI voltage into a voltage across 50  $\Omega$ . During the measurement, the transducer is considered a part of the instrument.

A transducer usually has a frequency-dependent transducer factor that includes the frequency response of the corresponding device. During level measurement, the transducer factor automatically converts the results into the correct unit and magnitude. A transducer factor consists of a maximum of 1001 reference values. Each reference value includes frequency, unit and level.

The FSW EMI measurement adds several predefined transducer factors. In addition, you can also create new and edit existing transducer factors.

For more information, see [Chapter 11.4.1, "Basics on transducer factors"](#), on page 754 .

### 6.13.3.6 Initial measurement - peak search

The purpose of an initial peak search is to find signals with a high interference level quickly. The peak search is performed with a fast detector like the peak or average detector. The initial peak search is the basis for a possible refined measurement of interferences with the detectors specific to EMI measurements.

The results of the initial peak search are shown in the Marker Table (see [Chapter 6.13.2, "EMI measurement results"](#), on page 333).

Peak searches can be performed automatically or manually.

#### Automatic peak search

If enabled, the automatic peak search starts as soon as you select the EMI measurement and one or more markers are active. During automatic peak search, the FSW looks for the strongest peaks in the frequency range you are measuring and positions a marker on those peaks after each sweep. If a **limit line** is assigned to the trace, the peak search is based on the level difference between the trace and the limit line. For each active marker, a peak is searched. You can use up to 16 markers simultaneously.

The largest peak is always assigned to the active marker with the lowest number; subsequent peaks are assigned to the active markers in ascending order.

The FSW allows you to distribute markers among several traces. If you do so, the marker with the lowest number assigned to a particular trace is positioned on the largest peak of the corresponding trace.

#### Manual peak search

If automatic peak search is off, you can set the markers to any frequency you need more information about manually. You can change the marker position with the rotary knob or the cursor s, or position it to a particular frequency with the number s.

Setting markers is the same as setting markers in other spectrum measurements. For more information, see [Chapter 8.3, "Marker usage"](#), on page 548.

#### Searching for peaks over several traces

You can search for peaks on six traces simultaneously with a different weighting detector for each trace.

In this case, the FSW searches for peaks on all traces separately, if you have assigned at least one marker to each trace.

A typical selection for EMI measurement is to use the peak and the average detector. After initial measurement, search for peaks on the peak trace and the average trace separately. Thus, you can consider the distribution of narrowband and wideband sources of interference.

**Example:**

- In the initial measurement, determine the peak on one trace using the average detector by assigning a marker to that trace. For the marker frequency, perform a refined measurement using the CISPR or RMS average detector.
- In the initial measurement, determine the peak on another trace using the peak detector by assigning another marker to that trace. For this marker frequency, perform a refined measurement using the quasi-peak detector.

**6.13.3.7 Final measurement at the marker position**

Finding peaks with the help of an initial marker peak search reduces data to be evaluated and thus measurement time. A final measurement with a special EMI detector can then refine the initial results.

The R&S FSW EMI measurement performs the final measurement automatically as soon as a detector for the final test is defined for an EMI marker and the marker is activated. The final measurement starts immediately after the marker has been set. The advantage of an immediate final measurement is that it eliminates the risk of measurement errors based on frequency drifts of the disturbance signal.

The final measurement at the marker frequency can have a different detector than during the initial peak search. Thus, the final measurement consumes much less time because detectors with a long measurement time are needed only at the critical frequency.

The R&S FSW EMI measurement also allows you to use multiple detectors for the final measurement. The advantage of multiple detections is that you only need one test run to see if the results comply with the limits specified in a standard. The detectors for the final EMI tests are defined in the marker configuration, as opposed to the *trace* detector which is used for the initial peak search.

The results of the final measurement are shown in the Result Summary (see [Chapter 6.13.2, "EMI measurement results"](#), on page 333).

**Defining a dwell time for the final measurement**

EMC tests often require a specific *dwell time* for an EMI measurement. The dwell time defines how long the FSW measures the signal at the frequencies of the marker positions. The dwell time is identical for all EMI final measurements and is thus defined in the EMI measurement configuration. Select a dwell time according to the characteristics of the measured signal. See also [Chapter 6.13.3.2, "Detectors and dwell time"](#), on page 336.

**6.13.3.8 Limit checks**

General limit line functionality is provided by the FSW base unit. The base unit also provides various predefined limit lines that you can use for various applications.

The EMI measurement adds further predefined limit lines designed in compliance with several EMC standards.

When using limit lines in combination with EMI measurements, the marker levels from the initial measurement are compared to the limit line values. The result of the limit line check is displayed in the diagram as usual.

In the EMI Result Summary, the limit check is based on the results of the final test. Since the marker can be determined using a different detector than the final test results, the two limit check results can differ. The difference between the limit line and the measured value is colored to indicate the following states:

- **green**: does not exceed limit
- **yellow**: within margin
- **red**: exceeds limit

For more information on using limit lines, see [Chapter 8.4.2.1, "Basics on limit lines"](#), on page 593.

### 6.13.4 EMI measurement configuration

**Access:** "Overview" > "Select Measurement" > "EMI" > "EMI Config"

On the FSW, EMI measurement configuration consists of the following settings.

In addition, some common settings are also relevant for EMI measurements:

- [Chapter 11.4.2, "Transducer settings"](#), on page 756
- ["Reference Level"](#) on page 484
- [Chapter 8.4.2.2, "Limit line settings and functions"](#), on page 597
- [EMI marker configuration](#)..... 341
- [EMI final measurement configuration](#)..... 345
- [LISN control settings](#)..... 349

#### 6.13.4.1 EMI marker configuration

**Access:** [MKR] > "Marker Config"

The final peak search for the EMI measurement is defined by the marker configuration.

## Electromagnetic interference (EMI) measurement

Markers	Marker Settings	Search	Marker Functions					
	Selected	State	X-Value	Type	Ref Marker	Link to Marker	Trace	Final Test Detector
1-5	Marker 1	On Off	3.75 GHz	Norm Delta	1	Off	1	Off
6-11	Delta 1	On Off	-750.0 MHz	Norm Delta	1	Off	1	Off
	Delta 2	On Off	-750.0 MHz	Norm Delta	1	Off	1	Off
12-16	Delta 3	On Off	-750.0 MHz	Norm Delta	1	Off	1	Off
	Delta 4	On Off	-750.0 MHz	Norm Delta	1	Off	1	Off
	Delta 5	On Off	-750.0 MHz	Norm Delta	1	Off	1	Off
All Markers Off								

Selected Marker.....	342
Marker State.....	342
Marker Position X-value.....	342
Marker Type.....	343
Reference Marker.....	343
Linking to Another Marker.....	343
Assigning the Marker to a Trace.....	344
Final Test Detector.....	344
Select Marker.....	345

**Selected Marker**

Marker name. The marker which is currently selected for editing is highlighted orange.

Remote command:

Marker selected via suffix <m> in remote commands.

**Marker State**

Activates or deactivates the marker in the diagram.

Remote command:

[CALCulate<n>:MARKer<m>\[:STATe\]](#) on page 1274

[CALCulate<n>:DELTAmarker<m>\[:STATe\]](#) on page 1271

**Marker Position X-value**

Defines the position (x-value) of the marker in the diagram. For normal markers, the absolute position is indicated. For delta markers, the position relative to the reference marker is provided.

To create a delta marker in a fixed distance to another marker, define the distance as the x-value for the delta marker. Then link the delta marker to another marker using the [Linking to Another Marker](#) function.

Remote command:

[CALCulate<n>:MARKer<m>:X](#) on page 1275

[CALCulate<n>:DELTaMarker<m>:X](#) on page 1272

### Marker Type

Toggles the marker type.

The type for marker 1 is always "Normal", the type for delta marker 1 is always "Delta". These types cannot be changed.

**Note:** If normal marker 1 is the active marker, switching the "Mkr Type" activates an additional delta marker 1. For any other marker, switching the marker type does not activate an additional marker, it only switches the type of the selected marker.

"Normal"            A normal marker indicates the absolute value at the defined position in the diagram.

"Delta"             A delta marker defines the value of the marker relative to the specified reference marker (marker 1 by default).

Remote command:

[CALCulate<n>:MARKer<m>\[:STATe\]](#) on page 1274

[CALCulate<n>:DELTaMarker<m>\[:STATe\]](#) on page 1271

### Reference Marker

Defines a marker as the reference marker which is used to determine relative analysis results (delta marker values).

If the reference marker is deactivated, the delta marker referring to it is also deactivated.

If a fixed reference point is configured (see "[Defining a Fixed Reference](#)" on page 556), the reference point ("FXD") can also be selected instead of another marker.

Remote command:

[CALCulate<n>:DELTaMarker<m>:MREference](#) on page 1271

### Linking to Another Marker

Links the current marker to the marker selected from the list of active markers. If the x-axis value of the initial marker is changed, the linked marker follows to the same position on the x-axis. Linking is off by default.

Using this function you can set two markers on different traces to measure the difference (e.g. between a max hold trace and a min hold trace or between a measurement and a reference trace).

For linked delta markers, the x-value of the delta marker is 0 Hz by default. To create a delta marker in a fixed distance to another marker, define the distance as the x-value for the linked delta marker.

Remote command:

[CALCulate<n>:MARKer<ms>:LINK:TO:MARKer<md>](#) on page 1273

[CALCulate<n>:DELTaMarker<ms>:LINK:TO:MARKer<md>](#) on page 1270

[CALCulate<n>:DELTaMarker<m>:LINK](#) on page 1269

### Assigning the Marker to a Trace

The "Trace" setting assigns the selected marker to an active trace. The trace determines which value the marker shows at the marker position. If the marker was previously assigned to a different trace, the marker remains on the previous frequency or time, but indicates the value of the new trace.

If a trace is turned off, the assigned markers and marker functions are also deactivated.

Remote command:

[CALCulate<n>:MARKer<m>:TRACe](#) on page 1274

### Final Test Detector

Defines the detector to be used for the final EMI test at the marker frequency.

This setting is only available if the EMI (R&S FSW-K54) measurement option is installed. CISPR detectors are only available after selecting a CISPR RBW or filter (see ["Res BW CISPR"](#) on page 349).

For details, see [Chapter 6.13.3.2, "Detectors and dwell time"](#), on page 336.

**Note:** The trace detector configured in the trace settings is used for the initial peak search only, see [Chapter 8.5.1.2, "Trace settings"](#), on page 622.

"Off"	No final test is performed.
"PositivePeak"	Determines the maximum signal level that was detected during the specified dwell time.
"Average"	Determines the average signal level of the samples that were collected during the specified dwell time.
"Quasi-Peak"	Determines the maximum signal level weighted to CISPR 16-1-1 that was detected during the dwell time. The "Quasi-Peak" detector is only available for the CISPR filter, and not for an RBW of 1 MHz.
"CISPR Average"	Determines a weighted average signal level according to CISPR 16-1-1. The average value according to CISPR 16-1-1 is the maximum value detected while calculating the linear average value during the specified dwell time. The "CISPR Average" detector is only available for the CISPR filter.
"RMS Average"	A combination of the RMS detector (for pulse repetition frequencies above a corner frequency) and the Average detector (for pulse repetition frequencies below the corner frequency). Lowpass filters of the second order determine the average value (simulation of a mechanical pointer instrument). The "RMS Average" detector is only available for the CISPR filter.

Remote command:

[CALCulate<n>:MARKer<m>:FUNCTION:FMEasurement:DETECTOR](#) on page 1081

[CALCulate<n>:DELTAmarker<m>:FUNCTION:FMEasurement:DETECTOR](#)

on page 1081



**Select Marker**

The "Select Marker" function opens a dialog box to select and activate or deactivate one or more markers quickly.



Remote command:

[CALCulate<n>:MARKer<m>\[:STATe\]](#) on page 1274

[CALCulate<n>:DELTAmarker<m>\[:STATe\]](#) on page 1271

**6.13.4.2 EMI final measurement configuration**

The final EMI measurement can be performed with different settings than the initial peak search. These settings are described here.

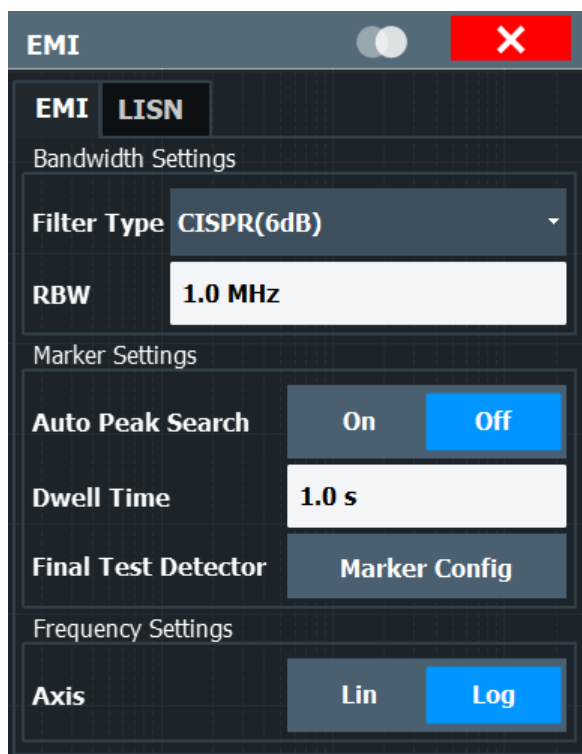

The detector to be used for the final EMI test can be defined differently for each frequency, thus the detector is configured in the EMI marker settings, see "[Final Test Detector](#)" on page 344.

<a href="#">Filter Type</a> .....	346
<a href="#">RBW</a> .....	347
<a href="#">Automatic Peak Search</a> .....	347
<a href="#">Dwell Time</a> .....	348
<a href="#">Final Test Detector</a> .....	348
<a href="#">Frequency Axis Scaling</a> .....	349
<a href="#">Res BW CISPR</a> .....	349
<a href="#">Res BW MIL</a> .....	349

### Filter Type

Defines the filter type.

The following filter types are available:

- Normal (3dB)
- Channel
- RRC (not available for sweep type "FFT")
- 5-Pole (not available for sweep type "FFT")
- CISPR (6 dB) - requires EMI (R&S FSW-K54) option
- MIL Std (6 dB) - requires EMI (R&S FSW-K54) option

For more information, see [Chapter 7.5.1.6, "Which data may pass: filter types"](#), on page 496.

**Note:** The EMI-specific filter types are available if the EMI (R&S FSW-K54) measurement option is installed, even if EMI measurement is not active. If you select a CISPR trace detector, the filter type is automatically also set to CISPR. An active CISPR filter is indicated in the channel info, next to the RBW information. For details, see [Chapter 6.13.3.1, "Resolution bandwidth and filter types"](#), on page 335.

The RBW filter configured in the bandwidth settings is identical to the filter configured in the EMI configuration.

Remote command:

`[SENSe:]BANDwidth[:RESolution]:TYPE` on page 1199

### RBW

Defines the resolution bandwidth. The available resolution bandwidths are specified in the specifications document. Numeric input is always rounded to the nearest possible bandwidth.

If "Auto" is selected, the resolution bandwidth is coupled to the selected span (for span > 0). If the span is changed, the resolution bandwidth is automatically adjusted.

If the resolution bandwidth is defined manually, a green bullet is displayed next to the "RBW" display in the channel bar.

For a list of supported filters, see the specifications document.

For more information see [Chapter 7.5.1.1, "Separating signals by selecting an appropriate resolution bandwidth"](#), on page 492.

**Note:** Restrictions.

- For measurements on I/Q data in the frequency domain, the maximum RBW is 1 MHz.
- Some additional Gaussian filters are provided for special measurements, such as 5G NR spurious emissions measurements. They are only available if you enter the value manually, not using the rotary knob or stepping through the filter values. They are not supported by all applications. For these particular filters, gating is also possible. The following values indicate the 3-dB filter width:
  - 51 kHz
  - 150 kHz
  - 250 kHz
  - 400 kHz
  - 450 kHz
  - 6 MHz
  - 8 MHz
- For EMI measurements using the quasipeak detector, the 1 MHz RBW filter is not available (see [Chapter 6.13.3.1, "Resolution bandwidth and filter types"](#), on page 335).

Remote command:

`[SENSe:]BANDwidth[:RESolution]` on page 1198

`[SENSe:]BANDwidth[:RESolution]:AUTO` on page 1198

### Automatic Peak Search

If activated, a peak search is performed automatically for all active markers after each sweep.

If Auto peak search *and* limit lines are active, the active markers are set to the peak *delta* values between the measured signal and the limit lines.

**Note:** The general search functions [Auto Max Peak Search / Auto Min Peak Search](#) are not available for EMI measurements.

Remote command:

`CALCulate<n>:MARKer<m>:FUNCTION:FMEasurement:PEAKsearch:AUTO`  
on page 1082

### Dwell Time

Sets the dwell time for the EMI marker measurement.

For more information see [Chapter 6.13.3.2, "Detectors and dwell time"](#), on page 336.

Remote command:

`CALCulate<n>:MARKer<m>:FUNCTION:FMEasurement:DWELL` on page 1083

### Final Test Detector

Defines the detector to be used for the final EMI test at the marker frequency.

This setting is only available if the EMI (R&S FSW-K54) measurement option is installed. CISPR detectors are only available after selecting a CISPR RBW or filter (see ["Res BW CISPR"](#) on page 349).

For details, see [Chapter 6.13.3.2, "Detectors and dwell time"](#), on page 336.

**Note:** The trace detector configured in the trace settings is used for the initial peak search only, see [Chapter 8.5.1.2, "Trace settings"](#), on page 622.

"Off"	No final test is performed.
"PositivePeak"	Determines the maximum signal level that was detected during the specified dwell time.
"Average"	Determines the average signal level of the samples that were collected during the specified dwell time.
"Quasi-Peak"	Determines the maximum signal level weighted to CISPR 16-1-1 that was detected during the dwell time. The "Quasi-Peak" detector is only available for the CISPR filter, and not for an RBW of 1 MHz.
"CISPR Average"	Determines a weighted average signal level according to CISPR 16-1-1. The average value according to CISPR 16-1-1 is the maximum value detected while calculating the linear average value during the specified dwell time. The "CISPR Average" detector is only available for the CISPR filter.
"RMS Average"	A combination of the RMS detector (for pulse repetition frequencies above a corner frequency) and the Average detector (for pulse repetition frequencies below the corner frequency). Lowpass filters of the second order determine the average value (simulation of a mechanical pointer instrument). The "RMS Average" detector is only available for the CISPR filter.

Remote command:

`CALCulate<n>:MARKer<m>:FUNCTION:FMEasurement:DETECTOR` on page 1081

`CALCulate<n>:DELTAmarker<m>:FUNCTION:FMEasurement:DETECTOR`

on page 1081

### Frequency Axis Scaling

Switches between linear and logarithmic scaling for the frequency axis.

Logarithmic scaling is only available if R&S FSW-K54 is installed and only for  $f_{\text{stop}} \geq 1.4 \cdot f_{\text{start}}$ .

By default, the frequency axis has linear scaling. Logarithmic scaling of the frequency axis, however, is common for measurements over large frequency ranges as it enhances the resolution of the lower frequencies. On the other hand, high frequencies get more crowded and become harder to distinguish.

For more information see [Chapter 7.3.1.3, "Coping with large frequency ranges - logarithmic scaling"](#), on page 472.

Remote command:

`DISPLAY[:WINDOW<n>][:SUBWindow<w>]:TRACE<t>:X:SPACING` on page 1191

### Res BW CISPR

Automatically sets the measurement bandwidth for commercial EMC standards according to CISPR.

For more information, see [Chapter 6.13.3.1, "Resolution bandwidth and filter types"](#), on page 335.

Remote command:

Filter type:

`[SENSe:]BANDwidth[:RESolution]:TYPE` on page 1199

Filter bandwidth:

`[SENSe:]BANDwidth[:RESolution]` on page 1198

### Res BW MIL

Automatically sets the measurement bandwidth for military EMC standards.

For more information, see [Chapter 6.13.3.1, "Resolution bandwidth and filter types"](#), on page 335.

Remote command:

Filter type:

`[SENSe:]BANDwidth[:RESolution]:TYPE` on page 1199

Filter bandwidth:

`[SENSe:]BANDwidth[:RESolution]` on page 1198

#### 6.13.4.3 LISN control settings

**Access:** [MEAS CONFIG] > "LISN Config"

For measurements with power lines, the following settings are available for the FSW to control which phase of the LISN is to be tested (e.g. for EMI measurements). LISN control requires the EMI measurement (R&S FSW-K54) option.

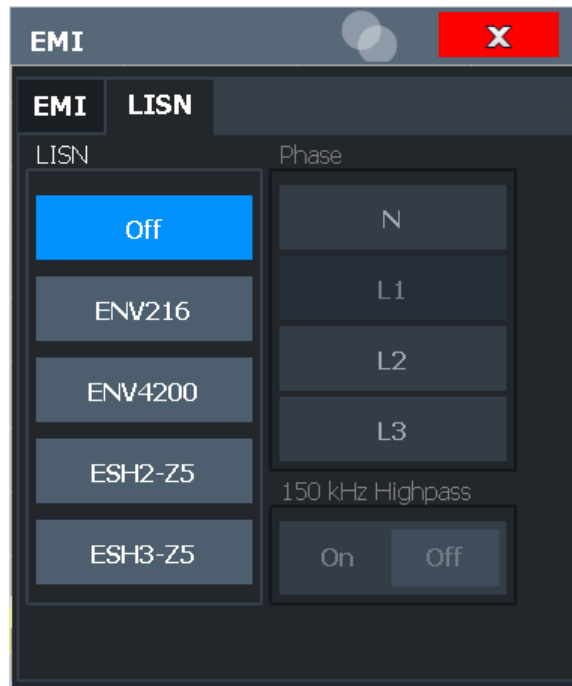

For more information, see [Chapter 6.13.3.4, "Controlling V-Networks \(LISN\)"](#), on page 338.

<a href="#">LISN Type</a> .....	350
<a href="#">Phase</a> .....	350
<a href="#">150 kHz Highpass</a> .....	350

### LISN Type

Selects the network type and activates output to the network via the user port of the FSW. The network type determines the supported phases (see [Table 6-16](#)).

"Off" disables LISN control and output.

Remote command:

[INPut:LISN\[:TYPE\]](#) on page 1084

### Phase

Selects the phase to be measured. Phase N and L1 are included in all four LISN. Phase L2 and L3 are only included in four-line networks.

You can select one phase only for each measurement.

Remote command:

[INPut:LISN:PHASe](#) on page 1084

### 150 kHz Highpass

Enables or disables the use of an additional 150 kHz highpass filter to protect the FSW LISN from excessive input.

The filter is available for the ENV 216 network only.

Remote command:

[INPut:LISN:FILTer:HPASs\[:STATe\]](#) on page 1083

### 6.13.5 EMI result analysis

The EMI measurement provides functionality to analyze the results.

#### Marker demodulation

The FSW is able to demodulate AM and FM signals for acoustic tests and monitoring purposes.

When the demodulator function is active, the EMI measurement demodulates the signal continuously (regardless of the "Continuous Demodulation" setting in the marker function configuration). The demodulation begins as soon as a marker is activated. During the initial measurement, demodulation is performed for the entire measurement span; during the final measurement only the detected peak marker positions are demodulated (for the defined dwell time). You can listen to the results during the measurement using headphones or the internal speaker.

For more information, see [Chapter 8.3.4.7, "Demodulating marker values and providing audio output \(marker demodulation\)"](#), on page 579.

#### Limit lines

General limit line functionality is provided by the FSW base unit. The base unit also provides various predefined limit lines that you can use for various applications.

The EMI measurement adds further predefined limit lines designed in compliance with several EMC standards.

Limit line configuration is described in [Chapter 8.4.2.2, "Limit line settings and functions"](#), on page 597.

#### Test reports

The FSW features a test report generator. A test report is a document that summarizes the results and configuration of measurements.

Test reports are based on a general template, and are completed with user-defined, measurement-specific contents. You can create multiple templates for different applications.

Test reports are described in [Chapter 10.6, "Working with test reports"](#), on page 710.

### 6.13.6 How to perform EMI measurements

The following step-by-step instructions demonstrate how to perform an EMI measurement with the FSW.



For remote operation, see [Chapter 13.5.14.8, "Programming example: EMI measurement"](#), on page 1087.

1. Select [MODE] on the front panel and select the "Spectrum" application.
2. Define the frequency range of the EMI measurement.

- a) Select [FREQ] and then the "Frequency Config" .
- b) Define the start and stop frequency.
3. Configure the traces for the initial EMI measurement.
  - a) Select [TRACE] .
  - b) Select the "Trace Config" to configure as many traces as required.
  - c) Define the detectors to use for the initial measurement, for example the peak detector and the average detector.
4. Select [MEAS] on the front panel and select the "EMI" measurement.

The EMI main menu is displayed.
5. Select the "EMI Config" .
6. Define the resolution bandwidth and filter type to be used for the measurement.

By default, the FSW uses a filter with a 3-dB bandwidth. EMI measurements usually require a filter with a 6 dB bandwidth.
7. Define the dwell time for which each marker position is measured during the final measurement.
8. To obtain an overview of peak values in the input signal during the initial measurement, activate the "Auto Peak Search".

As soon as a sweep is started, the FSW looks for the strongest peaks in the frequency range you are measuring and positions one of the active markers on those peaks. The number of active markers determines the number of detected peaks; no additional markers are activated.
9. Define the type of scaling for the frequency axis according to the definition of the limit lines in the standard.
10. Optionally, select the "LISN Config" to configure a LISN control.
11. Configure the EMI measurement markers.
  - a) Select "Marker Config".
  - b) Activate the number of markers or delta markers you want to analyze.
  - c) For each active marker, select a detector to be used for the "Final Test", that is: the subsequent EMI measurement at the marker position.
  - d) If you already know which frequencies cause irregular values, set the markers to those positions. (Otherwise perform an initial peak search to obtain an overview, see [step 8](#)).
12. Optionally, select the "Marker Demod Config" to configure continuous marker demodulation.

Demodulation begins immediately with the next measurement. During the initial measurement, demodulation is performed for the entire measurement span; during the final measurement only the detected peak marker positions are demodulated (for the defined dwell time).
13. Increase the number of sweep points for the EMI measurement.
  - a) Select [SWEEP] on the front panel.



- b) Select the "Sweep Config" .
  - c) Set the number of "Sweep Points" so that the distance between two sweep points is smaller than RBW/2.
14. Optionally, select or configure limit lines to check the marker results against.
  - a) Select [Lines] and then the "Lines Config" , then select the "Lines Config" tab.
  - b) In the "Line Config" dialog box, select the "View Filter" option: "Show Compatible".

All limit lines that comply with the following conditions are displayed in the overview:

    - Stored in the `limits` subfolder of the main installation folder of the instrument
    - File extension `.LIN`
    - Compatible to the current EMI measurement settings
  - c) Select the "Check Traces" setting for a limit line in the overview.
  - d) Select the trace numbers to be included in the limit check. You can assign the same limit line to several traces.
15. The default unit dBm is not suitable for EMI measurements. Define a suitable unit for the measured values, or select a transducer.

To change the unit:  
Select [AMPT] > "Amplitude Config" > "Unit".

To select a transducer:

  - a) Select [SETUP].
  - b) Select "Transducer".
  - c) In the "Transducer" dialog box, set the "View Filter" to "Show Compatible" to determine the available transducers for the current EMI measurement setup.
  - d) In the overview, select the "Active" setting for a transducer line.
16. Select [RUN SINGLE] to start a new EMI measurement.

If activated, a peak search is performed. For each active marker, a final measurement is performed using the specified detector for the specified dwell time. If activated, the signal is demodulated at the active marker positions.

The specified traces to be checked are compared with the active limit lines. The status of the limit check for the final measurement is indicated in the Result Summary.

### 6.13.7 Measurement example: measuring radio frequency interference

A common measurement task that you can do with the EMI measurement is to detect radio frequency interference (RFI) or electromagnetic interferences (EMI).

The measurement shows signal levels over a particular frequency range. A typical frequency range for EMI measurements is 150 kHz to 1 GHz. Usually, the captured signal characteristics are unknown. Thus, the best way to start the measurement is to preset the FSW and perform a peak search to obtain a general overview.

If you perform measurements according to a particular EMI standard, a preset also eliminates the risk of wrong settings inherited from previous measurements. Note that EMI measurements are possible in the Spectrum application only.



A programming example demonstrating an EMI measurement in a remote environment is provided in [Chapter 13.5.14.8, "Programming example: EMI measurement"](#), on page 1087.

### Preparing the measurement

1. Select [PRESET] .

The FSW restores the default settings.

2. Define the frequency range of the measurement.

- a) Select [FREQ] .
- b) Select "Start Frequency".
- c) Enter a frequency of *150 kHz*.
- d) Select "Stop Frequency".
- e) Enter a frequency of *1 GHz*.

The FSW scales the horizontal axis accordingly.

3. Select [MEAS] on the front panel and select the "EMI" measurement.

The EMI main menu is displayed.

4. Select the "EMI Config" .

5. Define the resolution bandwidth and filter type for the measurement.

By default, the FSW uses a filter with a 3-dB bandwidth. EMI measurements usually require a filter with a 6-dB bandwidth.

6. Define the dwell time for which each marker position is measured during the final measurement.

7. To obtain an overview of exceptional values in the input signal during the initial measurement, activate the "Auto Peak Search".

8. Select the measurement bandwidth.

- a) Select the "Res BW CISPR" .  
A CISPR (6 dB) filter is configured.
- b) Set the bandwidth to *1 MHz*.

The FSW shows the currently selected resolution bandwidth in the diagram header.

9. Configure the traces for the initial EMI measurement.

- a) Select [TRACE] .
- b) Select "Trace Config" to configure two traces.

## Electromagnetic interference (EMI) measurement

- c) Define the detectors to use for the initial measurement. Select the peak detector for trace 1 and the average detector for trace 2.

The peak detector ensures that the detected peak levels in the frequency range covered by one pixel are displayed.

The FSW now displays two traces. Trace 1 shows the peak values, trace 2 shows the average values.

10. Increase the number of sweep points for the EMI measurement.
  - a) Select [SWEEP] on the front panel.
  - b) Select the "Sweep Config" .
  - c) Set the number of "Sweep Points" to 200000.
11. Select [AMPT] , then select the "Amplitude Config" and, in the "Amplitude" dialog box, select V as the "Unit".

### Performing the measurement

1. Configure the EMI measurement markers. In this example, we use 6 markers.
  - a) Select the "Marker Config" .
  - b) Activate six normal markers.
  - c) Set markers 1 to 3 on trace 1. Set markers 4 to 6 on trace 2.
  - d) For each of these markers, select the "CISPR AV" detector to be used for the "Final Test", i.e. the subsequent EMI measurement at the marker positions.
2. Select a limit line to check the marker results against.
  - a) Select [Lines] and then the "Lines Config" , then select the "Lines Config" tab.
  - b) In the "Line Config" dialog box, select the "View Filter" option: "Show Compatible".

All limit lines that comply with the following conditions are displayed in the overview:

  - Stored in the `limits` subfolder of the main installation folder of the instrument
  - File extension `.LIN`
  - Compatible to the current EMI measurement settings
  - c) In the overview, click the "Check Traces" setting for the `EN55011A` limit line.
  - d) Select trace 1 to be included in the limit check. (Trace 2, which is defined as the average, is always lower than trace 1, which contains peak values.)
3. Select [RUN SINGLE] to start a new EMI measurement.

If activated, a peak search is performed. For each active marker, a final measurement is performed using the specified detector for the specified dwell time.

If activated, the signal is demodulated. During the initial measurement, demodulation is performed for the entire measurement span; during the final measurement only the detected peak marker positions are demodulated (for the defined dwell time).

The specified traces to be checked are compared with the active limit line. The status of the limit check for the final measurement is indicated in the Result Summary.

### Evaluating the measurement

Check the Result Summary to detect exceeded limit values.

Zoom into the diagram at the conspicuous frequency for more details.

If necessary, decrease the span to the area in which irregular values occurred and repeat the measurement.

## 6.13.8 Optimizing and troubleshooting EMI measurements

If the results do not meet your expectations, try the following methods to optimize the measurement:

### Number of sweep points

The resolution bandwidth should cover at least one sweep point (more is better). If this condition is not met, signals or interferences could be missed during refined measurement of narrowband interferences. See [Chapter 6.13.3.3, "Frequency resolution - sweep points and scaling"](#), on page 337.

If the distance between two sweep points is larger than  $RBW/2$ , a warning is displayed in the status bar ("Increase Sweep Points" or "RBW").

### Dwell time

Consider the following when defining the dwell time:

- **Unknown signals:** select a dwell time of at least 1 second to ensure that pulses down to a frequency of 5 Hz are weighted correctly
- **Pulsed signals or signals that fluctuate slowly:** the dwell time must cover at least the time until the first signal peak is measured; can require long dwell time
- **Unmodulated signals or signals with a high modulation frequency:** the dwell time must cover at least the time until the first signal peak is measured; usually shorter than for pulsed signals

## 7 Common measurement settings

Basic measurement settings that are common to many measurement tasks, regardless of the application or operating mode, are described here. If you are performing a specific measurement task, using an operating mode other than Signal and Spectrum Analyzer mode, or an application other than the Spectrum application, be sure to check the specific application or mode description for settings that may deviate from these common settings.

- [Configuration overview](#).....357
- [Data input and output](#).....359
- [Frequency and span configuration](#).....471
- [Amplitude and vertical axis configuration](#).....479
- [Bandwidth, filter and sweep configuration](#).....492
- [Trigger and gate configuration](#).....508
- [Adjusting settings automatically](#).....530

### 7.1 Configuration overview



**Access:** all menus

Each channel provides an overview of the most important currently defined settings and access to the most important configuration dialog boxes for the particular measurement. This overview is available via the "Overview" icon, which is displayed in all menus.

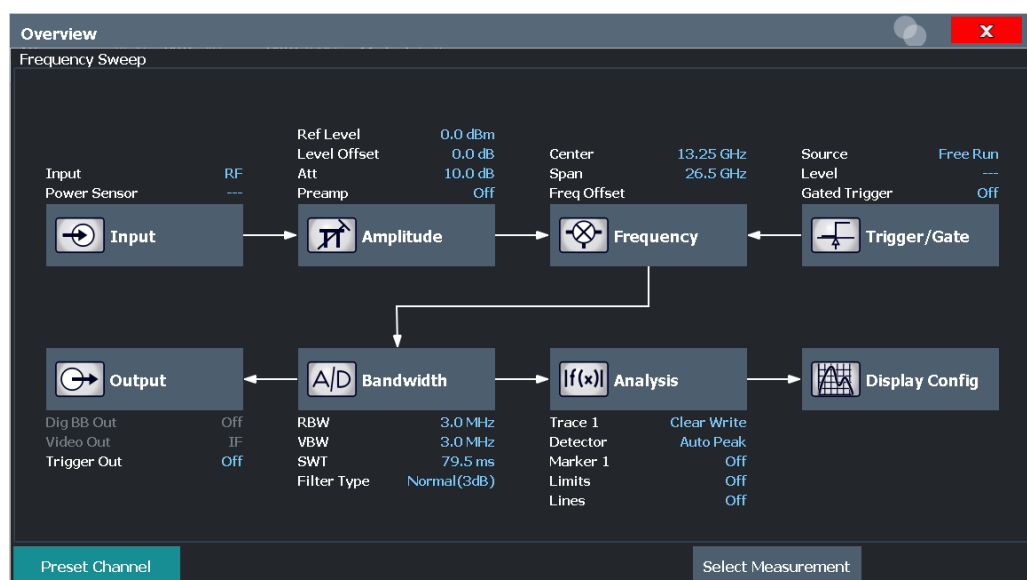

Using this overview, you can easily configure an entire channel from input over processing to output and analysis by stepping through the dialog boxes as indicated.

In particular, the "Overview" provides quick access to the following configuration dialog boxes (listed in the recommended order of processing):

1. "Select Measurement"  
See [Chapter 6, "Measurements and results"](#), on page 127
2. Input  
[Chapter 7.2, "Data input and output"](#), on page 359
3. Amplitude  
See [Chapter 7.4, "Amplitude and vertical axis configuration"](#), on page 479
4. Frequency  
See [Chapter 7.3, "Frequency and span configuration"](#), on page 471
5. (Optionally:) Trigger/Gate  
See [Chapter 7.6, "Trigger and gate configuration"](#), on page 508
6. Bandwidth  
See [Chapter 7.5.2, "Bandwidth, filter and sweep settings"](#), on page 498  
(For SEM measurements: SEM Setup, see [Chapter 6.6.5, "SEM configuration"](#), on page 247)  
(For Spurious measurements: Spurious Setup, see [Chapter 6.7.4, "Spurious emissions measurement configuration"](#), on page 283)
7. (Optionally:) Outputs  
See [Chapter 7.2.8, "Output settings"](#), on page 466
8. Analysis  
See [Chapter 8, "Common analysis and display functions"](#), on page 534
9. Display  
See [Chapter 8.1, "Result display configuration"](#), on page 534

### To configure settings

- ▶ Select any button to open the corresponding dialog box.  
Select a setting in the channel bar (at the top of the channel tab) to change a specific setting.

### Preset Channel

Select "Preset Channel" in the lower left-hand corner of the "Overview" to restore all measurement settings *in the current channel* to their default values.

**Note:** Do not confuse "Preset Channel" with the [Preset] key, which restores the entire instrument to its default values and thus closes *all channels* on the FSW (except for the default channel)!

Remote command:

`SYSTem:PRESet:CHANnel [:EXEC]` on page 1362

## 7.2 Data input and output

The FSW can analyze signals from different input sources and provide various types of output (such as video or trigger signals).

- [Receiving data input and providing data output](#)..... 359
- [Input source settings](#)..... 362
- [Power sensors](#)..... 367
- [Optional external generator control](#)..... 375
- [Probes](#)..... 403
- [Optional external mixers](#)..... 411
- [External frontend control \(R&S FSW-K553\)](#)..... 441
- [Output settings](#)..... 466
- [Trigger input/output settings](#)..... 468
- [How to output a trigger signal](#)..... 470

### 7.2.1 Receiving data input and providing data output

The FSW can analyze signals from different input sources and provide various types of output (such as noise or trigger signals).

#### 7.2.1.1 Receiving and providing trigger signals

Using one of the "TRIGGER INPUT / OUTPUT" connectors of the FSW, the FSW can use a signal from an external device as a trigger to capture data. Alternatively, the internal trigger signal used by the FSW can be output for use by other connected devices. Using the same trigger on several devices is useful to synchronize the transmitted and received signals within a measurement.

For details on the connectors see the FSW "Getting Started" manual.

#### External trigger as input

If the trigger signal for the FSW is provided by an external device, the trigger signal source must be connected to the FSW and the trigger source must be defined as "External" in the FSW.



#### External triggers with R&S FSW-B2000/B5000

When the input is provided from an FSW with the B2000/B5000 option, the connected oscilloscope samples the data. Thus, triggering is also processed by the oscilloscope. The trigger source can be either the IF level or an external trigger, for example from the FSW.

In this case, the trigger source must be defined as "External CH3" (or "External Analog" for power splitting mode) on the FSW.

#### Trigger output

The FSW can provide output to another device either to pass on the internal trigger signal, or to indicate that the FSW itself is ready to trigger.

The trigger signal can be output by the FSW automatically, or manually by the user. If it is provided automatically, a high signal is output when the FSW has triggered due to a sweep start ("Device Triggered"), or when the FSW is ready to receive a trigger signal after a sweep start ("Trigger Armed").

### Manual triggering

If the trigger output signal is initiated manually, the length and level (high/low) of the trigger pulse is also user-definable. Note, however, that the trigger pulse level is always opposite to the constant signal level defined by the output "Level" setting, e.g. for "Level" = "High", a constant high signal is output to the connector until "Send Trigger" is selected. Then, a low pulse is provided.

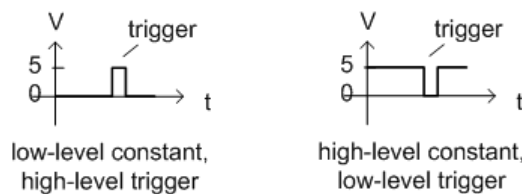

#### 7.2.1.2 IF and video signal output

The measured IF signal or displayed video signal (i.e. the filtered and detected IF signal) can be provided at the IF/VIDEO/DEMOD or "IF OUT 2 GHz/ IF OUT 5 GHz" output connector.

The **video output** is a signal of 1 V. It can be used, for example, to control demodulated audio frequencies.

The **IF output** is a signal of the measured level at a specified frequency.

The "2ND IF" output is a signal with a bandwidth of 2 GHz at the frequency 2 GHz. This output is only available if the "IF OUT 2 GHz/ IF OUT 5 GHz" output connector is installed. (The availability of this connector depends on the instrument model.)

If the optional 2 GHz / 5 GHz bandwidth extension (R&S FSW-B2000/B5000) is active, the "IF OUT 2 GHz/ IF OUT 5 GHz" output connector is used to transfer the measured data from the FSW to the connected oscilloscope. In this case, the "2ND IF" output is automatically deactivated. It is not reactivated when the B2000/B5000 option is switched off.

The frequency at which the active B5000 option transmits data to the oscilloscope via the "IF 5 GHz OUT" connector depends on the analysis bandwidth.

### Restrictions

Note the following restrictions for data output:

- IF and video output is only available in the time domain (zero span).
- For I/Q data, only IF output is available.
- IF output is not available if any of the following conditions apply:
  - The optional "Digital Baseband" interface is active (for input or output)



- MSRA operating mode is active
- MSRT operating mode is active
- A wideband extension is used (hardware options R&S FSWB160--B512; used automatically for bandwidths > 80 MHz; in this case select the "IF WIDE OUT" output, which uses the "IF WIDE OUTPUT" connector; for bandwidths larger than 512 MHz, IF output is not available.)  
A wideband extension is used (hardware options R&S FSWB160--B512; used automatically for bandwidths > 80 MHz; in this case select the "IF WIDE OUT" output, which uses the "IF WIDE OUTPUT" connector)
- The sample rate is larger than 200 MHz (upsampling)

### IF WIDE OUTPUT

For bandwidths > 80 MHz, but less than 512 MHz, the IF output is provided at the "**IF WIDE OUTPUT**" connector.

For bandwidths larger than 512 MHz, IF output is not available.

In this case, the IF output frequency cannot be defined manually, but is determined automatically depending on the center frequency. The currently used output frequency is indicated in the "IF Wide Out Frequency" field of the "Output" dialog box. For details on the used frequencies see the specifications document.

### 2ND IF Output

For instrument models FSW26/43/50/67/85, the IF output can also be provided at the optional "IF OUT 2 GHz" output connector at a frequency of 2 GHz and **with a bandwidth of 2 GHz**. The IF output can then be analyzed by a different instrument, for example an R&S@RTO oscilloscope.

For instrument model FSW85, the IF output can also be provided at the optional "IF OUT 2 GHz" output connector at a frequency of 2 GHz and **with a bandwidth of 2 GHz**. The IF output can then be analyzed by a different instrument. However, consider the note on the 2 GHz / 5 GHz bandwidth extension option below.



If "2ND IF" output is activated, the measured values are no longer available on the display; thus, the trace data currently displayed on the FSW becomes invalid. A message in the status bar indicates this situation. The message also indicates whether the sidebands of the IF spectrum output are in normal or inverted order compared to the RF signal, which depends on the used center frequency.



### 2 GHz / 5 GHz bandwidth extension option (R&S FSW-B2000/B5000)

To analyze IF data with a bandwidth of 2 GHz / 5 GHz using an R&S@RTO oscilloscope, it is recommended that you use the fully integrated solution including alignment with the **2 GHz / 5 GHz bandwidth extension option (R&S FSW-B2000/B5000)**, rather than the "2ND IF" output solution.

If the B2000/B5000 option is activated, the "2ND IF" output is automatically deactivated. It is not reactivated when the B2000/B5000 option is switched off.

For details see the FSW I/Q Analyzer and I/Q Input User Manual.

**Prerequisites**

Note the following prerequisites for output to the **"IF OUT 2 GHz"** connector ("2ND IF"):

- Instrument model FSW26/43/50/67/85; external mixers can be used
- Zero span mode, I/Q Analyzer, or optional application supporting B2000 (See the FSW I/Q Analyzer and I/Q Input User Manual)
- Center frequency  $\geq 5.5$  GHz
- Optional 2 GHz bandwidth extension (R&S FSW-B2000) is not active

Prerequisites for output to the **"IF OUT 5 GHz"** connector ("2ND IF"):

- Instrument model FSW43/85; external mixers can be used
- Zero span mode, I/Q Analyzer, or optional application supporting B5000
- Center frequency  $\geq 9.5$  GHz
- Optional 5 GHz bandwidth extension (R&S FSW-B5000) is not active

**7.2.2 Input source settings**

**Access:** "Overview" > "Input" > "Input Source"

The input source determines which data the FSW analyzes.

The default input source for the FSW is "Radio Frequency", i.e. the signal at the "RF Input" connector of the FSW. If no additional options are installed, this is the only available input source.

Since the Digital I/Q input and the Analog Baseband input use the same digital signal path, both cannot be used simultaneously. When one is activated, established connections for the other are disconnected. When the second input is deactivated, connections to the first are re-established. Reconnecting can cause a short delay in data transfer after switching the input source.

External mixers are not supported in MSRA/MSRT mode.

- [Radio frequency input](#)..... 362

**7.2.2.1 Radio frequency input**

**Access:** "Overview" > "Input/Frontend" > "Input Source" > "Radio Frequency"

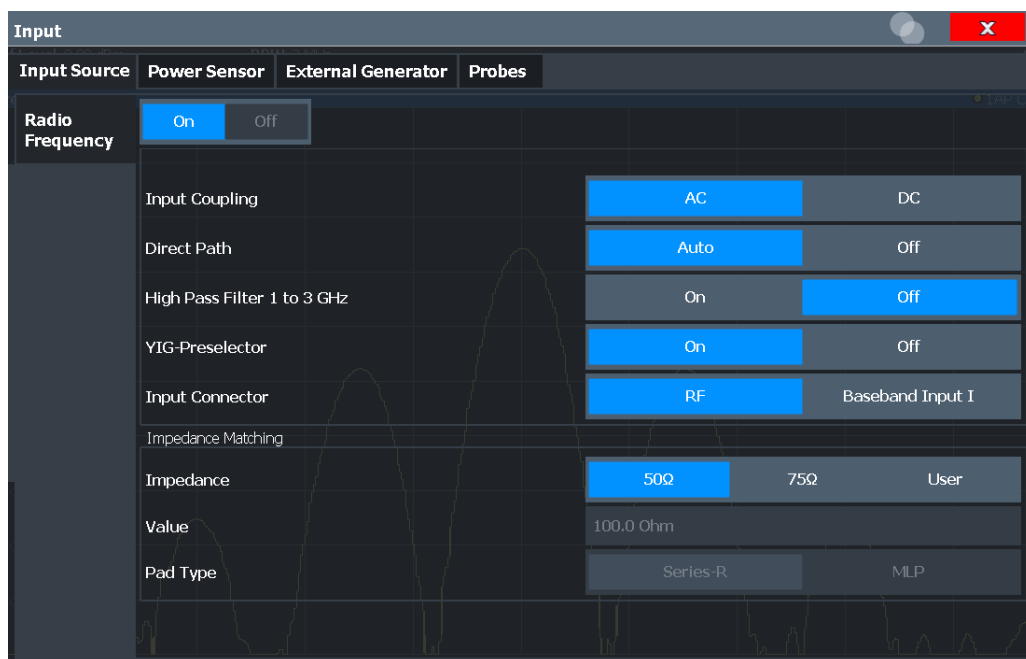

**RF Input Protection**

The RF input connector of the FSW must be protected against signal levels that exceed the ranges specified in the specifications document. Therefore, the FSW is equipped with an overload protection mechanism for DC and signal frequencies up to 30 MHz. This mechanism becomes active as soon as the power at the input mixer exceeds the specified limit. It ensures that the connection between RF input and input mixer is cut off.

When the overload protection is activated, an error message is displayed in the status bar ("INPUT OVLD"), and a message box informs you that the RF input was disconnected. Furthermore, a status bit (bit 3) in the `STAT:QUES:POW` status register is set. In this case, you must decrease the level at the RF input connector and then close the message box. Then measurement is possible again. Reactivating the RF input is also possible via the remote command `INPut:ATTenuation:PROTection:RESet`.

Radio Frequency State..... 363  
 Input Coupling..... 364  
 Impedance..... 364  
 Direct Path..... 365  
 High Pass Filter 1 to 3 GHz..... 365  
 YIG-Preselector..... 365  
 Preselector Adjust..... 366  
 Input Connector..... 366

**Radio Frequency State**

Activates input from the "RF Input" connector.

For FSW85 models with two input connectors, you must define which input source is used for each measurement channel.

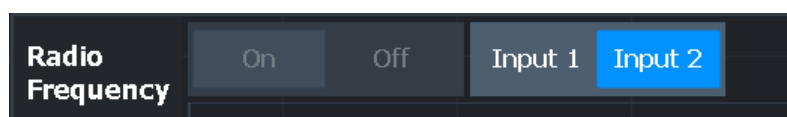

If an external frontend is active, select the connector the external frontend is connected to. You cannot use the other RF input connector simultaneously for the same channel. However, you can configure the use of the other RF input connector for another active channel at the same time.

"Input 1"            1.00 mm RF input connector for frequencies up to 85 GHz (90 GHz with option R&S FSW-B90G)

"Input 2"            1.85 mm RF input connector for frequencies up to 67 GHz

Remote command:

[INPut:SElect](#) on page 1113

[INPut:TYPE](#) on page 1114

### Input Coupling

The RF input of the FSW can be coupled by alternating current (AC) or direct current (DC).

For an active external frontend, input coupling is always AC.

Not available for input from the optional "Analog Baseband" interface.

Not available for input from the optional "Digital Baseband" interface.

AC coupling blocks any DC voltage from the input signal. AC coupling is activated by default to prevent damage to the instrument. Very low frequencies in the input signal can be distorted.

However, some specifications require DC coupling. In this case, you must protect the instrument from damaging DC input voltages manually. For details, refer to the specifications document.

Remote command:

[INPut:COUPling](#) on page 1110

### Impedance

The FSW has an internal impedance of 50  $\Omega$ . However, some applications use other impedance values. To match the impedance of an external application to the impedance of the FSW, an *impedance matching pad* can be inserted at the input. If the type and impedance value of the used matching pad is known to the FSW, it can convert the measured units accordingly so that the results are calculated correctly.

(See "[Reference Level](#)" on page 484).

For an active external frontend, impedance is always 50  $\Omega$ .

This function is not available for input from the optional "Digital Baseband" interface.

Not all settings are supported by all FSW applications.

The impedance conversion does not affect the level of the output signals (such as IF, video, demod, digital I/Q output).

"50 $\Omega$ "            (Default:) no conversion takes place

"75Ω"	The 50 Ω input impedance is transformed to a higher impedance using a 75 Ω adapter of the selected "Pad Type": "Series-R" (default) or "MLP" (Minimum Loss Pad)
"User"	The 50 Ω input impedance is transformed to a user-defined impedance value according to the selected "Pad Type": "Series-R" (default) or "MLP" (Minimum Loss Pad)

Remote command:

[INPut:IMPedance](#) on page 1112

[INPut:IMPedance:PTYPe](#) on page 1112

For Analog Baseband input:

[INPut:IQ:IMPedance](#) on page 1142

[INPut:IQ:IMPedance:PTYPe](#) on page 1142

### Direct Path

Enables or disables the use of the direct path for small frequencies.

In spectrum analyzers, passive analog mixers are used for the first conversion of the input signal. In such mixers, the LO signal is coupled into the IF path due to its limited isolation. The coupled LO signal becomes visible at the RF frequency 0 Hz. This effect is referred to as LO feedthrough.

To avoid the LO feedthrough the spectrum analyzer provides an alternative signal path to the A/D converter, referred to as the *direct path*. By default, the direct path is selected automatically for RF frequencies close to zero. However, this behavior can be disabled. If "Direct Path" is set to "Off", the spectrum analyzer always uses the analog mixer path.

For an active external frontend, the direct path is always used automatically for frequencies close to zero.

"Auto" (Default) The direct path is used automatically for frequencies close to zero.

"Off" The analog mixer path is always used.

Remote command:

[INPut:DPATH](#) on page 1111

### High Pass Filter 1 to 3 GHz

Activates an additional internal highpass filter for RF input signals from 1 GHz to 3 GHz. This filter is used to remove the harmonics of the analyzer to measure the harmonics for a DUT, for example.

This function requires an additional hardware option.

**Note:** For RF input signals outside the specified range, the high-pass filter has no effect. For signals with a frequency of approximately 4 GHz upwards, the harmonics are suppressed sufficiently by the YIG-preselector, if available.)

Remote command:

[INPut:FILTer:HPASs\[:STATe\]](#) on page 1111

### YIG-Preselector

Enables or disables the YIG-preselector.

An internal YIG-preselector at the input of the FSW ensures that image frequencies are rejected. However, image rejection is only possible for a restricted bandwidth. To use the maximum bandwidth for signal analysis you can disable the YIG-preselector at the input of the FSW, which can lead to image-frequency display.

**Note:** Note that the YIG-preselector is active only on frequencies greater than 8 GHz. Therefore, switching the YIG-preselector on or off has no effect if the frequency is below that value.

To use the optional 90 GHz frequency extension (R&S FSW-B90G), the YIG-preselector must be disabled.

The "YIG-Preselector" is off by default.

**Note:**

For the following measurements, the "YIG-Preselector" is off by default (if available).

- I/Q Analyzer
- All secondary applications in MSRA operating mode
- Real-time (and thus in all secondary applications in MSRT operating mode)

Remote command:

[INPut:FILTer:YIG\[:STATe\]](#) on page 1112

### Preselector Adjust

Activates or deactivates the preselector adjustment.

This function is only available for instrument models FSW43/50/67/85, for frequency sweeps in the Spectrum application.

Generally, sweeps exceeding a certain span use different signal paths to measure the required spectrum. To minimize the hysteresis impact of the YIG preselector at the transition frequencies, you can activate this function. It is applied only when the YIG-preselector is active.

If activated, the FSW automatically performs a short internal adjustment. If you change the frequency or span settings, the adjustment is repeated.

If activated, "PRADJ" is indicated in the window title bar.

Remote command:

[CALibration:PADJust\[:STATe\]](#) on page 1110

### Input Connector

Determines which connector the input data for the measurement is taken from.

For more information on the optional "Analog Baseband" interface, see the FSW I/Q Analyzer and I/Q Input user manual.

- |            |                                                                                                                                                                                                             |
|------------|-------------------------------------------------------------------------------------------------------------------------------------------------------------------------------------------------------------|
| "RF"       | (Default:) The "RF Input" connector                                                                                                                                                                         |
| "RF Probe" | The "RF Input" connector with an adapter for a modular probe<br>This setting is only available if a probe is connected to the "RF Input" connector.<br>It is not available for an active external frontend. |

"Baseband Input 1"      The optional "Baseband Input 1" connector  
 This setting is only available if the optional "Analog Baseband" interface is installed and active for input.  
 It is not available for the FSW67. For FSW85 models with two input connectors, this setting is only available for "Input 1".

Remote command:  
[INPut:CONNector](#) on page 1110

### 7.2.3 Power sensors

The FSW can also analyze data from a connected power sensor.

- [Basics on power sensors](#)..... 367
- [Power sensor settings](#).....368
- [How to work with a power sensor](#)..... 373

#### 7.2.3.1 Basics on power sensors

For precise power measurement, up to 4 power sensors can be connected to the instrument via the power sensor interface (on the front panel) or the USB connectors. Both manual operation and remote control are supported.



For a detailed list of supported sensors, see the specifications document.

Power sensors can also be used to trigger a measurement at a specified power level, e.g. from a signal generator (see "[Using a power sensor as an external power trigger](#)" on page 368).

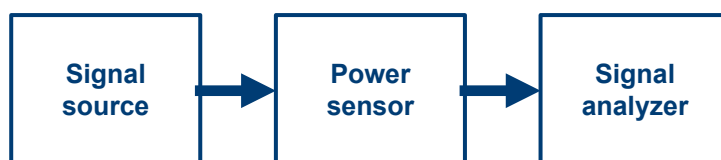

Figure 7-1: Power sensor support – standard test setup



#### Using the power sensor with several applications

The power sensor cannot be used from the FSW firmware and the R&S Power Viewer Plus (virtual power meter for displaying results of the R&S NRP power sensors) simultaneously.

#### Result display

The results of the power sensor measurements are displayed in the marker table. For each power sensor, a row is inserted. The sensor index is indicated in the "Type" column.

2 Marker Table					
Type	Ref	Trc	X-Value	Y-Value	Function Result
PWR1				-70.00 dBm	PWR123456 NRP-Z81
PWR2				-70.00 dBm	PWR111111 NRP-Z11

### Using a power sensor as an external power trigger

Power sensors can be used to trigger a measurement at a specified power level, e.g. from a signal generator. For a list of supported power sensors see the specifications document.

With the FSW, the power sensors can be connected to the "Power Sensor" interface directly, and no further cables are required. They can then be configured as an external power sensor trigger.



Figure 7-2: Connecting a power sensor using the POWER SENSOR interface

The FSW receives an external trigger signal when the defined trigger level is measured by the power sensor. Power measurement results are provided as usual.



The "Gate Mode" Level is not supported for R&S power sensors. The signal sent by these sensors merely reflects the instant the level is first exceeded, rather than a time period. However, only time periods can be used for gating in level mode. Thus, the trigger impulse from the sensors is not long enough for a fully gated measurement; the measurement cannot be completed. For details on gating see [Chapter 7.6.2.1, "Gated measurements"](#), on page 521.

For details see ["How to configure a power sensor as an external \(PSE\) trigger"](#) on page 375.

#### 7.2.3.2 Power sensor settings

**Access:** "Overview" > "Input" > "Power Sensor" tab

Each sensor is configured on a separate tab.



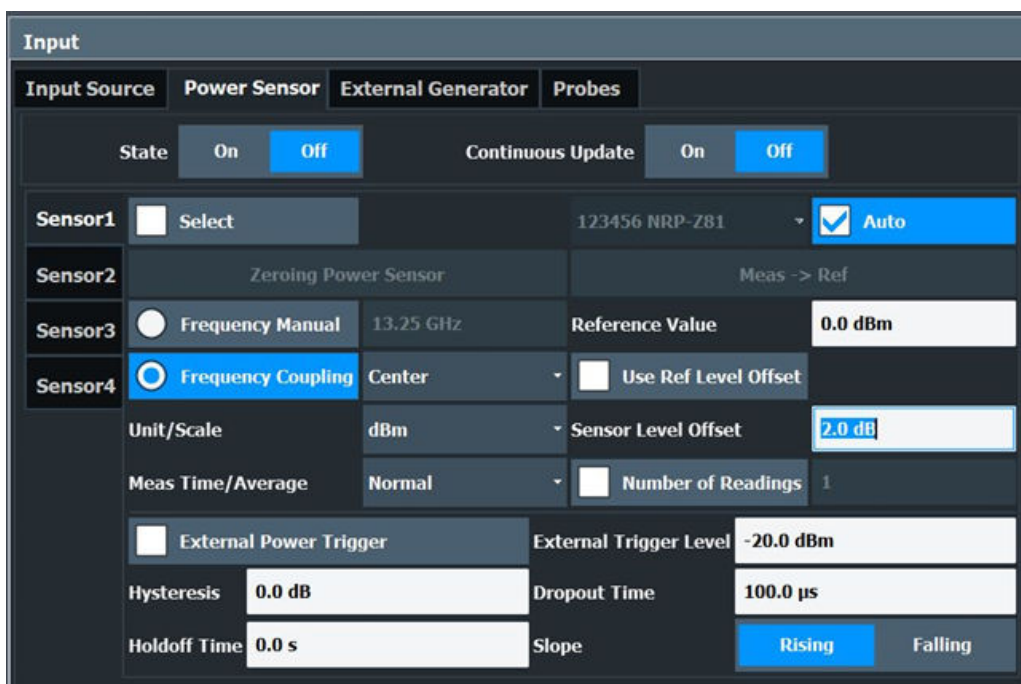

State..... 369

Continuous Value Update..... 370

Select..... 370

Zeroing Power Sensor..... 370

Frequency Manual..... 370

Frequency Coupling..... 370

Unit/Scale..... 371

Meas Time/Average..... 371

Setting the Reference Level from the Measurement Meas -> Ref..... 371

Reference Value..... 371

Use Ref Level Offset..... 371

Sensor Level Offset..... 372

Average Count (Number of Readings)..... 372

Duty Cycle..... 372

Using the power sensor as an external trigger..... 372

- L External Trigger Level..... 372
- L Hysteresis..... 373
- L Trigger Holdoff..... 373
- L Drop-Out Time..... 373
- L Slope..... 373

**State**

Switches the power measurement for all power sensors on or off. Note that in addition to this general setting, each power sensor can be activated or deactivated individually by the [Select](#) setting on each tab. However, the general setting overrides the individual settings.

### Continuous Value Update

If activated, the power sensor data is updated continuously during a sweep with a long sweep time, and even after a single sweep has completed.

This function cannot be activated for individual sensors.

If the power sensor is being used as a trigger (see ["Using the power sensor as an external trigger"](#) on page 372), continuous update is not possible; this setting is ignored.

Remote command:

[\[SENSe:\] PMETer<p>:UPDate\[:STATe\]](#) on page 1183

### Select

Selects the individual power sensor for usage if power measurement is generally activated ([State](#) function).

The detected **serial numbers** of the power sensors connected to the instrument are provided in a selection list. For each of the four available power sensor indexes ("Power Sensor 1"..."Power Sensor 4"), which correspond to the tabs in the configuration dialog, one of the detected serial numbers can be assigned. The physical sensor is thus assigned to the configuration setting for the selected power sensor index.

By default, serial numbers not yet assigned are automatically assigned to the next free power sensor index for which "Auto Assignment" is selected.

Alternatively, you can assign the sensors manually by deactivating the "Auto" option and selecting a serial number from the list.

Remote command:

[\[SENSe:\] PMETer<p>\[:STATe\]](#) on page 1183

[SYSTem:COMMunicate:RDEvice:PMETer<p>:DEFine](#) on page 1177

[SYSTem:COMMunicate:RDEvice:PMETer<p>:CONFigure:AUTO\[:STATe\]](#)  
on page 1176

[SYSTem:COMMunicate:RDEvice:PMETer<p>:COUNT?](#) on page 1177

### Zeroing Power Sensor

Starts zeroing of the power sensor.

For details on the zeroing process refer to ["How to zero the power sensor"](#) on page 374.

Remote command:

[CALibration:PMETer<p>:ZERO:AUTO ONCE](#) on page 1178

### Frequency Manual

Defines the frequency of the signal to be measured. The power sensor has a memory with frequency-dependent correction factors. This allows extreme accuracy for signals of a known frequency.

Remote command:

[\[SENSe:\] PMETer<p>:FREQuency](#) on page 1181

### Frequency Coupling

Selects the coupling option. The frequency can be coupled automatically to the center frequency of the instrument or to the frequency of marker 1.

Remote command:

[SENSe:] PMETer<p>:FREQuency:LINK on page 1181

### Unit/Scale

Selects the unit with which the measured power is to be displayed. Available units are dBm, dB, W and %.

If dB or % is selected, the display is relative to the reference value that is defined with either the "Meas -> Ref" setting or the "Reference Value" setting.

Remote command:

UNIT<n>:PMETer<p>:POWer on page 1184

UNIT<n>:PMETer<p>:POWer:RATio on page 1184

### Meas Time/Average

Selects the measurement time or switches to manual averaging mode. In general, results are more precise with longer measurement times. The following settings are recommended for different signal types to obtain stable and precise results:

"Short"	Stationary signals with high power (> -40dBm), because they require only a short measurement time and short measurement time provides the highest repetition rates.
"Normal"	Signals with lower power or modulated signals
"Long"	Signals at the lower end of the measurement range (<-50 dBm) or Signals with lower power to minimize the influence of noise
"Manual"	Manual averaging mode. The average count is set with the <a href="#">Average Count (Number of Readings)</a> setting.

Remote command:

[SENSe:] PMETer<p>:MTIME on page 1181

[SENSe:] PMETer<p>:MTIME:AVERage[:STATe] on page 1182

### Setting the Reference Level from the Measurement Meas -> Ref

Sets the currently measured power as a reference value for the relative display. The reference value can also be set manually via the [Reference Value](#) setting.

Remote command:

CALCulate<n>:PMETer<p>:RELative[:MAGNitude]:AUTO ONCE on page 1179

### Reference Value

Defines the reference value in dBm used for relative power meter measurements.

Remote command:

CALCulate<n>:PMETer<p>:RELative[:MAGNitude] on page 1178

### Use Ref Level Offset

If activated, takes the reference level offset defined for the analyzer into account for the measured power (see "[Shifting the Display \(Offset\)](#)" on page 485).

If deactivated, takes the [Sensor Level Offset](#) into account.

Remote command:

[SENSe:] PMETer<p>:ROFFset[:STATe] on page 1182

**Sensor Level Offset**

Takes the specified offset into account for the measured power. Only available if [Use Ref Level Offset](#) is disabled.

Remote command:

[\[SENSe:\] PMETer<p>:SOFFset](#) on page 1183

**Average Count (Number of Readings)**

Defines the number of readings (averages) to be performed after a single sweep has been started. This setting is only available if manual averaging is selected ([Meas Time/Average](#) setting).

The values for the average count range from 0 to 256 in binary steps (1, 2, 4, 8, ...). For average count = 0 or 1, one reading is performed. The general averaging and sweep count for the trace are independent from this setting.

Results become more stable with extended average, particularly if signals with low power are measured. This setting can be used to minimize the influence of noise in the power sensor measurement.

Remote command:

[\[SENSe:\] PMETer<p>:MTIME:AVERage:COUNT](#) on page 1182

**Duty Cycle**

Sets the duty cycle to a percent value for the correction of pulse-modulated signals and activates the duty cycle correction. With the correction activated, the sensor calculates the signal pulse power from this value and the mean power.

Remote command:

[\[SENSe:\] PMETer<p>:DCYCLE\[:STATe\]](#) on page 1180

[\[SENSe:\] PMETer<p>:DCYCLE:VALue](#) on page 1180

**Using the power sensor as an external trigger**

If activated, the power sensor creates a trigger signal when a power higher than the defined "External Trigger Level" is measured. This trigger signal can be used as an external power trigger by the FSW.

This setting is only available in conjunction with a compatible power sensor.

For details on using a power sensor as an external trigger, see ["Using a power sensor as an external power trigger"](#) on page 368.

Remote command:

[\[SENSe:\] PMETer<p>:TRIGger\[:STATe\]](#) on page 1186

[TRIG:SOUR PSE](#), see [TRIGger\[:SEQuence\]:SOURce](#) on page 1221

**External Trigger Level ← Using the power sensor as an external trigger**

Defines the trigger level for the power sensor trigger.

For details on supported trigger levels, see the specifications document.

Remote command:

[\[SENSe:\] PMETer<p>:TRIGger:LEVel](#) on page 1186

**Hysteresis ← Using the power sensor as an external trigger**

Defines the distance in dB to the trigger level that the trigger source must exceed before a trigger event occurs. Setting a hysteresis avoids unwanted trigger events caused by noise oscillation around the trigger level.

Remote command:

[\[SENSe:\] PMETer<p>:TRIGger:HYSteresis](#) on page 1185

**Trigger Holdoff ← Using the power sensor as an external trigger**

Defines the minimum time (in seconds) that must pass between two trigger events. Trigger events that occur during the holdoff time are ignored.

Remote command:

[\[SENSe:\] PMETer<p>:TRIGger:HOLDoff](#) on page 1185

**Drop-Out Time ← Using the power sensor as an external trigger**

Defines the time the input signal must stay below the trigger level before triggering again.

**Slope ← Using the power sensor as an external trigger**

Defines whether triggering occurs when the signal rises to the trigger level or falls down to it.

Remote command:

[\[SENSe:\] PMETer<p>:TRIGger:SLOPe](#) on page 1186

### 7.2.3.3 How to work with a power sensor

The following step-by-step instructions demonstrate how to set up a power sensor. For details on individual functions and settings see [Chapter 7.2.3.2, "Power sensor settings"](#), on page 368.

The remote commands required to perform these tasks are described in [Chapter 13.7.1.8, "Working with power sensors"](#), on page 1176.



Power sensors can also be used to trigger a measurement at a specified power level, e.g. from a signal generator.

This is described in ["How to configure a power sensor as an external \(PSE\) trigger"](#) on page 375.

#### How to set up a power sensor

Up to 4 external power sensors can be configured separately and used for precise power measurement. All power sensors can be activated and deactivated individually.

The following procedure describes in detail how to configure and activate power sensors.

1. To display the "Power Sensor" tab of the "Input" dialog box, do one of the following:
  - Select "Input" from the "Overview".
  - Select [INPUT/OUTPUT] and then "Power Sensor Config".

2. Select the tab for the power sensor index you want to configure, e.g. "Power Sensor 1".
3. Press "Select" to analyze the power sensor data according to the current configuration when power measurement is activated.
4. From the selection list with serial numbers of connected power sensors, select the sensor you want to configure.  
To have newly connected power sensors assigned to a tab automatically (default), select "Auto".
5. Define the frequency of the signal whose power you want to measure.
  - a) To define the frequency manually, select "Frequency Manual" and enter a frequency.
  - b) To determine the frequency automatically, select "Frequency Coupling" and then either "Center", to use the center frequency, or "Marker", to use the frequency defined by marker 1.
6. Select the unit for the power result display.
7. Select the measurement time for which the average is calculated, or define the number of readings to average. To define the number of readings to be taken into account manually, select "Manual" and enter the number in the "Number of Readings" field.
8. To activate the duty cycle correction, select "DutyCycle" and enter a percentage as the correction value.
9. If you selected "dB" or "%" as units (relative display), define a reference value:
  - a) To set the currently measured power as a reference value, press "Meas -> Ref".
  - b) Alternatively, enter a value manually in the "Reference Value" field.
  - c) Optionally, select the "Use Ref Level Offset" option to take the reference level offset set for the analyzer into account for the measured power.
10. To use the power sensor as an external power trigger, select the "External Power Trigger" option and define the trigger settings.  
For details see ["How to configure a power sensor as an external \(PSE\) trigger"](#) on page 375.
11. If necessary, repeat steps 3-10 for another power sensor.
12. Set the "Power Sensor State" at the top of the "Power Sensor" tab to "On" to activate power measurement for the selected power sensors.  
  
The results of the power measurement are displayed in the marker table (Function: "Sensor <1...4>").

### How to zero the power sensor

1. To display the "Power Sensor" tab of the "Input" dialog box, do one of the following:

- Select "Input" from the "Overview".
  - Select [INPUT/OUTPUT] and then "Power Sensor Config".
2. Select the tab that is assigned to the power sensor you want to zero.
  3. Press "Zeroing Power Sensor".  
A dialog box is displayed that prompts you to disconnect all signals from the input of the power sensor.
  4. Disconnect all signals sending input to the power sensor and press [ENTER] to continue.
  5. Wait until zeroing is complete.  
A corresponding message is displayed.

### How to configure a power sensor as an external (PSE) trigger

The following step-by-step instructions demonstrate how to configure a power sensor to be used as an external power sensor trigger.

#### To configure a power sensor as an external power sensor (PSE) trigger

1. Connect a compatible power sensor to the "Power Sensor" interface on the front panel of the FSW. (For details on supported sensors see ["Using a power sensor as an external power trigger"](#) on page 368).
2. Set up the power sensor as described in ["How to set up a power sensor"](#) on page 373.
3. In the "Power Sensor" tab of the "Input" dialog box, select the "External Power Trigger" option.
4. Enter the power level at which a trigger signal is to be generated ("External Trigger Level") and the other trigger settings for the power sensor trigger.
5. Press [TRIG] and then select "Trigger/ Gate Config".
6. In the "Trigger And Gate" dialog box, select "Signal Source" = "PSE".

The FSW is configured to trigger when the defined conditions for the power sensor occur. Power measurement results are provided as usual.

## 7.2.4 Optional external generator control

If the FSW optional External Generator Control is installed, you can operate various commercially available generators as an external generator with the FSW. Thus, scalar network analysis with the FSW is possible.

- [About external generator control](#).....376
- [Basics on external generator control](#).....376
- [External generator control settings](#)..... 385
- [How to work with external generator control](#).....393
- [Measurement example: calibration with an external generator](#)..... 396

### 7.2.4.1 About external generator control

A common measurement setup includes a signal generator, a device under test (DUT), and a signal and spectrum analyzer, for example the FSW. In this setup, the signal analyzer can control which signal the generator is to send, which is in turn measured by the analyzer. This process is referred to as *external generator control*. The generator in this setup is referred to as a *tracking generator*.

A measurement with a tracking generator is useful to measure any effects on the power level caused by the cables and connectors from the signal generator and the signal analyzer in advance. The known effects can then be removed from the measurement results to obtain accurate information on the DUT.

### 7.2.4.2 Basics on external generator control

Some background knowledge on basic terms and principles used for external generator control is provided here for a better understanding of the required configuration settings.



External generator control is only available in the following applications.

- Spectrum Analyzer
- I/Q Analyzer
- Analog Demodulation
- Noise Figure Measurements

• <a href="#">External generator connections</a> .....	376
• <a href="#">Generator setup files</a> .....	379
• <a href="#">Calibration mechanism</a> .....	379
• <a href="#">Normalization</a> .....	380
• <a href="#">Reference trace, reference line and reference level</a> .....	381
• <a href="#">Coupling the frequencies</a> .....	382
• <a href="#">Displayed information and errors</a> .....	384

#### External generator connections

The external generator is controlled either via a LAN connection or via the EXT. GEN. CONTROL GPIB interface of the FSW supplied with the option.

For more information on configuring interfaces, see [Chapter 12.1, "Remote control interfaces and protocols"](#), on page 816.

#### TTL synchronization

In addition, TTL synchronization can be used with some Rohde & Schwarz generators connected via GPIB. The TTL interface is included in the AUX control connector of the External Generator Control option.





Using the TTL interface allows for considerably higher measurement rates than pure GPIB control, because the frequency stepping of the FSW is directly coupled with the frequency stepping of the generator. For details see ["Coupling the frequencies"](#) on page 382.

In [Figure 7-3](#) the TTL connection is illustrated using an R&S SMA100B generator, for example.

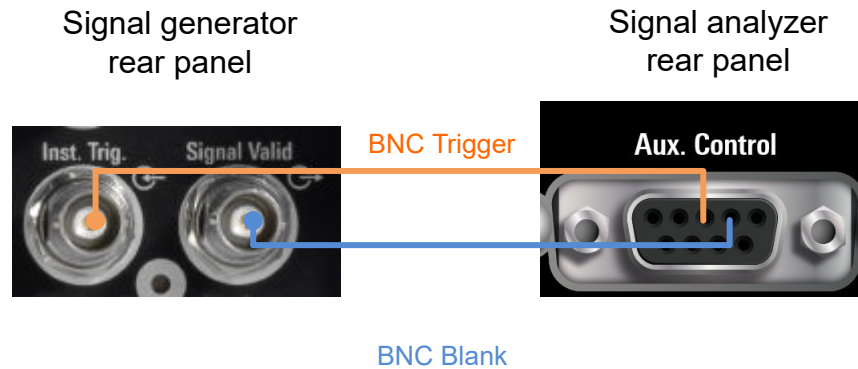

*Figure 7-3: TTL connection for an R&S SMA100B generator*

In [Figure 7-4](#) the TTL connection is illustrated using an R&S SMU generator, for example.

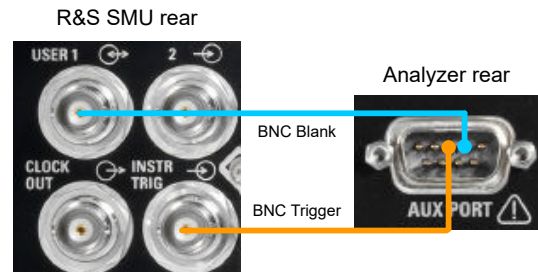

*Figure 7-4: TTL connection for an R&S SMU generator*

In [Figure 7-5](#) the TTL connection for an R&S SMW is shown.

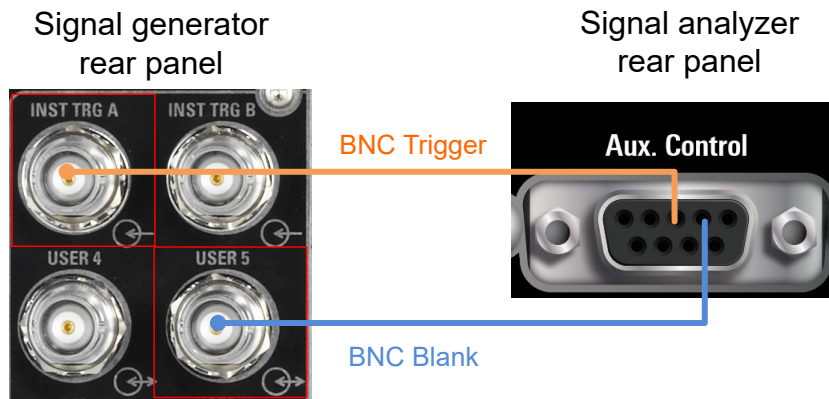

Figure 7-5: TTL connection for an R&S SMW generator

The external generator can be used to calibrate the data source by performing either transmission or reflection measurements.

**Transmission Measurement**

This measurement yields the transmission characteristics of a two-port network. The external generator is used as a signal source. It is connected to the input connector of the DUT. The input of the FSW is fed from the output of the DUT. A calibration can be carried out to compensate for the effects of the test setup (e.g. frequency response of connecting cables).

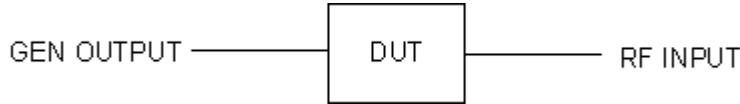

Figure 7-6: Test setup for transmission measurement

**Reflection Measurement**

Scalar reflection measurements can be carried out using a reflection-coefficient measurement bridge.

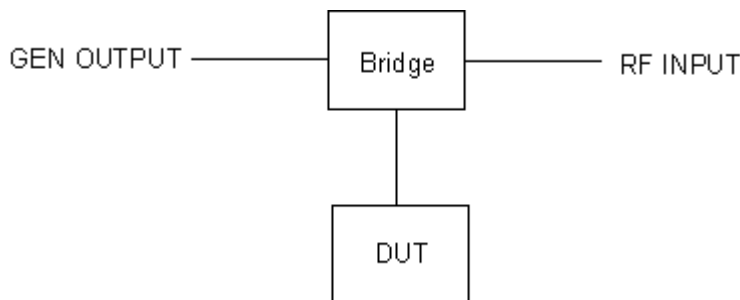

Figure 7-7: Test setup for reflection measurement

### Generated signal input

To use the functions of the external generator, an appropriate generator must be connected and configured correctly. In particular, the generator output must be connected to the RF input of the FSW.

### External reference frequency

To enhance measurement accuracy, use a common reference frequency for both the FSW and the generator. If no independent 10 MHz reference frequency is available, connect the reference output of the generator with the reference input of the FSW. Enable usage of the external reference on the FSW via "SETUP" > "Reference" > "External Reference".

For more information on external references, see [Chapter 11.6, "Reference frequency settings"](#), on page 779.

### Connection errors

If no external generator is connected, if the connection address is not correct, or the generator is not ready for operation, an error message is displayed (e.g. "Ext. Generator TCP/IP Handshake Error!", see ["Displayed information and errors"](#) on page 384).

### Generator setup files

For each signal generator type to be controlled by the FSW, configure a generator setup file and store it on the FSW. The setup file defines the frequency and power ranges supported by the generator, and information required for communication. For the signal generators listed in the specifications document, default setup files are provided. If necessary, you can edit or duplicate these files for varying measurement setups or other instruments.

You can display the existing setup files in an editor in read-only mode directly from the "External Generator" configuration dialog box. From there, you can edit them and store them under a different name. Then they are available on the FSW.

(For details see ["How to define a new generator setup file"](#) on page 393).

### Calibration mechanism

A common measurement setup includes a signal generator, a device under test (DUT), and a signal and spectrum analyzer. Therefore, it is useful to measure the attenuation or gain caused by the cables and connectors from the signal generator and the signal analyzer in advance. The known level offsets can then be removed from the measurement results to obtain accurate information on the DUT.

Calculating the difference between the currently measured power and a reference trace is referred to as *calibration*. Thus, the measurement results from the controlled external generator - including the inherent distortions - can be used as a reference trace to calibrate the measurement setup.

The inherent frequency and power level distortions can be determined by connecting the FSW to the signal generator. The FSW sends a predefined list of frequencies to the signal generator (see also ["Coupling the frequencies"](#) on page 382). The signal generator then sends a signal with the specified level at each frequency in the predefined

list. The FSW measures the signal and determines the level offsets to the expected values.

### Saving calibration results

A reference dataset for the calibration results is stored internally as a table of value pairs (frequency/level), one for each sweep point. The measured offsets can then be used as calibration factors for subsequent measurement results. The calibration data can also be stored permanently with the instrument settings using the "Save" function in the toolbar.

The calibration can be performed using either transmission or reflection measurements. The selected type of measurement used to determine the reference trace is included in the reference dataset.

### Normalization

Once the measurement setup has been calibrated and the reference trace is available, subsequent measurement results can be corrected according to the calibration factors, if necessary. Results are corrected by subtracting the reference trace from the measurement results. This process is referred to as *normalization* and can be activated or deactivated as required. If normalization is activated, "NOR" is displayed in the channel bar, next to the indication that an external generator is being used ("Ext.Gen"). The normalized trace from the calibration sweep is a constant 0 dB line, as  $\langle \text{calibration trace} \rangle - \langle \text{reference trace} \rangle = 0$ .

*As long as the same settings are used for measurement as for calibration*, the normalized measurement results should not contain any inherent frequency or power distortions. Thus, the measured DUT values are very accurate.

### Approximate normalization

As soon as any of the calibration measurement settings are changed, the stored reference trace is longer identical to the new measurement results. However, if the measurement settings do not deviate too much, the measurement results can still be normalized *approximately* using the stored reference trace. An "APX" label in the channel bar (instead of "NOR") indicates the approximated normalization.

Approximation is necessary if one or more of the following values deviate from the calibration settings:

- Coupling (RBW, VBW, SWT)
- Reference level, RF attenuation
- Start or stop frequency
- Output level of external generator
- Detector (max. peak, min. peak, sample, etc.)
- Frequency deviation at a maximum of 1001 points within the set sweep limits (corresponds to a doubling of the span)

Differences in level settings between the reference trace and the current instrument settings are considered automatically. If the span is reduced, a linear interpolation of the intermediate values is applied. If the span increases, the values at the left or right

border of the reference dataset are extrapolated to the current start or stop frequency. The reference dataset is extended by constant values.

Thus, you can change various instrument settings without giving up normalization. The necessity to carry out a new normalization is reduced to a minimum.

### The normalized trace in the display

The normalized reference trace is also displayed in the spectrum diagram, by default at the top of the diagram (= 100% of the window height). It is indicated by a red line labeled "NOR", followed by the current reference value. However, it can be shifted vertically to reflect an attenuation or gain caused by the measured DUT (see also "[Shifting the reference line \(and normalized trace\)](#)" on page 382).

### Restoring the calibration settings

If the measurement settings no longer match the instrument settings with which the calibration was performed (indicated by the "APX" or no label next to "Ext.TG" in the channel bar), you can restore the calibration settings, which are stored with the reference dataset on the FSW.

### Storing the normalized reference trace as a transducer factor

The (inverse) normalized reference trace can also be stored as a *transducer factor* for use in other FSW applications that do not support external generator control.

The normalized trace data is converted to a transducer with unit dB and stored in a file with the specified name and the suffix `.trd` under `c:\r_s\instr\trd`. The frequency points are allocated in equidistant steps between the start and stop frequency.

Transducer factors are useful, for example, to determine the effects of a particular device component and then remove these effects from a subsequent measurement which includes this component.

For an example, see "[How to remove the effects of a particular component from measurement results using calibration](#)" on page 395.



Note that the *normalized* measurement data is stored, not the original *reference* trace. Thus, if you store the normalized trace directly after calibration, without changing any settings, the transducer factor is 0 dB for the entire span (by definition of the normalized trace).

## Reference trace, reference line and reference level

### Reference trace

The calibration results are stored internally on the FSW as a *reference trace*. For each measured sweep point, the offset to the expected values is determined. If normalization is activated, the offsets in the reference trace are removed from the current measurement results to compensate for the inherent distortions.

### Reference line

The reference line is defined by the [Reference Value](#) and [Reference Position](#) in the "External Generator" > "Source Calibration" settings. It is similar to the [Reference Level](#) defined in the "Amplitude" settings. However, as opposed to the reference *level*, this reference *line* only affects the y-axis scaling in the diagram. It has no effect on the expected input power level or the hardware settings.

The reference line determines the range and the scaling of the y-axis, just as the reference level does.

The normalized reference trace (0 dB directly after calibration) is displayed on this reference line, indicated by a red line in the diagram. By default, the reference line is displayed at the top of the diagram. If you shift the reference line, the normalized trace is shifted, as well.

### Shifting the reference line (and normalized trace)

You can shift the reference line - and thus the normalized trace - in the result display by changing the [Reference Position](#) or the [Reference Value](#).

If the DUT inserts a gain or an attenuation in the measurement, this effect can be reflected in the result display on the FSW. To reflect a power offset in the measurement trace, change the [Reference Value](#).

For a detailed example, see [Chapter 7.2.4.5, "Measurement example: calibration with an external generator"](#), on page 396.

### Coupling the frequencies

As described in ["Normalization"](#) on page 380, normalized measurement results are very accurate *as long as the same settings are used as for calibration*. Although approximate normalization is possible, it is important to consider the required frequencies for calibration in advance. The frequencies and levels supported by the connected signal generator are provided for reference with the interface configuration.

Frequency coupling means that the generator frequency and the frequency of the FSW are the same.

- **Manual coupling:** a single frequency is defined
- **Automatic coupling:** a series of frequencies is defined (one for each sweep point), based on the current frequency at the RF input of the FSW. The RF frequency range covers the currently defined span of the FSW (unless limited by the range of the signal generator).

### Automatic coupling

If automatic coupling is used, the output frequency of the generator (source frequency) is calculated as follows:

$$F_{\text{Generator}} = \left| F_{\text{Analyzer}} * \frac{\text{Numerator}}{\text{Denominator}} + F_{\text{Offset}} \right|$$

Equation 7-1: Output frequency of the generator

Where:

$F_{\text{Generator}}$  = output frequency of the generator

$F_{\text{Analyzer}}$  = current frequency at the RF input of the FSW

Numerator = multiplication factor for  $F_{\text{Analyzer}}$

Denominator = division factor for  $F_{\text{Analyzer}}$

$F_{\text{Offset}}$  = frequency offset for  $F_{\text{Analyzer}}$ , for example for frequency-converting measurements or harmonics measurements

The value range for the offset depends on the selected generator. The default setting is 0 Hz. Offsets other than 0 Hz are indicated by the "FRQ" label in the channel bar (see also ["Displayed information and errors"](#) on page 384).

### Swept frequency range

The  $F_{\text{Analyzer}}$  values for the calibration sweep start with the start frequency and end with the stop frequency defined in the "Frequency" settings of the FSW. The resulting output frequencies ([Result Frequency Start](#) and [Result Frequency Stop](#)) are displayed in "External Generator" > "Measurement Configuration" for reference.

If the resulting frequency range exceeds the allowed ranges of the signal generator, an error message is displayed (see ["Displayed information and errors"](#) on page 384). The [Result Frequency Start](#) and [Result Frequency Stop](#) values are corrected to comply with the range limits.



The calibration sweep nevertheless covers the entire span defined by the FSW. However, no input is received from the generator outside the generator's defined limits.

### TTL synchronization

Some Rohde & Schwarz signal generators support TTL synchronization when connected via GPIB. The TTL interface is included in the AUX control connector of the External Generator Control option.

When pure GPIB connections are used between the FSW and the signal generator, the FSW sets the generator frequency for each frequency point individually via GPIB. Only when the setting procedure is finished, the FSW can measure the next sweep point.

For generators with a TTL interface, the FSW sends a list of the frequencies to be set to the generator before the beginning of the first sweep. Then the FSW starts the sweep and the next frequency point is selected by both the FSW and the generator using the TTL handshake line "TRIGGER". The FSW can only measure a value when the generator signals the end of the setting procedure via the "BLANK" signal.

Using the TTL interface allows for considerably higher measurement rates, because the frequency stepping of the FSW is directly coupled with the frequency stepping of the generator.

### Reverse sweep

The frequency offset for automatic coupling can be used to sweep in the reverse direction. To do so, define a negative offset in the external generator measurement configuration. (Note that the frequency is defined as the unsigned value of the equation, thus a negative frequency is not possible.)

#### Example: Example for reverse sweep

$$F_{\text{AnalyzerStart}} = 100 \text{ MHz}$$

$$F_{\text{AnalyzerStop}} = 200 \text{ MHz}$$

$$F_{\text{Offset}} = -300 \text{ MHz}$$

$$\text{Numerator} = \text{Denominator} = 1$$

$$\rightarrow F_{\text{GeneratorStart}} = 200 \text{ MHz}$$

$$\rightarrow F_{\text{GeneratorStop}} = 100 \text{ MHz}$$

If the offset is adjusted so that the sweep of the generator crosses the minimum generator frequency, a message is displayed in the status bar ("Reverse Sweep via min. Ext. Generator Frequency!").

#### Example: Example for reverse sweep via minimum frequency

$$F_{\text{AnalyzerStart}} = 100 \text{ MHz}$$

$$F_{\text{AnalyzerStop}} = 200 \text{ MHz}$$

$$F_{\text{Offset}} = -150 \text{ MHz}$$

$$F_{\text{min}} = 20 \text{ MHz}$$

$$\text{Numerator} = \text{Denominator} = 1$$

$$\rightarrow F_{\text{GeneratorStart}} = 50 \text{ MHz}$$

$$\rightarrow F_{\text{GeneratorStop}} = 50 \text{ MHz via } F_{\text{min}}$$

### Displayed information and errors

#### Channel bar

If external generator control is active, some additional information is displayed in the channel bar.

Label	Description
EXT TG: <source power>	External generator active; signal sent with <source power> level
LVL	Power Offset (see " <a href="#">Source Offset</a> " on page 387)
FRQ	Frequency Offset (see " <a href="#">(Automatic) Source Frequency (Numerator/Denominator/Offset)</a> " on page 387)
NOR	Normalization on; No difference between reference setting and measurement



Label	Description
APX (approximation)	Normalization on; Deviation from the reference setting occurs
-	Aborted normalization or no calibration performed yet

### Error and status messages

The following status and error messages can occur during external generator control.

Message	Description
"Ext. Generator GPIB Handshake Error!" / "Ext. Generator TCPIP Handshake Error!" / "Ext. Generator TTL Handshake Error!"	Connection to the generator is not possible, e.g. due to a cable damage or loose connection or wrong address.
"Ext. Generator Limits Exceeded!"	The allowed frequency or power ranges for the generator were exceeded.
"Reverse Sweep via min. Ext. Generator Frequency!"	Reverse sweep is performed; frequencies are reduced to the minimum frequency, then increased again; see <a href="#">"Reverse sweep"</a> on page 384.
"Ext. Generator File Syntax Error!"	Syntax error in the generator setup file (see <a href="#">"Generator setup files"</a> on page 379)
"Ext. Generator Command Error!"	Missing or wrong command in the generator setup file (see <a href="#">"Generator setup files"</a> on page 379)
"Ext. Generator Visa Error!"	Error with Visa driver provided with installation (very unlikely)

## NOTICE

### Overloading

At a reference level of -10 dBm and at an external generator output level of the same value, the FSW operates without overrange reserve. That means the FSW is in danger of being overloaded if a signal is applied whose amplitude is higher than the reference line. In this case, either the message "RF OVLD" for overload or "OVLD" for exceeded display range (clipping of the trace at the upper diagram border = overrange) is displayed in the status line.

Overloading can be avoided as follows:

- Reducing the output level of the external generator (["Source Power"](#) on page 387 in "External Generator > Measurement Configuration")
- Increasing the reference level ([Reference Level](#) in the "Amplitude" menu)

#### 7.2.4.3 External generator control settings

**Access:** [INPUT/OUTPUT] > "External Generator Config"

The "External Generator" settings are available if the FSW External Generator Control option is installed. For each measurement channel, you can configure one external

generator. To switch between different configurations, define multiple measurement channels.

For more information on external generator control, see [Chapter 7.2.4.2, "Basics on external generator control"](#), on page 376.

- [Measurement settings](#).....386
- [Interface configuration settings](#).....388
- [Source calibration functions](#).....390

**Measurement settings**

**Access:** [INPUT/OUPUT] > "External Generator Config" > "Measurement Configuration" tab

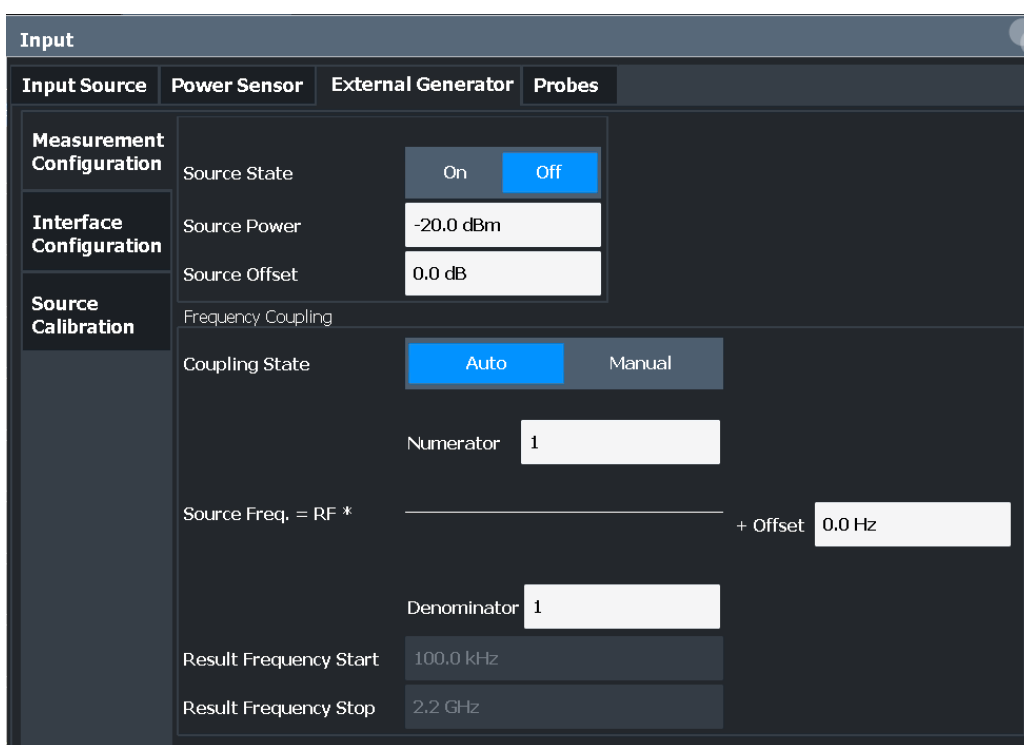

- [Source State](#)..... 386
- [Source Power](#).....387
- [Source Offset](#)..... 387
- [Source Frequency Coupling](#).....387
- [\(Manual\) Source Frequency](#).....387
- [\(Automatic\) Source Frequency \(Numerator/Denominator/Offset\)](#)..... 387
- [Result Frequency Start](#)..... 388
- [Result Frequency Stop](#).....388

**Source State**

Activates or deactivates control of an external generator.

Remote command:

`SOURce<si>:EXTernal<gen>[:STATe]` on page 1168

**Source Power**

The output power of the external generator. The default output power is -20 dBm. The range is specified in the specifications document.

Remote command:

`SOURce<si>:EXternal<gen>:POWer[:LEVel]` on page 1168

**Source Offset**

Constant level offset for the external generator. Values from -200 dB to +200 dB in 1 dB steps are allowed. The default setting is 0 dB. Offsets are indicated by the "LVL" label in the channel bar (see also "[Displayed information and errors](#)" on page 384).

Using this offset, attenuators or amplifiers at the output connector of the external generator can be considered. This is useful, for example, for the displayed output power values on screen or during data entry. Positive offsets apply to an amplifier, while negative offsets apply to an attenuator after the external generator.

Remote command:

`SOURce<si>:POWer[:LEVel][:IMMediate]:OFFSet` on page 1169

**Source Frequency Coupling**

Defines the frequency coupling mode between the FSW and the generator.

For more information on coupling frequencies, see "[Coupling the frequencies](#)" on page 382.

"Auto" Default setting: a series of frequencies is defined (one for each sweep point), based on the current frequency at the RF input of the FSW (see "[\(Automatic\) Source Frequency \(Numerator/Denominator/Offset\)](#)" on page 387). The RF frequency range covers the currently defined span of the FSW (unless limited by the range of the signal generator).

"Manual" The generator uses a single fixed frequency, defined by [\(Manual\) Source Frequency](#) which is displayed when you select "Manual" coupling.

Remote command:

`SOURce<si>:EXternal<gen>:FREQuency:COUPling[:STATe]` on page 1166

**(Manual) Source Frequency**

Defines the fixed frequency to be used by the generator.

Remote command:

`SOURce<si>:EXternal<gen>:FREQuency` on page 1165

**(Automatic) Source Frequency (Numerator/Denominator/Offset)**

With automatic frequency coupling, a series of frequencies is defined (one for each sweep point), based on the current frequency at the RF input of the FSW.

However, the frequency used by the generator can differ from the input from the FSW. The RF frequency can be multiplied by a specified factor, or a frequency offset can be added, or both.

**Note:** The input for the generator frequency is not validated, i.e. you can enter any values. However, if the allowed frequency ranges of the generator are exceeded, an error

message is displayed on the FSW. The values for [Result Frequency Start](#) and [Result Frequency Stop](#) are corrected to comply with the range limits.

The value range for the offset depends on the selected generator. The default setting is 0 Hz. Offsets  $\neq$  0 Hz are indicated by the "FRQ" label in the channel bar. Negative offsets can be used to define reverse sweeps.

For more information on coupling frequencies and reverse sweeps, see ["Coupling the frequencies"](#) on page 382. For more information on error messages and the channel bar, see ["Displayed information and errors"](#) on page 384.

Remote command:

`SOURce<si>:EXTernal<gen>:FREQuency[:FACTor]:DENominator`

on page 1166

`SOURce<si>:EXTernal<gen>:FREQuency[:FACTor]:NUMerator` on page 1167

`SOURce<si>:EXTernal<gen>:FREQuency:OFFSet` on page 1167

**Result Frequency Start**

For reference only: The start frequency for the generator, calculated from the configured generator frequency and the start value defined for the FSW.

**Result Frequency Stop**

For reference only: The stop frequency for the generator, calculated from the configured generator frequency and the stop value defined for the FSW.

**Interface configuration settings**

**Access:** [INPUT/OUPUT] > "External Generator Config" > "Interface Configuration" tab

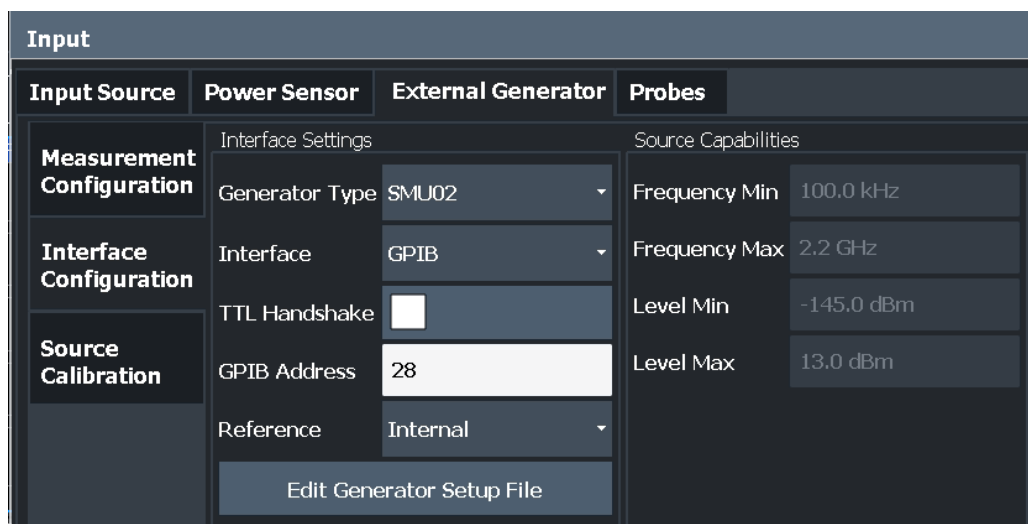

For more information on configuring interfaces, see [Chapter 12.1, "Remote control interfaces and protocols"](#), on page 816.

[Generator Type](#)..... 389

[Interface](#)..... 389

[TTL Handshake](#)..... 389

[GPIB Address/TCPIP Address / Computer Name](#)..... 389

[Reference](#)..... 389

<a href="#">Edit Generator Setup File.....</a>	390
<a href="#">Frequency Min/ Frequency Max.....</a>	390
<a href="#">Level Min/ Level Max.....</a>	390

### Generator Type

Selects the generator type and thus defines the generator setup file to use.

For an overview of supported generators, see the specifications document. For information on generator setup files, see "[Generator setup files](#)" on page 379.

Remote command:

[SYSTem:COMMunicate:RDEvice:GENerator<gen>:TYPE](#) on page 1171

### Interface

Type of interface connection used.

For details on which signal generators support which interfaces, see the documentation of the corresponding signal generator.

- GPIB
- TCP/IP

Remote command:

[SYSTem:COMMunicate:RDEvice:GENerator<gen>:INTerface](#) on page 1170

### TTL Handshake

If available for the specified generator type, this option activates TTL synchronization via handshake.

Using the TTL interface allows for considerably higher measurement rates, because the frequency stepping of the FSW is directly coupled with the frequency stepping of the generator.

For more information on TTL synchronization, see "[TTL synchronization](#)" on page 383.

Remote command:

[SYSTem:COMMunicate:RDEvice:GENerator<gen>:LINK](#) on page 1170

### GPIB Address/TCP/IP Address / Computer Name

For LAN connections: TCP/IP address of the signal generator

For GPIB connections: GPIB address of the signal generator.

Remote command:

[SYSTem:COMMunicate:GPIB:RDEvice:GENerator<gen>:ADDRESS](#) on page 1170

[SYSTem:COMMunicate:TCPIP:RDEvice:GENerator<gen>:ADDRESS](#)

on page 1171

### Reference

Selects the internal FSW or an external frequency reference to synchronize the FSW with the generator (default: internal).

Remote command:

[SOURce<si>:EXTernal<gen>:ROSCillator\[:SOURce\]](#) on page 1169

**Edit Generator Setup File**

Displays the setup file for the currently selected [Generator Type](#) in read-only mode in an editor.

Although the existing setup files are displayed in read-only mode in the editor, they can be saved under a different name (using "File > SaveAs").

Be careful, however, to adhere to the required syntax and commands. Errors are only detected and displayed when you try to use the new generator (see also "[Displayed information and errors](#)" on page 384).

For details, see "[Generator setup files](#)" on page 379.

**Frequency Min/ Frequency Max**

For reference only: Lower and upper frequency limit for the generator.

**Level Min/ Level Max**

For reference only: Lower and upper power limit for the generator.

**Source calibration functions**

**Access:** [INPUT/OUTPUT] > "External Generator Config" > "Source Calibration" tab

The calibration functions of the external generator are available *only if external generator control is active* (see "[Source State](#)" on page 386).

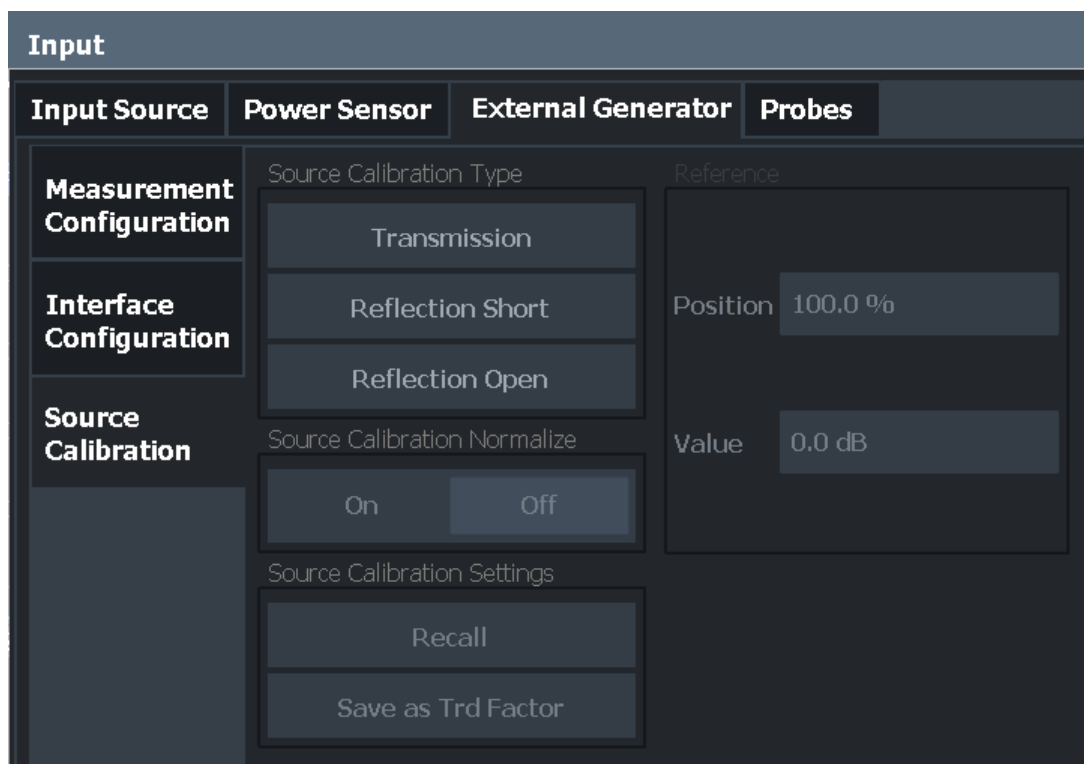

[Calibrate Transmission](#).....391

[Calibrate Reflection Short](#)..... 391

[Calibrate Reflection Open](#)..... 391

[Normalization state](#)..... 391

Recall Cal. Settings.....	391
Save as Trd Factor.....	392
Reference Position.....	392
Reference Value.....	392

### Calibrate Transmission

Starts a transmission type measurement to determine a reference trace. This trace is used to calculate the difference for the normalized values.

Remote command:

`[SENSe:]CORRection:MEtHod` on page 1173

### Calibrate Reflection Short

Starts a short-circuit reflection type measurement to determine a reference trace for calibration.

If both calibrations (open circuit, short circuit) are carried out, the calibration trace is calculated by averaging the two measurements. The order of the two calibration measurements is irrelevant.

Remote command:

`[SENSe:]CORRection:MEtHod` on page 1173

Selects the reflection method.

`[SENSe:]CORRection:COLLect[:ACQuire]` on page 1172

Starts the sweep for short-circuit calibration.

### Calibrate Reflection Open

Starts an open-circuit reflection type measurement to determine a reference trace for calibration.

If both reflection-type calibrations (open circuit, short circuit) are carried out, the reference trace is calculated by averaging the two measurements. The order of the two calibration measurements is irrelevant.

Remote command:

`[SENSe:]CORRection:MEtHod` on page 1173

Selects the reflection method.

`[SENSe:]CORRection:COLLect[:ACQuire]` on page 1172

Starts the sweep for open-circuit calibration.

### Normalization state

Switches the normalization of measurement results on or off. This function is only available if the memory contains a reference trace, that is, after a calibration has been performed.

For details on normalization, see "[Normalization](#)" on page 380.

Remote command:

`[SENSe:]CORRection[:STATe]` on page 1174

### Recall Cal. Settings

Restores the settings that were used during source calibration. This can be useful if instrument settings were changed after calibration (e.g. center frequency, frequency deviation, reference level, etc.).

Remote command:

[\[SENSe:\]CORRection:RECall](#) on page 1173

### Save as Trd Factor

Uses the normalized measurement data to generate a transducer factor. The trace data is converted to a transducer with unit dB and stored in a file with the specified name and the suffix `.trd` under

`C:\Program Files (x86)\Rohde-Schwarz\FSW\<version>\trd`. The frequency points are allocated in equidistant steps between start and stop frequency.

The generated transducer factor can be further adapted using the "Transducer" function in the [Setup] menu.

For more information on transducers, see [Chapter 11.4.1, "Basics on transducer factors"](#), on page 754.

**Note:** Note that the *normalized* measurement data is used, not the *reference* trace! Thus, if you store the normalized trace directly after calibration, without changing any settings, the transducer factor is 0 dB for the entire span (by definition of the normalized trace).

Remote command:

[\[SENSe:\]CORRection:TRANsdruce:GENerate](#) on page 1174

### Reference Position

Defines the position of the reference line in percent of the total y-axis range.

The top of the diagram is 100%, the bottom is 0%. By default, the 0 dB line is displayed at the top of the diagram (100%).

This setting is only available if normalization is on (see ["Normalization state"](#) on page 391).

The reference line defined by the reference value and reference position is similar to the [Reference Level](#) defined in the "Amplitude" settings. However, this reference line only affects the y-axis scaling in the diagram, it has no effect on the expected input power level or the hardware settings.

The normalized trace (0 dB directly after calibration) is displayed on this reference line, indicated by a red line in the diagram. If you shift the reference line, the normalized trace is shifted, as well.

Remote command:

[DISPlay\[:WINDow<n>\]\[:SUBWindow<w>\]:TRACe<t>:Y\[:SCALe\]:RPOSition](#) on page 1216

### Reference Value

Defines an offset for the position of the reference line.

This setting can be used to shift the reference line and thus the normalized trace, similar to the [Shifting the Display \(Offset\)](#) defined in the "Amplitude" settings shifts the reference level *in the display*.

Shifting the normalized trace is useful, for example, to reflect an attenuation or gain caused by the measured DUT. If you then zoom into the diagram around the normalized trace, the measured trace still remains fully visible.



Remote command:

`DISPlay[:WINDow<n>][:SUBWindow<w>]:TRACe<t>:Y[:SCALe]:RVALue`  
on page 1172

#### 7.2.4.4 How to work with external generator control

The following step-by-step instructions demonstrate how to work with the optional external generator control.



For remote operation, see "[Programming example for external generator control](#)" on page 1174.

- [How to configure an external generator connection via GPIB](#)..... 393
- [How to define a new generator setup file](#).....393
- [How to calibrate a measurement setup using an external generator](#).....394
- [How to remove the effects of a particular component from measurement results using calibration](#)..... 395
- [How to compensate for additional gain or attenuation after calibration](#)..... 395

#### How to configure an external generator connection via GPIB

1. Connect the signal generator's GPIB interface connector to the "Ext. Gen.Control GPIB" connector on the rear panel of the FSW.
2. If the signal generator supports TTL synchronization, connect the signal generator to the optional "Aux.Control" port.
3. Press [INPUT/OUTPUT] and select "External Generator Config".
4. In the "Interface Configuration" subtab, select the "Generator Type" connected to the FSW.  
If the required generator type is not available, define a new setup file as described in "[How to define a new generator setup file](#)" on page 393.
5. Select the type of interface and the address used to connect the generator to the FSW.
6. If the generator supports "TTL Synchronization", activate this function.

#### How to define a new generator setup file

1. Press [INPUT/OUTPUT] and select "External Generator Config".
2. In the "Interface Configuration" subtab, select a generator type that has similar characteristics (frequency and power ranges).
3. Select "Edit Generator Setup File".  
The configuration file for the selected generator type is displayed (read-only) in an editor.

4. Edit the configuration values according to your generator. Be sure not to change the syntax of the file - only change the *values* of the parameters. Errors are only detected and displayed when you try to use the new generator (see also "[Displayed information and errors](#)" on page 384).
5. Save the file under a different name with the extension `.gen`:
  - a) In the editor, select "File > SaveAs".
  - b) Select "Save as type: All Files (\*.\*)".
  - c) Specify a name with the extension `.gen`.
6. In the FSW firmware, close the "External Generator Config" dialog and re-open it.  
Now you can select the new generator type from the selection list on the "Interface Configuration" tab.

### How to calibrate a measurement setup using an external generator

1. Connect the signal generator output to the "RF input" connector of the FSW.
2. If the measurement setup does not require the full span of the FSW, change the "Frequency Start" and "Frequency Stop" values ([FREQ] > "Frequency Config").
3. Press [INPUT/OUTPUT] and select "External Generator Config".
4. In the "Interface Configuration" subtab, select "Reference: External" to synchronize the analyzer with the generator.
5. Switch to the "Measurement Configuration" subtab.
6. Set the "Source State" to "On".
7. Define the generator output level as the "Source Power".
8. Optionally, to define a constant level offset for the external generator, define a "Source Offset".
9. The default frequency list for the calibration sweep contains 1001 values, divided in equidistant frequencies between the FSW's start and stop frequency. Usually, this automatic coupling is correct. Check the "Result Frequency Start" and "Result Frequency Stop" values to make sure that the required measurement span is covered. If necessary, change the frequency settings on the FSW ([FREQ] > "Frequency Config"), or use a different generator type.
10. Switch to the "Source Calibration" subtab.
11. Select the "Source Calibration Type": "Transmission" to perform a calibration sweep and store a reference trace for the measurement setup.
12. Select "Source Calibration Normalize": "On".

13. Optionally, shift the reference line further down in the result display by decreasing the "Reference": "Position".

The measurement setup is now calibrated. Subsequent measurement results are normalized, so that any unwanted effects from the cables and connectors are removed.

#### **How to remove the effects of a particular component from measurement results using calibration**

1. Set up the measurement, including the component, and perform a calibration as described in ["How to calibrate a measurement setup using an external generator"](#) on page 394.
2. After setting "Source Calibration Normalize": "On", select "Save as Trd Factor" to store the normalized reference trace as a transducer factor.
3. If necessary, switch to another measurement channel for a different FSW application.
4. Press [Setup], then select "Transducer".
5. Select the stored transducer in the list of available transducers and select the "Active" setting for it.
6. Perform any measurement with the setup that contains the calibrated component.  
The measurement results do not include the effects from the component.

#### **How to compensate for additional gain or attenuation after calibration**

If a gain or an attenuation is inserted in the measurement after calibration, this effect can be reflected in the display of the normalized trace on the FSW. Thus, the measured trace and the normalized trace are not so far apart in the display, so that you can zoom into the normalized trace without cropping the measurement trace.

Prerequisite: a calibration has been performed for the original measurement setup, except for the component causing an additional gain or attenuation (as described in ["How to calibrate a measurement setup using an external generator"](#) on page 394)

1. Insert the additional component in the calibrated measurement setup and perform a new measurement.
2. Press [INPUT/OUTPUT] and select "External Generator Config".
3. Switch to the "Source Calibration" subtab.
4. With active normalization, set the "Reference": "Value" to the same value as the gain or attenuation the inserted component causes.
5. Optionally, shift the reference line further down in the result display by decreasing the "Reference": "Position".

The normalized reference trace moves to the position of the measured trace.

6. Optionally, zoom into the measured trace by changing the y-axis scaling (or the range: "AMPT > Scale Config > Range").

The measured trace is still fully visible, and the absolute values are still valid.

#### 7.2.4.5 Measurement example: calibration with an external generator

The following measurement example demonstrates the most common functions using an external generator. This example requires the External Generator Control option.

The example assumes an SMW100A generator is connected to the FSW. A band elimination filter is the device under test. After calibration, an additional attenuator is inserted between the DUT and the FSW.

The following procedures are described:

- ["Calibrating the measurement setup"](#) on page 396
- ["Measuring the effects of the DUT"](#) on page 398
- ["Compensating the effects of additional attenuation after calibration"](#) on page 400

##### Calibrating the measurement setup

1. Connect the signal generator's GPIB interface connector to the [Ext. Gen.Control GPIB] connector on the rear panel of the FSW.
2. Connect the signal generator output to the [RF input] connector of the FSW.
3. Adapt the measurement range of the FSW to the filter to be tested. In this measurement, define the following settings:
  - a) Press [FREQ], select "Frequency Config" and enter "Frequency Start":  
*100 MHz.*
  - b) Enter "Frequency Stop": *300 MHz*
4. Press [INPUT/OUTPUT] and select "External Generator Config".
5. In the "Interface Configuration" sub-tab, select "Generator Type": "SMW06".
6. Select "Reference: External" to synchronize the analyzer with the generator.
7. Switch to the "Measurement Configuration" sub-tab.
8. Set the "Source State" to "On".
9. Define the generator output level as the "Source Power": *-20 dBm*.
10. Set the "Coupling State" to "Auto".

The "Result Frequency Start" value for the generator is indicated as *100.0 MHz*.  
The "Result Frequency Stop" value is indicated as *300.0 MHz*.
11. Switch to the "Source Calibration" sub-tab.
12. Select the "Source Calibration Type": "Transmission" to perform a calibration sweep and store a reference trace for the measurement setup.



*Figure 7-8: Measurement results from generator, analyzer and connecting cables*

13. Select "Source Calibration Normalize": "On" to set the measurement results for the current setup to 0, thus eliminating all effects from the generator, the analyzer and the connecting cables from subsequent measurements with the band elimination filter.

The reference line is displayed at 0 dB at the top of the diagram (100%).



Figure 7-9: Normalized measurement results after calibration

### Measuring the effects of the DUT

After calibration we can insert the band elimination filter (our DUT) in the measurement setup.

1. Connect the signal generator output to the band elimination filter.
2. Connect the band elimination filter output to the [RF input] connector of the FSW.

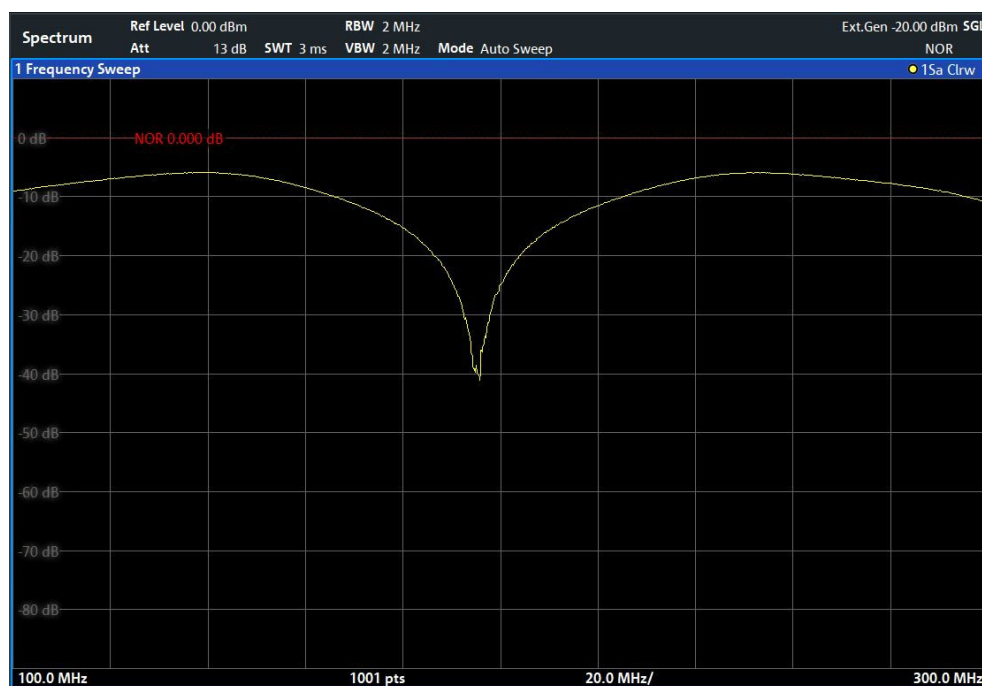

Figure 7-10: Band elimination filter results

- Shift the reference line from the top of the diagram to the middle of the diagram by changing the position of the reference point  $0.0\text{ dB}$  to  $50\%$ .  
In the "Source Calibration" tab, enter "Position":  $50\%$ .  
At the same time, the range of the displayed y-axis moves from  $[-100.0\text{ dB to }0\text{ dB}]$  to  $[-50\text{ dB to }+50\text{ dB}]$ .

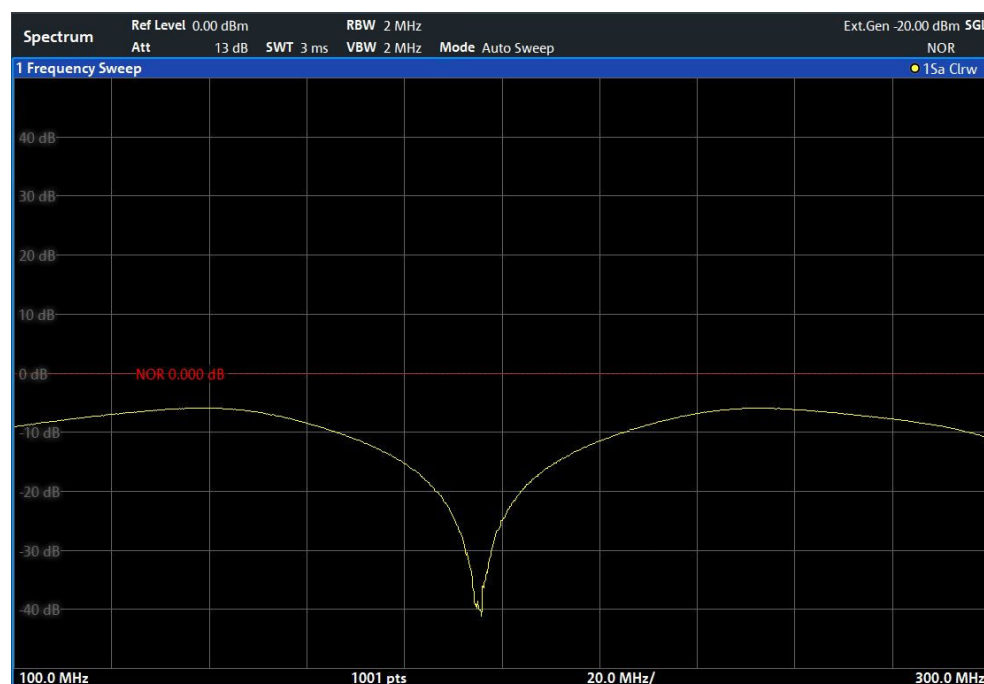

Figure 7-11: Reference line shifted to middle of diagram (50%)

### Compensating the effects of additional attenuation after calibration

After calibration, an additional attenuator is inserted between the DUT and the FSW. This may be necessary, for example, to protect the analyzer's input connector. Nevertheless, we are only interested in the effects of the DUT, not those of the additional protective attenuator. Thus, we will compensate these effects in the result display on the FSW by moving the reference line.

1. Connect a 3 dB attenuator between the band elimination filter output and the [RF input] connector on the FSW.

The measurement results are now 3 dB lower.



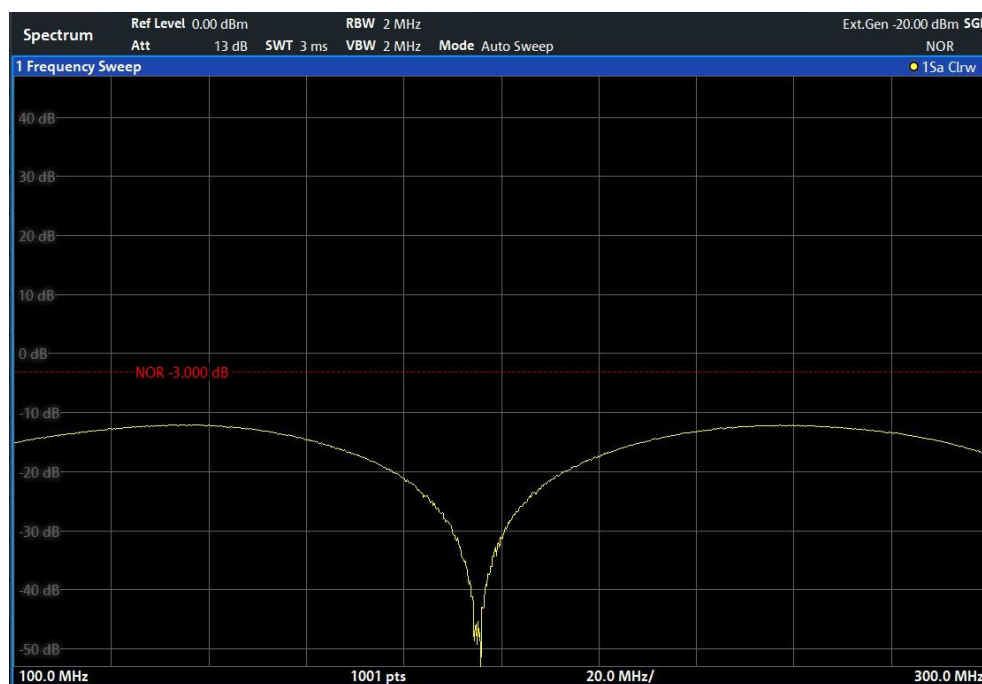

Figure 7-12: Measurement results with additional attenuator

- In the "Source Calibration" tab, enter "Reference Value": -3 dB.

The reference line is shifted down by 3 dB so that the measurement trace is displayed on the reference line again.

At the same time, the scaling of the y-axis is changed: -3dB are now shown at 50% of the diagram; the range is [-53 dB to +47 dB].

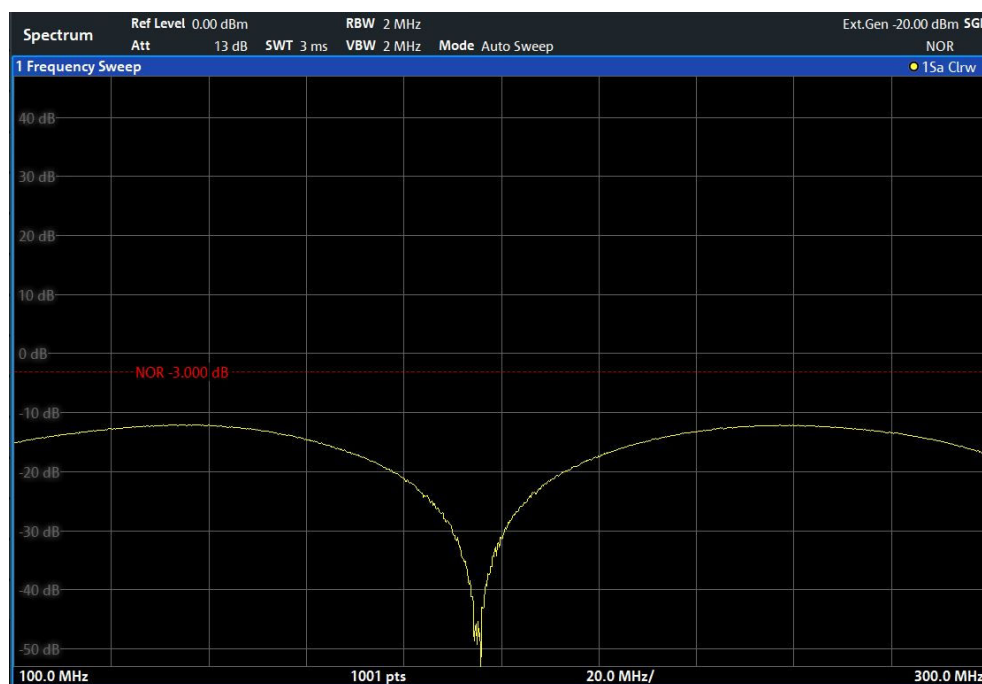

Figure 7-13: Reference line with an offset of -3 dB and shifted to middle of diagram (50%)

3. After the reference trace has been shifted, you can zoom into the measured trace to determine the offsets to the reference line, which represent the effects of the band elimination filter in the measurement setup. Change the y-axis scaling to 1 dB/div (or the range to 10 dB).
  - a) Press [AMPT], then select "Scale Config" > "Range".
  - b) Enter 10 dB.

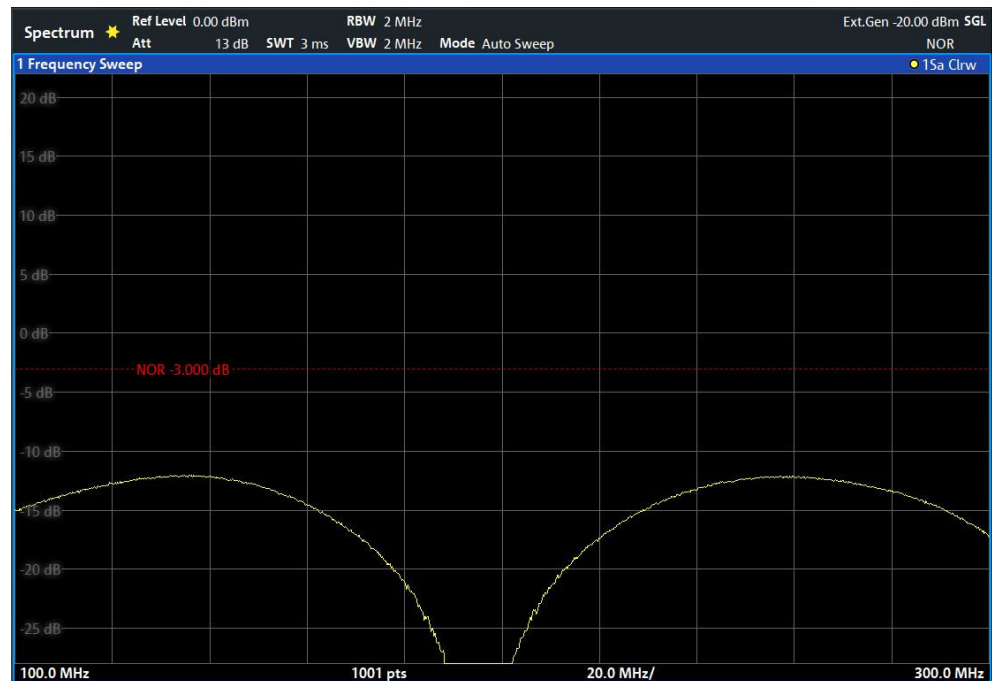

Figure 7-14: Reference line with measurement results using larger scale

## 7.2.5 Probes

The FSW can also analyze data from a connected probe.

### 7.2.5.1 Using probes

Probes allow you to perform voltage measurements very flexibly and precisely on all sorts of devices to be tested, without interfering with the signal. The FSW base unit and some (optional) applications support input from probes. For information on which probes are supported, see the FSW specifications document.

#### Probe connectors

Probes can be connected to the following connectors on the FSW:

- BASEBAND INPUT connectors, if the optional "Analog Baseband" interface is installed;  
Allows you to perform I/Q analysis or frequency sweeps on data from all active probes up to a frequency of 5 GHz. The power supply for the probe is integrated in the connector.  
Supported only by applications that can process I/Q data.
- "RF Input" connector using an R&S RT-ZA9 adapter;  
Allows you to perform I/Q analysis or frequency sweeps on data from active modular probes directly on the RF input up to the maximum frequency of the probe and analyzer. Does not require the optional "Analog Baseband" interface.  
Supported by all FSW applications, in particular the Spectrum application.

The R&S RT-ZA9 provides an interface between the probe's BNC socket and the analyzer's N-socket. The USB connection provides the necessary supply voltages for the probe.



### Active probes

When using active probes from the R&S RT family, consider the following:

- Active probes require operating power from the instrument and have a proprietary interface to the instrument.
- The probe is automatically recognized by the instrument, no adjustment is required.
- Connections should be as short as possible to keep the usable bandwidth high.
- Observe the operating voltage range.

### Microbutton action

You can define an action to be performed by the FSW when the probe's microbutton (if available) is pressed. Currently, a single data acquisition via the probe can be performed simply by pressing the microbutton.

### Analog baseband probes

Probes are automatically detected when you plug them into the upper BASEBAND INPUT connectors on the front panel of the FSW. The detected information on the probe is displayed in the "Probes" tab of the "Input" dialog box, individually for each connector.



To determine whether the probe has been connected properly and recognized by the FSW, use the `[SENSe:] PROBe<pb>:SETup:STATe?` remote control command.

Analog baseband input from connected probes can only be analyzed in applications that support I/Q data processing and the optional "Analog Baseband" interface, such as the I/Q Analyzer or one of the optional applications.

However, probes can also provide RF input to the FSW via the BASEBAND INPUT I connector. In this case, the input is redirected to the RF input path. Then the probe data can also be analyzed in the Spectrum application, allowing you to perform measurements in the time or frequency domain on the input from a probe.

For details see the FSW I/Q Analyzer and I/Q Input User Manual.

As opposed to common RF input processing, a transducer is activated before the common process to compensate for the additional path of the redirected signal.

### Impedance and attenuation

The measured signal from the probe is attenuated internally by the probe's specific attenuation.

For probe signals that are redirected to the RF path, the attenuation is compensated by the transducer.

The reference level is adjusted automatically.

For analog baseband input, the attenuation is compensated without a transducer. In this case, higher levels are available for the full scale level.

A fixed impedance of  $50\ \Omega$  is used for all probes to convert voltage values to power levels.

### Additional information

An application note discussing differential measurements with spectrum analyzers is available from the Rohde & Schwarz website:

[1EF84: Differential measurements with Spectrum Analyzers and Probes](#)

### Common mode offset (for differential probes)

Common mode offset compensation is available for R&S®RT-ZD10/20/30 probes with serial number  $\geq 200\ 000$ . It can compensate a common DC voltage applied to both input sockets (referenced to the ground socket). This is particularly helpful for measurements on differential signals with high common mode levels, for example, current measurements using a shunt resistor.

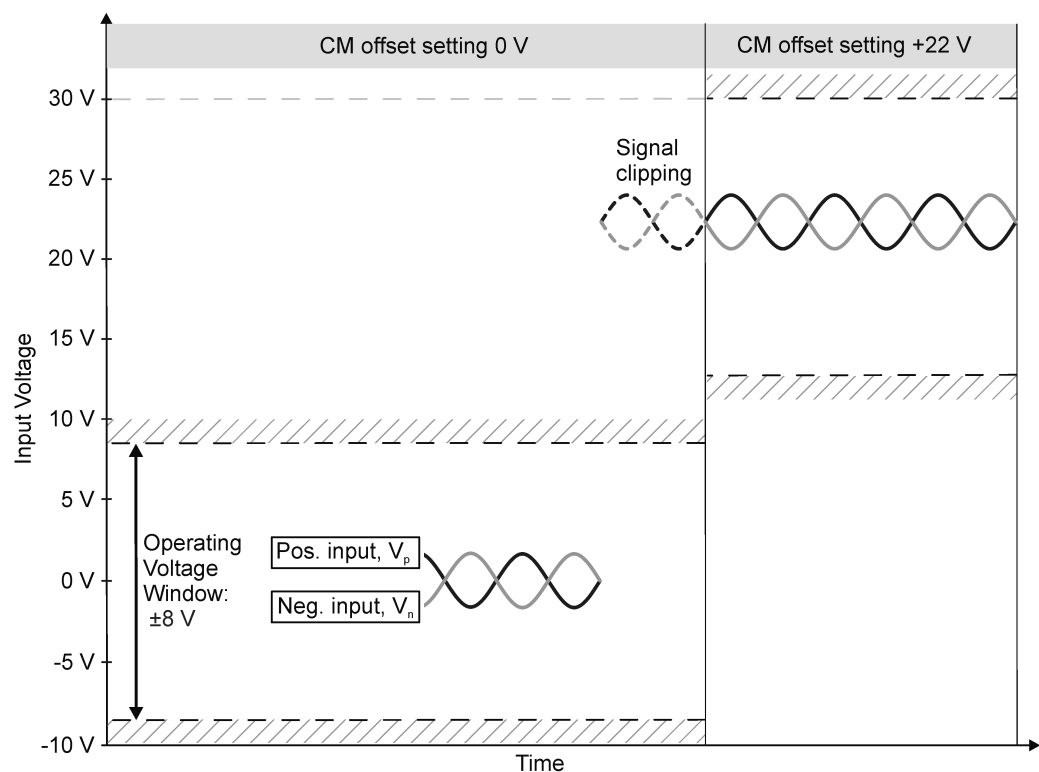

Figure 7-15: Common mode (CM) offset compensation for a differential measurement

If the input signals fit into the operating voltage window of the R&S®RT-ZD10/20/30, it is not necessary to set a common mode offset compensation.



### Clipping effects due to incorrect common mode offset

The R&S®RT-ZD10/20/30 probe measures only differential input signals. Common mode signals are suppressed by the probe. Therefore, the common mode offset compensation is not directly visible in the result display. An incorrect common mode offset compensation can lead to unwanted clipping effects. Measuring the common mode input voltage using the R&S ProbeMeter is a convenient way to detect breaches of the operating voltage window.

For more information on common mode offset see the R&S®RT-ZD10/20/30 User Manual.

### RF probes

Generally, you can perform frequency sweeps on active probes connected to the BASEBAND INPUT connectors by redirecting the input to the RF Input path (see "[Analog baseband probes](#)" on page 404). However, this measurement setup is restricted to a maximum frequency of 5 GHz by the BASEBAND INPUT connectors. Furthermore, this setup is restricted to applications that can process I/Q data.

Connecting probes directly to the RF Input connector allows you to make use of the maximum frequency range provided by the probe and the FSW, which can be much higher than 5 GHz.

Furthermore, input from probes at the RF Input connector can be analyzed in all FSW applications, including applications that do not process I/Q data, and do not support the optional "Analog Baseband" interface.

Only active modular probes can be connected to the RF Input connector via the optional R&S RT-ZA9 adapter.

### To connect an active probe to the RF Input

1. Connect the R&S RT-ZA9 adapter to the RF Input connector on the FSW.
2. Connect the R&S RT-ZA9 adapter's USB cable to a USB connector on the FSW.
3. Connect the probe to the adapter.

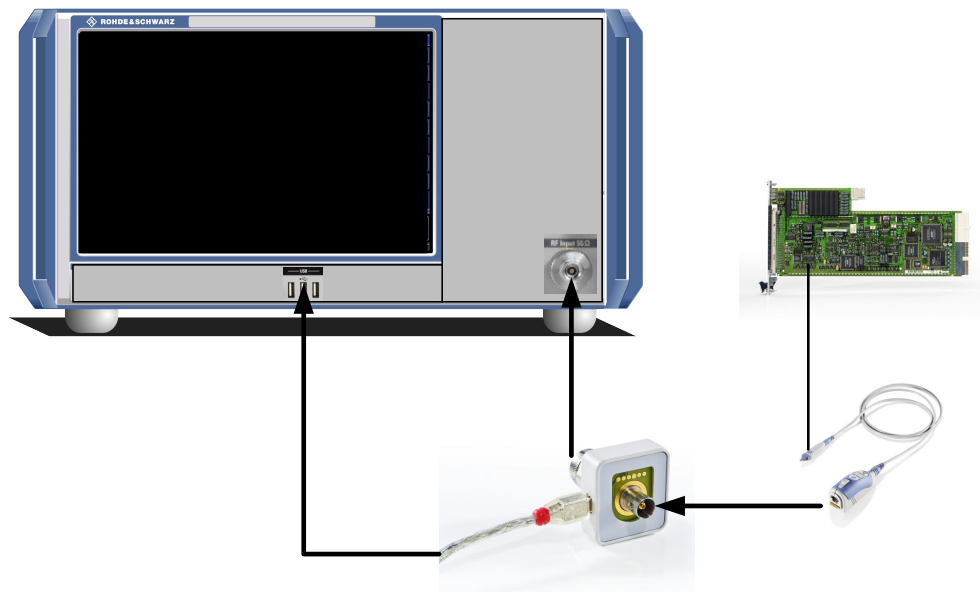

- In the "Input source" settings, select the "Input connector": "RF Probe".

Probes are automatically detected when you plug them into the FSW. The detected information on the probe is displayed in the "Probes" tab of the "Input" dialog box.



To determine whether the probe has been connected properly and recognized by the FSW, use the `[SENSE:] PROBe<pb>:SETup:STATe?` remote control command.

### Impedance and attenuation

The measured signal from the probe is attenuated internally by the probe's specific attenuation. For RF probes, the attenuation is compensated using a pre-defined "Probe on RF Input" transducer factor. This special transducer factor is automatically activated before the common RF data processing when you select "RF probe" as the input connector. The reference level is adjusted automatically.

A fixed impedance of 50  $\Omega$  is used for all probes to convert voltage values to power levels.

### Multimode function and offset compensation for modular RF probes

The R&S RT-ZM probe family features the MultiMode function which allows you to switch between single-ended, differential, and common mode measurements without reconnecting or resoldering the probe.

Four different input voltages can be measured with the MultiMode feature:

- **P-Mode:** (pos.) Single-ended input voltage ( $V_p$ )  
Voltage between the positive input terminal and ground
- **N-Mode:** (neg.) Single-ended input voltage ( $V_n$ )  
Voltage between the negative input terminal and ground
- **DM-Mode:** Differential mode input voltage ( $V_{dm}$ )  
Voltage between the positive and negative input terminal

$$V_{dm} = V_p - V_n$$

- **CM-Mode:** Common mode input voltage ( $V_{cm}$ )  
Mean voltage between the positive and negative input terminal vs. ground

$$V_{cm} = \frac{V_p + V_n}{2}$$

The FSW supports all probe modes.

The mode is configured in the [Chapter 7.2.5.2, "Probe settings"](#), on page 408.

### Offset compensation

The R&S RT-ZM probes feature a comprehensive offset compensation function. The compensation of DC components directly at the probe tip even in front of the active probe amplifier is possible with an extremely wide compensation range of  $\pm 16$  V ( $\pm 24$  V for P and N modes).

The offset compensation feature is available for every MultiMode setting:

MultiMode setting	Offset compensation	Offset compensation range	Application
DM-Mode	Differential DC voltage	$\pm 16$ V	Probing single-ended signals, e.g. power rails with high DC component and small AC signal.
CM-Mode	Common mode DC voltage	$\pm 16$ V	Measurements of signals with high common mode levels, e.g. current measurements with a shunt resistor.
P-Mode	DC voltage at positive input terminal	$\pm 24$ V	Measurement of single-ended AC signals with high superimposed DC component at the positive input terminal. <b>Note:</b> The maximum voltage difference between the positive and negative input terminals is 16 V.
N-Mode	DC voltage at negative input terminal	$\pm 24$ V	Measurement of single ended AC signals with high superimposed DC component at the negative input terminal. <b>Note:</b> The maximum voltage difference between the positive and negative input terminals is 16 V.



If the offset for DM-mode or CM-mode is changed, the offsets for the P-mode and N-mode are adapted accordingly, and vice versa.

### 7.2.5.2 Probe settings

**Access:** [INPUT / OUTPUT] > "Input Source Config" > "Probes"

Data input for the measurement can be provided by probes if the optional "Analog Baseband" interface is available or the R&S RT-ZA9 adapter is used.



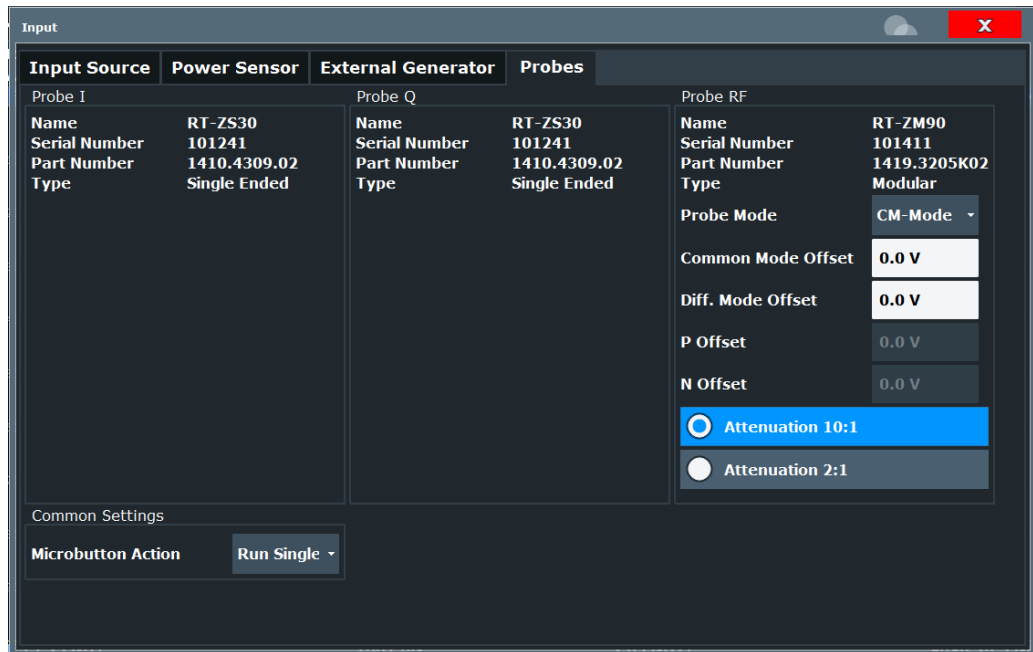

For each possible probe connector (Baseband Input I, Baseband Input Q, RF), the detected type of probe, if any, is displayed.

For more information on using probes with an FSW, see [Chapter 7.2.5.1, "Using probes"](#), on page 403.

For general information on the R&S®RT probes, see the device manuals.

<a href="#">Name</a> .....	409
<a href="#">Serial Number</a> .....	409
<a href="#">Part Number</a> .....	409
<a href="#">Type</a> .....	410
<a href="#">Mode</a> .....	410
<a href="#">Common Mode Offset / Diff. Mode Offset / P Offset / N Offset /</a> .....	410
<a href="#">Attenuation</a> .....	410
<a href="#">Microbutton Action</a> .....	411

**Name**

Probe name

Remote command:

[SENSe:] PROBe<pb>: SETup:NAME? on page 1162

**Serial Number**

Serial number of the probe

Remote command:

[SENSe:] PROBe<pb>: ID:SRNumber? on page 1160

**Part Number**

Rohde & Schwarz part number

Remote command:

[\[SENSe:\] PROBe<pb>:ID:PARTnumber?](#) on page 1159

### Type

Type of probe:

- Single-ended
- Differential
- Active Modular

Remote command:

[\[SENSe:\] PROBe<pb>:SETup:TYPE?](#) on page 1164

### Mode

Mode for multi-mode modular probes. Determines which voltage is measured.

"DM-mode"	Voltage between the positive and negative input terminal
"CM-mode"	Mean voltage between the positive and negative input terminal vs. ground
"P-mode"	Voltage between the positive input terminal and ground
"N-mode"	Voltage between the negative input terminal and ground

Remote command:

[\[SENSe:\] PROBe<pb>:SETup:PMODE](#) on page 1163

### Common Mode Offset / Diff. Mode Offset / P Offset / N Offset /

Sets the offset for the probe, depending on the used mode (CM and DM mode both use the "Common Mode Offset"). The setting is only available if a differential (R&S RT-ZD) or modular (R&S RT-ZM) probe is connected to the FSW.

If the probe is disconnected, the offset of the probe is reset to 0.0 V.

**Note:** If the offset for DM-mode or CM-mode is changed, the offsets for the P-mode and N-mode are adapted accordingly, and vice versa.

Remote command:

[\[SENSe:\] PROBe<pb>:SETup:CMOffset](#) on page 1161

[\[SENSe:\] PROBe<pb>:SETup:DMOffset](#) on page 1161

[\[SENSe:\] PROBe<pb>:SETup:NMOffset](#) on page 1162

[\[SENSe:\] PROBe<pb>:SETup:PMOffset](#) on page 1164

### Attenuation

Defines the attenuation applied to the input at the probe. This setting is only available for modular probes.

"10:1"            Attenuation by 20 dB

"2:1"             Attenuation by 6 dB

Remote command:

[\[SENSe:\] PROBe<pb>:SETup:ATTRatio](#) on page 1160

**Microbutton Action**

Active Rohde & Schwarz probes (except for R&S RT-ZS10E) have a configurable microbutton on the probe head. By pressing this button, you can perform an action on the instrument directly from the probe.

Select the action that you want to start from the probe:

- "Run Single"      Starts one data acquisition.
- "No Action"      Prevents unwanted actions due to unintended usage of the microbutton.

Remote command:

[SENSe:] PROBe<pb>:SETup:MODE on page 1162

**7.2.6 Optional external mixers**

If the FSW External Mixer option is installed, an external mixer can be connected to the FSW to increase the available frequency range. In this case, the input to measure is not taken from the RF input connector, but from the "Ext Mixer" connector(s).

For an active external frontend, external mixers are not available. See "[External Frontend Connection State](#)" on page 450.

- [Basics on external mixers](#)..... 411
- [External mixer settings](#).....423
- [How to work with external mixers](#).....434
- [Measurement examples: using an external mixer](#).....437

**7.2.6.1 Basics on external mixers**

Some background knowledge on basic terms and principles used with external mixers is provided here for a better understanding of the required configuration settings.

- [Frequency ranges](#)..... 411
- [Two-port and three-port mixers](#).....412
- [Bias current](#).....413
- [Conversion loss tables](#).....414
- [External mixers and large bandwidth extension options](#).....416
- [Automatic signal identification](#).....418

**Frequency ranges**

In a common spectrum analyzer, rather than providing one large (and thus inaccurate) filter, or providing several filters to cover the required frequency range of the input signal (at a high cost), a single, very accurate filter is used. Therefore, the input signal must be converted to the frequencies covered by the single accurate filter. This is done by a mixer, which converts and multiplies the frequency of the input signal with the help of the local oscillator (LO). The result is a higher and lower intermediate frequency (IF). The local oscillator can be tuned within the supported frequency range of the input signal.

In order to extend the supported frequency range of the input signal, an external mixer can be used. In this case, the LO frequency is output to the external mixer, where it is

mixed with the RF input from the original input signal. In addition, the *harmonics* of the LO are mixed with the input signal, and converted to new intermediate frequencies. Thus, a wider range of frequencies can be obtained. The IF from the external mixer is then returned to the spectrum analyzer.

The frequency of the input signal can be expressed as a function of the LO frequency and the selected harmonic of the first LO as follows:

$$f_{in} = n * f_{LO} + f_{IF}$$

Where:

$f_{in}$ : Frequency of input signal

$n$ : Order of harmonic used for conversion

$f_{LO}$ : Frequency of first LO: 7.65 GHz to 17.45 GHz

$f_{IF}$ : Intermediate frequency (variable; defined internally depending on RBW, span and optional bandwidth extensions)

Thus, depending on the required frequency band, the appropriate order of harmonic must be selected. For commonly required frequency ranges, predefined bands with the appropriate harmonic order setting are provided. By default, the lowest harmonic order is selected that allows conversion of input signals in the whole band.

For the "USER" band, the order of harmonic is defined by the user. The order of harmonic can be between 2 and 128, the lowest usable frequency being 16.88 GHz.

The frequency ranges for pre-defined bands are described in [Table 13-4](#).



Changes to the band and mixer settings are maintained even after using the [PRESET] function. A "Preset band" function allows you to restore the original band settings.

### Extending predefined ranges

In some cases, the harmonics defined for a specific band allow for an even larger frequency range than the band requires. By default, the pre-defined range is used. However, you can take advantage of the extended frequency range by overriding the defined start and stop frequencies by the maximum possible values ("RF Overrange" option).

### Additional ranges

If due to the LO frequency the conversion of the input signal is not possible using one harmonic, the band must be split. An adjacent, partially overlapping frequency range can be defined using different harmonics. In this case, the sweep begins using the harmonic defined for the first range, and at a specified frequency in the overlapping range ("handover frequency"), switches to the harmonic for the second range.

Which harmonics are supported depends on the mixer type.

### Two-port and three-port mixers

External mixers are connected to the FSW at the LO OUT/IF IN and IF IN connectors.

When using three-port mixers, the LO signal output from the FSW and the IF input from the mixer are transmitted on separate connectors, whereas for two-port mixers, both signals are exchanged via the same connector (LO OUT/IF IN). Because of the diplexer contained in the FSW, the IF signal can be tapped from the line which is used to feed the LO signal to the mixer.



For measurements with a bandwidth larger than 2 GHz and an external mixer, only 3-port mixers are supported.

For more information see ["External mixers and large bandwidth extension options"](#) on page 416.

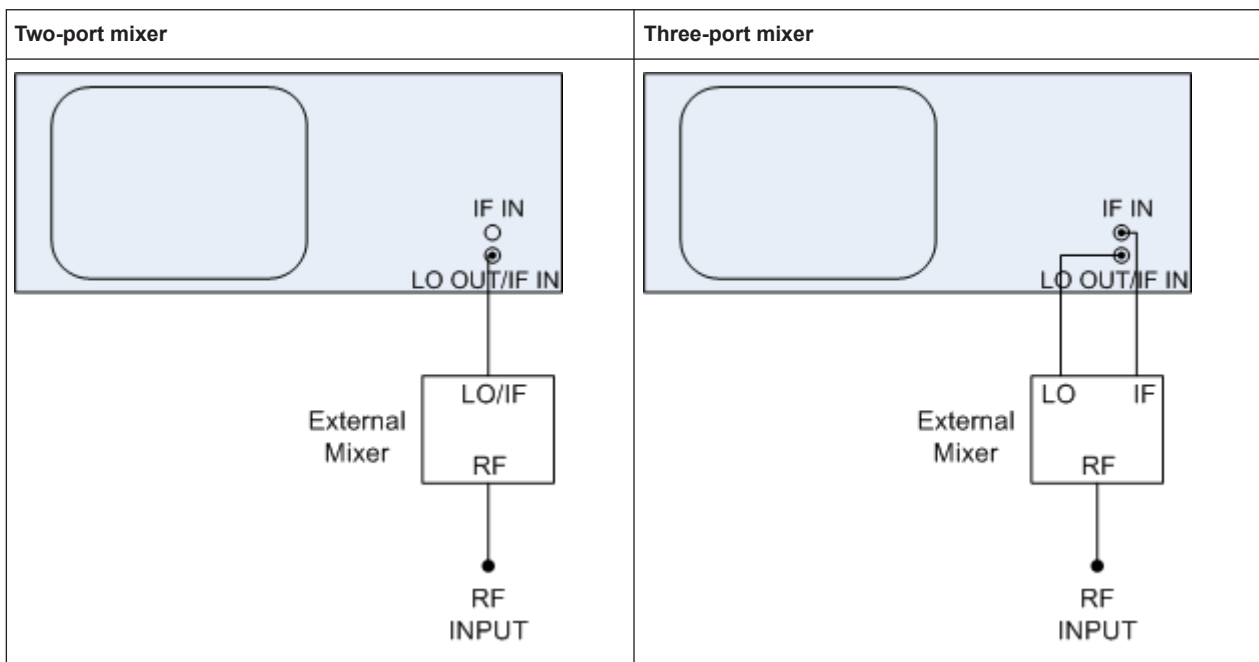

In both cases, the nominal LO level is 15.5 dBm.

### Bias current

Single-diode mixers generally require a DC voltage which is applied via the LO line. This DC voltage is to be tuned to the minimum conversion loss versus frequency. Such a DC voltage can be set via the "BIAS" function using the D/A converter of the FSW. The value to be entered is not the voltage but the short-circuit current. The current is defined in the "Bias Settings" or set to the value of the conversion loss table.

See ["Bias Value"](#) on page 429 and ["Bias"](#) on page 433.

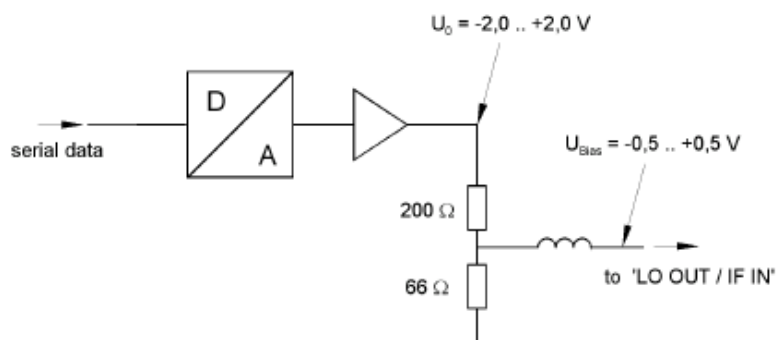
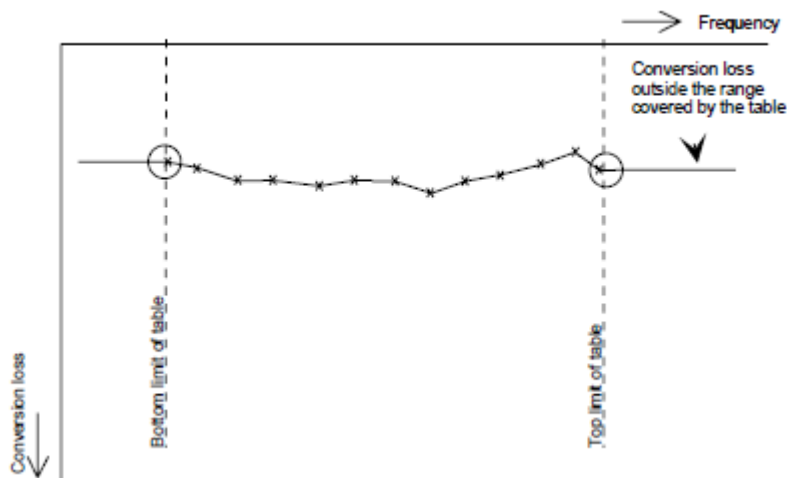

Figure 7-16: Bias circuit of the FSW

The voltage  $U_0$  at the output of the operational amplifier can be set in the range  $-2.0$  V to  $+2.0$  V. An open-circuit voltage  $U_{\text{bias}}$  of  $-0.5$  V to  $+0.5$  V is obtained accordingly at the output of the voltage divider. A short-circuit current of  $I_{\text{short}} = U_0 / 200 \Omega = 10$  mA to  $+10$  mA is obtained for a short circuit at the output of the voltage divider. In order to use biasing it is not important to know the exact current flowing through the diode since the conversion loss must be set to a minimum with the frequency. Therefore, it makes no difference whether the setting is performed by an open-circuit voltage or by a short-circuit current. A DC return path is ensured via the  $66 \Omega$  resistor, which is an advantage in some mixers.

### Conversion loss tables

Conversion loss tables consist of value pairs that describe the correction values for conversion loss at certain frequencies. Correction values for frequencies between the reference values are obtained by interpolation. Linear interpolation is performed if the table contains only two values. If it contains more than two reference values, spline interpolation is carried out. Outside the frequency range covered by the table the conversion loss is assumed to be the same as that for the first and last reference value (see Figure 7-17).



**Figure 7-17: Conversion loss outside the band's frequency range**

Predefined conversion loss tables are often provided with the external mixer and can be imported to the FSW.

Alternatively, you can define your own conversion loss tables. Conversion loss tables are configured and managed in the "Conversion loss Table Settings" tab of the "External Mixer Configuration" dialog box.

See ["Managing conversion loss tables"](#) on page 429 for more information about conversion loss tables.

When using external mixers with optional bandwidth extensions larger than 512 MHz, special conversion loss tables are required, see ["External mixers and large bandwidth extension options"](#) on page 416.

### Importing CVL tables

The conversion loss table to be used for a particular measurement range is also defined in the "External Mixer Configuration" dialog box.

The frequency range that the cvl table must cover depends on the used IF, which varies depending on the instrument and installed bandwidth extension options. Thus, external mixers from Rohde & Schwarz provide multiple conversion loss table files. When you select a storage path containing cvl files, or a particular cvl file from a Rohde & Schwarz mixer for import, all available files are copied to the `C:\R_S\INSTR\USER\cvl\` directory on the FSW. Provided `.acl` files are renamed according to the following syntax:

```
<serial_number>_<harmonic_order>_<IF>.acl,
```

```
e.g. 12345_2_1330M.acl
```

To select a conversion loss table for use in a measurement, you merely have to select the serial number for the external mixer in use. The FSW automatically selects the correct cvl file for the current IF. As an alternative, you can also select a user-defined conversion loss table (`.acl` file).



Before copying any files to the `C:\R_S\INSTR\USER\cv1\` directory, the FSW firmware moves any existing user-defined cvl tables to a `backup` subdirectory. To use a user-defined cvl table later, select the file in the `C:\R_S\INSTR\USER\cv1\backup` directory.

A validation check is then performed on the selected table to ensure that it complies with the settings. In particular, the following is checked:

- The assigned band name
- The harmonic order
- The mixer type
- The table must contain at least one frequency that lies within the frequency range for the band

### Reference level

The maximum possible reference level depends on the maximum used conversion loss value. Thus, the reference level can be adjusted for each range according to the used conversion loss table or average conversion loss value. If a conversion loss value is used which exceeds the maximum reference level, the reference level is adjusted to the maximum value permitted by the firmware.

### External mixers and large bandwidth extension options

If the bandwidth extension options R&S FSW-B1200/-B2001/-B2000 are active, external mixers with a bandwidth up to 2 GHz are supported. For information on which mixers are supported for these bandwidth options, see the FSW specifications document. Two-port mixers are not supported.

If the bandwidth extension option R&S FSW-B5000 is active, some external (three-port) mixers with a bandwidth up to 5 GHz are supported. For information on which mixers are supported for these bandwidth options, see the FSW specifications document. Two-port mixers are not supported. Instrument models 1312.8000Kxx require an additional hardware option, R&S FSW-U21 or R&S FSW-U85.

If the bandwidth extension options R&S FSW-B4001/B6001/B8001 are active, external mixers are supported for an analysis bandwidth up to 4 GHz. For information on which mixers are supported for these bandwidth options, see the FSW specifications document.

Depending on the installed and active bandwidth extension options and used measurement bandwidth, special conversion loss tables are required.

**Table 7-1: Required conversion loss tables depending on measurement bandwidth**

BW extension option	Used meas bandwidth	Required conversion loss table format
B1200/B2001	<=512 MHz	*.ACL
	>512 MHz	*_B1200_B2001.B2G
B2000 (active)	<=2 GHz	*_B2000.B2G
B5000 (active)	<=4.4 GHz	*_B5000_2G8.B5G



BW extension option	Used meas bandwidth	Required conversion loss table format
	>4.4 GHz	*_B5000_3G5.B5G
B4001/B6001/B8001	<=80 MHz	*.ACL
	80 MHz< bw <=4 GHz	*_B5000_2G8.B5G

While the common `.acl` files can be used, data acquisition with larger bandwidths using such conversion loss tables leads to substantial inaccuracy. Using an average conversion loss for the entire range (instead of a conversion loss table) during data acquisition with the large bandwidth extension options causes even more inaccuracy. In both cases, the `UNCAL` status message indicates that the measurement can have inaccurate results.

Special conversion loss tables (in `.b2g` or `.b5g` files) cannot be edited within the FSW firmware; they can only be imported and deleted.

### B2000-specific conversion loss tables

A B2000 conversion loss table consists of 43 magnitude correction values (as opposed to 1 for `.acl` files). To each side of the specific frequency, 21 reference values are defined with an offset of 25 MHz to 1025 MHz. Thus, correction levels are measured with a spacing of 50 MHz.

#### Example:

For example, for the level measured at the frequency 50 GHz, 43 correction levels are defined:

- 21 for the frequencies 48.075 GHz, 49.125 GHz, 49.175 GHz, ..., 49.975 GHz
- 1 for the frequency 50 GHz
- 21 for the frequencies 50.025 GHz, 50.075 GHz, 50.125 GHz, ..., 51.025 GHz

B2000-specific conversion loss tables are provided in files according to the following syntax:

```
<serial_no.>_MAG_<harmonic>_B2000.b2g
```

### Phase correction tables

In addition to the magnitude correction tables, B2000 phase correction tables with the same layout are defined in a separate file. Both files are always delivered as a pair by the manufacturer of the external mixer. Currently, the FSW uses only the magnitude correction files for external mixers; the phase is assumed to be ideal (correction values are all 0).

B2000-specific phase conversion loss tables are provided in files according to the following syntax:

```
<serial_no.>_PHASE_<harmonic>_B2000.b2g
```

### B5000-specific conversion loss tables

For bandwidths larger than 2 GHz, two different types of conversion loss tables are available, depending on the required bandwidth:

- For bandwidths  $\leq 4.4$  GHz: table consists of 91 correction values per frequency, for an IF of 2.8 GHz

The tables are provided in files according to the following syntax:

```
<serial_no.>_MAG|PHASE_<harmonic>_B5000_2G8.b5g
```

- For bandwidths between 4.4 GHz and 5 GHz: table consists of 103 correction values per frequency, for an IF of 3.5 GHz

The tables are provided in files according to the following syntax:

```
<serial_no.>_MAG|PHASE_<harmonic>_B5000_3G5.b5g
```

Currently, the FSW uses only the magnitude correction files; the phase is assumed to be ideal (correction values are all 0).

### Automatic signal identification

Automatic signal identification allows you to compare the upper and lower band results of the mixer, thus detecting unwanted mixer products due to conversion.

Note that automatic signal identification is only available for measurements that perform frequency sweeps (not in vector signal analysis or the I/Q Analyzer, for instance).



The "Auto ID" function is now also available for [Spectrum emission mask \(SEM\) measurement](#) and [Spurious emissions measurement](#) using an external mixer.

### Signal ID function

Two sweeps are performed alternately. Trace 1 shows the trace measured on the upper side band (USB) of the LO (the test sweep), trace 2 shows the trace measured on the lower side band (LSB), i.e. the reference sweep.

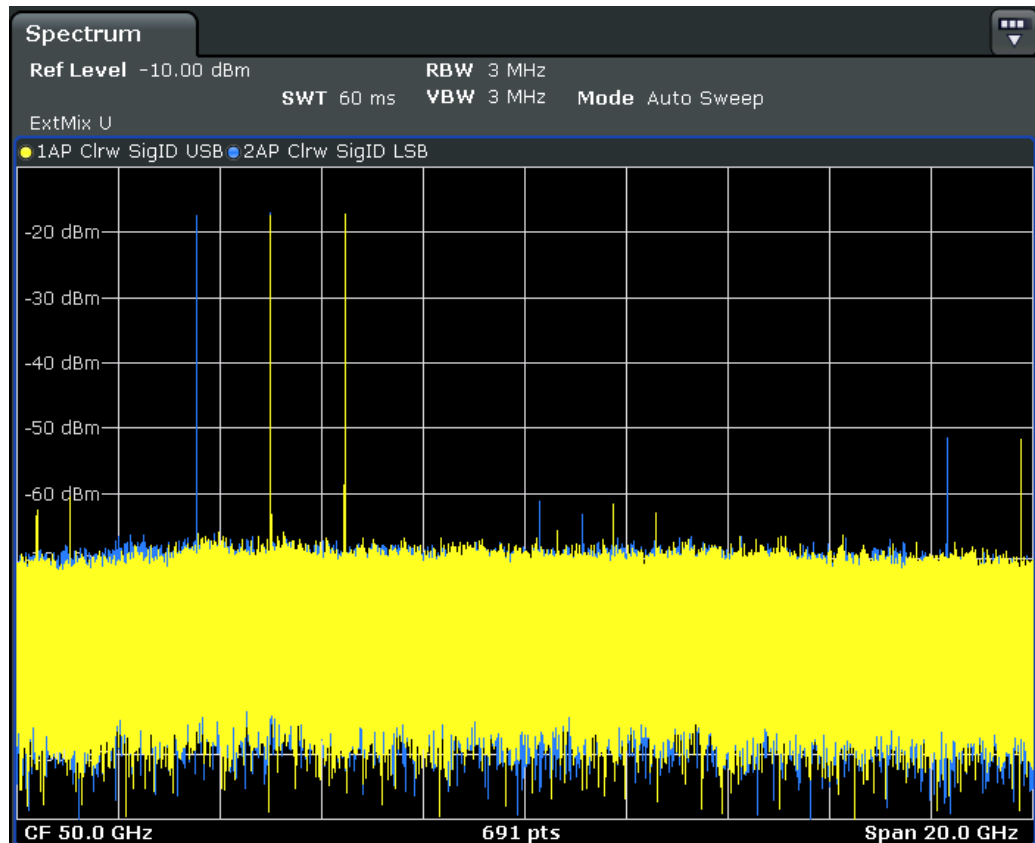

Figure 7-18: Signal identification function (Signal ID) with optional external mixer

The reference sweep is performed using an LO setting shifted downwards by  $2 \cdot \text{IF} / \langle \text{Harmonic order} \rangle$ . Input signals in the desired sideband that are converted using the specified harmonic are displayed in both traces at the same position on the frequency axis. Image signals and mixer products caused by other harmonics are displayed at different positions in both traces. The user identifies the signals visually by comparing the two traces.

Since the LO frequency is displaced downwards in the reference sweep, the conversion loss of the mixer may differ from the test sweep. Therefore the signal *level* should only be measured in the test sweep (trace 1).

### Auto ID function

The Auto ID function basically functions like [Signal ID function](#). However, the test and reference sweeps are converted into a single trace by a comparison of maximum peak values of each sweep point. The result of this comparison is displayed in trace 3 if "Signal ID" is active at the same time. If "Signal ID" is not active, the result can be displayed in any of the traces 1 to 3. Unwanted mixer products are suppressed in this calculated trace.

### Test sweep and reference sweep traces

Depending on which of the automatic signal identification functions are used, the traces are used to display either the test sweep (the upper side-band sweep) or the reference sweep (lower side-band sweep).

Function	Trace 1	Trace 2	Trace 3
Signal ID	Signal ID upper side-band	Signal ID lower side-band	-
Auto ID	Auto ID	-	-
Signal ID + Auto ID	Signal ID upper side-band	Signal ID lower side-band	Auto ID

### Tolerance for the comparison of test sweep and reference

Since the LO frequency is displaced downwards in the reference sweep, the conversion loss of the mixer may differ from that of the test sweep. This is due to the fact that the LO output power of the FSW varies with the frequency, and also due to the non-ideal characteristics of the mixer. A certain tolerance should therefore be permitted for the comparison of the signal levels in the test sweep and reference sweep. A user-defined threshold is used to determine deviations.

### Auto ID detection threshold

Real input signals are displayed at the same frequency in the test and reference sweeps, i.e. theoretically, identical signal levels are expected at the frequency of the real mixer product in both sweeps. If the level difference is lower than the user-defined threshold, the signal obtained in the test sweep is displayed. If a signal occurs only in the test sweep or reference sweep, it is an unwanted mixer product. The level of this signal is compared to the noise floor in the other sweep. If the S/N ratio is sufficiently large, the threshold is exceeded. This means that the signal with the lower level, i.e. noise in this case, is displayed.

Note that the Auto ID method operates according to the fail-safe principle, i.e. unwanted mixer products may not be detected as such but signals which are in fact real input signals are not blanked out.

### Time-constant spectrum

The automatic comparison of the test sweep and reference sweep with the Auto ID function can only be applied usefully for signals with a time-constant spectrum since the two sweeps are always required to determine the actual spectrum.

### Mixer products with low S/N ratio

If the S/N ratio of a mixer product is lower than the user-defined threshold, the level difference between the test sweep and reference sweep at the frequency of this mixer product is always within limits, even if the signal occurs in one of the sweeps only. Such mixer products cannot be identified by the Auto ID function. It is therefore recommended that you perform a visual comparison of the test sweep and reference sweep using the Signal ID function.

### **Examining unwanted mixer products with small span**

With large spans in which non-modulated sine-wave signals are represented as single lines, unwanted mixer products are generally completely blanked out. However, if you examine the frequency range containing a blanked signal in detail using a small span, e.g. an image-frequency response, part of the signal may nevertheless be displayed. This happens when the displayed components of a blanked signal have a level difference which is smaller than the user-defined threshold when compared with the noise floor. These components are therefore not blanked out.

An unwanted signal with an S/N ratio that corresponds approximately to the user-defined threshold may not be blanked out permanently. Due to the fact that the noise display varies from one sweep to another, the S/N ratio changes and thus the level difference between the test sweep and reference sweep measured at a frequency changes as well. As a result, the criterion for detecting unwanted signals is not fulfilled. To blank out unwanted signals permanently, an almost constant noise indication is therefore required. This can be achieved by reducing the video bandwidth. Since the average noise indication lies well below the generated noise peak values, the minimum level diminishes. For identification using the Auto ID function, signals should have this minimum noise level.

### **Display of mixer products at the same frequency**

If the input signal consists of a very large number of spectral components, it will become more and more probable that two different unwanted mixer products will be displayed at the same frequency in the test sweep and reference sweep.

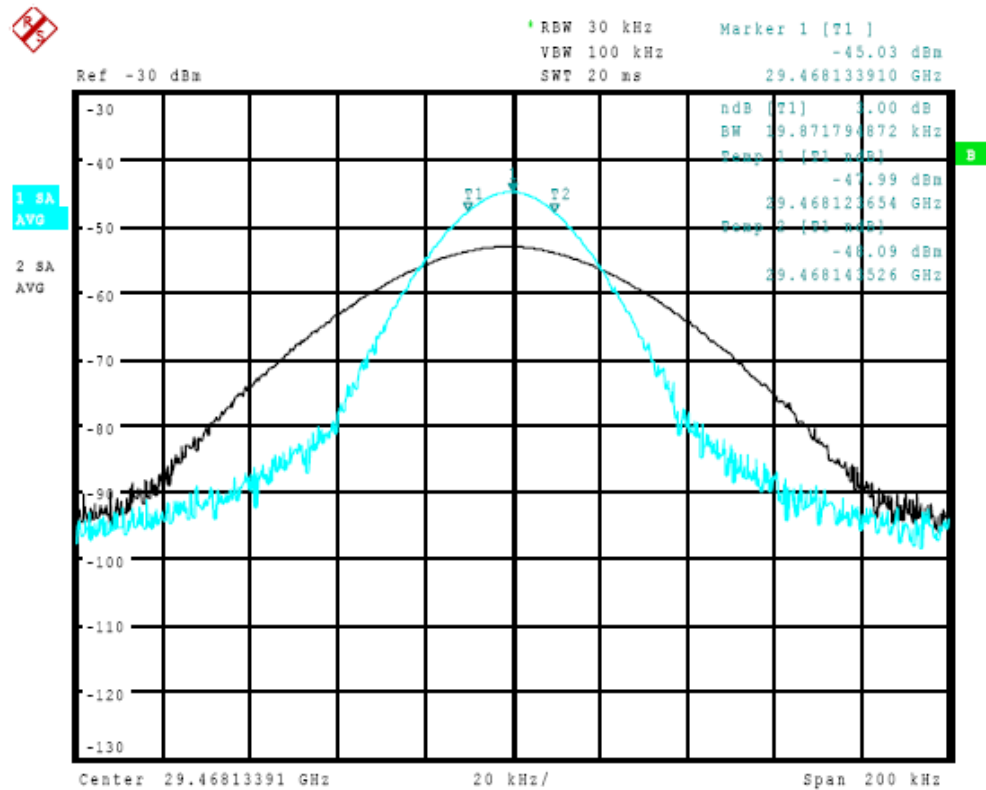

Figure 7-19: Different mixer products displayed at the same frequency in the test sweep and reference sweep (large span)

#### Example:

The external mixer is set to use the 2nd order harmonic. The signal recorded in the test sweep is displayed by trace 1. The IF filter of the FSW is represented at a 3 dB bandwidth of 20 kHz, the real IF bandwidth being 30 kHz. If, however, the 3 dB bandwidth of the signal recorded in the reference sweep is examined (trace 2), it will be found to be larger exactly by a factor of 2. This shows that the two products were generated by mixing with LO harmonics of different orders. The signal recorded in the test sweep was generated by mixing with the 3rd order harmonic. Since the frequency axis scaling is based on the 2nd order, the mixer product or the resulting diagram of the IF filter is compressed by a factor of  $2/3$ . The signal recorded in the reference sweep was generated by mixing with the fundamental of the LO signal. Since the frequency axis scaling is based on the 2nd order, the mixer product or the resulting diagram of the IF filter is expanded by a factor of 2.

Automatic identification with a large span is not possible since the two mixer products are displayed at the same frequency. The diagram shown in Figure 7-20 is obtained when examining products with a narrow span using the Auto ID function. You can easily recognize unwanted mixer products in the diagram obtained using one of the automatic detection functions.

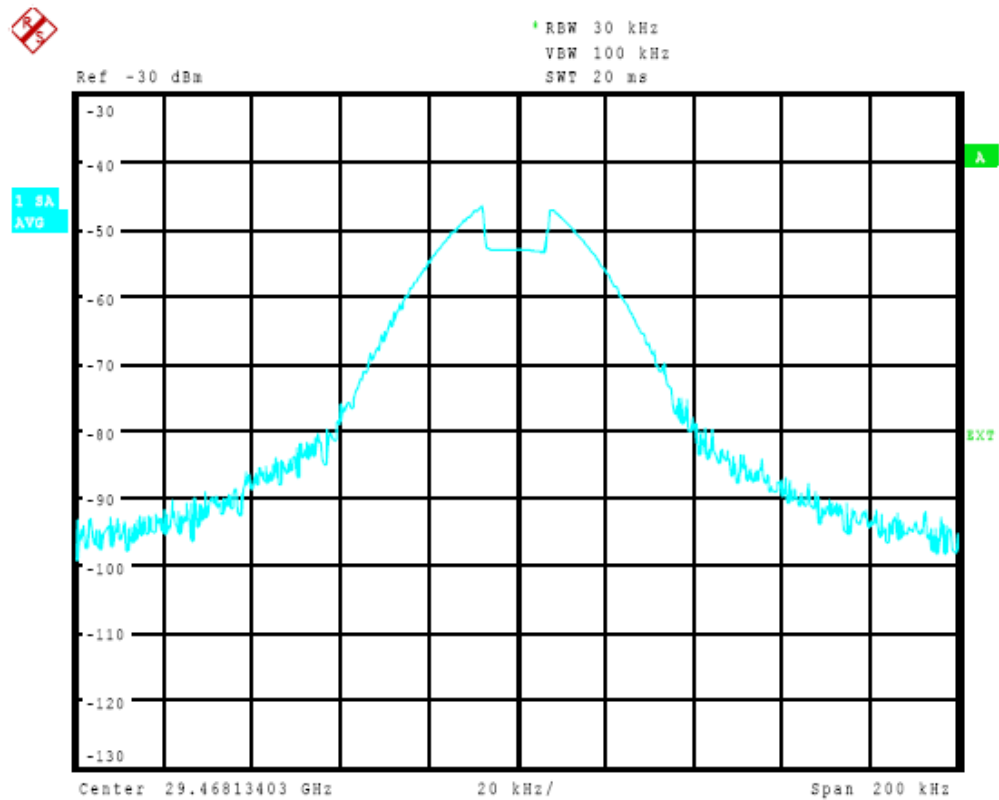

Figure 7-20: Unwanted mixer products displayed for small span

### 7.2.6.2 External mixer settings

**Access:** [INPUT/OUTPUT] > "External Mixer Config"

Note that external mixers are not supported in MSRA/MSRT mode.

Special conversion loss tables (in .b5g or .b2g files) cannot be edited within the FSW firmware; they can only be imported and deleted.

See "External mixers and large bandwidth extension options" on page 416

- [Mixer settings](#).....423
- [Basic settings](#).....427
- [Managing conversion loss tables](#).....429
- [Creating and editing conversion loss tables](#).....431

#### Mixer settings

**Access:** [INPUT/OUTPUT] > "External Mixer Config" > "Mixer Settings"

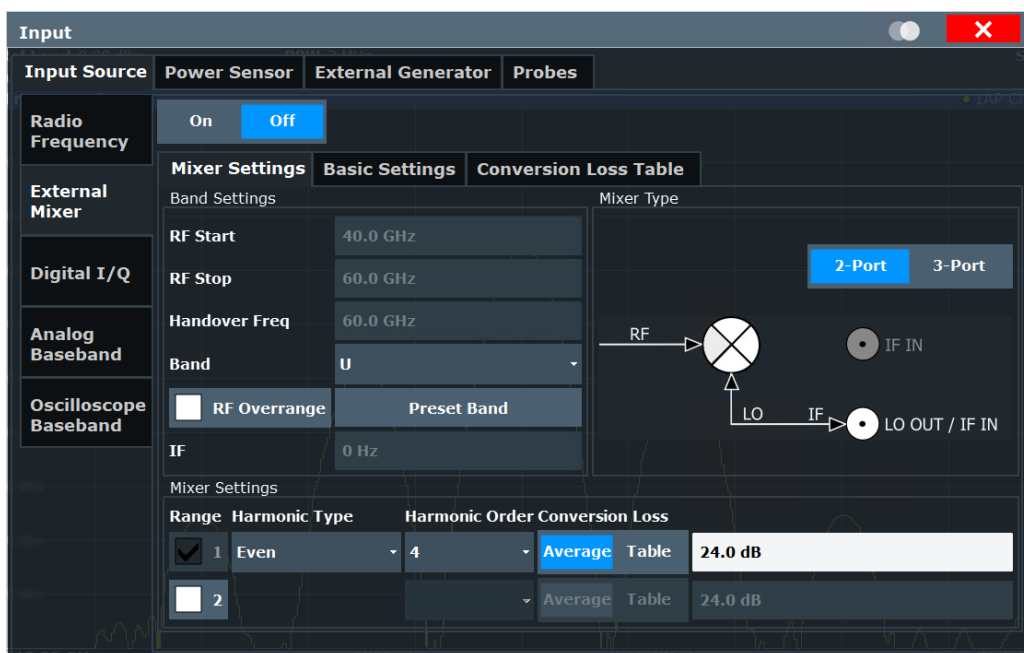

External Mixer (State)..... 424

RF Start / RF Stop.....424

Handover Freq..... 425

Band.....425

RF Overrange..... 425

Preset Band..... 425

IF..... 426

Mixer Type.....426

Mixer Settings (Harmonics Configuration)..... 426

- └ Range 1/Range 2.....426
- └ Harmonic Type.....426
- └ Harmonic Order..... 426
- └ Conversion Loss..... 427

**External Mixer (State)**

Activates or deactivates the external mixer for input. If activated, "ExtMix" is indicated in the channel bar of the application, together with the used band (see "Band" on page 425).

Remote command:

```
[SENSe:]MIXer<x>[:STATe] on page 1144
```

**RF Start / RF Stop**

Displays the start and stop frequency of the selected band (read-only).

The frequency range for the user-defined band is defined via the harmonics configuration (see "Range 1/Range 2" on page 426).

For details on available frequency ranges, see [table 13-4 on page 1148](#).



Remote command:

[\[SENSe:\]MIXer<x>:FREQuency:START](#) on page 1147

[\[SENSe:\]MIXer<x>:FREQuency:STOP](#) on page 1147

### Handover Freq

If due to the LO frequency the conversion of the input signal is not possible using one harmonic, the band must be split. An adjacent, partially overlapping frequency range can be defined using different harmonics. In this case, the sweep begins using the harmonic defined for the first range. At the specified "handover frequency" in the overlapping range, it switches to the harmonic for the second range.

The handover frequency can be selected freely within the overlapping frequency range.

Remote command:

[\[SENSe:\]MIXer<x>:FREQuency:HANDOver](#) on page 1147

### Band

Defines the waveguide frequency band or user-defined frequency band to be used by the mixer.

The start and stop frequencies of the selected band are displayed in the "RF Start" and "RF Stop" fields.

For a definition of the frequency range for the pre-defined bands, see [table 13-4 on page 1148](#).

The mixer settings for the user-defined band can be selected freely. The frequency range for the user-defined band is defined via the harmonics configuration (see "[Range 1/Range 2](#)" on page 426).

Remote command:

[\[SENSe:\]MIXer<x>:HARMonic:BAND](#) on page 1148

### RF Overage

Sometimes, the harmonics defined for a specific band allow for an even larger frequency range than the band requires. By default, the pre-defined range is used. However, you can take advantage of the extended frequency range by overriding the defined "RF Start" and "RF Stop" frequencies by the maximum values.

If "RF Overage" is enabled, the frequency range is not restricted by the band limits ("RF Start" and "RF Stop"). In this case, the full frequency range that can be reached using the selected harmonics is used.

Remote command:

[\[SENSe:\]MIXer<x>:RFOVerrange\[:STATe\]](#) on page 1152

### Preset Band

Restores the presettings for the selected band.

**Note:** changes to the band and mixer settings are maintained even after using the [PRESET] function. This function allows you to restore the original band settings.

Remote command:

[\[SENSe:\]MIXer<x>:HARMonic:BAND:PRESet](#) on page 1148

**IF**

Displays the intermediate frequency currently used by the external mixer (for reference and in the I/Q Analyzer only).

Remote command:

`[SENSe:]MIXer<x>:IF?` on page 1150

**Mixer Type**

The External Mixer option supports the following external mixer types:

**Note:** For measurements with a bandwidth larger than 2 GHz and an external mixer, only 3-port mixers are supported.

For more information, see "[External mixers and large bandwidth extension options](#)" on page 416.

"2 Port"            LO and IF data use the same port

"3 Port"            LO and IF data use separate ports

Remote command:

`[SENSe:]MIXer<x>:PORTs` on page 1152

**Mixer Settings (Harmonics Configuration)**

The harmonics configuration determines the frequency range for user-defined bands (see "[Band](#)" on page 425).

**Range 1/Range 2 ← Mixer Settings (Harmonics Configuration)**

Enables the use of one or two frequency ranges, where the second range is based on another harmonic frequency of the mixer to cover the band's frequency range.

For each range, you can define which harmonic to use and how the conversion loss is handled.

Remote command:

`[SENSe:]MIXer<x>:HARMonic:HIGH:STate` on page 1149

**Harmonic Type ← Mixer Settings (Harmonics Configuration)**

Defines if only even, only odd, or even and odd harmonics can be used for conversion. Depending on this selection, the order of harmonic to be used for conversion changes (see "[Harmonic Order](#)" on page 426). Which harmonics are supported depends on the mixer type.

Remote command:

`[SENSe:]MIXer<x>:HARMonic:TYPE` on page 1149

**Harmonic Order ← Mixer Settings (Harmonics Configuration)**

Defines which order of the harmonic of the LO frequencies is used to cover the frequency range.

By default, the lowest order of the specified harmonic type is selected that allows conversion of input signals in the whole band. If due to the LO frequency the conversion is not possible using one harmonic, the band is split.

For the "USER" band, the order of harmonic is defined by the user. The order of harmonic can be between 2 and 128, the lowest usable frequency being 16.88 GHz.

Remote command:

[\[SENSe:\]MIXer<x>:HARMonic\[:LOW\]](#) on page 1150

[\[SENSe:\]MIXer<x>:HARMonic:HIGH\[:VALue\]](#) on page 1149

### Conversion Loss ← Mixer Settings (Harmonics Configuration)

Defines how the conversion loss is handled. The following methods are available:

"Average" Defines the average conversion loss for the entire frequency range in dB.

"Table" Defines the conversion loss via the table selected from the list. Pre-defined conversion loss tables are often provided with the external mixer and can be imported to the FSW. Alternatively, you can define your own conversion loss tables. Imported tables are checked for compatibility with the current settings before being assigned. Conversion loss tables are configured and managed in the [Conversion Loss Table](#) tab.

For details on conversion loss tables, see ["Conversion loss tables"](#) on page 414.

For details on importing tables, see ["Import Table"](#) on page 431.

Remote command:

Average for range 1:

[\[SENSe:\]MIXer<x>:LOSS\[:LOW\]](#) on page 1152

Table for range 1:

[\[SENSe:\]MIXer<x>:LOSS:TABLE\[:LOW\]](#) on page 1151

Average for range 2:

[\[SENSe:\]MIXer<x>:LOSS:HIGH](#) on page 1150

Table for range 2:

[\[SENSe:\]MIXer<x>:LOSS:TABLE:HIGH](#) on page 1151

### Basic settings

**Access:** [INPUT/OUTPUT] > "External Mixer Config" > "Basic Settings"

The basic settings concern general use of an external mixer. They are only available if the [External Mixer \(State\)](#) is "On".

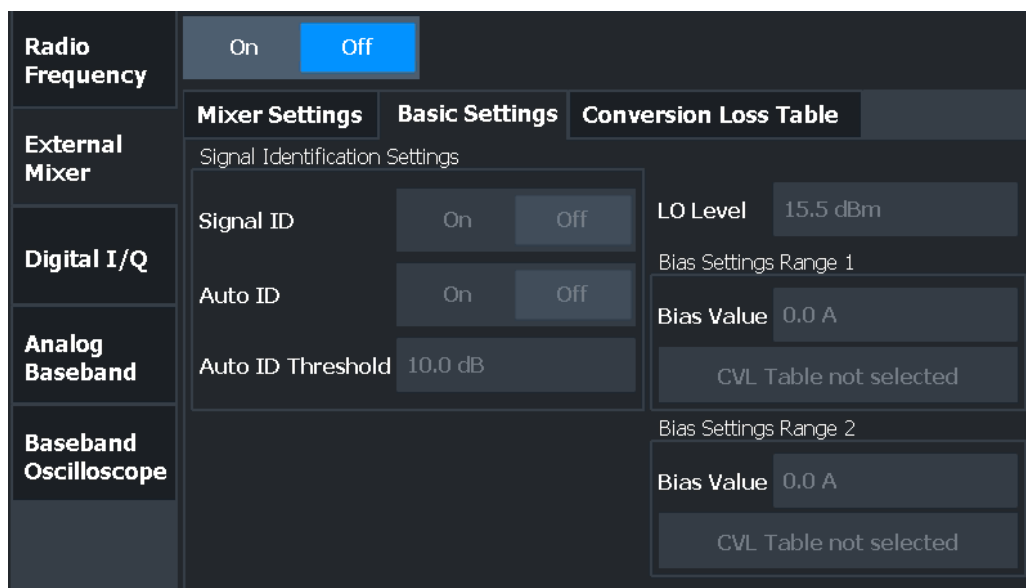

LO Level.....428

Signal ID.....428

Auto ID.....428

Auto ID Threshold.....429

Bias Value.....429

    ↳ Write to CVL table.....429

**LO Level**

Defines the LO level of the external mixer's LO port. Possible values are from 13.0 dBm to 17.0 dBm in 0.1 dB steps. Default value is 15.5 dB.

Remote command:

[SENSe:]MIXer<x>:LOPower on page 1145

**Signal ID**

Activates or deactivates visual signal identification. Two sweeps are performed alternately. Trace 1 shows the trace measured on the upper side band (USB) of the LO (the test sweep). Trace 2 shows the trace measured on the lower side band (LSB), i.e. the reference sweep.

Note that automatic signal identification is only available for measurements that perform frequency sweeps (not in the VSA or the I/Q Analyzer, for instance).

(See also "Automatic signal identification" on page 418).

Mathematical functions with traces and trace copy cannot be used with the Signal ID function.

Remote command:

[SENSe:]MIXer<x>:SIGNal on page 1145

**Auto ID**

Activates or deactivates automatic signal identification.

Auto ID basically functions like [Signal ID](#). However, the test and reference sweeps are converted into a single trace by a comparison of maximum peak values of each sweep point. The result of this comparison is displayed in trace 3 if "Signal ID" is active at the same time. If "Signal ID" is not active, the result can be displayed in any of the traces 1 to 3. Unwanted mixer products are suppressed in this calculated trace.

Note that automatic signal identification is only available for measurements that perform frequency sweeps (not in vector signal analysis or the I/Q Analyzer, for instance).

**Note:** The "Auto ID" function is now also available for [Spectrum emission mask \(SEM\) measurement](#) and [Spurious emissions measurement](#) using an external mixer.

(See also "[Automatic signal identification](#)" on page 418).

Remote command:

`[SENSe:]MIXer<x>:SIGNal` on page 1145

### Auto ID Threshold

Defines the maximum permissible level difference between test sweep and reference sweep to be corrected during automatic comparison ("[Auto ID](#)" on page 428 function). The input range is between 0.1 dB and 100 dB. Values of about 10 dB (i.e. default setting) generally yield satisfactory results.

(See also "[Automatic signal identification](#)" on page 418).

Remote command:

`[SENSe:]MIXer<x>:THReshold` on page 1146

### Bias Value

Define the bias current for each range, which is required to set the mixer to its optimum operating point. It corresponds to the short-circuit current. The bias current can range from -10 mA to 10 mA. The actual bias current is lower because of the forward voltage of the mixer diode(s).

**Tip:** The trace in the currently active result display (if applicable) is adapted to the settings immediately so you can check the results.

To store the bias setting in the currently selected conversion loss table, select [Write to CVL table](#).

Remote command:

`[SENSe:]MIXer<x>:BIAS[:LOW]` on page 1145

`[SENSe:]MIXer<x>:BIAS:HIGH` on page 1144

### Write to CVL table ← Bias Value

Stores the bias setting in the currently selected "Conversion Loss Table" for the range. If no conversion loss table is selected yet, this function is not available ("CVL Table not selected").

(See "[Conversion Loss](#)" on page 427).

Remote command:

`[SENSe:]CORRection:CVL:BIAS` on page 1153

### Managing conversion loss tables

**Access:** [INPUT/OUTPUT] > "External Mixer Config" > "Conversion Loss Table"

In this tab, you configure and manage conversion loss tables. Conversion loss tables consist of value pairs that describe the correction values for conversion loss at certain frequencies. The correction values for frequencies between the reference points are obtained via interpolation.

The currently selected table for each range is displayed at the top of the dialog box. All conversion loss tables found in the instrument's C:\R\_S\INSTR\USER\cv1\ directory are listed in the "Modify Tables" list.

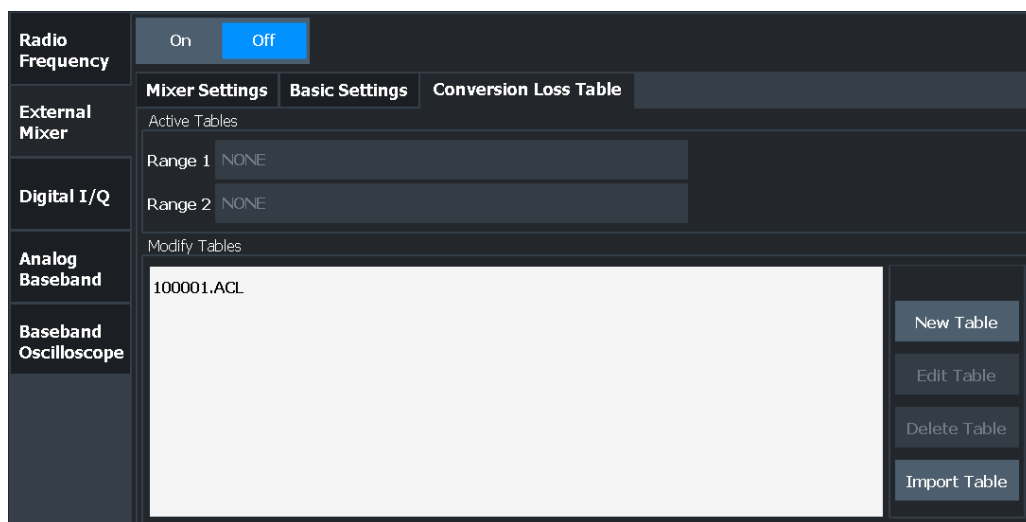

[New Table](#)..... 430

[Edit Table](#)..... 430

[Delete Table](#)..... 430

[Import Table](#)..... 431

**New Table**

Opens the "Edit conversion loss table" dialog box to configure a new conversion loss table.

For details on table configuration, see ["Creating and editing conversion loss tables"](#) on page 431.

Remote command:

[\[SENSe:\]CORRection:CVL:SElect](#) on page 1156

**Edit Table**

Opens the "Edit conversion loss table" dialog box to edit the selected conversion loss table.

For details on table configuration, see ["Creating and editing conversion loss tables"](#) on page 431.

Remote command:

[\[SENSe:\]CORRection:CVL:SElect](#) on page 1156

**Delete Table**

Deletes the currently selected conversion loss table after you confirm the action.

Remote command:

[SENSe:]CORRection:CVL:CLEAr on page 1154

### Import Table

Imports one or more stored conversion loss tables from any directory and copies them to the instrument's `C:\R_S\INSTR\USER\cvl\` directory. They can then be assigned for use for a specific frequency range (see "Conversion Loss" on page 427).

#### Note:

Before copying any files to the `C:\R_S\INSTR\USER\cvl\` directory, the FSW firmware moves any existing user-defined cvl tables to a `backup` subdirectory. To use a user-defined cvl table later, select the file in the `C:\R_S\INSTR\USER\cvl\backup` directory.

**Note:** If the bandwidth extension options R&S FSW-B6001/-B8001 are active, external mixers are supported for an analysis bandwidth up to 4 GHz.

Measurements using bandwidth extension options over 512 MHz require special conversion loss tables, see [Table 7-1](#).

Supported tables have the file extension `.b2g` or `.b5g`, as opposed to `.acl` for common tables. While `.acl` files can be used, data acquisition with larger bandwidths using such conversion loss tables leads to substantial inaccuracy. Using no conversion loss tables at all during data acquisition with the larger bandwidth options causes even more inaccuracy.

Note that only common conversion loss tables (in `.acl` files) can be edited. Special conversion loss tables (in `.b2g` or `.b5g` files) can only be imported and deleted.

For more details, see "[External mixers and large bandwidth extension options](#)" on page 416.

Remote command:

MMEM:COPY '<conversionlosstable>',C:\R\_S\INSTR\USER\cvl\

See [MMEMory:COPY](#) on page 1350

### Creating and editing conversion loss tables

**Access:** [INPUT/OUTPUT] > "External Mixer Config" > "Conversion Loss Table" > "New Table" / "Edit Table"

Conversion loss tables can be newly defined and edited.



Note that only common conversion loss tables (in `.acl` files) can be edited. Special conversion loss tables (in `.b2g` or `.b5g` files) can only be imported and deleted.

For details see "[External mixers and large bandwidth extension options](#)" on page 416.

A preview pane displays the current configuration of the conversion loss function as described by the position/value entries.

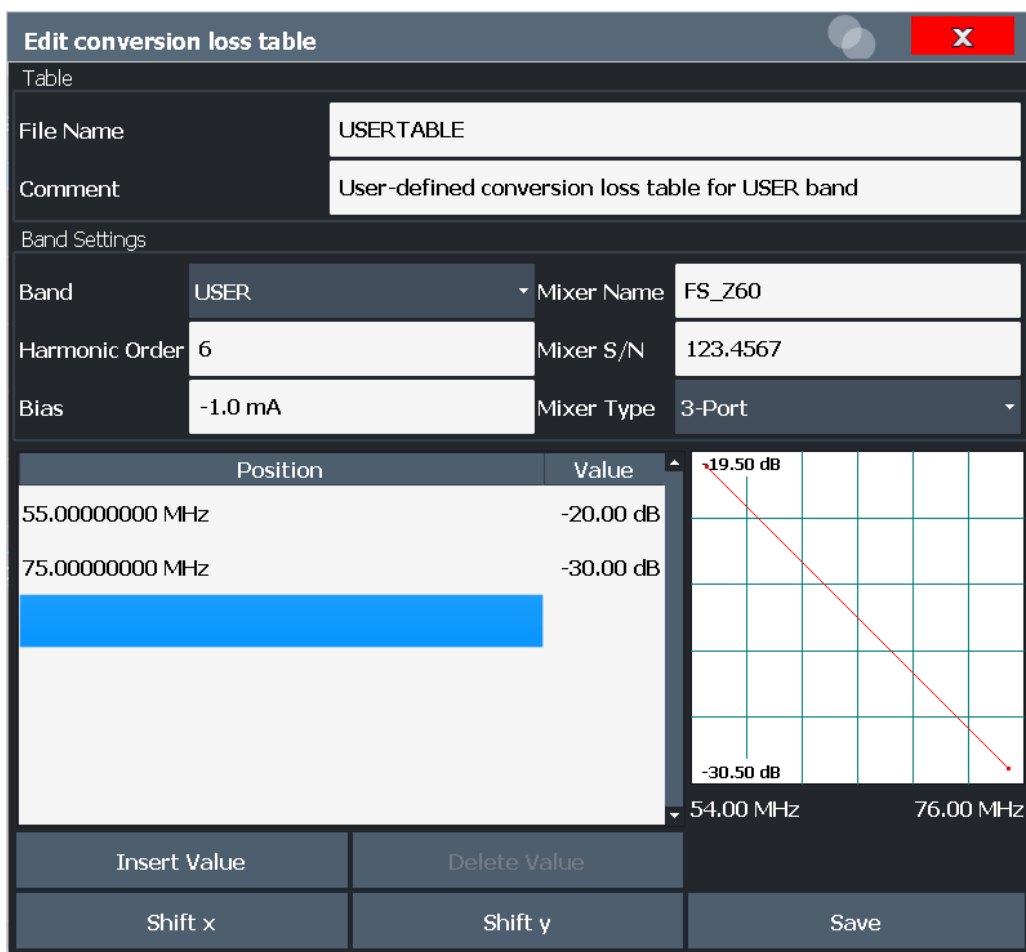

File Name.....432

Comment.....433

Band.....433

Harmonic Order.....433

Bias.....433

Mixer Name.....433

Mixer S/N.....433

Mixer Type.....434

Position/Value.....434

Insert Value.....434

Delete Value.....434

Shift x.....434

Shift y.....434

Save.....434

**File Name**

Defines the name under which the table is stored in the C:\R\_S\INSTR\USER\cv1\ directory on the instrument. The name of the table is identical to the name of the file (without extension) in which the table is stored. This setting is mandatory. The .ACL extension is automatically appended during storage.



Remote command:

[\[SENSe:\]CORRection:CVL:SElect](#) on page 1156

### Comment

An optional comment that describes the conversion loss table. The comment is user-definable.

Remote command:

[\[SENSe:\]CORRection:CVL:COMMeNt](#) on page 1154

### Band

The waveguide or user-defined band to which the table applies. This setting is checked against the current mixer setting before the table can be assigned to the range.

For a definition of the frequency range for the pre-defined bands, see [table 13-4 on page 1148](#).

Remote command:

[\[SENSe:\]CORRection:CVL:BAND](#) on page 1153

### Harmonic Order

The harmonic order of the range to which the table applies. This setting is checked against the current mixer setting before the table can be assigned to the range.

Remote command:

[\[SENSe:\]CORRection:CVL:HARMOnic](#) on page 1155

### Bias

The bias current which is required to set the mixer to its optimum operating point. It corresponds to the short-circuit current. The bias current can range from -10 mA to 10 mA. The actual bias current is lower because of the forward voltage of the mixer diode(s).

**Tip:** You can also define the bias interactively while a preview of the trace with the changed setting is displayed, see ["Bias Value"](#) on page 429.

Remote command:

[\[SENSe:\]CORRection:CVL:BIAS](#) on page 1153

### Mixer Name

Specifies the name of the external mixer to which the table applies. This setting is checked against the current mixer setting before the table can be assigned to the range.

Remote command:

[\[SENSe:\]CORRection:CVL:MIXer](#) on page 1155

### Mixer S/N

Specifies the serial number of the external mixer to which the table applies.

The specified number is checked against the currently connected mixer number before the table can be assigned to the range.

Remote command:

[\[SENSe:\]CORRection:CVL:SNUMber](#) on page 1157

**Mixer Type**

Specifies whether the external mixer to which the table applies is a two-port or three-port type. This setting is checked against the current mixer setting before the table can be assigned to the range.

Remote command:

[\[SENSe:\]CORRection:CVL:PORTs](#) on page 1156

**Position/Value**

Each position/value pair defines the conversion loss value in dB for a specific frequency. Enter the reference values in order of increasing frequencies. You can define a maximum of 500 reference values. To enter a new value pair, select an empty space in the "Position"/"Value" table, or select [Insert Value](#).

Correction values for frequencies between the reference values are interpolated. Linear interpolation is performed if the table contains only two values. If it contains more than two reference values, spline interpolation is carried out. Outside the frequency range covered by the table, the conversion loss is assumed to be the same as for the first and last reference value.

The current configuration of the conversion loss function as described by the position/value entries is displayed in the preview pane to the right of the table.

Remote command:

[\[SENSe:\]CORRection:CVL:DATA](#) on page 1155

**Insert Value**

Inserts a new position/value entry in the table.

If the table is empty, a new entry at 0 Hz is inserted.

If entries already exist, a new entry is inserted above the selected entry. The position of the new entry is selected such that it divides the span to the previous entry in half.

**Delete Value**

Deletes the currently selected position/value entry.

**Shift x**

Shifts all positions in the table by a specific value. The value can be entered in the edit dialog box. The conversion loss function in the preview pane is shifted along the x-axis.

**Shift y**

Shifts all conversion loss values by a specific value. The value can be entered in the edit dialog box. The conversion loss function in the preview pane is shifted along the y-axis.

**Save**

The conversion loss table is stored under the specified file name in the `C:\R_S\INSTR\USER\cv1\` directory of the instrument.

### 7.2.6.3 How to work with external mixers

The required tasks to work with external mixers are described step-by-step:

- ["To connect a three-port mixer"](#) on page 435
- ["To connect a two-port mixer"](#) on page 436
- ["To activate and configure the external mixer"](#) on page 436
- ["To define a new conversion loss table"](#) on page 437
- ["To shift the conversion loss values"](#) on page 437



For remote operation, see ["Programming example: working with an external mixer"](#) on page 1157.

### To connect a three-port mixer

External mixers can be connected at the LO OUT/IF IN and IF IN female connectors (if option is installed). Both two-port and three-port mixers can be used. Connect the mixer as follows:

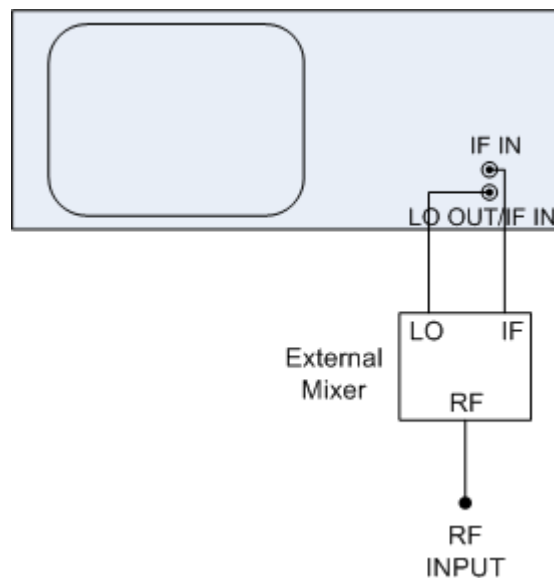

Use the supplied coaxial cable to feed in the LO signal. If no external mixers are connected to the FSW, cover the two front connectors [LO OUT / IF IN] and [IF IN] with the SMA caps supplied.

1. Connect the LO OUT / IF IN output of the FSW to the LO port of the external mixer.
2. Connect the IF IN input of the FSW to the IF port of the external mixer.
3. Feed the signal to be measured to the RF input of the external mixer.

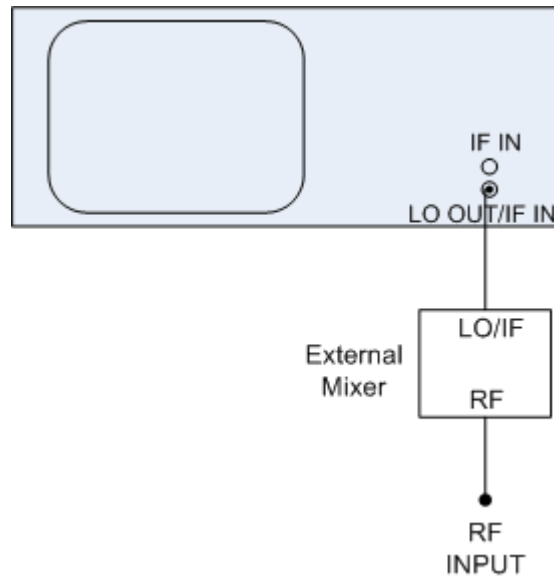
**To connect a two-port mixer**

1. Connect the LO OUT / IF IN output of the FSW to the LO/IF port of the external mixer. The nominal LO level is 15.5 dBm.  
Because of the diplexer contained in the FSW, the IF signal can be tapped from the line which is used to feed the LO signal to the mixer.
2. Feed the signal to be measured to the RF input of the external mixer.

**To activate and configure the external mixer**

1. Select "INPUT > Input Source Config > External Mixer: ON" to activate the external mixer for the current application.
2. Select "Mixer Settings > Band" to define the required frequency range.
3. From the "Band" selection list, select the required band.
4. In the Mixer Settings, select "Conversion Loss: Table" for Range 1 to define frequency-dependent level correction.
5. From the selection list, select a conversion loss table stored on the instrument. No further settings are necessary since the selected file contains all required parameters. If the selected table is not valid for the selected band, an error message is displayed.  
If no conversion loss table is available yet, create a new table first (as described in ["To define a new conversion loss table"](#) on page 437).
6. Optionally, select "Basic Settings > Auto ID: On" to activate automatic signal identification.
7. If necessary, adapt the tolerance limit by selecting "Basic Settings > Auto ID Threshold".

**To define a new conversion loss table**

1. Select "INPUT > Input Source Config > External Mixer > Conversion Loss Table".
2. Select "New Table".
3. Define a file name and, optionally, a comment for the new table.
4. Define the band and mixer settings for which the conversion loss table is to be used. These settings will be compared to the current mixer settings during the validation check when the table is imported.
5. Define the reference values for the frequency-dependant conversion loss:
  - a) Select "Insert Value" to add a new row in the table.
  - b) Enter the first reference frequency.
  - c) Enter the corresponding conversion loss value.  
The conversion loss function is updated and displayed in the preview diagram in the dialog box.
  - d) Repeat these steps to define up to 500 reference values. Remember to define the values in ascending order of frequencies.
6. Select "Save".

The table is stored and is then available for import and assignment to a specific frequency range.

**To shift the conversion loss values**

In order to increase each reference value in the conversion-loss table a constant value ( $a_0$ ), the values can be shifted either in x-direction or in y-direction.

1. Select "INPUT > Input Source Config > External Mixer > Conversion Loss Table".
2. Select the assigned conversion loss table.
3. Select "Edit Table".
4. Select "Shift y" and enter the constant value  $\langle a_0 \rangle$  to shift all y-values in the table by this value.  
Or:  
Select "Shift x" and enter the constant value  $\langle a_0 \rangle$  to shift all x-values in the table by this value.
5. Select "Save".

**7.2.6.4 Measurement examples: using an external mixer****Measurement example 1: two-port mixer**

The following example demonstrates the basic operation of an external two-port mixer as well as the required settings. A sine wave signal with  $f = 14.5$  GHz is applied to the input of a multiplier. The spectrum at the multiplier output is to be recorded in the range

of 52 GHz to 60 GHz using a 2-port mixer for the V band. The mixer used is a double-diode mixer. The example of operation is described in the following steps:

- "To set up the measurement" on page 438
- "To activate and configure the external mixer" on page 438
- "To take into account the cable loss in the IF path" on page 439

#### To set up the measurement

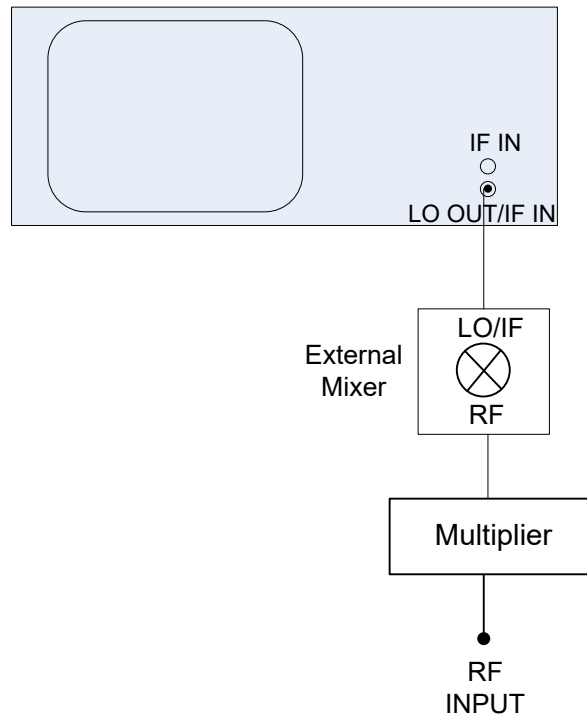

**Figure 7-21: External Mixer test setup**

1. Connect the [LO OUT / IF IN] output of the FSW to the [LO/IF] port of the external mixer.
2. Connect the multiplier to the RF input of the external mixer.
3. Apply a sine wave signal with  $f = 14.5 \text{ GHz}$  to the input of the multiplier.

#### To activate and configure the external mixer

1. Select "INPUT > Input Source Config > External Mixer: ON" to activate the external mixer for the current application.
2. Select "Mixer Settings > Band" to define the required frequency range.
3. From the "Band" selection list, select the band "V".
4. In the Mixer Settings, select "Conversion Loss: Table" for Range 1 to define frequency-dependent level correction.

5. From the selection list, select a conversion loss table stored on the instrument. No further settings are necessary since the selected file contains all required parameters. If the selected table is not valid for the selected band, an error message is displayed.  
If no conversion loss table is available yet, create a new table first (as described in ["To define a new conversion loss table"](#) on page 437).
6. A span is automatically set which covers the whole V band (50 GHz to 75 GHz).
7. Reduce the video bandwidth by selecting "BW > Video Bandwidth Manual": 1 MHz. This allows for correct signal identification using the Auto ID function (see also ["Automatic signal identification"](#) on page 418).
8. Select "Basic Settings> Auto ID: On" to activate automatic signal identification.
9. Adapt the tolerance limit by selecting "Basic Settings> Auto ID Threshold". The tolerance limit is set to 5 dB in this example.

#### To take into account the cable loss in the IF path

On performing level correction, the conversion loss of the mixer and also the insertion loss  $a_0$  of the cable used to tap off the IF signal are to be taken into account. This additional loss is frequency-dependent.

1. Determine the insertion of the cable at the used intermediate frequency.
2. Increase each reference value in the conversion-loss table by the insertion loss ( $a_0$ ).
  - a) Select "INPUT > Input Source Config > External Mixer > Conversion Loss Table".
  - b) Select the assigned conversion loss table.
  - c) Select "Edit Table".
  - d) Select "Shift y" and enter the insertion loss value  $\langle a_0 \rangle$  to shift all y-values in the table by this value.
3. Select "Save".

#### Measurement example 2: three-port mixer with a large analysis bandwidth

The following example demonstrates the operation of an external three-port mixer with a large analysis bandwidth in the I/Q Analyzer. This example requires the optional bandwidth extension R&S FSW-B5000. It is assumed that this option has been installed and set up and is ready for use.

(See the FSW I/Q Analyzer and I/Q Input User Manual.)

A broadband 5G-modulated signal with a carrier frequency of 58 GHz is applied. The spectrum is to be recorded in the range of 52 GHz to 60 GHz using a 3-port mixer for the V band. The mixer used is an RPG FS-Z75 (new model) double-diode mixer.

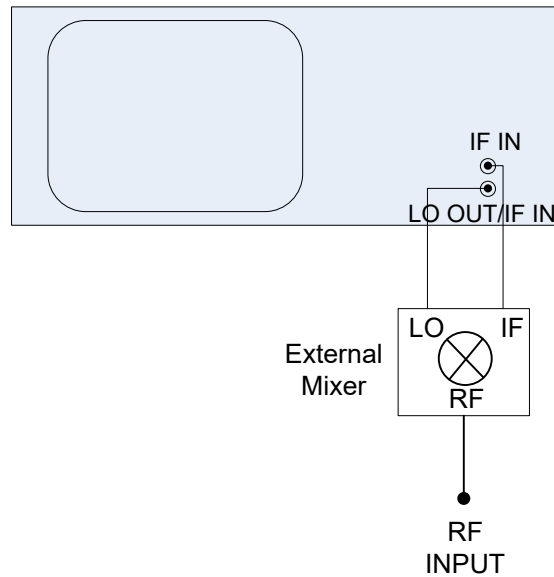
**To set up the measurement****Figure 7-22: 3-port external mixer test setup**

1. Connect the [LO] port of the external mixer to the [LO OUT / IF IN] connector of the FSW.
2. Connect the [IF] port of the external mixer to the [IF IN] connector of the FSW.
3. Apply a 5G-modulated signal with a carrier frequency of 58 GHz to the RF input of the mixer.

**To activate the large analysis bandwidth**

1. Press [Mode].
2. Select the I/Q Analyzer.
3. On the FSW, press [Input/Output].
4. Select "B5000 Config".
5. Set the B5000 "State" to "On".
6. If necessary, start an alignment for the measurement setup with the R&S FSW-B5000.

**To activate and configure the external mixer**

1. Select "INPUT" > "Input Source Config" > "External Mixer": "ON" to activate the external mixer for the current application.
2. Import the conversion loss table for the RPG FS-Z75 mixer, which is provided with the device.
  - a) Select the "Conversion Loss Table" tab.
  - b) Select "Import Table".



- c) From the `C:\R_S\INSTR\USER\cv1` directory, select the `100112_MAG_4_B5000_3G5.B5G` file.
  - d) Select [ENTER].
3. Switch to the "Mixer Settings" tab.
  4. Select the "Mixer Type": "3-port".
  5. Select "Mixer Settings > Band" to define the required frequency range.
  6. From the "Band" selection list, select the band "V".
  7. A span is automatically set which covers the whole V band (50 GHz to 75 GHz).
  8. In the "Mixer Settings", select "Conversion Loss: Table" for Range 1 to define frequency-dependent level correction.
  9. From the selection list, select the `100112_MAG_4_B5000_3G5.B5G` conversion loss table which you imported previously. No further settings are necessary since the selected file contains all required parameters.

Now you can analyze the broadband signal with an analysis bandwidth of 5 GHz.

## 7.2.7 External frontend control (R&S FSW-K553)

If the External Frontend Control option (R&S FSW-K553) is installed, you can control measurements with the FSW using a connected external frontend.

- [External frontend basics](#).....441
- [External frontend settings](#)..... 449
- [How to use an external frontend](#)..... 460
- [Troubleshooting external frontend control](#).....463

### 7.2.7.1 External frontend basics

Due to the physical dimensions of modern spectrum analyzers, long RF cables between the DUT and the analyzer are often necessary in complex setups. When measuring high frequency signals, the long RF cable can lead to unwanted loss.

An external frontend with smaller physical dimensions allows for measurements closer to the DUT. The measurement signal is transferred from the DUT to the analyzer on a lower intermediate frequency (IF), for which loss does not have a major effect.

Thus, the external frontend outsources the conversion of the RF input signal to the IF signal required for processing in the FSW. The external frontend downconverts the high-frequency RF input signal to a lower frequency IF signal using its own internal LO. For all subsequent signal processing steps in the FSW, this process is transparent.

Outsourcing has two main advantages:

- **Extended frequency range:** the external frontend can process RF data in a higher frequency range than the FSW itself supports.  
For example, using an R&S FE44S external frontend, RF signals in a range of 24 GHz to 44 GHz can be measured by an FSW7.

- **Minimized RF cable loss:** in difficult testing environments, long RF cables between the DUT and the FSW are no longer necessary. The external frontend, which is much smaller than the FSW, can be placed closer to the DUT using much shorter RF cables. The required IF cable between the frontend and the FSW is not as vulnerable to distortion effects and power loss. Furthermore, since the IF cable is usually part of the fixed setup, any existing frequency response can be calculated in advance. The FSW can then adapt the actual measurement results automatically. A typical application is a test involving a DUT placed in an RF shield box. The external frontend is connected directly to the shield box, while the FSW is placed in a measurement rack elsewhere in the laboratory.

### Prerequisites

To use an external frontend, the external frontend control option (R&S FSW-K553) must be installed.

Only measurements that support FFT sweeps or I/Q-based measurements, such as the I/Q Analyzer application, can process input from an external frontend.

• <a href="#">Test setup</a> .....	442
• <a href="#">Multiple connections to a single frontend</a> .....	443
• <a href="#">Mismatched settings on multiple connected instruments</a> .....	444
• <a href="#">Using external frontends for spectrum measurements</a> .....	444
• <a href="#">Using external frontends for FFT sweep measurements</a> .....	445
• <a href="#">Activation</a> .....	445
• <a href="#">Configuration</a> .....	445
• <a href="#">External frontend attenuation vs. analyzer attenuation</a> .....	446
• <a href="#">External frontends and FSW85 with two input connectors</a> .....	447
• <a href="#">LO signal input and output</a> .....	447
• <a href="#">Calibration and alignment</a> .....	448
• <a href="#">Diagnostics</a> .....	448
• <a href="#">Adding external devices to the test setup</a> .....	448

### Test setup

Currently, the FSW supports the following external frontend types:

- R&S FE44S
- R&S FE50DTR
- R&S FE110SR
- R&S FE170SR

For details on which FSWs support external frontends, see the instrument's specifications document.

The external frontend is controlled by the FSW via a LAN connection. Up to 2 LAN/SSL connections are supported by the frontend. The data is transferred using an IF cable. In addition, a reference signal is provided from the FSW to the frontend.

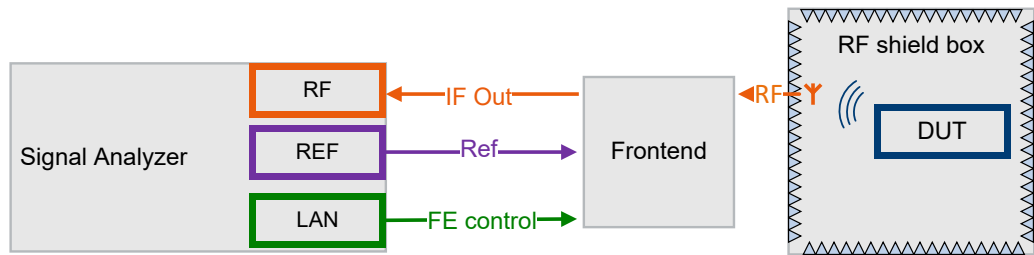

Figure 7-23: Typical setup using an external frontend

For details on setting up the external frontend, see the documentation of the used device.

### Multiple connections to a single frontend

The FE50DTR-type frontend has an RX and a TX signal path. The RX signal path uses the "RF A" and "IF Out A" connectors and is connected to the FSW. The TX path uses the "RF B" and "IF In B" connectors and can be connected to a signal generator. With the latest firmware, both a signal generator and a FSW can use the same frontend at the same time.

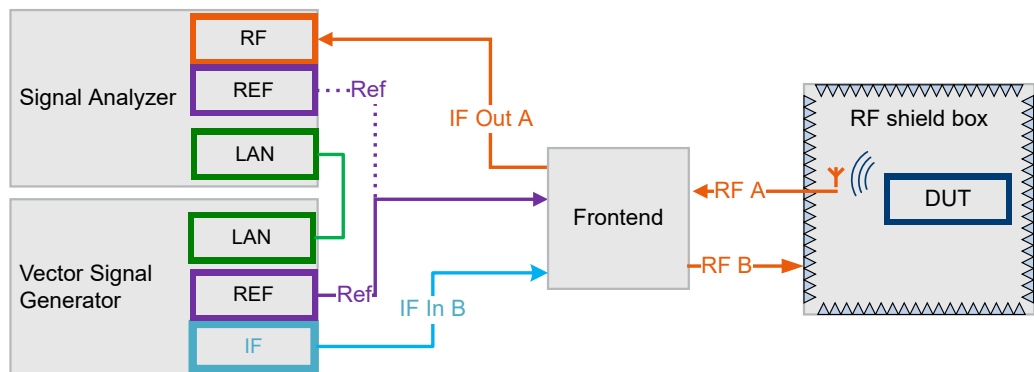

Figure 7-24: Typical setup for multiple instruments connected to one external frontend



### Exclusive use during specific tasks

For specific tasks, the external frontend is blocked exclusively for one connected instrument. In particular:

- When updating the frontend firmware
- During initial connection of an instrument to the frontend, when the device data is exchanged.

If such a task is performed while another instrument that is connected to the same frontend is performing a measurement, an error occurs ("Device busy"). In this case, the running measurement is aborted. The instrument remains connected, though, and you can restart the measurement once the frontend is available again.

Furthermore, only one instrument can access the frontend to change settings at a time. While one connected instrument changes hardware settings on the external frontend, the frontend is locked for the other connected instrument. The second instrument gets a "Device busy" message and must retry when the frontend is available again.

### Mismatched settings on multiple connected instruments

When multiple instruments are connected to the same frontend at the same time, both channels use the same internal LO and thus both signal paths operate on the same frequency. Therefore, if you want to analyze the signal from the generator using the same frontend, make sure the [Frequency Band Configuration](#) is identical on both instruments.

If multiple instruments use the same frontend at the same time, the frequency conversion settings are identical for all connected instruments. Thus, if you change a frequency setting on one instrument while the other is performing a measurement, the measurement results no longer match the original measurement settings. In this case, an error message is displayed ("Settings mismatch"). To restore the original measurement settings on the frontend, change a frontend setting in the FSW dialog. See also ["Configuration"](#) on page 445 and ["Error messages"](#) on page 463.

### Using external frontends for spectrum measurements

Most spectrum measurements support external frontends, except for:

- "Spectrum Emission Mask" measurements
- "Spurious Emissions" measurements
- "Harmonic Distortion" measurements
- "Fast ACLR" measurements
- List evaluation measurements (remote operation, see [Chapter 13.5.15, "List evaluations"](#), on page 1089)

### Restrictions

When using an external frontend in a "Spectrum" application, only the following trigger sources are supported:

- External trigger
- Video trigger

### Using external frontends for FFT sweep measurements

When using an external frontend, the RF input signal is downconverted to the IF frequency using the internal LO of the external frontend. The required LO frequency is determined automatically according to the selected frequency band and the reference frequency. In a basic I/Q measurement, the LO remains fixed during the measurement. It is indicated in the channel info bar and the [Frontend configuration settings](#).

For FFT sweep measurements, the LO is adapted during the measurement to cover the entire sweep range. The used IF range is indicated in the channel info bar and the [Frontend configuration settings](#).



When using R&S FE170SR and R&S FE110SR type frontends, make sure you insert the correct waveguide filter for the frequency range you intend to measure. See ["Adding external devices to the test setup"](#) on page 448 and the specifications document for details. Particularly when performing FFT sweeps with these external frontends, frequencies outside the filter range can cause mixer products that produce unexpected signals.

### Activation

Activation is a two-step process. First, global activation allows for the general use of an external frontend for the application. The application adapts the available measurement settings to the connected frontend, for example the available frequency range, reference level and attenuation.

If a measurement is active that does not support an FFT sweep, the basic frequency sweep measurement is automatically selected. For all frequency sweep measurements, the "Sweep type" is set to "FFT".

If a measurement is active that does not support external frontends when you activate the frontend, the basic zero span measurement is automatically selected.

If no frontend is configured yet, the configuration settings become available. The channel bar indicates "Inp: ExtFe".

In a second step, the configured frontend is connected. Due to the two-step process, the frontend can be deactivated temporarily for use by another connected instrument, for example if the frontend has two signal paths. The measurement settings on the FSW remain untouched.

If global activation is stopped, the application adapts the measurement settings to the common settings supported by the FSW.

If an external frontend is configured in the active channel and you start a new application that supports its use, the external frontend settings are automatically copied. However, you can deactivate the frontend or change the settings for individual applications. Only one application can use the frontend at the same time.

### Configuration

You can configure external frontends individually for each measurement application. The settings are preserved after presetting the instrument, and are included in save-

sets. The frontend is controlled and configured by the FSW using the common measurement settings.

There are some minor differences in the measurement settings if an external frontend is active:

- The available frequency range, reference level and attenuation are adapted to the values supported by the configured frontend.
- Amplitude settings refer to the RF input at the external frontend, not the levels at the RF input of the FSW (which is the downconverted IF data from the frontend). However, you can also configure attenuation for the analyzer, see "[External frontend attenuation vs. analyzer attenuation](#)" on page 446.
- Only mechanical attenuation is available. Electronic attenuation, preamplifier, and noise cancellation are not available.
- Auto settings are not available for active external frontends.
- Input coupling is always AC.
- Impedance is always 50  $\Omega$ .
- Only external triggers, I/Q power triggers, and (periodic) time triggers are supported as trigger sources. For spectrum measurements, only external triggers and video triggers are supported.
- Depending on the bandwidth extension options available on the FSW, the maximum I/Q bandwidth is 1 GHz.
- If global activation of the external frontend is on, but the connection state of the configured frontend is off, the FSW application is temporarily "on hold". It is set up for and awaiting input from the external frontend, but the connection is aborted. Thus, further measurement configuration is not possible until the frontend is reconnected, or global activation is stopped.
- The hardware of the FSW is adjusted to the defined reference level for the RF input at the external frontend. It is adjusted optimally for input signals with a crest factor of 10 dB. Thus, the required reference level for an optimal measurement can differ depending on the crest factor of the input signal.
- Input from external frontends cannot be used simultaneously with:
  - External generator control
  - I/Q file input
  - External mixers
  - Analog baseband input

#### External frontend attenuation vs. analyzer attenuation

If an external frontend is active, you can configure the attenuation of the external frontend and the analyzer separately. In both cases, only mechanical attenuation is available.

Defining attenuation at the analyzer can avoid frequent switching at the mechanical attenuator when you switch between applications with different input settings.

Note, however, that in "Auto" mode, the FSW determines the required attenuation at the external frontend for an optimal EVM automatically. If you adapt the attenuation at the frontend and the analyzer manually, the EVM can decrease.

### External frontends and FSW85 with two input connectors

Both RF connectors on the FSW85 can be used for external frontend input. Since the external frontend settings apply to both RF input connectors, you must select the connector the external frontend is connected to. You cannot use the other RF input connector simultaneously for the same channel.

### LO signal input and output

External frontends provide LO input and output connectors.

You can use these connectors, for example:

- To provide an external signal as LO input to the external frontend  
In the frontend configuration settings, you can configure whether the external frontend uses its internal LO frequency, or an external LO provided at the "LO IN" connector. Note that if you configure the external frontend to use an external LO signal, the signal must be provided at the frequency indicated in the dialog. Otherwise, the results of the external frontend are inaccurate.
- To provide an LO signal at the external frontend's "LO OUT" connector. The frequency at which the external frontend provides LO output is indicated in the frontend configuration settings.
- To couple multiple external frontends

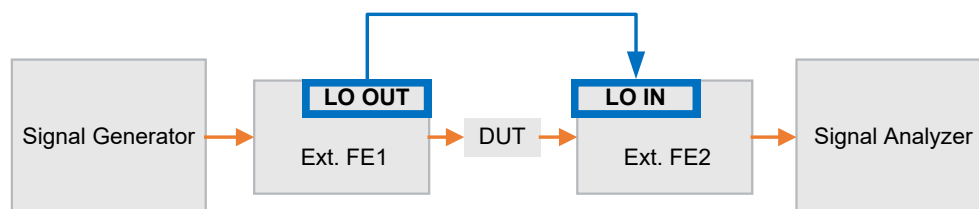

**Figure 7-25: Coupled LO frequencies between multiple external frontends**

Coupling multiple devices by their used LO signals is useful, for example, in setups with multiple input streams to reduce the phase noise.

To use the same LO signal on coupled external frontends, both devices have to use the same LO frequency for upconversion and downconversion. For coupled frontends of the same type, make sure to select the same frequency band configuration for all frontends. (See "[Frequency Band Configuration](#)" on page 452.)

You can also couple an R&S FE170SR and an R&S FE170ST, or an R&S FE110SR and an R&S FE110ST. However, since they are different types of frontend, they can use different LO signals for the same frequency band setting. In this case, use the "Shared LO" setting, which ensures that both devices use the same LO frequency according to a frequency plan.



LO input and output is not available for FFT sweep measurements. In this case, the external frontend always uses its internal LO.



### Missing "Shared LO" setting in stored frequency configurations

The frequency band configuration of the external frontend is stored on the device. Since the "Shared LO" setting was only introduced recently, this setting is not yet implemented on older devices. If you find this setting is missing on your R&S FE170SR and you require it, contact Rohde & Schwarz support.

### Calibration and alignment

The calibration data for the RF input and output signal paths of the frontend are stored on the device. The FSW reads out the data from the connected frontend and aligns the measured data accordingly. The IF cable used to transfer data from the external frontend to the RF input of the FSW must be calibrated during initial connection. Usually, this cable is part of the fixed test setup and is not changed regularly. The calibration data for the IF cable is often provided with the cable as a touchstone (.s2p) file. The FSW can read such files and adapt the measurement results to the frequency response of the cable.

To provide valid results, the frequency response file must provide the S21 parameter for the used frequency range of the external frontend.

Frequency response files are usually provided with the IF cable. The calibration data for the IF cable provided with the FSW is installed on the instrument at the factory.

The .s2p files are stored on the instrument under

```
C:\R_S\INSTR\USER\external_frontends\\  
touchstonefiles\.
```

For example, the files for the IF cable are stored under

```
C:\R_S\Instr\user\external_frontends\FE44S\touchstonefiles\  
if_default_cable_1347_7552_00.s2p.
```

### Diagnostics

The FSW allows you to obtain information on the performance of the connected frontend and to perform a self-test on the frontend. The results can be stored as an XML log file.

### Adding external devices to the test setup

R&S FE170SR and R&S FE110SR type frontends allow you to connect additional external devices to the signal path before the frontend. External devices can amplify or filter the RF signal before the frontend converts it. Using an IX cable, correction data and device information stored on the external device is transferred to the frontend. Thus, the external frontend can consider the correction data for its signal processing. The FSW automatically detects the external frontend and any connected external devices during initial connection. If an external device is connected to the frontend later, a refresh function initiates the detection.



When using R&S FE170SR and R&S FE110SR type frontends, make sure you insert the correct waveguide filter for the frequency range you intend to measure. See the specifications document for details.



**Test setup**

Figure 7-26 illustrates a test setup with an external frontend connected to a FSW and an antenna, which is mounted inside an RF shield box. An additional band filter is inserted between the DUT and the external frontend.

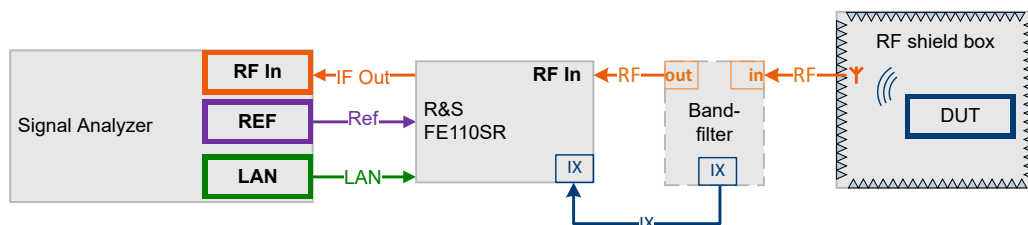

Figure 7-26: Example for a test setup with external devices

**Correcting the signal path**

IF cable loss can occur in the path between the frontend and the FSW. The frequency response for the IF cable is usually provided with the cable and considered by the analyzer. External devices can cause additional losses in the signal path between the DUT and the FSW. If you use the IX cable to connect the external device, the required correction data is automatically passed on from the external device to the frontend. The frontend then considers the data for its internal levelling algorithms and compensates the output values.

For external devices that are not connected to the frontend using an IX cable, you can configure a further correction file for the path between the DUT and the frontend manually.

**7.2.7.2 External frontend settings**

**Access:** "Overview" > "Input" > "Input Source Config" > "Input Source" > "External Frontend"

The following settings are only available if the external frontend control option (R&S FSW-K553) is installed on the FSW.

They are only available for measurements that support FFT sweeps or I/Q-based measurements, such as in the I/Q Analyzer application.

- [Global configuration settings](#).....449
- [Frontend configuration settings](#).....451
- [Diagnostics](#).....455
- [Network configuration](#).....456
- [External Devices](#).....458

**Global configuration settings**

**Access:** "Overview" > "Input" > "Input Source Config" > "Input Source" > "External Frontend" > "Global Config"

In the global configuration settings, you define general settings for the connected external frontend. The general measurement setup is indicated for reference.

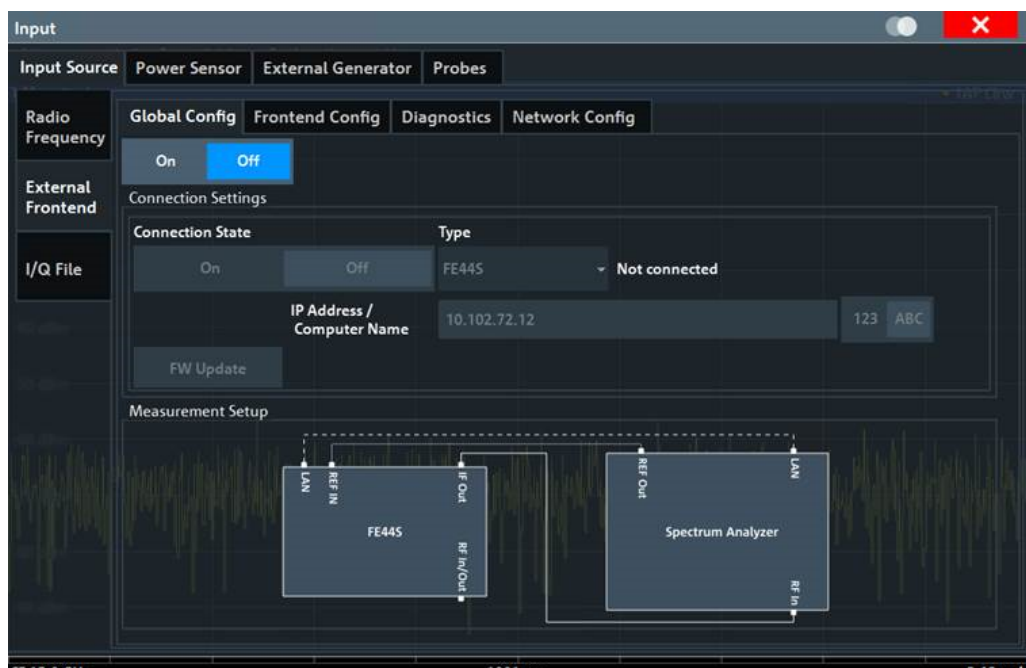

Global activation.....450

External Frontend Connection State.....450

Frontend Type.....451

IP Address/ Computer Name.....451

FW Update.....451

**Global activation**

If enabled, the FSW allows you to configure and connect an external frontend. The application adapts the available measurement settings to the connected frontend, for example the available frequency range, reference level and attenuation.

If a measurement is active that does not support an FFT sweep, the basic frequency sweep measurement is automatically selected. For all measurements, the "Sweep type" is set to "FFT".

If no frontend is configured yet, the configuration settings become available. The channel bar indicates "Inp: ExtFe".

If disabled, the frontend is disconnected. The application adapts the measurement settings to the common settings supported by the FSW.

Remote command:

[SENSe:] EFRontend[:STATe] on page 1124

**External Frontend Connection State**

Connects or disconnects the configured frontend for use in a measurement. Note that this setting is only available if [Global activation](#) of external frontends is set to "On".

It can take up to 10 seconds to determine that LAN connection failed.

If disabled, the connection to the frontend is deactivated temporarily. A running measurement is aborted, the measurement results are indicated as invalid. The measurement settings for the FSW remain untouched.

Remote command:

[\[SENSe:\]EFRontend:CONNECTION\[:STATe\]](#) on page 1116

[\[SENSe:\]EFRontend:CONNECTION:CSTate?](#) on page 1117

### Frontend Type

Defines the type of frontend to be connected.

Currently, the FSW supports the following external frontend types:

- R&S FE44S
- R&S FE50DTR
- R&S FE110SR
- R&S FE170SR

Remote command:

[\[SENSe:\]EFRontend:CONNECTION:CONFIg](#) on page 1116

### IP Address/ Computer Name

The IP address or computer name of the frontend connected to the FSW via LAN. The IP address and computer name are indicated on the electronic ink display on the side panel of the frontend.

By default, the TCPIP address is expected. To enter the computer name, toggle "123"/"ABC" to "ABC".

**Note:** You can change the IP address of the connected frontend directly from the FSW, in the ["Network configuration"](#) on page 456.

Remote command:

[\[SENSe:\]EFRontend:CONNECTION:CONFIg](#) on page 1116

### FW Update

When the FSW establishes a connection to the frontend, it checks the firmware version of the frontend. If the FSW does not support the firmware installed on the frontend, you are asked to update the frontend firmware. You can either start the firmware update immediately, or abort the connection process and update the firmware on the frontend later. In this case, the frontend is not available for use with the FSW until you perform the update.

Remote command:

[\[SENSe:\]EFRontend:FWUPDATE](#) on page 1126

### Frontend configuration settings

**Access:** "Overview" > "Input" > "Input Source Config" > "Input Source" > "External Frontend" > "Frontend Config"

In the frontend configuration tab, frequency information on the connected frontend is provided and you can configure the frequency response for the IF cable.

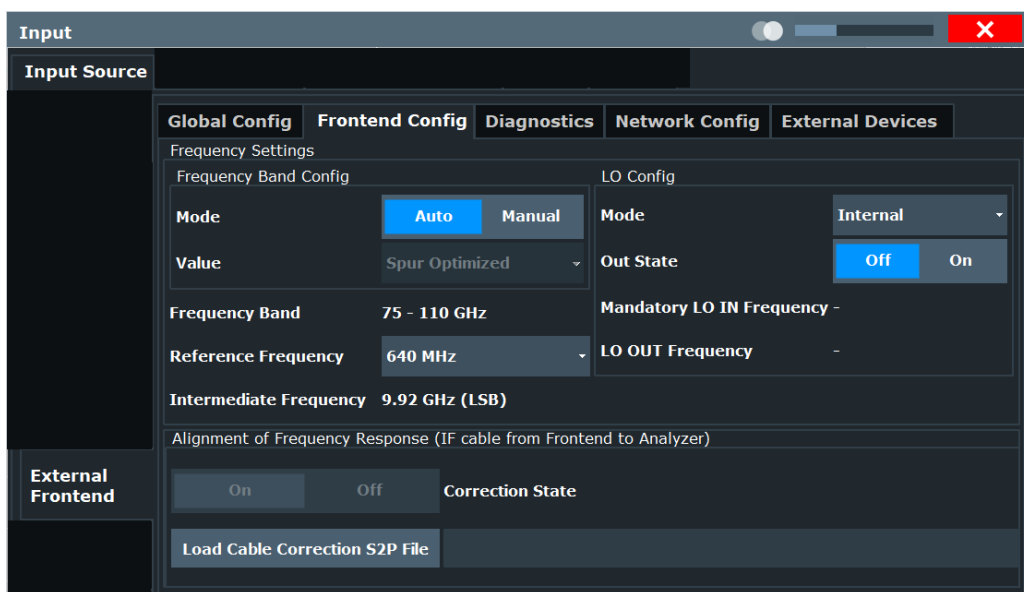

**Mismatched settings on multiple connected instruments**

Multiple instruments can be connected to and use the same frontend at the same time. The frequency conversion settings are identical for all connected instruments. Thus, if you change a frequency setting on one instrument while the other is performing a measurement, the measurement results no longer match the original measurement settings. In this case, an error message is displayed ("Settings mismatch"). To restore the original measurement settings on the frontend, change a frontend setting in the FSW dialog.

Only one instrument can access the frontend to change settings at a time. While one connected instrument changes hardware settings on the external frontend, the frontend is locked for the other connected instrument. The second instrument gets a "Device busy" message and must retry when the frontend is available again. In this case, start a new measurement to access the frontend and change the settings.

Frequency Band Configuration..... 452  
 Frequency Band.....453  
 Reference Frequency.....453  
 Intermediate Frequency..... 454  
 LO Mode..... 454  
 LO Out State..... 454  
 Mandatory LO IN Frequency.....455  
 LO OUT Frequency.....455  
 Correction State..... 455  
 Load Cable Correction S2P File.....455

**Frequency Band Configuration**

Defines the intermediate frequency (output) range of the external frontend.

The used [Intermediate Frequency](#) and the resulting [Frequency Band](#) sideband that can be analyzed on the FSW are indicated for reference.

The selected frequency band configuration is also indicated in the channel bar.

R&S FE50DTR-type frontends can be used by an analyzer and a signal generator simultaneously. In this case, both channels use the same internal LO and thus both signal paths operate on the same frequency. Therefore, if you want to analyze the signal from the generator using the same frontend, make sure that the configured frequency bands are identical on both instruments.

You can select the required IF output range manually, or it can be determined automatically, according to the other frequency settings.

Currently, auto mode always applies the "IF Low" range for R&S FE44S and R&S FE50DTR-type frontends. For R&S FE170SR and R&S FE110SR frontends, the "Spur Optimized" range is used.

In manual mode, select one of the following IF output ranges:

- "IF High" (R&S FE44S/ R&S FE50DTR)  
A higher intermediate frequency is used on the external frontend, resulting in a higher input frequency at the FSW.
- "IF Low" (R&S FE44S/ R&S FE50DTR)  
A lower intermediate frequency is used on the external frontend, resulting in a lower input frequency at the FSW.
- "Spur Optimized"  
(R&S FE170SR/R&S FE110SR only)  
The selected IF range avoids unwanted spurious effects.
- "EVM Optimized"  
(R&S FE170SR only)  
The selected IF range provides an optimal EVM result.
- "Shared LO" (R&S FE170SR/R&S FE110SR only)  
Ensures that multiple external frontends of a different type (R&S FE170SR/ R&S FE170ST or R&S FE110SR/R&S FE110ST) use the same LO frequencies for upconversion and downconversion.

Remote command:

[\[SENSe:\]EFRontend:FREQuency:BCONfig:AUTO](#) on page 1118

[\[SENSe:\]EFRontend:FREQuency:BCONfig:LIST?](#) on page 1119

[\[SENSe:\]EFRontend:FREQuency:BCONfig:SElect](#) on page 1119

### Frequency Band

Displays the range of the frequency band supported by the connected frontend (for reference only).

Remote command:

[\[SENSe:\]EFRontend:FREQuency:BAND:COUNT?](#) on page 1117

[\[SENSe:\]EFRontend:FREQuency:BAND<b>:LOWer?](#) on page 1117

[\[SENSe:\]EFRontend:FREQuency:BAND<b>:UPPer?](#) on page 1118

### Reference Frequency

Sets the reference frequency that is used for frequency conversion on the frontend. Depending on the connected type of frontend, different values are available.

Remote command:

[\[SENSe:\]EFRontend:FREQuency:REFerence](#) on page 1123

[\[SENSe:\]EFRontend:FREQuency:REFerence:LIST?](#) on page 1123

### Intermediate Frequency

Indicates the currently used intermediate frequency (IF) and sideband (upper/lower) for frequency conversion (for reference only).

This value depends on the ["Frequency Band Configuration"](#) on page 452.

For FFT sweep measurements, the LO is adapted during the measurement to cover the entire sweep range. The resulting IF range is indicated.

For FE50DTR-type frontends that are used by an analyzer and a signal generator simultaneously, make sure that the used intermediate frequency is identical on both instruments.

Make sure the IF frequency required by the external frontend lies within the IF frequency range of the FSW.

"USB"                   Upper sideband

"LSB"                   Lower sideband

Remote command:

For I/Q measurements:

[\[SENSe:\]EFRontend:FREQuency:IFrequency\[:VALue\]?](#) on page 1121

[\[SENSe:\]EFRontend:FREQuency:IFrequency:SIDeband?](#) on page 1120

For FFT sweep measurements:

[\[SENSe:\]EFRontend:FREQuency:IFrequency:MAXimum?](#) on page 1120

[\[SENSe:\]EFRontend:FREQuency:IFrequency:MINimum?](#) on page 1120

### LO Mode

Determines whether the external frontend uses its internal LO or an external LO.

The LO configuration settings are not available for FFT sweep measurements. The external frontend always uses its internal LO.

See also ["LO signal input and output"](#) on page 447.

"External"            Uses the external signal provided at the "LO Input" connector of the external frontend. The frequency at which the LO must be input to the external frontend is indicated as ["Mandatory LO IN Frequency"](#) on page 455.

If enabled, "LO EXT" is displayed in the channel bar.

"Internal"            Uses the internal LO

Remote command:

[\[SENSe:\]EFRontend:FREQuency:LOSCillator:MODE](#) on page 1121

### LO Out State

Enables or disables output of the LO at the "LO OUT" connector of the external frontend. Which LO is provided depends on [LO Mode](#). The frequency at which the LO is provided to the connector is indicated as [LO OUT Frequency](#).

Remote command:

[\[SENSe:\]EFRontend:FREQuency:LOSCillator:OUTPut:STATe](#) on page 1122

### Mandatory LO IN Frequency

Indicates the required frequency of the LO input at the external frontend when using an external LO. If the coupled device does not provide the external LO at this frequency, the results of the external frontend are inaccurate.

Remote command:

`[SENSe:]EFRontend:FREQuency:LOSCillator:INPut:FREQuency?`

on page 1121

### LO OUT Frequency

Indicates the frequency of the LO output, if **LO Out State** is "ON".

Remote command:

`[SENSe:]EFRontend:FREQuency:LOSCillator:OUTPut:FREQuency?`

on page 1122

### Correction State

Activates correction of the IF signal due to cable loss from the frontend to the analyzer.

Remote command:

`[SENSe:]EFRontend:ALIGnment<ch>:STATe` on page 1125

### Load Cable Correction S2P File

Opens a common file selection dialog to load correction data to compensate for signal losses in the cable occurring at different IF signal frequencies.

To provide valid results, the frequency response file must provide the S21 parameter for the used frequency range of the external frontend.

Frequency response files are usually provided with the IF cable. The calibration data for the IF cable provided with the FSW is installed on the instrument at the factory.

The `.s2p` files are stored on the instrument under

```
C:\R_S\INSTR\USER\external_frontends\<frontend_type>\
touchstonefiles\. For example, the files for the IF cable are stored under
C:\R_S\Instr\user\external_frontends\FE44S\touchstonefiles\
if_default_cable_1347_7552_00.s2p.
```

Remote command:

`[SENSe:]EFRontend:ALIGnment<ch>:FILE` on page 1125

### Diagnostics

**Access:** "Overview" > "Input" > "Input Source Config" > "Input Source" > "External Frontend" > "Diagnostics"

The "Diagnostics" tab provides information on the performance of the connected frontend and allows you to perform a self-test on the frontend.

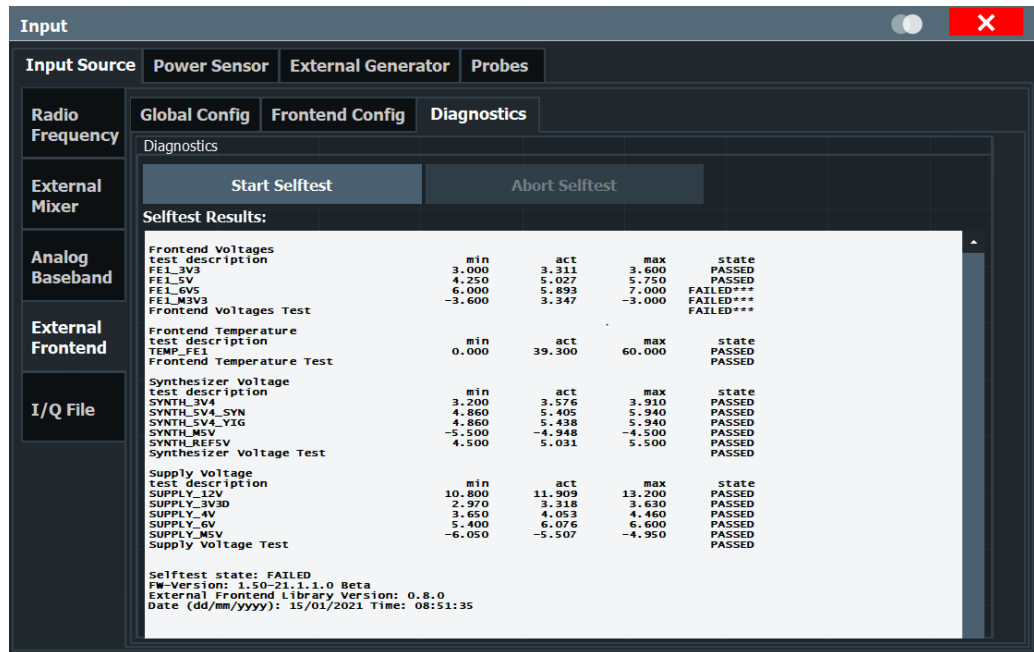

Start Selftest.....456  
 Abort Selftest.....456  
 Selftest Results..... 456

**Start Selftest**

Performs a self-test on the frontend to compare the current performance and characteristic values with the specified values for the frontend.

Remote command:

[SENSe:]EFRontend<fe>:SELfTest? on page 1126

**Abort Selftest**

Aborts a running self-test.

Remote command:

not supported

**Selftest Results**

Indicates the results of a selftest performed on the connected frontend.

Remote command:

[SENSe:]EFRontend<fe>:SELfTest:RESult? on page 1126

**Network configuration**

**Access:** "Overview" > "Input" > "Input Source Config" > "Input Source" > "External Frontend" > "Network Config"

After connection, you can assign a static IP address or switch to a dynamic IP address for the external frontend directly from the FSW.



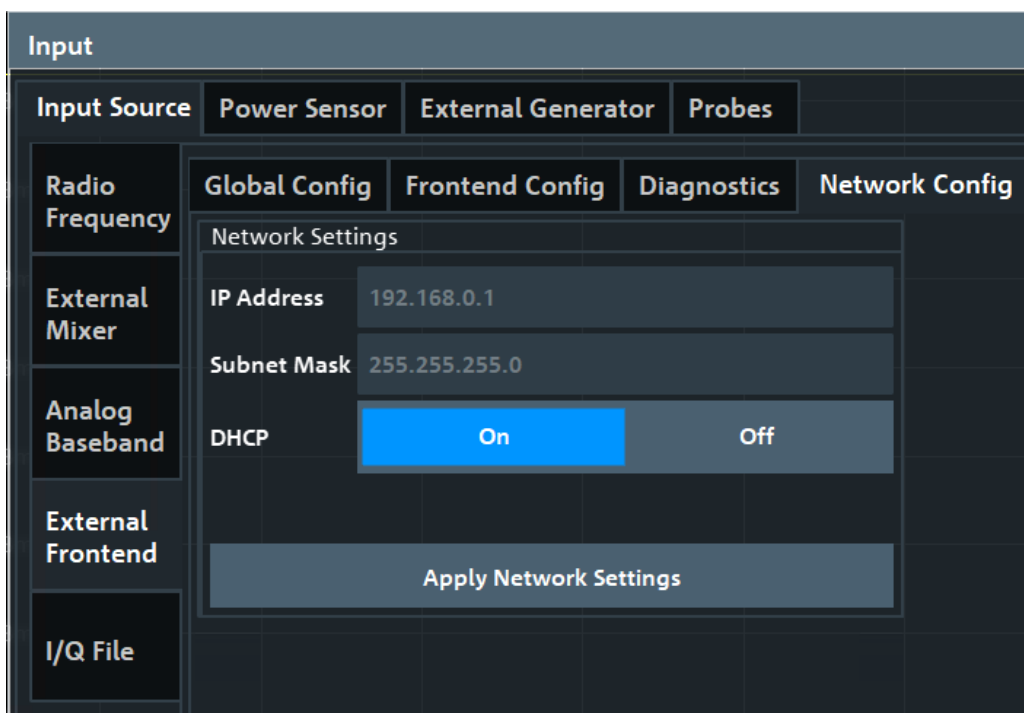

IP Address.....457  
 Subnet Mask.....457  
 DHCP.....457  
 Apply Network Settings.....457

**IP Address**

Defines the IP address of the external frontend. If the DHCP server is used ("DHCP On"), the setting is read-only.

Remote command:

[SENSe:]EFRontend:NETWork on page 1123

**Subnet Mask**

Defines the subnet mask of the external frontend. If the DHCP server is used ("DHCP On"), this setting is read-only.

Remote command:

[SENSe:]EFRontend:NETWork on page 1123

**DHCP**

Switches between DHCP server available ("On") or not available ("Off"). If a DHCP server is available in the network, the IP address and subnet mask of the external frontend are obtained automatically from the DHCP server.

Remote command:

[SENSe:]EFRontend:NETWork on page 1123

**Apply Network Settings**

Any changes to the external frontend network configuration are applied.

Beware that if you change the network information, the connection is aborted and you must re-establish a connection to the frontend (see "External Frontend Connection State" on page 450).

Remote command:

[SENSe:]EFRontend:NETWork on page 1123

**External Devices**

**Access:** "Overview" > "Input" > "Input Source Config" > "Input Source" > "External Frontend" > "External Devices"

You can insert additional external devices in the signal path between the DUT and the external frontend, such as preamplifiers or filters. The external frontend must then consider the additional gain or correction values.

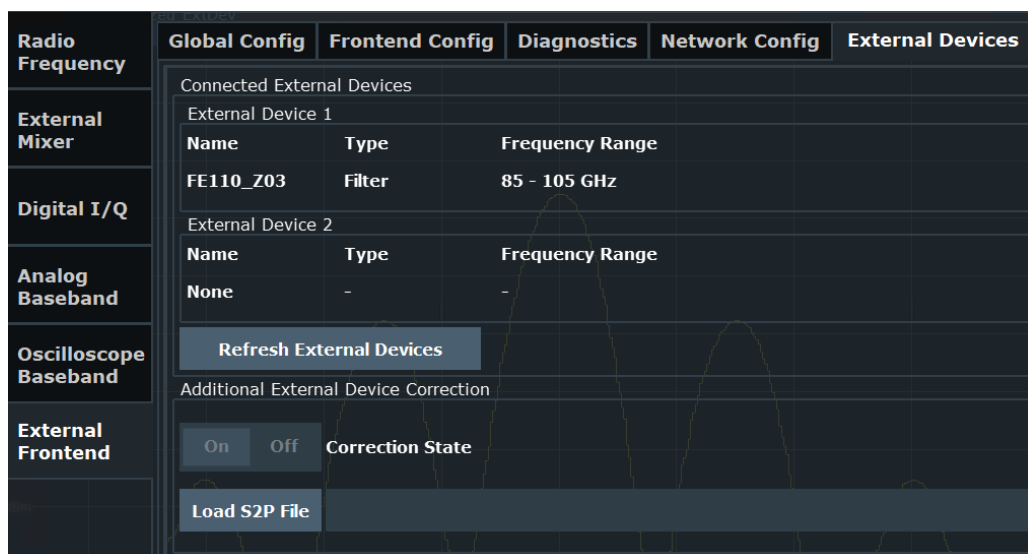

When the FSW initially connects to the external frontend, the instrument automatically detects any devices connected to the external frontend. The FSW displays information on detected devices in the "External Devices" tab of the dialog.

Name.....458  
 Type.....459  
 Frequency Range.....459  
 Gain.....459  
 Refresh External Devices.....459  
 Correction State.....459  
 Load S2P File.....459

**Name**

Name of the external device for reference.

Remote command:

[SENSe:]EFRontend[:CHANnel<ch>]:EXTDevice<di>:NAME? on page 1130

[SENSe:]EFRontend[:CHANnel<ch>]:EXTDevice<di>:LIST? on page 1128

**Type**

Type of the detected device for reference.

Currently, the following device types are supported:

- Filter
- Amplifier (R&S FE170SR only)

Remote command:

`[SENSe:]EFRontend[:CHANnel<ch>]:EXTDevice<di>:TYPE?` on page 1131

**Frequency Range**

The supported frequency range of the connected device.

Remote command:

`[SENSe:]EFRontend[:CHANnel<ch>]:EXTDevice<di>:FREQuency:MINimum?`  
on page 1130

`[SENSe:]EFRontend[:CHANnel<ch>]:EXTDevice<di>:FREQuency:MAXimum?`  
on page 1129

**Gain**

For connected external amplifiers only: provided gain.

Remote command:

`[SENSe:]EFRontend[:CHANnel<ch>]:EXTDevice<di>:GAIN?` on page 1130

**Refresh External Devices**

Scans the ports of the external frontend and refreshes the display with detected information on connected devices. This function is useful after connecting a new device to the frontend.

Remote command:

`[SENSe:]EFRontend[:CHANnel<ch>]:EXTDevice<di>:REFresh` on page 1129

**Correction State**

Enables or disables the use of an additional correction file for the connected external devices. Additional correction is useful, for example, if you do not use the IX cable to connect the external device to the external frontend. In this case, automatic compensation cannot be applied.

See also "[Correcting the signal path](#)" on page 449.

Remote command:

`[SENSe:]EFRontend[:CHANnel<ch>]:EXTDevice<di>:CORRection:STATe`  
on page 1127

**Load S2P File**

Opens a common file selection dialog to load correction data to compensate for signal losses by the external devices occurring at different RF signal frequencies.

To provide valid results, the frequency response file must provide the S21 parameter for the used frequency range of the external devices.

The dialog indicates whether the loaded file is valid or not.

Remote command:

[SENSe:]EFRontend[:CHANnel<ch>]:EXTDevice<di>:CORRection:FILE  
on page 1127

[SENSe:]EFRontend[:CHANnel<ch>]:EXTDevice<di>:CORRection:VALid?  
on page 1128

### 7.2.7.3 How to use an external frontend

#### To configure the use of an external frontend

1. Connect an external frontend to the DUT and the FSW as described in the frontend manual.
2. Open a measurement channel for a measurement that supports FFT sweeps ([MEAS]), or an I/Q-based application, such as the I/Q Analyzer ([Mode]).
3. Select [Input / Output] > "Input Source Config" > "Input Source" > "External Frontend".
4. On the "Global Config" tab, enable general use of the external frontend for the application ("On").  
The connection settings become available.
5. Select the "Type" of connected frontend.
6. Enter the IP address or computer name of the connected frontend. The information is indicated on the electronic label on the side panel of the frontend.

After you enter the IP address, the "Connection State" setting becomes available.

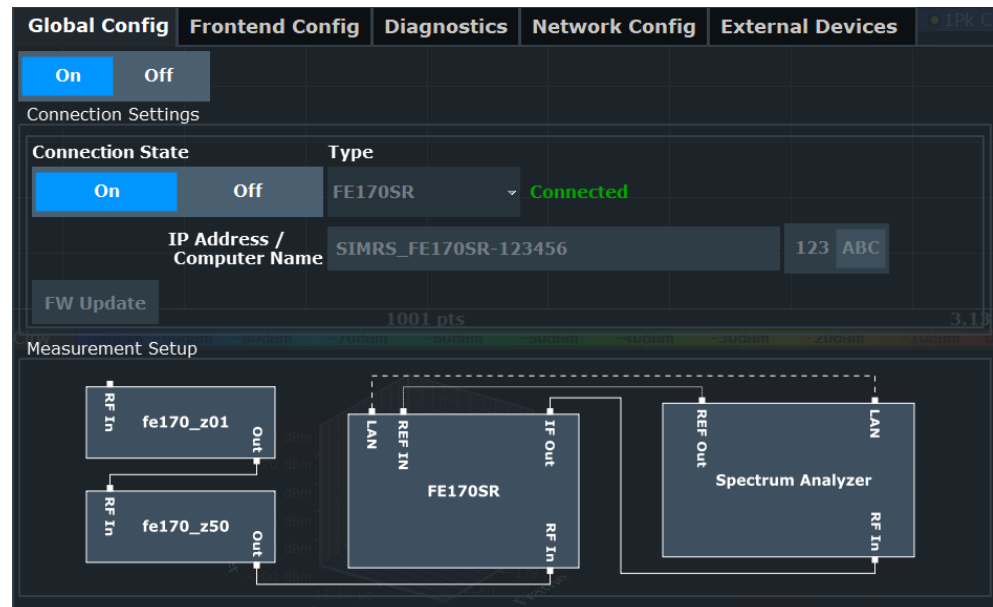

7. Set the "Connection State" to "On".

It can take up to 10 seconds until the FSW sets up the control connection to the frontend. The displayed status of the control connection in the dialog box switches from "Not Connected" (white) to "Connected" (green). The LAN LED on the front panel of the frontend switches from green to orange.

The frequency band supported by the connected frontend is displayed on the "Frontend Config" tab.

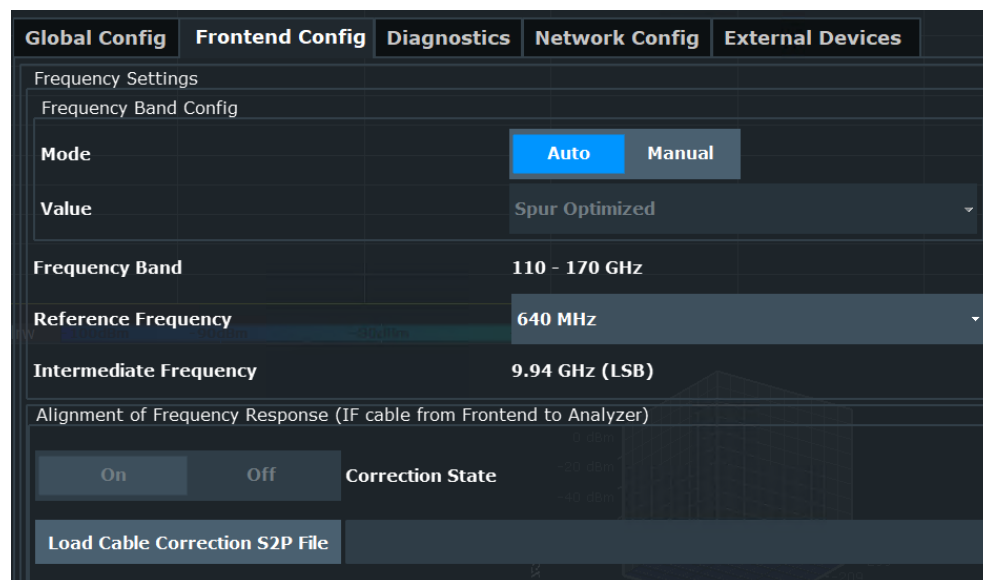

8. On the "Frontend Config" tab, select the "Frequency Band Configuration" to be used by the frontend. The band determines the used intermediate frequency and resulting frequency band you can analyze. Both values are indicated in the dialog box for reference.
9. Select the "Reference Frequency" to be used by the frontend.
10. Optionally, enable compensation for the frequency response of the IF cable from the FSW to the frontend.
  - a) Select "Load Cable Correction S2P File".
  - b) Select an `.s2p` file that contains the frequency response for the used IF cable.

To provide valid results, the frequency response file must provide the S21 parameter for the used frequency range of the external frontend.

Frequency response files are usually provided with the IF cable. The calibration data for the IF cable provided with the FSW is installed on the instrument at the factory.

The `.s2p` files are stored on the instrument under

```
C:\R_S\INSTR\USER\external_frontends\\touchstonefiles\.
```

For example, the files for the IF cable are stored under

```
C:\R_S\Instr\user\external_frontends\FE44S\touchstonefiles\if_default_cable_1347_7552_00.s2p.
```

- c) Set the "Correction State" to "On" to enable the use of the correction file.

The FSW automatically adapts the measured values from the external frontend to the known cable loss.

11. Optionally, check the network settings of the FSW.
  - a) Select the "Network Config" tab.
  - b) Make sure the correct "IP Address" and "Subnet Mask" are assigned.

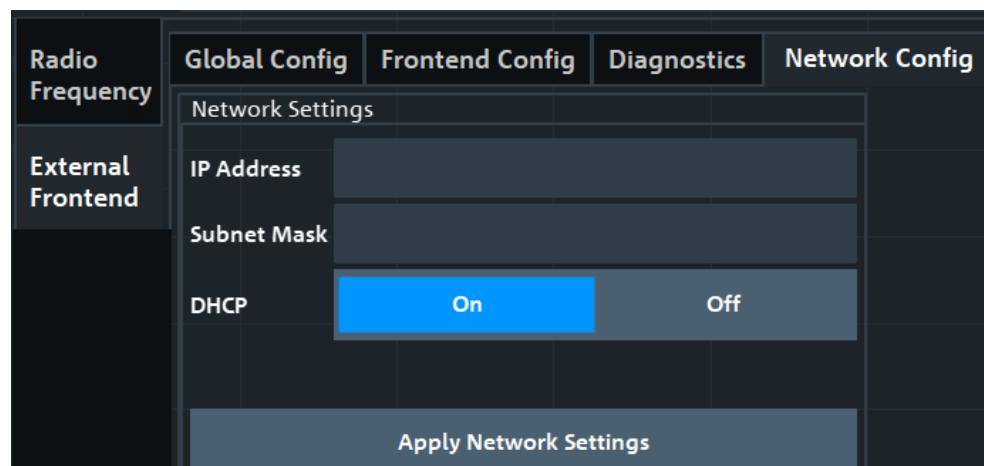

By default, DHCP is enabled and the IP address of the external frontend is assigned automatically.

12. Optionally, if you need to change the network settings, proceed as follows:
  - a) Disable DHCP ("DHCP" > "Off").
  - b) Adjust the network settings according to your test setup.
  - c) Click "Apply Network Settings".

**Note:** If you change the network configuration to "DHCP" > "On", the connection to the FSW is aborted. You must re-establish a connection to the frontend as described in [step 4](#)).

If you have connection issues, see .

13. Configure the measurement as usual. The amplitude and frequency settings are adapted to the supported values of the external frontend. The reference value refers to the RF input of the external frontend.

#### To configure the use of additional external devices

R&S FE170SR and R&S FE110SR type frontends allow you to connect additional external devices to the signal path before the frontend.

1. Connect an external device to the DUT and the R&S FE170SR/R&S FE110SR type frontend as described in the frontend manual.
2. Connect the external frontend to the FSW as described in the frontend manual.
3. Configure the external frontend as described in ["To configure the use of an external frontend"](#) on page 460.
4. Select [Input / Output] > "Input Source Config" > "Input Source" > "External Frontend" > "External Devices".

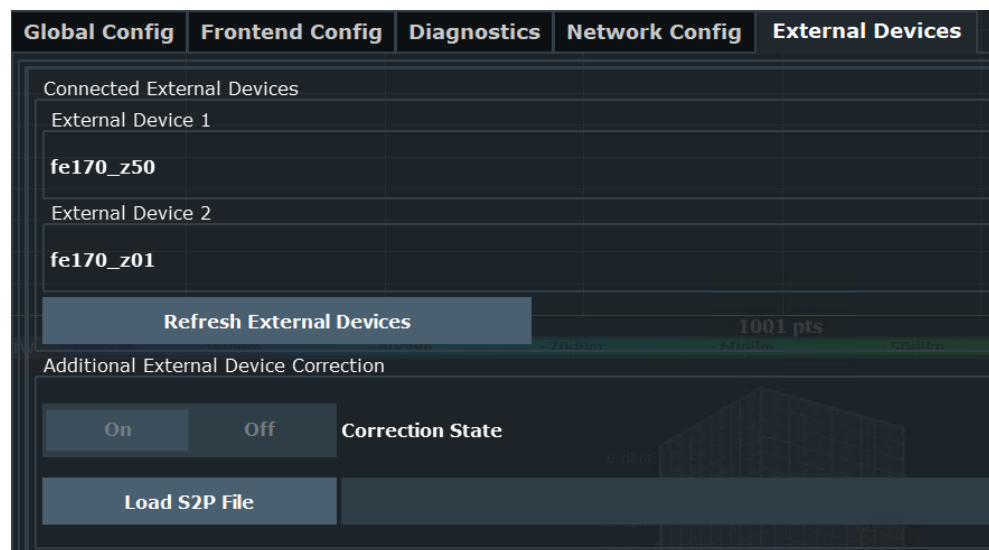

The detected external devices and the provided information is displayed.

5. If the external frontend was already connected to the analyzer when you connected the external device, select "Refresh External Devices" to update the information.
6. Optionally, if you do not connect the external device to the frontend using the IX cable, enable additional compensation for the external device.
  - a) Select "Load S2P File".
  - b) Select an `.s2p` file that contains the frequency response for the used devices and cables.
 

To provide valid results, the frequency response file must provide the S21 parameter for the used frequency range of the external devices.

The dialog indicates whether the selected file is valid or not.
  - c) Set the "Correction State" to "On" to enable the use of the correction file.

The external frontend automatically adapts the signal values from the external devices to the known loss.

#### 7.2.7.4 Troubleshooting external frontend control

If problems arise during external frontend control, try the following measures to optimize the connection or setup.

For additional information, see the external frontend documentation.

##### Error messages

If errors occur, status messages in the external frontend configuration dialog box and in the status bar of the display inform you about them.

Query the error message queue using the remote command `SYST:ERR?` to determine if any or which errors occurred during operation. For details, see [Chapter 14.2, "Error messages in remote control mode"](#), on page 1545.

If any errors occur that are not described here, contact the Rohde & Schwarz customer support, see [Chapter 14.7, "Contacting customer support"](#), on page 1553.

**Table 7-2: Status and error messages**

Status bar message	Dialog status	SYST:ERR? result	Description/ Possible solution
External Frontend [x]: Connecting...	Connecting...		Connection to the external frontend is being established.  It can take up to 10 seconds to determine that LAN connection failed.
Connected	Connected		Connection established, ready for operation.
No External Frontend Connected	Not connected		No external frontend detected. Connect an external frontend to the FSW.
External Frontend [x]: Invalid Host IP	Invalid Host IP	300, "Invalid Host IP"	Verify the specified IP address of the external frontend.
External Frontend [x]: LAN Connection Failed	Not connected	301, "LAN Connection Failed"	Verify that the external frontend is connected to the same network as the FSW.  Verify the specified IP address of the external frontend.
External Frontend [x]: Incompatible Analyzer Firmware	Incompatible Analyzer Firmware	302, "Incompatible Analyzer Firmware"	The frontend hardware is not compatible with the installed analyzer firmware.  Update your analyzer firmware.  See <a href="#">Chapter 11.7.4, "Firmware updates"</a> , on page 790.
External Frontend [x]: Incompatible Frontend Firmware	Incompatible Frontend Firmware	303, "Incompatible Frontend Firmware"	The firmware of the external frontend is not up-to-date.  Perform a firmware update.  See <a href="#">"FW Update"</a> on page 451.
External Frontend [x]: Device Locked	Device Locked	304, "Device Locked"	External frontend is accessible via ping, but no SSL-connection could be established.  Disconnect another device that is currently accessing the external frontend and try reconnecting.  A single frontend supports up to 2 LAN/SSL connections.
External Frontend [x]: Wrong Device Type	Wrong Device Type	306, "Wrong Device Type"	The connected external frontend is not of the specified type.  Disconnect the device, select the correct external frontend type in the configuration dialog box, and reconnect.
External Frontend [x]: LAN Connection Lost	LAN Connection Lost	314, "LAN Connection Lost"	The connection to the external frontend has been lost.  The analyzer attempts to reconnect periodically. Wait for the "Connecting..." message.
External Frontend [x]: Firmware Update Failed	Firmware Update Failed	315, "Firmware Update Failed"	The firmware of the external frontend was not updated successfully.



Status bar message	Dialog status	SYST:ERR? result	Description/ Possible solution
External Frontend [x]: <Frontend_Name> is not allowed, RF input frequency of at least <Max_RF> GHz is required.	Connected	316, "External Frontend Not Allowed"	The FSW does not support any IF frequencies required by the external frontend.
External Frontend [x]: Current RF frequency is out of valid range. Please check Frontend Config dialog for more information	Connected	317, "RF frequency is out of valid range."	The selected measurement (RF) frequency is not supported by the selected frequency band of the external frontend. Select a different frequency on the FSW, or a different frequency band for the frontend.
External Frontend [x]: Settings Mismatch - reinitiate frontend by changing a measurement parameter	Connected	332, "Settings Mismatch"	The conversion settings on the external frontend were changed by another instrument during the measurement on the FSW. The measurement results no longer match the original measurement settings. To restore the original measurement settings on the frontend, change a frontend setting in the FSW dialog.
External Frontend [x]: Not Connected – Device Busy	Device busy	333, "Device Busy"	The external frontend is currently blocked by another instrument, e.g. for initial connection or a firmware update. After the other instrument finishes its task, try reconnecting the FSW. (Switch the "Connection" state off and on again.)
External Frontend [x]: Device Busy	Connected	333, "Device Busy"	During a running measurement, the external frontend is blocked by another instrument, e.g. for initial connection or a firmware update. The current measurement is aborted. After the other instrument finishes its task, start a new measurement on the FSW.
External Frontend [x]: Touchstone file insufficient frequency range		350, "Touchstone file frequency range insufficient"	The .s2p file does not cover the used frequency. Correct the file or select a different correction file.
	"<filename>.s2p has wrong file format"	-150, "String data error"  (Result for [SENSe: JEFrontend: ALIGNment<ch>:FILE on page 1125)	The .s2p file does not have the correct syntax. Correct the file.
		-256, "File name not found"  (Result for [SENSe: JEFrontend: ALIGNment<ch>:FILE on page 1125)	The specified .s2p file does not exist. Correct the path and filename and make sure that the file is stored on the instrument under C:\R_S\INSTR\USER\external_frontends\ <frontend_type>\touchstonefiles.



### Touchstone file errors

Some errors concerning .s2p correction files do not cause warnings in the status bar and do not provide results in the system error queue, but do display messages or return errors in remote control.

### Problems with connection

If you cannot connect to the external frontend, check the status bar or error queue of the FSW for error messages (see also ["Error messages"](#) on page 463).

If no messages are available, check the "LAN" and "POWER" status LEDs on the external frontend. Permanent red lights indicate an error, usually hardware problems, e.g. if the fans are off. In this case, the instrument is automatically put in a safe (error) state to avoid damage. A LAN connection is no longer possible. Try switching the external frontend off and on again.

If the problem persists, contact Rohde & Schwarz service, as described in [Chapter 14.7, "Contacting customer support"](#), on page 1553.

### Problems during operation

[Problem: The analyzer does not show the signal sent by a signal generator using the same external frontend..... 466](#)

[Problem: My FSW85 does not show the signal measured with an external frontend. 466](#)

#### **Problem: The analyzer does not show the signal sent by a signal generator using the same external frontend**

**Possible Solution:** Although the generator and the analyzer are set to the same frequency, possibly they are not using the same IF for conversion.

Make sure that both instruments are set to the same [Frequency Band Configuration](#) in the [Frontend configuration settings](#).

#### **Problem: My FSW85 does not show the signal measured with an external frontend**

**Possible Solution:**

Select the other RF Input connector in the [Radio frequency input](#) (see ["Radio Frequency State"](#) on page 363). The external frontend settings apply to both RF input connectors on the FSW85, so you must select the connector you use.

## 7.2.8 Output settings

**Access:** [Input/Output] > "Output"

The FSW can provide output to special connectors for other devices.

For details on connectors, refer to the FSW Getting Started manual, "Front / Rear Panel View" chapters.



Providing trigger signals as output is described in [Chapter 7.2.9, "Trigger input/output settings"](#), on page 468.

Providing output for LISN control in EMI measurements is described in [Chapter 6.13.4.3, "LISN control settings"](#), on page 349.

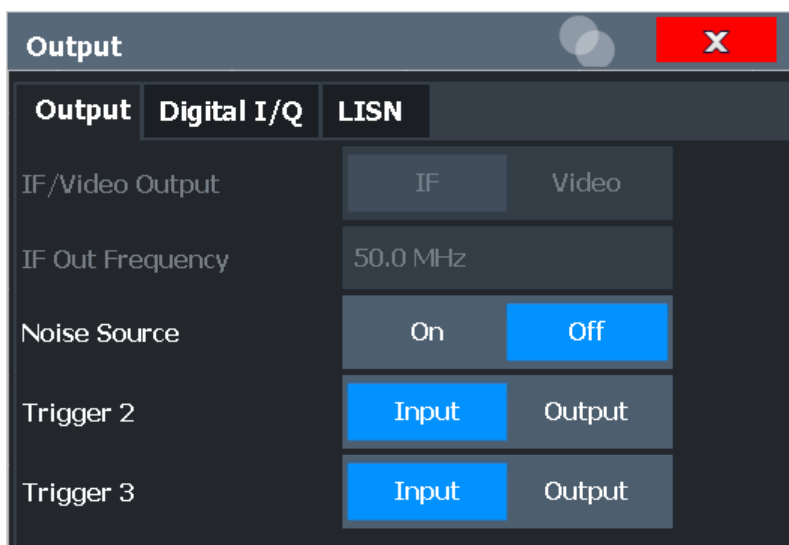

Data Output.....467  
 Noise Source Control.....468

**Data Output**

Defines the type of signal available at one of the output connectors of the FSW.

For restrictions and additional information, see [Chapter 7.2.1.2, "IF and video signal output"](#), on page 360.

- "IF" The measured IF value is provided at the IF/VIDEO/DEMODO output connector.  
 For bandwidths up to 80 MHz, the IF output is provided at the specified "IF Out Frequency".  
 If an optional bandwidth extension FSW-B160/-B320/-B512 is used, the measured IF value is available at the "IF WIDE OUTPUT" connector. The frequency at which this value is output is determined automatically. It is displayed as the "IF Wide Out Frequency". For details on the used frequencies, see the specifications document. This setting is not available for bandwidths larger than 512 MHz.
- "2ND IF" The measured IF value is provided at the "IF OUT 2 GHz/ IF OUT 5 GHz" output connector, if available, at a frequency of 2 GHz and with a bandwidth of 2 GHz. The availability of this connector depends on the instrument model.  
 This setting is not available if the optional 2 GHz / 5 GHz bandwidth extension (FSW-B2000/B5000) is active.
- "Video" The displayed video signal (i.e. the filtered and detected IF signal) is available at the IF/VIDEO/DEMODO output connector. This setting is required to provide demodulated audio frequencies at the output. It is not available for frequency sweeps or I/Q measurements.

Remote command:

[OUTPut:IF\[:SOURce\]](#) on page 1188

[OUTPut:IF:IFFrequency](#) on page 1189

[SYSTem:SPEaker:VOLume](#) on page 1190

**Noise Source Control**

Enables or disables the 28 V voltage supply for an external noise source connected to the "Noise source control / Power sensor") connector. By switching the supply voltage for an external noise source on or off in the firmware, you can enable or disable the device as required.

External noise sources are useful when you are measuring power levels that fall below the noise floor of the FSW itself, for example when measuring the noise level of an amplifier.

In this case, you can first connect an external noise source (whose noise power level is known in advance) to the FSW and measure the total noise power. From this value, you can determine the noise power of the FSW. Then when you measure the power level of the actual DUT, you can deduct the known noise level from the total power to obtain the power level of the DUT.

Remote command:

`DIAGnostic:SERVice:NSource` on page 1187

**7.2.9 Trigger input/output settings**

**Access:** "Overview" > "Trigger" > "Trigger In/Out"

**Or:** [TRIG] > "Trigger Config" > "Trigger In/Out"

The FSW can use a signal from an external device as a trigger to capture data. Alternatively, the internal trigger signal used by the FSW can be output for use by other connected devices.



Providing trigger signals as output is described in detail in [Chapter 7.2.1.1, "Receiving and providing trigger signals"](#), on page 359 and [Chapter 7.2.10, "How to output a trigger signal"](#), on page 470.

**Trigger 2/3**

Trigger Source	Trigger In/Out	
Trigger 2	Input	Output
Output Type	User Defined	Level Low High
Pulse Length	100.0 $\mu$ s	Send Trigger
Trigger 3	Input	Output

The trigger input and output functionality depends on how the variable "Trigger Input/Output" connectors are used.

"Trigger 1"	"Trigger 1" is input only.
"Trigger 2"	Defines the usage of the variable "Trigger Input/Output" connector on the front panel (not available for FSW85 models with 2 RF input connectors)
"Trigger 3"	Defines the usage of the variable "Trigger 3 Input/Output" connector on the rear panel
"Input"	The signal at the connector is used as an external trigger source by the FSW. Trigger input parameters are available in the "Trigger" dialog box.
"Output"	The FSW sends a trigger signal to the output connector to be used by connected devices. Further trigger parameters are available for the connector.

Remote command:

[OUTPut:TRIGger<tp>:DIRection](#) on page 1230

### Output Type ← Trigger 2/3

Type of signal to be sent to the output

"Device Triggered"	(Default) Sends a trigger when the FSW triggers.
"Trigger Armed"	Sends a (high level) trigger when the FSW is in "Ready for trigger" state. This state is indicated by a status bit in the <code>STATUS:OPERation</code> register (bit 5), as well as by a low-level signal at the "AUX" port (pin 9). For details, see <a href="#">Chapter 12.2.2.4, "STATUS:OPERation register"</a> , on page 826 and the FSW Getting Started manual.
"User Defined"	Sends a trigger when you select "Send Trigger". In this case, further parameters are available for the output signal.

Remote command:

[OUTPut:TRIGger<tp>:OTYPe](#) on page 1230

### Level ← Output Type ← Trigger 2/3

Defines whether a high (1) or low (0) constant signal is sent to the trigger output connector (for "Output Type": "User Defined").

The trigger pulse level is always opposite to the constant signal level defined here. For example, for "Level" = "High", a constant high signal is output to the connector until you select the [Send Trigger](#) function. Then, a low pulse is provided.

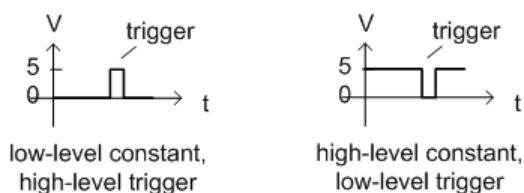

low-level constant,  
high-level trigger

high-level constant,  
low-level trigger

Remote command:

[OUTPut:TRIGger<tp>:LEVel](#) on page 1230

#### **Pulse Length ← Output Type ← Trigger 2/3**

Defines the duration of the pulse (pulse width) sent as a trigger to the output connector.

Remote command:

[OUTPut:TRIGger<tp>:PULSe:LENGth](#) on page 1231

#### **Send Trigger ← Output Type ← Trigger 2/3**

Sends a user-defined trigger to the output connector immediately.

Note that the trigger pulse level is always opposite to the constant signal level defined by the output [Level](#) setting. For example, for "Level" = "High", a constant high signal is output to the connector until you select the "Send Trigger" function. Then, a low pulse is sent.

Which pulse level is sent is indicated by a graphic on the button.

Remote command:

[OUTPut:TRIGger<tp>:PULSe:IMMediate](#) on page 1231

### **7.2.10 How to output a trigger signal**

Using the variable Trigger 2/3 connector of the FSW, the internal trigger signal can be output for use by other connected devices.

For details on the connectors see the FSW "Getting Started" manual.

#### **To output a trigger to a connected device**

1. Select [Trigger] > "Trigger Config".
2. Switch to the "Trigger In/Out" tab of "Trigger and Gate".
3. Set the trigger to be used to "Output".  
(Note: Trigger 2 is output to the front panel connector, Trigger 3 is output to the rear panel connector. For FSW85 models with two RF input connectors, Trigger 2 is not available.)
4. Define whether the trigger signal is to be output automatically ("Output Type" = "Device triggered" or "Trigger Armed") or whether you want to start output manually ("Output Type" = "User-defined").
5. For manual output: Specify the constant signal level and the length of the trigger pulse to be output. Note that the level of the trigger pulse is opposite to the constant output "Level" setting (compare the graphic on "Send Trigger").
6. Connect a device that will receive the trigger signal to the configured Trigger 2/3 connector.
7. Start a measurement and wait for an internal trigger, or select "Send Trigger".  
The configured trigger is output to the connector.

## 7.3 Frequency and span configuration

The frequency and span settings define the scope of the signal and spectrum to be analyzed with the FSW.

- [Impact of the frequency and span settings](#)..... 471
- [Frequency and span settings](#).....473
- [Keeping the center frequency stable - signal tracking](#)..... 477
- [How to define the frequency range](#)..... 478
- [How to move the center frequency through the frequency range](#)..... 478

### 7.3.1 Impact of the frequency and span settings

Some background knowledge on the impact of the described settings is provided here for a better understanding of the required configuration.

- [Defining the scope of the measurement - frequency range](#)..... 471
- [Stepping through the frequency range - center frequency stepsize](#)..... 471
- [Coping with large frequency ranges - logarithmic scaling](#).....472

#### 7.3.1.1 Defining the scope of the measurement - frequency range

The frequency range defines the scope of the signal and spectrum to be analyzed. It can either be defined as a span around a center frequency, or as a range from a start to a stop frequency. Furthermore, the full span comprising the entire possible frequency range can be selected, or a zero span. The full span option allows you to perform an overview measurement over the entire span. Using the "Last Span" function you can easily switch back to the detailed measurement of a specific frequency range.

For sinusoidal signals, the center frequency can be defined automatically by the FSW as the highest frequency level in the frequency span (see "[Adjusting the Center Frequency Automatically \(Auto Frequency\)](#)" on page 531).

#### 7.3.1.2 Stepping through the frequency range - center frequency stepsize

Using the arrow keys you can move the center frequency in discrete steps through the available frequency range. The step size by which the center frequency is increased or decreased is defined by the "Center Frequency Stepsize".



The "Center Frequency Stepsize" also defines the step size by which the value is increased or decreased when you use the rotary knob to change the center frequency; however, the **rotary knob** moves in steps of only **1/10 of the "Center Frequency Stepsize"** to allow for a more precise setting.

By default, the step size is set in relation to the selected span or resolution bandwidth (for zero span measurements). In some cases, however, it may be useful to set the step size to other values.



For example, to analyze signal harmonics, you can define the step size to be equal to the center frequency. In this case, each stroke of the arrow key selects the center frequency of another harmonic. Similarly, you can define the step size to be equal to the current marker frequency.

### 7.3.1.3 Coping with large frequency ranges - logarithmic scaling

In a linear display, the frequencies are distributed linearly across the x-axis. That means the entire frequency range is divided by the number of sweep points, and the distance between sweep points is equal. Linear scaling is useful to determine precise frequencies within a small range.

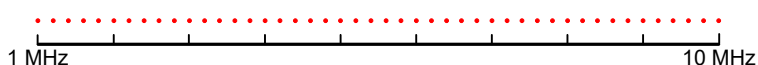

*Figure 7-27: Linear x-axis scaling: the distance between the sweep points is equal, e.g. 200 kHz*

However, if high and low frequencies appear in the same display, it is difficult to determine individual frequencies precisely or to distinguish frequencies that are close together.

In a logarithmic display, lower frequencies are distributed among a much larger area of the display, while high frequencies are condensed to a smaller area. Now it is much easier to distinguish several lower frequencies, as they are spread over a wider area. Logarithmic scaling is useful for overview measurements when a large frequency range must be displayed in one diagram.

Note that logarithmic scaling is only available if R&S FSW-K54 is installed.

However, with logarithmic scaling, the frequency resolution between two sweep points deteriorates with higher frequencies.

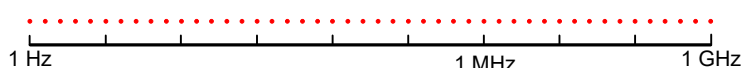
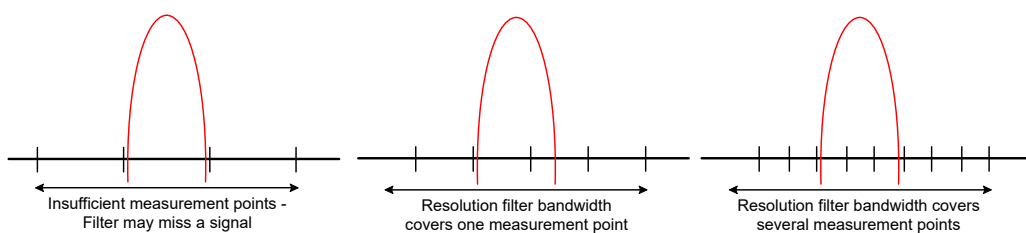

*Figure 7-28: Logarithmic x-axis scaling: the distance between sweep points is variable*

In the spectrum from 10 Hz to 100 Hz, the distance is a few Hz. Between 100 MHz and 1 GHz, the distance is several MHz.

Thus, for logarithmic x-axis scaling, the number of sweep points must be sufficiently high in order to distinguish high frequencies precisely. The resolution bandwidth should cover at least one sweep point (that means: the distance between two sweep points should not exceed the RBW). If this condition is not met, signals or interferers could be missed, especially narrowband interferers.





### 7.3.2 Frequency and span settings

**Access:** "Overview" > "Frequency"

For more information see [Chapter 7.3.4, "How to define the frequency range"](#), on page 478.

Frequency
X

Frequency
Signal Tracking

Frequency/Span

Center	13.25 GHz	Full Span
Span	26.5 GHz	Zero Span
Start	0.0 Hz	Last Span
Stop	26.5 GHz	

Axis

Lin

Log

Center Frequency Stepsize

Stepsize	0.1 * Span	X-Factor	10.0 %
----------	------------	----------	--------

Frequency Offset

Value	0.0 Hz
-------	--------

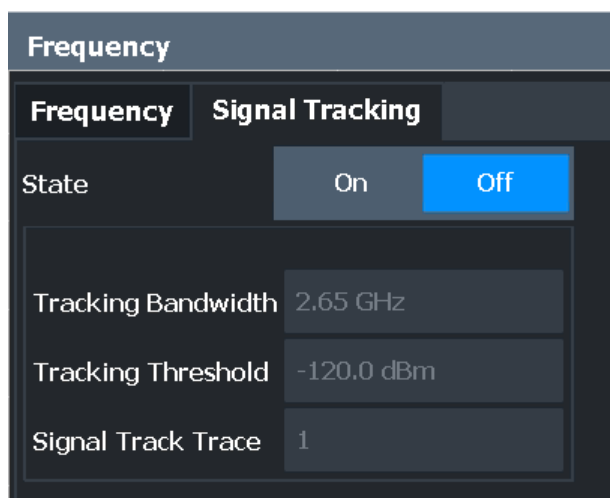

Center Frequency.....	474
Span.....	474
Start / Stop.....	475
Frequency Axis Scaling.....	475
Full Span.....	475
Zero Span.....	475
Last Span.....	475
Center Frequency Stepsize.....	476
Frequency Offset.....	476

### Center Frequency

Defines the center frequency of the signal in Hertz.

The allowed range of values for the center frequency depends on the frequency span.

$$\text{span} > 0: \text{span}_{\min}/2 \leq f_{\text{center}} \leq f_{\text{max}} - \text{span}_{\min}/2$$

$$\text{zero span}: 0 \text{ Hz} \leq f_{\text{center}} \leq f_{\text{max}}$$

$f_{\text{max}}$  and  $\text{span}_{\min}$  depend on the instrument and are specified in the specifications document.

Remote command:

[SENSe:] FREQuency: CENTer on page 1192

### Span

Defines the frequency span. The center frequency is kept constant. The following range is allowed:

$$\text{span} = 0: 0 \text{ Hz}$$

span >0:

$$\text{span}_{\min} \leq f_{\text{span}} \leq f_{\text{max}}$$

$f_{\text{max}}$  and  $\text{span}_{\min}$  are specified in the specifications document.

For more information, see [Chapter 7.3.1.1, "Defining the scope of the measurement - frequency range"](#), on page 471.

Remote command:

[SENSe:] FREQuency: SPAN on page 1194

### Start / Stop

Defines the start and stop frequencies.

The following range of values is allowed:

$$f_{\min} \leq f_{\text{start}} \leq f_{\max} - \text{span}_{\min}$$

$$f_{\min} + \text{span}_{\min} \leq f_{\text{stop}} \leq f_{\max}$$

$f_{\min}$ ,  $f_{\max}$  and  $\text{span}_{\min}$  are specified in the specifications document.

Remote command:

[SENSe:] FREQuency: START on page 1195

[SENSe:] FREQuency: STOP on page 1195

### Frequency Axis Scaling

Switches between linear and logarithmic scaling for the frequency axis.

Logarithmic scaling is only available if R&S FSW-K54 is installed and only for  $f_{\text{stop}} \geq 1.4 \cdot f_{\text{start}}$ .

By default, the frequency axis has linear scaling. Logarithmic scaling of the frequency axis, however, is common for measurements over large frequency ranges as it enhances the resolution of the lower frequencies. On the other hand, high frequencies get more crowded and become harder to distinguish.

For more information see [Chapter 7.3.1.3, "Coping with large frequency ranges - logarithmic scaling"](#), on page 472.

Remote command:

DISPlay[:WINDow<n>][:SUBWindow<w>]:TRACe<t>:X:SPACing on page 1191

### Full Span

Sets the span to the full frequency range of the FSW specified in the specifications document. This setting is useful for overview measurements.

Remote command:

[SENSe:] FREQuency: SPAN: FULL on page 1195

### Zero Span

Sets the span to 0 Hz (zero span). The x-axis becomes the time axis with the grid lines corresponding to 1/10 of the current sweep time ("SWT").

For details see [Chapter 6.1, "Basic measurements"](#), on page 128.

Remote command:

FREQ:SPAN 0Hz, see [SENSe:] FREQuency: SPAN on page 1194

### Last Span

Sets the span to the previous value. With this function you can switch between an overview measurement and a detailed measurement quickly.

Remote command:

[SENSe:] FREQuency: SPAN on page 1194

### Center Frequency Stepsize

Defines the step size by which the center frequency is increased or decreased when the arrow keys are pressed. When you use the rotary knob the center frequency changes in much smaller steps (1/10 the size as for the arrow keys).

The step size can be coupled to the span (span > 0) or the resolution bandwidth (span = 0), or it can be manually set to a fixed value.

For more details see [Chapter 7.3.1.2, "Stepping through the frequency range - center frequency stepsize"](#), on page 471.

"0.1 * Span" / "0.1 * RBW"	Sets the step size for the center frequency to 10 % of the span / RBW. This is the default setting.
"0.5 * Span" / "0.5 * RBW"	Sets the step size for the center frequency to 50 % of the span / RBW.
"x * Span" / "x * RBW"	Sets the step size for the center frequency to a manually defined factor of the span / RBW. The "X-Factor" defines the percentage of the span / RBW. Values between 1 and 100 % in steps of 1 % are allowed. The default setting is 10 %.
"= Center"	Sets the step size to the value of the center frequency and removes the coupling of the step size to span or resolution bandwidth. The used value is indicated in the "Value" field.
"= Marker"	This setting is only available if a marker is active. Sets the step size to the value of the current marker and removes the coupling of the step size to span or resolution bandwidth. The used value is indicated in the "Value" field.
"Manual"	Defines a fixed step size for the center frequency. Enter the step size in the "Value" field.

Remote command:

[\[SENSe:\] FREQuency:CENTer:STEP:LINK](#) on page 1193

[\[SENSe:\] FREQuency:CENTer:STEP:LINK:FACTor](#) on page 1194

[\[SENSe:\] FREQuency:CENTer:STEP](#) on page 1193

### Frequency Offset

Shifts the displayed frequency range along the x-axis by the defined offset.

This parameter has no effect on the instrument's hardware, on the captured data, or on data processing. It is simply a manipulation of the final results in which absolute frequency values are displayed. Thus, the x-axis of a spectrum display is shifted by a constant offset if it shows absolute frequencies. However, if it shows frequencies relative to the signal's center frequency, it is not shifted.

A frequency offset can be used to correct the display of a signal that is slightly distorted by the measurement setup, for example.

The allowed values range from -1 THz to 1 THz. The default setting is 0 Hz.

Remote command:

[\[SENSe:\] FREQuency:OFFSet](#) on page 1194

### 7.3.3 Keeping the center frequency stable - signal tracking

If the signal drifts on the display but you want to keep the center frequency on the signal peak, the center frequency can be adjusted automatically using **signal tracking**. In this case, the signal trace is surveyed in a specified bandwidth around the expected center frequency. After each sweep, the center frequency is set to the maximum signal found within the searched bandwidth. If no maximum signal above a defined threshold value is found in the searched bandwidth, the center frequency remains unchanged. The search bandwidth and the threshold value are shown in the diagram by red lines which are labeled as "TRK".

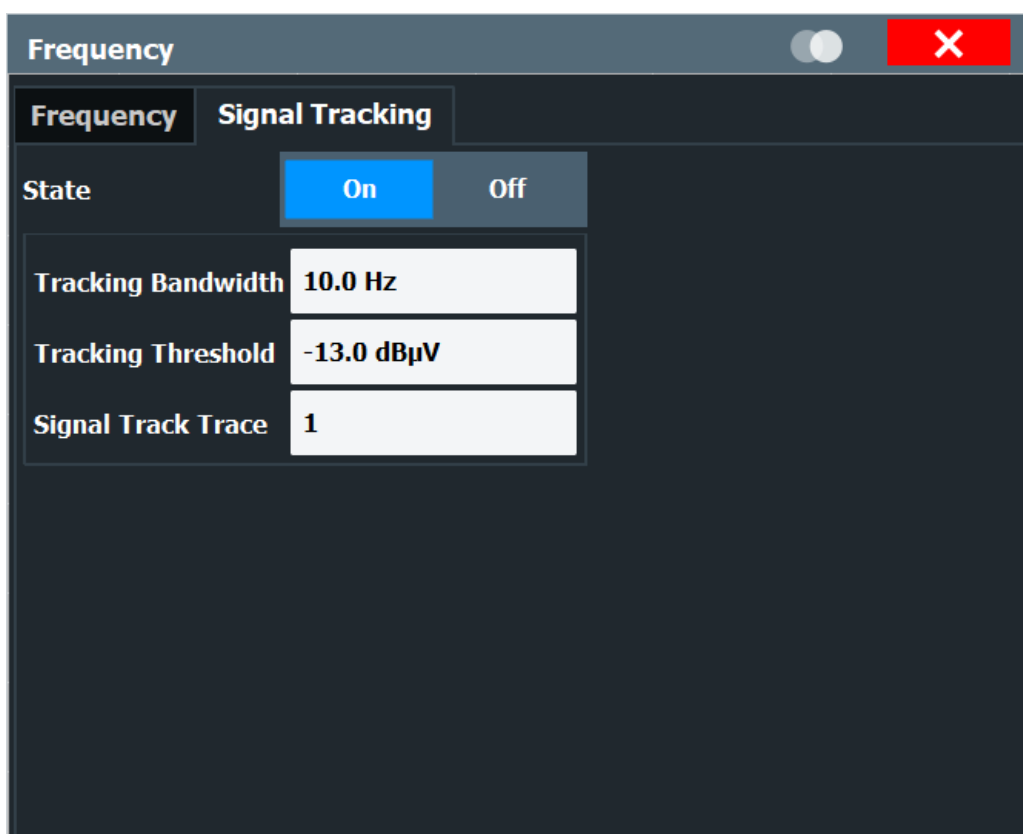

#### Signal Tracking

**Access:** "Overview" > "Frequency" > "Signal Tracking" tab

Defines the settings for signal tracking. These settings are only available for spans > 0.

For more details see [Chapter 7.3.3, "Keeping the center frequency stable - signal tracking"](#), on page 477.

If activated, after each sweep, the center frequency is set to the maximum level of the specified "Signal Track Trace" found within the searched "Tracking Bandwidth".

If the signal level does not pass the "Tracking Threshold", the center frequency is not changed.

Remote command:

`CALCulate<n>:MARKer<m>:FUNCTION:STRack[:STATe]` on page 1196

`CALCulate<n>:MARKer<m>:FUNCTION:STRack:BANDwidth` on page 1196

[CALCulate<n>:MARKer<m>:FUNction:STRack:THReshold](#) on page 1197

[CALCulate<n>:MARKer<m>:FUNction:STRack:TRACe](#) on page 1197

### 7.3.4 How to define the frequency range

The following step-by-step instructions demonstrate how to configure the frequency and span settings. For details on individual functions and settings see [Chapter 7.3.2, "Frequency and span settings"](#), on page 473.

The remote commands required to perform these tasks are described in [Chapter 13.7.2, "Defining the frequency and span"](#), on page 1190.

#### To configure the frequency and span

Frequency and span settings can be configured via the "Frequency" dialog box. Signal tracking is configured in the "Signal Tracking" tab of this dialog box.

1. To display the "Frequency" dialog box, do one of the following:
  - Select "Frequency" from the "Overview".
  - Select [FREQ] and then "Frequency Config".
  - Select [SPAN] and then "Frequency Config".
2. Define the frequency range using one of the following methods:
  - Define the "Center Frequency" and "Span".
  - Define the "Start Frequency" and "Stop Frequency".
  - To perform a measurement in the time domain, define the "Center Frequency" and select "Zero Span".
  - To perform a measurement over the entire available frequency range, select "Full Span".
  - To return to the previously set frequency range, select "Last Span".

### 7.3.5 How to move the center frequency through the frequency range

In some cases it may be useful to move the center frequency through a larger frequency range, for example from one harmonic to another.

1. In the "Frequency" dialog box, define the "Center Frequency Stepsize". This is the size by which the center frequency is to be increased or decreased in each step. Enter a manual or relative value, or set the step size to the current center frequency or marker value. To move from one harmonic to the next, use the center frequency or marker value.
2. Select the "Center Frequency" dialog field.
3. Use the arrow keys to move the center frequency in discrete steps through the available frequency range.

## 7.4 Amplitude and vertical axis configuration

In the Spectrum application, measurement results usually consist of the measured signal levels (amplitudes) displayed on the vertical (y-)axis for the determined frequency spectrum or for the measurement time (horizontal, x-axis). The settings for the vertical axis, regarding amplitude and scaling, are described here.

- [Impact of the vertical axis settings](#)..... 479
- [Amplitude settings](#).....481
- [Scaling the y-axis](#).....489
- [How to optimize the amplitude display](#).....491

### 7.4.1 Impact of the vertical axis settings

Some background knowledge on the impact of the described settings is provided here for a better understanding of the required configuration.

- [Reference level](#)..... 479
- [RF attenuation](#).....480
- [Scaling](#)..... 481

#### 7.4.1.1 Reference level

The reference level value is the maximum value the AD converter can handle without distortion of the measured value. Signal levels above this value will not be measured correctly, which is indicated by the "IF Overload" status display.

Internally, the reference level is also used to determine the optimum hardware settings for the FSW. The defined reference level should correspond with the maximum expected RF input level.



When determining the expected input level, consider that the power from *all* input signals contribute to the total power. The reference level must be higher than the total power from all signals.

The optimum reference level for the current measurement settings can be set automatically by the FSW (see "[Reference Level](#)" on page 484).

The reference level determines the amplitude represented by the topmost grid line in the display. When you change the reference level, the measurement is not restarted; the results are merely shifted in the display. Only if the reference level changes due to a coupled RF attenuation (see "[Attenuation Mode / Value](#)" on page 486), the measurement is restarted.

In general, the FSW measures the signal voltage at the RF input. The level display is calibrated in RMS values of an unmodulated sine wave signal. In the default state, the level is displayed at a power of 1 mW (= dBm). Via the known input impedance, conversion to other units is possible.

See "[Impedance](#)" on page 364.

### Reference level offset

If the signal is attenuated or amplified before it is fed into the FSW, you can define an (arithmetic) offset to the reference level so the application shows correct power results. All displayed power level results are shifted by this value, and the scaling of the y-axis is changed accordingly.

To determine the required offset, consider the external attenuation or gain applied to the input signal. For attenuation, define a positive offset so the FSW increases the displayed power values.

If an external gain is applied, define a negative offset so the FSW decreases the displayed power values.

Note, however, that the *internal* reference level (used to adjust the hardware settings to the expected signal optimally) ignores any "Reference Level Offset". Thus, it is important to keep in mind the actual power level the FSW must handle, and not to rely on the displayed reference level.

internal reference level = displayed reference level - offset

### Example

1. The initial reference level is 2 dBm with no offset.  
Both the displayed reference level and the internal reference level are 2 dBm.
2. An offset of 3 dB is defined.  
The displayed reference level is adjusted to 5 dBm.  
The internal reference level remains at 2 dBm.  
(5 dBm (displayed ref level) - 3 dB (offset) = 2 dBm)
3. Now the user decreases the reference level to 1 dBm.  
The displayed reference level is adjusted to 1 dBm.  
The internal reference level is adjusted to:  
1 dBm (displayed ref level) - 3 dB (offset) = -2 dBm.

#### 7.4.1.2 RF attenuation

The attenuation is meant to protect the input mixer from high RF input levels. The level at the input mixer is determined by the set RF attenuation according to the formula:

$$\text{level}_{\text{mixer}} = \text{level}_{\text{input}} - \text{RF attenuation}$$

The maximum mixer level allowed is 0 dBm.

Mixer levels above this value may lead to incorrect measurement results, which is indicated by the "RF Overload" status display. Furthermore, higher input levels may damage the instrument. Therefore, the required RF attenuation is determined automatically according to the reference level by default.

High attenuation levels also avoid intermodulation. On the other hand, attenuation must be compensated for by re-amplifying the signal levels after the mixer. Thus, high



attenuation values cause the inherent noise (i.e. the noise floor) to rise and the sensitivity of the analyzer decreases.

The sensitivity of a signal analyzer is directly influenced by the selected RF attenuation. The highest sensitivity is obtained at an RF attenuation of 0 dB. Each additional 10 dB step reduces the sensitivity by 10 dB, i.e. the displayed noise is increased by 10 dB. To measure a signal with an improved signal-to-noise ratio, decrease the RF attenuation.



For ideal sinusoidal signals, the displayed signal level is independent of the RF attenuation.

Depending on the type of measurement you must find a compromise between a low noise floor and high intermodulation levels, and protecting the instrument from high input levels. You achieve this best by letting the FSW determine the optimum level automatically (see "[Attenuation Mode / Value](#)" on page 486).



#### **Electronic attenuation**

If the optional electronic attenuation hardware is installed on the FSW, you can also activate an electronic attenuator. For details, see "[Using Electronic Attenuation](#)" on page 487.

### **7.4.1.3 Scaling**

In a linear display, the measurement values are distributed linearly throughout the grid. That means the entire range of measured values is divided by the number of rows in the grid (10) and each row corresponds to 1/10 of the total range. Linear scaling is useful to determine precise levels for a small range of values. However, if large and small values appear in the same display, it is difficult to determine individual values precisely or to distinguish values that are close together.

In a logarithmic display, smaller values are distributed among a much larger area of the display, while large values are condensed to a smaller area. Now it is much easier to distinguish several lower values, as they are spread over a wider area. Logarithmic scaling is useful when large ranges of values must be combined in one display. Logarithmic scaling is best applied to measurement values in logarithmic units (dB, dBm etc.).

In addition to linear or logarithmic scaling, the vertical axis can be set to display either absolute or relative values. Absolute values show the measured levels, while relative values show the difference between the measured level and the defined reference level. Relative values are indicated in percent for linear scaling, and in dB for logarithmic scaling.

## **7.4.2 Amplitude settings**

**Access:** "Overview" > "Amplitude"

Amplitude settings determine how the FSW must process or display the expected input power levels.

Configuring amplitude settings allows you to:

- Adapt the instrument hardware to the expected maximum signal level by setting the [Reference Level](#) to this maximum
- Consider an external attenuator or preamplifier (using the "Offset").
- Optimize the SNR of the measurement for low signal levels by configuring the [Reference Level](#) as high as possible without introducing compression, clipping or overload. Use early amplification by the preamplifier and a low attenuation.
- Optimize the SNR for high signal levels and ensure that the instrument hardware is not damaged, using high attenuation and AC coupling (for DC input voltage).
- Adapt the reference impedance for power results when measuring in a 75-Ohm system by connecting an external matching pad to the RF input.



#### Using external frontends

For an active external frontend, the amplitude settings refer to the RF input at the external frontend, not the levels at the RF input of the FSW. You can configure the attenuation at the external frontend and the analyzer separately. Electronic attenuation, preamplifier and noise cancellation are not available. Input coupling is always DC. Impedance is always 50  $\Omega$ .

Amplitude settings for input from the optional "Analog Baseband" interface are described in the FSW I/Q Analyzer and I/Q Input User Manual.

The remote commands required to define these settings are described in [Chapter 13.7.4.1, "Amplitude settings"](#), on page 1206.

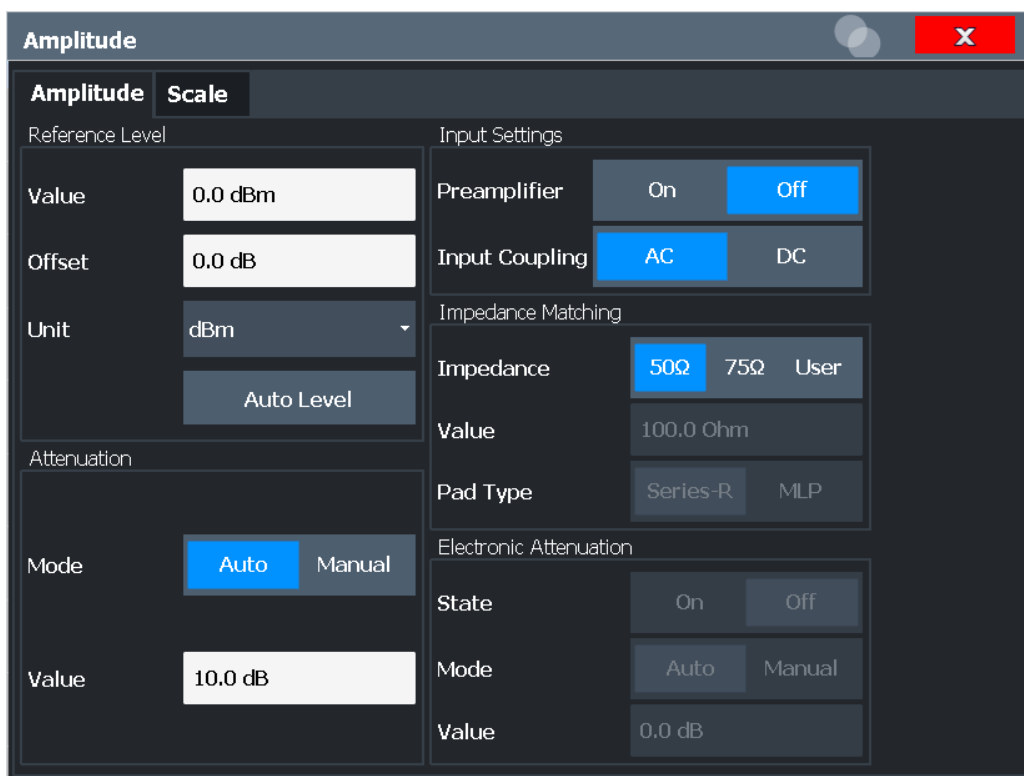

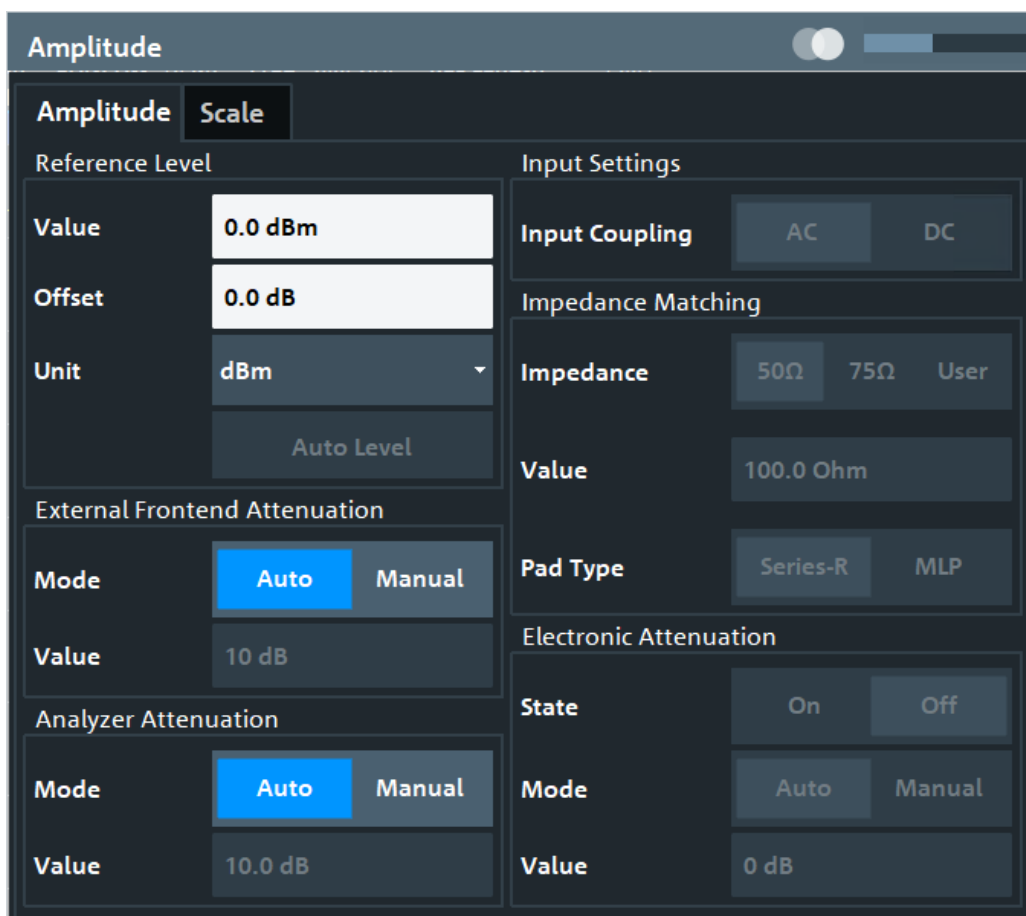

Figure 7-29: Amplitude settings for active external frontend

Reference Level..... 484

- └ Shifting the Display (Offset)..... 485
- └ Unit..... 485
- └ Setting the Reference Level Automatically (Auto Level)..... 486

External Frontend Attenuation..... 486

Attenuation Mode / Value..... 486

Using Electronic Attenuation..... 487

Input Settings..... 488

- └ Preamplifier..... 488
- └ Ext. PA Correction..... 488

Noise Cancellation..... 489

**Reference Level**

Defines the expected maximum reference level. Signal levels above this value are possibly not measured correctly. Signals above the reference level are indicated by an "IF Overload" or "OVLD" status display.

The reference level can also be used to scale power diagrams; the reference level is then used for the calculation of the maximum on the y-axis.

Since the hardware of the FSW is adapted according to this value, it is recommended that you set the reference level close above the expected maximum signal level. Thus you ensure an optimal measurement (no compression, good signal-to-noise ratio).

For details, see [Chapter 7.4.1.1, "Reference level"](#), on page 479.

Note that for input from the External Mixer (R&S FSW-B21) the maximum reference level also depends on the conversion loss, see ["Reference level"](#) on page 416.

For an active external frontend, the reference level refers to the RF input at the external frontend, not the levels at the RF input of the FSW. The hardware is adjusted to the defined reference level optimally for input signals with a crest factor of 10 dB. Thus, the required reference level for an optimal measurement can differ depending on the crest factor of the input signal.

See ["External Frontend Connection State"](#) on page 450.

Remote command:

`DISPlay[:WINDow<n>][:SUBWindow<w>]:TRACe<t>:Y[:SCALe]:RLEVel`  
on page 1207

### Shifting the Display (Offset) ← Reference Level

Defines an arithmetic level offset. This offset is added to the measured level. In some result displays, the scaling of the y-axis is changed accordingly.

Define an offset if the signal is attenuated or amplified before it is fed into the FSW so the application shows correct power results. All displayed power level results are shifted by this value.

The setting range is  $\pm 200$  dB in 0.01 dB steps.

Note, however, that the *internal* reference level (used to adjust the hardware settings to the expected signal) ignores any "Reference Level Offset". Thus, it is important to keep in mind the actual power level the FSW must handle. Do not rely on the displayed reference level (internal reference level = displayed reference level - offset).

For details, see ["Reference level offset"](#) on page 480.

Remote command:

`DISPlay[:WINDow<n>][:SUBWindow<w>]:TRACe<t>:Y[:SCALe]:RLEVel:`  
`OFFSet` on page 1208

### Unit ← Reference Level

The FSW measures the signal voltage at the RF input.

In the default state, the level is displayed at a power level of 1 mW (= dBm). Via the known input impedance (50  $\Omega$  or 75  $\Omega$ , see ["Impedance"](#) on page 364), conversion to other units is possible.

Additional units are available only if the R&S FSW-K54 (EMI measurements) option is installed. These additional "dBx/MHz" units are normalized to the pulse bandwidth and intended to be used only for EMI and EMC measurements. As opposed to the common dBm/Hz and dBm/MHz units, they are not suitable to measure power densities in the spectrum application.

Remote command:

`INPut:IMPedance` on page 1112  
`CALCulate<n>:UNIT:POWer` on page 1207

**Setting the Reference Level Automatically (Auto Level) ← Reference Level**

Automatically determines a reference level which ensures that no overload occurs at the FSW for the current input data. At the same time, the internal attenuators and the preamplifier (for analog baseband input: the full-scale level) are adjusted. As a result, the signal-to-noise ratio is optimized, while signal compression and clipping are minimized.

To determine the required reference level, a level measurement is performed on the FSW.

If necessary, you can optimize the reference level further. Decrease the attenuation level manually to the lowest possible value before an overload occurs, then decrease the reference level in the same way.

You can change the measurement time for the level measurement if necessary (see ["Changing the Automatic Measurement Time \(Meas Time Manual\)"](#) on page 532).

Remote command:

[\[SENSe:\]ADJust:LEVel](#) on page 1236

**External Frontend Attenuation**

If an external frontend is active, you can configure the attenuation for the external frontend and the analyzer separately.

For more information, see ["External frontend attenuation vs. analyzer attenuation"](#) on page 446.

When using an external frontend, only mechanical attenuation is available.

The RF attenuation can be set automatically as a function of the selected reference level (Auto mode). Automatic attenuation ensures that no overload occurs at the RF Input connector for the current reference level. It is the default setting.

In "Manual" mode, you can set the RF attenuation in 1 dB steps (down to 0 dB). Other entries are rounded to the next integer value. The range is specified in the specifications document. If the defined reference level cannot be set for the defined RF attenuation, the reference level is adjusted accordingly and the warning "limit reached" is displayed.

**NOTICE!** Risk of hardware damage due to high power levels. When decreasing the attenuation manually, ensure that the power level does not exceed the maximum level allowed at the RF input, as an overload can lead to hardware damage.

Remote command:

[INPut:ATTenuation](#) on page 1209

[INPut:ATTenuation:AUTO](#) on page 1210

**Attenuation Mode / Value**

Defines the attenuation applied to the RF input of the FSW.

This function is not available for input from the optional "Digital Baseband" interface.

The RF attenuation can be set automatically as a function of the selected reference level (Auto mode). Automatic attenuation ensures that no overload occurs at the RF Input connector for the current reference level. It is the default setting.

**Note:** Using an external frontend. If an external frontend is active, you can configure the attenuation for the external frontend and the analyzer separately. When using an external frontend, only mechanical attenuation is available.

For more information, see ["External frontend attenuation vs. analyzer attenuation"](#) on page 446.

By default and when no (optional) [electronic attenuation](#) is available, mechanical attenuation is applied.

In "Manual" mode, you can set the RF attenuation in 1 dB steps (down to 0 dB). Other entries are rounded to the next integer value. The range is specified in the specifications document. If the defined reference level cannot be set for the defined RF attenuation, the reference level is adjusted accordingly and the warning "limit reached" is displayed.

**NOTICE!** Risk of hardware damage due to high power levels. When decreasing the attenuation manually, ensure that the power level does not exceed the maximum level allowed at the RF input, as an overload can lead to hardware damage.

For details, see [Chapter 7.4.1.2, "RF attenuation"](#), on page 480.

Remote command:

[INPut:ATTenuation](#) on page 1209

[INPut:ATTenuation:AUTO](#) on page 1210

Defining attenuation for the analyzer when using an external frontend:

[INPut:SANalyzer:ATTenuation:AUTO](#) on page 1212

[INPut:SANalyzer:ATTenuation](#) on page 1211

### Using Electronic Attenuation

If the (optional) Electronic Attenuation hardware is installed on the FSW, you can also activate an electronic attenuator.

In "Auto" mode, the settings are defined automatically; in "Manual" mode, you can define the mechanical and electronic attenuation separately.

For an active external frontend, electronic attenuation is not available.

**Note:** Electronic attenuation is not available for stop frequencies (or center frequencies in zero span) above 15 GHz.

In "Auto" mode, RF attenuation is provided by the electronic attenuator as much as possible to reduce the amount of mechanical switching required. Mechanical attenuation can provide a better signal-to-noise ratio, however.

When you switch off electronic attenuation, the RF attenuation is automatically set to the same mode (auto/manual) as the electronic attenuation was set to. Thus, the RF attenuation can be set to automatic mode, and the full attenuation is provided by the mechanical attenuator, if possible.

The electronic attenuation can be varied in 1 dB steps. If the electronic attenuation is on, the mechanical attenuation can be varied in 5 dB steps. Other entries are rounded to the next lower integer value.

For the FSW85, the mechanical attenuation can be varied only in 10 dB steps.

If the defined reference level cannot be set for the given attenuation, the reference level is adjusted accordingly and the warning "limit reached" is displayed in the status bar.

Remote command:

[INPut:EATT:STATe](#) on page 1211

[INPut:EATT:AUTO](#) on page 1211

[INPut:EATT](#) on page 1210

### Input Settings

Some input settings affect the measured amplitude of the signal, as well.

The parameters "Input Coupling" and "Impedance" are identical to those in the "Input" settings.

See [Chapter 7.2.2, "Input source settings"](#), on page 362.

### Preamplifier ← Input Settings

If the (optional) internal preamplifier hardware is installed on the FSW, a preamplifier can be activated for the RF input signal.

You can use a preamplifier to analyze signals from DUTs with low output power.

**Note:** If an optional external preamplifier is activated, the internal preamplifier is automatically disabled, and vice versa.

For an active external frontend, a preamplifier is not available.

This function is not available for input from the (optional) "Digital Baseband" interface.

For all FSW models except for FSW85, the following settings are available:

"Off"	Deactivates the preamplifier.
"15 dB"	The RF input signal is amplified by about 15 dB.
"30 dB"	The RF input signal is amplified by about 30 dB.

For older FSW43/FSW50/FSW67 models, the input signal is always amplified by about 30 dB when the preamplifier is active.

For FSW85 models, no preamplifier is available.

Remote command:

[INPut:GAIN:STATE](#) on page 1213

[INPut:GAIN\[:VALue\]](#) on page 1214

### Ext. PA Correction ← Input Settings

This function is only available if an external preamplifier is connected to the FSW, and only for frequencies above 1 GHz. For details on connection, see the preamplifier's documentation.

Using an external preamplifier, you can measure signals from devices under test with low output power, using measurement devices which feature a low sensitivity and do not have a built-in RF preamplifier.

When you connect the external preamplifier, the FSW reads out the touchdown (.S2P) file from the EEPROM of the preamplifier. This file contains the s-parameters of the preamplifier. As soon as you connect the preamplifier to the FSW, the preamplifier is permanently on and ready to use. However, you must enable data correction based on the stored data explicitly on the FSW using this setting.

When enabled, the FSW automatically compensates the magnitude and phase characteristics of the external preamplifier in the measurement results. Any internal preamplifier, if available, is disabled.

An active external preamplifier is also included in the calculation of the combined user-defined frequency response correction filter and displayed in the preview for SnP files (see ["Preview"](#) on page 776).



For FSW85 models with two RF inputs, you can enable correction from the external preamplifier for each input individually, but not for both at the same time.

When disabled, no compensation is performed even if an external preamplifier remains connected.

Remote command:

`INPut:EGain[:STATe]` on page 1212

### Noise Cancellation

The FSW can correct the results by removing the inherent noise of the analyzer, which increases the dynamic range.

In this case, a reference measurement of the inherent noise of the analyzer is carried out. The measured noise power is then subtracted from the power in the channel that is being analyzed (first active trace only).

The inherent noise of the instrument depends on the selected center frequency, resolution bandwidth and level setting. Therefore, the correction function is disabled whenever one of these parameters is changed. A disable message is displayed on the screen. To enable the correction function after changing one of these settings, activate it again. A new reference measurement is carried out.

Noise cancellation is also available in zero span.

For an active external frontend, noise cancellation is not available. See "[External Frontend Connection State](#)" on page 450.

Currently, noise cancellation is only available for the following trace detectors (see "[Detector](#)" on page 624):

- RMS
- Average
- Sample
- Positive peak

Remote command:

`[SENSe:]POWer:NCORrection` on page 1208

## 7.4.3 Scaling the y-axis

The individual scaling settings that affect the vertical axis are described here.

**Access:** "Overview" > "Amplitude" > "Scale" tab

**Or:** [AMPT] > "Scale Config"

The remote commands required to define these settings are described in [Chapter 13.7.4, "Configuring the vertical axis \(amplitude, scaling\)"](#), on page 1206.

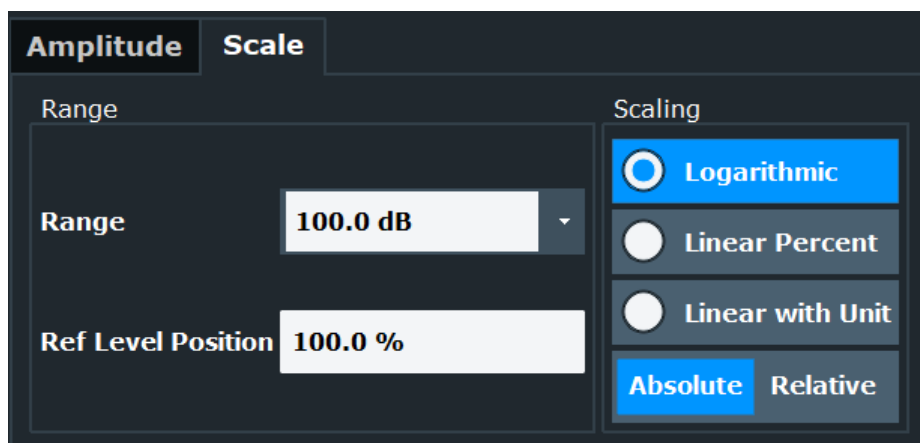

Range.....	490
Ref Level Position.....	490
Auto Scale Once.....	490
Scaling.....	491

### Range

Defines the displayed y-axis range in dB.

The default value is 100 dB.

Remote command:

`DISPlay[:WINDow<n>][:SUBWindow<w>]:TRACe<t>:Y[:SCALe]` on page 1214

### Ref Level Position

Defines the reference level position, i.e. the position of the maximum AD converter value on the level axis in %.

0 % corresponds to the lower and 100 % to the upper limit of the diagram.

Values from -120 % to +280 % are available.

Larger values are useful for small scales, such as a power range of 10 dB or 20 dB, and low signal levels, for example 60 dB below the reference level. In this case, large reference level position values allow you to see the trace again.

For spectrograms, this value defines the position of the reference level value within the span covered by the color map. In this case, the value is given in %, where 0 % corresponds to the maximum (right end) and 100 % to the minimum (left end) of the color map.

Remote command:

`DISPlay[:WINDow<n>][:SUBWindow<w>]:TRACe<t>:Y[:SCALe]:RPOSition` on page 1216

### Auto Scale Once

Automatically determines the optimal range and reference level position to be displayed for the current measurement settings.

The display is only set once; it is not adapted further if the measurement settings are changed again.

Remote command:

`DISPlay[:WINDow<n>][:SUBWindow<w>]:TRACe<t>:Y[:SCALe]:AUTO ONCE`  
on page 1215

### Scaling

Defines the scaling method for the y-axis.

For more information, see [Chapter 7.4.1.3, "Scaling"](#), on page 481.

"Logarithmic"	Logarithmic scaling (only available for logarithmic units - dB..., and A, V, Watt)
"Linear with Unit"	Linear scaling in the unit of the measured signal
"Linear Percent"	Linear scaling in percentages from 0 to 100
"Absolute"	The labeling of the level lines refers to the absolute value of the reference level (not available for "Linear Percent")
"Relative"	The scaling is in dB, relative to the reference level (only available for logarithmic units - dB...). The upper line of the grid (reference level) is always at 0 dB.

Remote command:

`DISPlay[:WINDow<n>][:SUBWindow<w>]:TRACe<t>:Y:SPACing` on page 1216  
`DISPlay[:WINDow<n>][:SUBWindow<w>]:TRACe<t>:Y[:SCALe]:MODE`  
on page 1215

## 7.4.4 How to optimize the amplitude display

This section gives you some advice on how to optimize the display of the measured signal amplitudes depending on the required evaluation.

1. Perform a measurement with the default settings to get an impression of the values to be expected.
2. Use the "Auto Level" function ([AUTO] menu) to optimize the reference level.
3. Use the "Auto Scale Once" function ([AUTO] menu) to optimize the scaling.
4. **To determine a precise level at a specific point in the signal:**
  - Reduce the "Range" of the y-axis to a small area around the required level. If necessary, change the "Ref Level Position" so the required range remains visible.
  - Select "Linear with Unit" scaling.

Now you can set a marker at the point in question and read the result.

5. **To detect a spurious signal close to the noise floor:**
  - Set the "RF Attenuation" to "Manual" mode and reduce the "Value" to lower the noise floor.
  - Select "Relative" - "Logarithmic" scaling.

Now you can determine if any spurious levels of a certain size are visible.

## 7.5 Bandwidth, filter and sweep configuration

The basic bandwidth, filter and sweep settings that apply to most measurements are described here. These parameters define how the data is measured: how much data is collected internally and which filters are used.

- [Impact of the bandwidth, filter and sweep settings](#)..... 492
- [Bandwidth, filter and sweep settings](#).....498

### 7.5.1 Impact of the bandwidth, filter and sweep settings

The bandwidth, filter and sweep settings are closely related and interdependent. The values available for resolution bandwidth and video bandwidth depend on the selected filter type. In addition, these settings have an impact on other measurement parameters. The following equation shows the interdependency of these settings:

$$T_{\text{MIN}} = K \cdot \text{Span} / \text{RBW}^2$$

where K = Filter constant

By default, a Gaussian filter is used. The resolution bandwidth, the video bandwidth and the "Sweep Time" are set automatically according to the set span, and default coupling is used. Thus, the following settings are applied:

$$\text{RBW} = \text{Span} / 100$$

$$\text{VBW} = \text{RBW}$$

$$\text{"Sweep Time"} = T_{\text{min}} \text{ for set Span, RBW, VBW}$$

When defining the bandwidth and filter settings, consider the impact of the individual settings on the other settings and the measurement result, as described in more detail in the following sections.

- [Separating signals by selecting an appropriate resolution bandwidth](#)..... 492
- [Smoothing the trace using the video bandwidth](#)..... 493
- [Coupling VBW and RBW](#)..... 494
- [Coupling span and RBW](#).....494
- [How data is measured: the sweep type](#)..... 495
- [Which data may pass: filter types](#)..... 496
- [How long the data is measured: Sweep Time](#).....497
- [How much data is measured: sweep points and sweep count](#)..... 497
- [How often data is measured: sweep mode](#).....498

#### 7.5.1.1 Separating signals by selecting an appropriate resolution bandwidth

The resolution bandwidth defines the 3 dB bandwidth of the resolution filter to be used. An RF sinusoidal signal is displayed according to the passband characteristic of the resolution filter (RBW), i.e. the signal display reflects the shape of the filter.

A basic feature of a signal analyzer is being able to separate the spectral components of a mixture of signals. The resolution at which the individual components can be separated is determined by the resolution bandwidth. Selecting a resolution bandwidth that is too large may make it impossible to distinguish between spectral components, i.e. they are displayed as a single component. Smaller resolution bandwidths, however, increase the required "Sweep Time".

Two signals with the same amplitude can be resolved if the resolution bandwidth is smaller than or equal to the frequency spacing of the signal. If the resolution bandwidth is equal to the frequency spacing, the spectrum display screen shows a level drop of 3 dB precisely in the center of the two signals. Decreasing the resolution bandwidth makes the level drop larger, which thus makes the individual signals clearer.

The highest sensitivity is obtained at the smallest bandwidth (1 Hz). If the bandwidth is increased, the reduction in sensitivity is proportional to the change in bandwidth. Increasing the bandwidth by a factor of 3 increases the displayed noise by approx. 5 dB (4.77 dB precisely). If the bandwidth is increased by a factor of 10, the displayed noise increases by a factor of 10, i.e. 10 dB.

If there are large level differences between signals, the resolution is determined by selectivity as well as by the resolution bandwidth that has been selected. The measure of selectivity used for signal analyzers is the ratio of the 60 dB bandwidth to the 3 dB bandwidth (= shape factor).

For the FSW, the shape factor for bandwidths is  $< 5$ , i.e. the 60 dB bandwidth of the 30 kHz filter is  $< 150$  kHz.

The higher spectral resolution with smaller bandwidths is won by longer sweep times for the same span. The sweep time has to allow the resolution filters to settle during a sweep at all signal levels and frequencies to be displayed.

If the RBW is too large, signal parts that are very far away (e.g. from a different signal) are considered in the measurement and distort the results. The noise increases.

If the RBW is too small, parts of the signal are lost. As the displayed signal always reflects the shape of the filter, select a bandwidth large enough so the displayed signal reflects the entire shape of the filter.

#### 7.5.1.2 Smoothing the trace using the video bandwidth

The video filters are responsible for smoothing the displayed trace. Using video bandwidths that are small compared to the resolution bandwidth, only the signal average is displayed and noise peaks and pulsed signals are repressed. If pulsed signals are to be measured, it is advisable to use a video bandwidth that is large compared to the resolution bandwidth ( $VBW = 10 \times RBW$ ) for the amplitudes of pulses to be measured correctly.

The level of a sine wave signal is not influenced by the video bandwidth. A sine wave signal can therefore be freed from noise by using a video bandwidth that is small compared with the resolution bandwidth, and thus be measured more accurately.



### RMS/Average detector and VBW

If an RMS detector is used, the video bandwidth in the hardware is bypassed. Thus, duplicate trace averaging with small VBWs and RMS or average detector no longer occurs. However, the VBW is still considered when calculating the "Sweep Time". This leads to a longer "Sweep Time" for small VBW values. Thus, you can reduce the VBW value to achieve more stable trace curves even when using an RMS detector. Normally, if the RMS detector is used, the "Sweep Time" should be increased to get more stable traces.

If an average detector is used, the video bandwidth in the hardware is only bypassed if the video filter is set to "Auto" mode. Use this mode to avoid duplicate trace averaging with small VBWs.

#### 7.5.1.3 Coupling VBW and RBW

The video bandwidth can be coupled to the resolution bandwidth automatically. In this case, if the resolution bandwidth is changed, the video bandwidth is automatically adjusted.

Coupling is recommended if a minimum "Sweep Time" is required for a selected resolution bandwidth. Narrow video bandwidths require longer "Sweep Time"s due to the longer settling time. Wide bandwidths reduce the signal/noise ratio.

**Table 7-3: Overview of RBW/VBW ratios and recommendations for use**

Ratio RBW/VBW	Recommendation for use
1/1	Recommended for sinusoidal signals This is the default setting for automatic coupling.
0.1	Recommended when the amplitudes of pulsed signals are to be measured correctly. The IF filter is exclusively responsible for the pulse shape. No additional evaluation is performed by the video filter.
10	Recommended to suppress noise and pulsed signals in the video domain.
Manually set (0.001 to 1000)	Recommended for other measurement requirements

#### 7.5.1.4 Coupling span and RBW

The resolution bandwidth can be coupled to the span setting, either by a manually defined factor or automatically. If the span is changed, the resolution bandwidth is automatically adjusted. The automatic coupling adapts the resolution bandwidth to the currently set frequency span/100.

The 6 dB bandwidths 200 Hz, 9 kHz and 120 kHz and the available channel filters are not changed by the coupling.

With a span/RBW ratio of 100 and a screen resolution of 1000 pixels, each frequency in the spectrum is displayed by 10 pixels. A span/RBW ratio of 1000 provides the highest resolution.

### 7.5.1.5 How data is measured: the sweep type

In a standard analog **frequency sweep**, the local oscillator of the analyzer sweeps the applied signal quasi analog from the start to the stop frequency to determine the frequency spectrum.

Alternatively, the analyzer can sample signal levels over time at a defined frequency and transform the data to a spectrum by Fast Fourier Transformation (**FFT**). Although this measurement method requires additional calculations, it can provide results much faster than the frequency sweep, in particular for small RBWs.

Which sweep mode is appropriate for the current measurement depends on the span, RBW, VBW and "Sweep Time" settings. By default ("Auto" sweep type), the FSW automatically uses the sweep type with the highest sweep rate depending on these measurement settings.

For EMI measurements, the FSW automatically selects sweep mode for auto sweep type. You can also select sweep mode manually.



#### Restrictions for FFT mode

FFT mode is not available when using 5-pole filters, channel filters or RRC filters, or the quasi peak detector. In this case, sweep mode is used.

The same applies when an external generator is active (with the optional External Generator Control).

FFT mode is not available if CISPR detectors are used.

(See [Chapter 6.13.3.2, "Detectors and dwell time"](#), on page 336).

#### Optimization

In FFT mode, FFT analysis is performed to determine a spectrum of frequencies. Several analysis steps are required to cover the entire span. The subspan which is covered by one FFT analysis depends on the RBW. The subspan cannot be defined directly, but it can be optimized according to measurement requirements.

Narrow subspans provide a higher dynamic range, and also allow you to perform measurements near a carrier with a reduced reference level. With a wide subspan, the carrier and the useful signal are likely to be measured at the same time, in which case the powers of both signals are summarized, so the reference level must be high enough to consider this factor. With a narrow subspan, this is less likely to happen, so the reference level can be reduced.

**For an optimal dynamic range**, the narrowest possible subspan (depending on the RBW) is used. Furthermore, the autorange function for the internal IF gain calculation is activated to obtain the best control range of the A/D converter.

On the other hand, the narrower the subspan, the more steps are required to cover the entire span, thus increasing analysis and calculation time. To **optimize the sweep rate**, the widest possible subspan (depending on the RBW) is used.



For an optimal sweep rate, it is recommended that you set the "Sweep Time" to "Auto", as well.

For general purpose measurements, an "Auto" mode is available, which provides a **compromise between a large dynamic range and a fast sweep**. In this case, a medium-sized subspan is used.



#### FFT mode and external mixers (R&S FSW-B21)

The subspan optimization modes "Dynamic" and "Auto" include automatic suppression of unwanted mixing products. Thus, when using external mixers (R&S FSW-B21), use the "Speed" mode to obtain similar results in FFT mode as in normal sweep mode.



#### FFT mode and EMI measurements (R&S FSW-K54)

For EMI measurements (using R&S FSW-K54), the subspan optimization mode "Dynamic" is not supported. "Auto" mode always uses "Speed" optimization.

#### Optimization for zero span sweeps

For normal sweeps in the time domain (zero span), the optimization mode determines the selection of the A/D converter prefilter, which depends on the RBW.

In **"Dynamic" mode**, the narrowest possible prefilter is used.

In **"Speed" mode**, the widest possible prefilter is used.

In **"Auto" mode**, a medium-sized prefilter is used.

#### Number of subspans

Several analysis steps are required to cover the entire span, in particular if the span exceeds the maximum I/Q bandwidth for a single measurement. In this case, each FFT analysis covers a subspan. The subspan cannot be defined directly, but it can be optimized according to measurement requirements, as described above. The number of required subspans is indicated in the sweep settings dialog box. Thus, you can determine the required measurement time for an individual span (and thus sweep point) as:

$$\langle \text{Meas time subspan} \rangle = \langle \text{sweep time} \rangle / \langle \text{no. of subspans} \rangle$$

#### 7.5.1.6 Which data may pass: filter types

While the filter is irrelevant when measuring individual narrowband signals (as long as the signal remains within the RBW), the measurement result for broadband signals is very dependant on the selected filter type and its shape. If the filter is too narrow, the signal is distorted by the filter. If the filter is too wide, multiple signals can no longer be distinguished. Generally, the smaller the filter width and the steeper its edges, the longer the settling time and thus the longer the "Sweep Time" must be.

All resolution bandwidths are realized with digital filters. Normal (3dB) Gaussian filters are set by default. Some communication standards require different filters.

For a list of available filter types, see the specifications document.



### Normal (3 dB) Gaussian filters

Gaussian filters provide a good compromise between steep edges and a short settling time. This filter is suitable for most measurement tasks and is used by default.

The available Gaussian (3 dB) filters are listed in the FSW specifications document.

### Channel filters

Channel filters are fairly steep but require a long settling time; they are useful for pulse measurements in the time domain.

### RRC filters

Root raised cosine filters are similar in shape to channel filters and are required by some measurement standards.

### 5-Pole filters

5-Pole filters are very broad and allow for a large bandwidth to pass.

#### 7.5.1.7 How long the data is measured: Sweep Time

Each filter has a settling time that must be awaited in order to obtain correct results. Since the resolution bandwidth and video bandwidth define the filter, the smaller of the two determines the minimum "Sweep Time" required for the measurement. Allowed values depend on the ratio of span to RBW and RBW to VBW.

If the selected "Sweep Time" is too short for the selected bandwidth and span, level measurement errors will occur. In this case, the FSW displays the error message "Sweep time too low" and marks the indicated "Sweep Time" with a red bullet. Furthermore, a status bit indicates an error.

(For more information see [Chapter 12.2.2.14, "STATus:QUESTionable:TIME register"](#), on page 834.)

The "Sweep Time" can be coupled to the span (not zero span), video bandwidth (VBW) and resolution bandwidth (RBW) automatically. If the span, resolution bandwidth or video bandwidth is changed, the "Sweep Time" is automatically adjusted.



Note that the "Sweep Time" only indicates how long data is captured; the time required to process the captured data may be considerably longer, in particular for FFT mode. For FFT mode, an estimated duration is indicated behind the "Sweep Time" in the channel bar (for RF measurements only).

#### 7.5.1.8 How much data is measured: sweep points and sweep count

By default, 1001 data points are determined in a single sweep. During the next sweep, 1001 new data points are collected, and so on. The number of **sweep points** defines how much of the entire span is covered by a single data point. By increasing the number of sweep points you can increase the reliability of the individual data points and thus the accuracy of the analyzed results. However, these data points are all stored on

the instrument, occupying a large amount of memory, and each sweep point increases the overall measurement time.

The number of sweeps to be performed in single sweep mode is defined by the "Sweep Count". Values from 0 to 200000 are allowed. If the values 0 or 1 are set, one sweep is performed. The sweep count is applied to all the traces in a diagram.

If the trace configurations "Average", "Max Hold" or "Min Hold" are set, the "Sweep/Average Count" also determines the number of averaging or maximum search procedures (see ["Analyzing several traces - trace mode"](#) on page 618).

For details on how the number of sweep points and the sweep count affect the trace results on the screen, see ["Mapping samples to sweep points with the trace detector"](#) on page 609.

#### 7.5.1.9 How often data is measured: sweep mode

How often the spectrum is swept depends on the sweep mode. Either a certain number of sweeps can be defined ("Sweep Count") which are performed in "Single Sweep" mode, or the sweep is repeated continuously ("Continuous Sweep" mode).

By default, the data is collected for the specified number of sweeps and the corresponding trace is displayed. When the next sweep is started, the previous trace is deleted.

However, the data from a single sweep run can also be retained and displayed together with the new data ("Continue Single Sweep" mode). This is particularly of interest when using the trace configurations "Average" or "Max Hold" to take previously recorded measurements into account for averaging/maximum search (see ["Analyzing several traces - trace mode"](#) on page 618).

### 7.5.2 Bandwidth, filter and sweep settings

**Access:** "Overview" > "Bandwidth"

The remote commands required to define these settings are described in [Chapter 13.7.3, "Configuring bandwidth and sweep settings"](#), on page 1197.

How to perform a basic sweep measurement is described in [Chapter 6.1.2, "How to perform a basic sweep measurement"](#), on page 130.

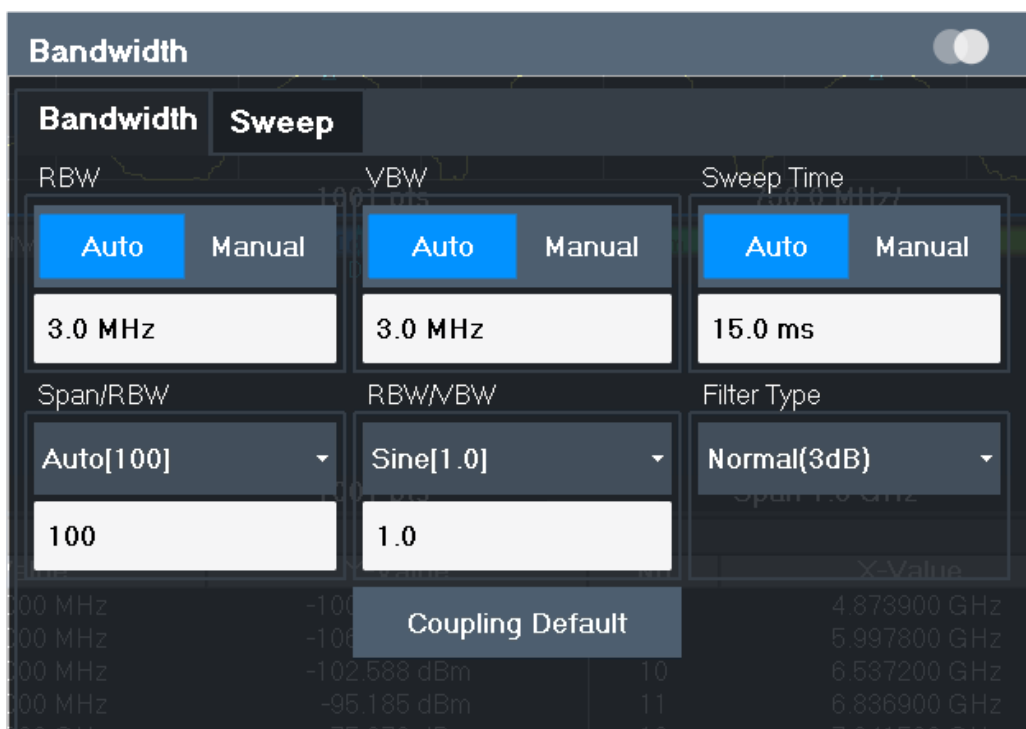

Figure 7-30: Bandwidth dialog box for RF measurements

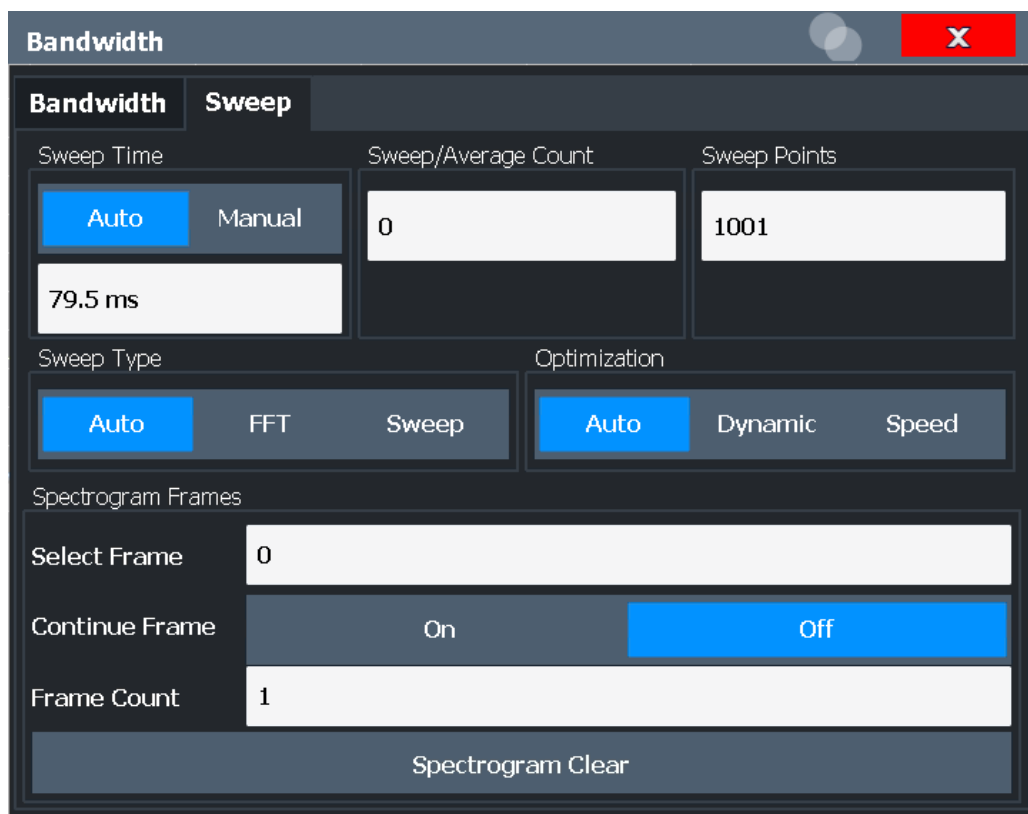

Figure 7-31: Sweep dialog box for spectrogram display

RBW.....	501
VBW.....	501
Sweep Time.....	502
Span/RBW.....	502
RBW/VBW.....	502
Filter Type.....	503
Default Coupling.....	503
Sweep/Average Count.....	504
Sweep Points.....	504
Optimization.....	504
Sweep Type.....	505
FFT Subspans.....	506
Single Sweep / Run Single.....	506
Continuous Sweep / Run Cont.....	506
Continue Single Sweep.....	507
Spectrogram Frames.....	507
L Select Frame.....	507
L Continue Frame.....	507
L Frame Count.....	508
L Clear Spectrogram.....	508

**RBW**

Defines the resolution bandwidth. The available resolution bandwidths are specified in the specifications document. Numeric input is always rounded to the nearest possible bandwidth.

If "Auto" is selected, the resolution bandwidth is coupled to the selected span (for span > 0). If the span is changed, the resolution bandwidth is automatically adjusted.

If the resolution bandwidth is defined manually, a green bullet is displayed next to the "RBW" display in the channel bar.

For a list of supported filters, see the specifications document.

For more information see [Chapter 7.5.1.1, "Separating signals by selecting an appropriate resolution bandwidth"](#), on page 492.

**Note:** Restrictions.

- For measurements on I/Q data in the frequency domain, the maximum RBW is 1 MHz.
- Some additional Gaussian filters are provided for special measurements, such as 5G NR spurious emissions measurements. They are only available if you enter the value manually, not using the rotary knob or stepping through the filter values. They are not supported by all applications. For these particular filters, gating is also possible. The following values indicate the 3-dB filter width:
  - 51 kHz
  - 150 kHz
  - 250 kHz
  - 400 kHz
  - 450 kHz
  - 6 MHz
  - 8 MHz
- For EMI measurements using the quasipeak detector, the 1 MHz RBW filter is not available (see [Chapter 6.13.3.1, "Resolution bandwidth and filter types"](#), on page 335).

Remote command:

[\[SENSe:\]BANDwidth\[:RESolution\]](#) on page 1198

[\[SENSe:\]BANDwidth\[:RESolution\]:AUTO](#) on page 1198

**VBW**

Defines the video bandwidth automatically or manually.

For more information see [Chapter 7.5.1.2, "Smoothing the trace using the video bandwidth"](#), on page 493.

- |          |                                                                                                                                                                                                                                                                                                                       |
|----------|-----------------------------------------------------------------------------------------------------------------------------------------------------------------------------------------------------------------------------------------------------------------------------------------------------------------------|
| "Auto"   | The video bandwidth is coupled to the resolution bandwidth. If the resolution bandwidth is changed, the video bandwidth is automatically adjusted.                                                                                                                                                                    |
| "Manual" | For manual mode, define the bandwidth value. The available video bandwidths are specified in the specifications document. Numeric input is always rounded to the nearest possible bandwidth.<br>If the video bandwidth is defined manually, a green bullet is displayed next to the "VBW" display in the channel bar. |

Remote command:

[SENSe:]BANDwidth:VIDeo:AUTO on page 1200

[SENSe:]BANDwidth:VIDeo on page 1200

[SENSe:]BANDwidth:VIDeo:TYPE on page 1201

### Sweep Time

Defines the duration of a single sweep, during which the defined number of sweep points are measured. The "Sweep Time" can be defined automatically or manually.

The allowed "Sweep Time" depends on the device model; refer to the specifications document.

For more information see [Chapter 7.5.1.7, "How long the data is measured: Sweep Time"](#), on page 497.

**Note:** The "Sweep Time" only indicates how long data is captured; the time required to process the captured data may be considerably longer, in particular for FFT mode. For FFT mode, an estimated duration is indicated behind the "Sweep Time" in the channel bar (for RF measurements only).

- |          |                                                                                                                                                                                                                                     |
|----------|-------------------------------------------------------------------------------------------------------------------------------------------------------------------------------------------------------------------------------------|
| "Auto"   | The "Sweep Time" is coupled to the span (not zero span), video bandwidth (VBW) and resolution bandwidth (RBW). If the span, resolution bandwidth or video bandwidth is changed, the "Sweep Time" is automatically adjusted.         |
| "Manual" | For manual mode, define the "Sweep Time". Allowed values depend on the ratio of span to RBW and RBW to VBW. For details refer to the specifications document. Numeric input is always rounded to the nearest possible "Sweep Time". |

Remote command:

[SENSe:]SWEep:TIME:AUTO on page 1205

[SENSe:]SWEep:TIME on page 1204

[SENSe:]SWEep:DURation? on page 1202

### Span/RBW

Sets the coupling ratio if [RBW](#) is set to auto mode.

For more information see [Chapter 7.5.1.4, "Coupling span and RBW"](#), on page 494.

- |             |                                                                                                                         |
|-------------|-------------------------------------------------------------------------------------------------------------------------|
| "Auto[100]" | "Resolution Bandwidth" = "Span/100"<br>This coupling ratio is the default setting of the FSW.                           |
| "Manual"    | The coupling ratio is defined manually.<br>The span/resolution bandwidth ratio can be set in the range from 1 to 10000. |

Remote command:

[SENSe:]BANDwidth[:RESolution]:RATio on page 1199

### RBW/VBW

Sets the coupling ratio between the resolution bandwidth and the video bandwidth.

This setting is only effective if [VBW](#) is set to auto mode.

For more information see [Chapter 7.5.1.3, "Coupling VBW and RBW"](#), on page 494.

"Sine[1/1]"	"Video Bandwidth" = "Resolution Bandwidth" This is the default setting for the coupling ratio RBW/VBW and is recommended if sinusoidal signals are to be measured.
"Pulse[0.1]"	"Video Bandwidth" = 10 x "Resolution Bandwidth" or "Video Bandwidth" = "10 MHz" (= max. VBW) Recommended for pulse signals
"Noise[10]"	"Video Bandwidth" = "Resolution Bandwidth/10" Recommended for noise measurements
"Manual"	The coupling ratio is defined manually. The RBW/VBW ratio can be set in the range of 0.001 to 1000.

Remote command:

[\[SENSe:\]BANDwidth:VIDeo:AUTO](#) on page 1200

[\[SENSe:\]BANDwidth:VIDeo:RATio](#) on page 1200

### Filter Type

Defines the filter type.

The following filter types are available:

- Normal (3dB)
- Channel
- RRC (not available for sweep type "FFT")
- 5-Pole (not available for sweep type "FFT")
- CISPR (6 dB) - requires EMI (R&S FSW-K54) option
- MIL Std (6 dB) - requires EMI (R&S FSW-K54) option

For more information, see [Chapter 7.5.1.6, "Which data may pass: filter types"](#), on page 496.

**Note:** The EMI-specific filter types are available if the EMI (R&S FSW-K54) measurement option is installed, even if EMI measurement is not active. If you select a CISPR trace detector, the filter type is automatically also set to CISPR. An active CISPR filter is indicated in the channel info, next to the RBW information. For details, see [Chapter 6.13.3.1, "Resolution bandwidth and filter types"](#), on page 335.

The RBW filter configured in the bandwidth settings is identical to the filter configured in the EMI configuration.

Remote command:

[\[SENSe:\]BANDwidth\[:RESolution\]:TYPE](#) on page 1199

### Default Coupling

Sets all coupled functions to the default state ("Auto"). In addition, the ratio "RBW/VBW" is set to "Sine[1/1]" and the ratio "Span/RBW" to 100.

For more information see [Chapter 7.5.1.3, "Coupling VBW and RBW"](#), on page 494.

Remote command:

[\[SENSe:\]BANDwidth\[:RESolution\]:AUTO](#) on page 1198

[\[SENSe:\]BANDwidth:VIDeo:AUTO](#) on page 1200

[\[SENSe:\]SWEep:TIME:AUTO](#) on page 1205

### Sweep/Average Count

Defines the number of sweeps to be performed in the single sweep mode. Values from 0 to 200000 are allowed. If the values 0 or 1 are set, one sweep is performed.

The sweep count is applied to all the traces in all diagrams.

If the trace modes "Average", "Max Hold" or "Min Hold" are set, this value also determines the number of averaging or maximum search procedures.

In continuous sweep mode, if "Sweep Count" = 0 (default), averaging is performed over 10 sweeps. For "Sweep Count" = 1, no averaging, maxhold or minhold operations are performed.

For more information, see [Chapter 7.5.1.8, "How much data is measured: sweep points and sweep count"](#), on page 497.

For spectrogram displays, the sweep count determines how many sweeps are combined in one frame in the spectrogram; that is: how many sweeps the FSW performs to plot one trace in the spectrogram result display. For more details, see ["Time frames"](#) on page 630.

Remote command:

[\[SENSe:\] SWEEp:COUNT](#) on page 1202

[\[SENSe:\] AVERAge<n>:COUNT](#) on page 1245

### Sweep Points

Defines the number of measured values to be collected during one sweep.

For details see [Chapter 7.5.1.8, "How much data is measured: sweep points and sweep count"](#), on page 497.

All values from 101 to 100001 can be set. The default value is 1001 sweep points.

For EMI measurements, 200001 sweep points are available.

Remote command:

[\[SENSe:\] SWEEp\[:WINDow<n>\]:POINTs](#) on page 1204

### Optimization

In FFT mode, several FFT analysis steps are required to cover the entire measurement span. The span which is covered by one FFT analysis step is called *subspan*. The subspan cannot be defined directly, but it can be optimized according to measurement requirements.

**Note:** To determine the number of required subspans for the measurement, see ["FFT Subspans"](#) on page 506.



**Table 7-4: Optimization parameters in FFT mode**

Optimization mode	Description
"Dynamic"	Optimizes the dynamic range by using the narrowest possible subspan (depending on the RBW). The autorange function for the internal IF gain calculation is activated to obtain the best control range for the A/D converter.
"Speed"	Optimizes the sweep rate by using the widest possible subspan (depending on the RBW). The autorange function for the internal IF gain calculation is deactivated. (Note: set the reference level accordingly to optimize the control range for the A/D converter). It is recommended that you set the <a href="#">Sweep Time</a> to "Auto" to optimize the sweep rate.
"Transient"	Recommended mode for measurements on highly transient signals in spectrum analysis. It increases the measurement speed with a trade off in dynamic range. Only available for FSW67/85 models.
"Auto"	Uses a medium-sized subspan to obtain a compromise between a large dynamic range and a fast sweep rate. The autorange function for the internal IF gain calculation is deactivated. (Note: set the reference level accordingly to optimize the control range for the A/D converter).

**Note: FFT mode and external mixers (R&S FSW-B21)**

The subspan optimization modes "Dynamic" and "Auto" include automatic suppression of unwanted mixing products. Thus, when using external mixers (R&S FSW-B21), use the "Speed" mode to obtain similar results in FFT mode as in frequency sweep mode.

**Zero span mode**

For zero span measurements, the optimization mode defines the selection of the A/D converter prefilter.

**Table 7-5: Optimization parameters in zero span mode**

Optimization mode	Description
Dynamic	The narrowest filter possible (depending on the RBW) is used.
Speed	The widest filter possible (depending on the RBW) is used.
Auto	A medium-sized prefilter is used.

**Note: EMI measurements**

For EMI measurements (using R&S FSW-K54), "Dynamic" mode is not supported. "Auto" mode always uses "Speed" optimization.

Remote command:

[\[SENSe:\]SWEep:OPTimize](#) on page 1203

**Sweep Type**

Defines the sweep type.

- "Sweep" In the standard sweep mode, the local oscillator is set to provide the spectrum quasi analog from the start to the stop frequency.
- "Auto" Automatically sets the fastest available sweep type for the current measurement (Frequency or FFT). Auto mode is set by default.

"FFT" The FFT sweep samples on a defined frequency value and transforms it to the spectrum by fast Fourier transformation (FFT) (see also [Chapter 7.5.1.5, "How data is measured: the sweep type"](#), on page 495).

FFT is not available in the following cases:

- When using 5-Pole filters or RRC filters
- When using one of the CISPR detectors
- When an external generator is active (via hardware option)

In these cases, frequency sweep is used.

Remote command:

[\[SENSe:\] SWEEp:TYPE](#) on page 1205

### FFT Subspans

Indicates the number of FFT subspans required to cover the entire measurement range (read-only).

See also ["Number of subspans"](#) on page 496.

Only available in FFT sweep mode in the Spectrum application, and not for SEM, ACLR, or Spurious emissions measurements.

Remote command:

[\[SENSe:\] SWEEp:FFTSubspan?](#) on page 1202

### Single Sweep / Run Single

After triggering, starts the number of sweeps set in "Sweep Count". The measurement stops after the defined number of sweeps has been performed.

While the measurement is running, "Single Sweep" and [RUN SINGLE] are highlighted. The running measurement can be aborted by selecting the highlighted softkey or key again.

**Note:** Sequencer. If the Sequencer is active, "Single Sweep" only controls the sweep mode for the currently selected channel. However, the sweep mode only takes effect the next time the Sequencer activates that channel, and only for a channel-defined sequence. In this case, the Sequencer sweeps a channel in single sweep mode only once.

Furthermore, [RUN SINGLE] controls the Sequencer, not individual sweeps. [RUN SINGLE] starts the Sequencer in single mode.

If the Sequencer is off, only the evaluation for the currently displayed channel is updated.

For details on the Sequencer, see [Chapter 5.4.1, "The sequencer concept"](#), on page 122.

Remote command:

[INITiate<n>\[:IMMediate\]](#) on page 910

[CALCulate<n>:SPECTrogram:CONTinuous](#) on page 1249

### Continuous Sweep / Run Cont

After triggering, starts the sweep and repeats it continuously until stopped. This is the default setting.

While the measurement is running, "Continuous Sweep" and [RUN CONT] are highlighted. The running measurement can be aborted by selecting the highlighted softkey or key again. The results are not deleted until a new measurement is started.

**Note:** Sequencer. If the Sequencer is active, "Continuous Sweep" only controls the sweep mode for the currently selected channel. However, the sweep mode only takes effect the next time the Sequencer activates that channel, and only for a channel-defined sequence. In this case, a channel in continuous sweep mode is swept repeatedly.

Furthermore, [RUN CONT] controls the Sequencer, not individual sweeps. [RUN CONT] starts the Sequencer in continuous mode.

For details on the Sequencer, see [Chapter 5.4.1, "The sequencer concept"](#), on page 122.

Remote command:

`INITiate<n>:CONTinuous` on page 909

### Continue Single Sweep

After triggering, repeats the number of sweeps set in "Sweep Count", without deleting the trace of the last measurement.

While the measurement is running, "Continue Single Sweep" and [RUN SINGLE] are highlighted. The running measurement can be aborted by selecting the highlighted softkey or key again.

Remote command:

`INITiate<n>:CONMeas` on page 909

### Spectrogram Frames

These settings are only available if spectrogram display is active.

For more information see [Chapter 8.5.2.3, "How to display and configure a spectrogram"](#), on page 642.

### Select Frame ← Spectrogram Frames

Selects a specific frame, loads the corresponding trace from the memory, and displays it in the Spectrum window.

Note that activating a marker or changing the position of the active marker automatically selects the frame that belongs to that marker.

This function is only available in single sweep mode or if the sweep is stopped, and only if a spectrogram is selected.

The most recent frame is number 0, all previous frames have a negative number.

For more details, see ["Time frames"](#) on page 630.

Remote command:

`CALCulate<n>:SPECTrogram:FRAME:SElect` on page 1250

### Continue Frame ← Spectrogram Frames

Determines whether the results of the previous sweeps are included in the analysis of the next sweeps for trace modes "Max Hold", "Min Hold", and "Average".

This function is available in single sweep mode only.

- **On**

When the average or peak values are determined for the new sweep, the results of the previous sweeps in the spectrogram are also considered.

- **Off**  
The average or peak values are determined from the results of the newly swept frames only.

Remote command:

`CALCulate<n>:SPECTrogram:CONTInuous` on page 1249

#### **Frame Count** ← **Spectrogram Frames**

Determines how many frames are plotted during a single sweep (as opposed to a continuous sweep). The maximum number of possible frames depends on the history depth (see "[History Depth](#)" on page 639).

For more details, see "[Time frames](#)" on page 630.

Remote command:

`CALCulate<n>:SPECTrogram:FRAMe:COUNT` on page 1249

#### **Clear Spectrogram** ← **Spectrogram Frames**

Resets the spectrogram result display and clears the history buffer.

This function is only available if a spectrogram is selected.

Remote command:

`CALCulate<n>:SPECTrogram:CLear[:IMMEDIATE]` on page 1248

## 7.6 Trigger and gate configuration

Triggering means to capture the interesting part of the signal. Choosing the right trigger type and configuring all trigger settings correctly allows you to detect various incidents in your signals.

Gating allows you to restrict measurement analysis to the important part or parts of the signal, for example bursts.

- [Triggering](#)..... 508
- [Gating](#)..... 520

### 7.6.1 Triggering

#### 7.6.1.1 Trigger basics

In a basic measurement with default settings, the sweep is started immediately. However, sometimes you want the measurement to start only when a specific condition is fulfilled, for example a signal level is exceeded, or in certain time intervals. For these cases, you can define a trigger for the measurement. In FFT sweep mode, the trigger defines when the data acquisition starts for the FFT conversion.

An "Offset" can be defined to delay the measurement after the trigger event, or to include data before the actual trigger event in time domain measurements (pre-trigger offset).

For complex tasks, advanced trigger settings are available:

- Hysteresis to avoid unwanted trigger events caused by noise
- Holdoff to define exactly which trigger event causes the trigger in a jittering signal
- [Trigger source](#)..... 509
- [Trigger offset](#)..... 509
- [Trigger hysteresis](#)..... 509
- [Trigger drop-out time](#)..... 510
- [Trigger holdoff](#)..... 511

### Trigger source

The trigger source defines which source must fulfill the condition that triggers the measurement. Basically, the source can be:

- Time: the measurement is repeated in a regular interval
- Power: an input signal is checked for a defined power level  
The trigger signal can be any of the following:
  - The input signal at one of various stages in the signal analysis process - before or after the input mixer, after the video filter etc.
  - A signal from an external device via one of the TRIGGER INPUT / OUTPUT connectors on the instrument
  - A signal from a power sensor, see "[Using a power sensor as an external power trigger](#)" on page 368.

For details on the available trigger sources, see "[Trigger Source](#)" on page 514.

### Trigger offset

An offset can be defined to delay the measurement after the trigger event, or to include data before the actual trigger event in time domain measurements (pre-trigger offset). Pre-trigger offsets are possible because the FSW captures data continuously in the time domain, even before the trigger occurs.

See "[Trigger Offset](#)" on page 518.

### Trigger hysteresis

Setting a hysteresis for the trigger helps avoid unwanted trigger events caused by noise, for example. The hysteresis is a threshold to the trigger level that the signal must fall below on a rising slope or rise above on a falling slope before another trigger event occurs.

**Example:**

In the following example, the signal does not drop below the hysteresis (threshold) before it reaches the trigger level again. Thus, the second possible trigger event on the rising edge is ignored. On the falling edge, however, two trigger events occur. The signal exceeds the hysteresis before it falls to the trigger level the second time.

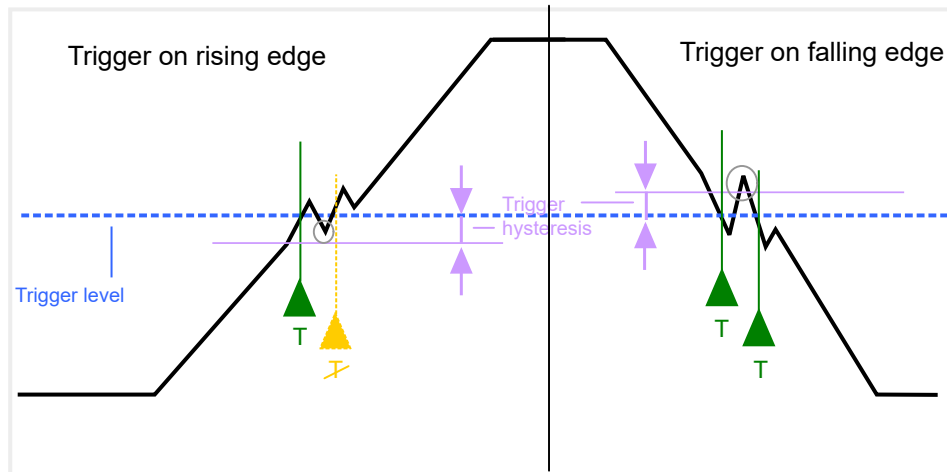

Figure 7-32: Effects of the trigger hysteresis

See ["Hysteresis"](#) on page 518

**Trigger drop-out time**

If a modulated signal is instable and produces occasional "drop-outs" during a burst, you can define a minimum duration that the input signal must stay below the trigger level before triggering again. This is called the "drop-out" time. Defining a dropout time helps you stabilize triggering when the analyzer is triggering on undesired events.

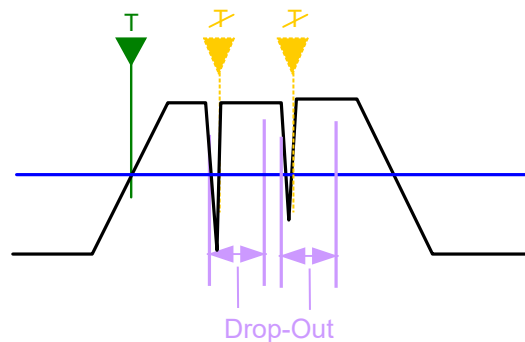

Figure 7-33: Effect of the trigger drop-out time

See ["Drop-Out Time"](#) on page 518.



### Drop-out times for falling edge triggers

If a trigger is set to a falling edge ("Slope" = "Falling", see "Slope" on page 519) the measurement is to start when the power level falls below a certain level. This is useful, for example, to trigger at the end of a burst, similar to triggering on the rising edge for the beginning of a burst.

If a drop-out time is defined, the power level must remain below the trigger level at least for the duration of the drop-out time (as defined above). However, if a drop-out time is defined that is longer than the pulse width, this condition cannot be met before the final pulse. Thus, a trigger event does not occur until the pulsed signal is over.

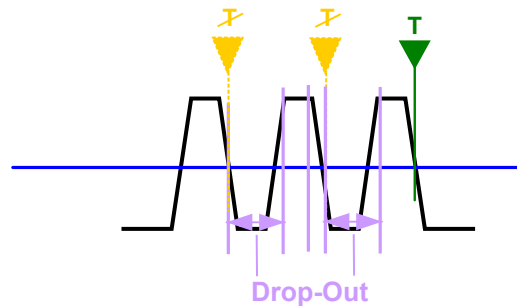

Figure 7-34: Trigger drop-out time for falling edge trigger

For gated measurements, a combination of a falling edge trigger and a drop-out time is generally not allowed.

### Trigger holdoff

The trigger holdoff defines a waiting period before the next trigger after the current one will be recognized.

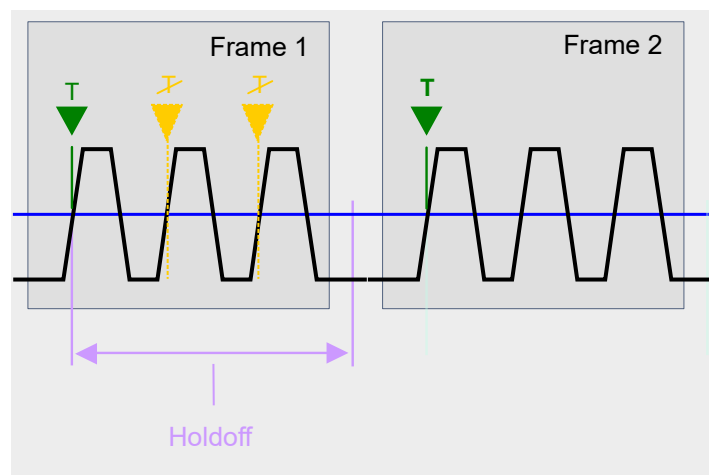
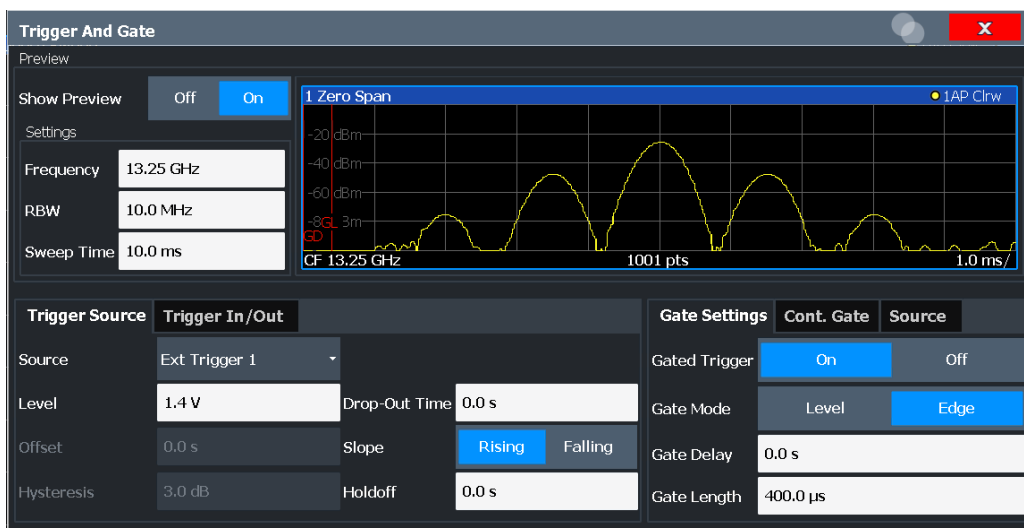

Figure 7-35: Effect of the trigger holdoff

See "Trigger Holdoff" on page 519.

### 7.6.1.2 Trigger settings

Access: "Overview" > "Trigger/Gate"



External triggers from one of the TRIGGER INPUT / OUTPUT connectors on the FSW are configured in a separate tab of the dialog box.

See [Chapter 7.2.9, "Trigger input/output settings"](#), on page 468

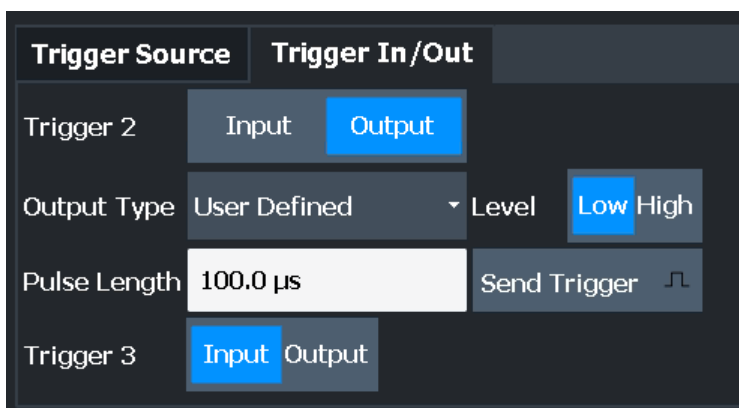

For step-by-step instructions on configuring triggered measurements, see [Chapter 7.6.1.4, "How to configure a triggered measurement"](#), on page 519.

Preview.....	513
L Frequency.....	513
L RBW.....	513
L Sweep Time.....	513
Trigger Source.....	514
L Free Run.....	514
L External Trigger 1/2/3.....	514
L Video.....	515
L IF Power.....	515
L Baseband Power.....	516
L I/Q Power.....	516



L RF Power.....	516
L Power Sensor.....	517
L Time.....	517
Trigger Level.....	517
Repetition Interval.....	518
Drop-Out Time.....	518
Trigger Offset.....	518
Hysteresis.....	518
Trigger Holdoff.....	519
Slope.....	519

### Preview

The preview mode allows you to try out trigger and gate settings before actually applying them to the current measurement.

The preview diagram displays a zero span measurement at the center frequency with the defined RBW and sweep time. This is useful when analyzing bursts, for example, to determine the required gate settings.

The trigger and gate settings are applied to the measurement when the dialog box is closed.

**Note:** The zero span settings refer only to the preview diagram. The main diagram remains unchanged.

If preview mode is switched off, any changes to the settings in this dialog box are applied to the measurement diagram directly. In this case, the zero span settings for the preview diagram are not displayed.

For information on the zero span settings, see:

- "Center Frequency" on page 474
- "RBW" on page 347
- "Sweep Time" on page 502

### Frequency ← Preview

Defines the center frequency for the preview diagram.

Remote command:

[SENSe:] FREQuency: CENTer on page 1192

### RBW ← Preview

Defines the resolution bandwidth for the preview diagram. The available resolution bandwidths are specified in the specifications document. Numeric input is always rounded to the nearest possible bandwidth.

Remote command:

[SENSe:] BANDwidth[:RESolution] on page 1198

### Sweep Time ← Preview

Defines the sweep time for the preview diagram. Allowed values depend on the ratio of span to RBW and RBW to VBW. For details refer to the specifications document. Numeric input is always rounded to the nearest possible sweep time.

Remote command:

[SENSe:] SWEEp: TIME on page 1204

**Trigger Source**

Selects the trigger source. If a trigger source other than "Free Run" is set, "TRG" is displayed in the channel bar and the trigger source is indicated.

For gated measurements, this setting also selects the gating source.

For more information, see ["Trigger source"](#) on page 509.

**Note:** When triggering or gating is activated, the squelch function is automatically disabled.

(See ["Squelch"](#) on page 581).

For an active external frontend, only external triggers, I/Q power triggers and (periodic) time triggers are supported as trigger sources.

See ["External Frontend Connection State"](#) on page 450.

**Note:** If the 1.2 GHz bandwidth extension option (B1200) or the internal 2 GHz option (B2001) is active, only an external trigger, IF power trigger, or no trigger is available. If a B4001/B6001/B8001 bandwidth extension option is active, only an external trigger, power trigger, or no trigger is available for bandwidths  $\geq 80$  MHz. If any trigger other than an external trigger or power trigger is active and the analysis bandwidth is increased above 80 MHz (thus activating the B4001/B6001/B8001 option), the trigger is automatically deactivated.

Remote command:

[TRIGger \[ : SEQuence \] : SOURce](#) on page 1221

[\[ SENSE : \] SWEep : EGATe : SOURce](#) on page 1228

**Free Run ← Trigger Source**

No trigger source is considered. Data acquisition is started manually or automatically and continues until stopped explicitly.

In the Spectrum application, this is the default setting.

Remote command:

[TRIG : SOUR IMM](#), see [TRIGger \[ : SEQuence \] : SOURce](#) on page 1221

**External Trigger 1/2/3 ← Trigger Source**

Data acquisition starts when the TTL signal fed into the specified input connector meets or exceeds the specified trigger level.

(See ["Trigger Level"](#) on page 517).

**Note:** "External Trigger 1" automatically selects the trigger signal from the "TRIGGER 1 INPUT" connector on the front panel.

For details, see the "Instrument Tour" chapter in the FSW Getting Started manual.

"External Trigger 1"

Trigger signal from the "TRIGGER 1 INPUT" connector.

"External Trigger 2"

Trigger signal from the "TRIGGER 2 INPUT / OUTPUT" connector.

Note: Connector must be configured for "Input" in the "Output" configuration

For FSW85 models, "Trigger 2" is not available due to the second RF input connector on the front panel.

**"External Trigger 3"**

Trigger signal from the "TRIGGER 3 INPUT / OUTPUT" connector on the rear panel.

Note: Connector must be configured for "Input" in the "Output" configuration.

(See [Chapter 7.2.9, "Trigger input/output settings"](#), on page 468).

Remote command:

TRIG:SOUR EXT, TRIG:SOUR EXT2

TRIG:SOUR EXT3

See [TRIGger\[:SEQuence\]:SOURce](#) on page 1221

SWE:EGAT:SOUR EXT for gated triggering, see [\[SENSe:\]SWEep:EGATe:SOURce](#) on page 1228

**Video ← Trigger Source**

Defines triggering by the video signal, i.e. the filtered and detected version of the input signal (the envelope of the IF signal), as displayed on the screen.

Define a trigger level from 0 % to 100 % of the diagram height. The absolute trigger level is indicated by a horizontal trigger line in the diagram, which you can also move graphically to change the trigger level.

A fixed hysteresis of  $\pm 5$  % of the specified trigger value (in V) is applied to the video trigger level automatically and cannot be changed.

Video mode is only available in the time domain, and not for I/Q-based data.

Remote command:

TRIG:SOUR VID, see [TRIGger\[:SEQuence\]:SOURce](#) on page 1221

SWE:EGAT:SOUR VID for gated triggering, see [\[SENSe:\]SWEep:EGATe:SOURce](#) on page 1228

**IF Power ← Trigger Source**

The FSW starts capturing data as soon as the trigger level is exceeded around the third intermediate frequency.

For frequency sweeps, the third IF represents the start frequency. The trigger threshold depends on the defined trigger level, as well as on the RF attenuation and preamplification. A reference level offset, if defined, is also considered. The trigger bandwidth at the intermediate frequency depends on the RBW and sweep type. For details on available trigger levels and trigger bandwidths, see the instrument specifications document.

For measurements on a fixed frequency (e.g. zero span or I/Q measurements), the third IF represents the center frequency.

This trigger source is only available for RF input.

Available for input from the optional "Analog Baseband" interface.

Available for input from the optional "Digital Baseband" interface.

The available trigger levels depend on the RF attenuation and preamplification. A reference level offset, if defined, is also considered.

For details on available trigger levels and trigger bandwidths, see the specifications document.

**Note:** Be aware that in auto sweep type mode, due to a possible change in sweep types, the trigger bandwidth can vary considerably for the same RBW setting.

Remote command:

TRIG:SOUR IFP, see [TRIGger\[:SEquence\]:SOURce](#) on page 1221

SWE:EGAT:SOUR IFP for gated triggering, see [\[SENSe:\]SWEep:EGATe:SOURce](#) on page 1228

#### Baseband Power ← Trigger Source

Defines triggering on the baseband power for baseband input.

Available for input from the optional "Analog Baseband" interface.

Available for input from the optional "Digital Baseband" interface.

Remote command:

TRIG:SOUR BBP, see [TRIGger\[:SEquence\]:SOURce](#) on page 1221

#### I/Q Power ← Trigger Source

This trigger source is only available in the I/Q Analyzer application and in applications that process I/Q data.

Not available for the optional "Digital Baseband" interface.

Triggers the measurement when the magnitude of the sampled I/Q data exceeds the trigger threshold.

Remote command:

TRIG:SOUR IQP, see [TRIGger\[:SEquence\]:SOURce](#) on page 1221

#### RF Power ← Trigger Source

Defines triggering of the measurement via signals which are outside the displayed measurement range.

For this purpose, the instrument uses a level detector at the first intermediate frequency.

The resulting trigger level at the RF input depends on the RF attenuation and preamplification. For details on available trigger levels, see the instrument's specifications document.

**Note:** If the input signal contains frequencies outside of this range (e.g. for fullspan measurements), the sweep can be aborted. A message indicating the allowed input frequencies is displayed in the status bar.

A "Trigger Offset", "Trigger Polarity" and "Trigger Holdoff" (to improve the trigger stability) can be defined for the RF trigger, but no "Hysteresis".

Not available for input from the optional "Analog Baseband" interface.

Not available for input from the optional "Digital Baseband" interface.

If the trigger source "RF Power" is selected and you enable baseband input, the trigger source is automatically switched to "Free Run".

Remote command:

TRIG:SOUR RFP, see [TRIGger\[:SEquence\]:SOURce](#) on page 1221

SWE:EGAT:SOUR RFP for gated triggering, see [\[SENSe:\]SWEep:EGATe:SOURce](#) on page 1228

**Power Sensor ← Trigger Source**

Uses an external power sensor as a trigger source. This option is only available if a power sensor is connected and configured.

(See [Chapter 7.2.3.3, "How to work with a power sensor"](#), on page 373.)

If a B4001/B6001/B8001 bandwidth extension option is active, this trigger is not available for bandwidths  $\geq 80$  MHz.

If a power sensor is selected as the trigger mode, the following softkeys are not available; these settings are configured in the "Power Sensor Config" dialog box (see [Chapter 7.2.3.2, "Power sensor settings"](#), on page 368).

- "Trigger Level" on page 517
- "Slope" on page 519
- "Hysteresis" on page 518
- "Trigger Holdoff" on page 519

**Note:** For Rohde & Schwarz power sensors, the "Gate Mode" *Lvl* is not supported. The signal sent by these sensors merely reflects the instant the level is first exceeded, rather than a time period. However, only time periods can be used for gating in level mode. Thus, the trigger impulse from the sensors is not long enough for a fully gated measurement; the measurement cannot be completed.

Remote command:

TRIG:SOUR PSE, see [TRIGger\[:SEquence\]:SOURce](#) on page 1221

SWE:EGAT:SOUR PSE for gated triggering, see [\[SENSe:\]SWEep:EGATe:SOURce](#) on page 1228

**Time ← Trigger Source**

Triggers in a specified repetition interval.

See ["Repetition Interval"](#) on page 518.

If a B4001/B6001/B8001 bandwidth extension option is active, this trigger is not available for bandwidths  $\geq 80$  MHz.

Remote command:

TRIG:SOUR TIME, see [TRIGger\[:SEquence\]:SOURce](#) on page 1221

**Trigger Level**

Defines the trigger level for the specified trigger source.

For gated measurements, this setting also defines the gate level.

For details on supported trigger levels, see the instrument specifications document.

For time triggers, the repetition interval is defined. See ["Repetition Interval"](#) on page 518.

Remote command:

[TRIGger\[:SEquence\]:LEVel:IFPower](#) on page 1220

[TRIGger\[:SEquence\]:LEVel:IQPower](#) on page 1220

[TRIGger\[:SEquence\]:LEVel\[:EXTeRnal<port>\]](#) on page 1219

[TRIGger\[:SEquence\]:LEVel:VIDeo](#) on page 1221

[TRIGger\[:SEquence\]:LEVel:RFPower](#) on page 1221

For baseband input only:

[TRIGger\[:SEquence\]:LEVel:BBPower](#) on page 1219

**Repetition Interval**

Defines the repetition interval for a time trigger.

The shortest interval is 2 ms.

Set the repetition interval to the exact pulse period, burst length, frame length or other repetitive signal characteristic. If the required interval cannot be set with the available granularity, configure a multiple of the interval that can be set. Thus, the trigger remains synchronized to the signal.

Remote command:

[TRIGger\[:SEquence\]:TIME:RINTerval](#) on page 1223

**Drop-Out Time**

Defines the time that the input signal must stay below the trigger level before triggering again.

For more information on the drop-out time, see "[Trigger drop-out time](#)" on page 510.

**Note:** For input from the optional "Analog Baseband" interface using the baseband power trigger (BBP), the default drop out time is set to 100 ns. This avoids unintentional trigger events (as no hysteresis can be configured in this case).

Remote command:

[TRIGger\[:SEquence\]:DTIME](#) on page 1218

**Trigger Offset**

Defines the time offset between the trigger event and the start of the sweep.

For more information, see "[Trigger offset](#)" on page 509.

Offset > 0:	Start of the sweep is delayed
Offset < 0:	Sweep starts earlier (pretrigger) Only possible for zero span (e.g. I/Q Analyzer application) and gated trigger switched off Maximum allowed range limited by the sweep time: $\text{Pretrigger}_{\text{max}} = \text{sweep time}_{\text{max}}$

For the "Time" trigger source in swept measurements, this function is not available.

Remote command:

[TRIGger\[:SEquence\]:HOLDoff\[:TIME\]](#) on page 1218

**Hysteresis**

Defines the distance in dB to the trigger level that the trigger source must exceed before a trigger event occurs. Setting a hysteresis avoids unwanted trigger events caused by noise oscillation around the trigger level.

This setting is only available for "IF Power" trigger sources. The range of the value is between 3 dB and 50 dB with a step width of 1 dB.

For more information, see "[Trigger hysteresis](#)" on page 509.

Remote command:

[TRIGger\[:SEquence\]:IFPower:HYSteresis](#) on page 1219

### Trigger Holdoff

Defines the minimum time (in seconds) that must pass between two trigger events. Trigger events that occur during the holdoff time are ignored.

For more information, see ["Trigger holdoff"](#) on page 511.

Remote command:

`TRIGger[:SEquence]:IFPower:HOLDoFF` on page 1218

### Slope

For all trigger sources except time, you can define whether triggering occurs when the signal rises to the trigger level or falls down to it.

For gated measurements in "Edge" mode, the slope also defines whether the gate starts on a falling or rising edge.

Remote command:

`TRIGger[:SEquence]:SLOPe` on page 1221

`[SENSe:]SWEp:EGATe:POLarity` on page 1228

#### 7.6.1.3 How to determine the required trigger/gate parameters

1. In the "Trigger And Gate" dialog box, switch on "Show Preview".  
A zero span measurement for the currently defined center frequency is displayed.
2. Set the "Frequency", "RBW" and "Sweep Time" such that the relevant part of the signal is displayed, for example a complete burst.
3. Determine the parameters you want to use to define the trigger and gate conditions from the preview diagram, for example:
  - the length of a burst or slot
  - the upper or lower power level of a pulse
  - the maximum noise level
  - the power level or time at which a certain incident occurs
4. Try out different trigger and gate settings as described in [How to configure a triggered measurement](#) and [How to configure a gated measurement](#), then select "Update Main Diagram" to see the effect of the current settings on the main measurement in the background.
5. If the results are as expected, close the dialog box to keep the changes permanently. Otherwise, correct the settings as necessary.

#### 7.6.1.4 How to configure a triggered measurement

##### To define a time trigger:

1. In the "Trigger And Gate" dialog box, define the "Trigger Source" = "Time".
2. Define the "Repetition Interval": the time after which a new measurement is started.

**To define an external trigger:**

1. Connect an external device that will provide the trigger signal to one of the TRIGGER INPUT / OUTPUT connectors on the FSW.  
For details see the FSW "Getting Started" manual.
2. In the "Trigger And Gate" dialog box, define the "Trigger Source" = "External".
3. If you are using the variable TRIGGER 2 INPUT / OUTPUT connector, you must define its use as an input connector. In the "Trigger In/Out" tab of the "Trigger And Gate" dialog box, set the corresponding trigger to "Input".  
(Note: Trigger 2 is on the front panel, Trigger 3 is on the rear panel.)
4. Configure the external trigger as described for the other power triggers.

**To define a power trigger:**

1. In the "Trigger And Gate" dialog box, define the "Trigger Source" = "IF Power". Alternatively, define "Trigger Source" = "Video". The video signal corresponds to the envelope of the IF signal: it has been processed by the resolution and video filters and the selected detector.
2. Define the "Trigger Level": the power level at which the measurement will start. For a "Video" trigger source you can move the level line graphically to define the level. If you define the value numerically, you must enter a percentage of the full diagram height as the level.
3. Define whether the signal must cross the trigger level on a falling or on a rising edge ("Slope") to trigger the measurement.
4. To start the measurement with a time delay, define a "Trigger Offset".
5. To reject triggers due to noise or jittering in the signal, define a "Hysteresis" that is larger than the expected noise or jittering. After the previous trigger, the signal must exceed this threshold before the next level crossing triggers a new measurement.
6. To skip multiple triggers in a burst, define a "Holdoff" time that must pass between two triggers. The holdoff time should be slightly larger than the burst.

**7.6.2 Gating**

- [Gated measurements](#).....521
- [Gate settings](#).....524
- [Continuous gate settings](#).....526
- [Gate source settings](#).....527
- [How to configure a gated measurement](#).....528



### 7.6.2.1 Gated measurements

Like a gate provides an opening in a fence, a gated measurement lets data from the input signal pass in defined areas only. The *gate* controls exactly when data is included in the measurement results and when not. The gate is opened by the trigger source, which is also the gate source.

Gates can be used in two different modes:

- **Level:** The gate opens and the measurement starts when a defined level in the gate source is exceeded and stops when the gate source drops below the "Gate Level".  
Using a pulsed gate signal in level mode, the following behavior can be achieved: When the gate source signal is active, the input signal data is collected; when the gate signal is inactive, the input signal is ignored.
- **Edge:** The gate opens and the measurement starts when a defined level in the gate source is exceeded and stops when the defined "Gate Length" is reached.



#### Restrictions

- The "Gate Mode" *Level* is not supported for Rohde & Schwarz power sensors. The signal sent by these sensors merely reflects the instant the level is first exceeded, rather than a time period. However, only time periods can be used for gating in level mode. Thus, the trigger impulse from the sensors is not long enough for a fully gated measurement; the measurement cannot be completed. For details on power sensors see ["Using a power sensor as an external power trigger"](#) on page 368.

Additionally, a delay time can be defined so that the first few measurement points after the gate opening are ignored.

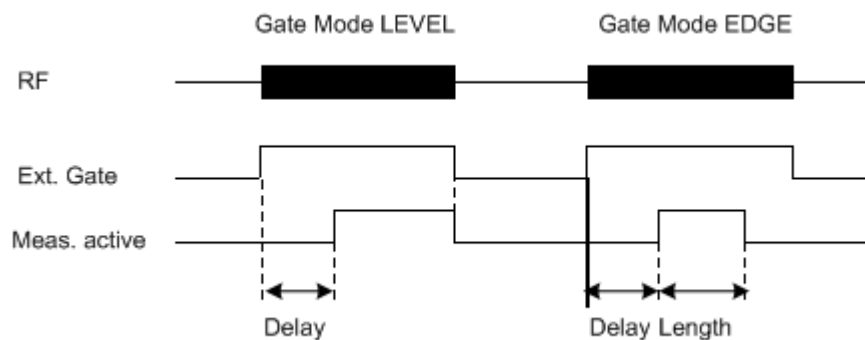

Figure 7-36: Effects of Gate mode, Gate delay and Gate length

**Example:**

By using a gate in sweep mode and stopping the measurement while the gate signal is inactive, the spectrum for pulsed RF carriers can be displayed without the superposition of frequency components generated during switching. Similarly, the spectrum can also be analyzed for an inactive carrier. The sweep can be controlled by an external gate or by the internal power trigger.

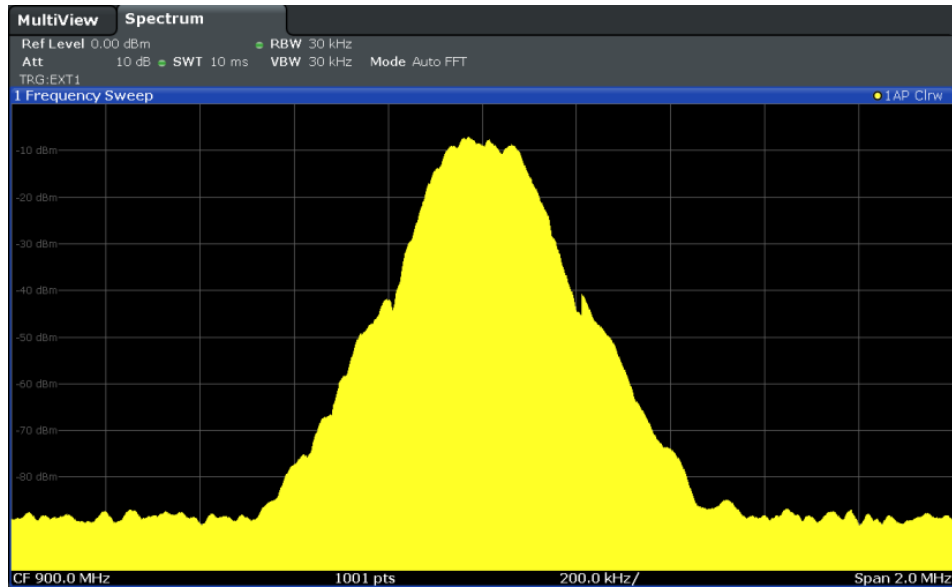

Figure 7-37: GSM signal with GATE OFF

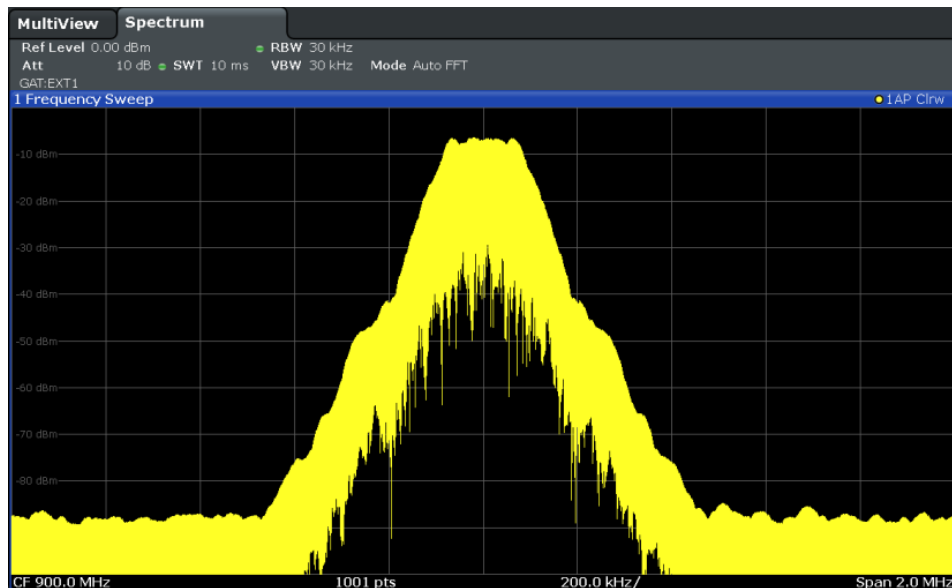

Figure 7-38: GSM signal with GATE ON

Gated sweep operation is also possible for zero span measurements. This allows you to display level variations of individual slots, for instance in burst signals, versus time.

To indicate that a gate is used for the sweep, "GAT" and the gate source is displayed in the channel bar.

**Continuous gating**

With common gating, a measurement is performed each time the trigger event occurs. However, when using an external trigger, the measurement time for a single gate is restricted by the repetition rate of the external trigger.

Now, a new function in the FSW allows you to perform a number of measurements periodically after each external trigger event. This function can speed up the measurement significantly. After the first external trigger event, a specified number of gate periods are generated internally, in a specified interval, without requiring additional trigger events. Only after the specified number of measurements have been performed, the FSW waits for the next external trigger event.

**Example:**

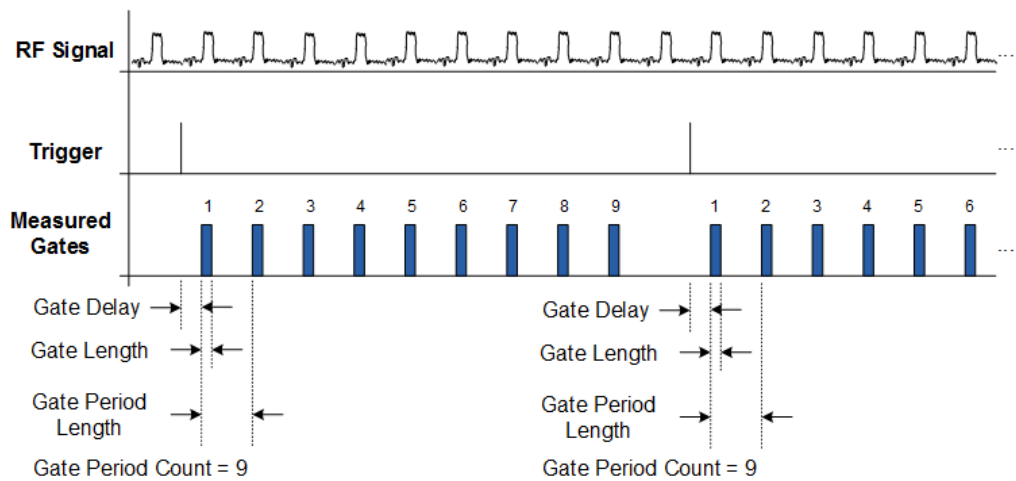

*Figure 7-39: Continuous gating for a gate period count of 9*

Continuous gating is useful, for example, if you want to measure a periodic signal which occurs after a specific trigger event. Using gate periods, you can average the individual periods of the signal for several trigger events.

Continuous gating can also improve the measurement speed, as you no longer have to wait for the next external trigger events, but can measure several periodic bursts after a single trigger event.

Settings for continuous gate periods are defined in a separate tab of the "Trigger / Gate Config" dialog box (see [Chapter 7.6.2.3, "Continuous gate settings"](#), on page 526).



### Restrictions for continuous gating

While continuous gating reduces the number of required external trigger events, not every sweep constellation can be performed using just one external trigger event. Note the following restrictions:

- The number of gates is limited to 1023. If the required measurement time exceeds the duration of 1023 gates, a new external trigger event is necessary for each subsequent 1023 gates.
- In "Sweep Mode Type: Sweep", more than one external trigger events may be necessary due to hardware segmentation of the sweep
- In "Sweep Mode Type: FFT", more than one external trigger event may be necessary, but the covered span with one external trigger event is normally larger than in "Sweep Mode Type: Sweep".

In FFT mode, it is recommended that you activate the "Optimization mode: Speed", as it further reduces the required number of external trigger events.

### Triggered gated measurements

By default, the gate is opened by the trigger source, which is also the gate source. However, you can also use different sources for a general trigger and the beginning of the individual gates. In this case, the trigger source defines when measurement is generally possible, and the gate source determines which data is actually measured.

#### Example:

A rotating antenna can be used as a general (external) trigger source, for example. Only when the antenna reaches a specified position, measurement is possible. A second external trigger can then be used to control the gating periods to measure a bursted signal.

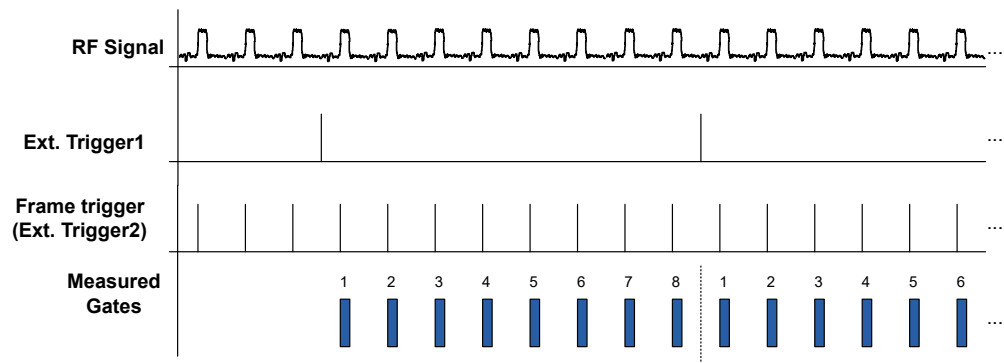

Figure 7-40: Triggered gated measurement

Triggered gated measurements are only available in applications based on frequency sweeps (not I/Q-data based), such as the Spectrum application.

#### 7.6.2.2 Gate settings

**Access:** "Overview" > "Trigger" > "Trigger / Gate Config." > "Gate Settings"

Gate settings define one or more extracts of the signal to be measured.

Gate Settings	Cont. Gate	Source
Gated Trigger	On	Off
Gate Mode	Level	Edge
Gate Delay	0.0 s	
Gate Length	400.0 $\mu$ s	



Gating is not available for measurements on I/Q-based data.

Gated Trigger.....	525
Gate Mode.....	525
Gate Delay.....	526
Gate Length.....	526

### Gated Trigger

Switches gated triggering on or off.

If the gate is switched on, a gate signal applied to one of the TRIGGER INPUT connectors or the internal IF power trigger controls the sweep.

Remote command:

[SENSe:] SWEep:EGATe on page 1224

### Gate Mode

Sets the gate mode.

For more information, see [Chapter 7.6.2.1, "Gated measurements"](#), on page 521

"Edge"            The trigger event for the gate to open is the detection of the signal edge.  
After the gate signal has been detected, the gate remains open until the gate length is over.

"Level"           The trigger event for the gate to open is a particular power level.  
After the gate signal has been detected, the gate remains open until the signal disappears.

**Note:** If you perform gated measurements in combination with the IF Power trigger, the FSW ignores the holding time for frequency sweep, FFT sweep, zero span and I/Q mode measurements.  
This mode is not supported when using R&S Power Sensors as power triggers ("Trg/Gate Source" = *Power Sensor* or *External*).

Remote command:

[SENSe:] SWEep:EGATe:TYPE on page 1229

**Gate Delay**

Defines the delay time between the gate signal and the continuation of the measurement.

The delay position on the time axis in relation to the sweep is indicated by a line labeled "GD".

For more information, see Chapter 7.6.2.1, "Gated measurements", on page 521

Remote command:

[SENSe:] SWEep:EGATe:HOLDoff on page 1226

**Gate Length**

Defines how long the gate is open when it is triggered.

The gate length can only be set in the edge-triggered gate mode. In the level-triggered mode the gate length depends on the level of the gate signal.

The gate length in relation to the sweep is indicated by a line labeled "GL".

For more information, see Chapter 7.6.2.1, "Gated measurements", on page 521

Remote command:

[SENSe:] SWEep:EGATe:LENGth on page 1226

**7.6.2.3 Continuous gate settings**

**Access:** "Overview" > "Trigger" > "Trigger / Gate Config." > "Cont. Gate" tab

Continuous gating allows you to perform a continuous gated sweep after a single external trigger is received.

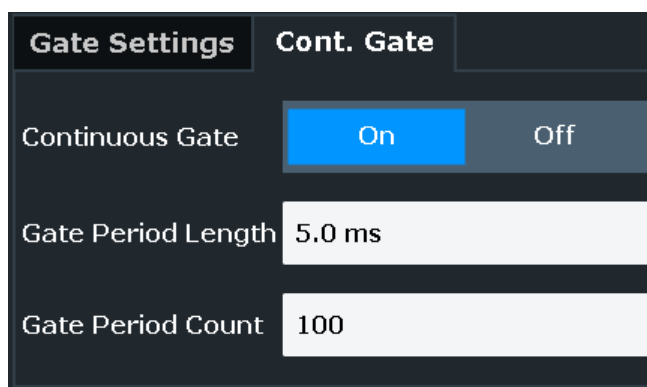

For details see "Continuous gating" on page 523.

Continuous Gate..... 526  
 Gate Period Length..... 527  
 Gate Period Count..... 527

**Continuous Gate**

Activates or deactivates continuous gating.

This setting is only available if [Gated Trigger](#) is "On".

If no external trigger is active yet when continuous gating is activated, external trigger 1 is automatically activated as the trigger source.

Remote command:

`[SENSe:]SWEep:EGATe:CONTinuous[:STATe]` on page 1226

#### Gate Period Length

Defines the length in seconds of a single gate period in continuous gating. The length is determined from the beginning of one gate measurement to the beginning of the next one.

Remote command:

`[SENSe:]SWEep:EGATe:CONTinuous:PLENgtH` on page 1225

#### Gate Period Count

Defines the number of gate periods to be measured after a single trigger event in continuous gating.

Remote command:

`[SENSe:]SWEep:EGATe:CONTinuous:PCOunt` on page 1225

### 7.6.2.4 Gate source settings

**Access:** "Overview" > "Trigger" > "Gate Settings" > "Source" tab

By default, the gate is opened by the trigger source, which is also the gate source. However, you can also use different sources for a general trigger and the beginning of the individual gates. In this case, the trigger source defines when measurement is generally possible, and the gate source determines which data is actually measured.

Triggered gated measurements are only available in applications based on frequency sweeps (not I/Q-data based), such as the Spectrum application.

For more information see "[Triggered gated measurements](#)" on page 524.

Gate Settings	Cont. Gate	Source
Mode	Auto	Manual
Source	Ext Trigger 1	
Level	1.4 V	
Slope	Rising	Falling

<a href="#">Gate Source Mode</a> .....	528
<a href="#">Source</a> .....	528
<a href="#">Level</a> .....	528
<a href="#">Polarity</a> .....	528

**Gate Source Mode**

Determines whether the same or different triggers are used for general measurement and gating.

- "AUTO" (Default:) The trigger defined by [Trigger Source](#) is used both for the general measurement trigger and the gating trigger.
- "MANUAL" The gate is opened by the trigger source defined in [Source](#), but only after a trigger from the general [Trigger Source](#) occurs.

Remote command:

[\[SENSe:\] SWEep:EGATe:AUTO](#) on page 1225

**Source**

Selects the gating trigger source which determines when the gate is opened. For [Gate Source Mode](#) "AUTO", the trigger defined by [Trigger Source](#) is used both for the general measurement trigger and the gating trigger.

The following gate trigger sources are supported:

- [External Trigger 1/2/3](#)
- [Power Sensor](#)

Remote command:

[\[SENSe:\] SWEep:EGATe:SOURce](#) on page 1228

**Level**

Defines the gate level for which the gate is open.

Remote command:

[\[SENSe:\] SWEep:EGATe:LEVel\[:EXTeRnal<tp>\]](#) on page 1227

[\[SENSe:\] SWEep:EGATe:LEVel:RFPower](#) on page 1228

**Polarity**

Defines whether the gate is opened when the signal rises to the trigger level or falls down to it. For gated measurements in "Edge" mode, the slope defines whether the gate starts on a falling or rising edge.

Remote command:

[\[SENSe:\] SWEep:EGATe:POLarity](#) on page 1228

**7.6.2.5 How to configure a gated measurement**

A gated measurement records data only while the gate conditions are fulfilled. These step-by-step instructions demonstrate how to configure a gated measurement manually.

**To configure a common gated measurement**

1. Determine the required parameters as described in [Chapter 7.6.1.4, "How to configure a triggered measurement"](#), on page 519.
2. The gate is opened by a trigger event, which must be based on a power source. Define the trigger as described in [Chapter 7.6.1.4, "How to configure a triggered measurement"](#), on page 519.



As the "Trigger Source", use "IF Power", "Video" or "External".

3. Define how long the gate is to remain open:  
To measure the signal as long as the trigger level is exceeded, for example for one or more pulses, define "Gate Mode" = "Level".  
To measure the signal for a certain time after a level is exceeded, for example during a burst:
  - a) Define "Gate Mode" = "Edge".
  - b) Define the time to measure for each gate: "Gate Length".
4. To open the gate with a time delay, for example to ignore an overshoot, define a "Gate Delay".
5. Select "Gated Trigger" = "On".

#### To configure a continuous gated measurement

A continuous gated measurement is based on a common gated measurement. However, after a single external trigger event, multiple further gate measurements are performed.

1. The gate is opened by a trigger event, which must be provided by an external trigger source. Define the trigger as described in [Chapter 7.6.1.4, "How to configure a triggered measurement"](#), on page 519. As the "Trigger Source", use "External".
2. In the "Gate Settings" of the "Trigger and Gate" dialog box, select "Gated Trigger": "On".
3. Define the gate settings as described in ["To configure a common gated measurement"](#) on page 528.
4. Select the "Cont. Gate" tab next to the "Gate Settings".
5. Set "Continuous Gate" to "On".
6. Define the length in seconds from the beginning of one gate measurement to the beginning of the next one ("Gate Period Length").
7. Define how many gate measurements are to be performed after a single trigger event ("Gate Period Count").
8. Run a measurement and wait for the external trigger event to occur.

#### To configure a triggered gated measurement

A triggered gated measurement is based on a common gated measurement. However, the gates are only opened after an initial trigger event.

1. Determine the required parameters as described in [Chapter 7.6.1.3, "How to determine the required trigger/gate parameters"](#), on page 519.
2. In order to trigger the initial gate, define a trigger event based on a power source. Define the trigger as described in [Chapter 7.6.1.4, "How to configure a triggered measurement"](#), on page 519. As the "Trigger Source", use "External" or "Power Sensor" (if available).

3. Each individual gate is also opened by a trigger event. To use a different trigger source for the individual gates than for general measurement:
  - a) Switch to the "Source" tab for gate settings.
  - b) As the "Source", select "External" or "Power Sensor" (if available).
  - c) Configure the power trigger as defined in [Chapter 7.6.1.4, "How to configure a triggered measurement"](#), on page 519.
4. Switch to the "Gate Settings" tab to define the individual gates.
5. Define how long the gate is to remain open:

To measure the signal as long as the trigger level is exceeded, for example for one or more pulses, define "Gate Mode" = "Level".

To measure the signal for a certain time after a level is exceeded, for example during a burst:

  - a) Define "Gate Mode" = "Edge".
  - b) Define the time to measure for each gate: "Gate Length".
6. To open the gate with a time delay, for example to ignore an overshoot, define a "Gate Delay".
7. Select "Gated Trigger" = "On".

## 7.7 Adjusting settings automatically

**Access:** [AUTO SET]

Some settings can be adjusted by the FSW automatically according to the current measurement settings. To do so, a measurement is performed. You can configure this measurement.

For an active external frontend, automatic settings are not available. See ["External Frontend Connection State"](#) on page 450.



### **MSRA/MSRT operating mode**

In MSRA and MSRT operating mode, settings related to data acquisition can only be adjusted automatically for the MSRA/MSRT primary, not the secondary applications.



### Adjusting settings automatically during triggered measurements

When you select an auto adjust function, a measurement is performed to determine the optimal settings. If you select an auto adjust function for a triggered measurement, you are asked how the FSW should behave:

- (Default:) The measurement for adjustment waits for the next trigger
- The measurement for adjustment is performed without waiting for a trigger. The trigger source is temporarily set to "Free Run". After the measurement is completed, the original trigger source is restored. The trigger level is adjusted as follows for "IF Power" and "RF Power" triggers:  
Trigger level = Reference level - 15 dB

#### Remote command:

[SENSe:]ADJust:CONFigure:TRIGger on page 1235

Adjusting all Determinable Settings Automatically (Auto All).....	531
Adjusting the Center Frequency Automatically (Auto Frequency).....	531
Setting the Reference Level Automatically (Auto Level).....	532
Resetting the Automatic Measurement Time (Meas Time Auto).....	532
Changing the Automatic Measurement Time (Meas Time Manual).....	532
Upper Level Hysteresis.....	532
Lower Level Hysteresis.....	533

### Adjusting all Determinable Settings Automatically (Auto All)

Activates all automatic adjustment functions for the current measurement settings, including:

- [Auto Frequency](#)
- [Auto Level](#)

**Note:** MSRA/MSRT operating modes. In MSRA/MSRT operating mode, this function is only available for the MSRA/MSRT primary, not the secondary applications.

Remote command:

[SENSe:]ADJust:ALL on page 1233

### Adjusting the Center Frequency Automatically (Auto Frequency)

The FSW adjusts the center frequency automatically.

The optimum center frequency is the frequency with the highest S/N ratio in the frequency span. As this function uses the signal counter, it is intended for use with sinusoidal signals.

This function is not available during signal tracking (see [Chapter 7.3.3, "Keeping the center frequency stable - signal tracking"](#), on page 477).

Remote command:

[SENSe:]ADJust:FREquency on page 1235

### Setting the Reference Level Automatically (Auto Level)

Automatically determines a reference level which ensures that no overload occurs at the FSW for the current input data. At the same time, the internal attenuators and the preamplifier (for analog baseband input: the full-scale level) are adjusted. As a result, the signal-to-noise ratio is optimized, while signal compression and clipping are minimized.

To determine the required reference level, a level measurement is performed on the FSW.

If necessary, you can optimize the reference level further. Decrease the attenuation level manually to the lowest possible value before an overload occurs, then decrease the reference level in the same way.

You can change the measurement time for the level measurement if necessary (see "Changing the Automatic Measurement Time (Meas Time Manual)" on page 532).

Remote command:

`[SENSe:]ADJust:LEVel` on page 1236

### Resetting the Automatic Measurement Time (Meas Time Auto)

Resets the measurement duration for automatic settings to the default value.

(Spectrum and AM/FM/PM modulation analysis application: 1 ms)

Remote command:

`[SENSe:]ADJust:CONFigure:LEVel:DURation:MODE` on page 1234

### Changing the Automatic Measurement Time (Meas Time Manual)

This function allows you to change the measurement duration for automatic setting adjustments. Enter the value in seconds.

**Note:** The maximum measurement duration depends on the currently selected measurement and the installed (optional) hardware. Thus, the measurement duration actually used to determine the automatic settings can be shorter than the value you define here.

Remote command:

`[SENSe:]ADJust:CONFigure:LEVel:DURation:MODE` on page 1234

`[SENSe:]ADJust:CONFigure:LEVel:DURation` on page 1233

### Upper Level Hysteresis

When the reference level is adjusted automatically using the [Auto Level](#) function, the internal attenuators and the preamplifier are also adjusted. To avoid frequent adaptation due to small changes in the input signal, you can define a hysteresis. This setting defines an upper threshold that the signal must exceed (compared to the last measurement) before the reference level is adapted automatically.

Remote command:

`[SENSe:]ADJust:CONFigure:HYSTeresis:UPPer` on page 1234

**Lower Level Hysteresis**

When the reference level is adjusted automatically using the [Auto Level](#) function, the internal attenuators and the preamplifier are also adjusted. To avoid frequent adaptation due to small changes in the input signal, you can define a hysteresis. This setting defines a lower threshold that the signal must fall below (compared to the last measurement) before the reference level is adapted automatically.

Remote command:

`[SENSe:]ADJust:CONFigure:HYSTeresis:LOWer` on page 1234

## 8 Common analysis and display functions

**Access:** "Overview" > "Analysis"

General methods and basic settings to display and analyze measurements, regardless of the operating mode, are described here. If you are performing a specific measurement task, using an operating mode other than Signal and Spectrum Analyzer mode, or an application other than the Spectrum application, be sure to check the specific application or mode description for settings and functions that may deviate from these common settings.

- [Result display configuration](#)..... 534
- [Zoomed displays](#)..... 541
- [Marker usage](#)..... 548
- [Display and limit lines](#)..... 590
- [Trace configuration](#)..... 609
- [Importing and exporting measurement results for evaluation](#)..... 648
- [Event-based actions](#)..... 660

### 8.1 Result display configuration

Measurement results can be evaluated in many different ways, for example graphically, as summary tables, statistical evaluations etc. Thus, the result display is highly configurable to suit your specific requirements and optimize analysis. Here you can find out how to optimize the display for your measurement results.

Basic operations concerning the FSW display, for example how to use the SmartGrid, are described in the FSW Getting Started manual.

General display settings that are usually configured during initial instrument setup, independently of the current measurement, e.g. which items or colors are displayed on the screen, are described in [Chapter 11.2, "Display settings"](#), on page 734.

- [Basic evaluation methods](#)..... 534
- [Laying out the result display with the smartgrid](#)..... 537

#### 8.1.1 Basic evaluation methods

Measurement results can be displayed and evaluated using various different methods, also at the same time. Depending on the currently selected measurement, in particular when using optional firmware applications, not all evaluation methods are available.

The evaluation methods described here are available for most measurements in the Spectrum application.

Diagram.....	535
Marker Table.....	535
Marker Peak List.....	536
Result Summary.....	536
Spectrogram.....	536

### Diagram

Displays a basic level vs. frequency or level vs. time diagram of the measured data to evaluate the results graphically. This is the default evaluation method. Which data is displayed in the diagram depends on the "Trace" settings. Scaling for the y-axis can be configured.

See [Chapter 8.5, "Trace configuration"](#), on page 609 and [Chapter 7.4.3, "Scaling the y-axis"](#), on page 489.

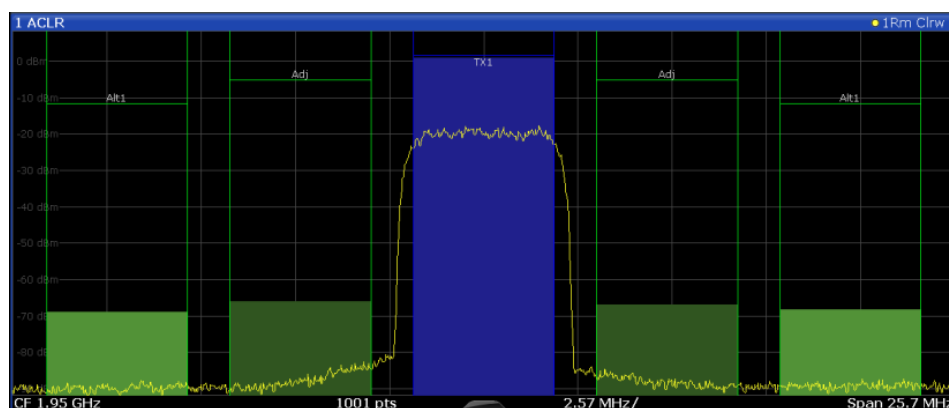

Remote command:

LAY:ADD? '1',RIGH, DIAG, see [LAYout:ADD\[:WINDow\]?](#) on page 1100

Results:

[TRACe<n>\[:DATA\]](#) on page 1258

### Marker Table

Displays a table with the current marker values for the active markers.

This table is displayed automatically if configured accordingly.

(See ["Marker Table Display"](#) on page 555).

2 Marker							
Type	Ref	Trc	Stimulus	Response	Function	Function Result	
N1		1	13.197 GHz	-25.87 dBm	Count	13.197057	
D1	N1	1	-7.942 GHz	-49.41 dB			
D2	N1	2	-3.918 GHz	-21.90 dB			
D3	N1	3	4.024 GHz	-21.99 dB			

**Tip:** To navigate within long marker tables, simply scroll through the entries with your finger on the touchscreen.

Remote command:

LAY:ADD? '1',RIGH, MTAB, see [LAYout:ADD\[:WINDow\]?](#) on page 1100

Results:

[CALCulate<n>:MARKer<m>:X](#) on page 1275

[CALCulate<n>:MARKer<m>:Y?](#) on page 1288

### Marker Peak List

The marker peak list determines the frequencies and levels of peaks in the spectrum or time domain. How many peaks are displayed can be defined, as well as the sort order. In addition, the detected peaks can be indicated in the diagram. The peak list can also be exported to a file for analysis in an external application.

You can define search and sort criteria to influence the results of the analysis.

(See [Chapter 8.3.3.1, "Marker search settings"](#), on page 557).

3 Marker Peak List				
Wnd	No	X-Value	Y-Value	
2	1	1.086245 ms	-75.810 dBm	
2	2	2.172490 ms	-6.797 dBm	
2	3	3.258736 ms	-76.448 dBm	
2	4	4.831918 ms	-76.676 dBm	
2	5	6.255274 ms	-76.482 dBm	
2	6	6.798397 ms	-6.800 dBm	
2	7	9.233084 ms	-76.519 dBm	
2	8	10.075861 ms	-76.172 dBm	
2	9	11.405574 ms	-6.801 dBm	

**Tip:** To navigate within long marker peak lists, simply scroll through the entries with your finger on the touchscreen.

Remote command:

LAY:ADD? '1',RIGH, PEAK, see [LAYout:ADD\[:WINDow\]?](#) on page 1100

Results:

[CALCulate<n>:MARKer<m>:X](#) on page 1275

[CALCulate<n>:MARKer<m>:Y?](#) on page 1288

### Result Summary

Result summaries provide the results of specific measurement functions in a table for numerical evaluation. The contents of the result summary vary depending on the selected measurement function. See the description of the individual measurement functions for details.

2 Result Summary				
Channel	Bandwidth	Offset	Power	
TX1 (Ref)	1.229 MHz		<b>-0.86 dBm</b>	
Tx Total			<b>-0.86 dBm</b>	
Channel	Bandwidth	Offset	Lower	Upper
Adj	30.000 kHz	750.000 kHz	<b>-79.59 dB</b>	<b>-80.34 dB</b>
Alt1	30.000 kHz	1.980 MHz	<b>-85.04 dB</b>	<b>-83.85 dB</b>

**Tip:** To navigate within long marker tables, simply scroll through the entries with your finger on the touchscreen.

Remote command:

LAY:ADD? '1',RIGH, RSUM, see [LAYout:ADD\[:WINDow\]?](#) on page 1100

### Spectrogram

A spectrogram shows how the spectral density of a signal varies over time. The x-axis shows the frequency or sweep time, the y-axis shows the measurement time. A third dimension, the power level, is indicated by different colors. Thus you can see how the strength of the signal varies over time for different frequencies.



The spectrogram display consists of two diagrams: the standard spectrum result display (upper diagram) and the spectrogram result display (lower diagram).

For details see [Chapter 8.5.2.1, "Working with spectrograms"](#), on page 629.

Remote command:

LAY:ADD? '1',RIGH, SGR, see [LAYout:ADD\[:WINDow\]?](#) on page 1100

## 8.1.2 Laying out the result display with the smartgrid

Measurement results can be evaluated in many different ways, for example graphically, as summary tables, statistical evaluations etc. Each type of evaluation is displayed in a separate window in the channel tab. Up to 16 individual windows can be displayed per channel (i.e. per tab). To arrange the diagrams and tables on the screen, the Rohde & Schwarz SmartGrid function helps you find the target position simply and quickly.

Principally, the layout of the windows on the screen is based on an underlying grid, the SmartGrid. However, the SmartGrid is dynamic and flexible, allowing for many different layout possibilities. The SmartGrid functionality provides the following basic features:

- Windows can be arranged in columns or in rows, or in a combination of both.
- Windows can be arranged in up to four rows and four columns.
- Windows are moved simply by dragging them to a new position on the screen, possibly changing the layout of the other windows, as well.
- All evaluation methods available for the currently selected measurement are displayed as icons in the evaluation bar. If the evaluation bar contains more icons than can be displayed at once on the screen, it can be scrolled vertically. The same evaluation method can be displayed in multiple windows simultaneously.
- New windows are added by dragging an evaluation icon from the evaluation bar to the screen. The position of each new window depends on where you drop the evaluation icon in relation to the existing windows.
- All display configuration actions are only possible in SmartGrid mode. When SmartGrid mode is activated, the evaluation bar replaces the current softkey menu display. When the SmartGrid mode is deactivated again, the previous softkey menu display is restored.

• <a href="#">Background information: the smartgrid principle</a> .....	537
• <a href="#">How to activate smartgrid mode</a> .....	539
• <a href="#">How to add a new result window</a> .....	539
• <a href="#">How to close a result window</a> .....	540
• <a href="#">How to arrange the result windows</a> .....	540

### 8.1.2.1 Background information: the smartgrid principle

#### SmartGrid display

During any positioning action, the underlying SmartGrid is displayed. Different colors and frames indicate the possible new positions. The position in the SmartGrid where you drop the window determines its position on the screen.

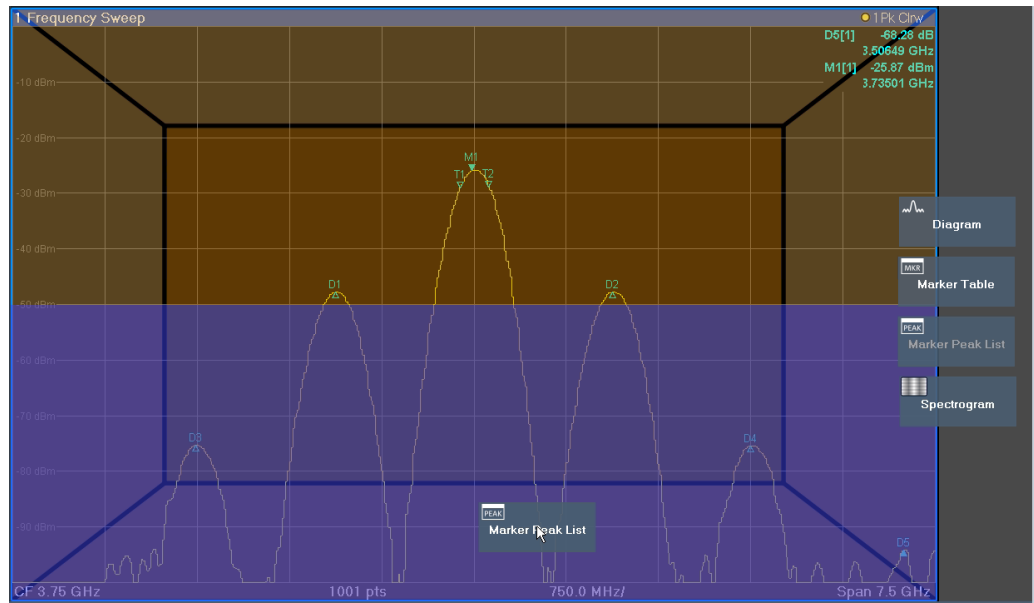

Figure 8-1: Moving a window in SmartGrid mode

The brown area indicates the possible "drop area" for the window, i.e. the area in which the window can be placed. A blue area indicates the (approximate) layout of the window as it would be if the icon were dropped at the current position. The frames indicate the possible destinations of the new window with respect to the existing windows: above/below, right/left or replacement (as illustrated in Figure 4-33). If an existing window would be replaced, the drop area is highlighted in a darker color shade.

**Positioning the window**

The screen can be divided into up to four rows. Each row can be split into up to four columns, where each row can have a different number of columns. However, rows always span the entire width of the screen and may not be interrupted by a column. A single row is available as the drop area for the window in the SmartGrid. The row can be split into columns, or a new row can be inserted above or below the existing row (if the maximum of 4 has not yet been reached).

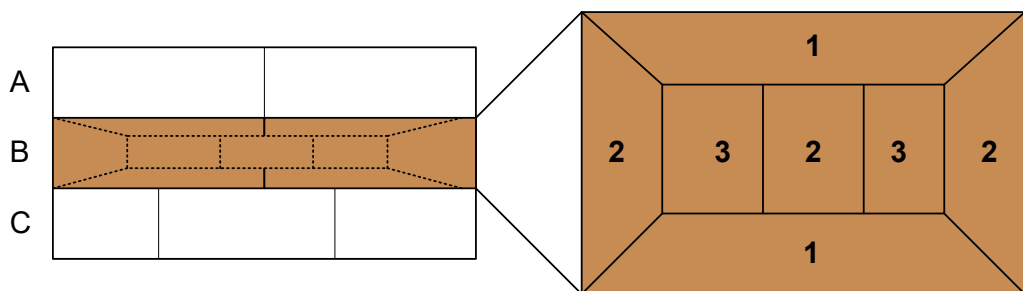

Figure 8-2: SmartGrid window positions

- 1 = Insert row above or below the existing row
- 2 = Create a new column in the existing row
- 3 = Replace a window in the existing row

### SmartGrid functions

Once the evaluation icon has been dropped, icons in each window provide delete and move functions.



The "Move" icon allows you to move the position of the window, possibly changing the size and position of the other displayed windows.



The "Delete" icon allows you to close the window, enlarging the display of the remaining windows.

#### 8.1.2.2 How to activate smartgrid mode

All display configuration actions are only possible in SmartGrid mode. In SmartGrid mode the evaluation bar replaces the current softkey menu display. When the SmartGrid mode is deactivated again, the previous softkey menu display is restored.

► To activate SmartGrid mode, do one of the following:



Select the "SmartGrid" icon from the toolbar.

- Select "Display Config" in the configuration "Overview".
- Select "Display Config" from the [Meas Config] menu.

The SmartGrid functions and the evaluation bar are displayed.



To close the SmartGrid mode and restore the previous softkey menu, select the "Close" icon, or press any key.

#### 8.1.2.3 How to add a new result window

Each type of evaluation is displayed in a separate window. Up to 16 individual windows can be displayed per channel (i.e. per tab).

1. Activate SmartGrid mode.

All evaluation methods available for the currently selected measurement are displayed as icons in the evaluation bar.

2. Select the icon for the required evaluation method from the evaluation bar.

If the evaluation bar contains more icons than can be displayed at once on the screen, it can be scrolled vertically. Touch the evaluation bar between the icons and move it up or down until the required icon appears.

3. Drag the required icon from the evaluation bar to the SmartGrid, which is displayed in the diagram area, and drop it at the required position. (See ["How to arrange the result windows"](#) on page 105 for more information on positioning the window).

**Remote command:**

[LAYout:ADD\[:WINDow\]?](#) on page 1100 / [LAYout:WINDow<n>:ADD?](#) on page 1104

**8.1.2.4 How to close a result window**

- ▶ To close a window, activate SmartGrid mode and select the "Delete" icon for the window.

**Remote command:**

[LAYout:REMove\[:WINDow\]](#) on page 1102 / [LAYout:WINDow<n>:REMove](#) on page 1105

**8.1.2.5 How to arrange the result windows**

1. Select an icon from the evaluation bar or the "Move" icon for an existing evaluation window.



2. Drag the evaluation over the SmartGrid.  
A blue area shows where the window will be placed.
3. Move the window until a suitable area is indicated in blue.
4. Drop the window in the target area.  
The windows are rearranged to the selected layout, and "Delete" and "Move" icons are displayed in each window.
5. To close a window, select the corresponding "Delete" icon.

**Remote command:**

[LAYout:REPLace\[:WINDow\]](#) on page 1102 / [LAYout:WINDow<n>:REPLace](#) on page 1105

[LAYout:MOVE\[:WINDow\]](#) on page 1102

## 8.2 Zoomed displays

You can zoom into the diagram to visualize the measurement results in greater detail. Using the touchscreen or a mouse pointer you can easily define the area to be enlarged.

### Graphical Zoom Versus Measurement Zoom

Graphical zooming is merely a visual tool, it does not change any measurement settings, such as the number of sweep points, the frequency range, or the reference level. Graphical zooming only changes the resolution of the displayed trace points temporarily. You must explicitly activate the graphical zoom function (see [Chapter 8.2.2, "Zoom functions"](#), on page 543).



### Graphical zoom and the number of sweep points

Note that (graphical) zooming is merely a visual tool, it does not change any measurement settings, such as the number of sweep points!

You should increase the number of sweep points before zooming, as otherwise the resolution of the trace in the zoomed region is poor (see [Chapter 7.5.1.8, "How much data is measured: sweep points and sweep count"](#), on page 497).

When you change the display using touch gestures, however, the corresponding measurement settings are adapted. For example, dragging horizontally in a spectrum display changes the center frequency. Dragging vertically in a spectrum display changes the reference level (for absolute scaling). These changes are permanent for the measurement. This behavior is also referred to as *measurement zoom*, and is active by default in the new FSW. However, you can also activate it manually for a display that has already been zoomed graphically. In this case, the temporary changes to the display are replaced by permanent changes to the measurement settings with the same effect.

### Example:

Assume you have a spectrum display from a spurious emission measurement. You graphically zoom into the area around a detected spur. If you now activate a measurement zoom, the reference level, the center frequency, the frequency span, and the scaling settings are adapted so that the results of the measurement now indicate only the formerly zoomed area around the detected spur.

- [Single zoom versus multiple zoom](#).....541
- [Zoom functions](#).....543
- [How to zoom into a diagram](#)..... 545

### 8.2.1 Single zoom versus multiple zoom

Two different (graphical) zoom modes are available: single zoom and multiple zoom. A single zoom replaces the current diagram by a new diagram which displays an enlarged extract of the trace. This function can be used repetitively until the required

details are visible. In multiple zoom mode, you can enlarge up to four different areas of the trace simultaneously. An overview window indicates the zoom areas in the original trace, while the zoomed trace areas are displayed in individual windows. The zoom areas can be moved and resized any time. The zoom area that corresponds to the individual zoom display is indicated in the lower right corner, between the scrollbars.

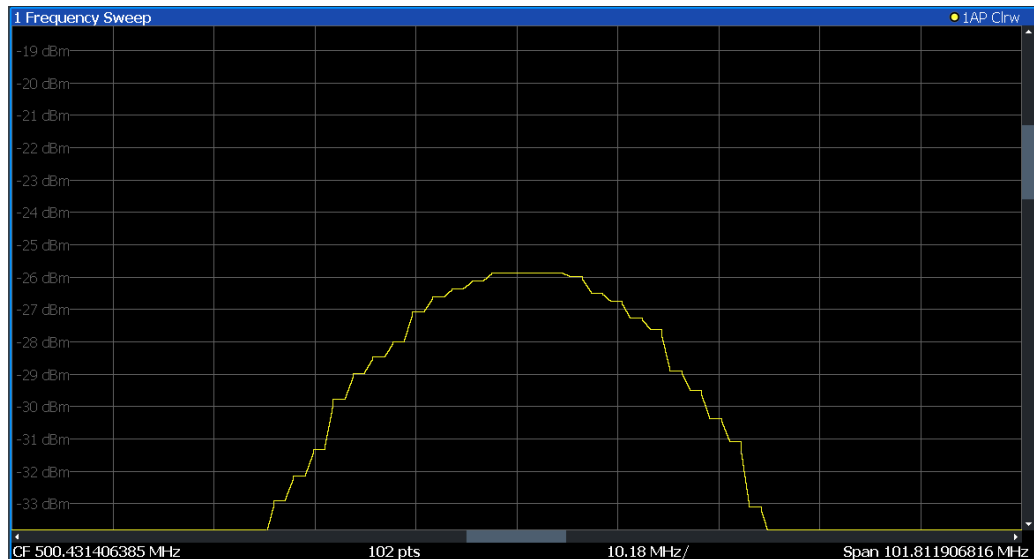

Figure 8-3: Single zoom

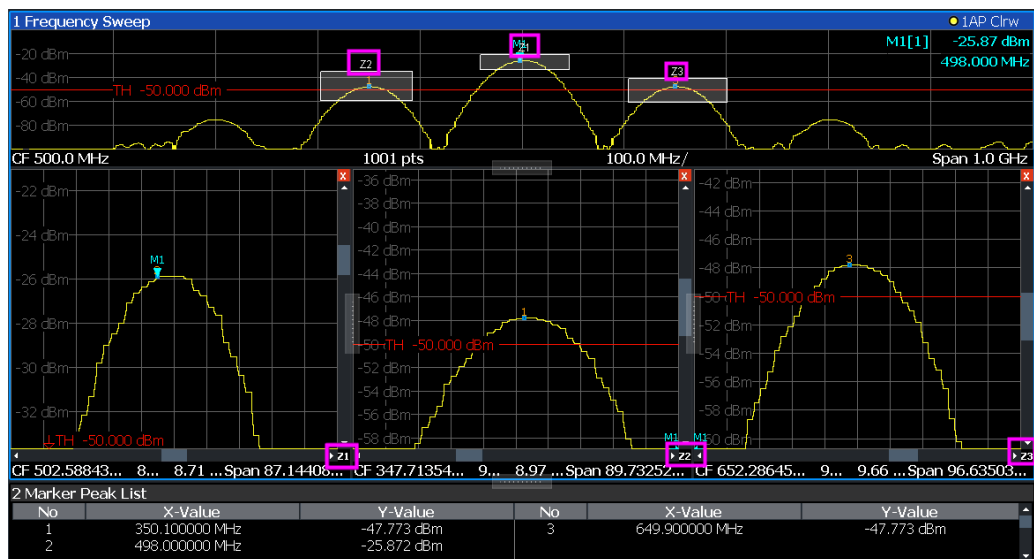

Figure 8-4: Multiple zoom





### Using the zoom area to restrict a peak search

The selected zoom area can be used to restrict the search range for a peak search, but only in single zoom mode (see ["Use Zoom Limits"](#) on page 560).

## 8.2.2 Zoom functions

**Access:** "Zoom" icons in toolbar

Single Zoom.....	543
Multi-Zoom.....	543
Measurement Zoom.....	543
L Level Lock.....	544
L X-Lock.....	544
L Y-Lock.....	544
L Adapt Measurement to Zoom (selected diagram).....	544
Restore Original Display.....	544
 Data shift (Pan).....	545
 Data Zoom.....	545

### Single Zoom



A single zoom replaces the current diagram by a new diagram which displays an enlarged extract of the trace. This function can be used repetitively until the required details are visible.

Remote command:

`DISPlay[:WINDow<n>][:SUBWindow<w>]:ZOOM[:STATe]` on page 1237

`DISPlay[:WINDow<n>][:SUBWindow<w>]:ZOOM:AREA` on page 1236

### Multi-Zoom



In multiple zoom mode, you can enlarge several different areas of the trace simultaneously. An overview window indicates the zoom areas in the original trace, while the zoomed trace areas are displayed in individual windows. The zoom area that corresponds to the individual zoom display is indicated in the lower right corner, between the scrollbars.

Remote command:

`DISPlay[:WINDow<n>][:SUBWindow<w>]:ZOOM:MULTiple<zn>[:STATe]`

on page 1239

`DISPlay[:WINDow<n>][:SUBWindow<w>]:ZOOM:MULTiple<zn>:AREA`

on page 1238

### Measurement Zoom

As opposed to the graphical zoom, which is merely a visual tool, the measurement zoom adapts the measurement settings such that the data you are interested in is displayed in the required detail. In measurement zoom mode, you can change the display using touch gestures. This is the default operating mode of the FSW.

For details on touch gestures see "Operating Basics" in the FSW Getting Started manual.

**Note:** The measurement settings are adapted to practical values based on a suitable grid for the current settings, rather than to unwieldy values that reflect precisely the pixel you happen to tap.

If the measurement zoom leads to undesirable results, you can easily return to the original measurement settings using the "UNDO" function.

When you select the "Measurement Zoom" icon, then tap in a diagram, a dotted rectangle is displayed which you can drag to define the zoom area. This allows you to define the zoom area more precisely than by spreading two fingers in the display.

The measurement zoom function provides further options in a context-sensitive menu, which is displayed when you tap the icon for about a second (or right-click it). These options concern the behavior of the firmware for subsequent touch gestures on the screen. Note that these settings remain unchanged after a channel preset.

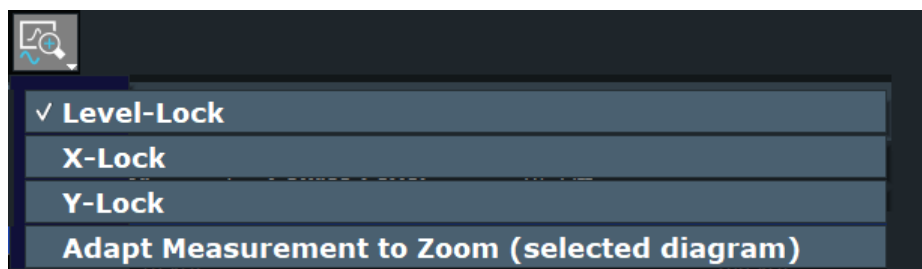

#### **Level Lock ← Measurement Zoom**

If activated (default), the reference level (and thus the attenuation) is locked, that is: remains unchanged during touch gestures on the screen.

#### **X-Lock ← Measurement Zoom**

If activated, the x-axis of the diagram is not changed during subsequent touch gestures.

#### **Y-Lock ← Measurement Zoom**

If activated, the y-axis of the diagram is not changed during subsequent touch gestures.

#### **Adapt Measurement to Zoom (selected diagram) ← Measurement Zoom**

If you already performed a graphical zoom using the "Single Zoom" on page 543 or "Multi-Zoom" on page 543 functions, this function automatically adapts the measurement settings to maintain the currently zoomed display.

#### **Restore Original Display**



Restores the original display, that is, the originally calculated displays for the entire capture buffer, and closes all zoom windows.

**Note:** This function only restores graphically zoomed displays. Measurement zooms, for which measurement settings were adapted, are recalculated based on the adapted measurement settings. In this case, the zoomed display is maintained.



Remote command:

Single zoom:

`DISPlay[:WINDow<n>][:SUBWindow<w>]:ZOOM[:STATe]` on page 1237

Multiple zoom:

`DISPlay[:WINDow<n>][:SUBWindow<w>]:ZOOM:MULTiple<zn>[:STATe]`  
on page 1239 (for each multiple zoom window)

#### **Data shift (Pan)**

Shifts the data to be evaluated in the result display (analysis region or hop/chirp) and re-evaluates the new data. *ALL* result displays based on the same data (analysis region or hop/chirp) are updated.

Currently, this function is only available in the Transient Analysis application.

**Tip:** Result tables are also re-evaluated for each data shift, which can take some time. Close the result tables during a data shift/zoom to improve the screen update speed.

#### **Data Zoom**

Decreases the amount of data to be evaluated in the result display (analysis region or hop/chirp) and re-evaluates the new data, thus enlarging the display of the remaining data.

*ALL* result displays based on the same data (analysis region or hop/chirp) are updated.

Currently, this function is only available in the Transient Analysis application.

**Tip:** result tables are also re-evaluated for each data zoom, which can take some time. Close the result tables during a data shift/zoom to improve the screen update speed.

### 8.2.3 How to zoom into a diagram

The remote commands required to zoom into a display are described in [Chapter 13.8.1, "Zooming into the display"](#), on page 1236.

The following tasks are described here:

- ["To zoom into the diagram at one position"](#) on page 545
- ["To return to original display"](#) on page 546
- ["To zoom into multiple positions in the diagram"](#) on page 546
- ["To maintain a zoomed display permanently"](#) on page 547



For information on how to zoom into a diagram using touch gestures and change the display permanently, see [Chapter 4.5.5, "Touchscreen gestures"](#), on page 97.

#### To zoom into the diagram at one position

1.



Click on the "Single Zoom" icon in the toolbar.

Zoom mode is activated.

2. Tap and drag your finger in the diagram to select the area to be enlarged. The selected area is indicated by a dotted rectangle.

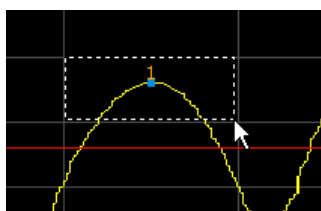

When you leave the touchscreen, the diagram is replaced by the zoomed trace area.

3. Repeat these steps, if necessary, to enlarge the diagram further.



### Scrolling in the zoomed display

You can scroll the diagram area to display the entire diagram using the scrollbars at the right and at the bottom of the diagram.

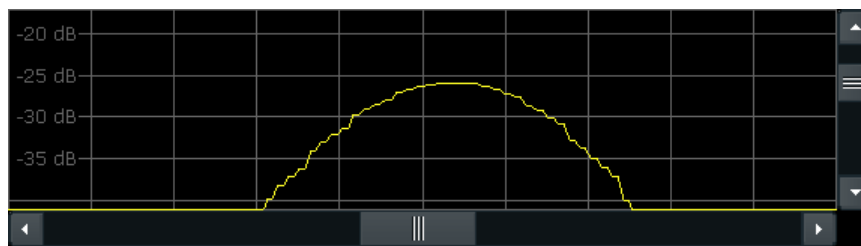

### To return to original display



Click on the "Zoom Off" icon in the toolbar.

The original trace display is restored. Zoom mode remains active, however.

### To zoom into multiple positions in the diagram



1.

Click on the "Multi-Zoom" icon in the toolbar.

Multiple zoom mode is activated.

2. Select the first area in the diagram to be enlarged as described in ["To zoom into the diagram at one position"](#) on page 545. The selected area is indicated by a dotted rectangle.

When you have completed your selection, the original trace is shown in an overview diagram with the selected area indicated by a dotted rectangle. The zoomed trace area is displayed in a separate window (see [Figure 8-4](#)).



Click on the "Multi-Zoom" icon in the toolbar again.

4. In the overview diagram, select the next area to be enlarged.

The second zoom area is indicated in the overview diagram, and a second zoom window is displayed.

5. Repeat these steps, if necessary, to zoom into further trace areas (up to four).

#### To move or change zoom areas

In multiple zoom mode, you can change the size or position of the individual zoom areas easily at any time.

- ▶ To resize a zoom area, tap directly **on** the corresponding frame in the overview window and drag the line to change the size of the frame.  
To move a zoom area, tap **inside** the corresponding frame in the overview window and drag the frame to the new position.

The contents of the zoom windows are adapted accordingly.

#### To maintain a zoomed display permanently

Graphical zooming only changes the resolution of the displayed trace points temporarily. In order to change the display permanently, you must change the corresponding measurement settings.

(Note: Performing a measurement zoom automatically adapts the measurement settings to reflect a graphically zoomed display, see ["To perform a measurement zoom"](#) on page 547).

1. Perform a graphical zoom as described in the previous procedures.



2. Select the "Measurement Zoom" icon from the toolbar.

3. Select "Adapt Measurement to Zoom (selected diagram)".

The measurement settings are adapted as required to obtain the zoomed result display.

#### To perform a measurement zoom

Performing a measurement zoom automatically adapts the measurement settings to reflect a graphically zoomed display.



1. Select the "Measurement Zoom" icon from the toolbar.
2. Do one of the following to define the zoom area:
  - Stretch two fingers in the diagram to enlarge the area between them.

- Tap and drag one finger in the diagram to select the area to be enlarged. The selected area is indicated by a dotted rectangle.

The measurement settings are adapted as required to obtain the zoomed result display.

## 8.3 Marker usage

Markers help you analyze your measurement results by determining particular values in the diagram. Thus you can extract numeric values from a graphical display both in the time and frequency domain. In addition to basic markers, sophisticated marker functions are provided for special results such as noise or demodulation.



### Markers in Spectrogram Displays

In the spectrogram result display, you can activate up to 16 markers or delta markers at the same time. Each marker can be assigned to a different frame. Therefore, in addition to the frequency you also define the frame number when activating a new marker. If no frame number is specified, the marker is positioned on the currently selected frame. All markers are visible that are positioned on a visible frame.

- [Basics on markers](#).....548
- [Marker settings](#).....551
- [Marker search settings and positioning functions](#)..... 557
- [Marker \(measurement\) functions](#)..... 565
- [How to work with markers](#).....586
- [Measurement example: measuring harmonics using marker functions](#).....589

### 8.3.1 Basics on markers

Some background knowledge on marker settings and functions is provided here for a better understanding of the required configuration settings.

Markers are used to mark points on traces, to read out measurement results and to select a display section quickly. FSW provides 17 markers per display window. In the Spectrum application, the same markers are displayed in all windows.

- To set individual markers very quickly, use the softkeys in the "Marker" menu.
- To set up several markers at once, use the "Marker" dialog box.
- To position the selected marker to a special value, use the softkeys in the "Marker To" menu.
- The easiest way to work with markers is using a mouse. Simply drag the marker and drop it at the required position.
- When you select a marker in a diagram, a vertical line is displayed which indicates the marker's current x-value.

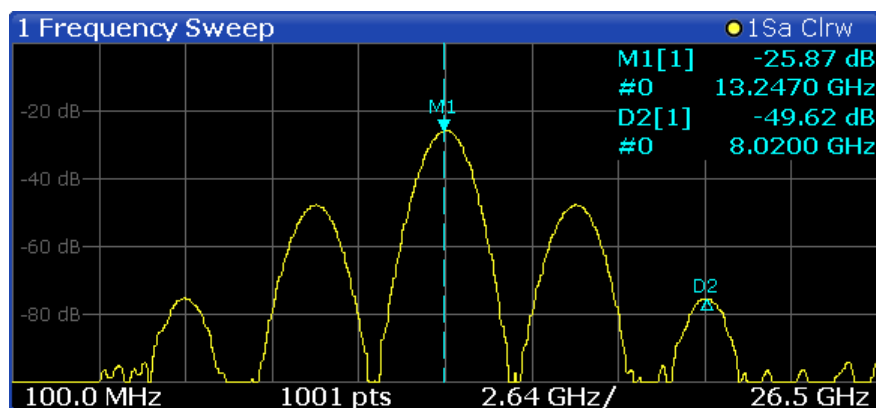

- Alternatively, change the position of the selected marker using the rotary knob. By default, the marker is moved from one pixel to the next. If you need to position the marker more precisely, change the step size to move from one sweep point to the next (General Marker Setting).
  - You can also set an active marker to a new position by defining its x-position numerically. When you select the softkey for a marker, an edit dialog box is displayed.
  - The most commonly required marker settings and functions are also available as softkeys or via the context menu. Tap the marker on the touch screen and hold your finger for about 2 seconds until the context menu is opened, then select the required entry.
  - Softkeys for active markers (displayed on the screen) are highlighted blue. The softkey for the currently selected marker (for which functions are performed) is highlighted orange.
  - To determine more sophisticated marker results, use the special functions in the "Marker Function" dialog box.
- |                                            |     |
|--------------------------------------------|-----|
| • <a href="#">Marker types</a> .....       | 549 |
| • <a href="#">Activating markers</a> ..... | 550 |
| • <a href="#">Marker results</a> .....     | 550 |

### 8.3.1.1 Marker types

All markers can be used either as normal markers or delta markers. A normal marker indicates the absolute signal value at the defined position in the diagram. A delta marker indicates the value of the marker relative to the specified reference marker (by default marker 1).

In addition, special functions can be assigned to the individual markers. The availability of special marker functions depends on whether the measurement is performed in the frequency or time domain, and on the type of measurement.

Temporary markers are used in addition to the markers and delta markers to analyze the measurement results for special marker functions. They disappear when the associated function is deactivated.

### 8.3.1.2 Activating markers

Only active markers are displayed in the diagram and in the marker table.

Active markers are indicated by a highlighted softkey.

By default, marker 1 is active and positioned on the maximum value (peak) of trace 1 as a normal marker. If several traces are displayed, the marker is set to the maximum value of the trace which has the lowest number and is not frozen (View mode). The next marker to be activated is set to the frequency of the next lower level (next peak) as a delta marker; its value is indicated as an offset to marker 1.

A marker can only be activated when at least one trace in the corresponding window is visible. If a trace is switched off, the corresponding markers and marker functions are also deactivated. If the trace is switched on again, the markers along with coupled functions are restored to their original positions, provided the markers have not been used on another trace.

### 8.3.1.3 Marker results

Normal markers point to a trace point on the x-axis and display the associated numeric value for that trace point. Delta markers indicate an offset between the level at the delta marker position and the level at the position of the assigned reference marker, in dB.

Note that markers placed on the start and stop values of the x-axis indicate the y-values of the first and last trace point, respectively. For details see "[X-value of the sweep point](#)" on page 617.

Signal count markers determine the frequency of a signal at the marker position very accurately.

The results can be displayed directly within the diagram area or in a separate table. By default, the first two active markers are displayed in the diagram area. If more markers are activated, the results are displayed in a marker table.

#### Marker information in diagram area

By default, the results of the last two markers or delta markers that were activated are displayed in the diagram area.

D2[1]	-21.90 dB
	-3.9180 GHz
M1[1]	-25.87 dBm
	13.1970 GHz

The following information is displayed there:

- The marker type (M for normal, D for delta, or special function name)
- The marker number
- The assigned trace number in square brackets [ ]
- The marker value on the y-axis, or the result of the marker function
- The marker position on the x-axis

For n dB down markers, additional information is displayed, see [Table 8-1](#).

### Marker information in marker table

In addition to the marker information displayed within the diagram area, a separate marker table may be displayed beneath the diagram. This table provides the following information for all active markers:

<b>Type</b>	Marker type: N (normal), D (delta), T (temporary, internal) and number
<b>Ref</b>	Reference marker for delta markers
<b>Trc</b>	Trace to which the marker is assigned
<b>Frame</b>	Spectrogram frame the marker is positioned in. Displayed only when the Spectrogram is displayed.
<b>X-value</b>	X-value of the marker
<b>Y-value</b>	Y-value of the marker
<b>Function</b>	Activated marker or measurement function
<b>Function Result</b>	Result of the active marker or measurement function

## 8.3.2 Marker settings

Or: [MKR] > "Marker Config"

The remote commands required to define these settings are described in [Chapter 13.8.3.1, "Setting up individual markers"](#), on page 1268.

- [Individual marker setup](#).....551
- [General marker settings](#).....555

### 8.3.2.1 Individual marker setup

Up to 17 markers or delta markers can be activated for each window simultaneously. Initial marker setup is performed using the "Marker" dialog box.

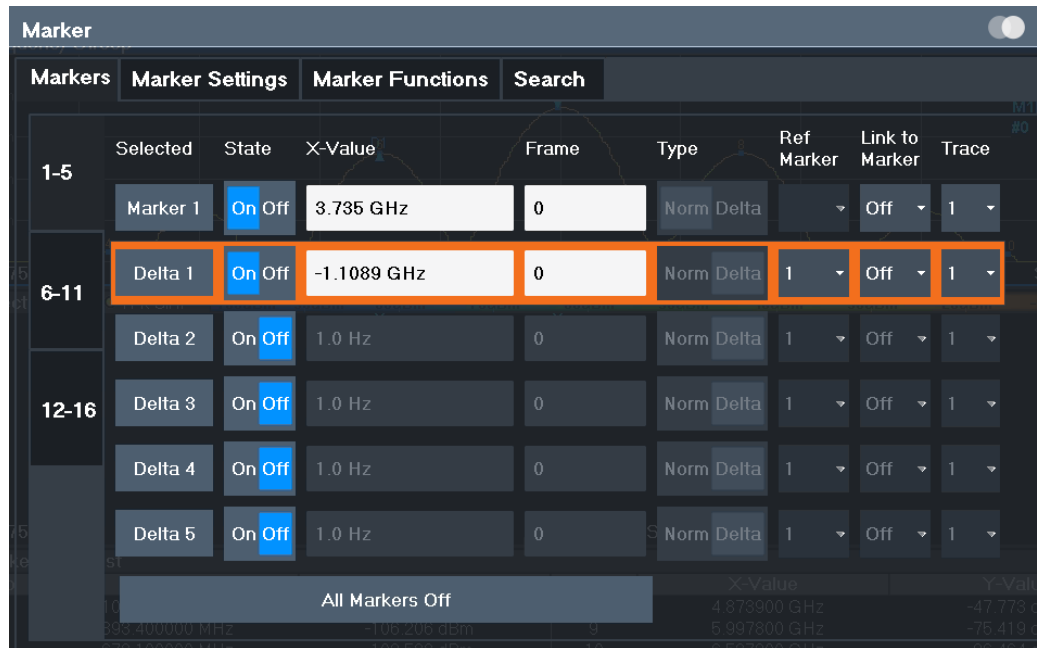

The markers are distributed among 3 tabs for a better overview. By default, the first marker is defined as a normal marker, whereas all others are defined as delta markers with reference to the first marker. All markers are assigned to trace 1, but only the first marker is active.

Selected Marker..... 552  
 Marker State..... 552  
 Marker Position X-value..... 553  
 Frame (Spectrogram only)..... 553  
 Marker Type..... 553  
 Reference Marker..... 553  
 Linking to Another Marker..... 554  
 Assigning the Marker to a Trace..... 554  
 Select Marker..... 554  
 All Markers Off..... 555

**Selected Marker**

Marker name. The marker which is currently selected for editing is highlighted orange.

Remote command:

Marker selected via suffix <m> in remote commands.

**Marker State**

Activates or deactivates the marker in the diagram.

Remote command:

CALCulate<n>:MARKer<m>[:STATe] on page 1274

CALCulate<n>:DELTAmarker<m>[:STATe] on page 1271



**Marker Position X-value**

Defines the position (x-value) of the marker in the diagram. For normal markers, the absolute position is indicated. For delta markers, the position relative to the reference marker is provided.

To create a delta marker in a fixed distance to another marker, define the distance as the x-value for the delta marker. Then link the delta marker to another marker using the [Linking to Another Marker](#) function.

Remote command:

[CALCulate<n>:MARKer<m>:X](#) on page 1275

[CALCulate<n>:DELTAmarker<m>:X](#) on page 1272

**Frame (Spectrogram only)**

Spectrogram frame the marker is assigned to.

Remote command:

[CALCulate<n>:MARKer<m>:SPECTrogram:FRAME](#) on page 1290

[CALCulate<n>:DELTAmarker<m>:SPECTrogram:FRAME](#) on page 1294

**Marker Type**

Toggles the marker type.

The type for marker 1 is always "Normal", the type for delta marker 1 is always "Delta". These types cannot be changed.

**Note:** If normal marker 1 is the active marker, switching the "Mkr Type" activates an additional delta marker 1. For any other marker, switching the marker type does not activate an additional marker, it only switches the type of the selected marker.

"Normal"            A normal marker indicates the absolute value at the defined position in the diagram.

"Delta"            A delta marker defines the value of the marker relative to the specified reference marker (marker 1 by default).

Remote command:

[CALCulate<n>:MARKer<m>\[:STATe\]](#) on page 1274

[CALCulate<n>:DELTAmarker<m>\[:STATe\]](#) on page 1271

**Reference Marker**

Defines a marker as the reference marker which is used to determine relative analysis results (delta marker values).

If the reference marker is deactivated, the delta marker referring to it is also deactivated.

If a fixed reference point is configured (see ["Defining a Fixed Reference"](#) on page 556), the reference point ("FXD") can also be selected instead of another marker.

Remote command:

[CALCulate<n>:DELTAmarker<m>:MREference](#) on page 1271

### Linking to Another Marker

Links the current marker to the marker selected from the list of active markers. If the x-axis value of the initial marker is changed, the linked marker follows to the same position on the x-axis. Linking is off by default.

Using this function you can set two markers on different traces to measure the difference (e.g. between a max hold trace and a min hold trace or between a measurement and a reference trace).

For linked delta markers, the x-value of the delta marker is 0 Hz by default. To create a delta marker in a fixed distance to another marker, define the distance as the x-value for the linked delta marker.

Remote command:

[CALCulate<n>:MARKer<ms>:LINK:TO:MARKer<md>](#) on page 1273

[CALCulate<n>:DELTamarker<ms>:LINK:TO:MARKer<md>](#) on page 1270

[CALCulate<n>:DELTamarker<m>:LINK](#) on page 1269

### Assigning the Marker to a Trace

The "Trace" setting assigns the selected marker to an active trace. The trace determines which value the marker shows at the marker position. If the marker was previously assigned to a different trace, the marker remains on the previous frequency or time, but indicates the value of the new trace.

If a trace is turned off, the assigned markers and marker functions are also deactivated.

Remote command:

[CALCulate<n>:MARKer<m>:TRACe](#) on page 1274

### Select Marker

The "Select Marker" function opens a dialog box to select and activate or deactivate one or more markers quickly.

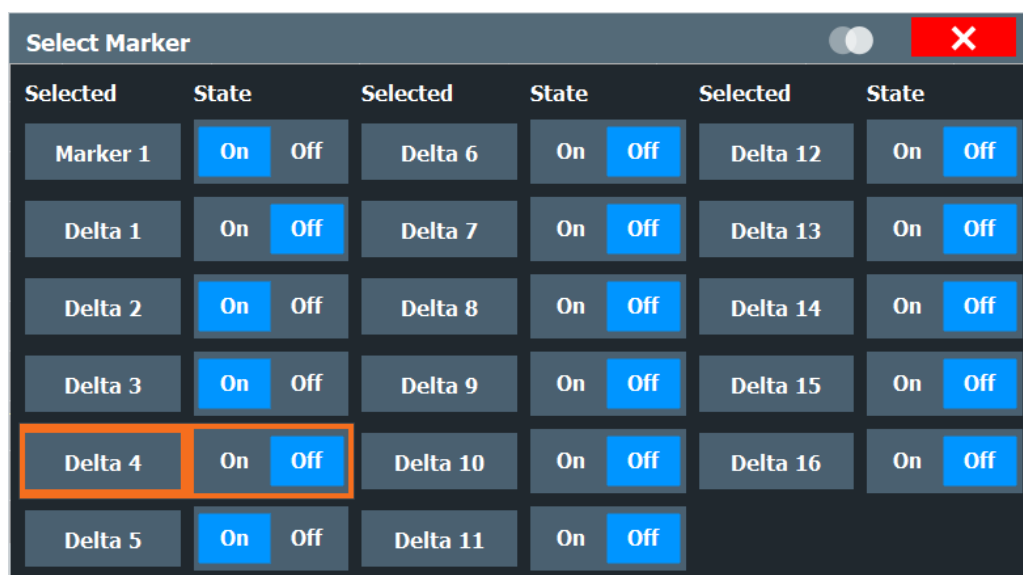

Remote command:

`CALCulate<n>:MARKer<m>[:STATe]` on page 1274

`CALCulate<n>:DELTAmarker<m>[:STATe]` on page 1271

**All Markers Off**

Deactivates all markers in one step.

Remote command:

`CALCulate<n>:MARKer<m>:AOFF` on page 1273

**8.3.2.2 General marker settings**

Some general marker settings allow you to influence the marker behavior for all markers.

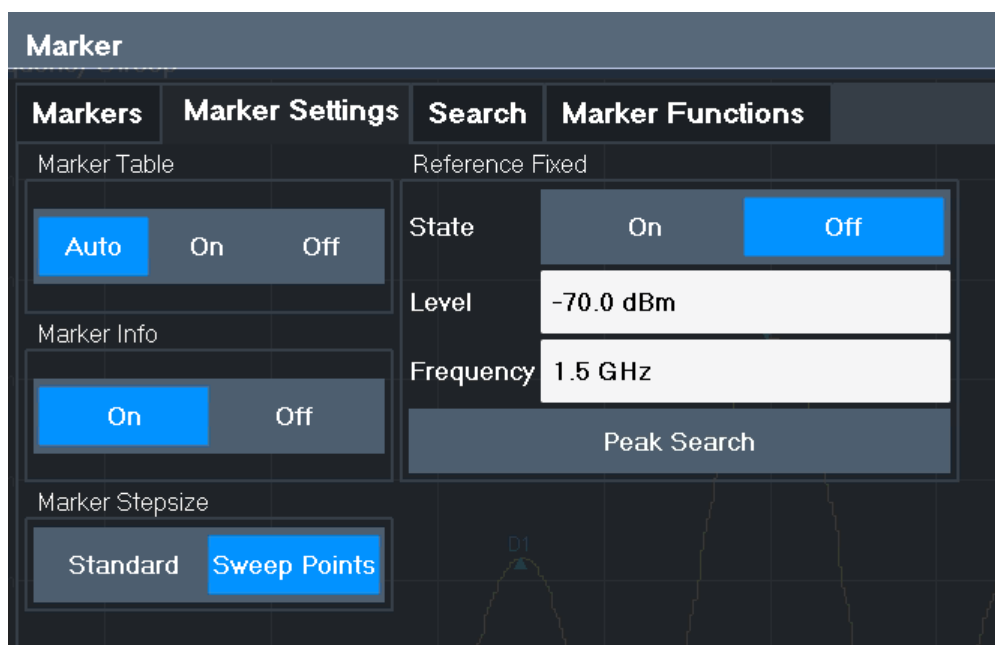

[Marker Table Display](#).....555

[Marker Info](#)..... 556

[Marker Stepsize](#)..... 556

[Defining a Fixed Reference](#).....556

**Marker Table Display**

Defines how the marker information is displayed.

- "On"                 Displays the marker information in a table in a separate area beneath the diagram.
- "Off"                No separate marker table is displayed.  
If [Marker Info](#) is active, the marker information is displayed within the diagram area.

"Auto" (Default) If more than two markers are active, the marker table is displayed automatically.  
If [Marker Info](#) is active, the marker information for up to two markers is displayed in the diagram area.

Remote command:

[DISPlay\[:WINDow<n>\]:MTABLE](#) on page 1276

### Marker Info

Turns the marker information displayed in the diagram on and off.

1AP Clrw	
M1[1]	81.13 dBµV 177.610 MHz
D2[1]	-22.18 dB -28.980 MHz

Remote command:

[DISPlay\[:WINDow<n>\]:MINFo\[:STATe\]](#) on page 1276

### Marker Stepsize

Defines the size of the steps that the marker position is moved using the rotary knob.

"Standard" The marker position is moved in steps of (Span/1000), which corresponds approximately to the number of pixels for the default display of 1001 sweep points. This setting is most suitable to move the marker over a larger distance.

"Sweep Points" The marker position is moved from one sweep point to the next. This setting is required for a very precise positioning if more sweep points are collected than the number of pixels that can be displayed on the screen. It is the default mode.

Remote command:

[CALCulate<n>:MARKer<m>:X:SSIZE](#) on page 1276

### Defining a Fixed Reference

Instead of using a reference marker whose position can vary depending on the measurement results, you can define a fixed reference marker for trace analysis.

Note that this function is not available in all result displays.

For "State" = "On", a vertical and a horizontal red display line are displayed, marked as "FXD". The normal marker 1 is activated and set to the peak value of the trace assigned to marker 1, and a delta marker to the next peak. The fixed reference marker is set to the position of marker 1 at the peak value. The delta marker refers to the fixed reference marker.

The "Level" and "Frequency" or "Time" settings define the position and value of the reference marker. To move the fixed reference, move the red display lines marked "FXD" in the diagram, or change the position settings in the "Marker Settings" tab of the "Marker" dialog box.

**Peak Search** sets the fixed reference marker to the current maximum value of the trace assigned to marker 1.

If activated, the fixed reference marker ("FXD") can also be selected as a [Reference Marker](#) instead of another marker.

Remote command:

`CALCulate<n>:DELTaMarker<m>:FUNctIon:FIXed[:STATe]` on page 1299

`CALCulate<n>:DELTaMarker<m>:FUNctIon:FIXed:RPOint:Y` on page 1299

`CALCulate<n>:DELTaMarker<m>:FUNctIon:FIXed:RPOint:X` on page 1298

`CALCulate<n>:DELTaMarker<m>:FUNctIon:FIXed:RPOint:MAXimum[:PEAK]` on page 1298

### 8.3.3 Marker search settings and positioning functions

**Access:** "Overview" > "Analysis" > "Marker" > "Search"

or: [MKR TO]

Several functions are available to set the marker to a specific position very quickly and easily, or to use the current marker position to define another characteristic value. In order to determine the required marker position, searches may be performed. The search results can be influenced by special settings.

For more information on searching for signal peaks see [Chapter 8.3.4.8, "Marker peak list"](#), on page 582.

The remote commands required to define these settings are described in [Chapter 13.8.3.4, "Positioning the marker"](#), on page 1281.

- [Marker search settings](#).....557
- [Marker search settings for spectrograms](#).....560
- [Positioning functions](#).....563

#### 8.3.3.1 Marker search settings

**Access:** [MKR TO] > "Search Config"

Markers are commonly used to determine peak values, i.e. maximum or minimum values, in the measured signal. Configuration settings allow you to influence the peak search results.



For Spectrograms, special marker settings are available, see [Chapter 8.3.3.2, "Marker search settings for spectrograms"](#), on page 560.

Marker	
Markers	Marker Settings
Next Peak Mode	Left <b>Absolute</b> Right
Exclude LO	<b>On</b> Off
Peak Excursion	6.0 dB
Auto Max Peak	On <b>Off</b>
Auto Min Peak	On <b>Off</b>

Search	
Search Limits	
Left Limit	<input type="checkbox"/> 40.0 GHz
Right Limit	<input type="checkbox"/> 40.0 GHz
Threshold	<input type="checkbox"/> -120.0 dBm
Use Zoom Limits	On <b>Off</b>
Search Limits Off	

Search Mode for Next Peak.....	558
Exclude LO.....	558
Peak Excursion.....	559
Auto Max Peak Search / Auto Min Peak Search.....	559
Search Limits.....	559
└ Search Limits (Left / Right).....	559
└ Search Threshold.....	559
└ Use Zoom Limits.....	560
└ Search Limits Off.....	560

### Search Mode for Next Peak

Selects the search mode for the next peak search.

"Left"	Determines the next maximum/minimum to the left of the current peak.
"Absolute"	Determines the next maximum/minimum to either side of the current peak.
"Right"	Determines the next maximum/minimum to the right of the current peak.

Remote command:

[Chapter 13.8.3.4, "Positioning the marker"](#), on page 1281

### Exclude LO

If activated, restricts the frequency range for the marker search functions.

"On"	The minimum frequency included in the peak search range is $\geq 5 \times$ resolution bandwidth (RBW). Due to the interference by the first local oscillator to the first intermediate frequency at the input mixer, the LO is represented as a signal at 0 Hz. To avoid the peak marker jumping to the LO signal at 0 Hz, this frequency is excluded from the peak search.
"Off"	No restriction to the search range. The frequency 0 Hz is included in the marker search functions.

Remote command:

[CALCulate<n>:MARKer<m>:LOEXclude](#) on page 1277

### Peak Excursion

Defines the minimum level value by which a signal must rise or fall so that it is identified as a maximum or a minimum by the search functions.

Entries from 0 dB to 80 dB are allowed; the resolution is 0.1 dB. The default setting for the peak excursion is 6 dB.

For Analog Modulation Analysis, the unit and value range depend on the selected result display type.

For more information, see [Chapter 8.3.4.8, "Marker peak list"](#), on page 582.

Remote command:

[CALCulate<n>:MARKer<m>:PEXCursion](#) on page 1277

### Auto Max Peak Search / Auto Min Peak Search

If activated, a maximum or minimum peak search is performed automatically for marker 1 after each sweep.

For spectrogram displays, define which frame the peak is to be searched in.

For EMI measurements, these functions are not available; use [Automatic Peak Search](#) instead (see [Chapter 6.13.4.2, "EMI final measurement configuration"](#), on page 345).

Remote command:

[CALCulate<n>:MARKer<m>:MAXimum:AUTO](#) on page 1281

[CALCulate<n>:MARKer<m>:MINimum:AUTO](#) on page 1283

### Search Limits

The search results can be restricted by limiting the search area or adding search conditions.

#### Search Limits (Left / Right) ← Search Limits

If activated, limit lines are defined and displayed for the search. Only results within the limited search range are considered.

For details on limit lines for searches, see ["Peak search limits"](#) on page 582.

Remote command:

[CALCulate<n>:MARKer<m>:X:SLIMits\[:STATe\]](#) on page 1278

[CALCulate<n>:MARKer<m>:X:SLIMits:LEFT](#) on page 1278

[CALCulate<n>:MARKer<m>:X:SLIMits:RIGHT](#) on page 1279

#### Search Threshold ← Search Limits

Defines an absolute threshold as an additional condition for the peak search. If enabled, only peaks that exceed the threshold are detected.

Remote command:

[CALCulate<n>:THReshold:STATe](#) on page 1280

[CALCulate<n>:THReshold](#) on page 1280

**Use Zoom Limits ← Search Limits**

If activated, the peak search is restricted to the active zoom area defined for a single zoom.

Remote command:

CALCulate<n>:MARKer<m>:X:SLIMits:ZOOM[:STATe] on page 1280

**Search Limits Off ← Search Limits**

Deactivates the search range limits.

Remote command:

CALCulate<n>:MARKer<m>:X:SLIMits[:STATe] on page 1278

CALCulate<n>:THReshold:STATe on page 1280

**8.3.3.2 Marker search settings for spectrograms**

**Access:** "Overview" > "Analysis" > "Markers" > "Search"

**or:** [MKR TO] > "Search Config"

Spectrograms show not only the current sweep results, but also the sweep history. Thus, when searching for peaks, you must define the search settings within a single time frame (x-direction) and within several time frames (y-direction).

These settings are only available for spectrogram displays.

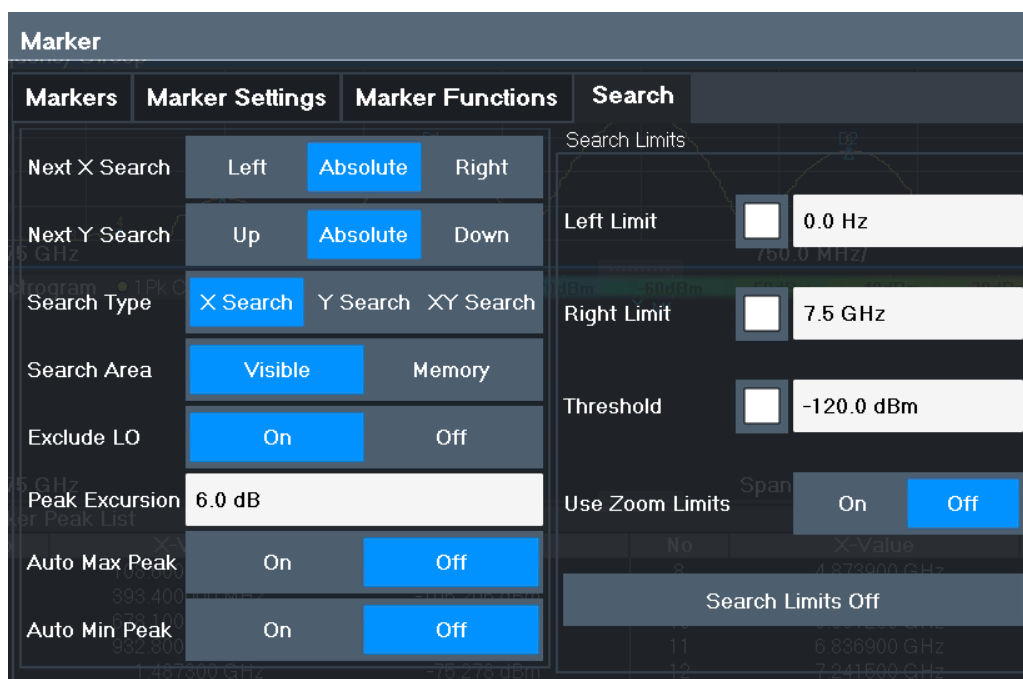

Search Mode for Next Peak in X-Direction..... 561

Search Mode for Next Peak in Y-Direction..... 561

Marker Search Type..... 562

Marker Search Area..... 562

Exclude LO..... 562

Peak Excursion..... 562



Auto Max Peak Search / Auto Min Peak Search.....	562
Search Limits.....	563
L Search Limits (Left / Right).....	563
L Search Threshold.....	563
L Use Zoom Limits.....	563
L Search Limits Off.....	563

### Search Mode for Next Peak in X-Direction

Selects the search mode for the next peak search within the currently selected frame.

"Left"	Determines the next maximum/minimum to the left of the current peak.
"Absolute"	Determines the next maximum/minimum to either side of the current peak.
"Right"	Determines the next maximum/minimum to the right of the current peak.

Remote command:

[Chapter 13.8.3.4, "Positioning the marker"](#), on page 1281

### Search Mode for Next Peak in Y-Direction

Selects the search mode for the next peak search within all frames at the current marker position.

"Up"	Determines the next maximum/minimum above the current peak (in more recent frames).
"Absolute"	Determines the next maximum/minimum above or below the current peak (in all frames).
"Down"	Determines the next maximum/minimum below the current peak (in older frames).

Remote command:

[CALCulate<n>:MARKer<m>:SPECTrogram:Y:MAXimum:ABOVE](#) on page 1291

[CALCulate<n>:DELTamarker<m>:SPECTrogram:Y:MAXimum:ABOVE](#)  
on page 1295

[CALCulate<n>:MARKer<m>:SPECTrogram:Y:MAXimum:BELOW](#) on page 1291

[CALCulate<n>:DELTamarker<m>:SPECTrogram:Y:MAXimum:BELOW](#)  
on page 1296

[CALCulate<n>:MARKer<m>:SPECTrogram:Y:MAXimum:NEXT](#) on page 1292

[CALCulate<n>:DELTamarker<m>:SPECTrogram:Y:MAXimum:NEXT](#)  
on page 1296

[CALCulate<n>:MARKer<m>:SPECTrogram:Y:MINimum:ABOVE](#) on page 1292

[CALCulate<n>:DELTamarker<m>:SPECTrogram:Y:MINimum:ABOVE](#)  
on page 1297

[CALCulate<n>:MARKer<m>:SPECTrogram:Y:MINimum:BELOW](#) on page 1292

[CALCulate<n>:DELTamarker<m>:SPECTrogram:Y:MINimum:BELOW](#)  
on page 1297

[CALCulate<n>:MARKer<m>:SPECTrogram:Y:MINimum:NEXT](#) on page 1293

[CALCulate<n>:DELTamarker<m>:SPECTrogram:Y:MINimum:NEXT](#)  
on page 1297

**Marker Search Type**

Defines the type of search to be performed in the spectrogram.

- "X-Search" Searches only within the currently selected frame.
- "Y-Search" Searches within all frames but only at the current frequency position.
- "XY-Search" Searches in all frames at all positions.

Remote command:

Defined by the search function, see [Chapter 13.8.3.6, "Marker search \(spectrograms\)"](#), on page 1289

**Marker Search Area**

Defines which frames the search is performed in.

- "Visible" Only the visible frames are searched.
- "Memory" All frames stored in the memory are searched.

Remote command:

[CALCulate<n>:MARKer<m>:SPECTrogram:SARea](#) on page 1290

[CALCulate<n>:DELTAmarker<m>:SPECTrogram:SARea](#) on page 1295

**Exclude LO**

If activated, restricts the frequency range for the marker search functions.

- "On" The minimum frequency included in the peak search range is  $\geq 5 \times$  resolution bandwidth (RBW).  
Due to the interference by the first local oscillator to the first intermediate frequency at the input mixer, the LO is represented as a signal at 0 Hz. To avoid the peak marker jumping to the LO signal at 0 Hz, this frequency is excluded from the peak search.
- "Off" No restriction to the search range. The frequency 0 Hz is included in the marker search functions.

Remote command:

[CALCulate<n>:MARKer<m>:LOEXclude](#) on page 1277

**Peak Excursion**

Defines the minimum level value by which a signal must rise or fall so that it is identified as a maximum or a minimum by the search functions.

Entries from 0 dB to 80 dB are allowed; the resolution is 0.1 dB. The default setting for the peak excursion is 6 dB.

For Analog Modulation Analysis, the unit and value range depend on the selected result display type.

For more information, see [Chapter 8.3.4.8, "Marker peak list"](#), on page 582.

Remote command:

[CALCulate<n>:MARKer<m>:PEXCursion](#) on page 1277

**Auto Max Peak Search / Auto Min Peak Search**

If activated, a maximum or minimum peak search is performed automatically for marker 1 after each sweep.

For spectrogram displays, define which frame the peak is to be searched in.

For EMI measurements, these functions are not available; use [Automatic Peak Search](#) instead (see [Chapter 6.13.4.2, "EMI final measurement configuration"](#), on page 345).

Remote command:

[CALCulate<n>:MARKer<m>:MAXimum:AUTO](#) on page 1281

[CALCulate<n>:MARKer<m>:MINimum:AUTO](#) on page 1283

### Search Limits

The search results can be restricted by limiting the search area or adding search conditions.

#### Search Limits (Left / Right) ← Search Limits

If activated, limit lines are defined and displayed for the search. Only results within the limited search range are considered.

For details on limit lines for searches, see ["Peak search limits"](#) on page 582.

Remote command:

[CALCulate<n>:MARKer<m>:X:SLIMits\[:STATe\]](#) on page 1278

[CALCulate<n>:MARKer<m>:X:SLIMits:LEFT](#) on page 1278

[CALCulate<n>:MARKer<m>:X:SLIMits:RIGHT](#) on page 1279

#### Search Threshold ← Search Limits

Defines an absolute threshold as an additional condition for the peak search. If enabled, only peaks that exceed the threshold are detected.

Remote command:

[CALCulate<n>:THReshold:STATe](#) on page 1280

[CALCulate<n>:THReshold](#) on page 1280

#### Use Zoom Limits ← Search Limits

If activated, the peak search is restricted to the active zoom area defined for a single zoom.

Remote command:

[CALCulate<n>:MARKer<m>:X:SLIMits:ZOOM\[:STATe\]](#) on page 1280

#### Search Limits Off ← Search Limits

Deactivates the search range limits.

Remote command:

[CALCulate<n>:MARKer<m>:X:SLIMits\[:STATe\]](#) on page 1278

[CALCulate<n>:THReshold:STATe](#) on page 1280

### 8.3.3.3 Positioning functions

**Access:** [MKR ->]

The following functions set the currently selected marker to the result of a peak search or set other characteristic values to the current marker value.

<a href="#">Peak Search</a> .....	564
<a href="#">Search Next Peak</a> .....	564
<a href="#">Search Minimum</a> .....	564

Search Next Minimum.....	564
Center Frequency = Marker Frequency.....	565
Reference Level = Marker Level.....	565

### Peak Search

Sets the selected marker/delta marker to the maximum of the trace. If no marker is active, marker 1 is activated.

For spectrogram displays, define which frame the peak is to be searched in.

Remote command:

`CALCulate<n>:MARKer<m>:MAXimum[:PEAK]` on page 1282

`CALCulate<n>:DELTamarker<m>:MAXimum[:PEAK]` on page 1285

### Search Next Peak

Sets the selected marker/delta marker to the next (lower) maximum of the assigned trace. If no marker is active, marker 1 is activated.

For spectrogram displays, define which frame the next peak is to be searched in.

Remote command:

`CALCulate<n>:MARKer<m>:MAXimum:NEXT` on page 1282

`CALCulate<n>:MARKer<m>:MAXimum:RIGHT` on page 1283

`CALCulate<n>:MARKer<m>:MAXimum:LEFT` on page 1282

`CALCulate<n>:DELTamarker<m>:MAXimum:NEXT` on page 1285

`CALCulate<n>:DELTamarker<m>:MAXimum:RIGHT` on page 1286

`CALCulate<n>:DELTamarker<m>:MAXimum:LEFT` on page 1285

### Search Minimum

Sets the selected marker/delta marker to the minimum of the trace. If no marker is active, marker 1 is activated.

For spectrogram displays, define which frame the minimum is to be searched in.

Remote command:

`CALCulate<n>:MARKer<m>:MINimum[:PEAK]` on page 1284

`CALCulate<n>:DELTamarker<m>:MINimum[:PEAK]` on page 1286

### Search Next Minimum

Sets the selected marker/delta marker to the next (higher) minimum of the selected trace. If no marker is active, marker 1 is activated.

For spectrogram displays, define which frame the next minimum is to be searched in.

Remote command:

`CALCulate<n>:MARKer<m>:MINimum:NEXT` on page 1284

`CALCulate<n>:MARKer<m>:MINimum:LEFT` on page 1283

`CALCulate<n>:MARKer<m>:MINimum:RIGHT` on page 1284

`CALCulate<n>:DELTamarker<m>:MINimum:NEXT` on page 1286

`CALCulate<n>:DELTamarker<m>:MINimum:LEFT` on page 1286

`CALCulate<n>:DELTamarker<m>:MINimum:RIGHT` on page 1287

**Center Frequency = Marker Frequency**

Sets the center frequency to the selected marker or delta marker frequency. A peak can thus be set as center frequency, for example to analyze it in detail with a smaller span.

This function is not available for zero span measurements.

Remote command:

`CALCulate<n>:MARKer<m>:FUNCTION:CENTer` on page 1190

**Reference Level = Marker Level**

Sets the reference level to the selected marker level.

Remote command:

`CALCulate<n>:MARKer<m>:FUNCTION:REFerence` on page 1207

**8.3.4 Marker (measurement) functions**

**Access:** "Overview" > "Analysis" > "Marker Functions"

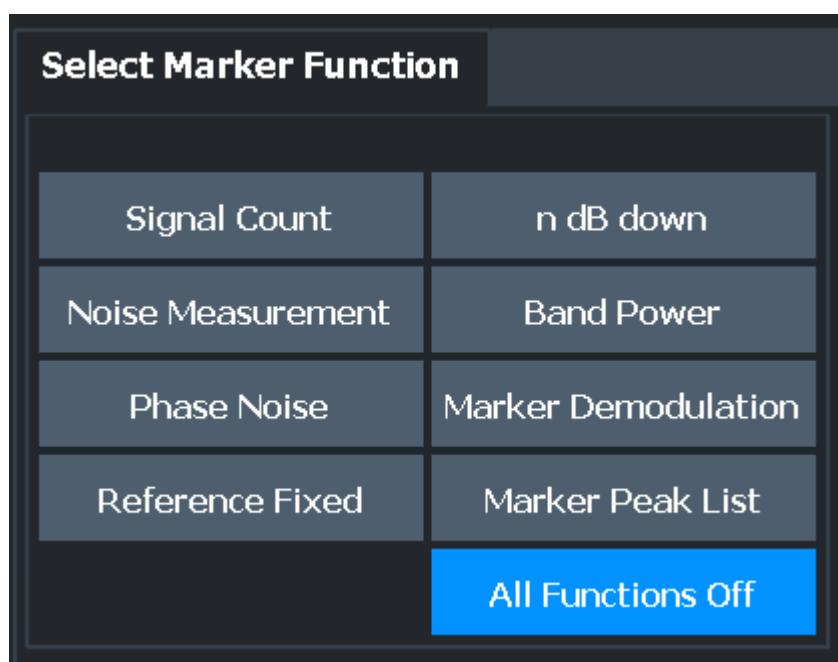

The remote commands required to define these settings are described in [Chapter 13.8.3, "Working with markers"](#), on page 1268.

- [Precise frequency \(signal count\) marker](#).....566
- [Measuring noise density \(noise meas marker\)](#)..... 567
- [Phase noise measurement marker](#)..... 570
- [Measuring characteristic bandwidths \(n db down marker\)](#).....573
- [Fixed reference marker](#).....575
- [Measuring the power in a channel \(band power marker\)](#).....576

- [Demodulating marker values and providing audio output \(marker demodulation\)](#) ..... 579
- [Marker peak list](#).....582
- [Deactivating all marker functions](#)..... 586

### 8.3.4.1 Precise frequency (signal count) marker

**Access:** "Overview" > "Analysis" > "Marker Functions" > "Select Marker Function" > "Signal Count" > "Signal Count Config"

**Or:** [MKR FUNC] > "Select Marker Function" > "Signal Count" > "Signal Count Config"

A normal marker determines the position of the point on the trace and indicates the signal frequency at this position. The trace, however, contains only a limited number of points. Depending on the selected span, each trace point can contain many measurement values. Thus, the frequency resolution of each trace point is limited.

(See also [Chapter 7.5.1.8, "How much data is measured: sweep points and sweep count"](#), on page 497).

Frequency resolution is further restricted by the RBW and sweep time settings.

To determine the frequency of a signal point accurately without changing the sweep settings, the FSW is equipped with a signal counter. The signal counter sets the RF to the current marker position, then counts the zero crossings of the IF (thus the term *signal counter*) and derives the precise frequency value.



To determine the frequency accurately using the signal counter function, the marker must be sufficiently close to the actual signal (for a 3-dB Gauss filter, the delta must be less than  $2 \cdot RBW$ ). Usually, the marker peak function detects a trace point that is close enough. However, for a large span or a small number of sweep points, the result can be inaccurate.

Signal counting can be performed explicitly at the current marker position ("Signal Count" marker function), or implicitly by the FSW for certain functions.

Signal counting is only possible while the instrument is not sweeping. Thus, to perform a signal count for a marker, the sweep is stopped at the marker position. The frequency is determined with the desired resolution and then the sweep is allowed to continue.

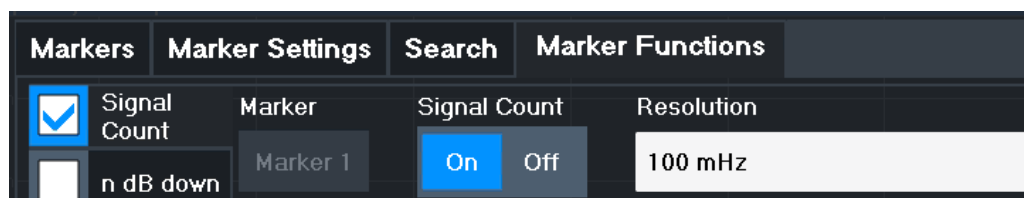

A measurement example is described in [Chapter 6.1.3.2, "Measuring the signal frequency using the signal counter"](#), on page 133.



Signal counters are not available for measurements on I/Q-based data.

#### Remote commands:

"Example: performing a highly accurate frequency measurement using the signal count marker" on page 1327

`CALCulate<n>:MARKer<m>:COUNT` on page 1315

`CALCulate<n>:MARKer<m>:COUNT:RESolution` on page 1316

`Signal Count Marker State`..... 567  
`Resolution`..... 567

#### Signal Count Marker State

Activates or deactivates the special signal count marker function.

When activated, the sweep stops at the reference marker until the signal counter has delivered a result.

Remote command:

`CALCulate<n>:MARKer<m>:COUNT` on page 1315

`CALCulate<n>:MARKer<m>:COUNT:FREQuency?` on page 1315

#### Resolution

Defines the resolution with which the signal is analyzed around the reference marker 1.

Remote command:

`CALCulate<n>:MARKer<m>:COUNT:RESolution` on page 1316

### 8.3.4.2 Measuring noise density (noise meas marker)

**Access:** "Overview" > "Analysis" > "Marker Functions" > "Select Marker Function" > "Noise Measurement" > "Noise Meas Config"

**Or:** [MKR FUNC] > "Select Marker Function" > "Noise Measurement" > "Noise Meas Config"

Using the noise measurement marker function, the noise power density is measured at the position of the marker. In the time domain mode, all points of the trace are used to determine the noise power density. When measurements are performed in the frequency domain, eight points to the right and left of the marker (if available) are used for the measurement to obtain a stable result.

#### Result display

Noise density is the noise referred to a bandwidth of 1 Hz. With logarithmic amplitude units (dBm, dBmV, dBm $\mu$ V, dB $\mu$ A), the noise power density is output in dBm/Hz, i.e. as the level in 1 Hz bandwidth with reference to 1 mW. With linear amplitude units (V, A, W), the noise voltage density is analyzed in  $\mu$ V/ $\sqrt$ Hz; the noise current density in  $\mu$ A/ $\sqrt$ Hz; the noise power density in  $\mu$ W/ $\sqrt$ Hz.

The result is indicated as the **function result in the Marker Table**.

### Prerequisite settings

The following settings are required to obtain correct values:

- Detector: Sample or RMS
- Video bandwidth:
  - ≤ 0.1 resolution bandwidth with sample detector
  - ≥ 3 x resolution bandwidth with RMS detector
- Trace averaging:

In the default setting, the FSW uses the sample detector for the noise function. With the sample detector, you can set the trace to "Average" mode to stabilize the measured values. When the RMS detector is used, trace averaging produces noise levels that are too low and cannot be corrected. Instead, increase the sweep time to obtain stable measurement results.

### Correction factors

The FSW uses the following correction factors to analyze the noise density from the marker level:

- Since the noise power is indicated with reference to 1 Hz bandwidth, the bandwidth correction value is deducted from the marker level. It is  $10 \times \lg(1 \text{ Hz}/\text{BWNoise})$ , where BWNoise is the noise or power bandwidth of the set resolution filter (RBW).
- RMS detector: With the exception of bandwidth correction, no further corrections are required since this detector already indicates the power for each point of the trace.
- Sample detector: As a result of video filter averaging and trace averaging, 1.05 dB is added to the marker level. This is the difference between the average value and the RMS value of white noise. With a logarithmic level axis, 1.45 dB is added additionally. Logarithmic averaging is thus fully taken into account, which yields a value that is 1.45 dB lower than that of linear averaging.
- To allow for a more stable noise display, eight trace points on each side of the measurement frequency are averaged.
- For span > 0, the measured values are averaged versus time (after a sweep).



The FSW noise figure can be calculated from the measured power density level. It is calculated by deducting the set RF attenuation (RF Att) from the displayed noise level and adding 174 to the result.

The individual marker settings correspond to those defined in the "Marker" dialog box (see [Chapter 8.3.2.1, "Individual marker setup"](#), on page 551). Any settings to the marker state or type changed in the "Marker Function" dialog box are also changed in the "Marker" dialog box and vice versa.



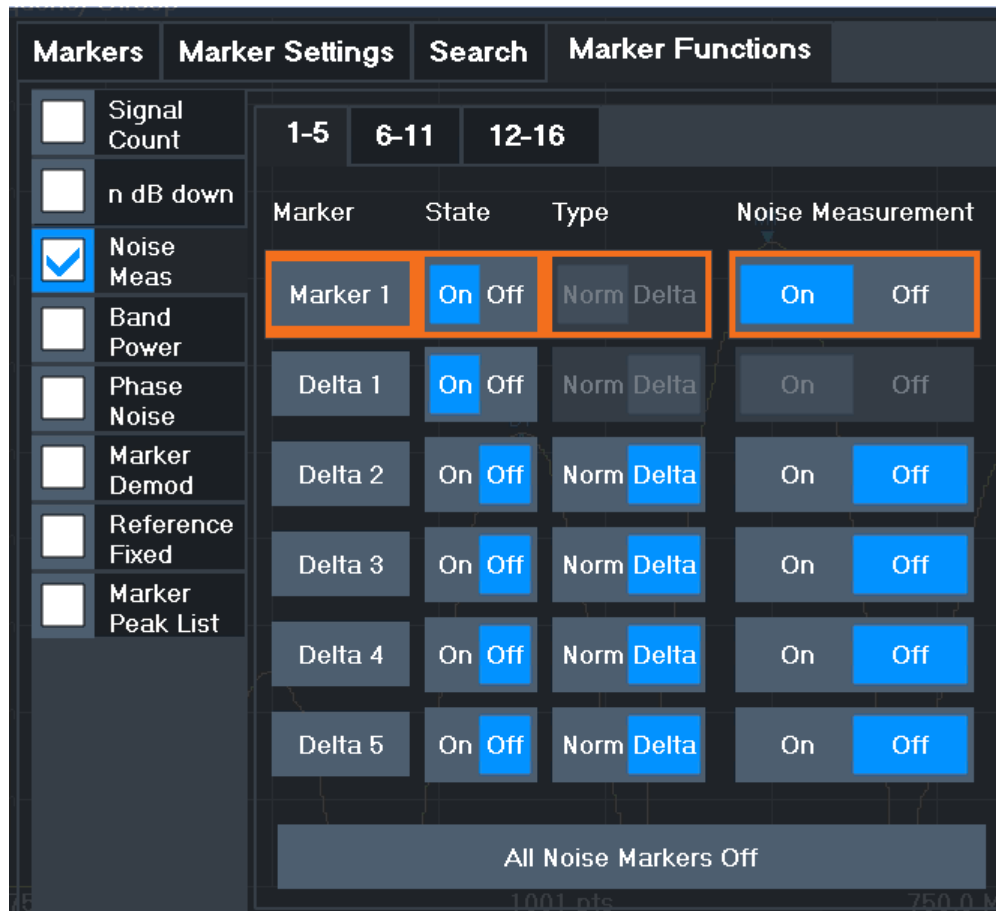

**Remote commands:**

"Example: measuring noise density" on page 1323

[CALCulate<n>:MARKer<m>:FUNCTION:NOISE\[:STATe\]](#) on page 1304

[CALCulate<n>:MARKer<m>:FUNCTION:NOISE:RESult?](#) on page 1304

[Marker State](#).....569

[Marker Type](#)..... 569

[Noise Measurement State](#).....570

[Switching All Noise Measurement Off](#).....570

**Marker State**

Activates or deactivates the marker in the diagram.

Remote command:

[CALCulate<n>:MARKer<m>\[:STATe\]](#) on page 1274

[CALCulate<n>:DELTamarker<m>\[:STATe\]](#) on page 1271

**Marker Type**

Toggles the marker type.

The type for marker 1 is always "Normal", the type for delta marker 1 is always "Delta". These types cannot be changed.

**Note:** If normal marker 1 is the active marker, switching the "Mkr Type" activates an additional delta marker 1. For any other marker, switching the marker type does not activate an additional marker, it only switches the type of the selected marker.

"Normal"	A normal marker indicates the absolute value at the defined position in the diagram.
"Delta"	A delta marker defines the value of the marker relative to the specified reference marker (marker 1 by default).

Remote command:

[CALCulate<n>:MARKer<m>\[:STATe\]](#) on page 1274

[CALCulate<n>:DELTAmarker<m>\[:STATe\]](#) on page 1271

### Noise Measurement State

Activates or deactivates noise measurement for the marker in the diagram.

This function is only available for normal markers.

If activated, the marker displays the noise power density measured at the position of the marker.

For details see [Chapter 8.3.4.2, "Measuring noise density \(noise meas marker\)"](#), on page 567.

Remote command:

[CALCulate<n>:MARKer<m>:FUNCTION:NOISe\[:STATe\]](#) on page 1304

[CALCulate<n>:MARKer<m>:FUNCTION:NOISe:RESult?](#) on page 1304

### Switching All Noise Measurement Off

Deactivates noise measurement for all markers.

Remote command:

[CALCulate<n>:MARKer<m>:FUNCTION:NOISe\[:STATe\]](#) on page 1304

### 8.3.4.3 Phase noise measurement marker

**Access:** "Overview" > "Analysis" > "Marker Functions" > "Phase Noise" > "Phase Noise Config"

**Or:** [MKR FUNC] > "Select Marker Function" > "Phase Noise" > "Phase Noise Config"

For each of the 16 markers, you can activate a phase noise measurement.

Phase noise is unintentional modulation of a carrier; it creates frequencies next to the carrier frequency. A phase noise measurement consists of noise density measurements at defined offsets from the carrier; the results are given in relation to the carrier level (dBc). The phase noise marker function measures the noise power at the delta markers referred to 1 Hz bandwidth. Marker 1 is used as the reference for the phase noise measurement. By default, the current frequency and level of marker 1 are used as the fixed reference marker. However, you can start a peak search to use the current signal peak as the reference point, or you can define a reference point manually.

The reference point for the phase noise measurement is fixed. After phase noise measurement is started, you can set the reference level or the center frequency so that the carrier is outside the displayed frequency range. You can also activate a notch filter to suppress the carrier.

Alternatively, the reference point can be determined automatically by a peak search after each sweep. Use this function to track a drifting source during a phase noise measurement. The delta marker 2, which shows the phase noise measurement result, keeps the delta frequency value. Thus, the phase noise measurement leads to reliable results in a certain offset although the source is drifting. Only if the marker 2 reaches the border of the span, the delta marker value is adjusted to be within the span. In these cases, select a larger span.

The result of the phase noise measurement is the difference in level between the reference point and the noise power density. It is indicated as the function result of the phase noise marker in the "marker table".

The sample detector is automatically used and the video bandwidth set to 0.1 times the resolution bandwidth (RBW). The two settings are considered in the correction values used for the noise power measurement. To obtain stable results, two pixels on the right and the left of the delta marker position are taken for the measurement.

The procedure to determine the noise power is identical to the method used for the noise power measurement (see [Chapter 8.3.4.2, "Measuring noise density \(noise meas marker\)"](#), on page 567).

The individual marker settings correspond to those defined in the "Marker" dialog box. Any settings to the marker state or type changed in the "Marker Function" dialog box are also changed in the "Marker" dialog box and vice versa.

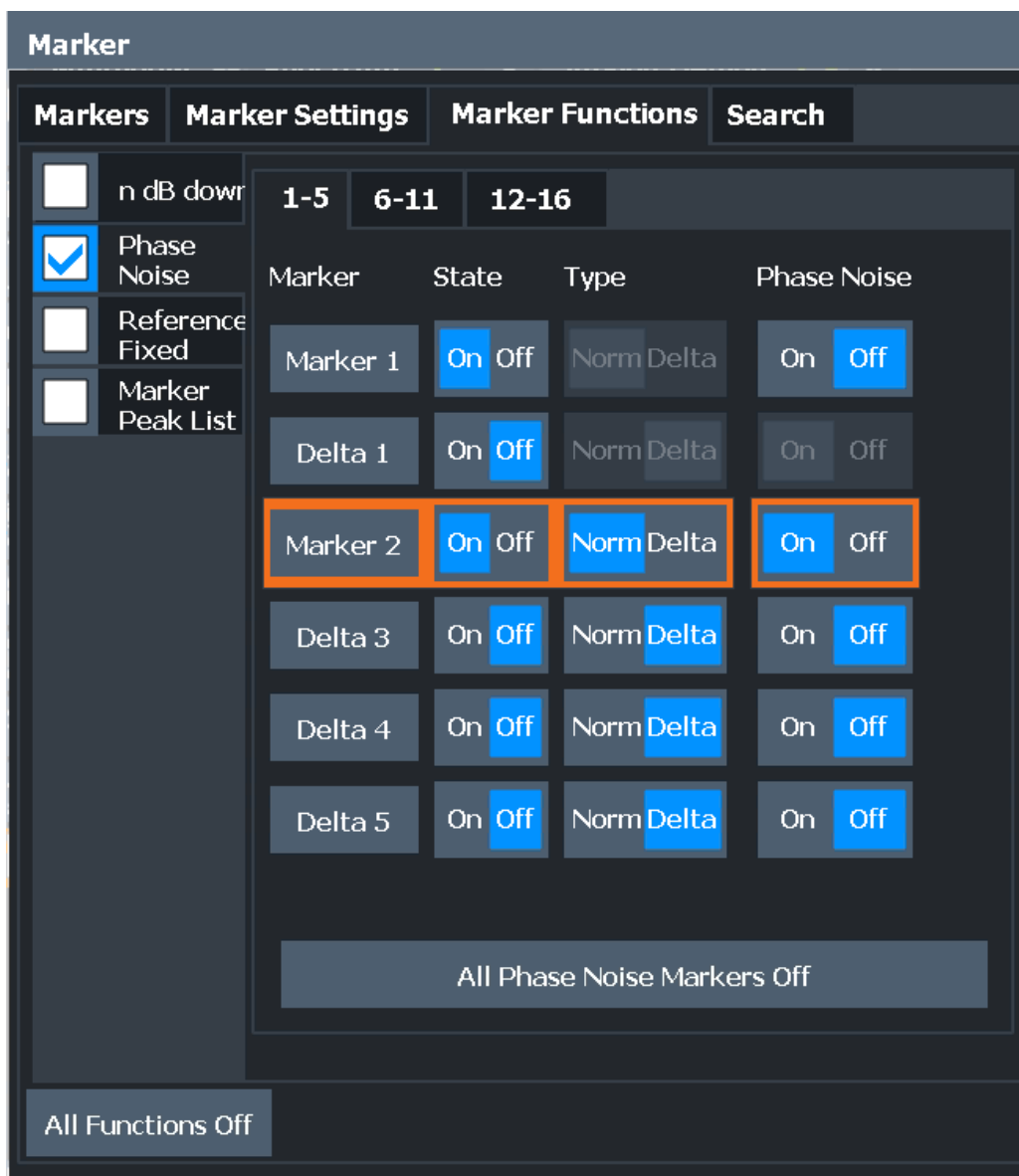

**Remote commands:**

[CALCulate<n>:MARKer<m>:FUNCTION:PNOise\[:STATe\]](#) on page 1307

[CALCulate<n>:MARKer<m>:FUNCTION:PNOise:RESult?](#) on page 1307

[Phase Noise Measurement State](#)..... 572

[Defining Reference Point](#)..... 573

[Switching All Phase Noise Measurements Off](#)..... 573

**Phase Noise Measurement State**

Activates or deactivates phase noise measurement for the reference point in the diagram.

This function is only available for delta markers.

If activated, the delta markers display the phase noise measured at defined offsets from the reference position.

Remote command:

[CALCulate<n>:DELTAmarker<m>:FUNCTION:PNOise\[:STATe\]](#) on page 1306

[CALCulate<n>:DELTAmarker<m>:FUNCTION:PNOise:RESult?](#) on page 1305

### Defining Reference Point

Instead of using marker 1 as the reference marker, a fixed reference marker can be defined for phase noise measurement.

The "Level" and "Frequency" or "Time" settings define the position and value of the reference point.

Alternatively, a **Peak Search** can be performed to set the maximum value of the selected trace as the reference point.

If "Automatic Peak Search" is activated, a peak search is started automatically after each sweep and the result is used as the reference point.

Remote command:

[CALCulate<n>:DELTAmarker<m>:FUNCTION:FIXed:RPoint:Y](#) on page 1299

[CALCulate<n>:DELTAmarker<m>:FUNCTION:FIXed:RPoint:X](#) on page 1298

[CALCulate<n>:DELTAmarker<m>:FUNCTION:FIXed:RPoint:MAXimum\[:PEAK\]](#) on page 1298

[CALCulate<n>:DELTAmarker<m>:FUNCTION:PNOise:AUTO](#) on page 1305

### Switching All Phase Noise Measurements Off

Deactivates phase noise measurement for all markers.

Remote command:

[CALCulate<n>:DELTAmarker<m>:FUNCTION:PNOise\[:STATe\]](#) on page 1306

#### 8.3.4.4 Measuring characteristic bandwidths (n db down marker)

**Access:** "Overview" > "Analysis" > "Marker Functions" > "n dB down" > "n dB Down Config"

**Or:** [MKR FUNC] > "Select Marker Function" > "n dB down" > "n dB Down Config"

When characterizing the shape of a signal, the bandwidth at a specified offset from its peak level is often of interest. The offset is specified as a relative decrease in amplitude of n dB. To measure this bandwidth, you could use several markers and delta markers and determine the bandwidth manually. However, using the n dB down marker function makes the task very simple and quick.

The n dB down marker function uses the current value of marker 1 as the reference point. It activates two temporary markers T1 and T2 located on the signal, whose level is n dB below the level of the reference point. Marker T1 is placed to the left and marker T2 to the right of the reference marker. The default setting for n is 3 dB, but it can be changed.

If a positive offset is entered, the markers T1 and T2 are placed below the active reference point. If a negative value is entered (for example for notch filter measurements), the markers T1 and T2 are placed above the active reference point.

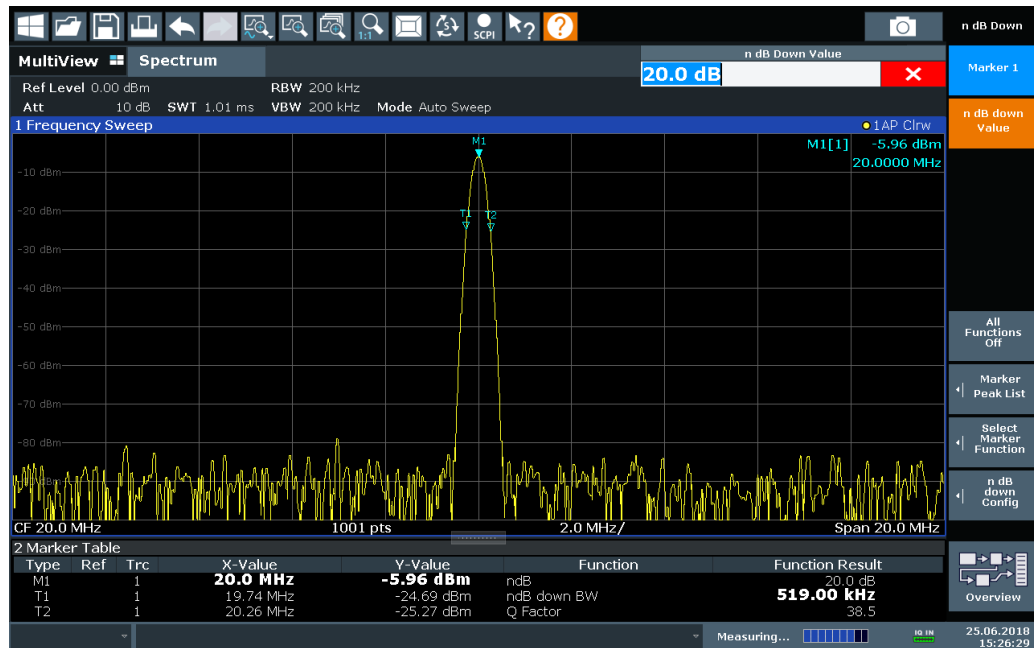

Figure 8-5: n dB down marker function

The following marker function results are displayed:

Table 8-1: n dB down marker function results

Label	Description
M1	Current position and level of marker 1
ndB	Offset value (n dB down)
ndB down Bw / PWid	Determined bandwidth or pulse width (zero span) at the offset
Q-factor	Center frequency / n-dB-down-bandwidth Quality factor of the determined bandwidth (characteristic of damping or resonance)
T1, T2	Current position and level of the temporary markers

If the required position for the temporary markers cannot be determined uniquely, for example due to noise, dashes are displayed as a result.

**Marker**

**Markers** **Marker Settings** **Marker Functions** **Search**

n dB down Marker      n dB down      Value

Phase Noise      Marker 1      **On** Off      3.0 dB

**Remote commands:**

CALCulate<n>:MARKer<m>:FUNCTION:NDBDown:STATe on page 1314

[CALCulate<n>:MARKer<m>:FUNction:NDBDown:RESult?](#) on page 1313

<a href="#">n dB down Marker State</a> .....	575
<a href="#">n dB down Value</a> .....	575

#### **n dB down Marker State**

Activates or deactivates the special n dB down marker function.

Remote command:

[CALCulate<n>:MARKer<m>:FUNction:NDBDown:STATe](#) on page 1314

[CALCulate<n>:MARKer<m>:FUNction:NDBDown:RESult?](#) on page 1313

#### **n dB down Value**

Defines the delta level from the reference marker 1 used to determine the bandwidth or time span.

Remote command:

[CALCulate<n>:MARKer<m>:FUNction:NDBDown:FREQuency?](#) on page 1312

[CALCulate<n>:MARKer<m>:FUNction:NDBDown:TIME?](#) on page 1314

### **8.3.4.5 Fixed reference marker**

**Access:** "Overview" > "Analysis" > "Marker Functions" > "Reference Fixed"

**Or:** [MKR FUNC] > "Select Marker Function" > "Reference Fixed"

Instead of using a reference marker that may vary its position depending on the measurement results, a fixed reference marker can be defined for trace analysis. Once positioned, the reference marker does not move during subsequent sweeps unless you explicitly move it manually.

When you select this marker function, a vertical and a horizontal red display line are displayed, marked as "FXD". A normal marker is activated and set to the peak value and a delta marker to the next peak. The fixed reference marker is set to the position of the normal marker at the peak value. The delta marker refers to the fixed reference marker.

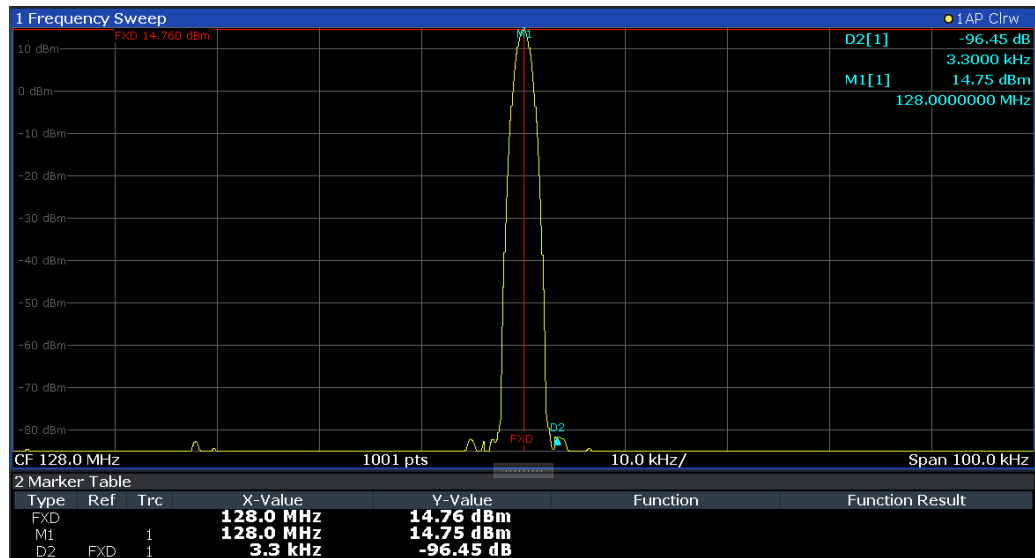

You can move the position of the fixed reference marker graphically by dragging the display lines, or numerically by entering values for the marker position and level.

#### Remote commands:

"Example: using a fixed reference marker" on page 1322

CALCulate<n>:DELTaMarker<m>:FUNCTION:FIXed[:STATe] on page 1299

CALCulate<n>:DELTaMarker<m>:FUNCTION:FIXed:RPoint:X on page 1298

CALCulate<n>:DELTaMarker<m>:FUNCTION:FIXed:RPoint:Y on page 1299

#### 8.3.4.6 Measuring the power in a channel (band power marker)

**Access:** "Overview" > "Analysis" > "Marker Functions" > "Band Power" > "Band Power Config"

**or:** [MKR FUNC] > "Select Marker Function" > "Band Power"

To determine the noise power in a transmission channel, you can use a noise marker and multiply the result with the channel bandwidth. However, the results are only accurate for flat noise.

Band power markers allow you to measure the integrated power for a defined span (band) around a marker (similar to ACP measurements). By default, 5 % of the current span is used. The span is indicated by limit lines in the diagram. You can easily change the span by moving the limit lines in the diagram. They are automatically aligned symmetrically to the marker frequency. They are also moved automatically if you move the marker on the screen.

The results can be displayed either as a power (dBm) or density (dBm/Hz) value and are indicated in the "marker table" for each band power marker.





**Relative band power markers**

The results for band power markers which are defined as *delta* markers and thus have a reference value can also be calculated as reference power values (in dB).

For Analog Modulation Analysis, relative band power markers are not available.

In this case, the result of the band power deltamarker is the difference between the absolute power in the band around the delta marker and the absolute power for the reference marker. The powers are subtracted logarithmically, so the result is a dB value.

$$[Relative\ band\ power\ (Delta2)\ in\ dB] = [absolute\ band\ power\ (Delta2)\ in\ dBm] - [absolute\ (band)\ power\ of\ reference\ marker\ in\ dBm]$$

The measured power for the reference marker may be an absolute power at a single point (if the reference marker is not a band power marker), or the power in a band (if the reference marker is a band power marker itself).

If the reference marker for the band power marker is also a delta marker, the absolute power level for the reference marker is used for calculation.



Band power markers are only available for standard frequency measurements (not zero span) in the Spectrum and Spectrum application. In Analog Modulation Analysis with AM, FM, or PM spectrum results, this marker function does not determine a power value, but rather the deviation within the specified span.

For the I/Q Analyzer application, band power markers are only available for Spectrum displays.

The entire band must lie within the display. If it is moved out of the display, the result cannot be calculated (indicated by "- -" as the "Function Result"). However, the width of the band is maintained so that the band power can be calculated again when it returns to the display.

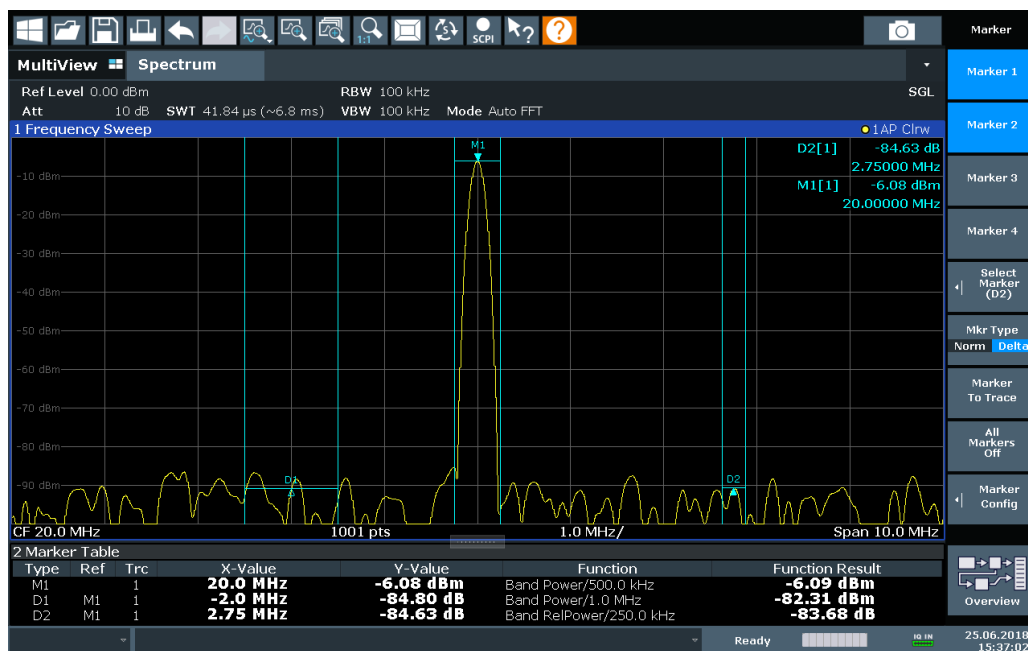

All markers can be defined as band power markers, each with a different span. When a band power marker is activated, if no marker is active yet, marker 1 is activated. Otherwise, the currently active marker is used as a band power marker (all other marker functions for this marker are deactivated).

If the detector mode for the marker trace is set to "Auto", the RMS detector is used.

The individual marker settings correspond to those defined in the "Marker" dialog box (see [Chapter 8.3.2.1, "Individual marker setup"](#), on page 551). Any settings to the marker state or type changed in the "Marker Function" dialog box are also changed in the "Marker" dialog box and vice versa.

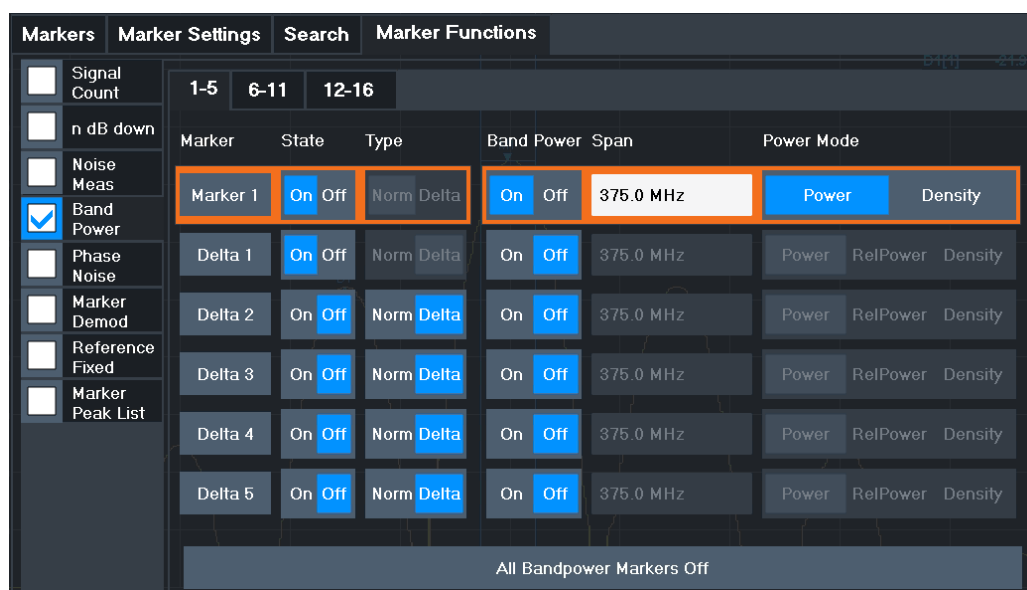

**Remote commands:**

"Example: measuring the power in a channel using band power markers" on page 1325

CALCulate<n>:MARKer<m>:FUNCTION:BPOWER[:STATE] on page 1309

CALCulate<n>:MARKer<m>:FUNCTION:BPOWER:RESULT? on page 1308

Band Power Measurement State..... 578

Span.....579

Power Mode.....579

Switching All Band Power Measurements Off.....579

**Band Power Measurement State**

Activates or deactivates band power measurement for the marker in the diagram.

Band power markers are only available for standard frequency measurements (not zero span) in the Spectrum application.

If activated, the markers display the power or density measured in the band around the current marker position.

For details see [Chapter 8.3.4.6, "Measuring the power in a channel \(band power marker\)"](#), on page 576.

Remote command:

[CALCulate<n>:MARKer<m>:FUNCTION:BPOWer\[:STATe\]](#) on page 1309

[CALCulate<n>:DELTAmarker<m>:FUNCTION:BPOWer\[:STATe\]](#) on page 1311

### Span

Defines the span (band) around the marker for which the power is measured.

The span is indicated by lines in the diagram. You can easily change the span by moving the limit lines in the diagram. They are automatically aligned symmetrically to the marker frequency. They are also moved automatically if you move the marker on the screen.

Remote command:

[CALCulate<n>:MARKer<m>:FUNCTION:BPOWer:SPAN](#) on page 1309

[CALCulate<n>:DELTAmarker<m>:FUNCTION:BPOWer:SPAN](#) on page 1311

### Power Mode

Defines the mode of the power measurement result.

For Analog Modulation Analysis, the power mode is not editable for AM, FM, or PM spectrum results. In this case, the marker function does not determine a power value, but rather the deviation within the specified span.

"Power"	The result is an absolute power level. The power unit depends on the <a href="#">Unit</a> setting.
"Relative Power"	This setting is only available for a delta band power marker. The result is the difference between the absolute power in the band around the delta marker and the absolute power for the reference marker (see <a href="#">"Reference Marker"</a> on page 343). The powers are subtracted logarithmically, so the result is a dB value. <i>[Relative band power (Delta2) in dB] = [absolute band power (Delta2) in dBm] - [absolute (band) power of reference marker in dBm]</i> For details see <a href="#">"Relative band power markers"</a> on page 577
"Density"	The result is a power level in relation to the bandwidth, displayed in dBm/Hz.

Remote command:

[CALCulate<n>:MARKer<m>:FUNCTION:BPOWer:MODE](#) on page 1308

[CALCulate<n>:DELTAmarker<m>:FUNCTION:BPOWer:MODE](#) on page 1310

### Switching All Band Power Measurements Off

Deactivates band power measurement for all markers.

Remote command:

[CALCulate<n>:MARKer<m>:FUNCTION:BPOWer\[:STATe\]](#) on page 1309

[CALCulate<n>:DELTAmarker<m>:FUNCTION:BPOWer\[:STATe\]](#) on page 1311

#### 8.3.4.7 Demodulating marker values and providing audio output (marker demodulation)

**Access:** "Overview" > "Analysis" > "Marker Functions" > "Select Marker Function" > "Marker Demodulation" > "Marker Demod Config"

Or: [MKR FUNC] > "Select Marker Function" > "Marker Demodulation" > "Marker Demod Config"

The FSW provides demodulators for AM, FM and PM signals. The demodulation marker function sends the demodulated data at the current marker frequency to the audio output. Thus, a displayed signal can be identified acoustically with the help of the internal loudspeaker or with headphones.



This function is not available for Spectrum Emission Mask measurements or measurements on I/Q-based data.

The sweep stops at the frequency determined by marker 1 for the selected time and the RF signal is demodulated in a bandwidth that corresponds to the RBW. Alternatively, demodulation can be activated continuously, i.e. audio output occurs regardless of the marker position and the marker stop time. For measurements in the time domain (zero span), demodulation is always continuous.

Optionally, a minimum level ("Squelch Level") can be defined so that the signal is only demodulated when it exceeds the set level. This is useful during continuous demodulation to avoid listening to noise.

The squelch function activates the video trigger function (see "Video" on page 515) and deactivates any other trigger or gating settings. The squelch level and trigger level are set to the same value. The trigger source in the channel bar is indicated as "SQL" for squelch. The squelch level is indicated by a red line in the diagram.

Marker Demodulation					
Marker	Marker Demodulation		Continuous Demodulation		Marker Stop Time
Marker 1	On	Off	On	Off	1.0 s
	Modulation		Squelch		Squelch Level
	AM	FM	On	Off	50.0 %

#### Remote commands:

Chapter 13.8.3.15, "Programming examples for using markers and marker functions", on page 1319

Marker Demodulation State.....	581
Continuous Demodulation.....	581
Marker Stop Time.....	581
Modulation.....	581
Squelch.....	581
Squelch Level.....	582

### Marker Demodulation State

Activates or deactivates the demodulation output. If activated, the signal is demodulated and sent to the audio output.

Remote command:

[CALCulate<n>:MARKer<m>:FUNCTION:DEModulation\[:STATe\]](#) on page 1318

### Continuous Demodulation

If activated, the signal is demodulated continuously and sent to the audio output, instead of stopping the sweep at the marker frequency of marker 1 and demodulating there for the configured marker stop time. This allows you to monitor the frequency range acoustically (assuming the sweep time is long enough).

In FFT mode, "Continuous Demodulation" is not available. The sweep always stops at the frequency of marker 1.

For EMI measurements, during the initial peak search, demodulation is not stopped at the determined markers, even if "Continuous Demodulation" is disabled.

During the final measurement, demodulation is always performed at the detected peak marker positions only (for the defined dwell time), regardless of the "Continuous Demodulation" setting.

Remote command:

[CALCulate<n>:MARKer<m>:FUNCTION:DEModulation:CONTinuous](#)  
on page 1317

### Marker Stop Time

Defines how long the sweep is stopped at the marker position to output the demodulated signal.

For zero span measurements, demodulation is always active continuously, regardless of the marker stop time.

For EMI measurements, the duration of the demodulation at each marker position is limited by the dwell time of the EMI measurement marker (see "[Dwell Time](#)" on page 348).

Remote command:

[CALCulate<n>:MARKer<m>:FUNCTION:DEModulation:HOLDoff](#) on page 1317

### Modulation

Defines the demodulation mode for output. The default setting is AM.

Remote command:

[CALCulate<n>:MARKer<m>:FUNCTION:DEModulation:SELect](#) on page 1318

### Squelch

Activates or deactivates the squelch function. If activated, the audible AF is cut off below a defined threshold level. Thus, you avoid hearing noise at the audio output when no signal is available.

The squelch function activates the video trigger function (see "[Video](#)" on page 515) and deactivates any other trigger or gating settings. The squelch level and trigger level are set to the same value. The trigger source in the channel bar is indicated as "SQL" for squelch. The squelch level is indicated by a red line in the diagram.

The trigger source in the channel bar is indicated as "SQL" for squelch. The squelch level is indicated by a red line in the diagram.

Remote command:

[\[SENSe:\]DEMod:SQUelch\[:STATe\]](#) on page 1319

### Squelch Level

Defines the level threshold below which the audible AF is cut off if squelching is enabled. The video trigger level is set to the same value.

The squelch level is indicated by a red line in the diagram.

Remote command:

[\[SENSe:\]DEMod:SQUelch:LEVel](#) on page 1318

#### 8.3.4.8 Marker peak list

**Access:** "Overview" > "Analysis" > "Marker Functions" > "Marker Peak List"

**Or:** [MKR FUNC] > "Marker Peak List"

A common measurement task is to determine peak values, i.e. maximum or minimum signal levels. The FSW provides various peak search functions and applications:

- Setting a marker to a peak value once (Peak Search)
- Searching for a peak value within a restricted search area (Search Limits)
- Creating a "marker table" with all or a defined number of peak values for one sweep ("Marker Peak List")
- Updating the marker position to the current peak value automatically after each sweep (Auto Peak Search)
- Creating a fixed reference marker at the current peak value of a trace (Fixed Reference)

#### Peak search limits

The peak search can be restricted to a search area. The search area is defined by limit lines which are also indicated in the diagram. In addition, a minimum value (threshold) can be defined as a further search condition.

#### When is a peak a peak? - Peak excursion

During a peak search, noise values are detected as a peak if the signal is very flat or does not contain many peaks. Therefore, you can define a relative threshold ("Peak Excursion"). The signal level must increase by the threshold value before falling again before a peak is detected. To avoid identifying noise peaks as maxima or minima, enter a peak excursion value that is higher than the difference between the highest and the lowest value measured for the displayed inherent noise.

#### Effect of peak excursion settings (example)

The following figure shows a trace to be analyzed.

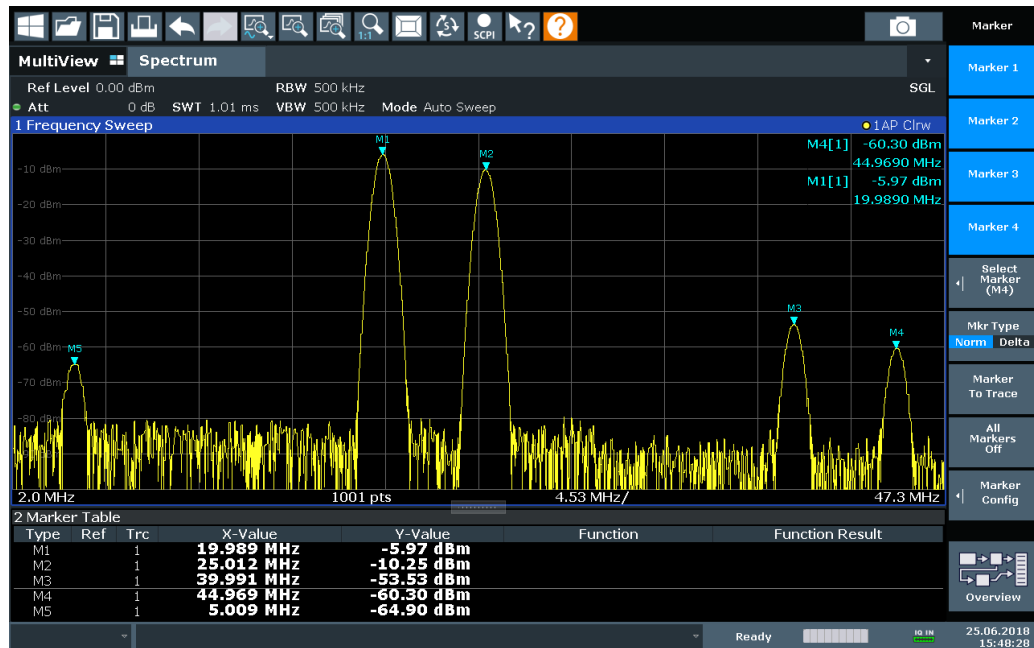

Figure 8-6: Trace example

The following table lists the peaks as indicated by the marker numbers in the diagram above, as well as the minimum decrease in amplitude to either side of the peak:

Marker #	Min. amplitude decrease to either side of the signal
1	80 dB
2	80 dB
3	55 dB
4	39 dB
5	32 dB

To eliminate the smaller peaks M3, M4 and M5 in the example above, a peak excursion of at least 60 dB is required. In this case, the amplitude must rise at least 60 dB before falling again before a peak is detected.

**Marker peak list**

The marker peak list determines the frequencies and levels of peaks in the spectrum. It is updated automatically after each sweep. How many peaks are displayed can be defined, as well as the sort order. In addition, the detected peaks can be indicated in the diagram. The peak list can also be exported to a file for analysis in an external application.

**Automatic peak search**

A peak search can be repeated automatically after each sweep to keep the maximum value as the reference point for a phase noise measurement. Automatic peak search is useful to track a drifting source. The delta marker 2, which shows the phase noise

measurement result, keeps the delta frequency value. Therefore, the phase noise measurement leads to reliable results in a certain offset although the source is drifting.

**Using a peak as a fixed reference marker**

Some results are analyzed in relation to a peak value, for example a carrier frequency level. In this case, the maximum level can be determined by an initial peak search and then be used as a reference point for further measurement results.

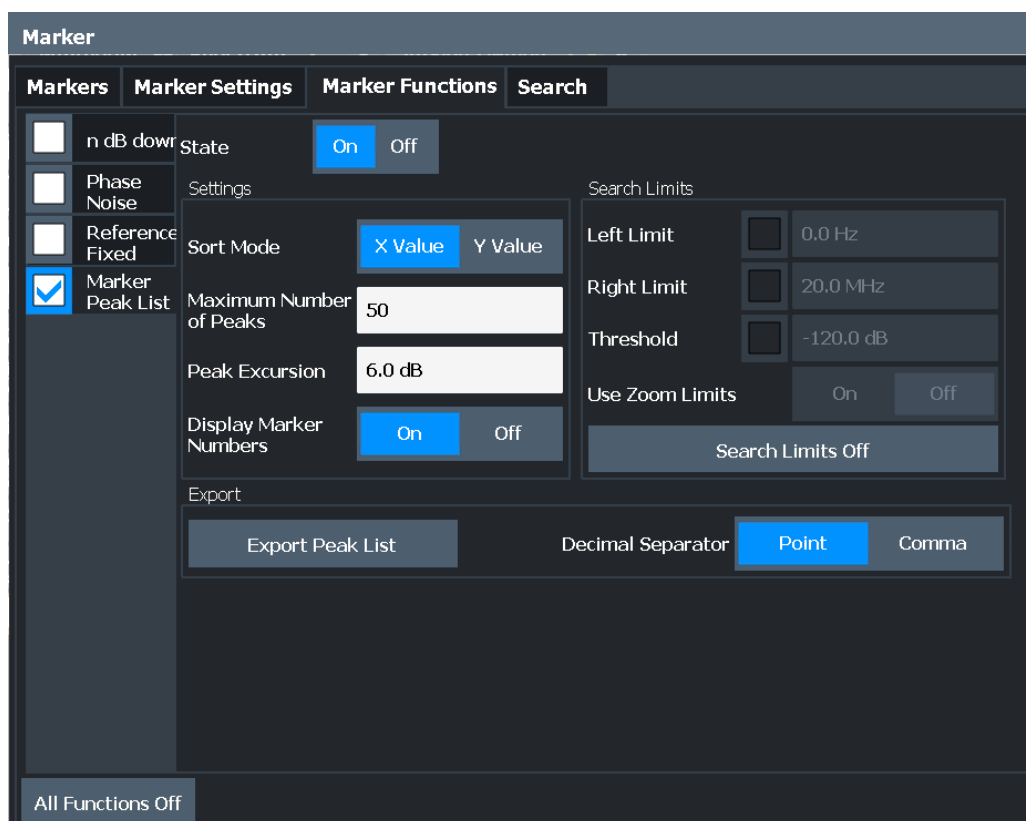

**Remote commands:**

"Example: obtaining a marker peak list" on page 1323

CALCulate<n>:MARKer<m>:FUNCTion:FPEaks:STATe on page 1302

TRAC? LIST,

See TRACe<n> [ :DATA] on page 1258

Peak List State..... 585

Sort Mode..... 585

Maximum Number of Peaks..... 585

Peak Excursion..... 585

Display Marker Numbers..... 585

Export Peak List..... 585



**Peak List State**

Activates/deactivates the marker peak list. If activated, the peak list is displayed and the peaks are indicated in the trace display.

For each listed peak, the frequency/time ("X-value") and level ("Y-Value") values are given.

Remote command:

[CALCulate<n>:MARKer<m>:FUNCTION:FPEaks:STATE](#) on page 1302

**Sort Mode**

Defines whether the peak list is sorted according to the x-values or y-values. In either case, the values are sorted in ascending order.

Remote command:

[CALCulate<n>:MARKer<m>:FUNCTION:FPEaks:SORT](#) on page 1302

**Maximum Number of Peaks**

Defines the maximum number of peaks to be determined and displayed.

Remote command:

[CALCulate<n>:MARKer<m>:FUNCTION:FPEaks:LIST:SIZE](#) on page 1301

**Peak Excursion**

Defines the minimum level value by which a signal must rise or fall so that it is identified as a maximum or a minimum by the search functions.

Entries from 0 dB to 80 dB are allowed; the resolution is 0.1 dB. The default setting for the peak excursion is 6 dB.

For Analog Modulation Analysis, the unit and value range depend on the selected result display type.

For more information, see [Chapter 8.3.4.8, "Marker peak list"](#), on page 582.

Remote command:

[CALCulate<n>:MARKer<m>:PEXCursion](#) on page 1277

**Display Marker Numbers**

By default, the marker numbers are indicated in the diagram so you can find the peaks from the list. However, for large numbers of peaks, the marker numbers can decrease readability; in this case, deactivate the marker number display.

Remote command:

[CALCulate<n>:MARKer<m>:FUNCTION:FPEaks:ANNOtation:LABel\[:STATE\]](#) on page 1300

**Export Peak List**

The peak list can be exported to an ASCII file (.DAT) for analysis in an external application.

Remote command:

[MMEMory:STORe<n>:PEAK](#) on page 1374

[FORMat:DEXPort:DSEParator](#) on page 1348

### 8.3.4.9 Deactivating all marker functions

**Access:** "Overview" > "Analysis" > "Marker Functions" > "All Functions Off"

**Or:** [MKR FUNC] > "All Functions Off"

All special marker functions can be deactivated in one step.

**Remote command:**

`CALCulate<n>:MARKer<m>:FUNCTION:BPowEr:AOff` on page 1308

`CALCulate<n>:MARKer<m>:FUNCTION:NOISe:AOff` on page 1303

`CALCulate<n>:MARKer<m>:FUNCTION:PNOise:AOff` on page 1306

## 8.3.5 How to work with markers

The following step-by-step instructions demonstrate in detail how to work with markers.

- [How to analyze a signal point in detail](#)..... 586
- [How to use a fixed reference marker](#)..... 587
- [How to output the demodulated signal accoustically](#)..... 587
- [How to export a peak list](#)..... 588

### 8.3.5.1 How to analyze a signal point in detail



Step-by-step instructions on working with markers are provided here. For details on individual functions and settings see [Chapter 8.3.2, "Marker settings"](#), on page 551.

The remote commands required to perform these tasks are described in [Chapter 13.8.3, "Working with markers"](#), on page 1268.

When you need to analyze a characteristic point in the signal in more detail, the following procedure can be helpful:

1. Perform a peak search to determine the characteristic point roughly by pressing [Peak Search].
2. If the required signal point is not the maximum, continue the peak search to one of the subsequent maxima or minima:
  - a) Press [Mkr ->].
  - b) Select "Next Peak" or "Next Min".
  - c) If necessary, change the search settings by selecting "Search Config".
3. Center the display around the determined signal point by setting the marker value to the center frequency. Select "Center = Mkr Freq".
4. Determine the precise frequency of the signal point:
  - a) Select "Select Marker Function".

- b) Select "Signal Count".
- c) Select "Signal Count Resolution".
- d) Select the resolution depending on how precise the result needs to be.

### 8.3.5.2 How to use a fixed reference marker

By default, delta markers refer to marker 1. However, they can also refer to a fixed reference marker.

#### How to Define and Move a Fixed Reference Marker

1. To display a fixed reference marker, do one of the following:
  - Press [MKR FUNC], then select the "Reference Fixed" marker function.
  - In the "Marker" dialog box, in the "Reference Fixed" area of the "Marker Config" tab, set the "State" to "On".

A vertical and a horizontal red display line are displayed, marked as "FXD". The normal marker 1 is activated and set to the peak value of the trace assigned to marker 1, and a delta marker to the next peak. The fixed reference marker is set to the position of marker 1 at the peak value.

2. To move the fixed reference marker, do one of the following:
  - Change the "Level" and "Frequency" of the reference point in the "Marker Config" tab of the "Marker" dialog box, . By default, the current peak value of trace 1 is set.
  - Set the fixed reference marker to the current peak value by selecting "Peak Search" in the "Marker Config" tab of the "Marker" dialog box.
  - Move the "FXD" display lines that define the position of the fixed reference marker by dragging them on the screen.

#### How to Assign a Fixed Reference Marker to Delta Markers

1. In the "Marker" dialog box, select the horizontal "Markers" tab.
2. For the active delta marker that is to refer to the fixed reference marker, select "FXD" from the "Reference Marker" list.

The delta marker indicates the offset of the current trace value at the marker position from the fixed reference value.

### 8.3.5.3 How to output the demodulated signal acoustically

For long sweep times you may wish to monitor a measurement acoustically rather than visually to determine when a certain signal level is reached.

1. Set marker 1 to the signal level you want to monitor.
2. Press [Mkr FUNCT].
3. Select "Select Marker Function".

4. Select "Marker Demodulation".
5. Select "Marker Demod Config".

The marker function results are determined immediately according to the default settings.
6. Define how long you want to hear the output signal when the marker value is reached by entering the duration in the "Marker Stop Time" field.

Alternatively, the audio signal can be output continuously, regardless of the marker value; in this case, set "Continuous Demodulation" to "On".
7. Select the modulation type (AM/FM/PM) of the signal.
8. To avoid listening to noise during continuous output, set "Squelch" to "On" and define the signal level below which the signal is ignored ("Squelch").
9. Set "Marker Demodulation" to "On".
10. **CAUTION!** Risk of hearing damage. To protect your hearing, make sure that the volume setting is not too high before putting on the headphones.

Plug your headphones into the PHONES connector on the front panel of the FSW.
11. Adjust the volume using the rotary knob next to the PHONES connector.

During the next or currently running measurement, when the sweep reaches the marker position, the demodulated signal is output as an audio signal via the headphones for the given duration. Or, depending on the configuration, the demodulated signal is continuously output via the headphones, if the signal level exceeds the squelch level.

#### 8.3.5.4 How to export a peak list

You can save the results of a marker peak list to an ASCII file.

1. Press [MKR FUNCT].
2. Select "Marker Peak List".
3. Configure the peak search and list settings as described in [Chapter 8.3.4.8, "Marker peak list"](#), on page 582.
4. Set the marker peak list "State" to "On".
5. Press [RUN SINGLE] to perform a single sweep measurement and create a marker peak list.
6. Select "Marker Peak List" to display the "Marker Peak List" dialog box again.
7. If necessary, change the decimal separator to be used for the ASCII export file.
8. Select "Export Peak List".
9. In the file selection dialog box, select the storage location and file name for the export file.

10. Select "Save" to close the dialog box and export the peak list data to the file.

### 8.3.6 Measurement example: measuring harmonics using marker functions

This measurement example describes how to measure harmonics using the provided marker functions. Note that this task can be performed much simpler using the Harmonic Distortion measurement (see [Chapter 6.10, "Harmonic distortion measurement"](#), on page 313).

#### Signal generator settings (e.g. R&S SMW):

Frequency:	128 MHz
Level:	+15 dBm

#### Procedure:

1. Preset the FSW.
2. Set the center frequency to *128 MHz*.
3. Set the span to *100 kHz*.
4. Select "Auto Level".  
The FSW displays the reference signal with a span of 100 kHz and resolution bandwidth of 1 kHz.
5. Switch on the marker by pressing [MKR].  
The marker is positioned on the trace maximum.
6. Set the measured signal frequency and the measured level as reference values:
  - a) Press [MKR FUNC]
  - b) Press "Reference Fixed".

The position of the marker becomes the reference point. The reference point level is indicated by a horizontal line, the reference point frequency with a vertical line. At the same time, the delta marker 2 is switched on.

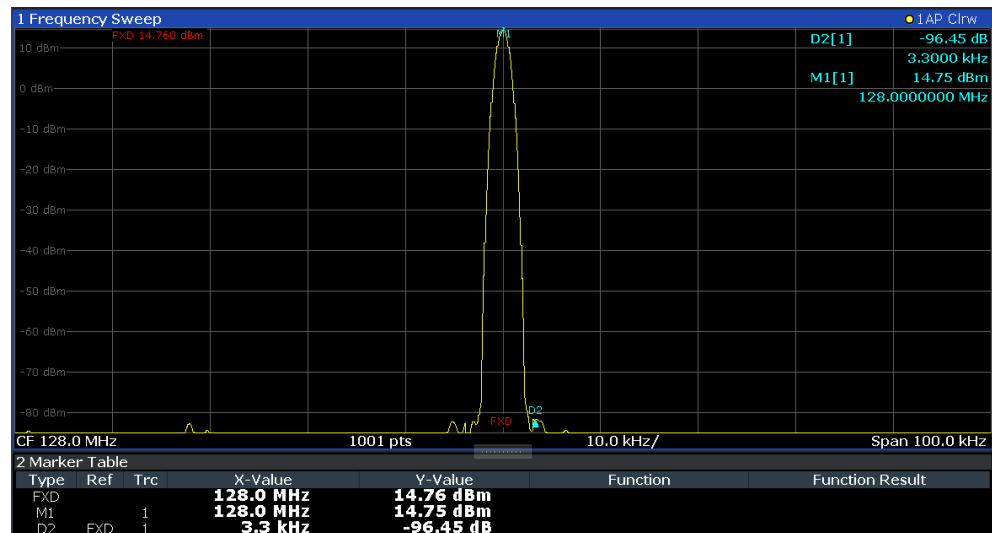

Figure 8-7: Fundamental wave and the frequency and level reference point

- Make the step size for the center frequency correspond to the signal frequency: in the "Frequency" configuration dialog box, select "Center Frequency Stepsize" = "Marker".

The step size for the center frequency is now equal to the marker frequency.

- Move the center frequency to the 2<sup>nd</sup> harmonic of the signal by pressing [UP] (↑).

The center frequency is set to the 2<sup>nd</sup> harmonic.

- Select "Auto Level" to ensure the FSW measures the harmonics with a high sensitivity.

- Place the delta marker on the 2<sup>nd</sup> harmonic: in the "Marker To" menu, select "Peak".

The delta marker moves to the maximum of the 2<sup>nd</sup> harmonic. The displayed level result is relative to the reference point level (= fundamental wave level).

The other harmonics are measured by repeating steps [step 8](#) to [step 10](#), with the center frequency being incremented or decremented in steps of 128 MHz using the [UP] or [DOWN] keys.

## 8.4 Display and limit lines

Display and limit lines help you analyze a measurement trace.



Display lines are only available in the Spectrum and (optional) Analog Demodulation applications.

In the I/Q Analyzer application, lines are only available for measurements in the frequency domain.

**Access:** "Overview" > "Analysis" > "Lines"

For remote operation, see [Chapter 13.8.4, "Configuring display lines"](#), on page 1328.

- [Display lines](#).....591
- [Limit lines](#).....593

## 8.4.1 Display lines

### 8.4.1.1 Basics on display lines

Display lines help you analyze a trace – as do markers. The function of a display line is comparable to that of a ruler that can be shifted on the trace in order to mark absolute values. They are used exclusively to visually mark relevant frequencies or points in time (zero span), as well as constant level values. It is not possible to check automatically whether the points are below or above the marked level values - use limit lines for that task (see [Chapter 8.4.2.1, "Basics on limit lines"](#), on page 593).

Two different types of display lines are provided:

- Two horizontal lines: "Horizontal Line 1" and "Horizontal Line 2".  
These lines are continuous horizontal lines across the entire width of a diagram and can be shifted up and down.
- Four vertical lines: "Vertical Line 1" to "Vertical Line 4".  
These lines are continuous vertical lines across the entire height of the diagram and can be shifted left and right.

#### Labels

Each line is identified by one of the following abbreviations in the diagrams:

- H1: "Horizontal Line 1"
- H2: "Horizontal Line 2"
- V1: "Vertical Line 1"
- V2: "Vertical Line 2"
- V3: "Vertical Line 3"
- V4: "Vertical Line 4"

### 8.4.1.2 Display line settings

**Access:** "Overview" > "Analysis" > "Lines" > "Display Lines"

Four vertical and two horizontal lines can be defined in the display.

Line Config	
Limit Lines	Display Lines
Vertical Line 1	<input type="checkbox"/> 0.0 s
Vertical Line 2	<input type="checkbox"/> 0.0 s
Vertical Line 3	<input type="checkbox"/> 0.0 s
Vertical Line 4	<input type="checkbox"/> 0.0 s
Horizontal Line 1	<input type="checkbox"/> 0.0 dBm
Horizontal Line 2	<input type="checkbox"/> 0.0 dBm

<a href="#">Vertical Line &lt;x&gt;</a> .....	592
<a href="#">Horizontal Line 1/ Horizontal Line 2</a> .....	592

#### Vertical Line <x>

Activates a vertical display line in the diagram at the specified point of the x-axis, depending on the scale of the axis.

Remote command:

[CALCulate<n>:FLINE<dl>](#) on page 1329

[CALCulate<n>:TLINE<dl>](#) on page 1329

#### Horizontal Line 1/ Horizontal Line 2

Activates a horizontal display line (H1 or H2) in the diagram at the specified point of the y-axis.

Remote command:

[CALCulate<n>:DLINE<dl>](#) on page 1328

[CALCulate<n>:DLINE<dl>](#) on page 1328

### 8.4.1.3 Defining display lines

1. Display lines are configured in the "Lines Config" dialog box. To display this dialog box, press [Lines] and then "Lines Config".
2. Select the "Display Lines" tab.
3. To define a vertical line:
  - a) Select "Vertical Line 1", 2, 3, or 4.
  - b) Enter the x-value at which the line is to be displayed.
4. To define a horizontal line:
  - a) Select "Horizontal Line 1" or 2.



- b) Enter the y-value at which the line is to be displayed.

## 8.4.2 Limit lines

Limit lines allow you to check automatically whether the measured points are below or above specified values.

- [Basics on limit lines](#).....593
- [Limit line settings and functions](#).....597
- [How to define limit lines](#).....604
- [Reference: limit line file format](#).....608

### 8.4.2.1 Basics on limit lines

Limit lines are used to define amplitude curves or spectral distribution boundaries in the result diagram which are not to be exceeded. They indicate, for example, the upper limits for interference radiation or spurious waves which are allowed from a device under test (DUT). When transmitting information in TDMA systems (e.g. GSM), the amplitude of the bursts in a time slot must adhere to a curve that falls within a specified tolerance band. The lower and upper limits may each be specified by a limit line. Then, the amplitude curve can be controlled either visually or automatically for any violations of the upper or lower limits (GO/NOGO test).

The FSW supports limit lines with a maximum of 200 data points. Eight of the limit lines stored in the instrument can be activated simultaneously. The number of limit lines stored in the instrument is only limited by the capacity of the storage device used.

Limit line data can also be exported to a file in ASCII (CSV) format for further evaluation in other applications. Limit lines stored in the specified ASCII (CSV) format can also be imported to the FSW for other measurements.

#### Compatibility

Limit lines are compatible with the current measurement settings, if the following applies:

- The x unit of the limit line has to be identical to the current setting.
- The y unit of the limit line has to be identical to the current setting with the exception of dB based units; all dB based units are compatible with each other.

#### Validity

Only limit lines that fulfill the following conditions can be activated:

- Each limit line must consist of a minimum of 2 and a maximum of 200 data points.
- The frequencies/times for each data point must be defined in ascending order; however, for any single frequency or time, two data points may be entered (to define a vertical segment of a limit line).
- Gaps in frequency or time are not allowed. If gaps are desired, two separate limit lines must be defined and then both enabled.

- The entered frequencies or times need not necessarily be selectable in FSW. A limit line may also exceed the specified frequency or time range. The minimum frequency for a data point is -200 GHz, the maximum frequency is 200 GHz. For the time range representation, negative times may also be entered. The allowed range is -1000 s to +1000 s.

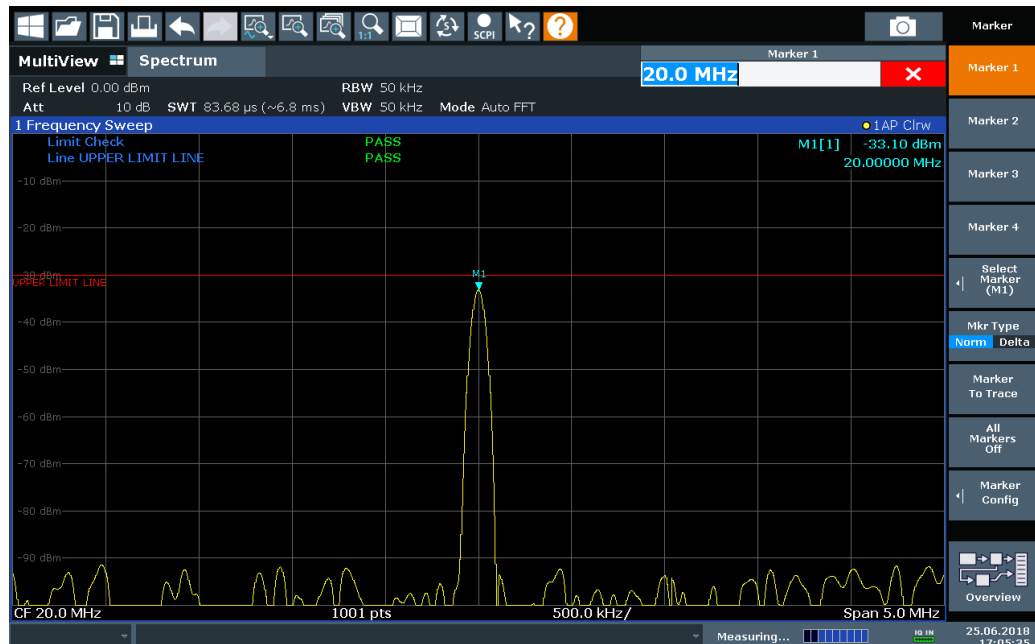

Figure 8-8: Example for an upper limit line

## Limits and Margins

Limit lines define strict values that must not be exceeded by the measured signal. A **margin** is similar to a limit, but less strict and it still belongs to the valid data range. It can be used as a warning that the limit is almost reached. The margin is not indicated by a separate line in the display, but if it is violated, a warning is displayed. Margins are defined as lines with a fixed distance to the limit line.

To check the signal for maximum levels you must define an **upper limit**, whereas to check the signal for minimum levels you must define a **lower limit**.

Limits can be defined relative to the reference level, the beginning of the time scale, or the center frequency, or as absolute values.

Relative scaling is suitable, for example, if masks for bursts are to be defined in zero span, or if masks for modulated signals are required in the frequency domain.

## Thresholds

If the y-axis for the limit line data points uses relative scaling, an additional absolute **threshold** can be defined for the limit check. In this case, both the threshold value and the relative limit line must be exceeded before a violation occurs.

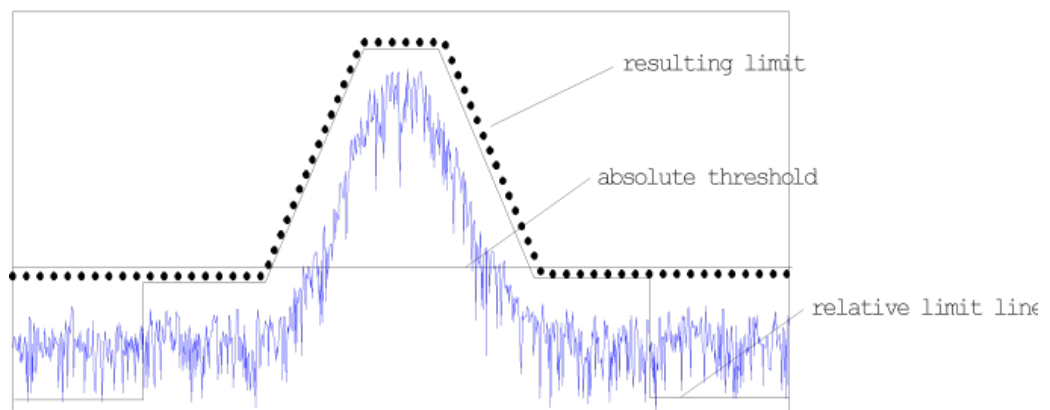

### Offsets and Shifting

A configured limit line can easily be moved vertically or horizontally. Two different methods to do so are available:

- An **offset** moves the entire line in the diagram without editing the configured values or positions of the individual data points. This option is only available if relative scaling is used.  
Thus, a new limit line can be easily generated based upon an existing limit line which has been shifted horizontally or vertically.
- Defining a **shift** width for the values or position of the individual data points changes the line configuration, thus changing the position of the line in the diagram.

### Limit Check Results

A limit check is automatically performed as soon as any of the limit lines is activated ("Visibility" setting). Only the specified "Traces to be Checked" are compared with the active limit lines. The status of the limit check for each limit line is indicated in the diagram. If a violation occurs, the limit check status is set to "MARG" for a margin violation, or to "Fail" for a limit violation.

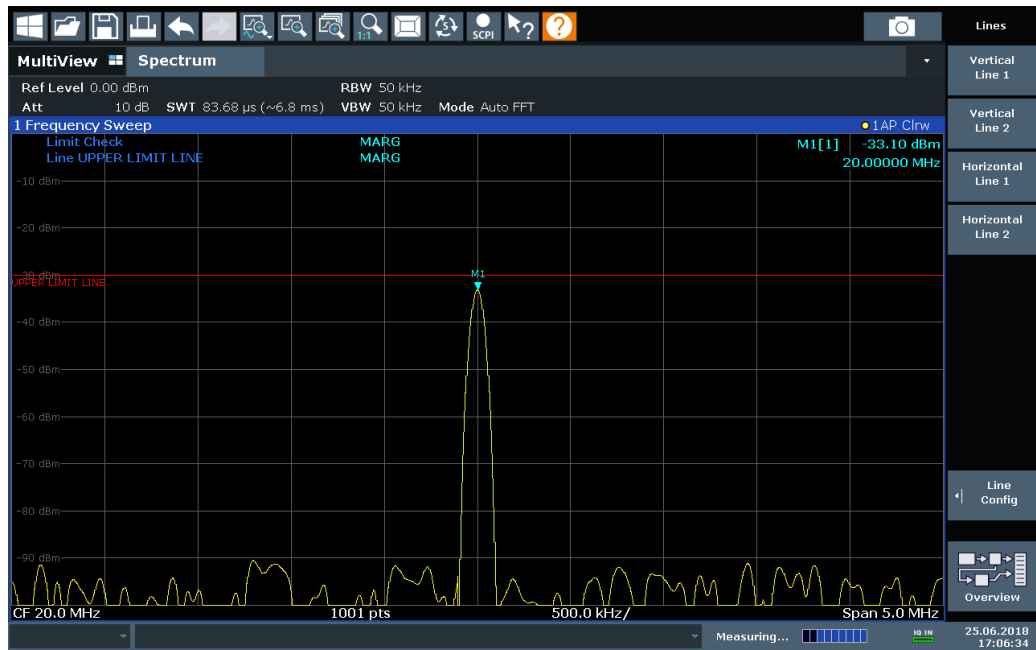

Figure 8-9: Margin violation for limit check

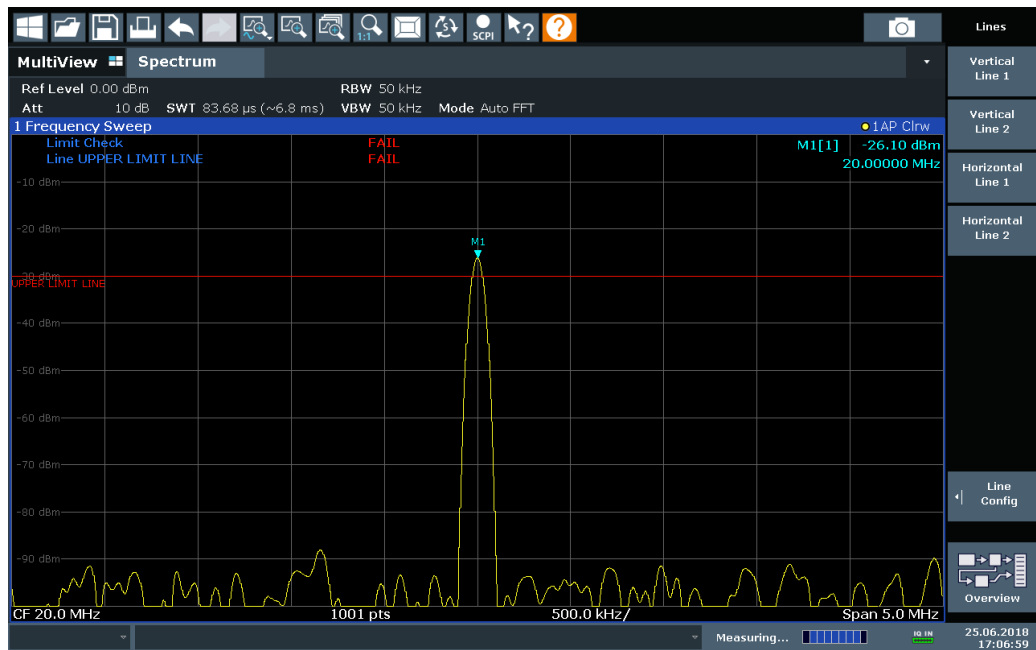

Figure 8-10: Limit violation for limit check



### Storing and Recalling Limit Lines

Limit lines can be stored with the configuration settings so they can be recalled for other measurements at a later time (see [Chapter 10.3, "Storing and recalling instrument settings and measurement data"](#), on page 677). Note, however, that any changes made to the limit lines *after* storing the configuration file cannot be restored and will be overwritten by the stored values when the configuration file is recalled. Always remember to store the settings again after changing the limit line values.

After recalling measurement settings, the limit line values applied to the measurement may be different to those displayed in the "Limit Lines" dialog box; see ["Saving and recalling transducer and limit line settings"](#) on page 678.

#### 8.4.2.2 Limit line settings and functions

**Access:** "Overview" > "Analysis" > "Lines"

**or:** [LINES] > "Line Config"

Up to 8 limit lines can be displayed simultaneously in the FSW. Many more can be stored on the instrument.



### Stored limit line settings

When storing and recalling limit line settings, consider the information provided in ["Saving and recalling transducer and limit line settings"](#) on page 678.

- [Limit line management](#).....597
- [Limit line details](#).....600

### Limit line management

**Access:** "Overview" > "Analysis" > "Lines" > "Limit Lines"

**or:** [LINES] > "Line Config" > "Limit Lines"

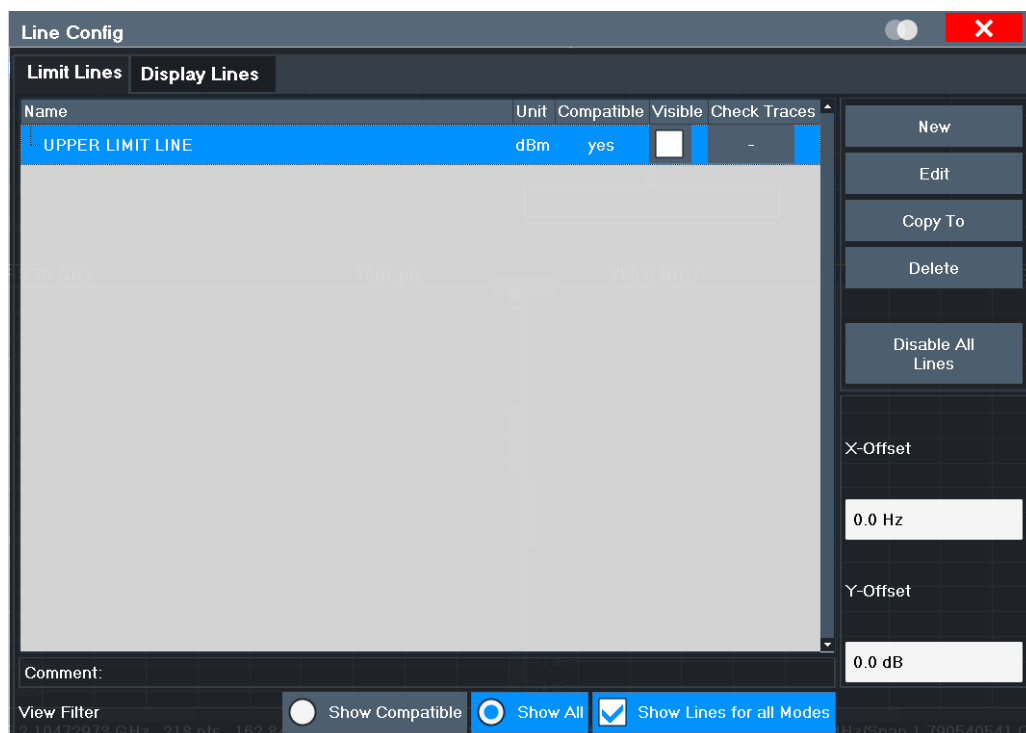

For the limit line overview, the FSW searches for all stored limit lines with the file extension `.LIN` in the `limits` subfolder of the main installation folder. The overview allows you to determine which limit lines are available and can be used for the current measurement.

For details on settings for individual lines see ["Limit line details"](#) on page 600.

For more basic information on limit lines see [Chapter 8.4.2.1, "Basics on limit lines"](#), on page 593.

Name.....	598
Unit.....	599
Compatibility.....	599
Visibility.....	599
Traces to be Checked.....	599
Comment.....	599
Included Lines in Overview (View Filter).....	599
└ Show Lines for all Modes.....	599
X-Offset.....	599
Y-Offset.....	600
Create New Line.....	600
Edit Line.....	600
Copy Line.....	600
Delete Line.....	600
Disable All Lines.....	600

**Name**

The name of the stored limit line.

**Unit**

The unit in which the y-values of the data points of the limit line are defined.

**Compatibility**

Indicates whether the limit line definition is compatible with the current measurement settings.

For more information on which conditions a limit line must fulfill to be compatible, see "[Compatibility](#)" on page 593.

**Visibility**

Displays or hides the limit line in the diagram. Up to 8 limit lines can be visible at the same time. Inactive limit lines can also be displayed in the diagram.

Remote command:

`CALCulate<n>:LIMit<li>:LOWer:STATe` on page 1336

`CALCulate<n>:LIMit<li>:UPPer:STATe` on page 1340

`CALCulate<n>:LIMit<li>:ACTive?` on page 1341

**Traces to be Checked**

Defines which traces are automatically checked for conformance with the limit lines. As soon as a trace to be checked is defined, the assigned limit line is active. One limit line can be activated for several traces simultaneously. If any of the "Traces to be Checked" violate any of the active limit lines, a message is indicated in the diagram.

Remote command:

`CALCulate<n>:LIMit<li>:TRACe<t>:CHECK` on page 1342

**Comment**

An optional description of the limit line.

**Included Lines in Overview (View Filter)**

Defines which of the stored lines are included in the overview.

"Show Compatible"	Only compatible lines Whether a line is compatible or not is indicated in the <a href="#">Compatibility</a> setting.
"Show All"	All stored limit lines with the file extension <code>.LIN</code> in the <code>limits</code> subfolder of the main installation folder. (if not restricted by "Show Lines for all Modes" setting).

**Show Lines for all Modes ← Included Lines in Overview (View Filter)**

If activated (default), limit lines from all applications are displayed. Otherwise, only lines that were created in the Spectrum application are displayed.

Note that limit lines from some applications may include additional properties that are lost when the limit lines are edited in the Spectrum application. In this case a warning is displayed when you try to store the limit line.

**X-Offset**

Shifts a limit line that has been specified for relative frequencies or times (x-axis) horizontally.

This setting does not have any effect on limit lines that are defined by absolute values for the x-axis.

Remote command:

[CALCulate<n>:LIMit<li>:CONTRol:OFFSet](#) on page 1333

### Y-Offset

Shifts a limit line that has relative values for the y-axis (levels or linear units such as volt) vertically.

This setting does not have any effect on limit lines that are defined by absolute values for the y-axis.

Remote command:

[CALCulate<n>:LIMit<li>:LOWer:OFFSet](#) on page 1335

[CALCulate<n>:LIMit<li>:UPPer:OFFSet](#) on page 1339

### Create New Line

Creates a new limit line.

### Edit Line

Edit an existing limit line configuration.

### Copy Line

Copy the selected limit line configuration to create a new line.

Remote command:

[CALCulate<n>:LIMit<li>:COPY](#) on page 1341

### Delete Line

Delete the selected limit line configuration.

Remote command:

[CALCulate<n>:LIMit<li>:DELete](#) on page 1341

### Disable All Lines

Disable all limit lines in one step.

Remote command:

[CALCulate<n>:LIMit<li>:STATe](#) on page 1342

### Limit line details

**Access:** "Overview" > "Analysis" > "Lines" > "Limit Lines" > "New" / "Edit" / "Copy To"

**or:** [LINES] > "Line Config" > "Limit Lines" > "New" / "Edit" / "Copy To"



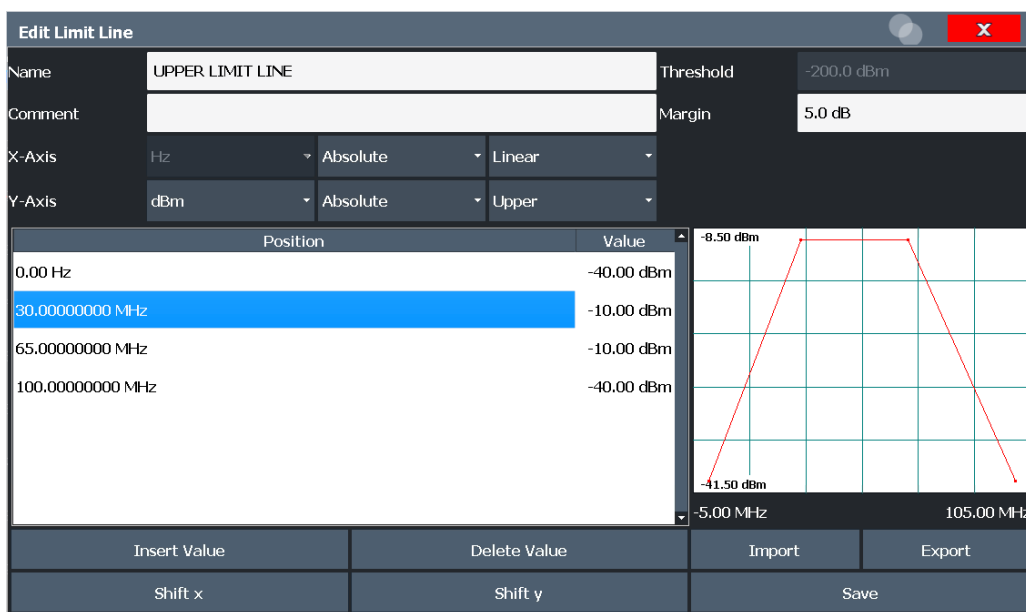

Name.....601

Comment.....601

Threshold.....601

Margin.....602

X-Axis.....602

Y-Axis.....602

Data Points.....602

Insert Value.....603

Delete Value.....603

Shift x.....603

Shift y.....603

Save.....603

Import.....603

    L File Explorer.....603

Export.....603

    L File Explorer.....604

**Name**

Defines the limit line name. All names must be compatible with Windows conventions for file names. The limit line data is stored under this name (with a .LIN extension).

Remote command:

CALCulate<n>:LIMit<li>:NAME on page 1337

**Comment**

Defines an optional comment for the limit line.

Remote command:

CALCulate<n>:LIMit<li>:COMMent on page 1331

**Threshold**

Defines an absolute threshold value (only for relative scaling of the y-axis).

For details on thresholds see "[Thresholds](#)" on page 594.

Remote command:

[CALCulate<n>:LIMit<li>:LOWer:THReshold](#) on page 1336

[CALCulate<n>:LIMit<li>:UPPer:THReshold](#) on page 1340

### Margin

Defines a margin for the limit line. The default setting is 0 dB (i.e. no margin).

For details on margins see "[Limits and Margins](#)" on page 594.

Remote command:

[CALCulate<n>:LIMit<li>:LOWer:MARGIn](#) on page 1334

[CALCulate<n>:LIMit<li>:UPPer:MARGIn](#) on page 1338

### X-Axis

Describes the horizontal axis on which the data points of the limit line are defined.

Includes the following settings:

- Unit:
  - "Hz": for frequency domain
  - "s": for time domain
- Scaling mode: absolute or relative values  
For relative values, the frequencies are referred to the currently set center frequency. In the time domain, the left boundary of the diagram is used as the reference.
- Scaling: linear or logarithmic

Remote command:

[CALCulate<n>:LIMit<li>:CONTRol:MODE](#) on page 1332

[CALCulate<n>:LIMit<li>:CONTRol:DOMain](#) on page 1332

[CALCulate<n>:LIMit<li>:CONTRol:SPACing](#) on page 1333

### Y-Axis

Describes the vertical axis on which the data points of the limit line are defined.

Includes the following settings:

- Level unit
- Scaling mode: absolute or relative (dB/%) values  
Relative limit values refer to the reference level.
- Limit type: upper or lower limit; values must stay above the lower limit and below the upper limit to pass the limit check

Remote command:

[CALCulate<n>:LIMit<li>:UNIT](#) on page 1337

[CALCulate<n>:LIMit<li>:LOWer:MODE](#) on page 1334

[CALCulate<n>:LIMit<li>:UPPer:MODE](#) on page 1338

[CALCulate<n>:LIMit<li>:LOWer:SPACing](#) on page 1336

[CALCulate<n>:LIMit<li>:UPPer:SPACing](#) on page 1339

### Data Points

Each limit line is defined by a minimum of 2 and a maximum of 200 data points. Each data point is defined by its position (x-axis) and value (y-value). Data points must be defined in ascending order. The same position can have two different values.

Remote command:

[CALCulate<n>:LIMit<li>:CONTrol\[:DATA\]](#) on page 1331

[CALCulate<n>:LIMit<li>:LOWer\[:DATA\]](#) on page 1334

[CALCulate<n>:LIMit<li>:UPPer\[:DATA\]](#) on page 1337

### Insert Value

Inserts a data point in the limit line above the selected one in the "Edit Limit Line" dialog box.

### Delete Value

Deletes the selected data point in the "Edit Limit Line" dialog box.

### Shift x

Shifts the x-value of each data point horizontally by the defined shift width (as opposed to an additive offset defined for the entire limit line, see "[X-Offset](#)" on page 599).

Remote command:

[CALCulate<n>:LIMit<li>:CONTrol:SHIFt](#) on page 1333

### Shift y

Shifts the y-value of each data point vertically by the defined shift width (as opposed to an additive offset defined for the entire limit line, see "[Y-Offset](#)" on page 600).

Remote command:

[CALCulate<n>:LIMit<li>:LOWer:SHIFt](#) on page 1335

[CALCulate<n>:LIMit<li>:UPPer:SHIFt](#) on page 1339

### Save

Saves the currently edited limit line under the name defined in the "Name" field.

### Import

Opens a file selection dialog box and loads the limit line from the selected file in .CSV format.

Note that a valid import file must contain a minimum of required information for the FSW.

For details on the file format see [Chapter 8.4.2.4, "Reference: limit line file format"](#), on page 608.

Remote command:

[MMEMory:LOAD<n>:LIMit](#) on page 1343

### File Explorer ← Import

Opens the Microsoft Windows File Explorer.

Remote command:

not supported

### Export

Opens a file selection dialog box and stores the currently displayed limit line to the defined file in .CSV format.

For details on the file format see [Chapter 8.4.2.4, "Reference: limit line file format"](#), on page 608.

The limit line can be imported again later by the FSW for use in other measurements.

Remote command:

`MMEMory:STORe<n>:LIMit` on page 1343

#### **File Explorer ← Export**

Opens the Microsoft Windows File Explorer.

Remote command:

not supported

### **8.4.2.3 How to define limit lines**

**Access:** "Overview" > "Analysis" > "Lines" > "Limit Lines"

or: [LINES] > "Line Config" > "Limit Lines"



#### **Limit lines for spurious and SEM measurements**

Note that for spurious and SEM measurements, special limit lines can be defined for each frequency range, see [Chapter 6.6.4.2, "Limit lines in SEM measurements"](#), on page 240 and [Chapter 6.7.3.2, "Limit lines in spurious measurements"](#), on page 282. It is strongly recommended that you define limits only via the "Sweep List" dialog for these measurements, not using [Lines].

Any changes to the special limit lines are automatically overwritten when the sweep list settings are changed.

The following tasks are described here:

- ["How to find compatible limit lines"](#) on page 604
- ["How to activate and deactivate a limit check"](#) on page 605
- ["How to edit existing limit lines"](#) on page 605
- ["How to copy an existing limit line"](#) on page 605
- ["How to delete an existing limit line"](#) on page 605
- ["How to configure a new limit line"](#) on page 606
- ["How to move the limit line vertically or horizontally"](#) on page 607

#### **How to find compatible limit lines**

- ▶ In the "Line Config" dialog box, select the "View Filter" option: "Show Compatible".

All stored limit lines with the file extension `.LIN` in the `limits` subfolder of the main installation folder of the instrument that are compatible to the current measurement settings are displayed in the overview.

### How to activate and deactivate a limit check

A limit check is automatically performed as soon as any of the limit lines is activated.

1. To activate a limit check:  
Select the "Check Traces" setting for a limit line in the overview and select the trace numbers to be included in the limit check. One limit line can be assigned to several traces.  
The specified traces to be checked are compared with the active limit lines. The status of the limit check is indicated in the diagram.
2. To deactivate a limit line, deactivate all "Traces to be Checked" for it.  
To deactivate all limit lines at once, select "Disable All Lines".  
The limit checks for the deactivated limit lines are stopped and the results are removed from the display.

### How to edit existing limit lines

Existing limit line configurations can be edited.

1. In the "Line Config" dialog box, select the limit line.
2. Select "Edit".
3. Edit the line configuration as described in ["How to configure a new limit line"](#) on page 606.
4. Save the new configuration by selecting "Save".  
If the limit line is active, the edited limit line is displayed in the diagram.

### How to copy an existing limit line

1. In the dialog box, select the limit line.
2. Select "Line Config" "Copy To".
3. Define a new name to create a new limit with the same configuration as the source line.
4. Edit the line configuration as described in ["How to configure a new limit line"](#) on page 606.
5. Save the new configuration by selecting "Save".  
The new limit line is displayed in the overview and can be activated.

### How to delete an existing limit line

1. In the "Line Config" dialog box, select the limit line.
2. Select "Delete".
3. Confirm the message.  
The limit line and the results of the limit check are deleted.

### How to configure a new limit line

1. In the "Line Config" dialog box, select "New".

The "Edit Limit Line" dialog box is displayed. The current line configuration is displayed in the preview area of the dialog box. The preview is updated after each change to the configuration.
2. Define a "Name" and, optionally, a "Comment" for the new limit line.
3. Define the x-axis configuration:
  - Time domain or frequency domain
  - Absolute or relative limits
  - Linear or logarithmic scaling
4. Define the y-axis configuration:
  - Level unit
  - Absolute or relative limits
  - Upper or lower limit line
5. Define the data points: minimum 2, maximum 200:
  - a) Select "Insert Value".
  - b) Define the x-value ("Position") and y-value ("Value") of the first data point.
  - c) Select "Insert Value" again and define the second data point.
  - d) Repeat this to insert all other data points.

To insert a data point before an existing one, select the data point and then "Insert Value".

To insert a new data point at the end of the list, move the focus to the line after the last entry and then select "Insert Value".

To delete a data point, select the entry and then "Delete Value".
6. Check the current line configuration in the preview area of the dialog box. If necessary, correct individual data points or add or delete some.

If necessary, shift the entire line vertically or horizontally by selecting "Shift x" or "Shift y" and defining the shift width.
7. Optionally, define a "Margin" at a fixed distance to the limit line.

The margin must be within the valid value range and is not displayed in the diagram or preview area.
8. Optionally, if the y-axis uses relative scaling, define an absolute "Threshold" as an additional criteria for a violation.
9. Save the new configuration by selecting "Save".

The new limit line is displayed in the overview and can be activated.

### How to move the limit line vertically or horizontally

A configured limit line can easily be moved vertically or horizontally. Thus, a new limit line can be easily generated based upon an existing limit line which has been shifted horizontally.

1. In the "Line Config" dialog box, select the limit line.
2. To shift the complete limit line parallel in the horizontal direction, select "X-Offset" and enter an offset value.  
To shift the complete limit line parallel in the vertical direction, select "Y-Offset" and enter an offset value.
3. To shift the individual data points of a limit line by a fixed value (all at once):
  - a) Select "Edit".
  - b) In the "Edit Limit Line" dialog box, select "Shift x" or "Shift y" and define the shift width.
  - c) Save the shifted data points by selecting "Save".

If activated, the limit line is shifted in the diagram.

### How to export a limit line

Limit line configurations can be stored to an ASCII file for evaluation in other programs or to be imported later for other measurements.

1. In the "Line Config" dialog box, select the limit line.
2. Select "New" or "Edit".
3. Define the limit line as described in ["How to configure a new limit line"](#) on page 606.
4. Select "Export" to save the configuration to a file.  
You are asked whether you would like to save the configuration internally on the FSW first.
5. Select a file name and location for the limit line.
6. Select the decimal separator to be used in the file.
7. Select "Save".

The limit line is stored to a file with the specified name and the extension `.CSV`.

For details on the file format see [Chapter 8.4.2.4, "Reference: limit line file format"](#), on page 608.

### How to import a limit line

Limit line configurations that are stored in an ASCII file and contain a minimum of required data can be imported to the FSW.

For details on the required file format see [Chapter 8.4.2.4, "Reference: limit line file format"](#), on page 608.

1. In the "Line Config" dialog box, select the limit line.

2. Select "New" or "Edit".
3. Select "Import" to load a limit line from a file.  
You are asked whether you would like to save the current configuration on the FSW first.
4. Select the file name of the limit line.
5. Select the decimal separator that was used in the file.
6. Select "Select".  
The limit line is loaded from the specified file and displayed in the "Edit Limit Line" dialog box.
7. Activate the limit line as described in ["How to activate and deactivate a limit check"](#) on page 605.

#### 8.4.2.4 Reference: limit line file format

Limit line data can be exported to a file in ASCII (CSV) format for further evaluation in other applications. Limit lines stored in the specified ASCII (CSV) format can also be imported to the FSW for other measurements (see ["How to import a limit line"](#) on page 607). This reference describes in detail the format of the export/import files for limit lines. Note that the **bold** data is **mandatory**, all other data is optional.

Different language versions of evaluation programs may require a different handling of the decimal point. Thus, you can define the decimal separator to be used (see ["Decimal Separator"](#) on page 652).

**Table 8-2: ASCII file format for limit line files**

File contents	Description
<b>Header data</b>	
<b>sep=;</b>	Separator for individual values (required by Microsoft Excel, for example)
<b>Type</b> ;RS_LimitLineDefinition;	Type of data
<b>FileFormatVersion</b> ;1.00;	File format version
Date;01.Oct 2006;	Date of data set storage
OptionID;SpectrumAnalyzer	Application the limit line was created for
<b>Name</b> ;RELFREQ1	Limit line name
Comment;Defines the upper limit line	Description of limit line
Mode;UPPER	Type of limit line (upper, lower)
ThresholdUnit;LEVEL_DBM	Unit of threshold value
ThresholdValue;-200	Threshold value
MarginValue;0	Margin value
XAxisScaling;LINEAR	Scaling of x-axis linear (LIN) or logarithmic (LOG)



File contents	Description
XAxisUnit;FREQ_HZ	Unit of x values
XAxisScaleMode;ABSOLUTE	Scaling of x-axis (absolute or relative)
YAxisUnit;LEVEL_DB	Unit of y values
YAxisScaleMode;ABSOLUTE	Scaling of y-axis (absolute or relative)
NoOfPoints;5	Number of points the line is defined by
<b>Data section for individual data points</b>	
-4500000000;-50	<b>x- and y-values of each data point defining the line</b>
-2000000000;-30	
-1000000000;0	
0;-30	
2500000000;-50	

## 8.5 Trace configuration

A trace is a collection of measured data points. The trace settings determine how the measured data is analyzed and displayed on the screen.

- [Standard traces](#).....609
- [Spectrograms](#).....629
- [Trace math](#).....646

### 8.5.1 Standard traces

#### 8.5.1.1 Basics on setting up traces

Some background knowledge on traces is provided here for a better understanding of the required configuration settings.

- [Mapping samples to sweep points with the trace detector](#).....609
- [X-value of the sweep point](#).....617
- [Analyzing several traces - trace mode](#).....618
- [How many traces are averaged - sweep count + Sweep mode](#).....619
- [How trace data is averaged - the averaging mode](#).....620
- [Trace smoothing](#).....621

#### **Mapping samples to sweep points with the trace detector**

A trace displays the values measured at the measurement points (also known as sweep points in some applications). However, the number of samples taken during a measurement can be much larger than the number of measurement points that are displayed in the measurement trace.



### Auto detector

If the FSW is set to define the appropriate detector automatically, the detector is set depending on the selected trace mode and average mode:

Trace mode	Detector
"Clear Write"	Auto peak
"Max Hold"	Positive peak
"Min Hold"	Negative peak
"Average"	Sample peak (for average mode "Power": RMS)
"View"	–
"Blank"	–



The detector activated for the specific trace is indicated in the corresponding trace information by an abbreviation. Not all detector types are supported by all applications available for the FSW.

**Table 8-3: Detector types**

Detector	Abbrev.
Positive peak	"Pk"
Negative peak	"Mi"
Auto peak	"Ap"
RMS	"Rm"
Average	"Av"

### EMI measurement detectors

Some additional detectors are available if the EMI (R&S FSW-K54) measurement option is installed. However, the EMI measurement need not be active. The additional detectors are especially designed for and required by EMI applications.

**Table 8-4: Detector types**

Detector	Abbrev.
Quasi Peak	"QP"
CISPR Average detector	"CISPR AV"
RMS Average detector	"RMS AV"

### Measurement time

The measurement time defines how long the FSW measures the signal at the individual frequencies. Each detector needs a different period of time to fully charge and dis-

charge; the individual requirements on the measurement time are described for each detector.

• Positive peak (max peak) and negative peak (min peak) detector.....	612
• Auto peak detector.....	612
• RMS detector.....	612
• Average detector.....	613
• Sample detector.....	614
• Quasipeak detector.....	614
• CISPR average detector.....	615
• RMS average detector.....	616

### Positive peak (max peak) and negative peak (min peak) detector

The positive (maximum) detector determines the largest of all positive peak values measured at the individual measurement points which are combined in one sample point.

The negative (minimum) peak detector determines the smallest of all negative peak values measured at the individual measurement points which are combined in one sample point.

Tips regarding measurement time:

- For unmodulated signals, you can use the shortest possible measurement time.
- For pulsed signals, measurement time must be longer than the expected pulse length, that is: it must cover at least one pulse.

### Auto peak detector

The auto peak detector combines the "Positive peak (max peak) and negative peak (min peak) detector" on page 612. The maximum and the minimum values determined for each sample point are displayed.

Available in the spectrum application, but not for the Spectrum Emission Mask measurement.

### RMS detector

The RMS detector calculates the root mean square of all samples combined in a sweep point. The whole IF envelope is used to calculate the power for each measurement point. The IF envelope is digitized using a sample rate which is at least five times the selected resolution bandwidth. Based on the sample values, the power is calculated for each measurement point using the following formula:

$$P_{RMS} = \frac{U_{RMS}^2}{R} = \frac{\left( \sqrt{\frac{1}{N} * \sum_{i=1}^N S_i} \right)^2}{R} = \frac{1}{N * R} * \sum_{i=1}^N S_i^2$$

Where:

- $P_{RMS}$  = power represented by a measurement point
- $N$  = number of A/D converter values (samples) per measurement point

- R = electrical impedance
- $s_i$  = linear digitized video voltage at the output of the A/D converter

For logarithmic scaling, after the power has been calculated, the power units are converted into decibels and the value is displayed as a measurement point.

$$P(dBm) = 30dBm + 10 \cdot \log_{10} \cdot P_{RMS} = 30dBm + 10 \cdot \log_{10} \left( \frac{1}{N \cdot R} * \sum_{i=1}^N s_i^2 \right)$$

Where:

- P (dB) = logarithmic power represented by a measurement point

Each sweep point thus corresponds to the root mean square of the measured values combined in the sweep point.

The RMS detector supplies the power of the signal irrespective of the waveform (CW carrier, modulated carrier, white noise or impulsive signal). Correction factors as needed for other detectors to measure the power of the different signal classes are not required.

Tips regarding measurement time:

- For unmodulated signals, you can use the shortest possible measurement time.
- For modulated signals, the measurement time must be long enough to make sure the averaging considers all variations due to the modulation characteristics of the signal.
- For pulsed signals, the measurement time must be long enough to capture a sufficient number of pulses. For averaging, a sufficient number of pulses is greater than 10.



#### The RMS detector and the video bandwidth

When using the RMS detector in the Spectrum application, the video bandwidth (VBW) in the hardware is bypassed. However, if the measurement time is determined automatically, the VBW is still considered. The measurement time is then set to the minimum time required by the current VBW setting. Thus, a similar averaging effect is achieved, while providing a correct RMS power result.

Video filtering together with the RMS detector would result in logarithmic averaging.

#### Average detector

The average detector calculates the linear average of all samples combined in a sweep point.

For average detection, the video voltage (envelope of IF signal) is averaged over the measurement time. Averaging is digital, i.e. the digitized values of the video voltage are summed up and divided by the number of samples at the end of the measurement time. This corresponds to a filtering with a rectangular window in the time domain and a filtering with  $\sin x/x$  characteristic in the frequency domain.

To this effect, FSW uses the linear voltage after envelope detection. The sampled linear values are summed up and the sum is divided by the number of samples (= linear average value). For linear display, the average value is displayed.

$$P_{Avg} = \frac{U_{Avg}^2}{R} = \frac{1}{R} * \left( \frac{1}{N} * \sum_{i=1}^N s_i \right)^2$$

Where:

- $P_{AVG}$  = power represented by a measurement point
- $N$  = number of A/D converter values per measurement point
- $R$  = electrical impedance
- $s_i$  = linear digitized video voltage at the output of the A/D converter

For logarithmic scaling, after the power has been calculated, the power units are converted into decibels, and the value is displayed as a measurement point.

$$P(dBm) = 30dBm + 10 \cdot \log_{10} \cdot P_{Avg} = 30dBm + 10 \cdot \log_{10} \left( \frac{1}{R} * \left( \frac{1}{N} * \sum_{i=1}^N s_i \right)^2 \right)$$

Where:

- $P$  (dBm) = logarithmic power represented by a measurement point

Each measurement point thus corresponds to the average of the measured values combined in the measurement point.

The average detector supplies the average value of the signal irrespective of the waveform (CW carrier, modulated carrier, white noise or impulsive signal).

Tips regarding measurement time:

- For unmodulated signals, you can use the shortest possible measurement time.
- For modulated signals, the measurement time must be long enough to make sure the averaging considers all variations due to the modulation characteristics of the signal.
- For pulsed signals, the measurement time must be long enough to capture a sufficient number of pulses. For averaging, a sufficient number of pulses is greater than 10.

### Sample detector

The sample detector selects and displays a single sample (always the first or always the last) from all samples that are combined in the sweep point. All other measured values for the sample point are ignored.

### Quasipeak detector

The quasipeak detector resembles the behavior of an analog voltmeter by analyzing the measured values for a sample point. The quasipeak detector is especially designed for the requirements of EMI measurements and is used to analyze pulse-shaped spurs.

This detector is only available for the CISPR filter.

It requires the R&S FSW EMI measurement option (K54) to be installed.

The quasipeak detector is not available for an RBW of 1 MHz.

The quasipeak detector displays the weighted maximum signal level according to CISPR 16-1-1 that was detected during the specified measurement time.

The filter bandwidth and time parameters of the detector depend on the measured frequency. The time lag of the simulated pointer instrument reflects the weighting factor of the signal depending on its form, modulation, etc.

**Table 8-5: Required parameters depending on frequency for CISPR quasi-peak detector**

	Band A	Band B	Band C/D
Frequency range	< 150 kHz	150 kHz to 30 MHz	> 30 MHz
Resolution bandwidth	200 Hz	9 kHz	120 kHz

Tips regarding measurement time:

- The relatively long time constants of the quasipeak detector result in long measurement times to yield valid results.
- For unknown signals, use a measurement time of at least 1 s. This ensures correct weighting of pulses down to a pulse frequency of 5 Hz.
- For known signals, you can use a much shorter measurement time.

When you change the frequency or the attenuation, the FSW waits until the lowpass filter has settled before starting the measurement. Since the level does not change during a frequency scan, known signals (e.g. broadband RFI) can be measured correctly with a much shorter measurement time.

### CISPR average detector

The CISPR Average detector displays a weighted average signal level according to CISPR 16-1-1.

The average value according to CISPR 16-1-1 is the maximum value detected while calculating the linear average value during the specified measurement time.

This detector is only available for the CISPR filter.

It requires the R&S FSW EMI measurement option (K54) to be installed.

The CISPR Average detector is applied to measure pulsed sinusoidal signals with a low pulse frequency, for example. It is calibrated with the RMS value of an unmodulated sinusoidal signal. The average value is determined by lowpass filters of the 2nd order (simulating a mechanical pointer instrument).

The lowpass time constants and the IF bandwidths depend on the measured frequency. The main parameters are listed in the following table:

**Table 8-6: Required parameters depending on frequency for CISPR Average detector**

	Band A	Band B	Band C/D	Band E
Frequency range	<150 kHz	150 kHz to 30 MHz	30 MHz to 1 GHz	>1 GHz
IF bandwidth	200 Hz	9 kHz	120 kHz	1 MHz

Tips regarding measurement time:

- The relatively long time constants of the CISPR average detector result in long measurement times to yield valid results.
- For unknown signals, use a measurement time of at least 1 s. This ensures correct weighting of pulses down to a pulse frequency of 5 Hz.
- For unmodulated sinusoidal signals and signals with a high modulation frequency, you can use a much shorter measurement time.
- For slowly fluctuating signals or pulsed signals, use longer measurement times.

When you change the frequency or the attenuation, the FSW waits until the lowpass filter has settled before starting the measurement. In this case, the measurement time depends on the resolution bandwidth and the characteristics of the signal.

### RMS average detector

The RMS Average detector is a combination of the RMS detector (for pulse repetition frequencies above a corner frequency) and the Average detector (for pulse repetition frequencies below the corner frequency). It thus achieves a pulse response curve with the following characteristics:

- 10 dB/decade above the corner frequency
- 20 dB/decade below the corner frequency

The average value is determined by lowpass filters of the 2nd order (simulation of a mechanical pointer instrument).

The RMS Average detector is only available for the CISPR filter.

It requires the R&S FSW EMI measurement option (K54) to be installed.

The detector is used to measure broadband emissions, for example, and can possibly replace the quasipeak detector in the future.

The detector parameters depend on the measured frequency.

**Table 8-7: Required parameters depending on frequency for RMS Average detector**

	Band A	Band B	Band C/D	Band E
Frequency range	<150 kHz	150 kHz to 30 MHz	30 MHz to 1 GHz	>1 GHz
IF bandwidth	200 Hz	9 kHz	120 kHz	1 MHz
Corner frequency	10 Hz	100 Hz	100 Hz	1 kHz

Tips regarding measurement time:

- The relatively long time constants of the CISPR average detector result in long measurement times to yield valid results.
- For unknown signals, use a measurement time of at least 1 s. This ensures correct weighting of pulses down to a pulse frequency of 5 Hz.
- For unmodulated sinusoidal signals and signals with a high modulation frequency, you can use a much shorter measurement time.
- For slowly fluctuating signals or pulsed signals, use longer measurement times.



When you change the frequency or the attenuation, the FSW waits until the lowpass filter has settled before starting the measurement. In this case, the measurement time depends on the resolution bandwidth and the characteristics of the signal.



### Measurement times shorter than 20 ms

With measurement times shorter than 20 ms, the detector weighting changes to plain RMS weighting.

### X-value of the sweep point

As described in "[Mapping samples to sweep points with the trace detector](#)" on page 609, the number of samples taken during a sweep can be much larger than the number of sweep points that are displayed in the measurement trace.

To determine the x-value of the sweep point, two different methods are available:

- Start/stop
- Bin-centered

#### Start/stop

This is the default (legacy) method for trace values in the frequency domain. The x-value of the first sweep point corresponds to the starting point of the full measurement span. The x-value of the last sweep point corresponds to the end point of the full measurement span. All other sweep points are divided evenly between the first and last points. The distance between two sweep points is  $\text{span}/(\text{no\_sweep\_points} - 1)$ .

#### Bin-centered

This is the default method for all marker values. The full measurement span is divided by the number of sweep points. The result is the span that is evaluated for an individual sweep point, also referred to as a *bin*. The x-value of the sweep point is then defined as the x-value at the center of the bin ( $\text{bin}/2$ ).

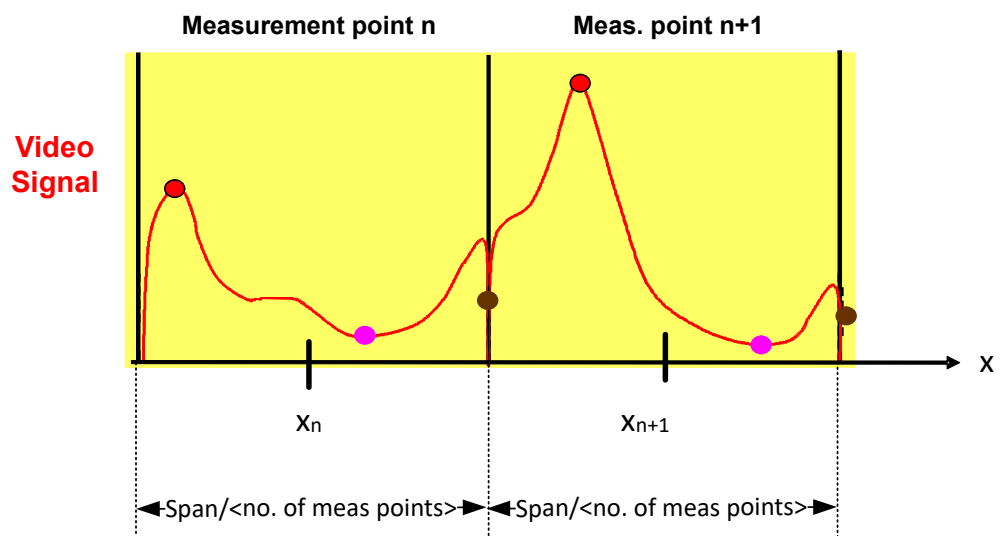

Using the bin-centered method, the first and last x-values of the trace are not identical to the exact starting and end point of the measurement span. The distance between two sweep points corresponds to the width of the bin, or  $\text{span}/(\text{no\_sweep\_points})$ .

Marker values are always determined using the bin-centered method. Markers placed on the first and last x-values of the measured span indicate the same results as the first and last trace point.

#### Example:

Assume the following measurement parameters:

- Start frequency: 1.000 GHz
- Stop frequency: 6.000 GHz
- => Span: 5 GHz
- sweep points: 1000
- =>bin: 5 MHz ( $\text{span}/\text{sweep points}$ )

The first trace point is displayed at  $(\text{<f}_{\text{start}} + \text{bin}/2) = 1.0025$  GHz.

The last trace point is displayed at  $(\text{<f}_{\text{stop}} - \text{bin}/2) = 5.9975$  GHz.

A marker placed at 1.000 GHz indicates the same result as a marker placed at 1.0025 GHz, since no other value is available.

For trace values in the frequency domain, you can select which method is used to determine the x-values in the frequency domain, that is:

- In the result displays
- When exporting traces
- For the `TRACe<n>[:DATA]:X?` command

See "[X-Value Distribution](#)" on page 652.

Note the possible minor discrepancy between marker values and trace values using the start/stop method.

#### Analyzing several traces - trace mode

If several sweeps are performed one after the other, or continuous sweeps are performed, the trace mode determines how the data for subsequent traces is processed. After each sweep, the trace mode determines whether:

- The data is frozen ("View")
- The data is hidden ("Blank")
- The data is replaced by new values ("Clear Write")
- The data is replaced selectively ("Max Hold", "Min Hold", "Average")



Each time you change the trace mode, the selected trace memory is cleared.

The trace mode also determines the detector type if the detector is set automatically, see "[Mapping samples to sweep points with the trace detector](#)" on page 609.

The FSW supports the following trace modes:

**Table 8-8: Overview of available trace modes**

Trace Mode	Description
Blank	Hides the selected trace.
Clear Write	Overwrite mode: the trace is overwritten by each sweep. This is the default setting. All available detectors can be selected.
Max Hold	The maximum value is determined over several measurements and displayed. The FSW saves the sweep result in the trace memory only if the new value is greater than the previous one.  This mode is especially useful with modulated or pulsed signals. The signal spectrum is filled up upon each sweep until all signal components are detected in a kind of envelope.  This mode is not available for statistics measurements.
Min Hold	The minimum value is determined from several measurements and displayed. The FSW saves the sweep result in the trace memory only if the new value is lower than the previous one.  This mode is useful for example for making an unmodulated carrier in a composite signal visible. Noise, interference signals or modulated signals are suppressed, whereas a CW signal is recognized by its constant level.  This mode is not available for statistics measurements.
Average	The average is formed over several measurements and displayed. The <a href="#">Sweep/Average Count</a> determines the number of averaging procedures. This mode is not available for statistics measurements.
View	The current contents of the trace memory are frozen and displayed.



If a trace is frozen ("View" mode), you can change the measurement settings, apart from scaling settings, without impact on the displayed trace. The fact that the displayed trace no longer matches the current measurement settings is indicated by a yellow asterisk  on the tab label.

If you change any parameters that affect the scaling of the diagram axes, the FSW automatically adapts the trace data to the changed display range. Thus, you can zoom into the diagram after the measurement to show details of the trace.

### How many traces are averaged - sweep count + Sweep mode

In "Average" trace mode, the sweep count and sweep mode determine how many traces are averaged. The more traces are averaged, the smoother the trace is likely to become.

The algorithm for averaging traces depends on the sweep mode and sweep count.

- **sweep count = 0** (default)
  - In "**Continuous**" sweep mode, a continuous average is calculated for 10 sweeps, according to the following formula:

$$Trace = \frac{9 * Trace_{old} + MeasValue}{10}$$

**Figure 8-11: Equation 1**

Due to the weighting between the current trace and the average trace, past values have practically no influence on the displayed trace after about ten sweeps. With this setting, signal noise is effectively reduced without need for restarting the averaging process after a change of the signal.

- In **"Single"** sweep mode, the current trace is averaged with the previously stored averaged trace. No averaging is carried out for the first sweep but the measured value is stored in the trace memory. The next time a sweep is performed, the trace average is calculated according to the following formula:

$$Trace = \frac{Trace_{old} + MeasValue}{2}$$

The averaged trace is then stored in the trace memory.

- **sweep count = 1**

The currently measured trace is displayed and stored in the trace memory. No averaging is performed.

- **sweep count > 1**

For both **"Single"** sweep mode and **"Continuous"** sweep mode, averaging takes place over the selected number of sweeps. In this case the displayed trace is determined during averaging according to the following formula:

$$Trace_n = \frac{1}{n} \cdot \left[ \sum_{i=1}^{n-1} (T_i) + MeasValue_n \right]$$

**Figure 8-12: Equation 2**

Where n is the number of the current sweep (n = 2 ... sweep count).

No averaging is carried out for the first sweep but the measured value is stored in the trace memory. With increasing n, the displayed trace is increasingly smoothed since there are more individual sweeps for averaging.

After the selected number of sweeps, the average trace is saved in the trace memory. Until this number of sweeps is reached, a preliminary average is displayed. When the averaging length defined by the "Sweep Count" is attained, averaging is continued in continuous sweep mode or for "Continue Single Sweep" according to the following formula:

$$Trace = \frac{(N-1) * Trace_{old} + MeasValue}{N}$$

Where N is the sweep count

### How trace data is averaged - the averaging mode

When the trace is averaged over several sweeps (Trace mode: "Average"), different methods are available to determine the trace average.

With logarithmic averaging, the dB values of the display voltage are averaged or subtracted from each other with trace mathematical functions.

With linear averaging, the level values in dB are converted into linear voltages or powers before averaging. Voltage or power values are averaged or offset against each other and reconverted into level values.

For stationary signals, the two methods yield the same result.

Logarithmic averaging is recommended if sinewave signals are to be clearly visible against noise since with this type of averaging noise suppression is improved while the sinewave signals remain unchanged.

For noise or pseudo-noise signals, the positive peak amplitudes are decreased in logarithmic averaging due to the characteristic involved. The negative peak values are increased relative to the average value. If the distorted amplitude distribution is averaged, a value is obtained that is smaller than the actual average value. The difference is -2.5 dB.

This low average value is usually corrected in noise power measurements by a 2.5 dB factor. Therefore the FSW offers the selection of linear averaging. The trace data is linearized before averaging, then averaged and logarithmized again for display on the screen. The average value is always displayed correctly irrespective of the signal characteristic.

### Trace smoothing

A video bandwidth filter (VBW) is a hardware-based method of smoothing the trace (see also [Chapter 7.5.1.2, "Smoothing the trace using the video bandwidth"](#), on page 493). However, other sweep and bandwidth settings can be coupled to the VBW. For some signals, a VBW may not be freely selectable to obtain the required smoothing effect. Therefore, a software-based trace smoothing function is also available.

(Software-based) **smoothing** is a way to remove anomalies visually in the trace that can distort the results. The smoothing process is based on a moving average over the complete measurement range. The number of samples included in the averaging process (the *aperture size*) is variable and is a percentage of all samples that the trace consists of.

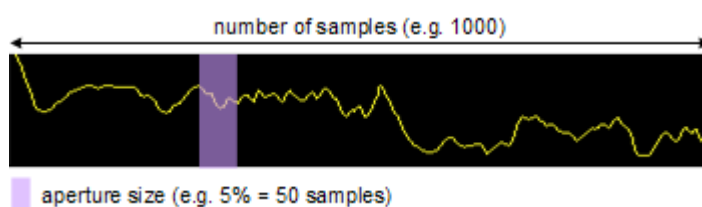

Figure 8-13: Sample size included in trace smoothing



### Effects of smoothing on post-processing functions

Note that in Spectrum mode, all functions performed after the sweep, such as limit checks, markers, or channel power measurements, are based on the smoothed trace data. Thus, the results differ from results based on the original trace.

You can turn trace smoothing on and off for all traces individually and compare, for example, the raw and the smooth trace.

Linear smoothing is based on the following algorithm:

$$y'(s) = \frac{1}{n} \left( \sum_{x=s-\frac{n-1}{2}}^{x=s+\frac{n-1}{2}} y(x) \right)$$

**Equation 8-1: Linear trace smoothing**

With:

s = sample number

x = sample offset from s

n = aperture size

### 8.5.1.2 Trace settings

**Access:** "Overview" > "Analysis" > "Traces"

Or: [TRACE] > "Trace Config"

You can configure the settings for up to 6 individual traces in the same result display. Each trace is displayed in a different color, indicated in the window title bar and the trace settings.

For settings on spectrograms, see [Chapter 8.5.2.2, "Spectrogram settings"](#), on page 637.



Trace data can also be exported to an ASCII file for further analysis. For details see [Chapter 8.6.2, "Trace/data ex/import"](#), on page 650.

Trace	Mode	Detector		Smoothing			Average
		Auto	Type	Hold	State	Value	
Trace 1	Clear Write	<input checked="" type="checkbox"/>	Auto Peak	<input type="checkbox"/>	<input type="checkbox"/>	2 %	Linear
Trace 2	Max Hold	<input checked="" type="checkbox"/>	Positive Peak	<input type="checkbox"/>	<input type="checkbox"/>	2 %	Logarithmic
Trace 3	Blank	<input checked="" type="checkbox"/>	Auto Peak	<input type="checkbox"/>	<input type="checkbox"/>	2 %	Power
Trace 4	Blank	<input checked="" type="checkbox"/>	Auto Peak	<input type="checkbox"/>	<input type="checkbox"/>	2 %	
Trace 5	Blank	<input checked="" type="checkbox"/>	Auto Peak	<input type="checkbox"/>	<input type="checkbox"/>	2 %	
Trace 6	Blank	<input checked="" type="checkbox"/>	Auto Peak	<input type="checkbox"/>	<input type="checkbox"/>	2 %	

Count: 0

Quick Config

Preset All Traces      Set Trace Mode Max | Avg | Min      Set Trace Mode Max | ClrWrite | Min

Trace 1/Trace 2/Trace 3/Trace 4/Trace 5/Trace 6.....	623
Trace Mode.....	623
Detector.....	624
Hold.....	624
Smoothing.....	625
Average Mode.....	625
Average Count.....	625
Predefined Trace Settings - Quick Config.....	626
Trace 1/ Trace 2/ Trace 3/ Trace 4 (Softkeys).....	626
Copy Trace.....	627
Trace Labels.....	627

### Trace 1/Trace 2/Trace 3/Trace 4/Trace 5/Trace 6

Selects the corresponding trace for configuration. The currently selected trace is highlighted.

For details see [Chapter 8.5.1.3, "How to configure a standard trace"](#), on page 628.

Remote command:

Selected via numeric suffix of:TRACe<1...6> commands

DISPlay[:WINDow<n>][:SUBWindow<w>]:TRACe<t>[:STATe] on page 1243

### Trace Mode

Defines the update mode for subsequent traces.

For details, see ["Analyzing several traces - trace mode"](#) on page 618.

"Clear/ Write"	<p>Overwrite mode (default): the trace is overwritten by each sweep. All available detectors can be selected. In Spectrum mode, the "Detector" is automatically set to "Auto Peak".</p>
"Max Hold"	<p>The maximum value is determined over several measurements and displayed. The FSW saves the sweep result in the trace memory only if the new value is greater than the previous one. This mode is especially useful with modulated or pulsed signals. The signal spectrum is filled up upon each sweep until all signal components are detected in a kind of envelope. The "Detector" is automatically set to "PositivePeak". This mode is not available for statistics measurements.</p>
"Min Hold"	<p>The minimum value is determined from several measurements and displayed. The FSW saves the sweep result in the trace memory only if the new value is lower than the previous one. This mode is useful for example for making an unmodulated carrier in a composite signal visible. Noise, interference signals or modulated signals are suppressed, whereas a CW signal is recognized by its constant level. The "Detector" is automatically set to "Negative Peak". This mode is not available for statistics measurements.</p>
"Average"	<p>The average is formed over several sweeps. The <a href="#">Sweep/Average Count</a> determines the number of averaging procedures. The "Detector" is automatically set to "Sample". This mode is not available for statistics measurements.</p>

"View" The current contents of the trace memory are frozen and displayed.

**Note:** If a trace is frozen, you can change the measurement settings, apart from scaling settings, without impact on the displayed trace. The fact that the displayed trace no longer matches the current measurement settings is indicated by a yellow asterisk  on the tab label. If you change any parameters that affect the scaling of the diagram axes, the FSW automatically adapts the trace data to the changed display range. Thus, you can zoom into the diagram after the measurement to show details of the trace.

"Blank" Removes the selected trace from the display.

Remote command:

`DISPlay[:WINDow<n>][:SUBWindow<w>]:TRACe<t>:MODE` on page 1241

### Detector

Defines the trace detector to be used for trace analysis.

For details see ["Mapping samples to sweep points with the trace detector"](#) on page 609.

**Note:** For EMI measurements, the trace detector is used for the initial peak search only, not for the final test. The detector for the final test is configured in the EMI marker settings, see [Chapter 6.13.4.1, "EMI marker configuration"](#), on page 341.

"Auto" (default:) Selects the optimum detector for the selected trace and filter mode

"Type" Defines the selected detector type.

**Note:** If the EMI (R&S FSW-K54) measurement option is installed, additional detectors are available, even if EMI measurement is not active. If you select a CISPR trace detector, the RBW filter type is automatically also set to CISPR.

CISPR detectors are only available under the following conditions:

- Time domain measurements and frequency measurements in sweep mode (not FFT mode, not power measurements, emission measurements, or statistics measurements)

For details and further restrictions, see [Chapter 6.13.3.2, "Detectors and dwell time"](#), on page 336.

Remote command:

`[SENSe:] [WINDow<n>:] DETector<t> [:FUNCTION]` on page 1246

`[SENSe:] [WINDow<n>:] DETector<t> [:FUNCTION]:AUTO` on page 1247

### Hold

If activated, traces in "Min Hold", "Max Hold" and "Average" mode are not reset after specific parameter changes have been made.

Normally, the measurement is started again after parameter changes, before the measurement results are analyzed (e.g. using a marker). In all cases that require a new measurement after parameter changes, the trace is reset automatically to avoid false results (e.g. with span changes). For applications that require no reset after parameter changes, the automatic reset can be switched off.

The default setting is off.



Remote command:

`DISPlay[:WINDow<n>][:SUBWindow<w>]:TRACe<t>:MODE:HCONTinuous`  
on page 1242

### Smoothing

If enabled, the trace is smoothed by the specified value (between 1 % and 50 %). The smoothing value is defined as a percentage of the display width. The larger the smoothing value, the greater the smoothing effect.

**Note:** Effects of smoothing on post-processing functions. Note that in Spectrum mode, all functions performed after the sweep, such as limit checks, markers, or channel power measurements, are based on the smoothed trace data. Thus, the results differ from results based on the original trace.

For more information, see ["Trace smoothing"](#) on page 621.

Remote command:

`DISPlay[:WINDow<n>][:SUBWindow<w>]:TRACe<t>:SMOothing[:STATe]`  
on page 1244

`DISPlay[:WINDow<n>][:SUBWindow<w>]:TRACe<t>:SMOothing:APERture`  
on page 1244

### Average Mode

Defines the mode with which the trace is averaged over several sweeps.

This setting is generally applicable if trace mode "Average" is selected.

For FFT sweeps, the setting also affects the VBW (regardless of whether the trace is averaged).

(See also ["Video bandwidth \(VBW\)"](#) on page 158).

How many sweeps are averaged is defined by the ["Sweep/Average Count"](#) on page 504.

For details see ["How trace data is averaged - the averaging mode"](#) on page 620.

"Linear"	The power level values are converted into linear units before averaging. After the averaging, the data is converted back into its original unit.
"Logarithmic"	For logarithmic scaling, the values are averaged in dBm. For linear scaling, the behavior is the same as with linear averaging.
"Power"	Activates linear power averaging. The power level values are converted into unit Watt before averaging. After the averaging, the data is converted back into its original unit. Use this mode to average power values in Volts or Amperes correctly. In particular, for small VBW values (smaller than the RBW), use power averaging mode for correct power measurements in FFT sweep mode.

Remote command:

`[SENSe:]AVERAge<n>:TYPE` on page 1245

### Average Count

Determines the number of averaging or maximum search procedures If the trace modes "Average", "Max Hold" or "Min Hold" are set.

In continuous sweep mode, if sweep count = 0 (default), averaging is performed over 10 sweeps. For sweep count = 1, no averaging, Max Hold or Min Hold operations are performed.

This value is identical to the [Sweep/Average Count](#) setting in the "Sweep" settings.

Remote command:

[\[SENSe:\]AVERAge<n>:COUNT](#) on page 1245

### Predefined Trace Settings - Quick Config

Commonly required trace settings have been predefined and can be applied very quickly by selecting the appropriate button.

Function	Trace Settings	
Preset All Traces	Trace 1:	Clear Write Auto Detector (Auto Peak)
	Traces 2-6:	Blank Auto Detector
Set Trace Mode Max   Avg   Min	Trace 1:	Max Hold Auto Detector (Positive Peak)
	Trace 2:	Average Auto Detector (Sample)
	Trace 3:	Min Hold Auto Detector (Negative Peak)
	Traces 4-6:	Blank Auto Detector
Set Trace Mode Max   ClrWrite   Min	Trace 1:	Max Hold Auto Detector (Positive Peak)
	Trace 2:	Clear Write Auto Detector (Auto Peak)
	Trace 3:	Min Hold Auto Detector (Negative Peak)
	Traces 4-6:	Blank Auto Detector

Remote command:

[DISPlay\[:WINDow<n>\]\[:SUBWindow<w>\]:TRACe<t>:PRESet](#) on page 1243

### Trace 1/ Trace 2/ Trace 3/ Trace 4 (Softkeys)

Displays the "Traces" settings and focuses the "Mode" list for the selected trace.

For details see [Chapter 8.5.1.3, "How to configure a standard trace"](#), on page 628.

Remote command:

[DISPlay\[:WINDow<n>\]\[:SUBWindow<w>\]:TRACe<t>\[:STATe\]](#) on page 1243

### Copy Trace

**Access:** "Overview" > "Analysis" > "Traces" > "Copy Trace"

**Or:** [TRACE] > "Copy Trace"

Copies trace data to another trace.

The first group of buttons (labeled "Trace 1" to "Trace 6") selects the source trace. The second group of buttons (labeled "Copy to Trace 1" to "Copy to Trace 6") selects the destination.

Remote command:

[TRACe<n>:COPY](#) on page 1247

### Trace Labels

**Access:** "Overview" > "Analysis" > "Traces" > "Trace Label" tab

You can define a descriptive label to active traces instead of the default "Trace <x>" label.

**Note:** This function is not available in all applications.

The labels are displayed in the diagram area. The font color corresponds to the color of the particular trace (for example, yellow trace: yellow font).

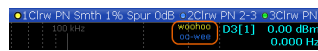

*Figure 8-14: Example: the yellow and blue traces have a label*

You can move the trace label to any position on the display by dragging it to the new position.

You can only configure labels for active traces and for traces whose "State" is enabled.

Traces	Export / Import	Copy Trace	Trace Math	Trace Label
	State		Text	
Trace 1	<input type="checkbox"/>			Trace 1
Trace 2	<input type="checkbox"/>			Trace 2
Trace 3	<input type="checkbox"/>			Trace 3
Trace 4	<input type="checkbox"/>			Trace 4
Trace 5	<input type="checkbox"/>			Trace 5
Trace 6	<input type="checkbox"/>			Trace 6

Enable the state and enter a trace label.

Remote command:

[DISPlay\[:WINDow<n>\]:TRACe<t>:LABel\[:STATE\]](#) on page 1240

[DISPlay\[:WINDow<n>\]:TRACe<t>:LABel:TEXT](#) on page 1241

### 8.5.1.3 How to configure a standard trace

Step-by-step instructions on configuring the trace settings are provided here.

For details on individual functions and settings see [Chapter 8.5.1.2, "Trace settings"](#), on page 622.

The remote commands required to perform these tasks are described in [Chapter 13.8.2, "Configuring the trace display and retrieving trace data"](#), on page 1239.

Trace settings are configured in the "Traces" dialog box.

To display the "Traces" dialog box, do one of the following:

- Press [TRACE] and then select "Trace Config".
  - Select "Analysis" from the "Overview", then select the "Traces" tab.
1. For each trace, select the "Trace Mode" and "Trace Detector". Traces with the trace mode "Blank" are not displayed.
  2. To configure several traces to predefined display modes in one step, press the button for the required function:
    - "Preset All Traces"
    - "Set Trace Mode Max | Avg | Min"
    - "Set Trace Mode Max | ClrWrite | Min"
  3. For "Average" trace mode, define the number of sweeps to be averaged in the "Count:" field.
  4. If linear scaling is used, select the "Average Mode": "Linear".
  5. To improve the trace stability, increase the number of "Sweep Points" or the "Sweep Time" (in the "Sweep" settings).

All configured traces (not set to "Blank") are displayed after the next sweep.

#### How to Copy Traces

1. A trace copy function is provided in a separate tab of the "Traces" dialog box. To display this tab do one of the following:
  - Select [TRACE] and then "Trace Copy".
  - Select "Analysis" from the "Overview", then select the "Trace Copy" tab.
2. Select the "Source" trace to be copied.
3. Select "Copy to Trace" for the trace to which the settings are to be applied.

The settings from the source trace are applied to the destination trace. The newly configured trace (if not set to "Blank") is displayed after the next sweep.

## 8.5.2 Spectrograms

### 8.5.2.1 Working with spectrograms

In addition to the standard "level versus frequency" or "level versus time" traces, the FSW also provides a spectrogram display of the measured data.

A spectrogram shows how the spectral density of a signal varies over time. The x-axis shows the frequency, the y-axis shows the time. A third dimension, the power level, is indicated by different colors. Thus you can see how the strength of the signal varies over time for different frequencies.



Three-dimensional spectrograms are also available and are described in "[Three-dimensional spectrograms](#)" on page 633. Most basic information described in the following sections applies similarly to both two- and three-dimensional spectrograms.

#### Example:

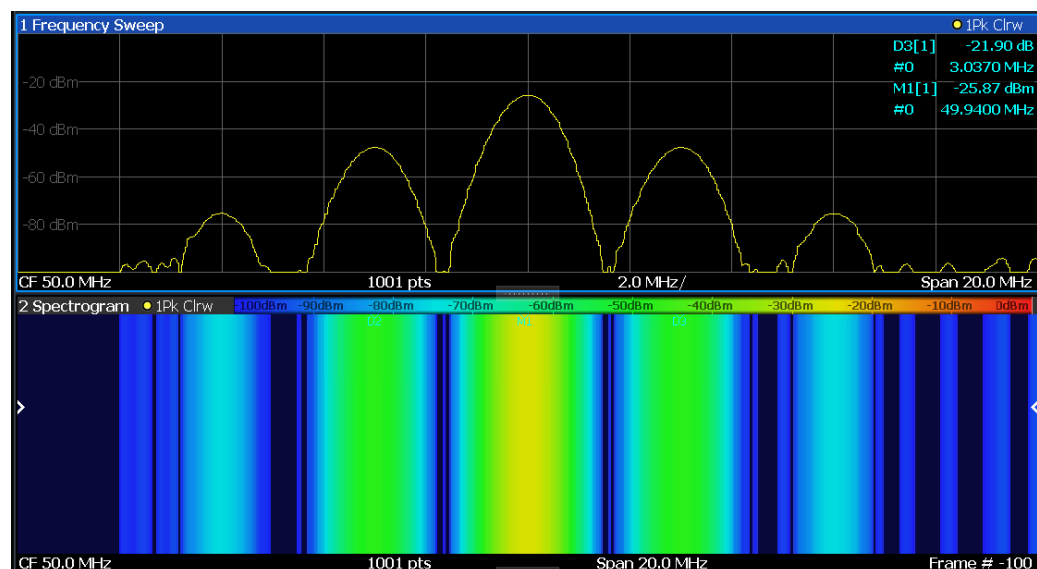

In this example, you see the spectrogram for the calibration signal of the FSW, compared to the standard spectrum display. Since the signal does not change over time, the color of the frequency levels does not change over time, i.e. vertically. The legend above the spectrogram display describes the power levels the colors represent.

#### Result display

The spectrogram result can consist of the following elements:

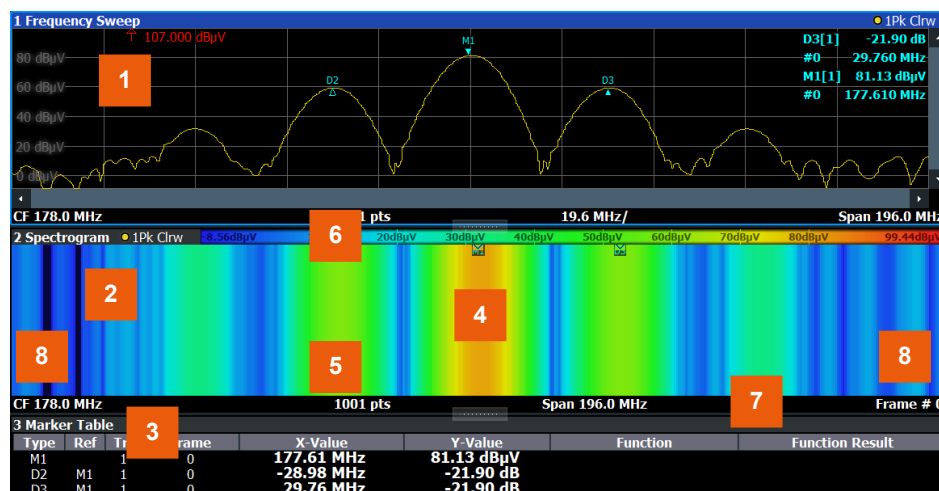

Figure 8-15: Screen layout of the spectrogram result display

- 1 = Spectrum result display
- 2 = Spectrogram result display
- 3 = Marker list
- 4 = Marker
- 5 = Delta marker
- 6 = Color map
- 7 = Timestamp / frame number
- 8 = Current frame indicator

For more information about spectrogram configuration, see [Chapter 8.5.2.2, "Spectrogram settings"](#), on page 637.

**Remote commands:**

Activating and configuring spectrograms:

[Chapter 13.8.2.2, "Configuring spectrograms"](#), on page 1248

Storing results:

[MMEMory:STORe<n>:SPECTrogram](#) on page 1374

- [Time frames](#)..... 630
- [Markers in the spectrogram](#)..... 632
- [Three-dimensional spectrograms](#).....633
- [Color maps](#).....634

**Time frames**

The time information in the spectrogram is displayed vertically, along the y-axis. Each line (or trace) of the y-axis represents one or more captured sweep and is called a **time frame** or simply "frame". As with standard spectrum traces, several measured values are combined in one sweep point using the selected detector.

(See ["Mapping samples to sweep points with the trace detector"](#) on page 609).

Frames are sorted in chronological order, beginning with the most recently recorded frame at the top of the diagram (frame number 0). With the next sweep, the previous frame is moved further down in the diagram, until the maximum number of captured frames is reached. The display is updated continuously during the measurement, and the measured trace data is stored. Spectrogram displays are continued even after single measurements unless they are cleared manually.



In three-dimensional spectrograms, frames are displayed vertically. The most recently recorded frame (frame 0) is added at the front of the display (in the default position). For more information, see "[Three-dimensional spectrograms](#)" on page 633.

The maximum number of frames that you can capture is summarized in [Table 8-9](#).

**Table 8-9: Correlation between number of sweep points and number of frames stored in the history buffer**

Sweep Points	Max. History Depth
≤1250	20000
2001	12488
4001	6247
8.001	3124
16.001	1562
32.001	781



The scaling of the time axis (y-axis) is not configurable. However, you can enlarge the spectrogram display by maximizing the window using "Split/Maximize".



### Frame analysis - Frame count vs. sweep count

As described for standard spectrum sweeps, the sweep count defines how many sweeps are analyzed to create a single trace. Thus, for a trace in "Average" mode, for example, a sweep count of 10 means that 10 sweeps are averaged to create a single trace, or frame.

The frame count, on the other hand, determines how many frames are plotted during a single sweep measurement (as opposed to a continuous sweep). For a frame count of 2, for example, 2 frames will be plotted during each single sweep. For continuous sweep mode, the frame count is irrelevant; one frame is plotted per sweep until the measurement is stopped.

If you combine the two settings, 20 sweeps will be performed for each single sweep measurement. The first 10 will be averaged to create the first frame, the next 10 will be averaged to create the second frame.

As you can see, increasing the sweep count increases the accuracy of the individual traces, while increasing the frame count increases the number of traces in the diagram.

Especially for "Average" or "Min Hold" and "Max Hold" trace modes, the number of sweeps that are analyzed to create a single trace has an effect on the accuracy of the results. Thus, you can also define whether the results from frames in previous traces are considered in the analysis for each new trace ("Continue Frame").

### Tracking absolute time - timestamps

Alternatively to the frame count, the absolute time (that is: a *timestamp*) at which a frame was captured can be displayed. While the measurement is running, the timestamp shows the system time. In single sweep mode or if the sweep is stopped, the timestamp shows the time and date at the end of the sweep. Thus, the individual frames can be identified by their timestamp or their frame count.

When active, the timestamp replaces the display of the frame number in the diagram footer (see [Figure 8-15](#)).

### Displaying individual frames

The spectrogram diagram contains all stored frames since it was last cleared. Arrows on the left and right border of the spectrogram indicate the currently selected frame. The spectrum diagram always displays the spectrum for the currently selected frame.

The current frame number is indicated in the diagram footer, or alternatively a timestamp, if activated. The current frame, displayed at the top of the diagram, is frame number 0. Older frames further down in the diagram are indicated by a negative index, e.g. "-10". You can display the spectrum diagram of a previous frame by changing the current frame number.

### Markers in the spectrogram

Markers and delta markers are shaped like diamonds in the spectrogram. They are only displayed in the spectrogram if the marker position is inside the visible area of the spectrogram. If more than two markers are active, the marker values are displayed in a separate marker table.



Markers in three-dimensional spectrograms are slightly different and are described in "[Markers in three-dimensional spectrograms](#)" on page 634.

In the spectrum result display, the markers and their frequency and level values (1) are displayed as usual. Additionally, the frame number is displayed to indicate the position of the marker in time (2).

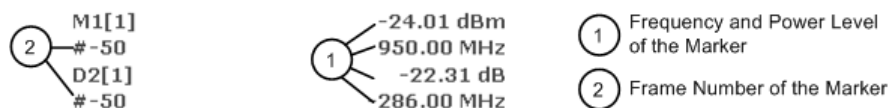

In the spectrogram result display, you can activate up to 16 markers or delta markers at the same time. Each marker can be assigned to a different frame. Therefore, in addition to the frequency you also define the frame number when activating a new marker. If no frame number is specified, the marker is positioned on the currently selected frame. All markers are visible that are positioned on a visible frame. Special search functions are provided for spectrogram markers.



In the spectrum result display, only the markers positioned on the currently selected frame are visible. In "Continuous Sweep" mode, this means that only markers positioned on frame 0 are visible. To view markers that are positioned on a frame other than frame 0 in the spectrum result display, you must stop the measurement and select the corresponding frame.

### Three-dimensional spectrograms

A common spectrogram shows the frequency on the x-axis, while the y-axis shows the time (in frames). The power level is indicated by different colors of the 2-dimensional points.

In the 3-dimensional spectrogram, the power is indicated by a value in a third dimension, the z-axis. The color mapping is maintained for the point in the 3-dimensional result display.

This new display provides an even better overview of how the strength of the signal varies over time for different frequencies.

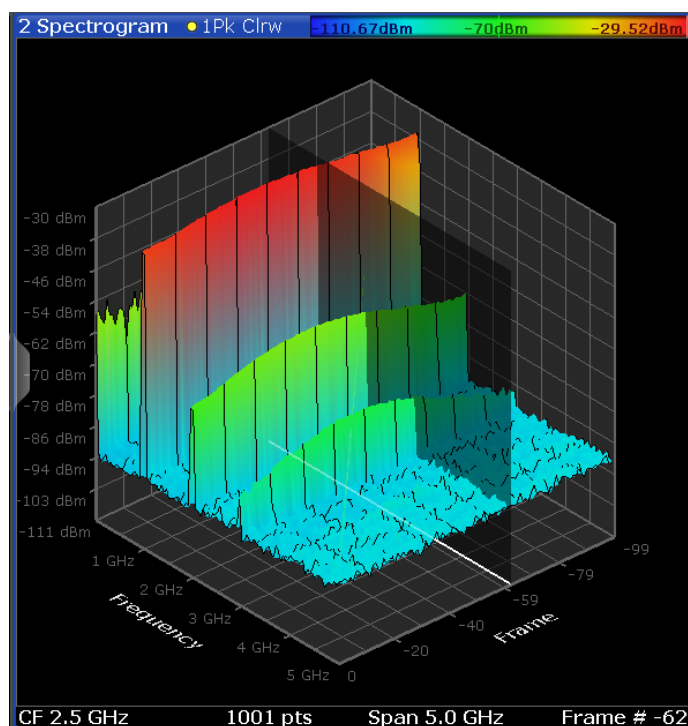

**Figure 8-16: Three-dimensional spectrogram**

The number of frames displayed on the time (y-)axis is user-definable, whereas for 2-dimensional spectrograms, the number of frames is determined automatically according to the size of the window. All other spectrogram settings are identical for 3-dimensional and 2-dimensional spectrograms.

When the measurement is stopped or completed, the currently selected frame is indicated by a gray vertical plane. (As opposed to the small white arrows at the borders of the 2-dimensional display.) The spectrum diagram always displays the spectrum for the currently selected frame.

By default, the most recently recorded frame (frame 0) is selected, and added at the front of the diagram.

### Rotating the spectrogram in three dimensions

Depending on which aspect of the spectrogram is currently of interest, you can rotate the display to have a closer look at the frequency, the time, or the power dimension. Simply drag your finger or the mouse pointer over the spectrogram in the direction you want to rotate it. You can rotate the display left or right, up and down. Note, however, that the degree of rotation is restricted in the upward direction to avoid confusing views. If you rotate the spectrogram such that you see the frequency-frame-plane directly from above, the display is identical to the 2-dimensional spectrogram.

**Table 8-10: Effect of rotating the spectrogram in three dimensions**

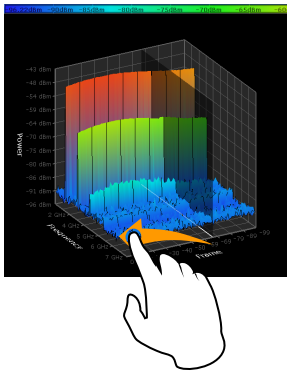
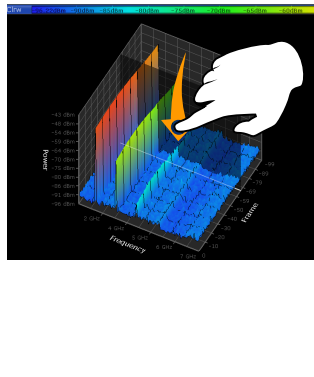
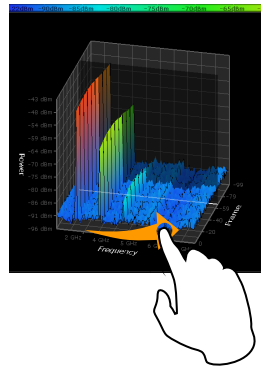
		
Rotation to the left > focus on frame	Rotation down > focus on frequency and frame	Rotation to the right > focus on frequency

### Markers in three-dimensional spectrograms

In three-dimensional spectrograms, the markers are indicated by the common arrows used in the spectrum display, for example. New markers are automatically placed on the current frame. You can move the markers to any position in all dimensions of the diagram. When you select a marker on the screen, three-dimensional cross-hairs indicate the position on all axes.

Sometimes, a marker can be hidden by other frames. If necessary, rotate the spectrogram or select a different frame as the current frame.

### Color maps

Spectrograms assign power levels to different colors to visualize them. The legend above the spectrogram display describes the power levels the colors represent.

The color display is highly configurable to adapt the spectrograms to your needs. You can define:

- Which colors to use (Color scheme)
- Which value range to apply the color scheme to
- How the colors are distributed within the value range, i.e. where the focus of the visualization lies (shape of the color curve)

The individual colors are assigned to the power levels automatically by the FSW.

### The Color Scheme

- **Hot**



Uses a color range from blue to red. Blue colors indicate low levels, red colors indicate high ones.

- **Cold**



Uses a color range from red to blue. Red colors indicate low levels, blue colors indicate high ones.

The "Cold" color scheme is the inverse "Hot" color scheme.

- **Radar**



Uses a color range from black over green to light turquoise with shades of green in between. Dark colors indicate low levels, light colors indicate high ones.

- **Grayscale**



Shows the results in shades of gray. Dark gray indicates low levels, light gray indicates high ones.

### The value range of the color map

If the measured values only cover a small area in the spectrogram, you can optimize the displayed value range. Then it becomes easier to distinguish between values that are close together. Display only parts of interest.

### The shape and focus of the color curve

The color-mapping function assigns a specified color to a specified power level in the spectrogram display. By default, colors on the color map are distributed evenly. However, to visualize a certain area of the value range in greater detail than the rest, you can set the focus of the color mapping to that area. Changing the focus is performed by changing the shape of the color curve.

The color curve is a tool to shift the focus of the color distribution on the color map. By default, the color curve is linear. If you shift the curve to the left or right, the distribution becomes non-linear. The slope of the color curve increases or decreases. One end of the color palette then covers a large range of results, while the other end distributes several colors over a relatively small result range.

You can use this feature to put the focus on a particular region in the diagram and to be able to detect small variations of the signal.

**Example:**

In the color map based on the linear color curve, the range from -100 dBm to -60 dBm is covered by blue and a few shades of green only. The range from -60 dBm to -20 dBm is covered by red, yellow and a few shades of green.

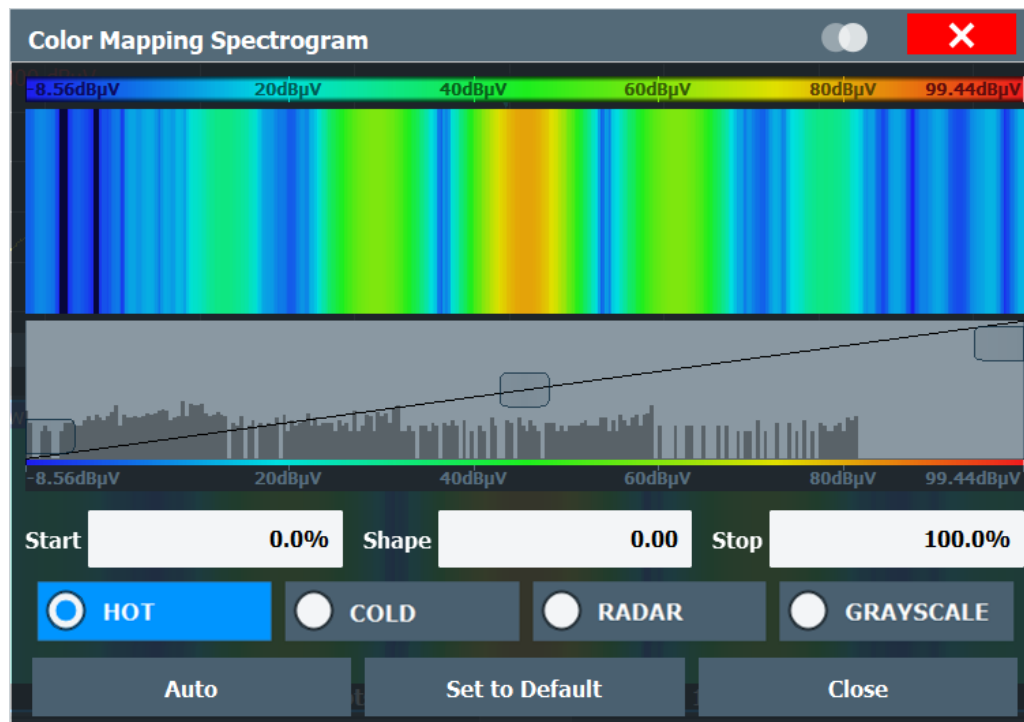

*Figure 8-17: Spectrogram with (default) linear color curve shape = 0*

The sample spectrogram is dominated by blue and green colors. After shifting the color curve to the left (negative value), more colors cover the range from -100 dBm to -60 dBm (blue, green and yellow). This range occurs more often in the example. The range from -60 dBm to -20 dBm, on the other hand, is dominated by various shades of red only.

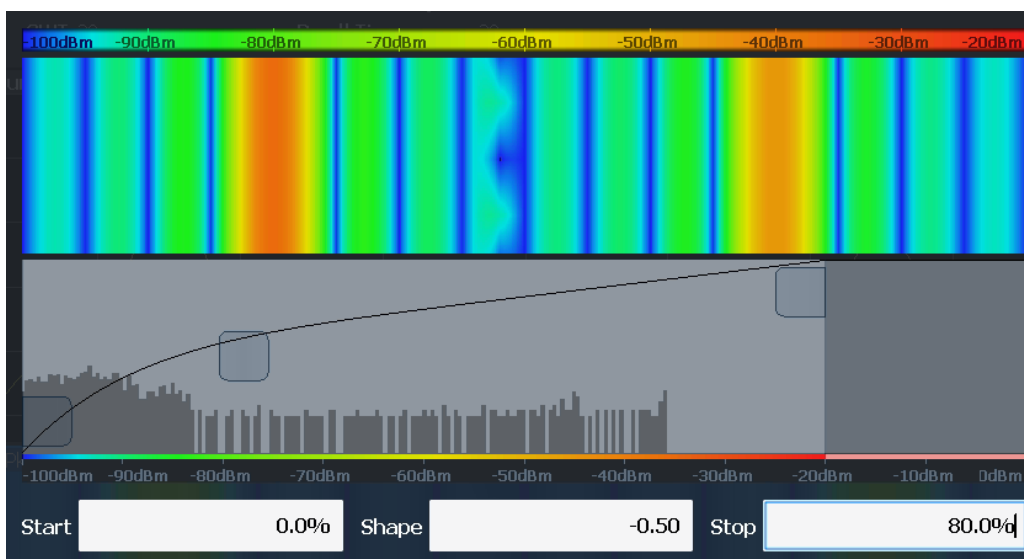

Figure 8-18: Spectrogram with non-linear color curve (shape = -0.5)

### 8.5.2.2 Spectrogram settings

**Access:** [TRACE] > "Spectrogram Config"

The individual settings available for spectrogram display are described here. For settings on color mapping, see "Color map settings" on page 641.

Settings concerning the frames and how they are handled during a sweep are provided as additional sweep settings for spectrogram display.

See Chapter 7.5, "Bandwidth, filter and sweep configuration", on page 492.

Search functions for spectrogram markers are described in Chapter 8.3.3.2, "Marker search settings for spectrograms", on page 560.

- General spectrogram settings..... 637
- Color map settings..... 641

#### General spectrogram settings

**Access:** [TRACE] > "Spectrogram Config"

This section describes general settings for spectrogram display.

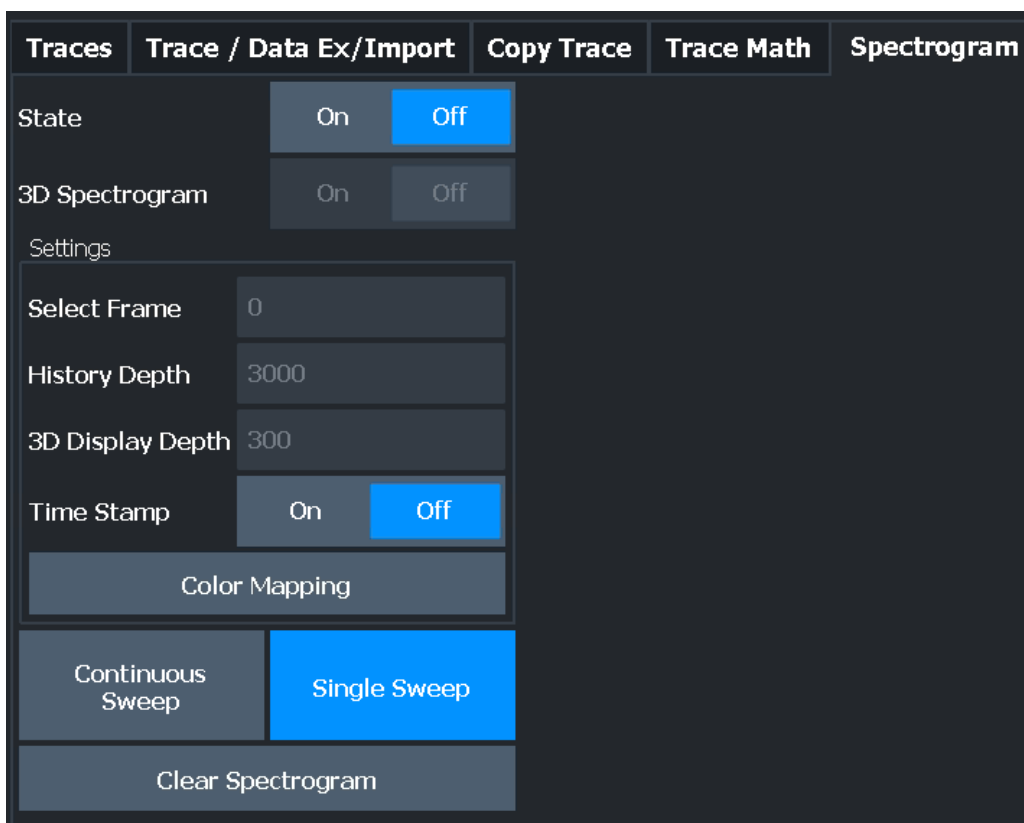

State..... 638

3D Spectrogram State..... 639

Select Frame..... 639

History Depth..... 639

3-D Display Depth..... 639

Time Stamp..... 639

Color Mapping..... 639

Continuous Sweep / Run Cont..... 640

Single Sweep / Run Single..... 640

Clear Spectrogram..... 640

**State**

Activates and deactivates a Spectrogram subwindow.

- "Split"            Displays the Spectrogram as a subwindow in the original result display.
- "Full"             Displays the Spectrogram in a subwindow in the full size of the original result display.
- "Off"               Closes the Spectrogram subwindow.

Remote command:

[CALCulate<n>:SPECTrogram:LAYout](#) on page 1251

### 3D Spectrogram State

Activates and deactivates a 3-dimensional spectrogram. As opposed to the common 2-dimensional spectrogram, the power is not only indicated by a color mapping, but also in a third dimension, the z-axis.

For details see ["Three-dimensional spectrograms"](#) on page 633.

Remote command:

`CALCulate<n>:SPECTrogram:THReedim[:STATe]` on page 1251

### Select Frame

Selects a specific frame, loads the corresponding trace from the memory, and displays it in the Spectrum window.

Note that activating a marker or changing the position of the active marker automatically selects the frame that belongs to that marker.

This function is only available in single sweep mode or if the sweep is stopped, and only if a spectrogram is selected.

The most recent frame is number 0, all previous frames have a negative number.

For more details, see ["Time frames"](#) on page 630.

Remote command:

`CALCulate<n>:SPECTrogram:FRAMe:SElect` on page 1250

### History Depth

Sets the number of frames that the FSW stores in its memory.

The maximum number of frames depends on the [Sweep Points](#).

If the memory is full, the FSW deletes the oldest frames stored in the memory and replaces them with the new data.

Remote command:

`CALCulate<n>:SPECTrogram:HDEPth` on page 1250

### 3-D Display Depth

Defines the number of frames displayed in a 3-dimensional spectrogram.

For details see ["Three-dimensional spectrograms"](#) on page 633.

### Time Stamp

Activates and deactivates the timestamp. The timestamp shows the system time while the measurement is running. In single sweep mode or if the sweep is stopped, the timestamp shows the time and date of the end of the sweep.

When active, the timestamp replaces the display of the frame number.

Remote command:

`CALCulate<n>:SPECTrogram:TSTamp[:STATe]` on page 1253

`CALCulate<n>:SPECTrogram:TSTamp:DATA?` on page 1252

### Color Mapping

Opens the "Color Mapping" dialog.

For details see ["Color maps"](#) on page 634.

### Continuous Sweep / Run Cont

After triggering, starts the sweep and repeats it continuously until stopped. This is the default setting.

While the measurement is running, "Continuous Sweep" and [RUN CONT] are highlighted. The running measurement can be aborted by selecting the highlighted softkey or key again. The results are not deleted until a new measurement is started.

**Note:** Sequencer. If the Sequencer is active, "Continuous Sweep" only controls the sweep mode for the currently selected channel. However, the sweep mode only takes effect the next time the Sequencer activates that channel, and only for a channel-defined sequence. In this case, a channel in continuous sweep mode is swept repeatedly.

Furthermore, [RUN CONT] controls the Sequencer, not individual sweeps. [RUN CONT] starts the Sequencer in continuous mode.

For details on the Sequencer, see [Chapter 5.4.1, "The sequencer concept"](#), on page 122.

Remote command:

`INITiate<n>:CONTInuous` on page 909

### Single Sweep / Run Single

After triggering, starts the number of sweeps set in "Sweep Count". The measurement stops after the defined number of sweeps has been performed.

While the measurement is running, "Single Sweep" and [RUN SINGLE] are highlighted. The running measurement can be aborted by selecting the highlighted softkey or key again.

**Note:** Sequencer. If the Sequencer is active, "Single Sweep" only controls the sweep mode for the currently selected channel. However, the sweep mode only takes effect the next time the Sequencer activates that channel, and only for a channel-defined sequence. In this case, the Sequencer sweeps a channel in single sweep mode only once.

Furthermore, [RUN SINGLE] controls the Sequencer, not individual sweeps. [RUN SINGLE] starts the Sequencer in single mode.

If the Sequencer is off, only the evaluation for the currently displayed channel is updated.

For details on the Sequencer, see [Chapter 5.4.1, "The sequencer concept"](#), on page 122.

Remote command:

`INITiate<n>[:IMMEDIATE]` on page 910

`CALCulate<n>:SPECTrogram:CONTInuous` on page 1249

### Clear Spectrogram

Resets the spectrogram result display and clears the history buffer.

This function is only available if a spectrogram is selected.

Remote command:

`CALCulate<n>:SPECTrogram:CLEar[:IMMEDIATE]` on page 1248



### Color map settings

**Access:** "Overview" > "Analysis" > "Traces" > "Spectrogram" > "Color Mapping"

**or:** [TRACE] > "Spectrogram Config" > "Color Mapping"

For more information on color maps, see ["Color maps"](#) on page 634. For details on changing color-mapping settings, see ["How to configure the color mapping"](#) on page 644.

In addition to the available color settings, the dialog box displays the current color map and provides a preview of the display with the current settings.

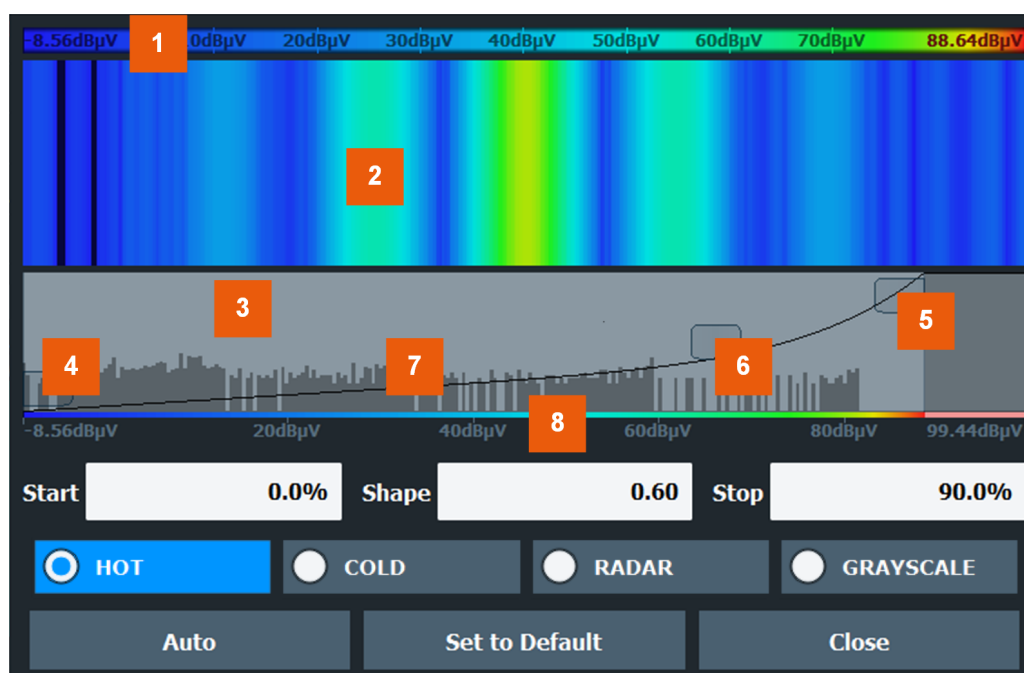

**Figure 8-19: Color Mapping dialog box**

- 1 = Color map: shows the current color distribution
- 2 = Preview pane: shows a preview of the spectrogram with any changes that you make to the color scheme
- 3 = Color curve pane: graphical representation of all settings available to customize the color scheme
- 4/5 = Color range start and stop sliders: define the range of the color map or amplitudes for the spectrogram
- 6 = Color curve slider: adjusts the focus of the color curve
- 7 = Histogram: shows the distribution of measured values
- 8 = Scale of the horizontal axis (value range)

<a href="#">Start / Stop</a> .....	641
<a href="#">Shape</a> .....	642
<a href="#">Hot/Cold/Radar/Grayscale</a> .....	642
<a href="#">Auto</a> .....	642
<a href="#">Set to Default</a> .....	642
<a href="#">Close</a> .....	642

#### Start / Stop

Defines the lower and upper boundaries of the value range of the spectrogram.

Remote command:

[DISPlay\[:WINDow<n>\]:SPECTrogram:COLor:LOWer](#) on page 1254

[DISPlay\[:WINDow<n>\]:SPECTrogram:COLor:UPPer](#) on page 1254

### Shape

Defines the shape and focus of the color curve for the spectrogram result display.

"-1 to <0" More colors are distributed among the lower values

"0" Colors are distributed linearly among the values

">0 to 1" More colors are distributed among the higher values

Remote command:

[DISPlay\[:WINDow<n>\]:SPECTrogram:COLor:SHApe](#) on page 1254

### Hot/Cold/Radar/Grayscale

Sets the color scheme for the spectrogram.

Remote command:

[DISPlay\[:WINDow<n>\]:SPECTrogram:COLor\[:STYLE\]](#) on page 1255

### Auto

Defines the color range automatically according to the existing measured values for optimized display.

### Set to Default

Sets the color mapping to the default settings.

Remote command:

[DISPlay\[:WINDow<n>\]:SPECTrogram:COLor:DEFault](#) on page 1254

### Close

Saves the changes and closes the dialog box.

## 8.5.2.3 How to display and configure a spectrogram

Step-by-step instructions on how to display and configure a spectrogram are provided here. For details on individual functions and settings see [Chapter 8.5.2.2, "Spectrogram settings"](#), on page 637.

The remote commands required to perform these tasks are described in [Chapter 13.8.2.2, "Configuring spectrograms"](#), on page 1248.

The following tasks are described here:

- ["To display a spectrogram"](#) on page 643
- ["To remove the spectrogram display"](#) on page 643
- ["To set a marker in the spectrogram"](#) on page 643
- ["To configure a spectrogram"](#) on page 643
- ["To select a color scheme"](#) on page 644
- ["To set the value range graphically using the color range sliders"](#) on page 645
- ["To set the value range of the color map numerically"](#) on page 645

- ["To set the color curve shape graphically using the slider"](#) on page 646
- ["To set the color curve shape numerically"](#) on page 646

#### To display a spectrogram

1. In the "Overview", select "Display", then drag the evaluation type "Spectrogram" to the diagram area.  
Alternatively:
  - a) Select [TRACE] and then "Spectrogram Config".
  - b) Toggle "Spectrogram" to "On".
2. To clear an existing spectrogram display, select "Clear Spectrogram".
3. Start a new measurement using [RUN SINGLE] or [RUN CONT].  
The spectrogram is updated continuously with each new sweep.
4. To display the spectrum diagram for a specific time frame:
  - a) Stop the continuous measurement or wait until the single sweep is completed.
  - b) Select the frame number in the diagram footer.
  - c) Enter the required frame number in the edit dialog box.  
Note that the most recent sweep is frame number 0, all previous frames have negative numbers.

#### To remove the spectrogram display

1. Select [TRACE] and then "Spectrogram Config".
2. Toggle "Spectrogram" to "Off".  
The standard spectrum display is restored.

#### To set a marker in the spectrogram

1. While a spectrogram is displayed, select [MARKER].
2. Select a "Marker" softkey.
3. Enter the frequency or time (x-value) of the marker or delta marker.
4. Enter the frame number for which the marker is to be set, for example 0 for the current frame, or -2 for the second to last frame. Note that the frame number is always 0 or a negative value!  
The marker is only visible in the spectrum diagram if it is defined for the currently selected frame. In the spectrogram result display all markers are visible that are positioned on a visible frame.

#### To configure a spectrogram

1. Configure the spectrogram frames:
  - a) Select [SWEEP].
  - b) Select "Sweep Config".

- c) In the "Sweep/Average Count" field, define how many sweeps are to be analyzed to create a single frame.
  - d) In the "Frame Count" field, define how many frames are to be plotted during a single sweep measurement.
  - e) To include frames from previous sweeps in the analysis of the new frame (for "Max Hold", "Min Hold" and "Average" trace modes only), select "Continue Frame" = "On".
2. Define how many frames are to be stored in total:
    - a) Select [TRACE] and then "Spectrogram Config".
    - b) Select "History Depth".
    - c) Enter the maximum number of frames to store.
  3. Optionally, replace the frame number by a time stamp by toggling "Time Stamp" to "On".
  4. If necessary, adapt the color mapping for the spectrogram to a different value range or color scheme as described in ["How to configure the color mapping"](#) on page 644.

### How to configure the color mapping

The color display is highly configurable to adapt the spectrogram to your needs.

The settings for color mapping are defined in the "Color Mapping" dialog box. To display this dialog box, do one of the following:

- Select the color map in the window title bar of the "Spectrogram" result display.
- Select "Color Mapping" in the "Spectrogram" menu.

#### To select a color scheme

You can select which colors are assigned to the measured values.

- ▶ In the "Color Mapping" dialog box, select the option for the color scheme to be used.

#### Editing the value range of the color map

The distribution of the measured values is displayed as a histogram in the "Color Mapping" dialog box. To cover the entire measurement value range, make sure the first and last bar of the histogram are included.

To ignore noise in a spectrogram, for example, exclude the lower power levels from the histogram.



The value range of the color map must cover at least 10% of the value range on the horizontal axis of the diagram, that means, the difference between the start and stop values must be at least 10%.

The value range of the color map can be set numerically or graphically.

### To set the value range graphically using the color range sliders

1. Select and drag the bottom color curve slider (indicated by a gray box at the left of the color curve pane) to the lowest value you want to include in the color mapping.
2. Select and drag the top color curve slider (indicated by a gray box at the right of the color curve pane) to the highest value you want to include in the color mapping.

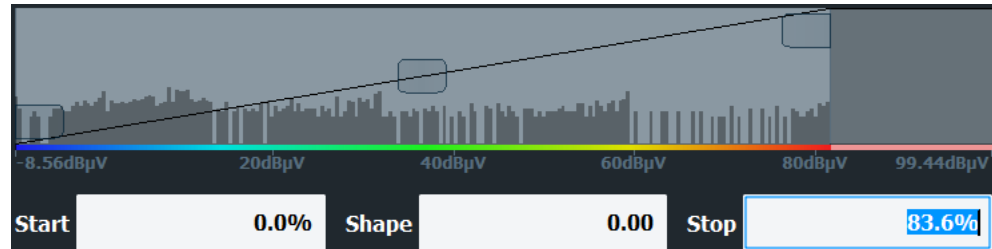

### To set the value range of the color map numerically

1. In the "Start" field, enter the percentage from the left border of the histogram that marks the beginning of the value range.
2. In the "Stop" field, enter the percentage from the right border of the histogram that marks the end of the value range.

#### Example:

The color map starts at -110 dBm and ends at -10 dBm (that is: a range of 100 dB). In order to suppress the noise, you only want the color map to start at -90 dBm. Thus, you enter 10% in the "Start" field. The FSW shifts the start point 10% to the right, to -90 dBm.



#### Adjusting the reference level and level range

Since the color map is configured using percentages of the total value range, changing the reference level and level range of the measurement (and thus the power value range) also affects the color mapping in the spectrogram.

#### Editing the shape of the color curve

The color curve is a tool to shift the focus of the color distribution on the color map. By default, the color curve is linear, i.e. the colors on the color map are distributed evenly. If you shift the curve to the left or right, the distribution becomes non-linear. The slope of the color curve increases or decreases. One end of the color palette then covers a large number of results, while the other end distributes several colors over a relatively small result range.

The color curve shape can be set numerically or graphically.

### To set the color curve shape graphically using the slider

- ▶ Select and drag the color curve shape slider (indicated by a gray box in the middle of the color curve) to the left or right. The area beneath the slider is focused, i.e. more colors are distributed there.

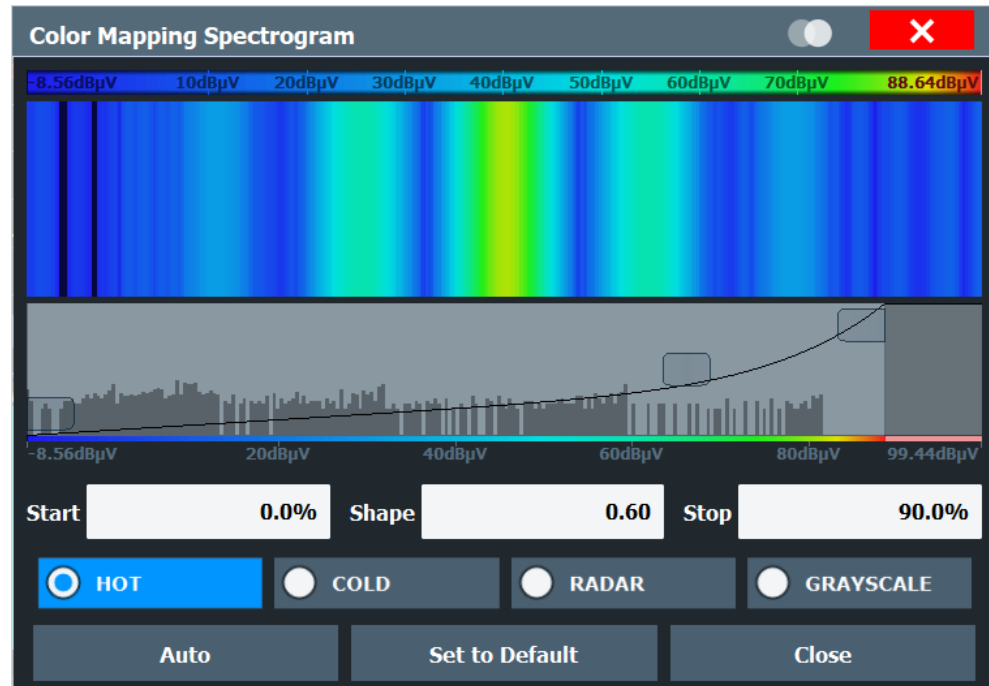

### To set the color curve shape numerically

- ▶ In the "Shape" field, enter a value to change the shape of the curve:
  - A negative value (-1 to <0) focuses the lower values
  - 0 defines a linear distribution
  - A positive value (>0 to 1) focuses the higher values

## 8.5.3 Trace math

**Access:** [TRACE] > "Trace Math"

**Or:** "Overview" > "Analysis" > "Traces" > "Trace Math"

If you have several traces with different modes, for example an average trace and a maximum trace, it may be of interest to compare the results of both traces. In this example, you could analyze the maximum difference between the average and maximum values. To analyze the span of result values, you could subtract the minimum trace from the maximum trace. For such tasks, the results from several traces can be combined using mathematical functions.

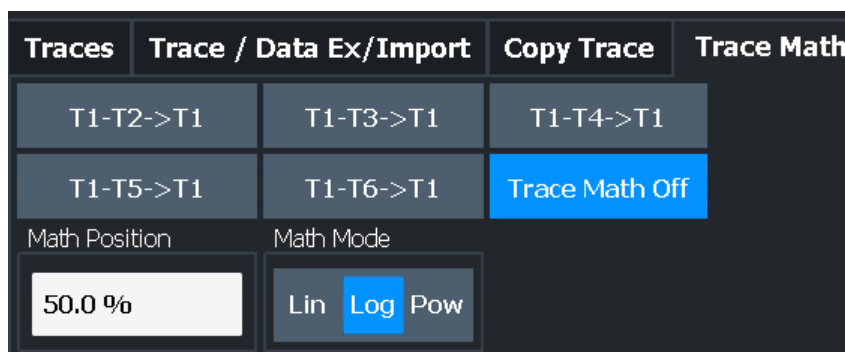

<a href="#">Trace Math Function</a> .....	647
<a href="#">Trace Math Off</a> .....	647
<a href="#">Trace Math Position</a> .....	647
<a href="#">Trace Math Mode</a> .....	648

### Trace Math Function

You can select one of several different math operations.

Each operation subtracts one trace from another as indicated on the corresponding button and writes the result to one of the traces. "T1 - T3 > T1", for example, subtracts trace 3 from trace 1 and writes the result to trace 1. You can apply one operation at a time.

The result refers to the zero point defined with the [Trace Math Position](#) setting. The following subtractions can be performed:

"T1-T2->T1"	Subtracts trace 2 from trace 1.
"T1-T3->T1"	Subtracts trace 3 from trace 1
"T1-T4->T1"	Subtracts trace 4 from trace 1
"T1-T5->T1"	Subtracts trace 5 from trace 1
"T1-T6->T1"	Subtracts trace 6 from trace 1

To switch off the trace math, use the [Trace Math Off](#) button.

Remote command:

[CALCulate<n>:MATH<t>\[:EXPRession\] \[:DEFine\]](#) on page 1255

[CALCulate<n>:MATH<t>:STATe](#) on page 1257

### Trace Math Off

Deactivates any previously selected trace math functions.

Remote command:

[CALC:MATH:STAT OFF](#), see [CALCulate<n>:MATH<t>:STATe](#) on page 1257

### Trace Math Position

Defines the zero point on the y-axis of the resulting trace in % of the diagram height. The range of values extends from -100 % to +200 %.

Remote command:

[CALCulate<n>:MATH<t>:POSition](#) on page 1257

**Trace Math Mode**

Defines the mode for the trace math calculations.

"Lin"	<p>Activates linear subtraction, which means that the power level values are converted into linear units prior to subtraction. After the subtraction, the data is converted back into its original unit.</p> <p>This setting takes effect if the grid is set to a linear scale. In this case, subtraction is done in two ways (depending on the set unit):</p> <ul style="list-style-type: none"> <li>• The unit is set to either W or dBm: the data is converted into W prior to subtraction, i.e. averaging is done in W.</li> <li>• The unit is set to either V, A, dBmV, dBμV, dBμA or dBpW: the data is converted into V prior to subtraction, i.e. subtraction is done in V.</li> </ul>
"Log"	<p>Activates logarithmic subtraction.</p> <p>This subtraction method only takes effect if the grid is set to a logarithmic scale, i.e. the unit of the data is dBm. In this case the values are subtracted in dBm. Otherwise (i.e. with linear scaling) the behavior is the same as with linear subtraction.</p>
"Power"	<p>Activates linear power subtraction.</p> <p>The power level values are converted into unit Watt prior to subtraction. After the subtraction, the data is converted back into its original unit.</p> <p>Unlike the linear mode, the subtraction is always done in W.</p>

Remote command:

`CALCulate<n>:MATH<t>:MODE` on page 1256

## 8.6 Importing and exporting measurement results for evaluation

The FSW provides various evaluation methods for the results of the performed measurements. However, you may want to evaluate the data with further, external applications. In this case, you can export the measurement data to a standard format file (ASCII or XML). Some of the data stored in these formats can also be re-imported to the FSW for further evaluation later, for example in other applications.

The following data types can be exported (depending on the application):

- Trace data
- Table results, such as result summaries, marker peak lists etc.
- I/Q data

The following data types can be imported (depending on the application):

- I/Q data





I/Q data can only be imported and exported in applications that process I/Q data, such as the I/Q Analyzer or optional applications.

See the corresponding user manuals for those applications for details.

- [Displaying a reference trace - importing trace data](#)..... 649
- [Trace/data ex/import](#)..... 650
- [How to import traces](#)..... 655
- [How to export trace data and numerical results](#)..... 655
- [How to export a peak list](#)..... 656
- [Reference: ASCII file export format](#)..... 657

### 8.6.1 Displaying a reference trace - importing trace data

Trace data that was stored during a previous measurement can be imported to the Spectrum application, for example as a reference trace.

The data in the import file must have a specified format (see [Chapter 8.6.6, "Reference: ASCII file export format"](#), on page 657), and can be stored in .CSV or .DAT format.

#### Trace Mode

The trace mode for the imported traces is set to "View" so that the data is not overwritten immediately during the next sweep. Other trace settings remain unchanged. Thus, **the displayed trace may not comply with the displayed trace settings in the channel bar.**

#### Detector type and number of sweep points

In particular, the detector type and the number of sweep points remain unchanged.

If the detector type of the active trace requires two points per x-value ("Auto Peak"), but the file contains only one, each point is duplicated. If the detector type requires only one point per x-value, but the file contains two, each second point is ignored.

If the file contains more sweep points than the active trace requires, the superfluous points are ignored. If the file does not contain enough sweep points, the missing points are inserted as -200 dBm.

#### Units

If the unit of the y-axis values in the file does not correspond to the active result display, the imported values are converted. If no unit is defined in the file, it is assumed to be dBm.

#### Importing multiple traces in one file

If the import file contains more than one trace, you can import several traces at once, overwriting the existing trace data for any active trace in the result display with the same trace number. Data from the import file for currently not active traces is not imported.

Alternatively, you can import a single trace only, which is displayed for the trace number specified in "Import to Trace". This list contains all currently active traces in the result display. If a trace with the specified number exists in the import file, that trace is imported. Otherwise, the first trace in the file is imported (indicated by a message in the status bar).

**Example:**

The import file contains trace 1, trace 2, and trace 4. The current result display has 4 active traces.

"Import to Trace" = 2: trace 2 of the import file is displayed as trace 2 in the result display.

"Import to Trace" = 3: trace 3 is not available in the import file, thus trace 1 is imported and displayed as trace 3 in the result display

"Import all Traces" is enabled: Trace 1 is imported from the file and replaces trace 1 in the result display.

Trace 2 is imported from the file and replaces trace 2 in the result display.

Trace 4 is imported from the file and replaces trace 4 in the result display.

Trace 3 in the result display remains unchanged.

**Importing spectrogram traces**

Trace data can also be imported to an active Spectrogram result display.

Note the following differences that apply in this case:

- The measurement must be stopped before import.
- Only trace 1 is imported to the spectrogram. Any other traces may be imported to a Spectrum display, if available. However, they do not change the spectrogram display, which always refers to trace 1.
- A single spectrum is inserted as a new frame number 0.
- The trace mode is *not* changed to "View" as for Spectrum trace imports.

## 8.6.2 Trace/data ex/import

**Access:** [TRACE] > "Trace Config" > "Trace / Data Export"

The FSW provides various evaluation methods for the results of the performed measurements. However, you may want to evaluate the data with other, external applications. In this case, you can export the measurement data to a standard ASCII format file (DAT or CSV). You can also import existing trace data from a file, for example as a reference trace (Spectrum application only).



The standard data management functions (e.g. saving or loading instrument settings) that are available for all FSW applications are not described here.

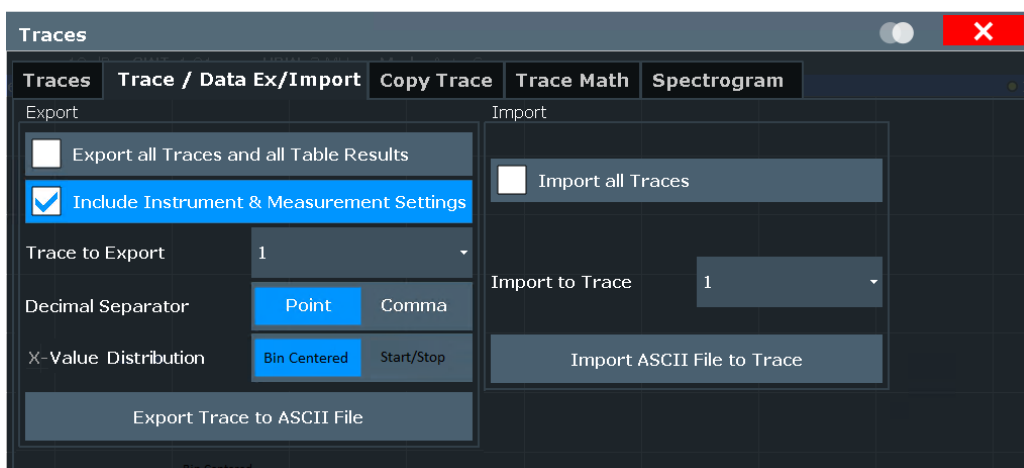

Export all Traces and all Table Results..... 651

Include Instrument & Measurement Settings..... 651

Trace to Export..... 651

Decimal Separator..... 652

X-Value Distribution..... 652

Export Trace to ASCII File..... 652

    L File Type..... 654

    L Decimal Separator..... 654

    L Column Separator..... 654

    L File Explorer..... 654

Importing Traces..... 654

    L Import All Traces/Import to Trace..... 654

    L Import ASCII File to Trace..... 655

        L File Explorer..... 655

**Export all Traces and all Table Results**

Selects all displayed traces and result tables (e.g. "Result Summary", marker table etc.) in the current application for export to an ASCII file.

Alternatively, you can select one specific trace only for export (see [Trace to Export](#)).

The results are output in the same order as they are displayed on the screen: window by window, trace by trace, and table row by table row.

Remote command:

`FORMat:DEXPort:TRACes` on page 1263

**Include Instrument & Measurement Settings**

Includes additional instrument and measurement settings in the header of the export file for result data.

See [Chapter 8.6.6, "Reference: ASCII file export format"](#), on page 657 for details.

Remote command:

`FORMat:DEXPort:HEADer` on page 1373

**Trace to Export**

Defines an individual trace to be exported to a file.

This setting is not available if [Export all Traces and all Table Results](#) is selected.

### Decimal Separator

Defines the decimal separator for floating-point numerals for the data export/import files. Evaluation programs require different separators in different languages.

Remote command:

`FORMat:DEXPort:DSEParator` on page 1348

### X-Value Distribution

Defines how the x-values of the trace are determined in the frequency domain.

See "[X-value of the sweep point](#)" on page 617.

"Bin-Centered" The full measurement span is divided by the number of sweep points to obtain *bins*. The x-value of the sweep point is defined as the x-value at the center of the bin ( $\text{bin}/2$ ).

"Start/Stop" (Default): The x-value of the first sweep point corresponds to the starting point of the full measurement span. The x-value of the last sweep point corresponds to the end point of the full measurement span. All other sweep points are divided evenly between the first and last points.

Remote command:

`FORMat:DEXPort:XDIStrib` on page 1263

### Export Trace to ASCII File

Saves the selected trace or all traces in the currently active result display to the specified file and directory in the selected ASCII format.

"File Explorer": Instead of using the file manager of the FSW firmware, you can also use the Microsoft Windows File Explorer to manage files.

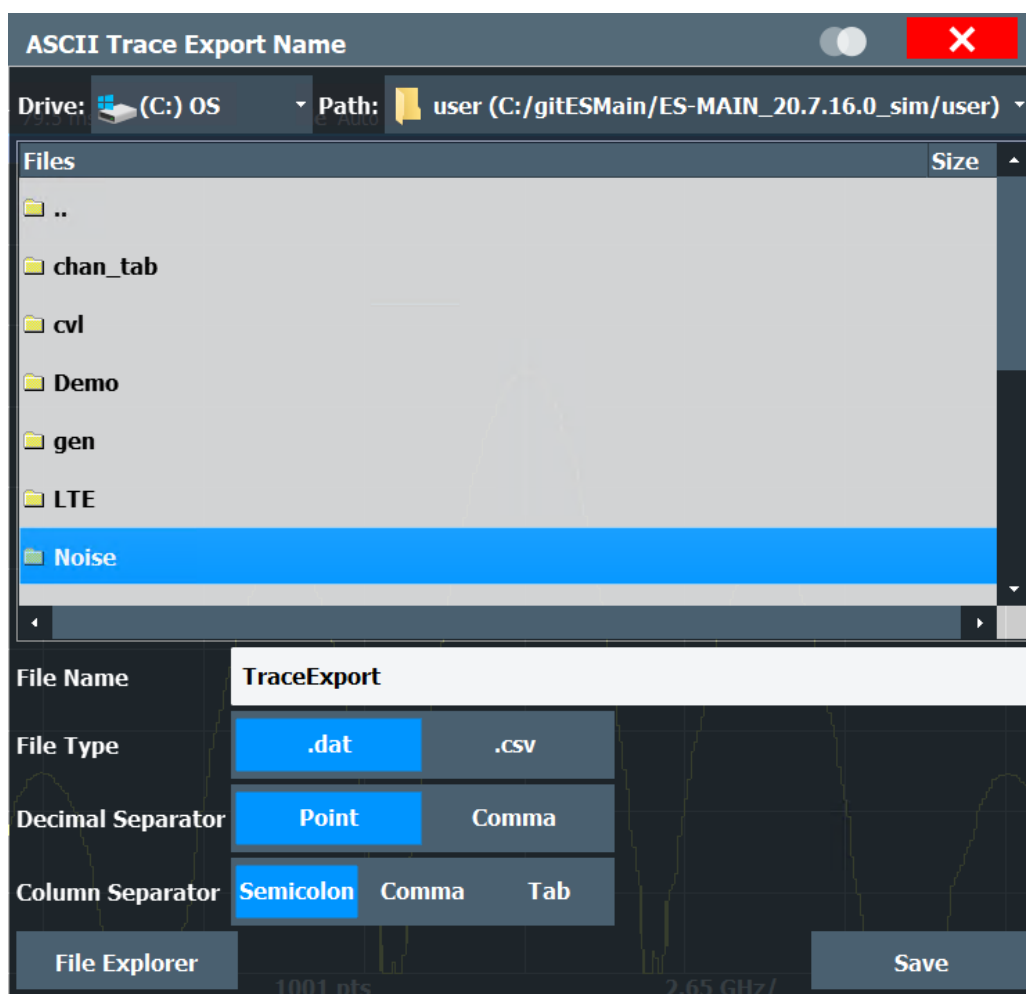

If the spectrogram display is selected when you perform this function, the entire histogram buffer with all frames is exported to a file. The data for a particular frame begins with information about the frame number and the time that frame was recorded. For large history buffers the export operation can take some time.

For details on the file format in the Spectrum application, see [Chapter 8.6.6, "Reference: ASCII file export format"](#), on page 657.

**Note:** Secure user mode.

In secure user mode, settings that are stored on the instrument are stored to volatile memory, which is restricted to 256 MB. Thus, a "memory limit reached" error can occur although the hard disk indicates that storage space is still available.

To store data permanently, select an external storage location such as a USB memory device.

For details, see [Chapter 4.2.15, "Protecting data using the secure user mode"](#), on page 39.

Remote command:

[MMEMory:STORe<n>:TRACe](#) on page 1265

[MMEMory:STORe<n>:SPECTrogram](#) on page 1374

**File Type ← Export Trace to ASCII File**

Determines the format of the ASCII file to be imported or exported.

Depending on the external program in which the data file was created or is evaluated, a comma-separated list (CSV) or a plain data format (DAT) file is required.

Remote command:

[FORMat:DEXPort:FORMat](#) on page 1263

**Decimal Separator ← Export Trace to ASCII File**

Defines the decimal separator for floating-point numerals for the data export/import files. Evaluation programs require different separators in different languages.

Remote command:

[FORMat:DEXPort:DSEPARATOR](#) on page 1348

**Column Separator ← Export Trace to ASCII File**

Selects the character that separates columns in the exported ASCII file. The character can be either a semicolon, a comma or a tabulator (tab).

Example for semicolon:

```
Type;FSW13;Version;1.00;Date;01.Jan 3000;
```

Example for comma:

```
Type,FSW13,  
Version,1.00,  
Date,01.Jan 3000,
```

Example for tabulator (tab after the last column is not visible):

```
Type      FSW13  
Version   1.00  
Date      01.Jan 3000
```

The selected column separator setting remains the same, even after a preset.

Remote command:

[FORMat:DEXPort:CSEPARATOR](#) on page 1262

**File Explorer ← Export Trace to ASCII File**

Opens the Microsoft Windows File Explorer.

Remote command:

not supported

**Importing Traces**

Trace data that was stored during a previous measurement can be imported to the Spectrum application, for example as a reference trace.

**Import All Traces/Import to Trace ← Importing Traces**

If the import file contains more than one trace, you can import several traces at once, overwriting the existing trace data for any active trace in the result display with the same trace number. Data from the import file for currently not active traces is not imported.

Alternatively, you can import a single trace only, which is displayed for the trace number specified in "Import to Trace". This list contains all currently active traces in the result display. If a trace with the specified number exists in the import file, that trace is imported. Otherwise, the first trace in the file is imported (indicated by a message in the status bar).

Remote command:

[FORMat:DIMPort:TRACes](#) on page 1264

#### **Import ASCII File to Trace ← Importing Traces**

Loads one trace or all traces from the selected file in the selected ASCII format (.DAT or .CSV) to the currently active result display.

Remote command:

[FORMat:DIMPort:TRACes](#) on page 1264

#### **File Explorer ← Import ASCII File to Trace ← Importing Traces**

Opens the Microsoft Windows File Explorer.

Remote command:

not supported

### **8.6.3 How to import traces**

Trace data that was stored during a previous measurement can be imported to the Spectrum application, for example as a reference trace.

#### **To import trace data**

1. Press [Trace].
2. Select "Trace Config" > "Trace / Data Export"/"Import".
3. Select "Import All Traces" to import traces for all the currently active traces, or select a specific trace to be imported in "Import to Trace".
4. Select "Import ASCII File to Trace".
5. Select the file format in which the data is stored.
6. Select the file that contains the trace data.
7. Select "Select" to close the dialog box and start the import.

### **8.6.4 How to export trace data and numerical results**

The measured trace data and numerical measurement results in tables can be exported to an ASCII file. For each sweep point, the measured trace position and value are output.

The file is stored with a .DAT or .CSV extension. For details on the storage format, see [Chapter 8.6.6, "Reference: ASCII file export format"](#), on page 657.



For the results of a Spectrum Emission Mask (SEM) or Spurious Emissions measurement, special file export functions are available, see [Chapter 6.6.6.2, "How to save SEM result files"](#), on page 270 (SEM) and ["Save Evaluation List"](#) on page 290 (Spurious).

#### To export trace data and table results

1. Select [TRACE] > "Trace Config" > "Trace / Data Export" tab.
2. Select "Export all Traces and all Table Results" to export all available measurement result data for the current application, or select a specific "Trace to Export".
3. Optionally, select "Include Instrument & Measurement Settings" to insert additional information in the export file header.
4. Select "Export Trace to ASCII File".
5. In the file selection dialog box, select the storage location and file name for the export file.
6. If necessary, change the decimal separator for the ASCII export file.
7. Select the data format of the ASCII file.
8. Select "Save" to close the dialog box and export the data to the file.

### 8.6.5 How to export a peak list

You can save the results of a marker peak list to an ASCII file.

1. Press [MKR FUNCT].
2. Select "Marker Peak List".
3. Configure the peak search and list settings as described in [Chapter 8.3.4.8, "Marker peak list"](#), on page 582.
4. Set the marker peak list "State" to "On".
5. Press [RUN SINGLE] to perform a single sweep measurement and create a marker peak list.
6. Select "Marker Peak List" to display the "Marker Peak List" dialog box again.
7. If necessary, change the decimal separator to be used for the ASCII export file.
8. Select "Export Peak List".
9. In the file selection dialog box, select the storage location and file name for the export file.
10. Select "Save" to close the dialog box and export the peak list data to the file.



### 8.6.6 Reference: ASCII file export format

Trace data can be exported to a file in ASCII format for further evaluation in other applications. This reference describes in detail the format of the export files for result data.

(For details see [Chapter 8.6.4, "How to export trace data and numerical results"](#), on page 655)



For a description of the file formats for spectrum emission mask (SEM) measurement settings and results, see [Chapter 6.6.8, "Reference: SEM file descriptions"](#), on page 272.

The file format for Spurious Emissions measurement results is described in [Chapter 6.7.6, "Reference: ASCII export file format \(spurious\)"](#), on page 292.

The file consists of the header containing important scaling parameters and a data section containing the trace data. Optionally, the header can be excluded from the file (see ["Include Instrument & Measurement Settings"](#) on page 651).

The data of the file header consist of three columns, each separated by a semicolon: parameter name; numeric value; basic unit. The data section starts with the keyword "Trace <n>" (<n> = number of stored trace). The measured data follows in one or several columns (depending on the measurement), which are also separated by a semicolon.

The results are output in the same order as they are displayed on the screen: window by window, trace by trace, and table row by table row.

Generally, the format of this ASCII file can be processed by spreadsheet calculation programs, e.g. MS-Excel. Different language versions of evaluation programs can require a different handling of the decimal point. Thus, you can define the decimal separator to use (decimal point or comma, see ["Decimal Separator"](#) on page 652).

If the spectrogram display is selected when you select "ASCII Trace Export", the entire histogram buffer with all frames is exported to a file. The data corresponding to a particular frame begins with information about the frame number and the time that frame was recorded.

**Table 8-11: ASCII file format for trace export in the Spectrum application**

File contents	Description
<b>Header data</b>	
Type;FSW;	Instrument model
Version;1.00;	Firmware version
Date;01.Oct 2006;	Date of data set storage
Mode;ANALYZER;	Operating mode
Preamplifier;OFF	Preamplifier status
Transducer; OFF	Transducer status
Center Freq;55000;Hz	Center frequency

## Importing and exporting measurement results for evaluation

File contents	Description
Freq Offset;0;Hz	Frequency offset
Start;10000;Hz Stop;100000;Hz	Start/stop of the display range. Unit: Hz for span > 0, s for span = 0, dBm/dB for statistics measurements
Span;90000;Hz	Frequency range (0 Hz in zero span and statistics measurements)
Ref Level;-30;dBm	Reference level
Level Offset;0;dB	Level offset
Rf Att;20;dB	Input attenuation
EI Att;2.0;dB	Electrical attenuation
RBW;100000;Hz	Resolution bandwidth
VBW;30000;Hz	Video bandwidth
SWT;0.005;s	Sweep time
Sweep Count;20;	Number of sweeps set
Ref Position;75;%	Position of reference level referred to diagram limits (0 % = lower edge)
Level Range;100;dB	Display range in y direction. Unit: dB with x-axis LOG, % with x-axis LIN
x-Axis;LIN;	Scaling of x-axis linear (LIN) or logarithmic (LOG)
y-Axis;LOG;	Scaling of y-axis linear (LIN) or logarithmic (LOG)
x-Unit;Hz;	Unit of x values: Hz with span > 0; s with span = 0; dBm/dB with statistics measurements
y-Unit;dBm;	Unit of y values: dB*/V/A/W depending on the selected unit with y-axis LOG or % with y-axis LIN
<b>Data section for individual window</b>	
Window;1;Frequency Sweep	Window number and name
Trace 1;;	Selected trace
Trace Mode;AVERAGE;	Display mode of trace: CLR/WRITE,AVERAGE,MAXHOLD,MINHOLD
Detector;AUTOPEAK;	Selected detector
Values; 1001;	Number of measurement points
10000;-10.3;-15.7 10130;-11.5;-16.9 10360;-12.0;-17.4 ...;...;	Measured values: <x value>, <y1>, <y2>; <y2> being available only with detector AUTOPEAK and containing in this case the smallest of the two measured values for a measurement point.
<b>Data section for individual trace</b>	
Trace 2;;	Next trace in same window

## Importing and exporting measurement results for evaluation

File contents	Description
...	
<b>Data section for individual window</b>	
Window;2 ..;	Name of next window
<b>Data section for individual trace</b>	
Trace 1;;	First trace
...	

Table 8-12: ASCII file format for spectrogram trace export

File contents	Description
<b>Header</b>	
Type;FSW;	Instrument model
Version;5.00;	Firmware version
Date;01.Oct 2006;	Date of data set storage
Mode;ANALYZER; <b>SPECTROGRAM</b>	Operating mode
Center Freq;55000;Hz	Center frequency
Freq Offset;0;Hz	Frequency offset
Span;90000;Hz	Frequency range (0 Hz in zero span and statistics measurements)
x-Axis;LIN;	Scaling of x-axis linear (LIN) or logarithmic (LOG)
Start;10000;Hz Stop;100000;Hz	Start/stop of the display range. Unit: Hz for span > 0, s for span = 0, dBm/dB for statistics measurements
Ref Level;-30;dBm	Reference level
Level Offset;0;dB	Level offset
Ref Position;75; %	Position of reference level referred to diagram limits (0 % = lower edge)
y-Axis;LOG;	Scaling of y-axis linear (LIN) or logarithmic (LOG)
Level Range;100;dB	Display range in y direction. Unit: dB with x-axis LOG, % with x-axis LIN
Rf Att;20;dB	Input attenuation
RBW;100000;Hz	Resolution bandwidth
VBW;30000;Hz	Video bandwidth
SWT;0.005;s	Sweep time
Trace Mode;AVERAGE;	Display mode of trace: CLR/WRITE,AVERAGE,MAXHOLD,MINHOLD
Detector;AUTOPEAK;	Selected detector

File contents	Description
Sweep Count;20;	Number of sweeps set
<b>Data section</b>	
Trace 1;;	Selected trace
x-Unit;Hz;	Unit of x values: Hz with span > 0; s with span = 0; dBm/dB with statistics measurements
y-Unit;dBm;	Unit of y values: dB*/V/A/W depending on the selected unit with y-axis LOG or % with y-axis LIN
Values; 1001;	Number of measurement points
<b>Frames;2;</b>	<b>Number of exported frames</b>
<b>Frame;0;</b>	<b>Most recent frame number</b>
Timestamp;17.Mar 11;11:27:05.990	<b>Timestamp of this frame</b>
10000;-10.3;-15.7 10130;-11.5;-16.9 10360;-12.0;-17.4 ...;...;	Measured values, identical to spectrum data: <x value>, <y1>, <y2>; <y2> being available only with detector AUTOPEAK and containing in this case the smallest of the two measured values for a measurement point.
<b>Frame;-1;</b>	<b>Next frame</b>
<b>Timestamp;17.Mar 11;11:27:05.342</b>	<b>Timestamp of this frame</b>
...	

## 8.7 Event-based actions

During a measurement, specific events require that you take a certain action. The FSW allows you to automatize such tasks.

The event-based actions feature allows you to capture a particular state of the device under test. Then you can document it for further research or start a specific procedure. The mechanism triggers one or more actions at the end of a sweep if a certain condition applies. The combinations of condition and actions are called *rules*. Each application individually specifies its own set of rules. Triggering conditions are referred to as *events*. Typical examples are exceeding or going below a limit value, the (non-) violation of a limit line, hitting a marker value, etc. The range of actions includes taking a screenshot, starting a separate program, saving I/Q data, etc. Also, continuous sweeping can be stopped to retain the data of a particular state of the system.



**General conditions for event-based actions**

Some general conditions apply to event-based actions:

- A maximum of 5 rules can be defined for each application.
- The base unit applications (Spectrum, I/Q analyzer, Analog Demodulation) are counted together and thus support a total of 5 rules over all three applications. Rules defined in one application are visible, but cannot be edited or enabled, in the other two applications. The same applies to different measurements within a single application (e.g. SEM and ACLR).
- Only the currently active measurement channel processes rules.
- The FSW in general, or any applications, do not perform a validity check on the rules.
- When you save and then recall the instrument settings, any rule definitions are also stored and loaded, including their state.
- After an instrument preset or restart, the rules are maintained, but disabled. The trigger count for rules is cleared.

- [Managing rules](#).....661
- [Defining rules](#)..... 662
- [Debugging rules with the EBA-Journal](#)..... 669
- [Reference: overview of available result-events and state-events](#)..... 670

**8.7.1 Managing rules**



**Access:** toolbar

The event-based actions manager allows you to configure actions to be performed when specific events occur in the measurement.

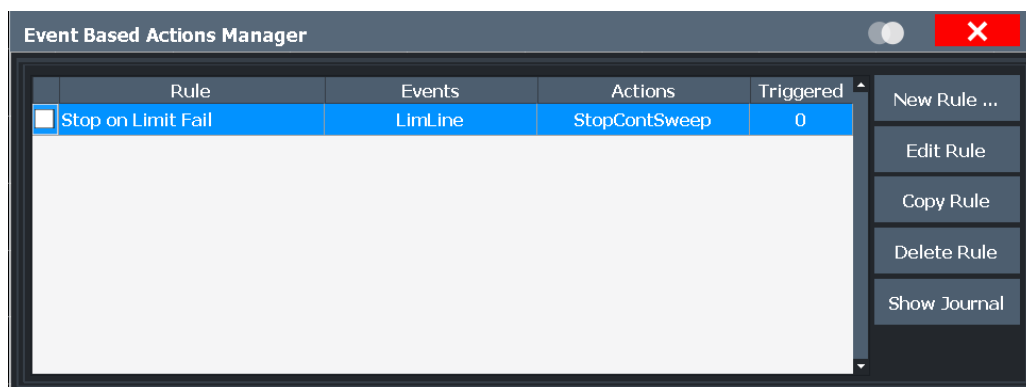

- [Rule state](#)..... 662
- [Rule](#)..... 662
- [Events](#)..... 662
- [Actions](#)..... 662
- [Triggered](#)..... 662
- [New Rule](#)..... 662
- [Edit Rule](#)..... 662

<a href="#">Copy Rule</a> .....	662
<a href="#">Delete Rule</a> .....	662
<a href="#">Show Journal</a> .....	662

**Rule state**

Enables/disables processing of the defined rule for the currently active channel only.

Note that the application does not perform a validity check on the rules. For example, if you change or delete the required command file for a rule, the rule becomes invalid. However, the application still attempts to process the rule as far as possible. An easy way to detect such a situation is using the log information, see [Chapter 8.7.3, "Debugging rules with the EBA-Journal"](#), on page 669.

**Rule**

Name of the rule

**Events**

Specified trigger events for the rule

**Actions**

Specified actions to be performed by the rule.

**Triggered**

Number of trigger events for the rule that occurred since the last instrument preset or restart.

**New Rule**

Opens the "Event Based Actions: Add Rule" dialog box to define a new rule as described in [Chapter 8.7.2, "Defining rules"](#), on page 662.

**Edit Rule**

Opens the "Event Based Actions: Modify Rule" dialog box to edit the selected rule as described in [Chapter 8.7.2, "Defining rules"](#), on page 662.

**Copy Rule**

Creates a copy of the selected rule and opens the "Event Based Actions: Modify Rule" dialog box to edit it, as described in [Chapter 8.7.2, "Defining rules"](#), on page 662.

**Delete Rule**

Deletes the selected event-based action rule.

**Show Journal**

Shows the logging information for the rules defined in the EBA rule manager. This information is useful to debug rules when expected actions are not performed. For details, see [Chapter 8.7.3, "Debugging rules with the EBA-Journal"](#), on page 669.

## 8.7.2 Defining rules

**Access:** "Event-based actions" > "New Rule" / "Edit Rule" / "Copy Rule"

Rules are defined individually for each measurement channel. You must activate each rule for each application individually, and only the currently active channel processes the rules.

A maximum of 5 rules can be defined for each application. The base unit applications (Spectrum, I/Q analyzer, Analog Demodulation) are counted together and thus support a total of 5 rules over all three applications. Rules defined in one application are visible, but cannot be edited or enabled, in the other two applications. The same applies to different measurements within a single application (e.g. SEM and ACLR).

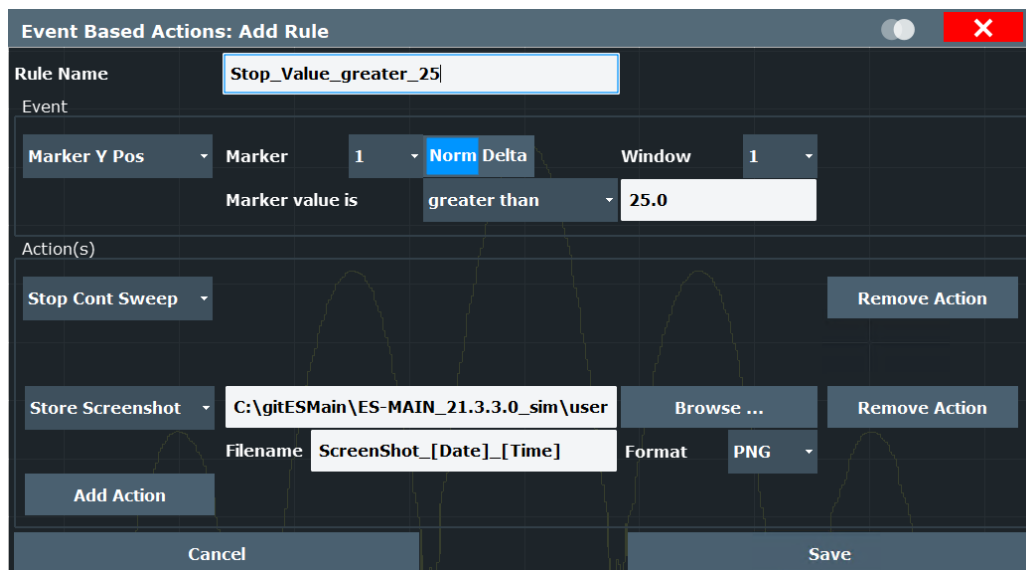

- Rule Name..... 664
- Event..... 664
  - Limit Line..... 664
    - Limit Line..... 664
    - Trigger condition..... 664
    - Window..... 664
  - Marker Y Pos..... 664
    - Marker..... 665
    - Window..... 665
    - Trigger condition (Marker value is)..... 665
    - Value..... 665
  - Result Value..... 665
    - Result..... 665
    - Trigger condition (Value is)..... 665
    - Value..... 665
  - State Value..... 665
    - Result..... 666
    - Trigger condition (Check for)..... 666
- Action..... 666
  - Store Screenshot..... 666
    - Storage location (Browse)..... 666
    - File name..... 666
    - Format..... 667

L Stop Cont Sweep.....	667
L Deactivate Rule.....	667
L Auto Level.....	667
L Trace Export.....	667
L Browse.....	667
L Mode.....	667
L I/Q Export.....	667
L Start Program/Script.....	668
L Type.....	668
L Program/script (Browse).....	668
Add Action.....	668
Remove Action.....	668
Save.....	669

**Rule Name**

Defines the unique name for the actions to be taken under specific conditions.

Without a name, the rule cannot be stored.

**Event**

Defines the event that triggers the action.

Depending on the selected event, further parameters are available.

**Limit Line ← Event**

The result of a limit line check triggers the actions.

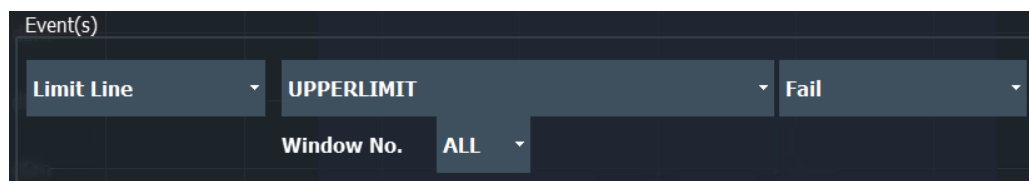
**Limit Line ← Limit Line ← Event**

The name of a limit line that is defined for the current measurement channel (see [Chapter 8.4.2, "Limit lines"](#), on page 593).

The limit line must be active in the current measurement channel for the rule to be processed.

**Trigger condition ← Limit Line ← Event**

The result of the limit check ("Pass" / "Fail" / "Margin") that triggers the actions.

**Window ← Limit Line ← Event**

Window in which the specified limit line is evaluated.

**Marker Y Pos ← Event**

The value of a specific marker triggers the actions. The marker must be active in the current measurement channel for the rule to be processed (see ["Marker State"](#) on page 342).



The screenshot shows a configuration window titled "Event(s)". It contains several dropdown menus and a text input field. The "Marker Y Pos" dropdown is selected. The "Marker No." dropdown is set to "1". The "Norm Delta" dropdown is selected. The "Window No." dropdown is set to "1". Below these, the text "Marker value is" is followed by a dropdown menu set to "greater than" and a text input field containing "-20.0".

**Marker ← Marker Y Pos ← Event**

The marker whose value triggers the actions; only for marker 1: also the marker type ("Norm"/"Delta")

**Window ← Marker Y Pos ← Event**

Window in which the specified marker is evaluated.

**Trigger condition (Marker value is) ← Marker Y Pos ← Event**

The relation of the marker value to the specified value ("greater than" / "lower than") that triggers the actions

**Value ← Marker Y Pos ← Event**

Value with which the marker value is compared.

**Result Value ← Event**

The value of a specific result triggers the actions. Depending on the currently selected measurement, different result values are available (see [Chapter 6, "Measurements and results"](#), on page 127, [Chapter 8.7.4, "Reference: overview of available result-events and state-events"](#), on page 670).

The screenshot shows a configuration window titled "Event(s)". It contains several dropdown menus and a text input field. The "Result Value" dropdown is selected. The text "Value is" is followed by a dropdown menu set to "greater than" and a text input field containing "-20.0". The "Spectrum Emission Mask Tx Power" dropdown is also visible.

**Result ← Result Value ← Event**

The measurement result whose value is evaluated (see also [Chapter 8.7.4, "Reference: overview of available result-events and state-events"](#), on page 670).

**Trigger condition (Value is) ← Result Value ← Event**

The relation of the result value to the specified value ("greater than" / "lower than") that triggers the actions

**Value ← Result Value ← Event**

Value with which the result value is compared.

**State Value ← Event**

The measurement result whose state ("Pass" / "Fail") is evaluated. Depending on the currently selected measurement, different state results are available (see [Table 8-13](#)).

For example, a limit check for a specific result triggers the actions.

Event(s)			
State Value		Spurious Emissions Limit Check	
	Check for	Fail	

**Result ← State Value ← Event**

The measurement result whose state is evaluated (see also [Table 8-13](#)).

**Trigger condition (Check for) ← State Value ← Event**

The state ("Pass" / "Fail") that triggers the actions.

**Action**

Defines the actions to be taken when the specified events occur.

Depending on the selected action, further settings are available.

**Store Screenshot ← Action**

Creates and stores a screenshot of the current display to a file.

Action(s)			
Store Screenshot	C:\ES-MAIN\etv\SW\user	Browse ...	
Filename	ScreenShot_[Date]_[Time]	Format	PNG

**Storage location (Browse) ← Store Screenshot ← Action**

Defines the storage location of the screenshots. Enter the path of the target directory directly, or browse in the file explorer and select the directory there.

**File name ← Store Screenshot ← Action**

Defines the (generic) file name for the screenshots. If necessary, a consecutive number is added to the specified file name to create unique file names. Placeholders can be inserted in square brackets to create generic file names. The placeholders are replaced by current values at the time the screenshot is created.

The following placeholders are supported:

- [Year]
- [Month]
- [Day]
- [Hour]
- [Minute]
- [Second]
- [Date] = [Year]-[Month]-[Day]
- [Time]: =[Hour]-[Minute]-[Second]

**Example:**

The definition `ScreenShot_[Date]_[Time]` creates file names such as `ScreenShot_2018-12-14_12-49-51.PNG`, `ScreenShot_2018-12-14_12-50-01.PNG`.

**Format ← Store Screenshot ← Action**

Defines the image file format

**Stop Cont Sweep ← Action**

Stops a continuous sweep.

No further parameters required.

**Deactivate Rule ← Action**

Deactivates the rule after the specified number of trigger events occurred; useful to perform a single action only.

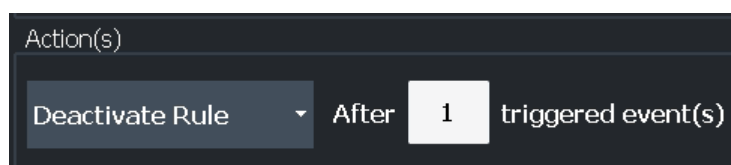
**Auto Level ← Action**

Automatically optimizes the level settings according to the current measurement.

**Note:** If several "Auto Level" actions are defined for the same rule or for multiple rules, only one "Auto Level" action is performed.

Combining an I/Q data export and the "Auto Level" function for the same event stops a continuous sweep.

**Trace Export ← Action**

Stores the current trace data to the specified file.

**Note:** Exporting trace data more than once for the same event is not possible (and not useful), even if the event is specified for multiple rules.

Define the path and (generic) file name. The default directory is C:\R\_S\INSTR\USER. If necessary, a consecutive number is added to the specified file name to create unique file names. Placeholders can be inserted in square brackets to create generic file names. The placeholders are replaced by current values at the time the data is exported.

The following placeholders are supported:

- [Date] = [Year] - [Month] - [Day]
- [Time]: = [Hour] - [Minute] - [Second]

**Browse ← Trace Export ← Action**

Opens a file-selection dialog box to select the directory for exported traces.

**Mode ← Trace Export ← Action**

Defines whether all traces or only user-defined traces are exported (as defined in [Trace] > "Trace export" settings).

**I/Q Export ← Action**

Stores the current I/Q data to the specified file. Only available for I/Q-based applications.

**Note:** Exporting I/Q data more than once for the same event is not possible (and not useful), even if the event is specified for multiple rules.

Combining an I/Q data export and the "Auto Level" function for the same event stops a continuous sweep.

Define the path and (generic) file name. The default directory is C:\R\_S\INSTR\USER. If necessary, a consecutive number is added to the specified file name to create unique file names. Placeholders can be inserted in square brackets to create generic file names. The placeholders are replaced by current values at the time the data is exported.

The following placeholders are supported:

- [Date] = [Year] - [Month] - [Day]
- [Time]: = [Hour] - [Minute] - [Second]

Select "Browse" to select the directory for exported data from a file-selection dialog box.

### Start Program/Script ← Action

Executes the specified program, script, or command, for example a user-defined script or an external application. The command is executed asynchronously to the measurement, that is: the measurement continues without waiting for the command to finish execution. However, you can combine the action "Stop continuous sweep" with the "Start Program/Script" to retain the processed measurement results (see "Add Action" on page 668).

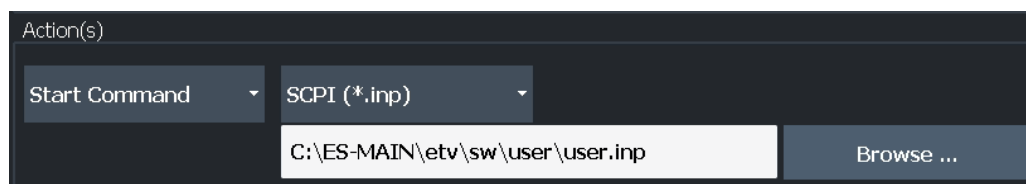

### Type ← Start Program/Script ← Action

Defines the type of command to be executed, which determines the application required to execute the command. For example, a SCPI command script (\*.inp) is executed in the R&S IECWIN tool.

### Program/script (Browse) ← Start Program/Script ← Action

Defines the path and file name of the script or program to be executed; invalid (not available) file names are indicated by red font.

### Add Action

Adds another action to be taken when the specified events occur. You can define up to 3 different actions. The order in which the actions are defined is irrelevant.

If several actions are scheduled due to one or more rules, the actions are performed in the following order (if specified):

1. [Store Screenshot](#)
2. [Auto Level](#)
3. [Start Program/Script](#)

Any other actions are performed in parallel.

### Remove Action

Removes the corresponding action from the rule.

**Save**

Saves the rule definition. Saving is only available if the rule definition is valid. Invalid parts of the definition are indicated by red font, for example if the specified command name, result, or limit line does not exist. Other validity checks are not performed.

**8.7.3 Debugging rules with the EBA-Journal**

**Access:** "Event-based actions" > "Show Journal"

The event-based actions journal shows the logging information for the rules defined in the EBA manager. This information is useful to debug rules when actions are not performed as expected.

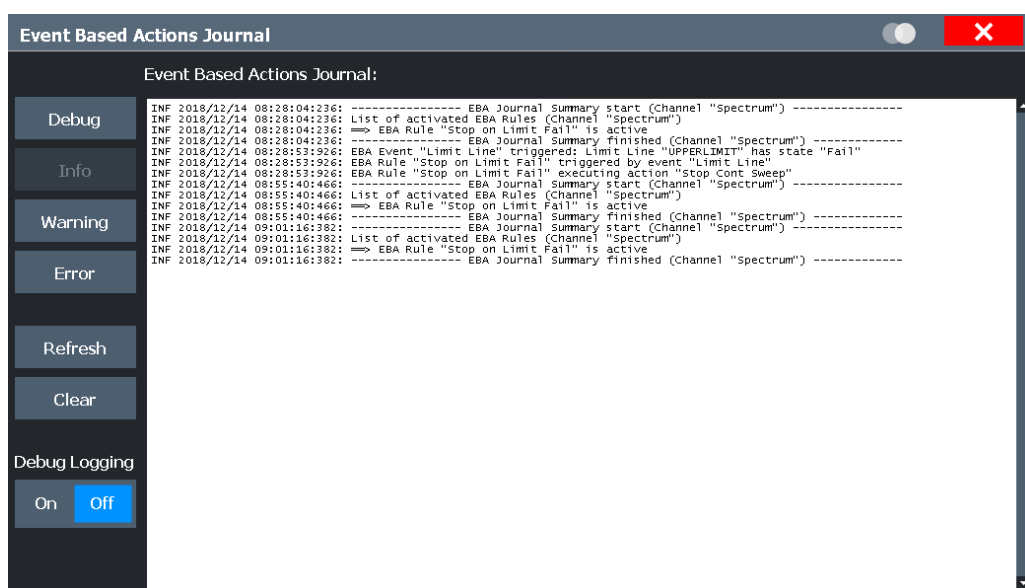

<a href="#">Debug / Info / Warning / Error</a> .....	669
<a href="#">Refresh</a> .....	670
<a href="#">Clear</a> .....	670
<a href="#">Debug Logging</a> .....	670

**Debug / Info / Warning / Error**

Determines which level of information is provided in the journal, depending on its importance. Each level displays information of the selected level or higher. The type of information is indicated in the log display.

"DBG"	Additional descriptions as debugging information (only if <a href="#">Debug Logging</a> is enabled).
"INF"	Basic information on triggering events or executed actions defined by the active rules
"WNG"	Information on possibly unexpected results due to conflicting rule definitions, for example if an "Auto Level" action causes the EBA manager to pause execution of further actions
"ERR"	Errors concerning failed rules, for example due to missing action command or invalid trigger event

**Refresh**

Updates the journal display to include the latest information (since journal was opened or last updated).

**Clear**

Clears all currently stored information in the journal

**Debug Logging**

If enabled, additional debug information is logged in the journal. Since this information requires large amounts of storage space and can slow down the performance of the firmware, use this mode carefully and only when necessary for troubleshooting. Debug mode is automatically disabled when you close the "EBA Journal" dialog.

**8.7.4 Reference: overview of available result-events and state-events**

Using the event-based actions, you can define actions to be performed depending on the values or states of specific results (see [Result Value](#) and ["State Value"](#) on page 665). The following overview shows you which results and states are available for which measurements.

**Table 8-13: Available result and state events**

Measurement	Results	States
Channel power ACLR	Channel Power ACLR Tx Total	Channel Power ACLR
	Channel Power ACLR Tx<1-n>	
	Channel Power ACLR Adj Lower	
	Channel Power ACLR Adj Upper	
	Channel Power ACLR Alt<1-n> Lower	
	Channel Power ACLR Alt<1-n> Upper	
Carrier-to-Noise	C/N	
	C/N <sub>0</sub>	
OBW	OBW Occ BW	
	OBW Occ BW Freq Offset	
Statistics	APD Crest (TRC <1-6>)	
	CCDF Crest (TRC <1-6>)	
Spectrum Emission Mask	Spectrum Emission Mask Tx Power	Spectrum Emission Mask Limit Check
Spurious Emissions		Spurious Emissions Limit Check
Time Domain Power	Time Domain Power Peak	
	Time Domain Power RMS	
	Time Domain Power Mean	
	Time Domain Power Std Dev	

Measurement	Results	States
Noise Power Ratio	NPR Channel Power Density	
	NPR Notch Power Density	

## 9 Optimizing measurements

### 9.1 Minimizing the measurement duration

If you want to minimize the measurement duration, try the following methods to optimize the measurement:

- Reduce the **span** of the measurement to the relevant parts of the signal only.
- Increase the **RBW** to minimize the measurement time; however, consider the requirements of the standard if you need to measure according to standard!
- Take advantage of the **speed optimization mode** in the "Sweep" settings if you do not require the larger dynamic range (see "[Optimization](#)" on page 504).
- Reduce the **sweep time** and thus the amount of data to be captured and calculated; however, consider the requirements regarding the standard deviation.
- To determine average (or peak) values, use an **RMS detector (or peak detector) with a higher sweep time** instead of trace averaging to obtain better average power results in less time. Furthermore, enforce the use of the **sweep type "FFT"** (as opposed to "Auto"; in Sweep mode, the averaging effect of the RMS detector may be less efficient).
- When performing multiple measurements, use **multiple channels** to switch between measurements rather than changing the settings within one channel repeatedly.  
Take advantage of the **Sequencer** function to switch between multiple measurements automatically or continuously (see also [Chapter 5.4, "Running a sequence of measurements"](#), on page 122).

#### Additional information

An application note discussing measurement speed optimization is available from the Rohde & Schwarz website:

[1EF90: Speeding up Spectrum Analyzer Measurements](#)

### 9.2 Improving averaging results

Instead of **trace averaging**, use an RMS detector with a higher sweep time to obtain better average power results in less time. Furthermore, enforce the use of the **sweep type "FFT"** (as opposed to "Auto"; in Sweep mode, the averaging effect of the RMS detector may be less efficient).

In FFT mode, FFTs are calculated per bin and combined using the RMS detector. For trace averaging, on the other hand, the local oscillator must be switched repeatedly for each trace, which takes additional time.



Generally, a higher **sweep time** leads to more data to be averaged and thus stabilizes the results. In FFT mode, a higher sweep time means more FFTs are calculated and combined per bin.

Thus, in the same capture time, the FFT mode with an RMS detector can provide better results than an averaged trace.

## 10 Data management

The FSW allows you to store and load instrument settings, as well as import and export measurement data for analysis later. Finally, you can store or print the measurement results displayed on the screen.

General storage and import/export functions are available via the toolbar. Some special storage functions are (also) available via softkeys or dialog boxes in the corresponding menus, for example trace data export.

See [Chapter 8.6, "Importing and exporting measurement results for evaluation"](#), on page 648 for RF measurements in the Spectrum mode, or the description of the specific applications.

- [Restoring the default instrument configuration \(preset\)](#)..... 674
- [Protecting data using the secure user mode](#).....675
- [Storing and recalling instrument settings and measurement data](#)..... 677
- [Import/export functions](#).....689
- [Creating screenshots of current measurement results and settings](#).....693
- [Working with test reports](#).....710

### 10.1 Restoring the default instrument configuration (preset)

When delivered, the FSW has a default configuration. You can restore this defined initial state at any time as a known starting point for measurements. This is often recommendable as a first step in troubleshooting when unusual measurement results arise.



#### Factory default configuration

The factory default configuration is selected such that the RF input is always protected against overload, provided that the applied signal levels are in the allowed range for the instrument.

Alternatively to the factory default settings, you can define user-specific recall settings to be restored after a preset or reboot, see ["To recall settings automatically after preset or reboot"](#) on page 689.

#### To restore the default instrument configuration for all channels at once

- ▶ Press [PRESET].



After you use the [PRESET] function, the history of previous actions is deleted, i.e. any actions performed previously cannot be undone or redone using the [UNDO/REDO] keys.

#### Remote command:

\*RST or SYSTem:PRESet

### To restore the default configuration for a single channel

The default measurement settings can also be reset for an individual channel only, rather than resetting the entire instrument.

- ▶ In the "Overview", select "Preset Channel".

The factory default settings are restored to the current channel. Note that a user-defined recall settings file is **NOT** restored.

#### Remote command:

`SYSTem:PRESet:CHANnel[:EXEC]` on page 1362

## 10.2 Protecting data using the secure user mode

During normal operation, the FSW uses a solid-state drive to store its operating system, instrument firmware, instrument self-alignment data, and any user data created during operation.

If necessary, the solid-state drive can be removed from the FSW and locked in a secure place to protect any classified data it may contain.

### Redirecting storage to volatile memory

Alternatively, to avoid storing any sensitive data on the FSW permanently, the *secure user mode* was introduced (option R&S FSW-K33). In secure user mode, the instrument's solid-state drive is write-protected so that no information can be written to memory permanently. Data that the FSW normally stores on the solid-state drive is redirected to volatile memory instead, which remains available only until the instrument is switched off. This data includes:

- Windows operating system files
- Firmware shutdown files containing information on last instrument state
- Self-alignment data
- General instrument settings such as the IP address
- Measurement settings
- User data created during operation (see also [Table 10-1](#))
- Any data created by other applications installed on the FSW, for example, text editors (Notepad), the clipboard, or drawing tools.

Users can access data that is stored in volatile memory just as in normal operation. However, when the instrument's power is switched off, all data in this memory is cleared. Thus, in secure user mode, the instrument always starts in a defined, fixed state when switched on.

To store data such as measurement results permanently, it must be stored to an external storage device, such as a memory stick.



### Limited storage space

The volatile memory used to store data in secure user mode is restricted to 256 MB. Thus, a "Memory full" error can occur although the hard disk indicates that storage space is still available.

### Storing required data permanently

Any data that is to be available for subsequent sessions with the FSW must be stored on the instrument permanently, *before activating the secure user mode*. This includes predefined instrument settings, transducer factors and self-alignment data.



### Self-alignment data

Note that self-alignment data becomes invalid with time and due to temperature changes. Therefore, to achieve optimal accuracy, it can be preferable to perform a new self-alignment at the start of each new session on the FSW.



### Windows updates

In secure user mode, in rare cases, Windows updates trigger a reboot. We recommend using secure user mode on R&S FSW-K33 only in private LAN without access to the internet or disconnected to LAN to avoid unwanted Windows updates. In preparation for Windows updates, disable secure user mode temporarily.

### Restricted operation

Since permanent storage is not possible, the following functions are not available in secure user mode:

- Firmware update
- Activating a new option key

Furthermore, since the "SecureUser" used in secure user mode does not have administrator rights, **administrative tasks** such as LAN configuration and some general instrument settings are not available. Refer to the description of the basic instrument setup ([SETUP] menu) to find out which functions are affected.

### Activating and deactivating secure user mode

Only a user with administrator rights can activate (and deactivate) the secure user mode. Once activated, a restart is required. The special user "SecureUser" is then logged on to the FSW automatically using the auto-login function. While the secure user mode is active, a message is displayed in the status bar at the bottom of the screen.



### Secure passwords

By default, the initial password for both the administrator account and the "Secure-User" account is "894129". When the secure user mode is activated the first time after installation, you are prompted to change the passwords for all user accounts to improve system security. Although it is possible to continue without changing the passwords, it is strongly recommended that you do so.

You can change the password in Windows 10 for any user at any time via:

"Start > Settings > Account > SignIn Options > Password > Change"

To deactivate the secure user mode, the "SecureUser" must log off and a user with administrator rights must log on.



### Switching users when using the auto-login function

In the "Start" menu, select the arrow next to "Shut down" and then "Log off".

The "Login" dialog box is displayed, in which you can enter the different user account name and password.

The secure user mode setting and auto-login is automatically deactivated when another user logs on. The "SecureUser" is no longer available.

For users with administrator rights, the secure user mode setting is available in the general system configuration settings (see "[SecureUser Mode](#)" on page 792).

### Remote control

Initially after installation of the R&S FSW-K33 option, secure user mode must be enabled manually once before remote control is possible.

(See `SYSTEM:SECurity[:STATe].`)

Manual activation is necessary to prompt for a change of passwords.

## 10.3 Storing and recalling instrument settings and measurement data



**Access:** "Save"/ "Open" icon in the toolbar



Possibly you would like to restore or repeat a measurement you performed under specific conditions on the instrument. Or you want to evaluate imported data in another application on the FSW and would like to restore the measurement settings applied during measurement. In these cases, you can store and recall instrument and measurement settings, and possibly other related measurement data.

Two different methods are available for managing instrument settings:

- Quick Save/Quick Recall - a defined set of instrument settings or channels are stored or recalled quickly in just one step

- Configurable Save/Recall - a user-defined set of instrument settings or channels are stored to a definable storage location



### Restrictions when recalling measurement settings

When recalling a saved configuration file, the following restrictions apply:

- The FSW must support the frequency range defined in the configuration file.
- Configuration files created on a FSW with certain options in use do not work on an FSW without these options.
- Files created with newer firmware versions may not work with a previous version.
- Files created on an instrument other than the FSW do not work on the FSW.



### Saving instrument settings in secure user mode

Be sure to store instrument settings that you require beyond the current session before [SecureUser Mode](#) is enabled; see [Chapter 4.2.15, "Protecting data using the secure user mode"](#), on page 39.

Settings that are saved via QuickSave in secure user mode are only available during the current session. As soon as the power is switched off on the FSW, the data is cleared.



### Saving and recalling transducer and limit line settings

If a transducer file was in use when the save set was stored (with the save item "Current Settings" only) the FSW assumes that these transducer values should remain valid after every recall of that save set. Thus, even if the transducer file is changed and the original save set file is recalled later, the *originally stored* transducer values are recalled and applied to the measurement. In the "Edit" transducer dialog box, however, the *changed* transducer file values are displayed, as no updated transducer file was loaded.

The same applies to limit line settings.

The same applies to integrated measurements' weighting filter.

If you want to apply the changed transducer values after recalling the save set, you must force the application to reload the transducer file. To do so, simply open the "Edit Transducer" dialog box (see [Chapter 11.4.2, "Transducer settings"](#), on page 756) and toggle the "X-Axis" option from "Lin" to "log" and back. Due to that change, the transducer file is automatically reloaded, and the changed transducer values are applied to the current measurement. Now you can create a new save set with the updated transducer values.

Similarly, if you want to apply the changed limit values after recalling the save set, you must force the application to reload the limit file. To do so, simply open the "Edit Limit Line" dialog box (see [Chapter 8.4.2.2, "Limit line settings and functions"](#), on page 597) and toggle the "Y-Axis" unit. Due to that change, the limit line file is automatically reloaded, and the changed limit values are applied to the current measurement. Now a new save set with the updated limit values can be created.

- [Quick save/quick recall](#)..... 679
- [Configurable storage and recall](#)..... 681
- [How to save and load instrument settings](#)..... 687

### 10.3.1 Quick save/quick recall

The "Quick Save" and "Quick Recall" functions allow you to store instrument settings or channels very easily and quickly in one step. Up to ten different sets of settings can be stored to or recalled from "save sets". Each save set is identified by its storage date and type (instrument or specific "Channel") in the display. The save sets are stored in the `C:\R_S\INSTR\QuickSave` directory, in files named `QuickSave1.dfl` to `QuickSave10.dfl`. Only the current measurement settings are stored, not any additional data such as traces, limit line or transducer files (see [Chapter 10.3.2.1, "Stored data types"](#), on page 681).

Source calibration files for an optional external generator, if available, are included.



#### Saving instrument settings in secure user mode

Settings that are saved via Quick Save in secure user mode are stored to the SDRAM, and are only available during the current session. As soon as the power is switched off on the FSW, the data is cleared (see [Chapter 4.2.15, "Protecting data using the secure user mode"](#), on page 39).

During recall, save sets of type "Instrument" replace the settings of the entire instrument. All other save sets start a new channel with the stored settings.



If a channel with the same name as the "Channel" to be restored is already active, the name for the new channel is extended by a consecutive number:

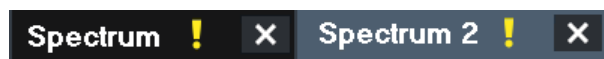

#### 10.3.1.1 Quick save / quick recall settings



**Access:** "Save"/ "Open" icon in the toolbar > "Quick Save" / "Quick Recall"



Both dialog boxes are very similar and closely related.

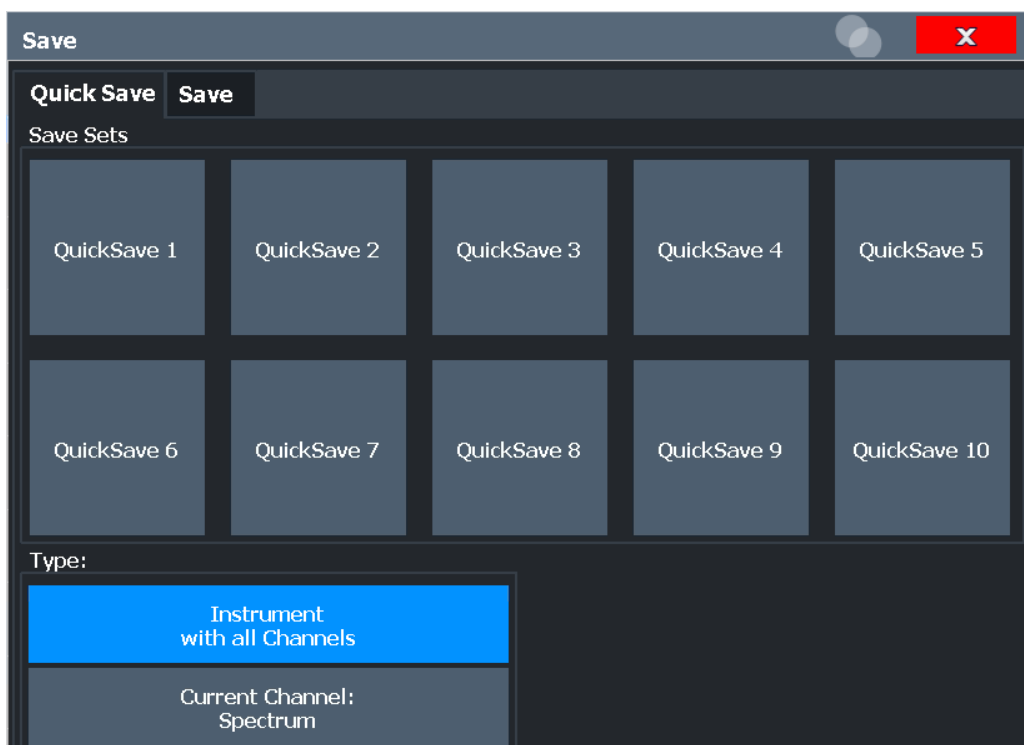

QuickSave 1 / ... / QuickSave 10..... 680  
     L Rename..... 681  
     L Write Protection..... 681  
 Storage Type (Save only)..... 681  
 Recall..... 681

**QuickSave 1 / ... / QuickSave 10**

Selects one of the save sets to store the current settings in or to be recalled. At the time of storage, the "QuickSave 1 / ... / QuickSave 10" placeholder is replaced by a label indicating the storage date and time and the storage type.

Right-click on one of the QuickSave buttons to display a context menu with additional functions for the save set.

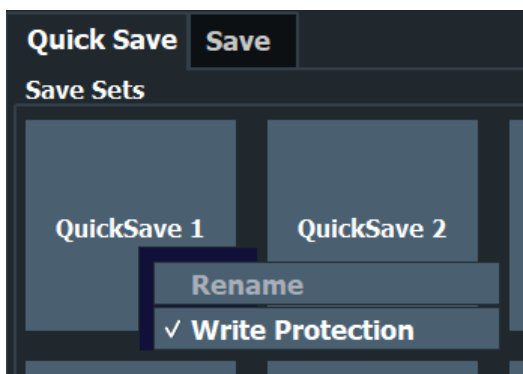

During recall, save sets of type "Instrument" replace the settings of the entire instrument. All other save sets start a new channel with the stored settings.



## Storing and recalling instrument settings and measurement data

**Note:** Saving instrument settings in secure user mode.

Settings that are saved via Quick Save in secure user mode are only available during the current session. As soon as the power is switched off on the FSW, the data is cleared (see [Chapter 4.2.15, "Protecting data using the secure user mode"](#), on page 39).

**Rename** ← **QuickSave 1 / ... / QuickSave 10**

Displays an input field to rename the save set, if write protection is disabled.

**Write Protection** ← **QuickSave 1 / ... / QuickSave 10**

Enables or disables write protection for the save set. If enabled, the save set cannot be renamed or overwritten.

**Storage Type (Save only)**

Defines which type of settings are stored in the save set.

"Instrument with all Channels"      The instrument settings for all currently active "Channel"s are stored.

"Current Channel"      Only the instrument settings for the currently selected measurement "Channel"s are stored.

**Recall**

Restores the instrument settings as saved in the selected settings file. If the settings file contains settings for a specific "Channel" only, a new channel with the stored settings is activated, otherwise all "Channel"s and instrument settings are overwritten with the stored settings.

**Note:** After you use the "Recall" function, the history of previous actions is deleted, i.e. any actions performed previously cannot be undone or redone using the [UNDO/REDO] keys.

Remote command:

[MMEMory:LOAD:STATe](#) on page 1358

## 10.3.2 Configurable storage and recall

The more sophisticated storage and recall functions allow you to define which settings are stored, and where the settings file is stored to. Any settings file can be selected for recall.

- [Stored data types](#).....681
- [Storage location and filename](#).....682
- [Save and recall dialog boxes](#).....683
- [Startup recall settings](#).....685

### 10.3.2.1 Stored data types

The following types of data can be stored to and loaded from files via the "Save" dialog box on the FSW:

## Storing and recalling instrument settings and measurement data

**Table 10-1: Items that can be stored to files**

Item	Description
Current Settings	Current instrument and measurement settings.
All Transducers	All transducer factor <i>files</i> . (Note: Restoring a saveset overwrites transducer factor files on the hard disk that have the same name as those in the saveset. For more information, see <a href="#">"Saving and recalling transducer and limit line settings"</a> on page 678.)
All Traces	All active traces.
All Limit Lines	All limit line <i>files</i> .
EBA Rules	Event based action rules See <a href="#">Chapter 8.7, "Event-based actions"</a> , on page 660
Source Cal Data	Source calibration data for an optional external generator (If available, see <a href="#">"Saving calibration results"</a> on page 380).
Spectrograms	Spectrogram trace data (only available if spectrogram display is currently active).

**10.3.2.2 Storage location and filename**

The data is stored on the internal flash disk or, if selected, on a memory stick or network drive. The operating system, firmware and stored instrument settings are located on drive C.

**Saving instrument settings in secure user mode**

In secure user mode all data is stored to the SDRAM, and is only available during the current session. As soon as the power is switched off on the FSW, the data is cleared (see [Chapter 4.2.15, "Protecting data using the secure user mode"](#), on page 39).

Other storage locations cannot be selected in this mode.

The storage location and filename are selected in a file selection dialog box which is displayed when you perform a storage function.

By default, the name of a settings file consists of a base name followed by an underscore and three numbers, e.g. `limit_lines_005`. In the example, the base name is `limit_lines`. The base name can contain characters, numbers and underscores. The file extension `df1` is added automatically. The default folder for settings files is `C:\R_S\INSTR\Save`.

**File name restrictions**

File names must be compatible with the Windows conventions for file names. In particular, they must not contain special characters such as `:", "*", "?"`.

10.3.2.3 Save and recall dialog boxes



**Access:** "Save"/ "Open" icon in the toolbar > "Save" / "Recall"



Both dialog boxes are very similar and closely related.

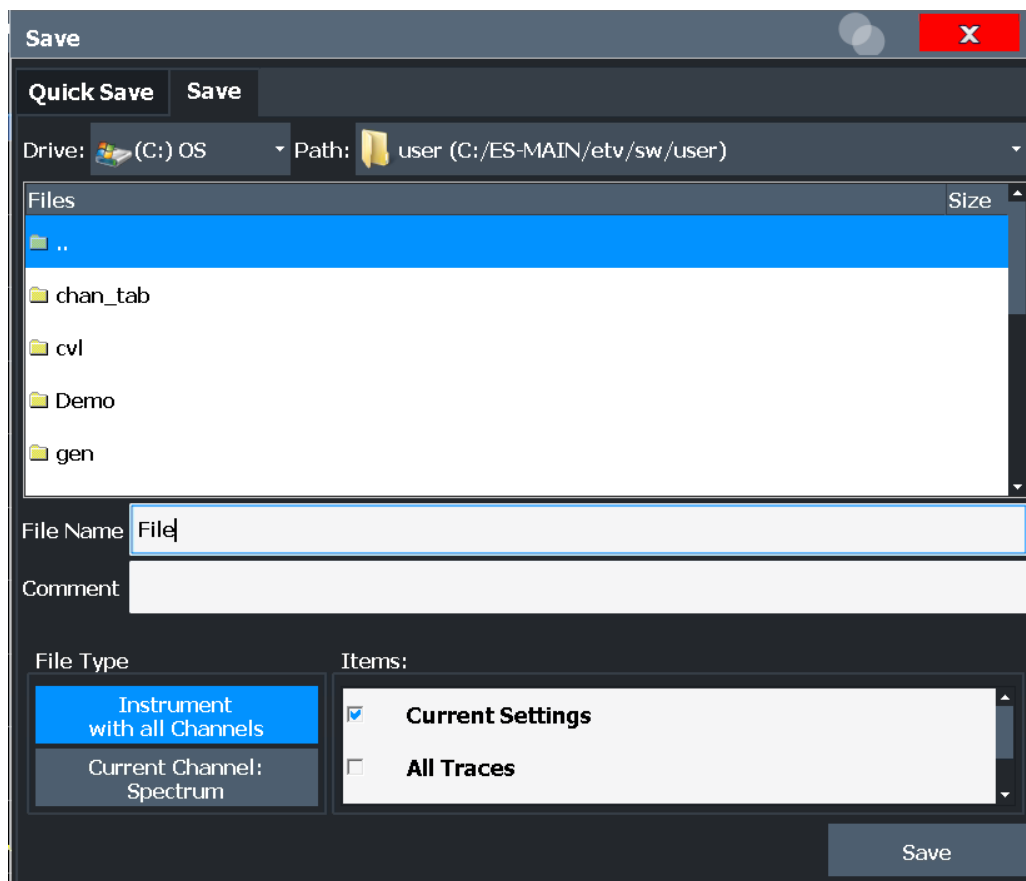

Selecting Storage Location - Drive/ Path/ Files.....683

File Name.....684

Comment.....684

File Explorer.....684

File Type.....684

Items:.....684

Save File.....685

Recall in New Channel / Recall in Current Channel.....685

**Selecting Storage Location - Drive/ Path/ Files**

Select the storage location of the file on the instrument or an external drive.

The default storage location for the SEM settings files is:

C:\Program Files (x86)\Rohde-Schwarz\FSW\<version>\sem\_std.

**Note:** Saving instrument settings in secure user mode.

In secure user mode, settings that are stored on the instrument are stored to volatile memory, which is restricted to 256 MB. Thus, a "memory limit reached" error can occur although the hard disk indicates that storage space is still available.

## Storing and recalling instrument settings and measurement data

To store data permanently, select an external storage location such as a USB memory device.

For details, see [Chapter 4.2.15, "Protecting data using the secure user mode"](#), on page 39.

Remote command:

[MMEMemory:CATalog](#) on page 1349

### File Name

Contains the name of the data file without the path or extension.

By default, the name of a user file consists of a base name followed by an underscore. Multiple files with the same base name are extended by three numbers, e.g.

`limit_lines_005.`

File names must be compatible with the Windows conventions for file names. In particular, they must not contain special characters such as ":", "\*", "?".

For details on the filename and location, see [Chapter 10.3.2.2, "Storage location and filename"](#), on page 682.

### Comment

An optional description for the data file. A maximum of 60 characters can be displayed.

Remote command:

[MMEMemory:COMMent](#) on page 1350

### File Explorer

Opens the Microsoft Windows File Explorer.

Remote command:

not supported

### File Type

Determines whether the global instrument settings with all "Channel"s are stored or recalled, or the current "Channel" settings only.

### Items:

Defines which data and settings are stored or are recalled. Depending on the "File Type", either channels only, or global settings are available. Which items are available also depends on the installed options (see also [Chapter 10.3.2.1, "Stored data types"](#), on page 681).

Remote command:

[MMEMemory:SElect\[:ITEM\]:ALL](#) on page 1354

[MMEMemory:SElect\[:ITEM\]:DEFault](#) on page 1355

[MMEMemory:SElect\[:ITEM\]:NONE](#) on page 1356

[MMEMemory:SElect\[:ITEM\]:HWSettings](#) on page 1355

[MMEMemory:SElect\[:ITEM\]:LINes:ALL](#) on page 1355

[MMEMemory:SElect\[:ITEM\]:SCData](#) on page 1356

[MMEMemory:SElect\[:ITEM\]:SGRam](#) on page 1356

[MMEMemory:SElect\[:ITEM\]:TRACe<1...3>\[:ACTive\]](#) on page 1357

[MMEMemory:SElect\[:ITEM\]:TRANsducer:ALL](#) on page 1357

**Save File**

Saves the settings file with the defined filename.

**Note:** Secure user mode. In secure user mode, settings that are stored on the instrument are stored to volatile memory, which is restricted to 256 MB. Thus, a "memory limit reached" error can occur although the hard disk indicates that storage space is still available.

For details, see [Chapter 4.2.15, "Protecting data using the secure user mode"](#), on page 39.

Remote command:

[MMEMory:STORe<1|2>:STATe](#) on page 1360

[MMEMory:STORe<1|2>:STATe:NEXT](#) on page 1360

**Recall in New Channel / Recall in Current Channel**

Restores the instrument settings as saved in the selected settings file. If the settings file contains settings for a specific "Channel" only, select "Recall in New Channel" to activate a new channel with the stored settings. Select "Recall in Current Channel" to replace the current "Channel" settings.

**Note:** After you use the "Recall" function, the history of previous actions is deleted, i.e. any actions performed previously cannot be undone or redone using the [UNDO/REDO] keys.

Remote command:

[MMEMory:LOAD:STATe](#) on page 1358

**10.3.2.4 Startup recall settings**

**Access:** "Open" icon in the toolbar > "Startup Recall"

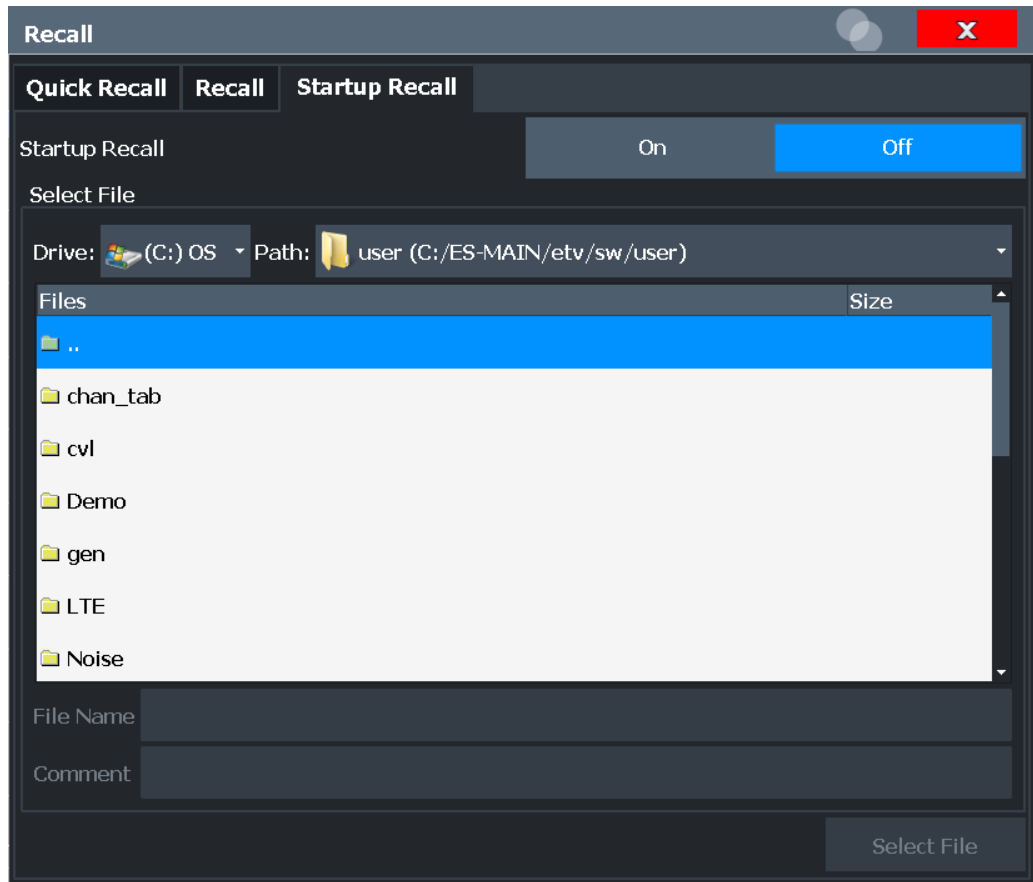

Startup Recall.....686  
 Selecting Storage Location - Drive/ Path/ Files.....686  
 File Name.....687  
 Comment.....687

**Startup Recall**

Activates or deactivates the startup recall function. If activated, the settings stored in the selected file are loaded each time the instrument is started or preset. If deactivated, the default settings are loaded.

Note that only *instrument* settings files can be selected for the startup recall function, not "Channel" files.

Remote command:

`MMEMoRY:LOAD:AUTO` on page 1358

**Selecting Storage Location - Drive/ Path/ Files**

Select the storage location of the file on the instrument or an external drive.

The default storage location for the SEM settings files is:

`C:\Program Files (x86)\Rohde-Schwarz\FSW\<version>\sem_std.`

**Note:** Saving instrument settings in secure user mode.

In secure user mode, settings that are stored on the instrument are stored to volatile memory, which is restricted to 256 MB. Thus, a "memory limit reached" error can occur although the hard disk indicates that storage space is still available.

## Storing and recalling instrument settings and measurement data

To store data permanently, select an external storage location such as a USB memory device.

For details, see [Chapter 4.2.15, "Protecting data using the secure user mode"](#), on page 39.

Remote command:

[MMEMoRY:CATalog](#) on page 1349

#### File Name

Contains the name of the data file without the path or extension.

By default, the name of a user file consists of a base name followed by an underscore. Multiple files with the same base name are extended by three numbers, e.g. `limit_lines_005`.

File names must be compatible with the Windows conventions for file names. In particular, they must not contain special characters such as ":", "\*", "?".

For details on the filename and location, see [Chapter 10.3.2.2, "Storage location and filename"](#), on page 682.

#### Comment

An optional description for the data file. A maximum of 60 characters can be displayed.

Remote command:

[MMEMoRY:COMMeNt](#) on page 1350

### 10.3.3 How to save and load instrument settings

Instrument settings can be saved to a file and loaded again later, so that you can repeat the measurement with the same settings. Optionally, user-defined measurement settings can automatically be restored each time you start or preset the instrument.

#### To save and recall instrument settings using the Quick Save function



1. Select the "Save" icon from the toolbar.
2. Select whether the instrument settings for **all** "Channel"s are stored, or only those for the **current** "Channel".
3. Select one of the save sets in which the settings are stored ("QuickSaveX").

The selected settings are stored to the file

`C:\R_S\INSTR\QuickSave\QuickSaveX.dfl`.

**Note:** If you make any changes to the settings *after* storing the configuration file, remember to save the settings again. Otherwise those settings cannot be restored and will be overwritten by the stored values when the configuration file is recalled.



4. To restore the settings, select the "Open" icon from the toolbar.
5. Select the save set in which the settings were stored ("QuickSaveX").  
The selected settings are restored to the instrument or channel.

### To save configurable instrument settings



1. Select the "Save" icon from the toolbar.
2. In the "Save" dialog box, switch to the "Save" tab.
3. In the file selection dialog box, select a filename and storage location for the settings file.
4. Optionally, define a comment to describe the stored settings.
5. Select whether the instrument settings for **all**"Channel"s are stored, or only those for the **current**"Channel".
6. Select the items to be saved with the settings. Either the settings for the currently selected "Channel" only, or the settings for all "Channel"s can be stored. Various other items, such as lines or traces etc., can be stored as well (see [Chapter 10.3.2.1, "Stored data types"](#), on page 681).
7. Select "Save".

A file with the defined name and path and the extension `.df1` is created.



If you make any changes to the settings *after* storing the configuration file, remember to save the settings again. Otherwise those settings cannot be restored and will be overwritten by the stored values when the configuration file is recalled.

### To recall configurable instrument settings



1. Select the "Open" icon from the toolbar.
2. In the "Recall" dialog box, switch to the "Recall" tab.
3. In the file selection dialog box, select the filename and storage location of the settings file.  
**Note:** The "File Type" indicates whether the file contains instrument settings for **all**"Channel"s, or only those for the current "Channel".
4. If several items were saved, select which items are restored.
5. If a "Channel" was saved, select whether the settings will replace the settings in the current "Channel", or whether a new channel with the saved settings will be opened.
6. Select "Recall".

The settings and selected items from the saved measurement are restored and you can repeat the measurement with the same settings.

Note that any changes made to the settings *after* storing the configuration file will be overwritten by the stored values when the configuration file is recalled.



### To recall settings automatically after preset or reboot

You can define the settings that are restored when you preset or reboot the instrument.

1. Configure the settings as required and save them as described in "[To save configurable instrument settings](#)" on page 688.
2. In the "Save/Recall" menu, select "Startup Recall".
3. From the file selection dialog box, select the recall settings to restore.
4. Select "Select File".
5. Set "Startup Recall" to "On".

Now when you press [PRESET] or reboot the instrument, the defined settings will be restored.

6. To restore the factory preset settings, set "Startup Recall" to "Off".

## 10.4 Import/export functions



**Access:** "Save"/ "Open" icon in the toolbar > "Import" / "Export"



The FSW provides various evaluation methods for the results of the performed measurements. However, you may want to evaluate the data with further, external applications. In this case, you can export the measurement data to a standard format file (ASCII or XML). Some of the data stored in these formats can also be re-imported to the FSW for further evaluation later, for example in other applications.

The following data types can be exported (depending on the application):

- Trace data
- Table results, such as result summaries, marker peak lists etc.
- I/Q data

The following data types can be imported (depending on the application):

- I/Q data



I/Q data can only be imported and exported in applications that process I/Q data, such as the I/Q Analyzer or optional applications.

See the corresponding user manuals for those applications for details.



These functions are only available if no measurement is running.

In particular, if [Continuous Sweep / Run Cont](#) is active, the import/export functions are not available.

<a href="#">Import</a> .....	690
<a href="#">Export</a> .....	690
L <a href="#">Export Trace to ASCII File</a> .....	690
L <a href="#">File Type</a> .....	692

L	Decimal Separator.....	692
L	Column Separator.....	692
L	File Explorer.....	692
L	Export Configuration.....	692
L	I/Q Export.....	692
L	File Type.....	693
L	File Explorer.....	693



### Import

**Access:** "Save/Recall" > Import



Provides functions to import data.

Importing trace data is only available via the "Trace Config" dialog box, see [Chapter 8.6.2, "Trace/data ex/import"](#), on page 650.

I/Q data can only be imported by applications that process I/Q data.

Importing I/Q data is not possible in MSRA operating mode.

See the FSW I/Q Analyzer user manual for more information.



### Export

**Access:** "Save/Recall" > Export



Opens a submenu to configure data export.

#### Export Trace to ASCII File ← Export

Saves the selected trace or all traces in the currently active result display to the specified file and directory in the selected ASCII format.

"File Explorer": Instead of using the file manager of the FSW firmware, you can also use the Microsoft Windows File Explorer to manage files.

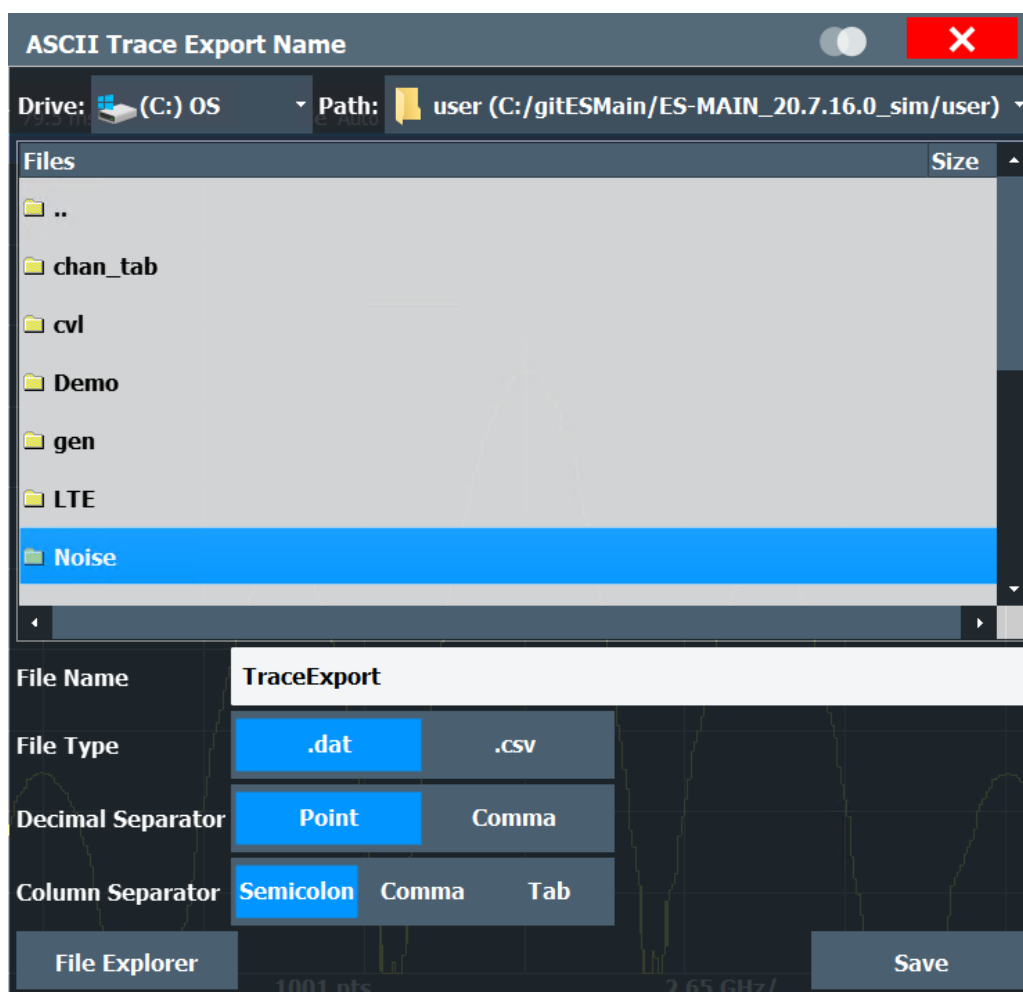

If the spectrogram display is selected when you perform this function, the entire histogram buffer with all frames is exported to a file. The data for a particular frame begins with information about the frame number and the time that frame was recorded. For large history buffers the export operation can take some time.

For details on the file format in the Spectrum application, see [Chapter 8.6.6, "Reference: ASCII file export format"](#), on page 657.

**Note:** Secure user mode.

In secure user mode, settings that are stored on the instrument are stored to volatile memory, which is restricted to 256 MB. Thus, a "memory limit reached" error can occur although the hard disk indicates that storage space is still available.

To store data permanently, select an external storage location such as a USB memory device.

For details, see [Chapter 4.2.15, "Protecting data using the secure user mode"](#), on page 39.

Remote command:

[MMEMory:STORe<n>:TRACe](#) on page 1265

[MMEMory:STORe<n>:SPECTrogram](#) on page 1374

**File Type ← Export Trace to ASCII File ← Export**

Determines the format of the ASCII file to be imported or exported.

Depending on the external program in which the data file was created or is evaluated, a comma-separated list (CSV) or a plain data format (DAT) file is required.

Remote command:

[FORMat:DEXPort:FORMat](#) on page 1263

**Decimal Separator ← Export Trace to ASCII File ← Export**

Defines the decimal separator for floating-point numerals for the data export/import files. Evaluation programs require different separators in different languages.

Remote command:

[FORMat:DEXPort:DSEParator](#) on page 1348

**Column Separator ← Export Trace to ASCII File ← Export**

Selects the character that separates columns in the exported ASCII file. The character can be either a semicolon, a comma or a tabulator (tab).

Example for semicolon:

```
Type;FSW13;Version;1.00;Date;01.Jan 3000;
```

Example for comma:

```
Type,FSW13,
Version,1.00,
Date,01.Jan 3000,
```

Example for tabulator (tab after the last column is not visible):

```
Type      FSW13
Version   1.00
Date     01.Jan 3000
```

The selected column separator setting remains the same, even after a preset.

Remote command:

[FORMat:DEXPort:CSEParator](#) on page 1262

**File Explorer ← Export Trace to ASCII File ← Export**

Opens the Microsoft Windows File Explorer.

Remote command:

not supported

**Export Configuration ← Export**

Opens the "Traces" dialog box to configure the trace and data export settings.

[Chapter 8.6.2, "Trace/data ex/import"](#), on page 650

**I/Q Export ← Export**

Opens a file selection dialog box to define an export file name to which the I/Q data is stored. This function is only available in single sweep mode.

It is not available in the Spectrum application, only in applications that process I/Q data, such as the I/Q Analyzer or optional applications.

## Creating screenshots of current measurement results and settings

For details, see the description in the FSW I/Q Analyzer User Manual ("Importing and Exporting I/Q Data").

**Note:** Storing large amounts of I/Q data (several Gigabytes) can exceed the available (internal) storage space on the FSW. In this case, it can be necessary to use an external storage medium.

**Note:** Secure user mode.

In secure user mode, settings that are stored on the instrument are stored to volatile memory, which is restricted to 256 MB. Thus, a "memory limit reached" error can occur although the hard disk indicates that storage space is still available.

To store data permanently, select an external storage location such as a USB memory device.

For details, see [Chapter 4.2.15, "Protecting data using the secure user mode"](#), on page 39.

#### File Type ← I/Q Export ← Export

The I/Q data file can be stored in one of the following supported formats:

- .iq.tar
- .iqw
- .csv
- .mat
- .aid

**Note:** Not all applications support all formats.

Remote command:

The file type is determined by the file extension of the file name parameter. If no file extension is provided, the file type is assumed to be .iq.tar. For .mat files, Matlab® v4 is assumed.

#### File Explorer ← I/Q Export ← Export

Opens the Microsoft Windows File Explorer.

Remote command:

not supported

## 10.5 Creating screenshots of current measurement results and settings

To document the graphical results and the most important settings for the currently performed measurement, you can create a screenshot of the current display. Screenshots can either be printed or stored to a file.

- [Print and screenshot settings](#).....694
- [How to store or print screenshots of the display](#)..... 705
- [Example for storing multiple measurement results to a PDF file](#)..... 708

## 10.5.1 Print and screenshot settings



**Access:** "Print" icon in the toolbar

For step-by-step instructions, see [Chapter 10.5.2, "How to store or print screenshots of the display"](#), on page 705.

Remote commands for these settings are described in [Chapter 13.9.4, "Storing or printing screenshots"](#), on page 1362.



To print a screenshot of the current display with the current settings immediately, without switching to the "Print" menu, use the "SnapShot" icon in the toolbar.

- [Print content settings](#).....694
- [Print preview functions](#).....697
- [Printer settings](#).....699
- [Page setup](#).....702
- [Print color settings](#).....704

### 10.5.1.1 Print content settings



**Access:** "Print" > "Print Config" > "Content" tab

The content settings determine which data is included in the printout.

Note that some content settings are independent of the selected printing device, others are printing device-specific.

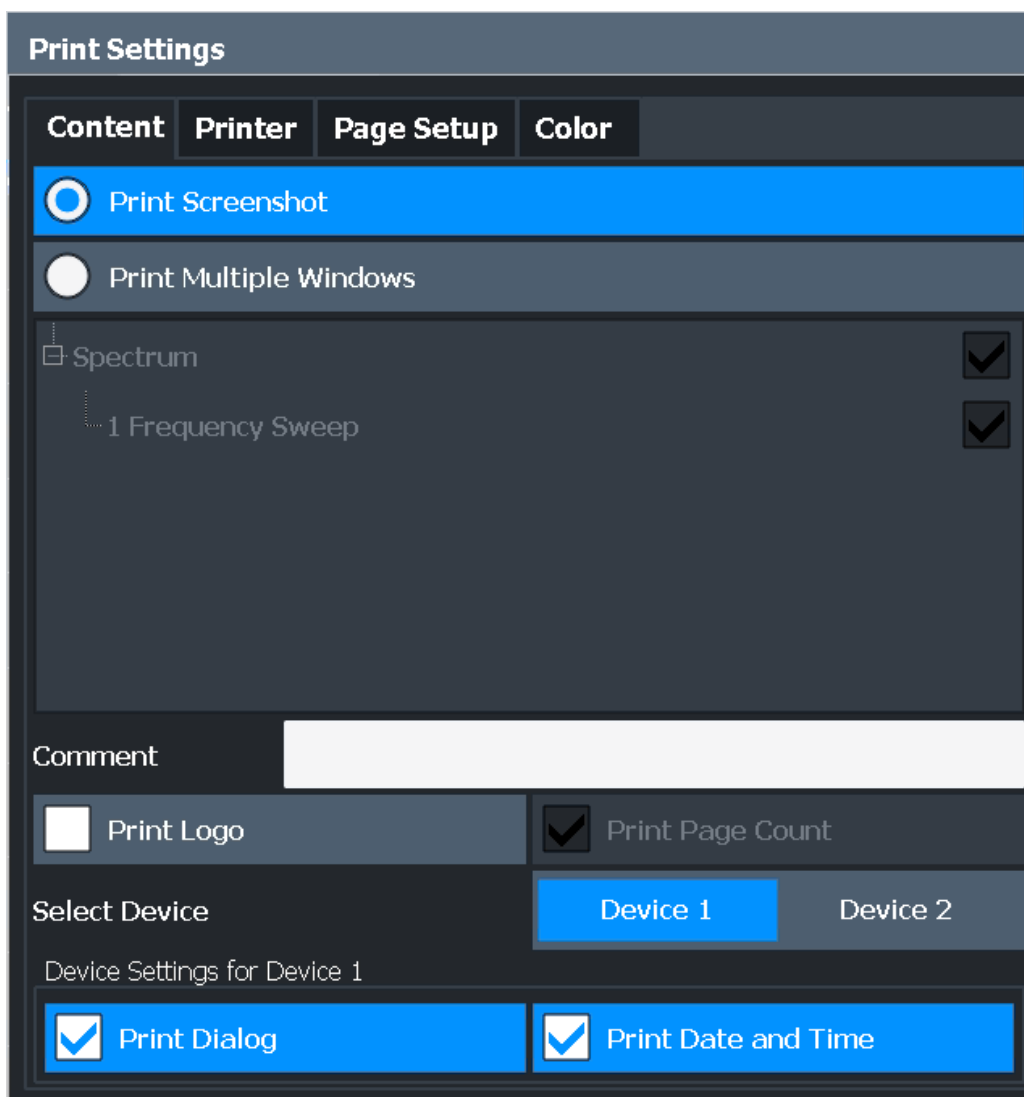

Print Screenshot.....	695
Print Multiple Windows.....	696
Comment.....	696
Print Logo.....	696
Print Page Count.....	696
Select Device 1/2.....	696
Print Dialog.....	697
Print Date and Time.....	697

**Print Screenshot**

Selects all measurement results displayed on the screen for the current channel (or "MultiView"): diagrams, traces, markers, marker lists, limit lines, etc., including the channel bar and status bar, for printout on a single page. Displayed items belonging to the software user interface (e.g. softkeys) are not included. The position and size of the elements in the printout is identical to the display.

This setting is independent of the printing device.

Remote command:

[HCOPY:CONTent](#) on page 1363

### Print Multiple Windows

Includes only the selected windows in the printout. All currently active windows for the current channel (or "MultiView") are available for selection. How many windows are printed on a single page of the printout is user-definable (see "[Windows Per Page](#)" on page 704).

This option is only available when printing on a printer or to a PDF file (see "[Destination](#)" on page 701). If the [Destination](#) is currently set to an image file or the clipboard for the selected printing device, it is automatically changed to be a PDF file.

Remote command:

[HCOPY:CONTent](#) on page 1363

[HCOPY:PAGE:WINDow:STATe](#) on page 1371

[HCOPY:PAGE:WINDow:CHANnel:STATe](#) on page 1370

### Comment

Defines an optional comment to be included in the printout of the display. Maximum 120 characters are allowed. Up to 60 characters fit in one line. In the first line, a manual line-feed can be forced at any point by entering "@".

The comment is printed in the top left corner of each printout page. If a comment should not be printed, it must be deleted.

This setting is independent of the printing device.

**Tip:** The current date and time can be inserted automatically, see "[Print Date and Time](#)" on page 697.

Remote command:

[HCOPY:ITEM:WINDow:TEXT](#) on page 1368

### Print Logo

Activates/deactivates the printout of the Rohde & Schwarz company logo in the upper right corner.

This setting is independent of the printing device.

Remote command:

[DISPlay:LOGO](#) on page 1363

### Print Page Count

Includes the page number for printouts consisting of multiple windows ("[Print Multiple Windows](#)" on page 696).

This setting is independent of the printing device.

Remote command:

[HCOPY:PAGE:COUNt:STATe](#) on page 1368

### Select Device 1/2

Selects the printing device to be configured.



## Creating screenshots of current measurement results and settings

Two different printout devices can be configured, for example one for printing and one for storage to a file. When you execute the "SnapShot" function, the selected printing device and its settings determine the behavior of the FSW.

**Print Dialog**

Includes any currently displayed dialog in the screenshot printout.

This setting is (printing) device-specific and only available if [Print Screenshot](#) is selected.

**Print Date and Time**

Includes or removes the current date and time at the bottom of the printout.

This setting is (printing) device-specific.

Remote command:

[HCOPY:TDSTamp:STATe](#) on page 1371

**10.5.1.2 Print preview functions**

**Access:** "Print"

The "Print Preview" of the printout according to the current configuration is available in all "Print Settings" dialog tabs.

The preview display (not the functions) is device-specific (see ["Select Device 1/2"](#) on page 696).

Creating screenshots of current measurement results and settings

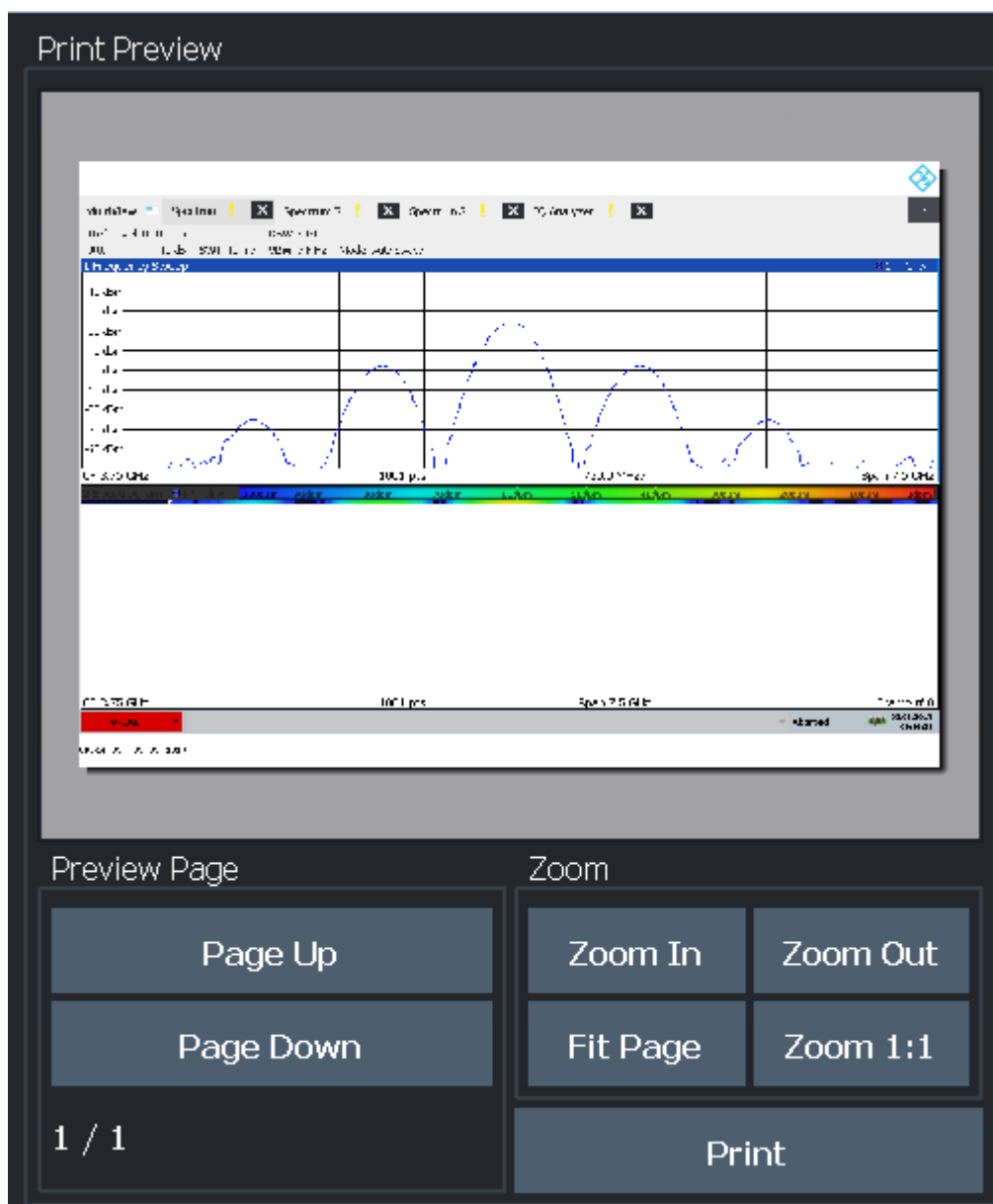

Zoom In / Zoom Out.....	698
Fit Page.....	699
Zoom 1:1.....	699
Page Up / Page Down.....	699
Print.....	699

**Zoom In / Zoom Out**

Zooms into (enlarges) or zooms out of (decreases) the preview display. Note that the zoom functions affect only the preview, not the printout itself.

**Fit Page**

Adapts the preview display zoom factor so that one complete page is visible as large as possible in the available display space. Note that the zoom functions affect only the preview, not the printout itself.

**Zoom 1:1**

Displays the printout in its original size, as it will be printed.

**Page Up / Page Down**

Depending on the selected contents (see [Chapter 10.5.1.1, "Print content settings"](#), on page 694), the printout can consist of multiple pages. Use these functions to scroll within the preview to see the individual pages.

**Print**

Starts to print or store the selected screen contents to a file (see [Chapter 10.5.1.1, "Print content settings"](#), on page 694).

Whether the output is sent to the printer or stored in a file or the clipboard depends on the selected printing device and the printing device settings (see [Chapter 10.5.1.3, "Printer settings"](#), on page 699).

If the output is stored to a file, a file selection dialog box is opened to select the file-name and location. The default path is C:\R\_S\INSTR\USER.

Remote command:

[HCOPY\[:IMMEDIATE\]](#) on page 1367

[HCOPY\[:IMMEDIATE\]:NEXT](#) on page 1367

**10.5.1.3 Printer settings**

**Access:** "Print" > "Print Config" > "Printer" tab

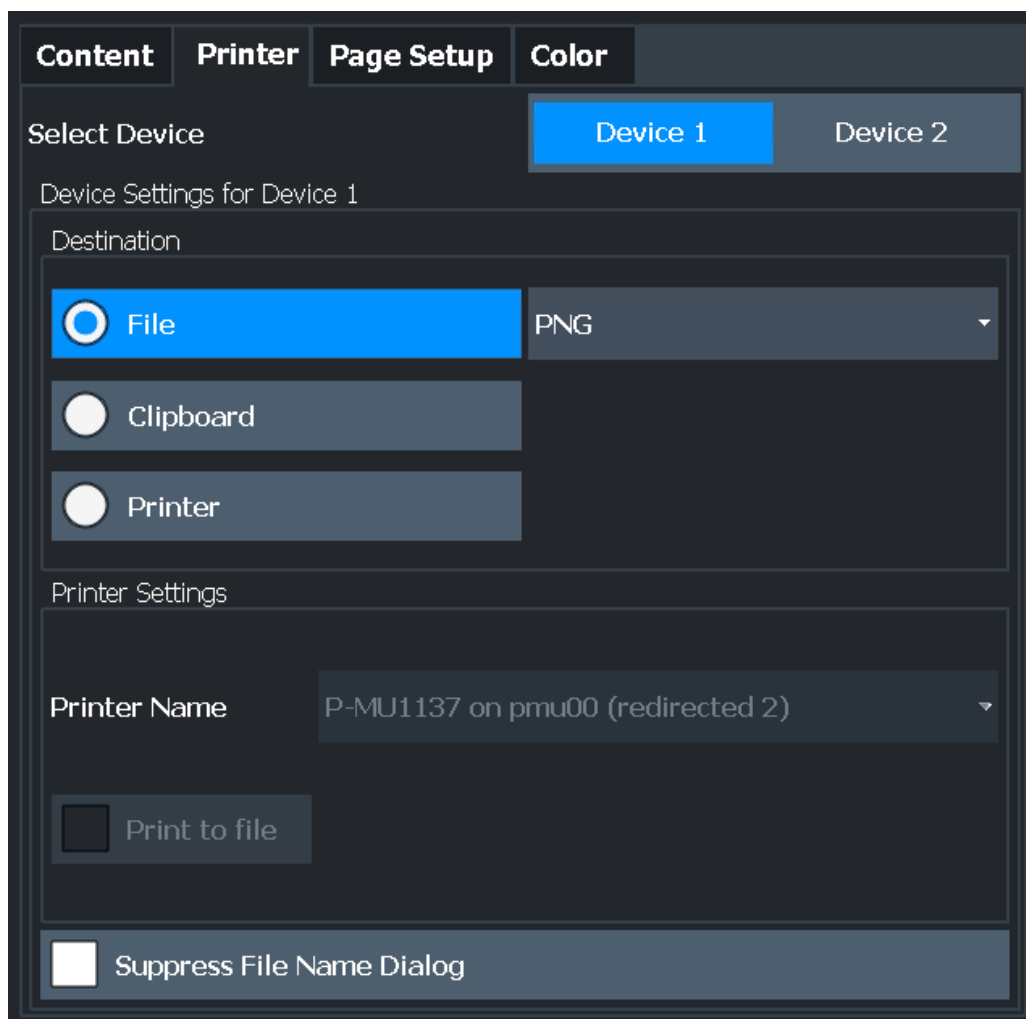

**i** Printer settings are (printing) device-specific. That means you can configure two different printing devices (for example, a printer and a file) and switch between configurations easily simply by selecting the appropriate device before printing.

Select Device 1/2.....	700
Destination.....	701
L Destination: File.....	701
L Destination: Clipboard.....	701
L Destination: Printer.....	701
Suppress File Name Dialog.....	701
Printer Name.....	701
Print to file.....	702
Install Printer.....	702

**Select Device 1/2**

Selects the printing device to be configured.

## Creating screenshots of current measurement results and settings

Two different printout devices can be configured, for example one for printing and one for storage to a file. When you execute the "SnapShot" function, the selected printing device and its settings determine the behavior of the FSW.

**Destination**

Defines the medium to which the printout is output.

**Destination: File ← Destination**

Stores the printout to a file in the selected format. The filename is queried at the time of storage, or a default name is used (see [Suppress File Name Dialog](#)).

Multiple windows can only be printed to a file in PDF format. If you select an image file format, the content setting is automatically set to [Print Screenshot](#). Page settings are not available for image files; however, you can configure the colors used for the screenshot (see [Chapter 10.5.1.5, "Print color settings"](#), on page 704).

Remote command:

To save as a file:

```
HCOPY:DESTination<di> 'MMEM'
```

To save as a file in the specified format:

```
HCOPY:DEVIce:LANGUage on page 1367
```

**Destination: Clipboard ← Destination**

Copies the printout to the clipboard. Since only single pages can be copied, only screenshots can be copied to this destination, not multiple windows (see [Chapter 10.5.1.1, "Print content settings"](#), on page 694). Page settings are not available; however, you can configure the colors used for the screenshot (see [Chapter 10.5.1.5, "Print color settings"](#), on page 704).

If you select the clipboard as the printing destination, the content setting is automatically set to [Print Screenshot](#).

Remote command:

```
HCOP:DEST1 'SYSTem:COMMunicate:CLIPboard'
```

**Destination: Printer ← Destination**

Sends the printout to the printer selected from the [Printer Name](#) list.

Remote command:

```
HCOP:DEST1 'SYSTem:COMMunicate:PRINter'
```

**Suppress File Name Dialog**

If the [Destination](#) is a file, the file selection dialog box is not displayed. Instead, the default storage location and filename are used.

```
(C:\R_S\INSTR\USER\FSW_ScreenShot_<date and time>).
```

**Printer Name**

Defines the printer to print to if a printer is selected as the [Destination](#).

Any printers detected in the network are listed for selection.

**Tip:** the printout can also be stored in a print file using the selected printer driver, see ["Print to file"](#) on page 702.

Remote command:

`SYSTem:COMMunicate:PRINter:ENUMerate[:NEXT]` on page 1372

`SYSTem:COMMunicate:PRINter:ENUMerate:FIRSt` on page 1372

`SYSTem:COMMunicate:PRINter:SElect<di>` on page 1372

### Print to file

If a printer is selected as the [Destination](#), use this option to store the data in a `.prn` file using the selected printer driver.

Remote command:

To enable: `HCOP:DEST1 'MMEM'`

To disable: `HCOP:DEST1 'SYSTem:COMMunicate:PRINter'`

### Install Printer

This softkey opens the standard Windows dialog box to install a new printer. All printers that are already installed are displayed.

Only user accounts with administrator rights can install a printer.

For further information, refer to the Microsoft Windows documentation.

#### 10.5.1.4 Page setup



**Access:** "Print" > "Print Config" > "Page Setup" tab

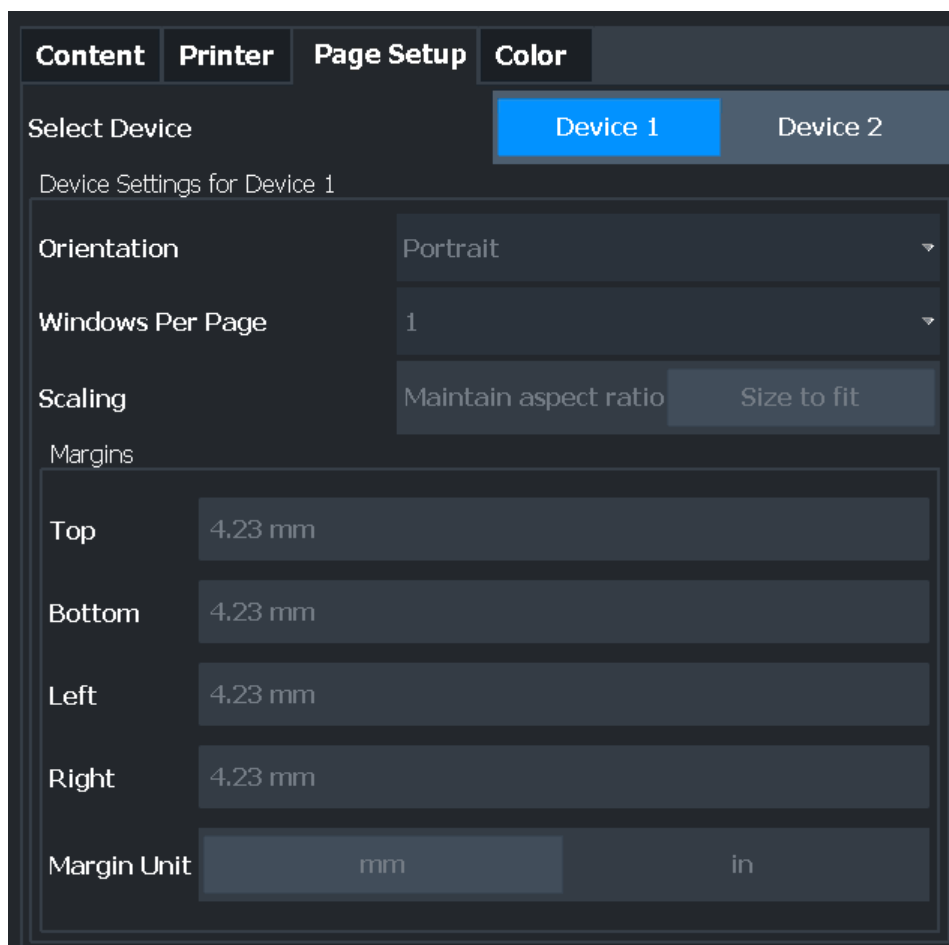

Page settings are (printing) device-specific. That means you can configure two different printing devices (for example, a printer and a file) and switch between configurations easily simply by selecting the appropriate device before printing.

Page settings are only available when printing on a printer or to a PDF file (see "Destination" on page 701).

Select Device 1/2.....	703
Orientation.....	704
Windows Per Page.....	704
Scaling.....	704
Margins.....	704

**Select Device 1/2**

Selects the printing device to be configured.

Two different printout devices can be configured, for example one for printing and one for storage to a file. When you execute the "SnapShot" function, the selected printing device and its settings determine the behavior of the FSW.

**Orientation**

Selects the page orientation of the printout: portrait or landscape.

Remote command:

[HCOPY:PAGE:ORIENTATION](#) on page 1369

**Windows Per Page**

Defines how many windows are displayed on a single page of the printout. This setting is only available if [Print Multiple Windows](#) is active (see [Chapter 10.5.1.1, "Print content settings"](#), on page 694).

If more than one window is printed on one page, each window is printed in equal size.

Remote command:

[HCOPY:PAGE:WINDOW:COUNT](#) on page 1370

**Scaling**

Determines the scaling of the windows in the printout if [Print Multiple Windows](#) is active (see [Chapter 10.5.1.1, "Print content settings"](#), on page 694).

If more than one window is printed on one page (see [Windows Per Page](#)), each window is printed in equal size.

"Maintain aspect ratio" Each window is printed as large as possible while maintaining the aspect ratio of the original display.

"Size to fit" Each window is scaled to fit the page size optimally, not regarding the aspect ratio of the original display.

Remote command:

[HCOPY:PAGE:WINDOW:SCALE](#) on page 1370

**Margins**

Defines margins for the printout page on which no elements are printed. The margins are defined according to the selected unit.

Remote command:

[HCOPY:PAGE:MARGIN:BOTTOM](#) on page 1368

[HCOPY:PAGE:MARGIN:LEFT](#) on page 1368

[HCOPY:PAGE:MARGIN:RIGHT](#) on page 1369

[HCOPY:PAGE:MARGIN:TOP](#) on page 1369

[HCOPY:PAGE:MARGIN:UNIT](#) on page 1369

**10.5.1.5 Print color settings**

**Access:** "Print" > "Print Config" > "Color" tab



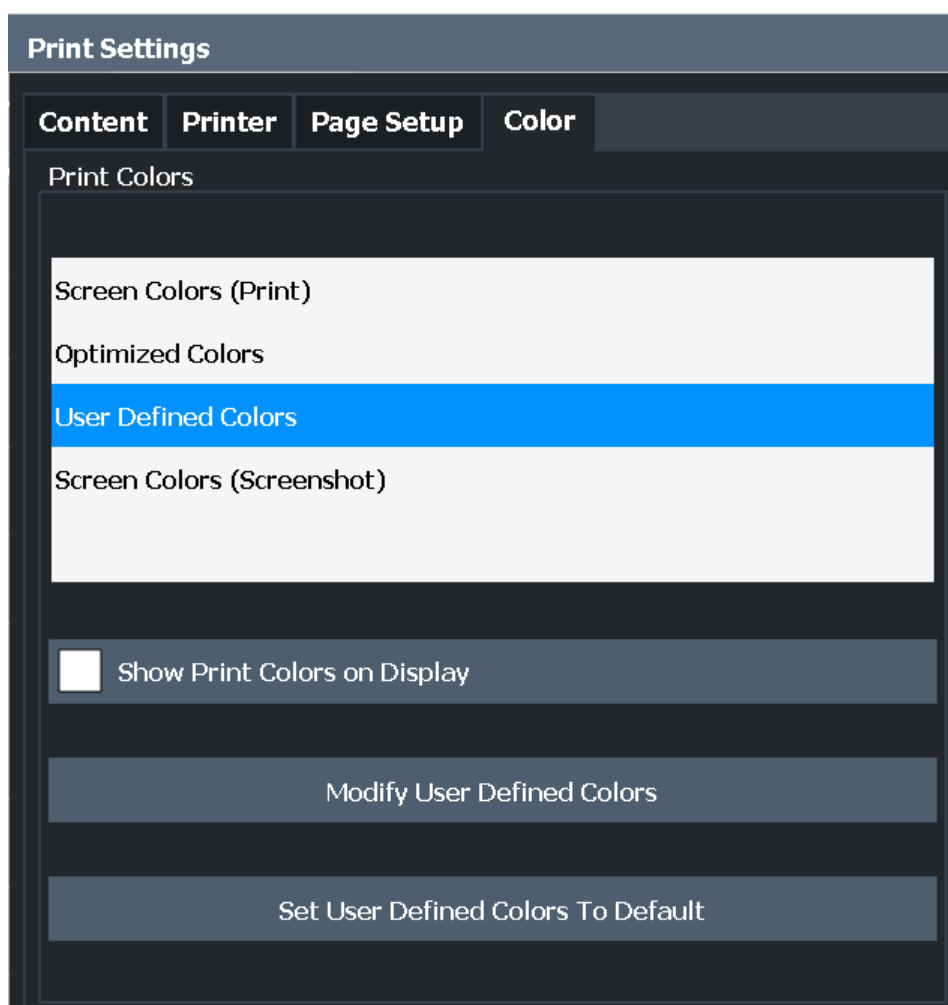

The settings provided here are identical to those in the "Print Colors" section of the "Display" > "Theme + Color" dialog box.

See ["Print Colors"](#) on page 741.

## 10.5.2 How to store or print screenshots of the display

The measurement results displayed on the screen can be printed or stored to a file very easily.

Two different scenarios can be configured in parallel, assigned to different printing devices. You can then perform one or the other simply by selecting the corresponding printing device and the "Print" function.



For a programming example, see [Chapter 13.9.7, "Examples: managing data"](#), on page 1385.

**To start printing or storing results to a file**

- ▶ If the FSW has already been set up according to your current requirements, simply select the "Print immediate" on the toolbar.

The current measurement display is printed or stored to a file, as configured.

**To print a screenshot**

This configuration assumes a printer has already been installed. To install a new printer, use the [Install Printer](#) function (common Microsoft Windows procedure).



1. Select the "Printer" tool in the toolbar.  
The "Print Settings" dialog box is displayed.
2. Select "Device 1" or "Device 2" to define which printing device you want to configure.  
(Note: Some settings are independent of the printing-device.)
3. In the "Content" tab, define the elements of the screen and additional information to be included in the printout.
  - a) Select "Print Screenshot" to include all elements displayed on the screen in a single-page printout.
  - b) Optionally, add a comment to be printed at the top of the printout.
  - c) Optionally, activate the date and time or the logo so they are added to the printout.
  - d) Optionally, activate "Print Dialog" to include any dialog boxes currently displayed on the screen in the printout. This is useful, for example, to document the used settings for a particular result.
  - e) Check the "Print Preview" to make sure all relevant elements of the display are visible.
4. In the "Printer" tab, select "Printer" as the "Destination".
5. Select the "Printer Name" to print to from the list of installed printers.
6. In the "Page Setup" tab, configure the layout of the printout page.
  - a) Select the page orientation.
  - b) Define the page margins.
  - c) Check the "Print Preview" to make sure all relevant elements of the display are visible.
7. In the "Color" tab, define the colors to be used for the printout.
  - a) By default, "Optimized Colors" are used to improve the visibility of the colors. The background is always printed in white and the grid in black. For a printout that reflects exactly what you see on the screen, select "Screen Colors (Screenshot)".
  - b) Check the "Print Preview" to find out if the setting is appropriate.
8. Select "Print" to execute the print function.  
The screenshot is printed on the printer as configured.

## Creating screenshots of current measurement results and settings



9. To print another screenshot using the same configuration any other time, simply press the "SnapShot" icon on the toolbar.

If you use different printing scenarios alternately, perform the following steps to print another screenshot:

- a) Select the  "Printer" tool in the toolbar.
- b) Select "Device 1" or "Device 2" to select the configured printing device.
- c) Select "Print" to execute the print function.

### To store a printout containing multiple windows



1. Select the "Printer" tool in the toolbar.  
The "Print Settings" dialog box is displayed.
2. Select "Device 1" or "Device 2" to define which printing device you want to configure.
3. In the "Content" tab, define the elements of the screen and additional information to be included in the printout.
  - a) Select "Print Selected Windows" to include the selected windows in the printout, possibly on multiple pages.
  - b) Select the result displays in the currently selected channel to be included in the printout.  
**Tip:** Select the "MultiView" before configuring the printout to include result displays from any active channel.
  - c) Optionally, add a comment to be printed at the top of each page of the printout.
  - d) Optionally, activate the date and time or the logo so they are added to the printout pages.
4. Check the "Print Preview" to make sure all required result displays are included.
  - a) Scroll through the individual pages of the printout using "Page Up" and "Page Down".
  - b) Use the zoom functions to make sure all relevant parts of the result display are visible.
5. In the "Printer" tab, select "File" as the "Destination".
6. Select the file format from the selection list.
7. By default, you define the filename individually for each print operation. To avoid having the "File Selection" dialog box being displayed for each print operation, select "Suppress File Name Dialog". In this case, the previously used or default storage location and filename are used.  
(C:\R\_S\INSTR\USER\FSW\_ScreenShot\_<date and time>).
8. In the "Page Setup" tab, configure the layout of the printout page.
  - a) Select the page orientation.
  - b) Define the page margins.
  - c) Check the "Print Preview" to make sure all relevant elements of the display are visible.

9. In the "Color" tab, define the colors to be used for the printout.
  - a) By default, "Optimized Colors" are used to improve the visibility of the colors. The background is always printed in white and the grid in black. For a printout that reflects the colors you see on the screen, but with a white background, select "Screen Colors (Print)".
  - b) Check the "Print Preview" to find out if the setting is appropriate.
10. Select "Print" to execute the print function.
11. If you did not select the option to suppress the dialog, enter a filename in the file selection dialog box.

The selected data elements are stored to the file as configured.



12. To store another file using the same configuration any other time, simply select the "Print immediate" icon on the toolbar. If you use different printing scenarios alternately, perform the following steps to store another file:
  - a) Select the  "Printer" tool in the toolbar.
  - b) Select "Device 1" or "Device 2" to select the configured printing device.
  - c) Select "Print" to execute the print function.

### 10.5.3 Example for storing multiple measurement results to a PDF file

The following example describes the procedure to store results from measurements in the Spectrum application and the I/Q Analyzer to a single PDF file.

1. Configure and perform the measurements in the Spectrum application and I/Q Analyzer as required. Configure at least the following result displays:
  - Frequency Sweep, Spectrogram (Spectrum)
  - Magnitude, Spectrum (I/Q Analyzer)
2. Switch to the "MultiView" tab to display an overview of the result displays in all active channels.

## Creating screenshots of current measurement results and settings

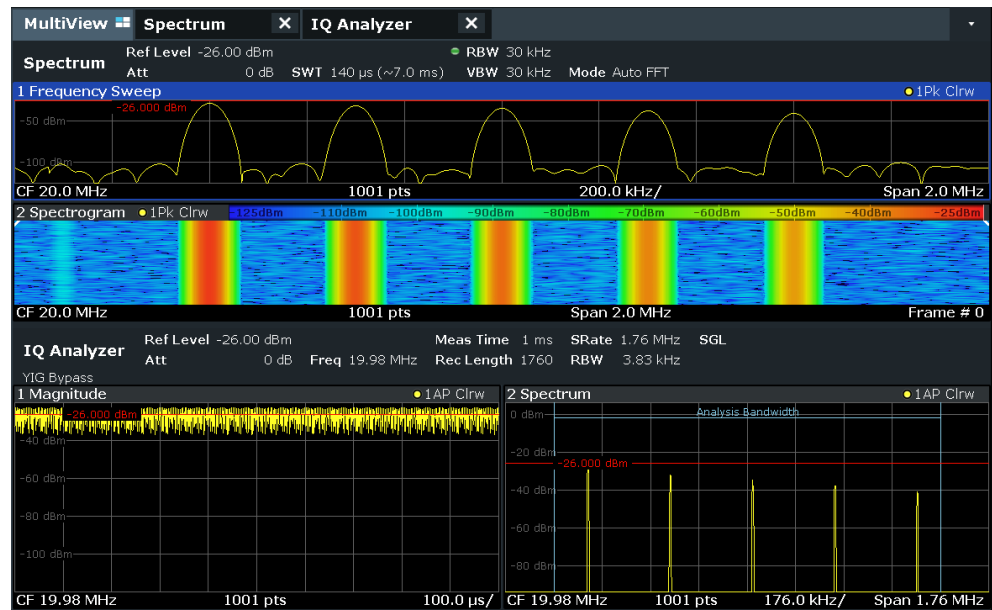

3. Select the "Printer" tool in the toolbar.  
The "Print Settings" dialog box is displayed.
4. Select "Device 1" to configure the settings for this printing device.
5. In the "Content" tab, select "Print Selected Windows".
6. Select the result displays listed in [step 1](#).
7. Enter the comment *Measurement Test Report* to be inserted at the top of each page.
8. Select "Print Page Count" and "Print Date and Time".
9. In the "Content" tab, select "Print Selected Windows".
10. In the "Printer" tab, select "File" as the "Destination".
11. Select "PDF" from the file format selection list.
12. Select "Suppress File Name Dialog".
13. In the "Page Setup" tab, select "Landscape" as the "Orientation".
14. Select "Windows Per Page": 1 to print a single result display on each page.
15. Select the "Scaling" option "Size to fit" to maximize the result display on each page.
16. In the "Color" tab, select "Screen Colors (Print)" for a printout that reflects the colors you see on the screen, but with a white background.
17. Check the "Print Preview" to make sure all required result displays are included and all relevant data elements are visible.
  - a) Scroll through the individual pages of the printout using "Page Up" and "Page Down".

- b) Use the zoom functions to make sure all relevant parts of the result display are visible.
18. Select "Print" to execute the print function.

The selected data elements are stored to the file as configured.

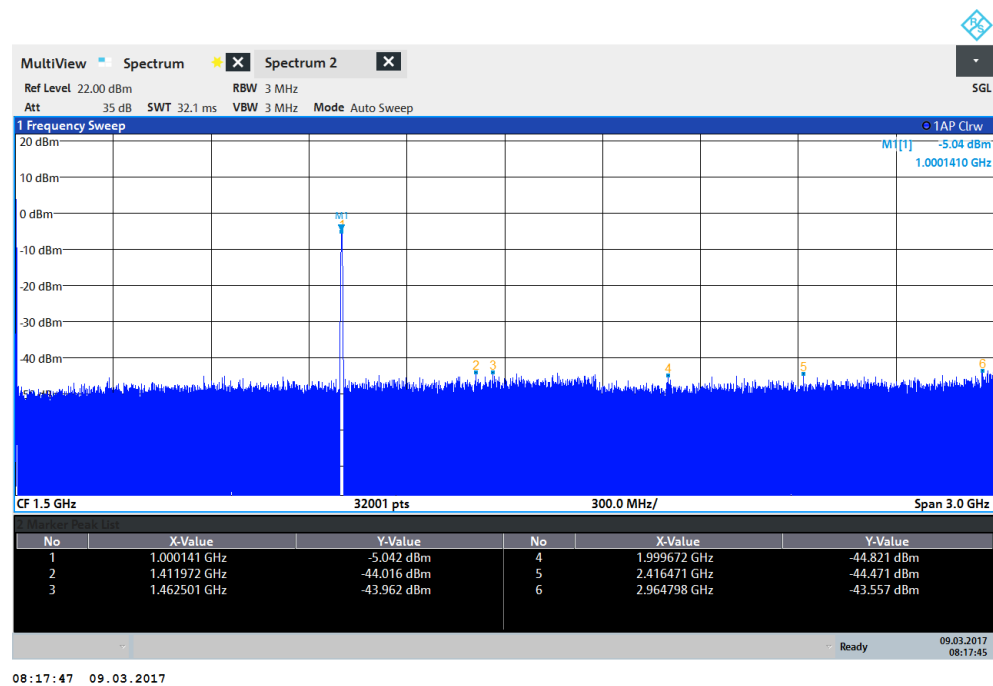

## 10.6 Working with test reports

**Access:** Toolbar:



The FSW features a test report generator. A test report is a document that summarizes the results and configuration of measurements.

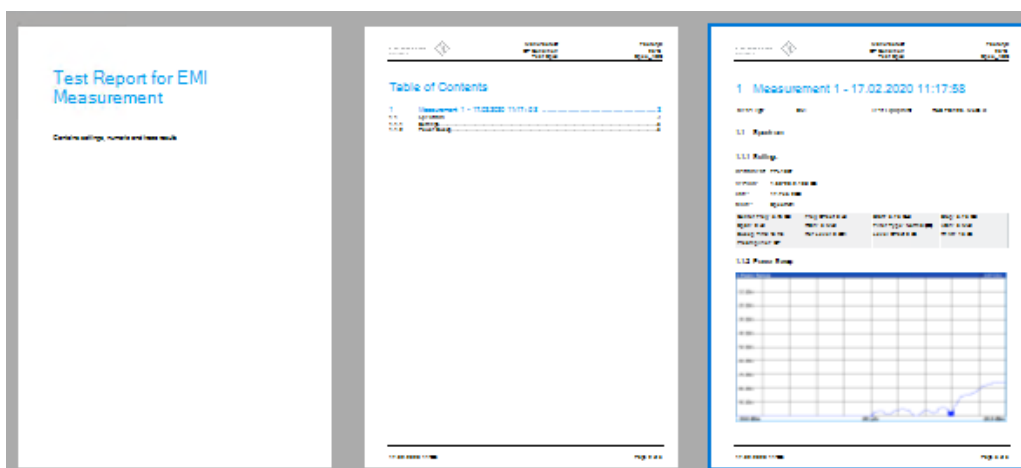

Figure 10-1: Example of a test report

A test report is made up of one or more datasets. Each dataset contains the results and configuration of one measurement.

Test reports are based on a general template, and are completed with user-defined, measurement-specific contents. You can create multiple templates for different applications.



Currently, test reports are only supported in the Spectrum application, for all measurement types.

Test reports require the R&S FSW-K54 option to be installed on the FSW.

- [Designing a test report template](#)..... 711
- [Managing templates](#).....720
- [Creating datasets](#).....721
- [Creating a test report](#)..... 722
- [How to create a test report](#).....724

### 10.6.1 Designing a test report template

**Access:** > "Report menu" > "Templates"

The FSW allows you to create multiple test report templates. Thus, you can document measurement tasks that require different information or a different layout in the test report.

The properties available in the "Templates" tab define the information that each dataset in the test report will contain. Templates contain general contents and application-specific contents.

The test report consists of different types of information, some of which are displayed on each page, others per measurement (subreport):

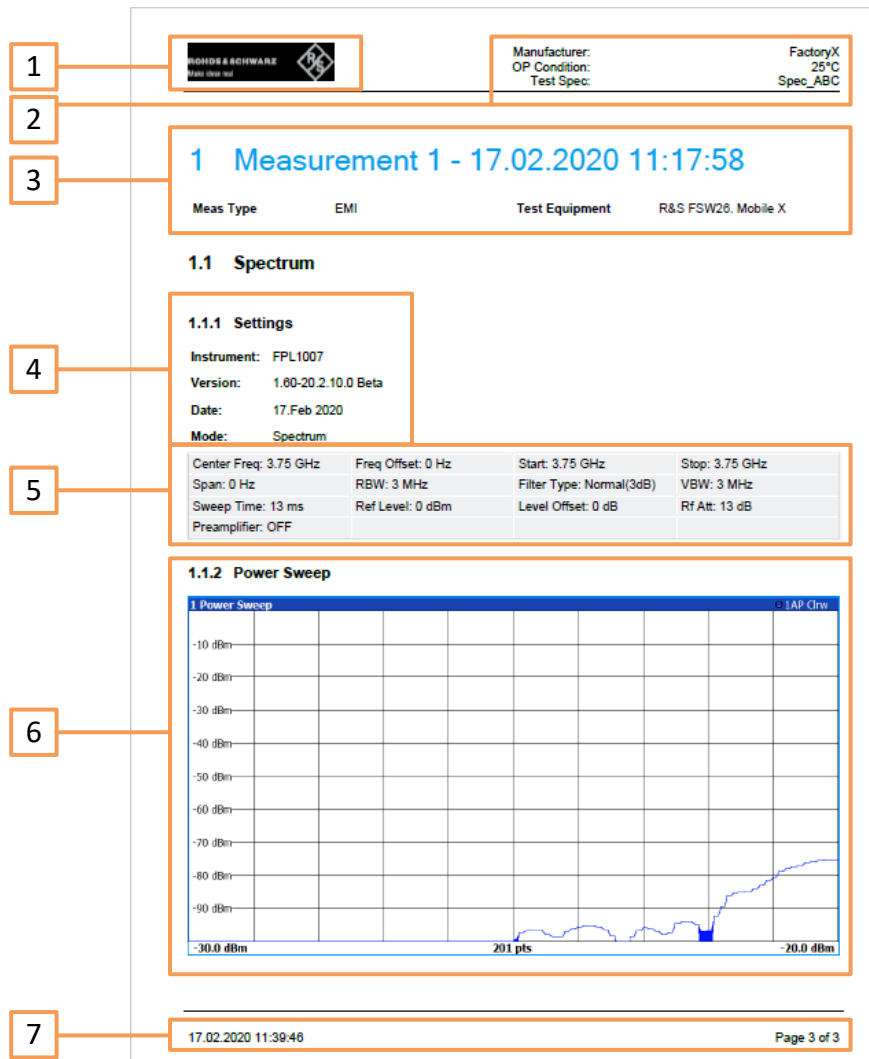

Figure 10-2: Types of information in the test report

- 1 = Logo (each page)
- 2 = Global information (each page)
- 3 = Measurement-specific information (per subreport)
- 4 = General instrument settings (per subreport)
- 5 = Measurement-specific settings (per subreport)
- 6 = Measurement results (per subreport)
- 7 = Date and page count (each page)



To see the result of your template configuration, use the [Show Preview](#) function.

- [General contents](#).....713
- [Title page](#)..... 714
- [Measurement information](#)..... 717
- [Application-specific contents](#).....719



10.6.1.1 General contents

**Access:**  > "Report menu" > "Templates" > "General" > "v" > "General"

The "General" area defines general properties of the report document.

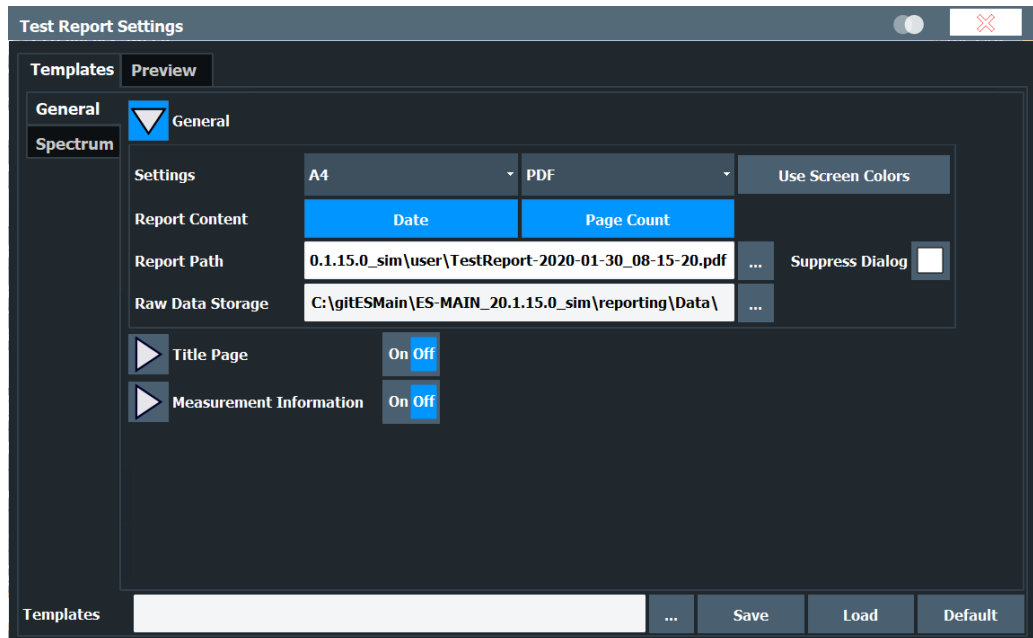

Page format.....713

File type.....713

Use Screen Colors.....713

Date.....714

Page Count.....714

Report Path.....714

    L Suppress Dialog.....714

Raw Data Storage.....714

**Page format**

Selects the format of the document (A4 or "Letter" format).

Remote command:

[HCOPY:TREPort:PAGesize](#) on page 1383

**File type**

Selects the file type (\*.pdf or \*.doc).

Remote command:

[HCOPY:DEVIce:LANGuage](#) on page 1367

**Use Screen Colors**

Enables or disables the use of printer-friendly color schemes (as opposed to the colors used on the screen).

Remote command:

[HCOPY:TREPort:PCOLors:STATe](#) on page 1383

**Date**

Adds the current date to each page of the report.

Remote command:

[HCOPY:TREPort:TDSTamp:STATe](#) on page 1384

**Page Count**

Adds page numbers to each page of the report.

Remote command:

[HCOPY:TREPort:PAGecount:STATe](#) on page 1383

**Report Path**

Defines the location where the report file is saved.

Enter the path in the input field, or select the directory using the "..." button.

If you omit the path, the report is saved in the default directory (C:\R\_S\INSTR\USER).

**Note:** This path defines the location of the actual test report. Templates are stored in a different location (see ["Save"](#) on page 721).

Remote command:

[MMEMoRY:NAME](#) on page 1352

**Suppress Dialog ← Report Path**

By default, when you store a report, a dialog is displayed to define the file name.

If the dialog is suppressed, reports are saved to the [Report Path](#) with a generic name without further interaction. The generic name is:

```
TestReport-<YYYY>-<MM>-<DD>-<hh>-<mm>-<ss>[_<nnn>]
```

Where <nnn> is a consecutive number, added if multiple files are created with the same name.

**Raw Data Storage**

Defines the location where the measurement data sets for the report are stored until the report is created.

Enter the path and filename in the input field, or select the directory using the "..." button.

Remote command:

[MMEMoRY:RAW](#) on page 1385

**10.6.1.2 Title page**

**Access:**  > "Report menu" > "Templates" > "General" > "▼" > "Title Page"

You can define an optional title page for the test report with a title and a short description of the report contents. It is only included in the report if you enable it.

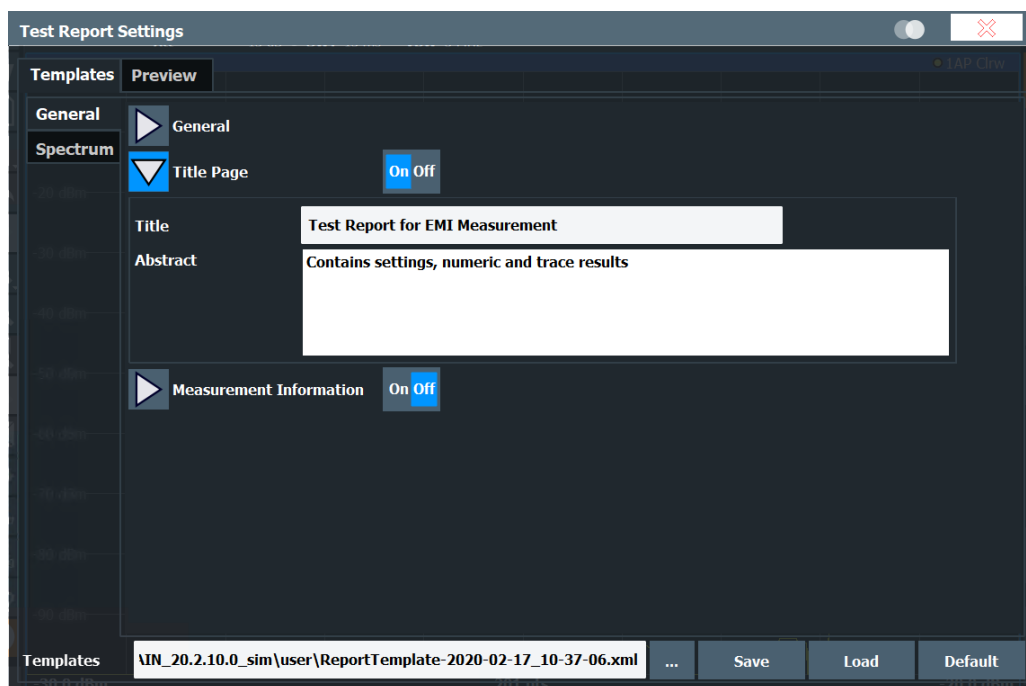

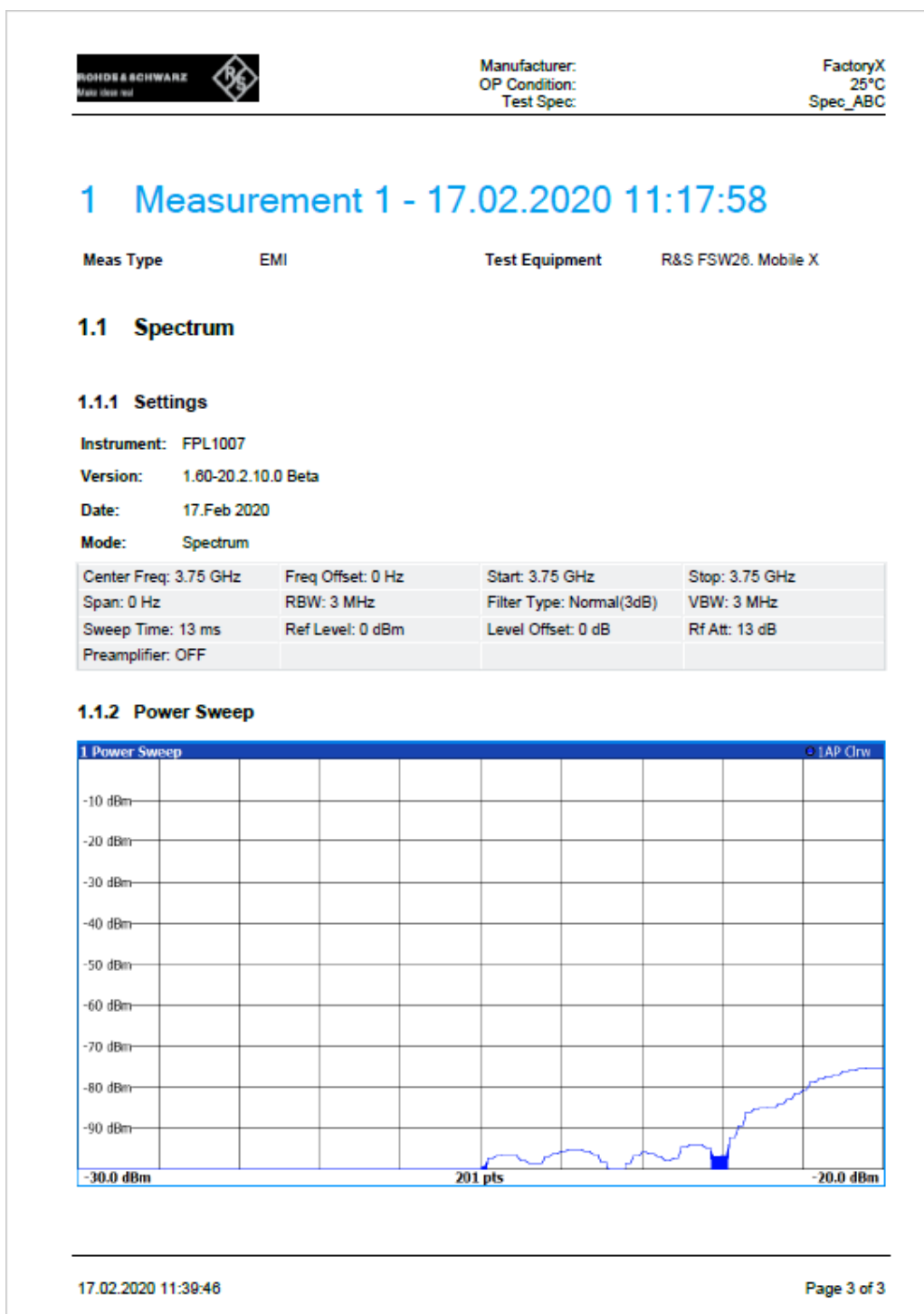

Figure 10-3: Example of a test report title page

State: `HCOPY:TREPort:TITLe:STATe` on page 1385

Title: `HCOPY:TREPort:TITLe` on page 1384

Abstract: `HCOPY:TREPort:DEScRiption` on page 1376

### 10.6.1.3 Measurement information

**Access:** [Icon] > "Report menu" > "Templates" > "General" > "v" > "Measurement Information"

The "Measurement Information" area allows you to add user-defined information on the measurement to the report.

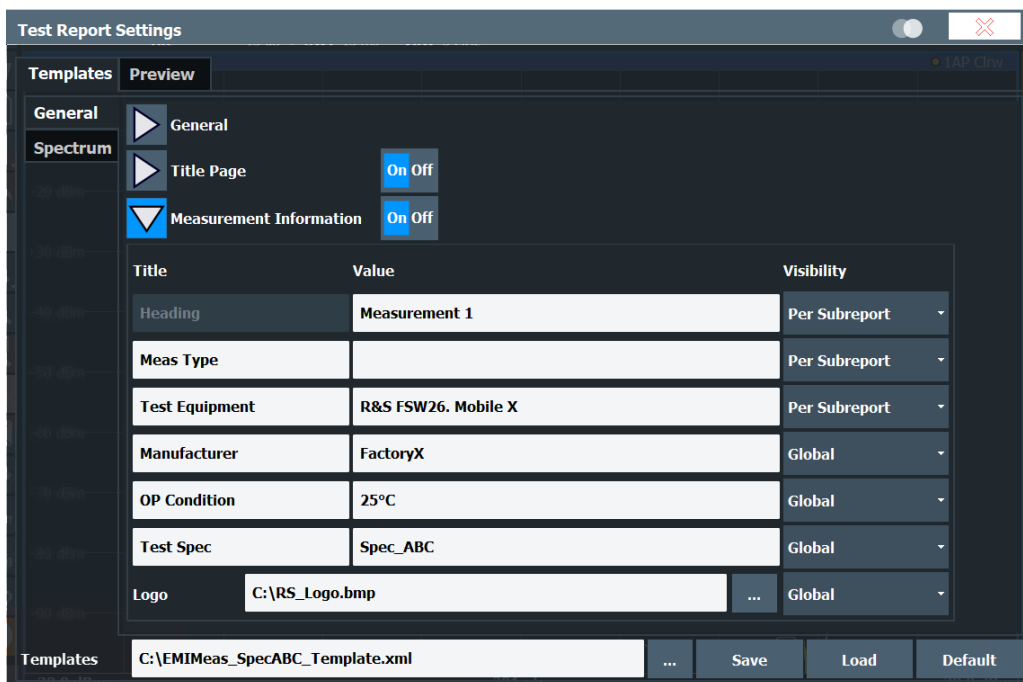

You can add up to six lines to the report, plus one picture, for example a company logo. The first line is a heading. Each of the following five lines consists of a title and a value, which is displayed next to the title. The information can be global, that is: valid for the entire report, or specific to an individual measurement. In this case, you define the actual value when you store the measurement data.

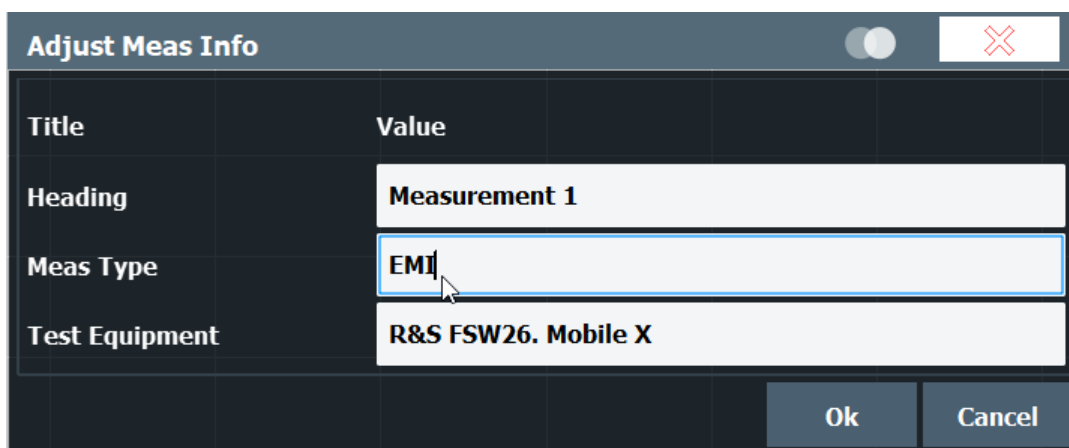
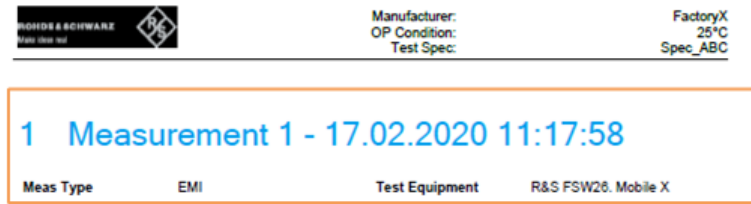

Figure 10-4: Dialog box for measurement information when appending data to a report



**1.1 Spectrum**

*Figure 10-5: Example for measurement-specific information in a test report*

State.....718  
 Title.....718  
 Value.....718  
 Visibility.....718  
 Logo.....719

**State**

Enables or disables the user-defined measurement information on the test report.

Remote command:

[HCOPY:TREPort:ITEM:HEADer:STATe](#) on page 1379

**Title**

Defines a title for the type of information, for example "Test equipment" for the name of the device under test. Default titles are provided, but you can change and customize each title, except for the initial "heading". A maximum of 17 characters are available.

For data that is specific to an individual measurement, this title is used in the dialog box asking you to provide the information when you append the measurement results to the report.

Remote command:

[HCOPY:TREPort:ITEM:HEADer:LINE<li>:TITLe](#) on page 1378

**Value**

Defines the actual text for the content defined by the title. A maximum of 25 characters are available.

For data that is specific to an individual measurement, you are asked to provide this information when you append the measurement results to the report.

Remote command:

[HCOPY:TREPort:ITEM:HEADer:LINE<li>:TEXT](#) on page 1377

**Visibility**

Determines the validity of the content and thus when the contents are configured and where the line is displayed in the report.

"Never" (Default): Contents are ignored.

"Global" Contents are valid globally for the entire report. They are configured in the template and included on each page.

"Subreport" Contents are valid for an individual measurement only. They are configured when you append the measurement results to the report, and included once for each subreport (measurement).

Remote command:

[HCOpy:TREPort:ITEM:HEADer:LINE<li>:CONTrol](#) on page 1377

[HCOpy:TREPort:ITEM:LOGO:CONTrol](#) on page 1380

### Logo

Includes a picture or logo in the report. Enter the path and filename in the input field, or select the directory using the "..." button.

The following formats are supported:

- .bmp
- .jpg
- .png
- .gif
- .emf
- .wmf

Remote command:

[HCOpy:TREPort:ITEM:LOGO](#) on page 1379

#### 10.6.1.4 Application-specific contents

For each application, you can select which graphical results, numerical results, or information on the measurement setup to include in the report. Information that is to be included in the test report is represented by a blue button. Information not included is represented by a gray button. Some information is only included if it is also displayed for the measurement, indicated by an asterisk (\*).

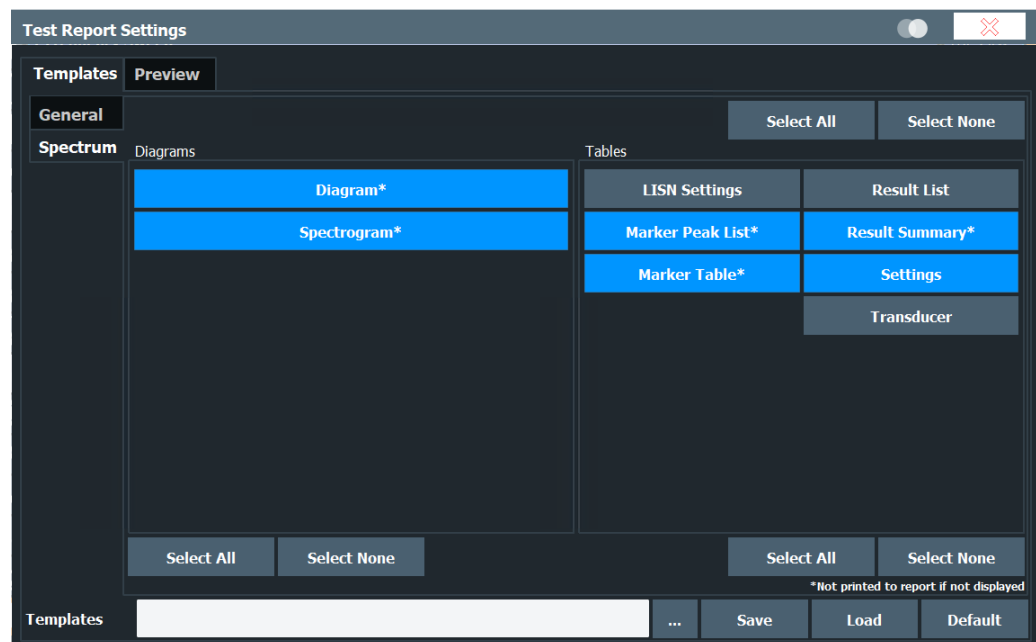



For the FSW, test reports are only available in Spectrum mode, and only if the R&S FSW-K54 is installed.

For details on the provided information, see:

- ["Diagram"](#) on page 535
- ["Spectrogram"](#) on page 536
- ["Marker Table"](#) on page 535
- ["Marker Peak List"](#) on page 536
- ["Result Summary"](#) on page 536
- [Chapter 11.4, "Transducers"](#), on page 754
- [Chapter 6.13.4.3, "LISN control settings"](#), on page 349
- **Result list:** a table that contains the trace values for each trace point  
A maximum of 50001 measurement points per trace are written to the report. The rest is dismissed.  
If you have more measurement points, export the data to an ASCII file (see ["Export Trace to ASCII File"](#) on page 652 ).
- **Settings:** basic instrument and measurement-specific settings (as indicated in the channel bar)

#### Select All / Select None

Selects or deselects all items in the corresponding area:

- Diagrams
- Tables
- All items

Remote command:

[HCOpy:TREPort:ITEM:SElect](#) on page 1380

## 10.6.2 Managing templates

**Access:** > "Report menu" > "Templates"

Some general functions to manage test report templates are available on all "Templates" subtabs.

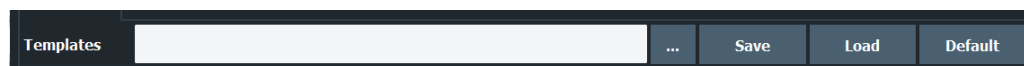

<a href="#">Template name</a> .....	720
<a href="#">Save</a> .....	721
<a href="#">Load</a> .....	721
<a href="#">Default</a> .....	721

#### Template name

Enter the path and filename of the template in the input field, or select the directory using the "..." button.



If you omit the path, the template is saved in the default directory (C:\R\_S\INSTR\USER).

Remote command:

Query available templates: [HCOpy:TREPort:ITEM:TEMPlate:CATalog?](#)

on page 1381

### Save

Saves the current test report configuration as a template to the specified [Template name](#).

Remote command:

[HCOpy:TREPort:ITEM:TEMPlate:SAVE](#) on page 1382

### Load

Restores the selected test report configuration.

Remote command:

[HCOpy:TREPort:ITEM:TEMPlate:LOAD](#) on page 1382

### Default

Restores the default template configuration.

Remote command:

[HCOpy:TREPort:ITEM:DEFault](#) on page 1377

## 10.6.3 Creating datasets



**Access:** Toolbar:



Before you can print a test report, you have to create report data.

Test report data is organized in datasets. Each dataset contains the information for one measurement. A dataset can contain several subsets for different kinds of data for a single measurement, for example settings and a result summary.

You create new datasets manually after a measurement.

Datasets are stored in the directory specified in "[Raw Data Storage](#)" on page 714.

After creating a dataset, you can view the details in the "Preview" dialog box (see "[Show Preview](#)" on page 724).

 [Report New](#)..... 721

 [Report Append](#)..... 722

### Report New

Deletes all currently stored datasets and creates a new one. Note that the dataset is only written to an actual report when you select [Save](#).

Remote command:

[HCOpy:TREPort:NEW](#) on page 1382

**Report Append**

Adds a new dataset to the existing ones for the next test report. If measurement-specific data is configured in the report template, a dialog box prompts you to provide the information for the appended dataset. Note that the dataset is only written to an actual report when you select [Save](#).

Remote command:

[HCOPY:TREPort:APPend](#) on page 1376

### 10.6.4 Creating a test report

**Access:** > "Report menu" > "Preview"

Once you have created datasets for a report, you can create and save the actual test report. Optionally, you can select which of the saved datasets to include. Before you save the test report to a file, you can check a preview of the current configuration and contents.

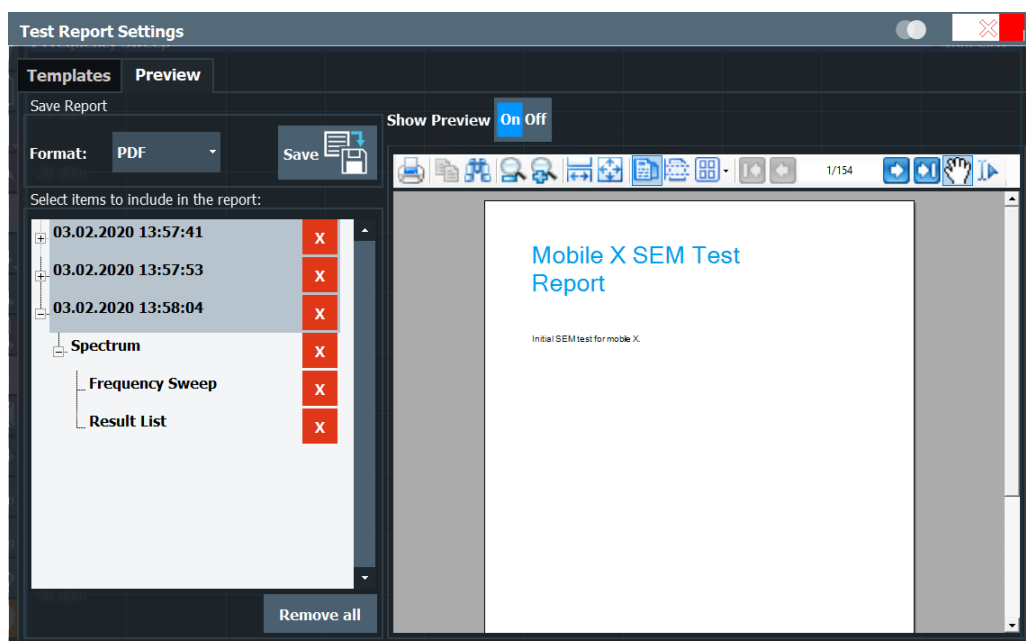

[File type](#).....722

[Save](#).....723

[Selecting items to include in the report](#).....723

    L [Remove All](#).....723

[Show Preview](#).....724

**File type**

Selects the file type of the report (\*.pdf or \*.doc).

Remote command:

[HCOPY:DEVIce:LANGuage](#) on page 1367

**Save**

**Access:**  > "Report menu" > "Save"

Saves the test report with the [selected items](#) to the selected [Report Path](#) with the selected [File type](#). If the option [Suppress Dialog](#) is enabled, the report is saved to the directory specified in the general contents area (see [Report Path](#)).

Tip: before saving the report, check the contents using the [Show Preview](#) function.

Remote command:

Print mode: [HCOPY:MODE](#) on page 1376

Report name and directory: [MMEMORY:NAME](#) on page 1352

Print report: [HCOPY\[:IMMEDIATE\]](#) on page 1367

**Selecting items to include in the report**

By default, all datasets and subsets stored for the test report are included (see [Chapter 10.6.3, "Creating datasets"](#), on page 721). However, you can remove individual datasets or subsets before creating the report.

Each dataset is indicated by the date and time it was stored. A dataset can contain subsets for individual results.

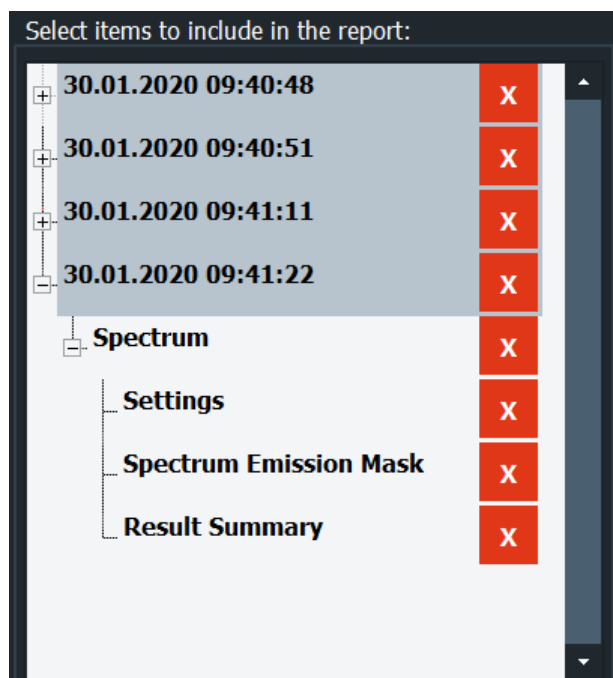

To delete an item, select the "X" next to the item.

Remote command:

[HCOPY:TREPort:TEST:REMove](#) on page 1384

**Remove All ← Selecting items to include in the report**

Deletes all items currently stored for the test report.

Remote command:

[HCOPY:TREPort:TEST:REMove:ALL](#) on page 1384

### Show Preview

If enabled, a preview of the current test report configuration and contents is displayed. Note that it can take a short time until the preview has been created.

The preview area provides typical viewing functions as in common PDF viewers.

## 10.6.5 How to create a test report

Using a test report you can summarize the results and configuration of measurements in a document directly from the Spectrum application.

### To configure a test report template

1. **Access:**  > "Report menu" > "Templates"
2. In the "General" area, define the general report settings, including:
  - Page format
  - File type
  - Color scheme (as on screen or print-optimized)
  - Include date
  - Include page numbers
  - Storage path for the final report and temporary data
3. Optionally, in the "Title Page" area, configure a separate title page with a title and description of the report.
4. Optionally, in the "Measurement Information" area, configure further information on the measurement to be included in the report.
  - a) Define a label ("Title").
  - b) Enter the text for the label ("Value").
  - c) Select whether the text is to appear on each page ("Global"), or only once per measurement ("Subreport").
  - d) Upload a picture, e.g. a logo.
5. Select the "Spectrum" tab to configure application-specific contents.
6. Select the diagrams and tables to include in the report.
7. If you want to create multiple test report configurations, save the configuration as a template.
  - a) Enter a name for the test report template.
  - b) Select "Save" to save the template.

### To create an initial test report

1. **Access:**  > "Report menu" > "Templates"
2. If you want to use one of multiple predefined test report configurations, load the required template.
  - a) Select the "..." button at the bottom of the "Templates" tab to select the pre-configured template for your report.

b) Select "Load".

The preconfigured report template is loaded to the dialog box.

3. Configure and perform your measurement as usual.
4. When the measurement is finished, save the results for your report:  
From the toolbar, select  > "Report new" to delete any existing report data and start a new report.



5. Perform further measurements and save the results as required.  
From the toolbar, select "Report Append".
6. When you are ready to create the report, from the toolbar, select  > "Report menu" > "Preview".
7. Optionally, remove any datasets you do not want to include in the report, for example due to false measurement settings.  
In the "Select items to include in the report" area, select the "X" to remove an item.
8. Optionally, use the browser functions to view the report preview in more detail.
9. Select "Save".

A file selection dialog box is displayed, unless you enabled the "Suppress dialog" option in the general template settings.

10. Select the file name and path for the report.
11. Select "OK".

The test report is saved to the selected location.

#### To create subsequent test reports

1. Configure and perform your measurement as usual.
2. When the measurement is finished, save the results for your report:  
From the toolbar, select "Report New".



3. Perform further measurements and save the results as required.  
From the toolbar, select "Report Append".
4. When you are ready to create the report, from the toolbar, select  > "Report menu" > "Save".

A file selection dialog box is displayed, unless you enabled the "Suppress dialog" option in the general template settings.

5. Select the file name and path for the report.
6. Select "OK".

The test report is saved to the selected location.

# 11 General instrument setup

**Access:** [SETUP]

Some basic instrument settings can be configured independently of the selected operating mode or application. Usually, you will configure most of these settings initially when you set up the instrument according to your personal preferences or requirements and then only adapt individual settings to special circumstances when necessary. Some special functions are provided for service and basic system configuration.



## Network and Remote Settings, Display Settings

Settings for network and remote operation are described in [Chapter 12, "Network operation and remote control"](#), on page 816.

Display settings are described in [Chapter 11.2.1, "Display settings"](#), on page 734.

- [Alignment](#)..... 726
- [Display settings](#)..... 734
- [Application starter](#)..... 749
- [Transducers](#)..... 754
- [Frequency response correction \(R&S FSW-K544\)](#)..... 767
- [Reference frequency settings](#)..... 779
- [System configuration settings](#)..... 783
- [Service functions](#)..... 796
- [Synchronizing measurement channel configuration](#)..... 803

## 11.1 Alignment

### 11.1.1 Basics on alignment

When you put the instrument into operation for the first time or when strong temperature changes occur, align the data to a reference source (see ["Temperature check"](#) on page 727).

The firmware determines the correction data and characteristics required for the alignment. It compares the results at different settings with the known characteristics of the high-precision calibration signal source at 64 MHz.

Basic operation of the FSW can be affected before or after a self-alignment in the following ways:

- Depending on the installation settings, an automatic self-alignment is performed directly after installation, and a dialog is displayed indicating how much warm-up time is still required before self-alignment can be performed.
- During instrument start, the firmware checks whether the installed hardware is supported. If not, an error message is displayed ("Wrong Firmware Version") and you

are asked to update the firmware. Until the firmware version is updated, self-alignment fails.

- When you start self-alignment, a self-test is automatically performed first. For details on the self-test, see [Chapter 11.8.2, "Self-test settings and results"](#), on page 797.
- By default, a reminder is shown in the status bar of the instrument 30 days after the last self-alignment took place. You can enable or disable the reminder, and change the timing for it.  
**Tip:** To check for a self-alignment reminder message in the status history, use the `SYStem:ERRor:EXTended?` command and search for messages that start with `Self alignment older than`. In addition, you can check bit 12 in the `STATus:OPERation` register.
- A reminder is shown in the status bar of the instrument if the temperature changes by more than 10 degrees compared to the last self-alignment took place.  
**Tip:** To check if the temperature has changed, check bit 0 in the `STATus:QUEStionable:TEMPerature` register.
- If you start a self-alignment remotely and then select "Local" while the alignment is still running, the instrument only returns to the manual operation state after the alignment is completed.
- During self-alignment, do not connect a signal to the RF input connector. Running a self-alignment with a signal connected to the RF input can lead to false measurement results.

### Alignment results

The alignment results are displayed and contain the following information:

- Date and time of last correction data record
- Overall results of correction data record
- List of performed alignment steps

The results are classified as follows:

<b>PASSED</b>	Calibration successful without any restrictions
<b>CHECK</b>	Deviation of correction value larger than expected, correction could however be performed
<b>FAILED</b>	Deviations of correction value too large, no correction was possible. The found correction data is not applicable.

The results are available until the next self-alignment process is started or the instrument is switched off.

### Temperature check

During self-alignment, the instrument's frontend temperature is measured (if activated, only after the instrument has warmed up completely, see ["Await Warm-Up Operation before Self Alignment"](#) on page 731). This temperature is used as a reference for a continuous temperature check during operation. If the current temperature deviates from the stored self-alignment temperature by a certain degree, a warning is displayed

in the status bar. The warning indicates the resulting deviation in the measured power levels. A status bit in the `STATUS:QUESTIONABLE:TEMPERATURE` register indicates a possible deviation. The current temperature of the frontend can be queried using a remote command (see `SOURCE<si>:TEMPERATURE:FRONTEND` on page 1401).

### Touchscreen alignment

When the device is delivered, the touchscreen is initially calibrated. However, to ensure that the touchscreen responds to the finger contact correctly, a touchscreen alignment is required.

Alignment of the touchscreen is useful:

- At first use
- After an image update or after exchanging a hard disk
- If you notice that touching a specific point on the screen does not achieve the correct response
- If the position of the instrument has been changed and you cannot look straight on the screen
- If another person operates the instrument

## 11.1.2 Alignment settings

**Access:** [Setup] > "Alignment"

Both the instrument and the touchscreen can be aligned when necessary (see [Chapter 11.1.1, "Basics on alignment"](#), on page 726).





### Automatic self-alignment

During installation of the FSW firmware, you can configure an automatic self-alignment to be performed directly after installation. In addition, you can activate a preceding warmup time before self-alignment, which is strongly recommended. If you do not activate this option, make sure the instrument has reached its operating temperature before installing the firmware. Furthermore, you can force the instrument to shut down after self-alignment. Note, however, that you cannot switch the instrument back on remotely afterwards.

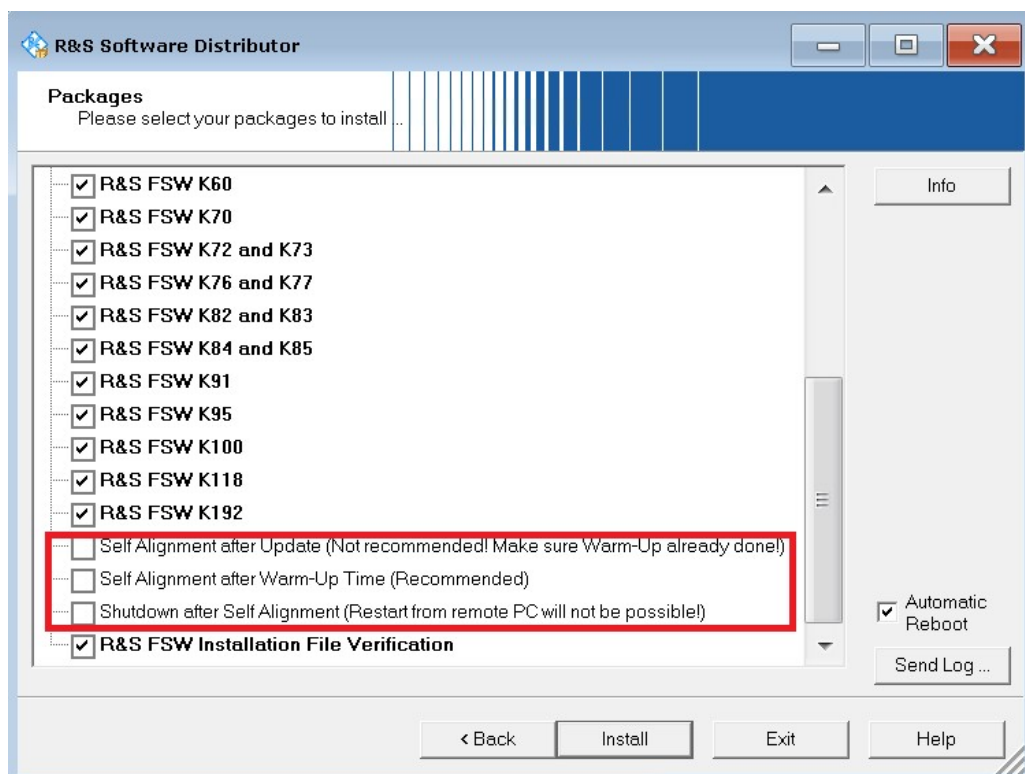

The additional settings for self-alignment can also be activated or deactivated during operation in the "Alignment" settings dialog (see [Await Warm-Up Operation before Self Alignment](#) and [Shut down Device after Self Alignment](#).)

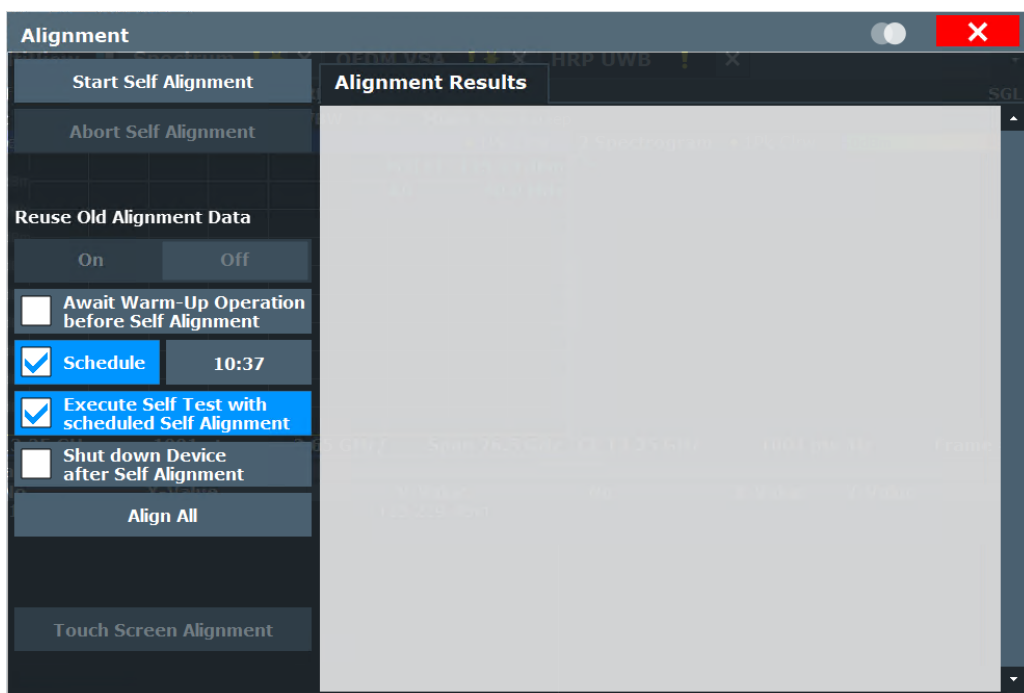

**Self-alignment results in secure user mode**

Be sure to store self-alignment results before [SecureUser Mode](#) is enabled; see [Chapter 4.2.15, "Protecting data using the secure user mode"](#), on page 39.

In secure user mode, the results are not stored permanently. Thus, if the currently stored self-alignment results are not suitable, you must perform a self-alignment each time you switch on the FSW.

<a href="#">Start Self Alignment</a> .....	730
<a href="#">Abort Self Alignment</a> .....	731
<a href="#">Await Warm-Up Operation before Self Alignment</a> .....	731
<a href="#">Schedule</a> .....	731
<a href="#">Shut down Device after Self Alignment</a> .....	731
<a href="#">Reuse Old Alignment Data</a> .....	732
<a href="#">Start Preselector Centering</a> .....	732
<a href="#">Align all</a> .....	732
<a href="#">Starting Touch Screen Alignment</a> .....	732
<a href="#">Regular Reminder</a> .....	732
<a href="#">Alignment Results</a> .....	733

**Start Self Alignment**

Starts recording correction data for the instrument. If the correction data acquisition fails or if the correction values are deactivated, a corresponding message is displayed in the status field.

For details, see [Chapter 11.1.1, "Basics on alignment"](#), on page 726.

**Note:**

A running Sequencer operation is aborted when you start a self-alignment.

During self-alignment, do not connect a signal to the RF input connector. Running a self-alignment with a signal connected to the RF input can lead to false measurement results.

Remote command:

[\\*CAL?](#) on page 893, see also [CALibration\[:ALL\]?](#) on page 1394

### Abort Self Alignment

As long as the self-alignment data is being collected, the procedure can be canceled using "Abort Self Alignment".

**Note:** If you start a self-alignment remotely, then select "Local" while the alignment is still running, the instrument only returns to the manual operation state after the alignment is completed. In this case, you cannot abort a self-alignment manually.

### Await Warm-Up Operation before Self Alignment

Displays a message indicating the remaining warmup time required before self-alignment is performed. After the warmup operation has completed, self-alignment is started automatically.

Remote command:

[CALibration:DUE:WARMup](#) on page 1397

### Schedule

If enabled, a self-alignment is performed regularly at specific days and time.

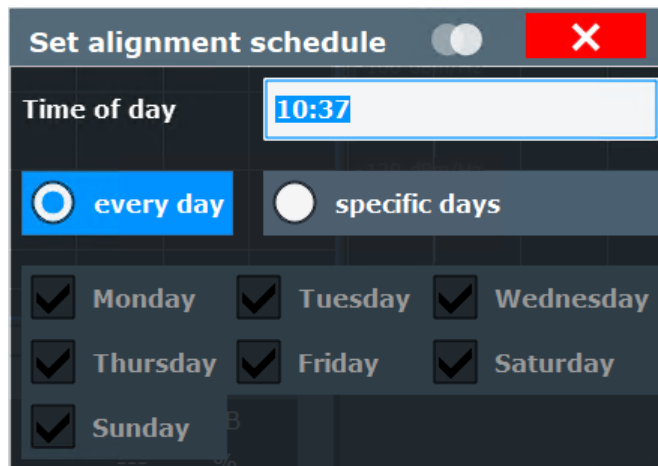

Remote command:

[CALibration:DUE:SCHEdule](#) on page 1395

[CALibration:DUE:DAYs](#) on page 1395

[CALibration:DUE:TIME](#) on page 1396

### Shut down Device after Self Alignment

If activated, the FSW is automatically shut down after self-alignment is completed. Note that the instrument cannot be restarted via remote control.

Remote command:

[CALibration:DUE:SHUTdown](#) on page 1396

### Reuse Old Alignment Data

If data from a previous self-alignment is available on the instrument, it can be reused even though the instrument claims the instrument is uncalibrated. This is useful, for example, after activating a software option or updating the firmware to a beta version. After rebooting the instrument, you must re-activate this function if you still want to reuse the old alignment data.

Note, however, that **re-using old alignment data can lead to inaccurate measurement results, or even cause the FSW firmware to fail altogether**. For measurements using old alignment data, an [OLD CAL] message is indicated in the status bar (instead of [UNCAL], which indicates that a new self-alignment is actually required.)

**To measure with the accuracy specified in the specifications document, always perform a self-alignment** when the instrument calls for it.

### Start Preselector Centering

Due to changes in temperature, the YIG-preselector frequency may become slightly offset. This function re-aligns the preselector quickly, without requiring a full self-alignment of the FSW. For FSW85 models, the YIG2 filter is also re-aligned.

This function is only available for FSW models 1331.5003Kxx, and only if a YIG-preselector is available.

Remote command:

[CALibration:PRESelection](#) on page 1397

### Align all

Performs an extended self-alignment as performed in the factory. Any previous self-alignment results are deleted.

Note that this process takes longer than the common self-alignment.

Remote command:

[CALibration\[:ALL\] AClear](#)

### Starting Touch Screen Alignment

Starts the touchscreen alignment.

Tap the 4 markers on the screen as you are asked to do. The touchscreen is aligned according to the executed pointing operations.

### Regular Reminder

Schedules a regular reminder for self-alignment. By default, a reminder is shown in the status bar of the instrument 30 days after the last self-alignment took place.

Enable or disable the reminder as required.

If enabled, define the number of days after the last self-alignment that the reminder appears.

Remote command:

To query whether a reminder is being displayed (self-alignment overdue):  
[CALibration:INFO:OLD?](#) on page 1397

**Alignment Results:**

Information on whether the alignment was performed successfully and on the applied correction data is displayed. The results are available until the next self-alignment process is started or the instrument is switched off.

Remote command:

[CALibration:RESult?](#) on page 1398

### 11.1.3 How to perform a self-test

You do not have to repeat the self-test every time you switch on the instrument. It is only necessary when instrument malfunction is suspected.

**Operating temperature**

Before performing this alignment, make sure that the instrument has reached its operating temperature.

For details, refer to the specifications document.

1. Select [SETUP].
2. Select "Service".
3. Select "Selftest".

Once the instrument modules have been checked successfully, a message is displayed.

### 11.1.4 How to align the instrument

**Operating temperature**

Before performing this alignment, make sure that the instrument has reached its operating temperature.

For details, refer to the specifications document.

**To perform a self-alignment**

Make sure no signal is connected to the RF input connector. Running a self-alignment with a signal connected to the RF input can lead to false measurement results.

1. Select [SETUP].
2. Select "Alignment".
3. Select "Start Self Alignment".
4. To abort the self-alignment process, select "Abort Self Alignment".

Once the system correction values have been calculated successfully, a message is displayed.

**To display the alignment results again later**

- ▶ Select [SETUP] > "Alignment".

### 11.1.5 How to align the touchscreen

**To align the touchscreen**

1. Press [Setup].
2. Select "Alignment".
3. Select "Touch Screen Alignment".  
A blinking cross appears in the lower left corner of the screen.
4. Touch and hold the blinking cross until it stops blinking.  
Repeat this action for the crosses in the other corners.

## 11.2 Display settings

### 11.2.1 Display settings

**Access:** [Setup] > "Display"

Some general display settings are available regardless of the current application or operating mode. For information on optimizing your display for measurement results, see [Chapter 8.1, "Result display configuration"](#), on page 534.

- [General display settings](#).....734
- [Displayed items](#).....736
- [Display theme and colors](#).....739
- [External monitor settings](#).....744
- [Touch\(screen\) settings](#).....745

#### 11.2.1.1 General display settings

**Access:** [Setup] > "Display" > "General"

This section includes general screen display behavior and date and time display.

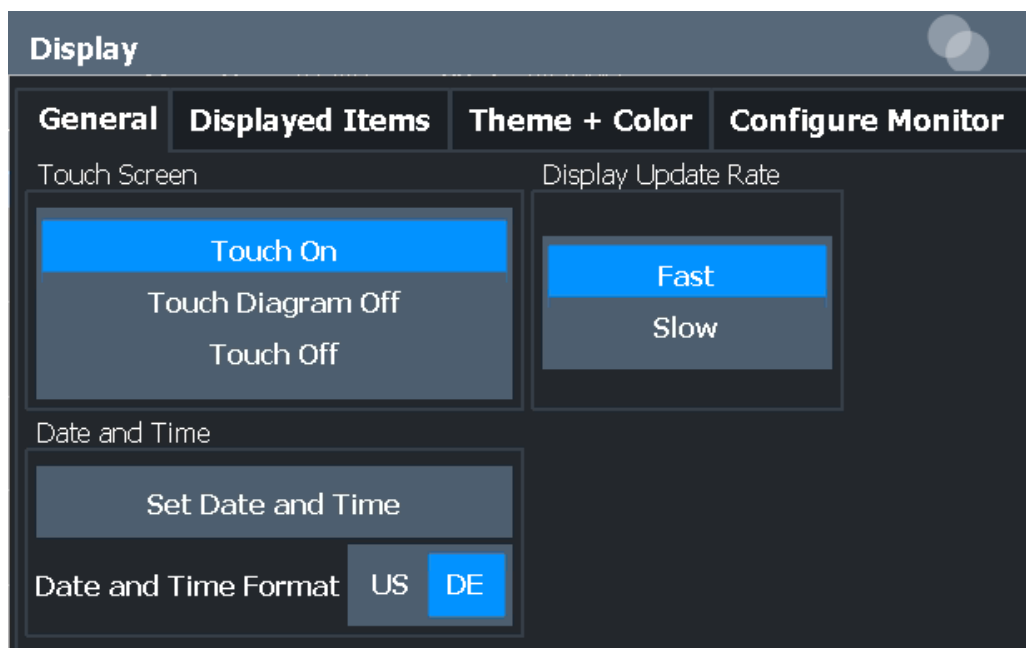

Deactivating and Activating the Touchscreen.....	735
Display Update Rate.....	735
Set Date and Time.....	735
Date and Time Format.....	736

### Deactivating and Activating the Touchscreen

The touchscreen function can be deactivated, e.g. when the instrument is being used for demonstration purposes and tapping the screen must not provoke an action.

To reactivate the touchscreen, simply press [Setup] on the front panel. The "Display" dialog box is opened automatically and the "Touch Screen" option is set to "On".

"Touch On" Touchscreen function is active for the entire screen.

"Touch Off" Touchscreen is deactivated for the entire screen.

"Touch Diagram Off"  
Touchscreen is deactivated for the diagram area of the screen, but active for the surrounding softkeys, toolbars and menus.

Remote command:

`DISPlay:TOUChscreen[:STATe]` on page 1427

### Display Update Rate

By default, a fast update rate ensures the most recent measurement results on the display. However, when performance is poor due to slow data transfer (for example during remote control), it can be helpful to decrease the frequency with which the screen display is updated.

### Set Date and Time

Sets the current date and time for the internal real-time clock on the instrument. This function uses the standard Windows "Date and Time Properties" dialog box. Setting the clock requires administrator rights.

Select "Set Date and Time" in the "Display" dialog box, or select the date and time display in the status bar to open the Windows dialog box.

Remote command:

`SYSTem:DATE` on page 1428

`SYSTem:TIME` on page 1428

**Date and Time Format**

Switches the time and date display on the screen between US, ISO and German (DE) format.

"DE" dd.mm.yyyy hh:mm:ss  
24 hour format.

"US" mm/dd/yyyy hh:mm:ss  
12 hour format.

"ISO" yyyy-mm-dd hh:mm:ss  
24 hour format.

Remote command:

`DISPlay[:WINDow<n>]:TIME:FORMat` on page 1427

**11.2.1.2 Displayed items**

**Access:** [Setup] > "Display" > "Displayed Items"

Several elements on the screen display can be hidden or shown as required, for example to enlarge the display area for the measurement results.

General	Displayed Items	Theme + Color	Configure Monitor	Touch
Toolbar	<input checked="" type="checkbox"/> On <input type="checkbox"/> Off		Status Bar	<input checked="" type="checkbox"/> On <input type="checkbox"/> Off
Softkey Bar	<input checked="" type="checkbox"/> On <input type="checkbox"/> Off		Channel Bar	<input checked="" type="checkbox"/> On <input type="checkbox"/> Off
Annotation	<input checked="" type="checkbox"/> On <input type="checkbox"/> Off		Date and Time	<input checked="" type="checkbox"/> On <input type="checkbox"/> Off
Front Panel	<input checked="" type="checkbox"/> On <input type="checkbox"/> Off		Mini Front Panel	<input type="checkbox"/> On <input checked="" type="checkbox"/> Off
Disconnect RF	<input checked="" type="checkbox"/> On <input type="checkbox"/> Off		Frequency Lock	<input checked="" type="checkbox"/> On <input type="checkbox"/> Off

Toolbar..... 737

Status Bar..... 737

Softkey Bar.....737

Channel Bar..... 737

Diagram Footer (Annotation).....737

Date and Time.....737

Front Panel.....738

Mini Front Panel..... 738



### Toolbar

The toolbar provides access to frequently used functions via icons at the top of the screen. Some functions, such as zooming, finding help, printing screenshots or storing and loading files are not accessible at all without the toolbar.

Remote command:

`DISPlay:TBAR[:STATe]` on page 1426

### Status Bar

The status bar beneath the diagram indicates the global instrument settings, the instrument status and any irregularities during measurement or display.

Some of the information displayed in the status bar can be queried from the status registry via remote commands, see [Chapter 13.11, "Using the status register"](#), on page 1478.

We recommend displaying the status bar at all times. If you hide the status bar, you can miss important error messages.

Remote command:

`DISPlay:SBAR[:STATe]` on page 1426

### Softkey Bar

Softkeys are virtual keys provided by the software. Thus, more functions can be provided than can be accessed directly via the function keys on the device.

The functions provided by the softkeys are often also available via dialog boxes. However, some functions are not accessible at all without the softkey bar.

**Note:** The softkey bar is hidden while the SmartGrid is displayed and restored automatically when the SmartGrid is closed.

Remote command:

`DISPlay:SKEYs[:STATe]` on page 1426

### Channel Bar

The channel bar provides information on firmware and measurement settings for a specific channel.

Remote command:

`DISPlay:ANNotation:CBAR` on page 1425

### Diagram Footer (Annotation)

The diagram footer beneath the diagram contains information on the x-axis of the diagram display, such as:

- The current center frequency and span settings
- The displayed span per division
- The number of sweep points

Remote command:

`DISPlay:ANNotation:FREQuency` on page 1426

### Date and Time

The date and time display can be switched off independently of the status bar.

You can set the current date and time and configure the display format in the "General" tab of the "Display" dialog box.

Remote command:

`DISPlay[:WINDow<n>]:TIME` on page 1427

### Front Panel

The "Front Panel" display simulates the entire front panel of the device (except for the external connectors) on the screen. Thus, you can interact with the FSW without the keypad and keys on the front panel of the device. That is useful, for example, when working with an external monitor or operating via remote control from a computer.

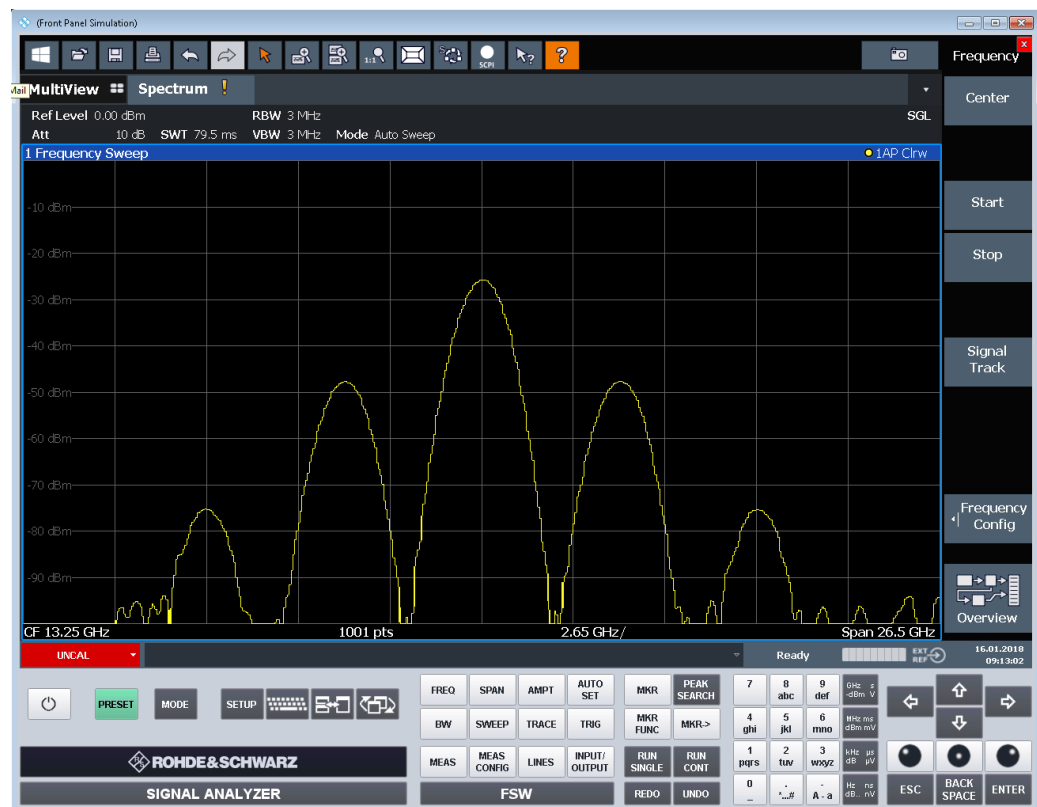

To hide or show the front panel temporarily, press [F6] on the external keyboard (if available) or the remote computer.

For more information, see [Chapter 11.2.3, "How to work with the soft front panels"](#), on page 746.

Remote command:

`SYSTem:DISPlay:FPANel[:STATe]` on page 1428

### Mini Front Panel

If you require a front panel display but do not want to lose too much space for results in the display area, a mini front panel is available. The mini version displays only the main function keys in a separate window in the display area.



For more information, see [Chapter 11.2.3, "How to work with the soft front panels"](#), on page 746.

**Note:**

You can also show the mini front panel using the key combination [ALT + m] (be aware of the keyboard language defined in the operating system!). That is useful when you are working from a remote PC and the front panel function is not active.

Remote command:

`SYSTem:DISPlay:FPANel[:STATe]` on page 1428

### 11.2.1.3 Display theme and colors

**Access:** [Setup] > "Display" > "Theme + Color"

You can configure the used colors and styles of display elements on the screen.

For step-by-step instructions see [Chapter 11.2.2, "How to configure the colors for display and printing"](#), on page 745.

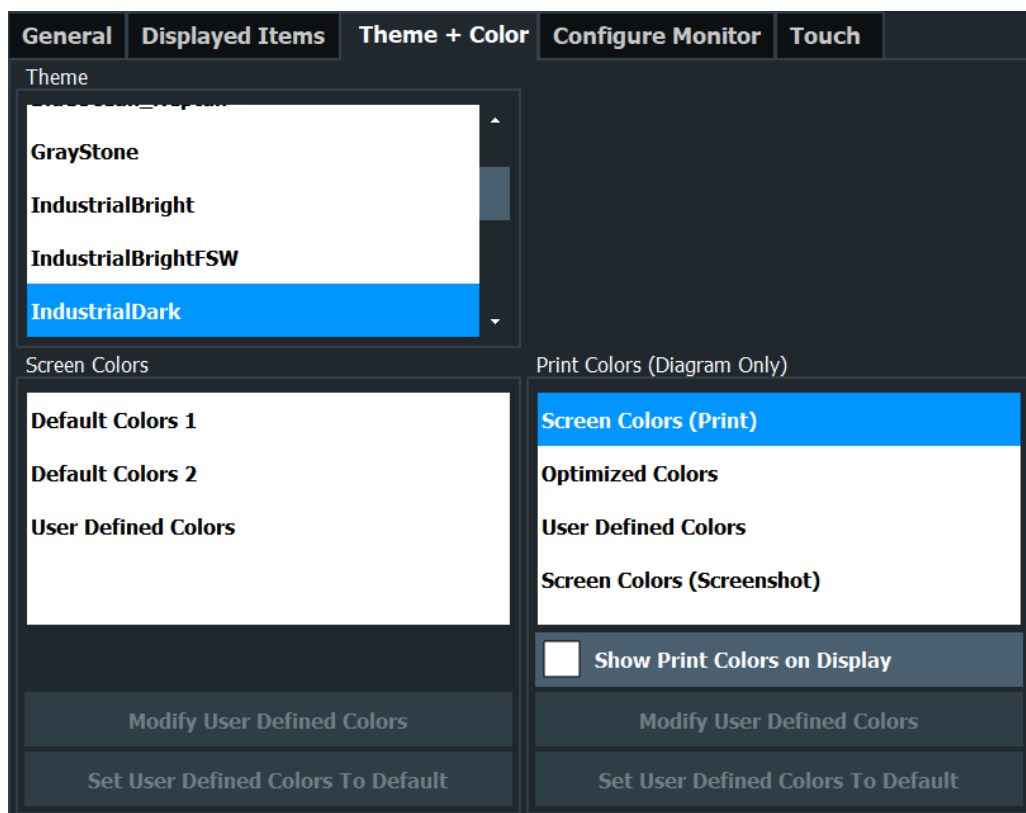

Theme..... 740

Screen Colors..... 740

Print Colors..... 741

Showing Print Colors on Display..... 741

Modifying User-Defined Color Assignments..... 741

- L Selecting the Object..... 742
- L Predefined Colors..... 742
- L Preview..... 742

Defining User-specific Colors..... 743

Restoring the User Settings to Default Colors..... 743

**Theme**

The theme defines the colors and style used to display softkeys and other screen objects.

The default theme is "IndustrialDark".

Remote command:

[DISPlay:THEMe:SELeCt](#) on page 1430

**Screen Colors**

Two different color sets are provided by the instrument, a third user-defined set can be configured.

The default color schemes provide optimum visibility of all screen objects when regarding the screen from above or below. Default setting is "Default Colors 1".

If "User Defined Colors" is selected, a user-defined color set can be defined (see ["Defining User-specific Colors"](#) on page 743).

Remote command:

`DISPlay:CMAP<it>:DEFault<ci>` on page 1429

### Print Colors

Defines the color settings used for printout.

In addition to the predefined settings, a user-defined color set can be configured (see ["Defining User-specific Colors"](#) on page 743).

If "Show Print Colors on Display" is activated, the currently selected print colors are displayed as a preview for your selection.

Gui setting	Description	Remote command
"Optimized Colors"	Selects an optimized color setting for the printout to improve the visibility of the colors (default setting). Trace 1 is blue, trace 2 black, trace 3 green, and the markers are turquoise. The background is always printed in white and the grid in black.	HCOP:CMAP:DEF2
"Screen Colors (Print)"	Selects the current screen colors for the printout. The background is always printed in white and the grid in black.	HCOP:CMAP:DEF1
"Screen Colors (Screenshot)"	Selects the current screen colors without any changes for a screenshot.	HCOP:CMAP:DEF4
"User Defined Colors"	Selects the user-defined color setting.	HCOP:CMAP:DEF3

Remote command:

`HCOPy:CMAP<it>:DEFault<ci>` on page 1364

### Showing Print Colors on Display

Temporarily shows the currently selected print colors on the screen display. This function can be used as a preview for printing.

### Modifying User-Defined Color Assignments

You can configure the colors used to display and print individual screen objects according to your specific requirements.

The colors are configured in the (identical) "Screen Color Setup"/"Printer Color Setup" dialog boxes.



#### Selecting the Object ← Modifying User-Defined Color Assignments

Selects the object for which the color is to be defined. Colors can be defined for the following objects:

- Background
- Grid
- Individual traces
- Display lines
- Limit lines and check results
- Markers and marker information

Remote command:

Each object is assigned to a specific suffix of the CMAP commands, see [Chapter 13.10.5.3, "CMAP suffix assignment"](#), on page 1431.

#### Predefined Colors ← Modifying User-Defined Color Assignments

Displays the available colors from the predefined color set that can be used for the selected object.

Remote command:

[HCOPY:CMAP<it>:PDEFined](#) on page 1365

#### Preview ← Modifying User-Defined Color Assignments

Indicates the currently selected color that will be used for the selected object.

### Defining User-specific Colors

In addition to the colors in the predefined color set you can configure a user-specific color to be used for the selected object.

When you select "Userdefined Colors...", the set of predefined colors is replaced by a color palette and color configuration settings.



The color palette allows you to select the color directly. The color settings allow you to define values for tint, saturation and brightness.

Remote command:

[HCOPY:CMAP<it>:HSL](#) on page 1365

### Restoring the User Settings to Default Colors

In addition to the predefined color settings, a user-defined setting can be configured. By default, the same settings as defined in "Default Colors 1" are used. They can then be modified according to user-specific requirements (see "[Modifying User-Defined Color Assignments](#)" on page 741).

The "Set to Default" function restores the original default settings for the user-defined color set. You can select which of the three default settings are restored.

Remote command:

[DISPlay:CMAP<it>:PDEFined](#) on page 1430

### 11.2.1.4 External monitor settings

**Access:** [Setup] > "Display" > "Configure Monitor"

You can connect an external monitor (or projector) to the "DVI" or "display port" connector on the instrument's rear panel.



#### Screen resolution and format

The touchscreen of the FSW is calibrated for a 16:10 format. If you connect a monitor or projector using a different format (e.g. 4:3), the calibration is not correct and the screen does not react to your touch actions properly.

The touchscreen has a screen resolution of 1280x800 pixels. Usually, the display of the external monitor is a duplicate of the instrument's monitor.

If you configure the external monitor to be used as the *only* display in the Windows configuration dialog box ("Show only on 2"), the maximum screen resolution of the monitor is used. In this case, you can maximize the FSW application window and see even more details. You cannot change the monitor's screen resolution via the standard Windows configuration dialog box.

However, you can restore the default instrument resolution (1280x800) on the monitor using the instrument function "Setup" > "Display" > "Configure Monitor" > "Screen Resolution: Restore to default".

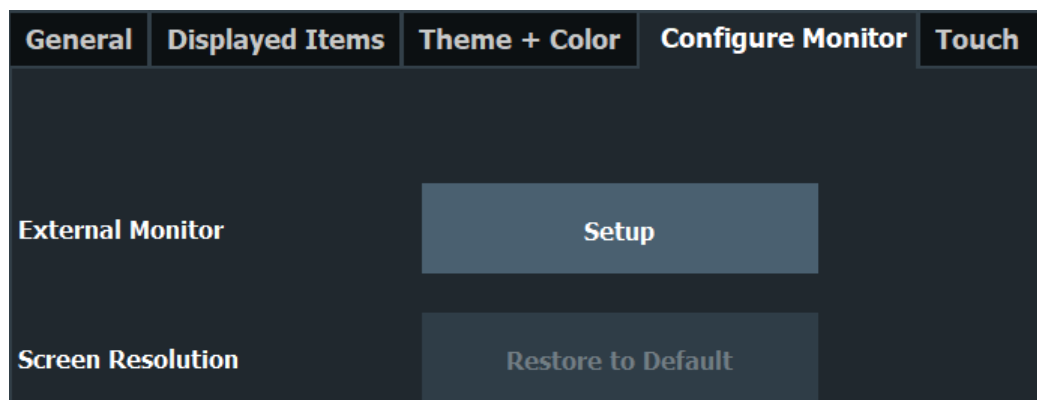

<a href="#">Setup</a> .....	744
<a href="#">Screen Resolution: Restore to Default</a> .....	744

#### Setup

Opens the standard Windows configuration dialog box to configure the used display devices.

#### Screen Resolution: Restore to Default

The default screen resolution (1280 x 800) is restored in the Windows configuration settings. This is useful, for instance, if the instrument was connected to a display device and was adapted to different requirements.



### 11.2.1.5 Touch(screen) settings

**Access:** [Setup] > "Display" > "Touch"

These options concern the behavior of the firmware for touch gestures on the screen.

Note that these settings remain unchanged after a channel preset.

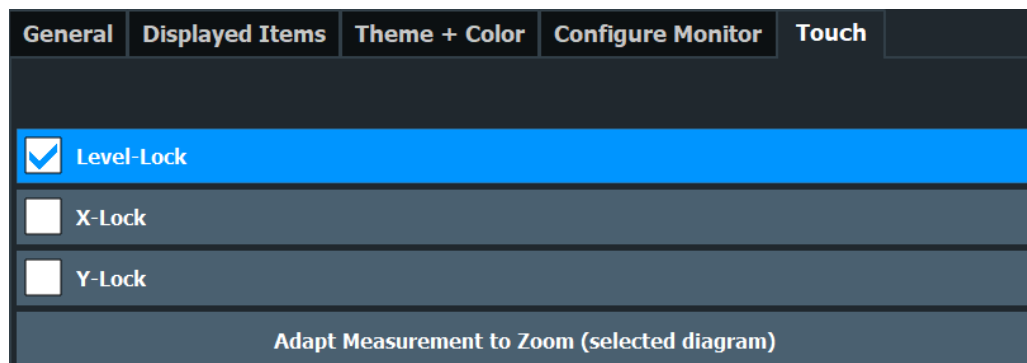

Level Lock.....	745
X-Lock.....	745
Y-Lock.....	745
Adapt Measurement to Zoom (selected diagram).....	745

#### Level Lock

If activated (default), the reference level (and thus the attenuation) is locked, that is: remains unchanged during touch gestures on the screen.

#### X-Lock

If activated, the x-axis of the diagram is not changed during subsequent touch gestures.

#### Y-Lock

If activated, the y-axis of the diagram is not changed during subsequent touch gestures.

#### Adapt Measurement to Zoom (selected diagram)

If you already performed a graphical zoom using the "Single Zoom" on page 543 or "Multi-Zoom" on page 543 functions, this function automatically adapts the measurement settings to maintain the currently zoomed display.

## 11.2.2 How to configure the colors for display and printing

You can configure the style and colors with which various screen objects are displayed or printed.

#### To select a color set

1. Press [Setup] and select "Display".
2. Select the "Theme + Color" tab.

3. In the "Screen Colors" area, do one of the following:
  - Select a predefined set of colors for screen display.
  - Select "User Defined Colors" to configure the color set yourself.
4. In the "Print Colors" area, do one of the following:
  - Select a predefined set of colors for printing screenshots.
  - Select "User Defined Colors" to configure the color set yourself.
5. Activate the "Show Print Colors on Display" option to see a preview of the print colors.

#### To configure a user-defined color set

1. In the "Theme + Color" tab of the "Display" dialog box, select "User Defined Colors" either for the screen or the print colors.
2. Select "Modify User Defined Colors".

The "Screen Color Setup" dialog box is opened.
3. From the "Selected Object:" list, select the object to which you want to assign a color.
4. Do one of the following:
  - Select a color from the "Predefined Colors".
  - Select "Userdefined Colors ..." to define a different color.

The "Preview" area indicates the currently selected color.
5. To assign a user-specific color to the selected object, do one of the following:
  - Select the color from the palette.
  - Enter values for the "Tint:", "Saturation:", and "Brightness:".  
**Note:** In the continuous color spectrum ("Tint:"), 0 % represents red and 100 % represents blue.
  - Enter an "ARGB:" value in hexadecimal format.
6. Select the next object to which you want to assign a color from the "Selected Object:" list.
7. Repeat these steps until you have assigned a color to all objects you want to configure.
8. Select "OK" to close the dialog box.



The colors are applied to the assigned objects.

### 11.2.3 How to work with the soft front panels

Basic operation with the soft front panels is identical to normal operation, except for the following aspects:

- To activate a key, select the key on the touchscreen.

- To simulate the use of the rotary knob, use the additional keys displayed between the keypad and the arrow keys:

Icon	Function
	Turn left
	Enter
	Turn right

### Mini front panel

The mini front panel provides only the keys on the touchscreen, to operate the FSW via an external monitor or remote desktop.

#### To display the soft front panel or mini front panel

1. Press [Setup] and select "Display".
2. Select the "Displayed Items" tab.
3. Select "Front Panel": "On" or "Mini Front Panel": "On".



To hide or show the front panel, press [F6] on the external keyboard (if available) or on the remote computer.

To hide or show the "Mini Front Panel", double-click the title of the softkey menu. As an alternative, press [ALT + m] (be aware of the keyboard language defined in the operating system!) on the external keyboard (if available) or on the remote computer.

#### To close the mini front panel

- ▶ Select the  "Close" icon at the top of the panel.



## 11.2.4 Reference: Keyboard shortcuts for the mini front panel

The mini front panel provides an alternative way to access the functionality of the hardkeys when you are operating the instrument remotely. You can access the keys either using a mouse or using keyboard shortcuts on the remote computer. The follow table provides an overview of the assigned keyboard shortcuts *for a German keyboard layout*. Be aware of the keyboard language defined in the operating system!



To hide or show the "Mini Front Panel", double-click the title of the softkey menu. As an alternative, press [ALT + m].

Hardkey on instrument	Keyboard shortcut
[Freq.]	[Alt+Shift+J]
[Span]	[Alt+Shift+K]

Hardkey on instrument	Keyboard shortcut
[Amp./Scale]	[Alt+Shift+C]
[Auto Set]	[Alt+Shift+N]
[BW]	[Alt+Shift+L]
[Sweep]	[Alt+Shift+M]
[Trace]	[Alt+Shift+F]
[Trigger]	[Alt+Shift+S]
[Meas]	[Alt+Shift+A]
[Meas Config]	[Alt+Shift+W]
[Lines]	[Alt+Shift+B]
[Input/Output]	[Alt+Shift+I]
[Marker]	[Alt+Shift+G]
[Peak Search]	[Alt+Shift+R]
[Marker Function]	[Alt+Shift+Q]
[Marker ->]	[Alt+Shift+H]
[Undo]	[CTRL+Shift+U]
[Redo]	[CTRL+Shift+R]
[Run Single]	[Alt+Shift+D]
[Run Cont.]	[Alt+Shift+E]
[Setup]	[Alt+Shift+T]
[Print]	[Alt+CTRL+P]
[File]	[CTRL+S]
[Mode]	[Alt+Shift+P]
	[CTRL+M]
	[CTRL+N]
[GHz s -dBm V]	[CTRL+Shift+G]
[MHz ms dBm mV]	[CTRL+Shift+M]
[kHz μs dB μV]	[CTRL+Shift+K]
[Hz ns dB.. nV]	[CTRL+Shift+H]
[Preset]	[Alt+Shift+U]

## 11.3 Application starter

The "Application Starter" allows you to start any external application directly from the FSW firmware.

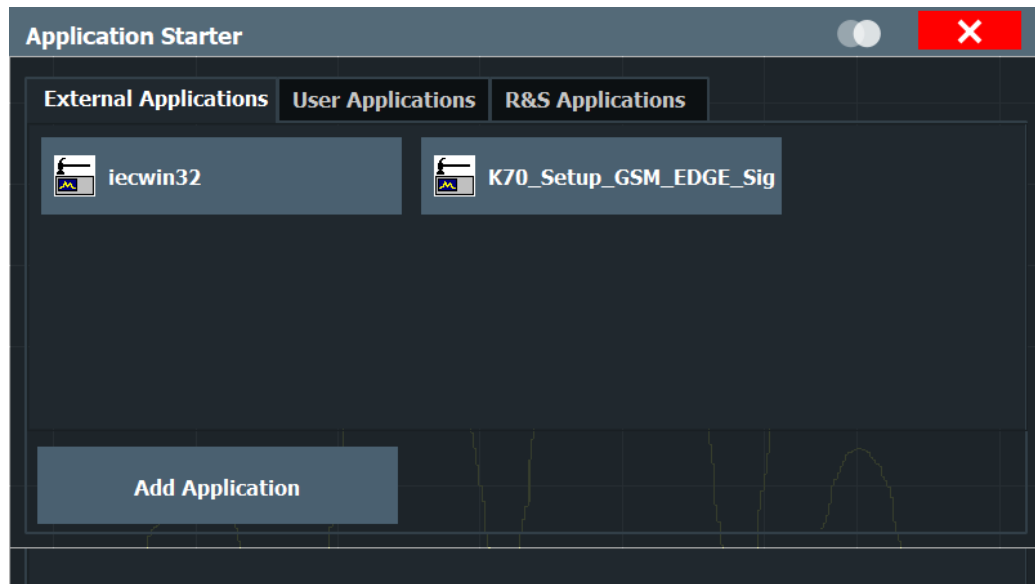

This is useful, for example, for the following scenarios:

- Starting analysis software for the measurement data, such as R&S Vector Signal Analysis (VSA) software
- Starting the provided auxiliary tool IECWIN to test a remote command script that was created using the SCPI Recorder, for example
- Start an application to send the measurement results to a connected PC or cloud
- Start any user-defined application script to provide additional functionality to the firmware, such as measurement-specific auto leveling

### 11.3.1 Application starter functions



**Access:** Toolbar

The "Application Starter" dialog box provides different tabs for different types of applications:

- "External Applications": contains applications that are provided with, but are not part of the FSW, such as auxiliary tools
- "User Applications": contains any user-defined applications that can be accessed from the FSW, such as command scripts
- "R&S Applications": contains applications predefined by Rohde & Schwarz to enhance the functionality of your FSW

You can add further applications to the "User Applications" and "External Applications" tabs as you like. They are separated only to improve usability if you have a large number of applications. You cannot edit the "R&S Applications" tab.

The application starter provides the following functions.

Application buttons.....	750
Add Application/ Change Application.....	750
L Drive/ Path/ File Name.....	751
L File Type.....	751
L File Explorer.....	751
L Select.....	751
Edit Properties.....	751
L Application.....	752
L Parameters.....	752
L Working Directory.....	752
L Display Name.....	752
L Choose Icon.....	753
Delete Link.....	753
Add to Toolbar.....	753
Remove from Toolbar.....	753

### Application buttons

Start the selected application directly on the FSW. Any application windows, outputs, or results are displayed on the FSW screen.

Remote command:

[SYSTem:PLUGIn:APPStarter:EXECute](#) on page 1475

### Add Application/ Change Application

Opens the "Add Application"/ "Change Application" dialog box. Both dialog boxes are identical.

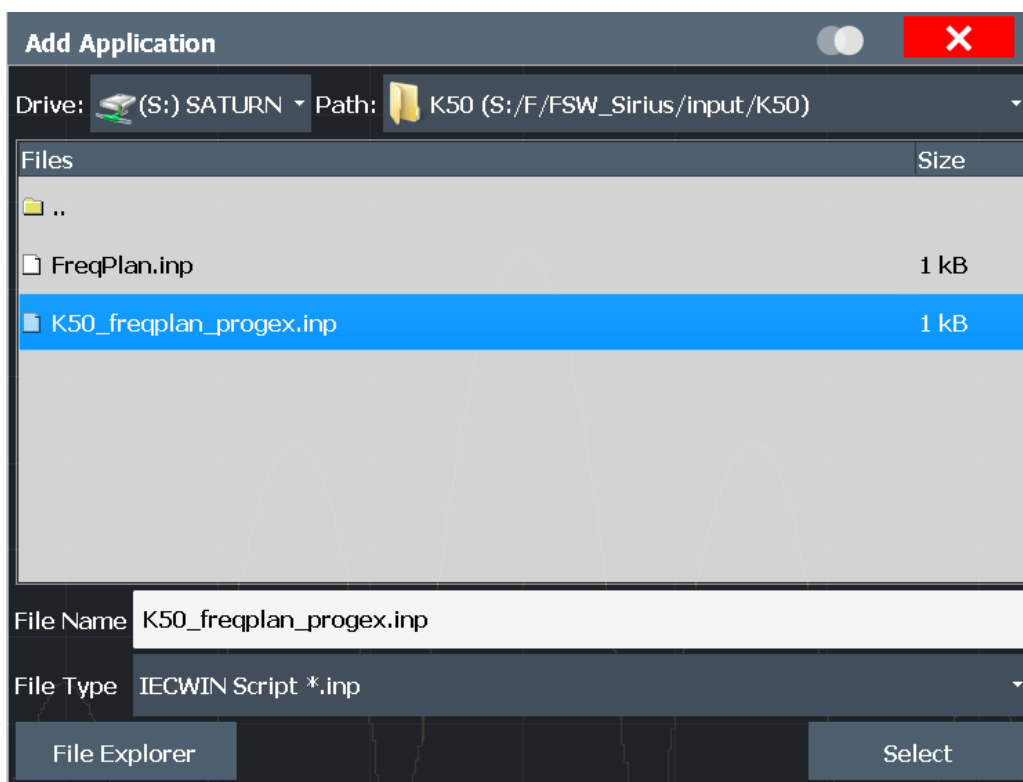

This function is not available for applications on the "R&S Applications" tab.

Remote command:

For data security reasons, executable applications cannot be added to the Application Starter remotely.

#### **Drive/ Path/ File Name ← Add Application/ Change Application**

Defines the path and file name of the application.

#### **File Type ← Add Application/ Change Application**

Defines a filter for the type of application, for example an `.exe`, `.inp` (IECWIN script) or other file.

If you select a file type other than `.exe`, the FSW searches for the appropriate application to start your file with.

For `.inp` files, for example, the IECWIN tool provided by Rohde & Schwarz to execute scripts is preselected as the application to start.

#### **File Explorer ← Add Application/ Change Application**

Opens the Microsoft Windows File Explorer.

Remote command:

not supported

#### **Select ← Add Application/ Change Application**

Closes the "Add Application"/ "Change Application" dialog box and opens the "Edit Properties" dialog box.

Remote command:

[SYSTem:PLUGin:APPStarter:SElect](#) on page 1477

#### **Edit Properties**

**Access:** Application button context menu

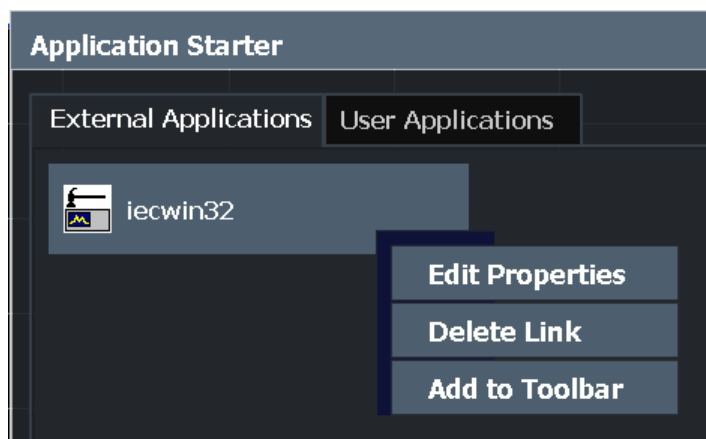

Defines the display and behavior of the selected application.

This function is not available for applications on the "R&S Applications" tab.

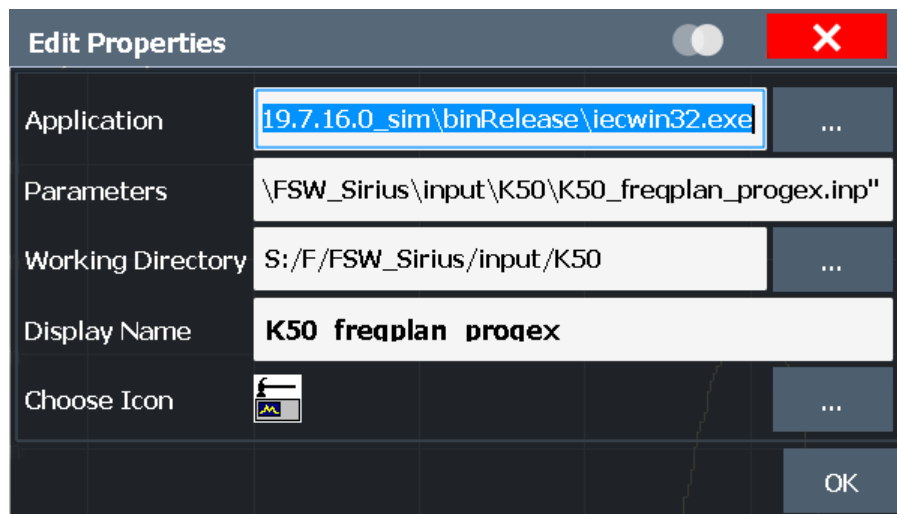
**Tip:**

For `.inp` files, the IECWIN tool provided by Rohde & Schwarz to execute scripts is preselected as the application to start. The script is defined as the parameter for the application. The file name without the extension is used as the application name. The IECWIN icon is selected as the application icon.

Remote command:

[SYSTem:PLUGin:APPStarter:SElect](#) on page 1477

**Application ← Edit Properties**

Indicates the application selected in the "Add Application" dialog box. Provides access to the [Add Application/ Change Application](#) dialog box to change the application.

Remote command:

[SYSTem:PLUGin:APPStarter:SElect](#) on page 1477

**Parameters ← Edit Properties**

Defines parameters that are provided with the application for execution, for example arguments for a custom script.

Remote command:

[SYSTem:PLUGin:APPStarter:PARams](#) on page 1476

**Working Directory ← Edit Properties**

Defines the working directory used by the selected application.

Remote command:

[SYSTem:PLUGin:APPStarter:DIRectory](#) on page 1475

**Display Name ← Edit Properties**

Defines the name of the application as displayed on the button in the "Application Starter" dialog box.

Remote command:

[SYSTem:PLUGin:APPStarter:NAME](#) on page 1476



**Choose Icon ← Edit Properties**

Defines an icon for the application to be displayed on the button in the "Application Starter" dialog box and optionally in the toolbar.

Remote command:

[SYSTEM:PLUGIN:APPStarter:ICON](#) on page 1476

**Delete Link**

**Access:** Application button context menu

Removes the application from the "Application Starter" dialog box and the toolbar.

This function is not available for applications on the "R&S Applications" tab.

Remote command:

[SYSTEM:PLUGIN:APPStarter:DELeTe](#) on page 1475

**Add to Toolbar**

**Access:** Application button context menu

Inserts the specified application icon in the FSW toolbar.

**Remove from Toolbar**

**Access:** Application button context menu

Removes the application icon from the FSW toolbar.

## 11.3.2 How to work with the application starter

**To start an application**

1. Select the Application Starter icon from the toolbar.  
The "Application Starter" dialog box is displayed.
2. Select the required application from the dialog box.  
The application is started and displayed on the FSW screen.

**To return to the FSW**

1. If no external keyboard is connected to the instrument, select the online keyboard icon.
2. Press [Alt]+[Tab].

**To add an application to the Application Starter**

1. Select the Application Starter icon from the toolbar.  
The "Application Starter" dialog box is displayed.
2. Select "Add Application".
3. Select the file type of the application to filter the file selection in the dialog box.
4. Select or enter the file name of the required application.

5. Select "Select".

The "Edit Properties" dialog box is displayed.

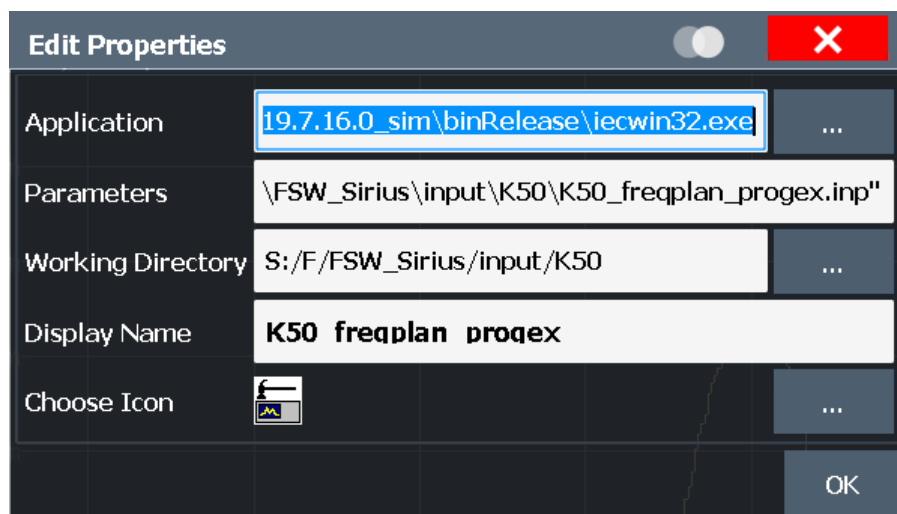

6. Optionally, define parameters to be provided to the application.
7. Define the working directory to be used by the application.
8. Define the name to be displayed on the button in the "Application Starter" dialog box.
9. Select an icon to be displayed on the button in the "Application Starter" dialog box and optionally in the toolbar.
10. Select "OK".

The application is available in the Application Starter.

11. Optionally, add an icon for the application to the toolbar.

#### To add an icon for the application to the toolbar



1. Select the Application Starter icon from the toolbar.  
The "Application Starter" dialog box is displayed.
2. Right-click the application button in the Application Starter.
3. Select "Add to Toolbar".

## 11.4 Transducers

### 11.4.1 Basics on transducer factors

The transducer allows you to manipulate the trace at discrete trace points to correct the signal coming from an input device. Transducers are often used to correct the fre-

quency response for antennas, for example. The transducer is configured by defining transducer factors for specific trace points. A set of transducer factors defines an interpolated transducer line and can be stored on the instrument.

In the Spectrum application, the correction factor from all active transducers is calculated for each displayed trace point once in advance and is added to the result of the level measurement during the sweep. If the sweep range changes, the correction values are calculated again. If several measured values are combined in one point, only one value is taken into consideration. If the active transducer line is not defined for the entire sweep range, the missing values are replaced by zeroes.

When a transducer is used, the trace is shifted by a calculated factor. However, an upward shift reduces the dynamic range for the displayed values. Thus, the reference level can be adapted automatically to restore the original dynamic range. The reference level is shifted by the maximum transducer factor. By default, if transducers are active the reference level function is adapted automatically to obtain the best dynamic performance.

If a transducer factor is active, "TDF" is displayed in the channel bar.



Transducers can also be defined when an optional external mixer is used (R&S FSW-B21).

When using probes for RF input, transducers are automatically created according to the probe's detected characteristics as soon as the probe is connected.

(See the FSW I/Q Analyzer and I/Q Input User Manual.)

Input from I/Q data files is imported as it was stored, including any correction factors, for example from transducers. Any currently configured correction factors at the time of import, however, are not applied.

### Y-Axis Unit

The individual transducer factors can be defined as absolute values or relative (dB) values. However, all factors for one transducer line use the same unit. As soon as a transducer is activated, the unit of the transducer is automatically used for all the level settings and outputs. The unit cannot be changed in the amplitude settings since the FSW and the active transducer are regarded as one measuring instrument. Only for relative transducer factors (unit dB), the unit originally set on the instrument is maintained and can be changed.

When all transducers have been switched off, the FSW returns to the unit that was used before a transducer was activated.

### Configuration

The FSW supports transducer lines with a maximum of 1001 data points. Eight of the transducer lines stored in the instrument can be activated simultaneously. The number of transducer lines stored in the instrument is only limited by the capacity of the storage device used.

A transducer line consists of the following data:

- A maximum of 1001 data points with a position and value

- A unit for the values
- A name to distinguish the transducer lines

### Validity

The transducer factors must comply with the following rules to ensure correct operation:

- The frequencies for the data points must always be defined in ascending order. Otherwise the entry will not be accepted and an error message is displayed.
- The frequencies of the data points may exceed the valid frequency range of the FSW since only the set frequency range is taken into account for measurements. The minimum frequency of a data point is 0 Hz, the maximum frequency 200 GHz.
- The value range for the transducer factor is  $\pm 200$  dB.
- Gain has to be entered as a negative value, and attenuation as a positive value.

### Storing transducer factors

Transducer factors can be exported to a file in ASCII (CSV) format for further evaluation in other applications. Transducer factors stored in the specified ASCII (CSV) format can also be imported to the FSW for other measurements.

Transducer factors can also be stored with the configuration settings so they can be recalled for other measurements at a later time. Note, however, that any changes made to the transducer factors *after* storing the configuration file cannot be restored and will be overwritten by the stored values when the configuration file is recalled. Always remember to store the settings again after changing the transducer factors.

(See [Chapter 10.3, "Storing and recalling instrument settings and measurement data"](#), on page 677).



#### Recalling transducer factors stored with measurement settings

After recalling measurement settings, the transducer factors applied to the measurement may be different to those displayed in the "Transducer" dialog box; see ["Saving and recalling transducer and limit line settings"](#) on page 678.

## 11.4.2 Transducer settings

**Access:** [Setup] > "Transducer"

Up to 8 transducer lines can be activated simultaneously in the FSW. Many more can be stored on the instrument.



Transducers can also be defined when an optional external mixer is used (R&S FSW-B21).



**Transducer settings in secure user mode**

Be sure to store transducer files before [SecureUser Mode](#) is enabled; see [Chapter 4.2.15, "Protecting data using the secure user mode"](#), on page 39.



**Stored transducer settings**

When storing and recalling transducer settings, consider the information provided in ["Saving and recalling transducer and limit line settings"](#) on page 678.

- [Transducer management](#)..... 757
- [Transducer factors](#)..... 759

**11.4.2.1 Transducer management**

**Access:** [Setup] > "Transducer"

The settings required to manage all transducer lines on the instrument are described here.

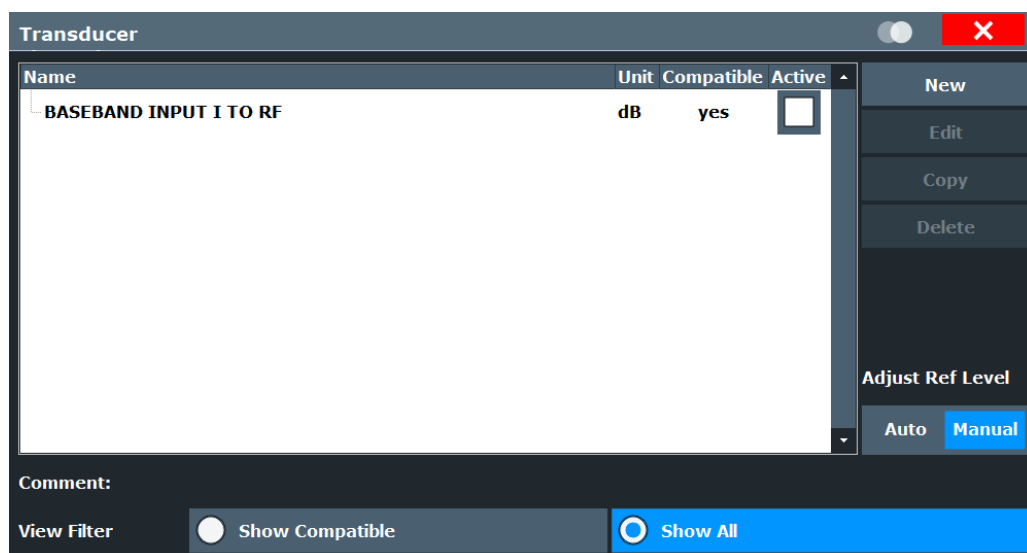

For the transducer line overview, the FSW searches for all stored transducer lines with the file extension .TDF in the C:\Program Files (x86)\Rohde-Schwarz\FSW\\trd directory. The overview allows you to determine which transducer lines are available and can be used for the current measurement.

For details on settings for individual lines see [Chapter 11.4.2.2, "Transducer factors"](#), on page 759.

For instructions on configuring and working with transducers see [Chapter 11.4.4, "How to configure the transducer"](#), on page 763.

[Name](#).....758  
[Unit](#).....758  
[Compatibility](#).....758

Activating / Deactivating.....	758
Comment.....	758
Included Transducer Lines in Overview (View Filter).....	758
Adjust Ref Level.....	759
Create New Line.....	759
Edit Line.....	759
Copy Line.....	759
Delete Line.....	759

**Name**

The name of the stored transducer line.

**Unit**

The unit in which the y-values of the data points of the transducer line are defined.

The following units are available:

- dB
- dBm
- dBmV
- dB $\mu$ V
- dB $\mu$ V/m
- dB $\mu$ A
- dB $\mu$ A/m
- dBpW
- dBpT

Additional units available only for installed FSW-K54 (EMI measurements) option:

- dBmV/MHz (normalized to 1 MHz)
- dB $\mu$ V/MHz (normalized to 1 MHz)
- dB $\mu$ A/MHz (normalized to 1 MHz)

**Compatibility**

Indicates whether the transducer factors are compatible with the current measurement settings.

For more information on which conditions a transducer line must fulfill to be compatible, see [Chapter 11.4.1, "Basics on transducer factors"](#), on page 754.

**Activating / Deactivating**

Activates/deactivates the transducer line. Up to 8 transducer lines can be active at the same time.

Remote command:

`[SENSe:]CORRection:TRANsdUcer:SELEct` on page 1404

`[SENSe:]CORRection:TRANsdUcer[:STATe]` on page 1405

**Comment**

An optional description of the transducer line.

**Included Transducer Lines in Overview (View Filter)**

Defines which of the stored transducer lines are included in the overview. The view can be restricted to compatible transducer lines only or include all transducer lines found. Whether a line is compatible or not is indicated in the [Compatibility](#) setting.

**Adjust Ref Level**

Activates or deactivates the automatic adjustment of the reference level to the selected transducer factor.

"Auto" Activates the automatic adjustment. The original dynamic range is restored by shifting the reference level by the maximum transducer factor.

"Manual" Deactivates the automatic adjustment. Adjust the reference level via the "Amplitude" menu.

Remote command:

[\[SENSe:\]CORRection:TRANsducer:ADJust:RLEVel\[:STATe\]](#) on page 1402

**Create New Line**

Create a new transducer line.

Remote command:

[\[SENSe:\]CORRection:TRANsducer:SElect](#) on page 1404

**Edit Line**

Edit an existing transducer line configuration.

**Copy Line**

Copy the selected transducer line configuration to create a new line.

**Delete Line**

Delete the selected transducer line.

Remote command:

[\[SENSe:\]CORRection:TRANsducer:DElete](#) on page 1404

**11.4.2.2 Transducer factors**

**Access:** [Setup] > "Transducer" > "Edit Line" / "Copy Line" / "New Line"

The settings and functions available for individual transducer lines are described here.

For instructions on creating and editing transducer lines see [Chapter 11.4.4, "How to configure the transducer"](#), on page 763.

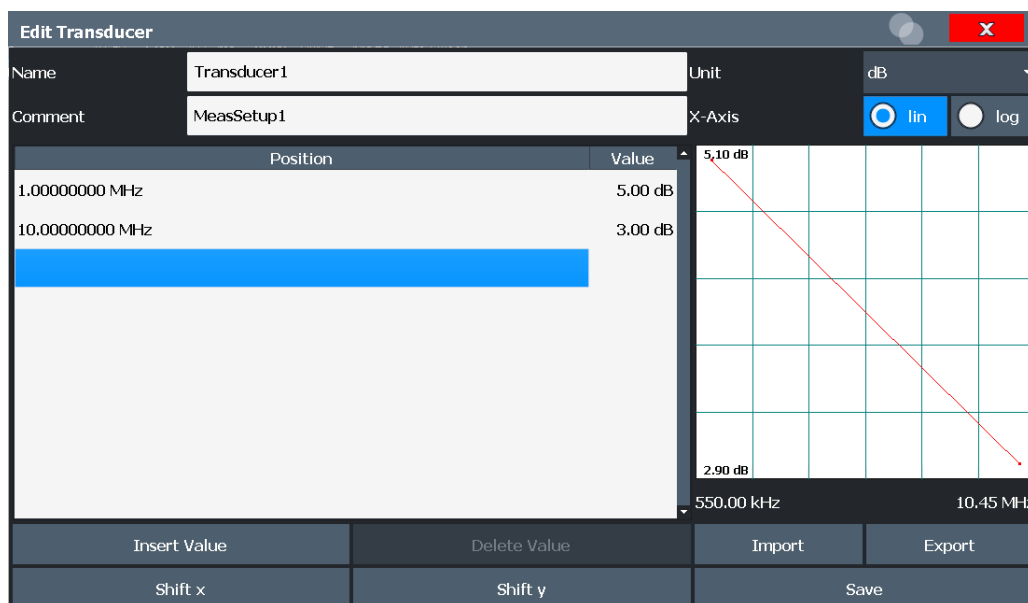

Name.....760

Comment.....760

Unit.....761

X-Axis Scaling.....761

Data Points.....761

Insert Value.....761

Delete Value.....761

Shift x.....761

Shift y.....761

Save.....761

Import.....762

    L File Explorer.....762

Export.....762

    L File Explorer.....762

**Name**

Defines the transducer line name. All names must be compatible with the Windows 10 conventions for file names. The transducer data is stored under this name (with a .TDF extension) in the

C:\Program Files (x86)\Rohde-Schwarz\FSW\<version>\trd directory.

Remote command:

[SENSe:]CORRection:TRANsducer:SELEct on page 1404

**Comment**

Defines an optional comment for the transducer line. The text may contain up to 40 characters.

Remote command:

[SENSe:]CORRection:TRANsducer:COMMeNt on page 1403



**Unit**

The unit in which the y-values of the data points of the transducer line are defined.

As soon as a transducer is activated, the unit of the transducer is automatically used for all the level settings and outputs. The unit cannot be changed in the amplitude settings unless dB is used.

Remote command:

[\[SENSe:\]CORRection:TRANsdUcer:UNIT](#) on page 1405

**X-Axis Scaling**

Describes the scaling of the horizontal axis on which the data points of the transducer line are defined. Scaling can be linear or logarithmic.

Remote command:

[\[SENSe:\]CORRection:TRANsdUcer:SCALing](#) on page 1404

**Data Points**

Each transducer line is defined by a minimum of 2 and a maximum of 1001 data points. Each data point is defined by its position (x-axis) and value (y-value).

The data points must comply with the following rules to ensure correct operation:

- The frequencies for the data points must always be defined in ascending order. Otherwise the entry will not be accepted and an error message is displayed.
- The frequencies of the data points may exceed the valid frequency range of the FSW since only the set frequency range is taken into account for measurements. The minimum frequency of a data point is 0 Hz, the maximum frequency 200 GHz.
- The value range for the transducer factor is  $\pm 200$  dB.
- Gain has to be entered as a negative value, and attenuation as a positive value.

Remote command:

[\[SENSe:\]CORRection:TRANsdUcer:DATA](#) on page 1403

**Insert Value**

Inserts a data point in the transducer line above the selected one in the "Edit Transducer" dialog box.

**Delete Value**

Deletes the selected data point in the "Edit Transducer" dialog box.

**Shift x**

Shifts the x-value of each data point horizontally by the defined shift width.

**Shift y**

Shifts the y-value of each data point vertically by the defined shift width.

**Save**

Saves the currently edited transducer line under the name defined in the "Name" field.

Remote command:

[MMEMory:SELEct\[:ITEM\]:TRANsdUcer:ALL](#) on page 1357

[MMEMory:STORe<1|2>:STATe](#) on page 1360

**Import**

Opens a file selection dialog box and loads the transducer factor from the selected file in .CSV format.

Note that a valid import file must contain a minimum of required information for the FSW. For details on the file format see [Chapter 11.4.3, "Reference: transducer factor file format"](#), on page 762.

Remote command:

`MMEMoRY:LOAD<n>:TFACTOR` on page 1405

**File Explorer ← Import**

Opens the Microsoft Windows File Explorer.

Remote command:

not supported

**Export**

Opens a file selection dialog box and stores the currently displayed transducer factor to the defined file in .CSV format.

For details on the file format see [Chapter 11.4.3, "Reference: transducer factor file format"](#), on page 762.

The transducer factor can be imported again later by the FSW for use in other measurements.

Remote command:

`MMEMoRY:STORe<n>:TFACTOR` on page 1406

**File Explorer ← Export**

Opens the Microsoft Windows File Explorer.

Remote command:

not supported

### 11.4.3 Reference: transducer factor file format

Transducer factor data can be exported to a file in ASCII (CSV) format for further evaluation in other applications. Transducer factors stored in the specified ASCII (CSV) format can also be imported to the FSW for other measurements.

For more information about transducer factors, see ["Import"](#) on page 762.

This reference describes in detail the format of the export/import files for transducer factors. Note that the **bold** data is **mandatory**, all other data is optional.

Different language versions of evaluation programs may require a different handling of the decimal point. Thus, you can define the decimal separator to be used (see ["Decimal Separator"](#) on page 652).

Table 11-1: ASCII file format for transducer factor files

File contents	Description
<b>Header data</b>	
sep=;	Separator for individual values (required by Microsoft Excel, for example)
Type;RS_TransducerFactor;	Type of data
FileFormatVersion;1.00;	File format version
Date;01.Oct 2006;	Date of data set storage
OptionID;SpectrumAnalyzer	Application the transducer factor was created for
Name;TestTDF1	Transducer factor name
Comment;Transducer for device A	Description of transducer factor
XAxisScaling;LINEAR	Scaling of x-axis linear (LIN) or logarithmic (LOG)
YAxisUnit;LEVEL_DB	Unit of y values
YAxisScaleMode;ABSOLUTE	Scaling of y-axis (absolute or relative)
NoOfPoints;5	Number of points the line is defined by
<b>Data section for individual data points</b>	
1000000000;-50.000000	<b>x- and y-values of each data point defining the line</b>
5000000000;-30.000000	
10000000000;0.000000	
15000000000;-30.000000	
25000000000;-50.000000	

#### 11.4.4 How to configure the transducer

Configuring the transducer is very similar to configuring transducer factors.

The transducer settings are defined in the "Transducer" dialog box which is displayed when you press [Setup] and then select "Transducer".



##### Stored transducer settings

When storing and recalling transducer settings, consider the information provided in ["Saving and recalling transducer and limit line settings"](#) on page 678.

The following tasks are described:

- ["How to find compatible transducer lines"](#) on page 764
- ["How to activate and deactivate a transducer"](#) on page 764
- ["How to edit existing transducer lines"](#) on page 764
- ["How to copy an existing transducer line"](#) on page 764
- ["How to delete an existing transducer line"](#) on page 765

- ["How to configure a new transducer line"](#) on page 765
- ["How to move the transducer line vertically or horizontally"](#) on page 766

#### How to find compatible transducer lines

- ▶ In the "Transducer" dialog box, select the "View Filter" option: "Show Compatible". All transducer lines stored on the instrument that are compatible to the current measurement settings are displayed in the overview.

#### How to activate and deactivate a transducer

1. To activate a transducer select a transducer line in the overview and select the "Active" setting for it.  
The trace is automatically recalculated for the next sweep after a transducer line is activated.
2. To deactivate a transducer line, deactivate the "Active" setting for it.  
After the next sweep, the originally measured values are displayed.

#### How to edit existing transducer lines

Existing transducer line configurations can be edited.

1. In the "Transducer" dialog box, select the transducer line.
2. Select "Edit".
3. Edit the line configuration as described in ["How to configure a new transducer line"](#) on page 765.
4. Save the new configuration by selecting "Save".  
The trace is automatically recalculated for the next sweep if the transducer line is active.



In order to store the changes to the transducer lines in a settings file, select the  "Save" icon in the toolbar.

(See [Chapter 10.3, "Storing and recalling instrument settings and measurement data"](#), on page 677).

#### How to copy an existing transducer line

1. In the "Transducer" dialog box, select the transducer line.
2. Select "Copy".  
The "Edit Transducer" dialog box is opened with the configuration of the selected transducer.
3. Define a new name to create a new transducer with the same configuration as the source line.

4. Edit the line configuration as described in ["How to configure a new transducer line"](#) on page 765.
5. Save the new configuration by selecting "Save".

The new transducer line is displayed in the overview and can be activated.

#### How to delete an existing transducer line

1. In the "Transducer" dialog box, select the transducer line.
2. Select "Delete".
3. Confirm the message.

The transducer line is deleted. After the next sweep, the originally measured values are displayed.

#### How to configure a new transducer line

1. In the "Transducer" dialog box, select "New".  
The "Edit Transducer" dialog box is displayed. The current line configuration is displayed in the preview area of the dialog box. The preview is updated after each change to the configuration.
2. Define a "Name" and, optionally, a "Comment" for the new transducer line.
3. Define the scaling for the x-axis.
4. Define the data points: minimum 2, maximum 1001:
  - a) Select "Insert Value".
  - b) Define the x-value ("Position") and y-value ("Value") of the first data point.
  - c) Select "Insert Value" again and define the second data point.
  - d) Repeat this to insert all other data points.  
To insert a data point before an existing one, select the data point and then "Insert Value".  
To insert a new data point at the end of the list, move the focus to the line after the last entry and then select "Insert Value".  
To delete a data point, select the entry and then "Delete Value".
5. Check the current line configuration in the preview area of the dialog box. If necessary, correct individual data points or add or delete some.  
If necessary, shift the entire line vertically or horizontally by selecting "Shift x" or "Shift y" and defining the shift width.
6. Save the new configuration by selecting "Save".

The new transducer line is displayed in the overview and can be activated.

### How to move the transducer line vertically or horizontally

A configured transducer line can easily be moved vertically or horizontally. Thus, a new transducer line can be easily generated based upon an existing transducer line which has been shifted.

1. In the "Line Config" dialog box, select the transducer line.
2. Select "Edit".
3. In the "Edit Transducer Line" dialog box, select "Shift x" or "Shift y" and define the shift width.
4. Save the shifted data points by selecting "Save".

If activated, the trace is recalculated after the next sweep.

### How to export a transducer factor

Transducer factor configurations can be stored to an ASCII file for evaluation in other programs or to be imported later for other measurements.

1. In the "Edit Transducer" dialog box, select the transducer factor.
2. Select "New" or "Edit".
3. Define the transducer factor as described in ["How to configure a new transducer line"](#) on page 765.
4. Select "Export" to save the configuration to a file.  
You are asked whether you would like to save the configuration internally on the FSW first.
5. Select a file name and location for the transducer factor.
6. Select the decimal separator to be used in the file.
7. Select "Save".

The transducer factor is stored to a file with the specified name and the extension `.CSV`.

For details on the file format see [Chapter 11.4.3, "Reference: transducer factor file format"](#), on page 762.

### How to import a transducer factor

Transducer factor configurations that are stored in an ASCII file and contain a minimum of required data can be imported to the FSW.

For details on the required file format see [Chapter 11.4.3, "Reference: transducer factor file format"](#), on page 762.

1. In the "Edit Transducer" dialog box, select the transducer factor.
2. Select "New" or "Edit".
3. Select "Import" to load a transducer factor from a file.

You are asked whether you would like to save the current configuration on the FSW first.

4. Select the file name of the transducer factor.
5. Select the decimal separator that was used in the file.
6. Select "Select".

The transducer factor is loaded from the specified file and displayed in the "Edit Transducer" dialog box.

7. Activate the transducer factor as described in ["How to activate and deactivate a transducer"](#) on page 764.

## 11.5 Frequency response correction (R&S FSW-K544)

If the Frequency Response Correction option (R&S FSW-K544) is installed, the FSW supports frequency response correction using Touchstone (`.snp`) files or `.fres` files.

### 11.5.1 Basics on frequency response correction

#### Input-specific frequency correction

Frequency response correction can be configured individually for all available input types (RF, baseband). The settings in the "User-defined Frequency Response Correction" dialog box apply to the currently selected input type. Be sure to select the appropriate input source before you define the correction data

[Chapter 7.2.2, "Input source settings"](#), on page 362

In remote operation, be sure to use the correct command for the required input type (see ["Input-specific frequency correction"](#) on page 1407).

Otherwise the correction may seem to fail because it was defined for a different input type than the one being used.

#### Touchstone (`.snp`) files

Touchstone (`.snp`) files contain data to characterize a measurement setup in respect to the gain and phase error over frequency. Such files are generated by network analyzers, for example. The FSW can use such files to compensate for any gain or phase errors between the DUT and the connection from the DUT to the instrument.

Touchstone files can be defined for a varying number of input and output ports. The total number of ports configured in the file is indicated by the file extension; the "n" in `.snp` is merely a placeholder. Thus, a file for a cable with one input and one output is referred to as an S2P file. A file for a switch with one input and 3 outputs is referred to as an S4P file etc.

### Transducer vs filter function

Touchstone files are handled similarly to transducer files by the FSW. However, while a transducer adapts the frequency values by a fixed factor, Touchstone files act as a filter on I/Q input data. For common frequency sweeps, the effects of transducers and Touchstone files are the same.

### .fres files

Additional frequency response correction files in `.fres` format allow you to correct effects from components for which no Touchstone files are available.

Files in `.fres` format correspond to an S1P file. They contain exactly three values for each frequency:

- The frequency
- The magnitude correction value
- The phase correction value

Instead of the magnitude and phase correction values, the I and Q values can be provided.

These values are applied to the input data. If the file contains any other data, it cannot be loaded.

For `.fres` files, magnitude and phase correction can be activated separately.

### Group delay compensation

The phase correction values can be used to compensate for a group delay. However, to calculate the correction correctly, the distance between two values must not be too large. Thus, the application requires a minimum number of values in the correction file. Define at least enough values so the following equation is true:

$$\text{Group\_delay} * \text{Frequency\_Spacing} * 360 < 180$$

### Combining multiple correction files

Since the measurement setup may consist of several cables, DUTs and other components, multiple Touchstone and frequency response files can be required for full compensation. In this case, the order in which the files are applied is important. The FSW combines all active Touchstone files to a single S2P file, and creates the required filter or correction factors for the measurement.





### Correction filters for I/Q data

Filters can only be applied to I/Q data if they are defined for the complete analysis bandwidth. Therefore, if the combined frequency response filter does not cover the complete analysis span, it is invalid and cannot be used for the measurement. See also ["Recognizing frequency response correction in measurement results"](#) on page 769.

For common frequency sweeps, values not covered by the combined frequency response are not corrected, but the settings remain valid. A message is displayed in the status bar. See also ["Recognizing frequency response correction in measurement results"](#) on page 769.

### External preamplifier Touchstone files

If an external preamplifier is connected to the FSW, an additional Touchstone file is provided by the preamplifier. The combined frequency response filter also considers those values. For your convenience, the external preamplifier can be switched on and off directly in the "User-Defined Frequency Response Correction" dialog box, as an alternative to the common input settings.

### Correcting data in one or more applications

While transducer files are always used for all measurements on the instrument, `.snp` and `.fres` files can be configured either for the current application only, or for all measurement channels.

Thus, you can configure different files for individual measurement setups with a particular input source and channel setup. For example, you can set up three different I/Q Analyzer channels in parallel and use different Touchstone files for each measurement channel.

### Recognizing frequency response correction in measurement results

If frequency response correction is active for a measurement channel, "FRCORR" is indicated in the channel bar. The status of the correction settings is indicated by the color of this message:

Color	Meaning
Green	Active correction settings valid and in use
Yellow	For Spectrum mode only: Correction settings active, but not all frequencies in measurement span are covered by filter, or the combined filter does not cover any frequencies.  Use the <code>[SENSe:]CORRection:FRESponse&lt;si&gt;:USER:SCOVered?</code> command to determine the covered span.
Red	Correction settings active, but not in use, e.g. due to invalid settings (see <a href="#">"Correction filters for I/Q data"</a> on page 769)

### Remote command:

`[SENSe:]CORRection:FRESponse<si>:USER:VALid?` on page 1424



Since multiple correction settings can be active at the same time, the channel bar merely indicates that frequency response correction is being applied, but not which files are being used. To find out which correction files are being used for the active application, open the "User-Defined Frequency Response Correction" dialog box (see [Chapter 11.5.2, "User-defined frequency response correction settings"](#), on page 770). An LED-like symbol indicates whether each file is active and user correction or the external preamplifier in general is switched on (symbol "lights up") or not (symbol is dark). A purple symbol represents a Touchstone file. A green symbol represents a frequency response (.fres) file.

### Storing frequency response correction settings

You can store frequency response correction settings to a file (saveset) and load them for future measurements. For details see ["Save Settings"](#) on page 774.



#### Storing SaveSets with a loaded Touchstone file

If you store the settings for a measurement using a Touchstone file in a saveset, only the link to the Touchstone file name is actually stored. That means that if you change the settings in the file and recall the saveset for the measurement later, the results will differ from the original measurement.



#### Imported I/Q data

Correction factors are not applied to input from I/Q data files during import. Data from these files is imported as it was stored. However, if any correction factors were applied to the stored data, for example from Touchstone files, the imported data contains those corrections.

### Restrictions

Currently, the FSW has the following restrictions for Touchstone file support:

- Trace data containing corrections from Touchstone files cannot be returned in I/Q block format  
(See `TRAC:IQ:DATA:FORM`, described in the FSW I/Q Analyzer and I/Q Input User Manual).

## 11.5.2 User-defined frequency response correction settings

**Access:** [SETUP] > "User Correction"

User-defined frequency response correction can be defined in one or more Touchstone files and in one or more frequency response (.fres) files, or a combination of them. A configuration of correction files can be stored to and loaded from a file.

Frequency response correction (R&S FSW-K544)

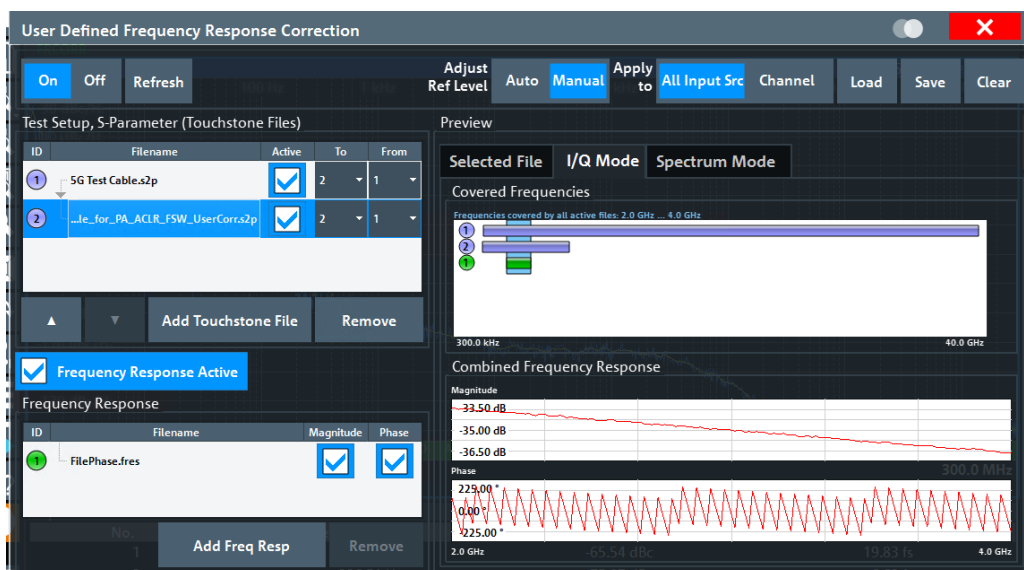

Frequency response correction can be configured individually for all available input types (RF, baseband). The settings in the "User-defined Frequency Response Correction" dialog box apply to the currently selected input type.

- State..... 772
- Refresh..... 772
- Ext. PA Correction..... 772
- Adjust Ref Level..... 773
- Apply to..... 773
- Load Settings..... 773
- Save Settings..... 774
- Clear Settings..... 774
- Touchstone File Information..... 774
  - L ID..... 774
  - L Filename..... 774
  - L Active..... 774
  - L To - From..... 774
- Add Touchstone File..... 775
- Remove File..... 775
- Move File Up or Down..... 775
- Frequency Response active..... 775
- Frequency Response File Information..... 775
  - L ID..... 775
  - L Filename..... 776
  - L Magnitude..... 776
  - L Phase..... 776
- Add Freq Resp File..... 776
- Remove Frequency Response File..... 776
- Preview..... 776

## Frequency response correction (R&amp;S FSW-K544)

L Selected File.....	776
L IQ Mode.....	777
L Spectrum Mode.....	778

**State**

Enables or disables the general usage of user-defined frequency response correction settings. If activated, the data in the active correction files is combined to create a filter. This filter is applied to the measurement results of subsequent sweeps.

TPIS correction is not supported if user frequency response correction is active. If you activate frequency response correction, TPIS correction is automatically deactivated in all channels.

For details see the FSW I/Q Analyzer and I/Q Input User Manual.

Remote command:

`[SENSe:]CORRection:FRESponse<si>:USER:STATE` on page 1423

Testing the validity of the correction setting:

`[SENSe:]CORRection:FRESponse<si>:USER:VALid?` on page 1424

**Refresh**

Retrieves the specified files again and creates a new combined filter. If enabled, the filter is applied immediately.

Remote command:

`[SENSe:]CORRection:FRESponse<si>:INPut<ip>:USER:REFresh`  
on page 1415

**Ext. PA Correction**

This function is only available if an external preamplifier is connected to the FSW, and only for frequencies above 1 GHz. For details on connection, see the preamplifier's documentation.

Using an external preamplifier, you can measure signals from devices under test with low output power, using measurement devices which feature a low sensitivity and do not have a built-in RF preamplifier.

When you connect the external preamplifier, the FSW reads out the touchdown (.S2P) file from the EEPROM of the preamplifier. This file contains the s-parameters of the preamplifier. As soon as you connect the preamplifier to the FSW, the preamplifier is permanently on and ready to use. However, you must enable data correction based on the stored data explicitly on the FSW using this setting.

When enabled, the FSW automatically compensates the magnitude and phase characteristics of the external preamplifier in the measurement results. Any internal preamplifier, if available, is disabled.

An active external preamplifier is also included in the calculation of the combined user-defined frequency response correction filter and displayed in the preview for SnP files (see "Preview" on page 776).

For FSW85 models with two RF inputs, you can enable correction from the external preamplifier for each input individually, but not for both at the same time.

When disabled, no compensation is performed even if an external preamplifier remains connected.

Remote command:

`INPut:EGAIIn[:STATe]` on page 1212

### Adjust Ref Level

Activates or deactivates the automatic adjustment of the reference level to the active filter calculation configuration. The offset is the mean of the filter calculation. The reference level offset is calculated individually for each channel the frequency response correction settings apply to (see ["Apply to"](#) on page 773).

Note the following prerequisites and restrictions concerning the automatic reference level adjustment:

- The reference level offset is only applied if frequency response correction is enabled (see ["State"](#) on page 772). If you disable frequency response correction, "Adjust Ref Level" is automatically set to "Manual".
- The reference level offset is only applied if the center frequency is within the currently covered filter frequency range.
- The reference level offset is applied independently of a transducer reference level offset (see ["Adjust Ref Level"](#) on page 759).

"Auto" Activates the automatic adjustment. The original dynamic range of the reference level is shifted by the filter calculation offset.

"Manual" Deactivates the automatic adjustment. Adjust the reference level in the "Amplitude" settings (see ["Reference Level"](#) on page 484).

Remote command:

`[SENSe:]CORRection:FRESponse<si>:USER:ADJust:RLEVel:STATe` on page 1409

### Apply to

Determines which channels the correction settings are applied to.

**Note:** In MSRA mode, the settings are always applied to **all** active measurement channels.

"All Input Src" The frequency response correction settings are applied to **all** active measurement channels with the same input source. A new filter is calculated for each measurement channel as soon as you switch to it, or when a measurement is performed (e.g. by the Sequencer).

"Channel" The frequency response correction settings are applied to the currently selected channel only.

Remote command:

`[SENSe:]CORRection:FRESponse<si>:USER:SCOPE` on page 1415

### Load Settings

Loads a stored saveset for a user-defined frequency response correction scenario. Existing settings in the dialog box are overwritten. The settings apply to the currently selected channel or all channels, depending on the [Apply to](#) setting.

Only `.df1` files can be loaded. The default storage directory for correction files is `C:\R_S\INSTR\USER\FResponse`.

Remote command:

`[SENSe:]CORRection:FRESponse<si>:USER:LOAD` on page 1414

**Save Settings**

Stores a saveset for a user-defined frequency response correction scenario. As for all instrument settings, a `.df1` file is created for the correction data. Note that only the settings defined in this dialog box are stored, not the contents of the files themselves. Whether the settings for the currently selected channel only or for all channels are stored depends on the [Apply to](#) setting.

The default storage directory is `C:\R_S\INSTR\USER\FResponse`.

Remote command:

`[SENSe:]CORRection:FRESponse<si>:USER:STORe` on page 1423

**Clear Settings**

Clears all current user-defined frequency response correction settings, either for the currently selected channel only or for all channels, depending on the [Apply to](#) setting.

Merely files specific to the FSW itself remain in the list of Touchstone files.

Remote command:

`[SENSe:]CORRection:FRESponse<si>:USER:PRESet` on page 1415

**Touchstone File Information**

Provides information on loaded Touchstone files and the order of their application.

If an external preamplifier is active, it is also included at the bottom of the list.

**ID ← Touchstone File Information**

Consecutive number which determines the order in which the correction files are applied to the measurement data. The maximum number of files per configuration is 15.

An LED-like symbol indicates whether the file is active and Touchstone files or the external preamplifier in general are switched on (symbol "lights up") or not (symbol is dark). A purple symbol represents a Touchstone file.

**Filename ← Touchstone File Information**

Name of a loaded Touchstone file.

**Active ← Touchstone File Information**

Activates or deactivates the selected file for the current configuration. Only active files are included in filter calculation.

Remote command:

`[SENSe:]CORRection:FRESponse<si>:USER:SLISt<sli>:STATe`

on page 1422

**To - From ← Touchstone File Information**

Touchstone files can be defined for a varying number of input and output ports.

You must define the ports from the Touchstone file whose data is to be applied.

Remote command:

`[SENSe:]CORRection:FRESponse<si>:USER:SLISt<sli>:PORTs:TO`

on page 1419

`[SENSe:]CORRection:FRESponse<si>:USER:SLISt<sli>:PORTs:FROM`

on page 1419

**Add Touchstone File**

Loads a new Touchstone file for the current configuration. The maximum number of files per configuration is 15. The new file is added below the currently selected file. To change the order of the files, use the [Move File Up or Down](#) icons.

The file extension of the Touchstone file must correspond to the number of ports included in the file. For example, a file containing 4 parameters for S11, S22, S12 and S21 must have the extension `.s2p`.

A minimum number of values is required to compensate for a group delay, see "[Group delay compensation](#)" on page 768.

The default directory for Touchstone files is `C:\R_S\INSTR\USER\Fresponse`.

Remote command:

`[SENSe:]CORRection:FRESponse<si>:USER:SLISt<sli>:INSert`  
on page 1418

**Remove File**

Removes the selected Touchstone file from the current configuration.

Remote command:

`[SENSe:]CORRection:FRESponse<si>:USER:SLISt<sli>:REMOve`  
on page 1420  
`[SENSe:]CORRection:FRESponse<si>:USER:SLISt<sli>:CLEar`  
on page 1417

**Move File Up or Down**

Moves the selected Touchstone file one position up or down in the list of files, changing the order in which the correction data is applied.

Remote command:

`[SENSe:]CORRection:FRESponse<si>:USER:SLISt<sli>:MOVE` on page 1418

**Frequency Response active**

Activates or deactivates the use of additional frequency response (`.fres`) files. The correction data in these files is applied after any correction settings in active Touchstone files. Only active files are included in filter calculation.

Remote command:

`[SENSe:]CORRection:FRESponse<si>:USER:FSTate` on page 1413

**Frequency Response File Information**

Provides information on loaded frequency response files and the order of their application.

**ID ← Frequency Response File Information**

Consecutive number which determines the order in which the correction files are applied to the measurement data. The maximum number of files per configuration is 15.

An LED-like symbol indicates whether the file and frequency response in general is active (symbol "lights up") or not (symbol is dark). A green symbol represents a frequency response (`.fres`) file.

**Filename ← Frequency Response File Information**

Name of a loaded Touchstone file.

**Magnitude ← Frequency Response File Information**

Activates or deactivates the use of the correction data in the selected file for magnitude results.

Remote command:

`[SENSe:]CORRection:FRESponse<si>:USER:FLISt<fli>:MAGNitude[:STATe]` on page 1411

**Phase ← Frequency Response File Information**

Activates or deactivates the use of the correction data in the selected file for phase results.

Remote command:

`[SENSe:]CORRection:FRESponse<si>:USER:FLISt<fli>:PHASe[:STATe]` on page 1412

**Add Freq Resp File**

Loads a frequency response (.fres) file to the current configuration. The maximum number of files per configuration is 15.

A minimum number of values is required to compensate for a group delay, see "[Group delay compensation](#)" on page 768.

The default directory for .fres files is C:\R\_S\INSTR\USER\Fresponse.

Remote command:

`[SENSe:]CORRection:FRESponse<si>:USER:FLISt<fli>:INSert` on page 1410

**Remove Frequency Response File**

Removes the selected frequency response (.fres) file from the current configuration.

Remote command:

`[SENSe:]CORRection:FRESponse<si>:USER:FLISt<fli>:REMOve` on page 1412

`[SENSe:]CORRection:FRESponse<si>:USER:FLISt<fli>:CLEAr` on page 1410

**Preview**

The preview of the (combined) user correction files shows the correction values.

Remote command:

`[SENSe:]CORRection:FRESponse<si>:USER:PSTATe` on page 1420

`[SENSe:]CORRection:FRESponse<si>:USER:SCOVERed?` on page 1416

**Selected File ← Preview**

The preview of the selected user correction file shows the correction values for the specified frequency range. The values for individual ports can be activated or deactivated.



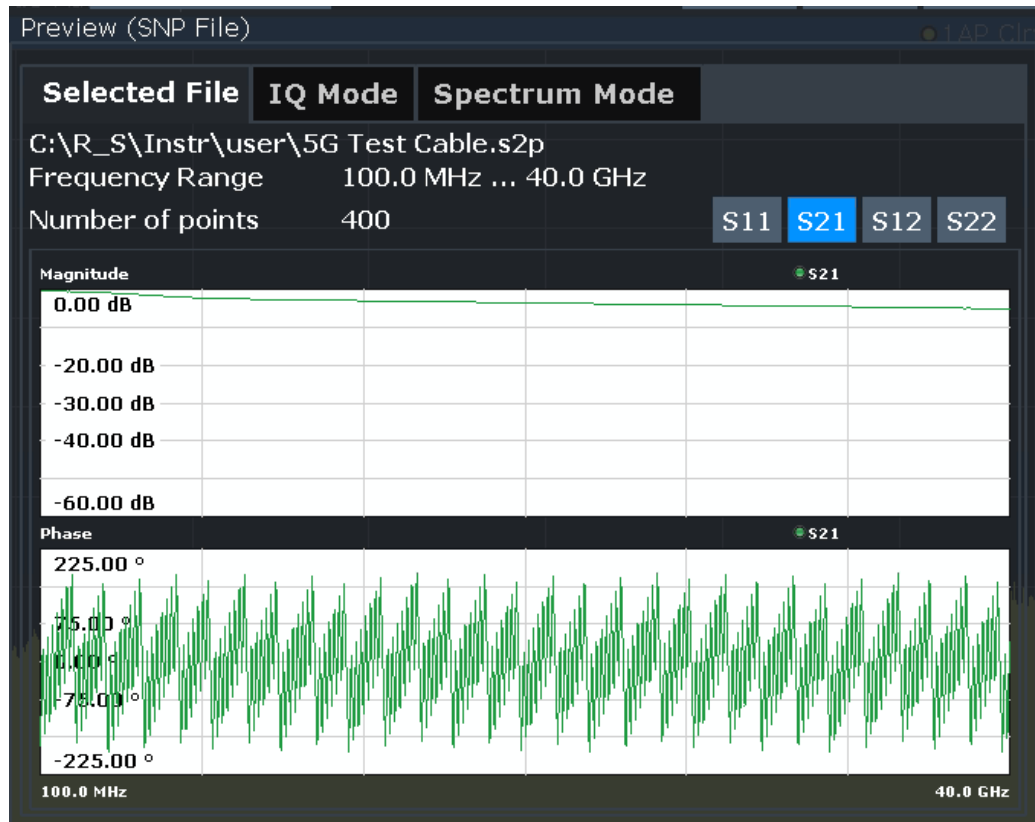

Figure 11-1: Preview of selected user correction file

Remote command:

[SENSe:]CORRection:FRESponse<si>:USER:FLISt<fli>:DATA:FREQuency?  
on page 1410

[SENSe:]CORRection:FRESponse<si>:USER:FLISt<fli>:DATA:MAGNitude?  
on page 1410

[SENSe:]CORRection:FRESponse<si>:USER:FLISt<fli>:DATA:PHASe?  
on page 1410

[SENSe:]CORRection:FRESponse<si>:USER:SLISt<sli>:DATA:  
FREQuency<spi>? on page 1417

[SENSe:]CORRection:FRESponse<si>:USER:SLISt<sli>:DATA:  
MAGNitude<spi>? on page 1417

[SENSe:]CORRection:FRESponse<si>:USER:SLISt<sli>:DATA:  
PHASe<spi>? on page 1417

### IQ Mode ← Preview

The preview in IQ Mode indicates the frequency ranges covered by the individual correction files. The blue bar indicates the valid frequency range for which all files contain values.

An LED-like symbol indicates whether each file is active and user correction in general is switched on (symbol "lights up") or not (symbol is dark). A purple symbol represents a Touchstone file. A green symbol represents a frequency response (.fres) file.

The lower part shows the combined correction values for the valid frequency range.

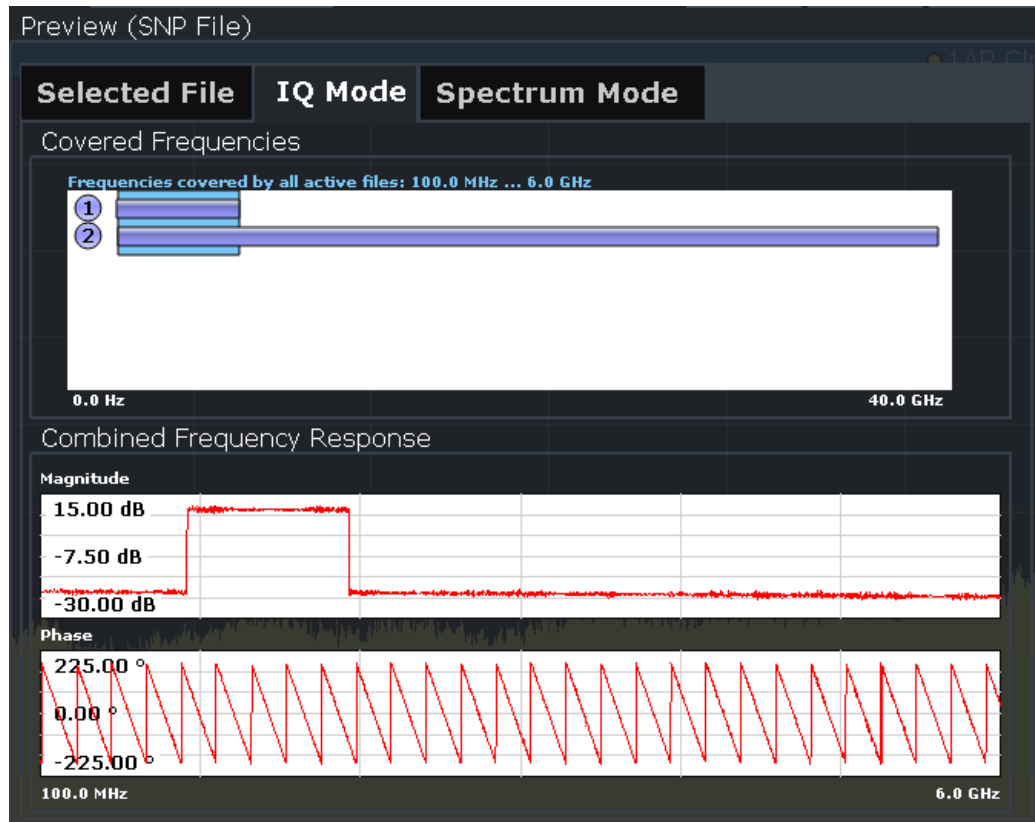

Figure 11-2: IQ Mode preview of user correction files

Remote command:

`[SENSe:]CORRection:FRESponse<si>:USER:IQ:DATA:FREQuency?`

on page 1414

`[SENSe:]CORRection:FRESponse<si>:USER:IQ:DATA:MAGNitude?`

on page 1414

`[SENSe:]CORRection:FRESponse<si>:USER:IQ:DATA:PHASe?` on page 1414

### Spectrum Mode ← Preview

The preview in Spectrum Mode indicates the frequency ranges covered by the individual correction files. The blue bar indicates the valid frequency range for which at least one file contains values.

An LED-like symbol indicates whether each file is active and user correction in general is switched on (symbol "lights up") or not (symbol is dark). A purple symbol represents a Touchstone file. A green symbol represents a frequency response (`.fres`) file.

The lower part shows the combined correction values for the valid frequency range.



Figure 11-3: Spectrum Mode preview of user correction files

Remote command:

`[SENSe:]CORRection:FRESponse<si>:USER:SPECTrum:DATA:FREQuency?`

on page 1422

`[SENSe:]CORRection:FRESponse<si>:USER:SPECTrum:DATA:MAGNitude?`

on page 1422

`[SENSe:]CORRection:FRESponse<si>:USER:SPECTrum:DATA:PHASe?`

on page 1422

## 11.6 Reference frequency settings

Access: [Setup] > "Reference"

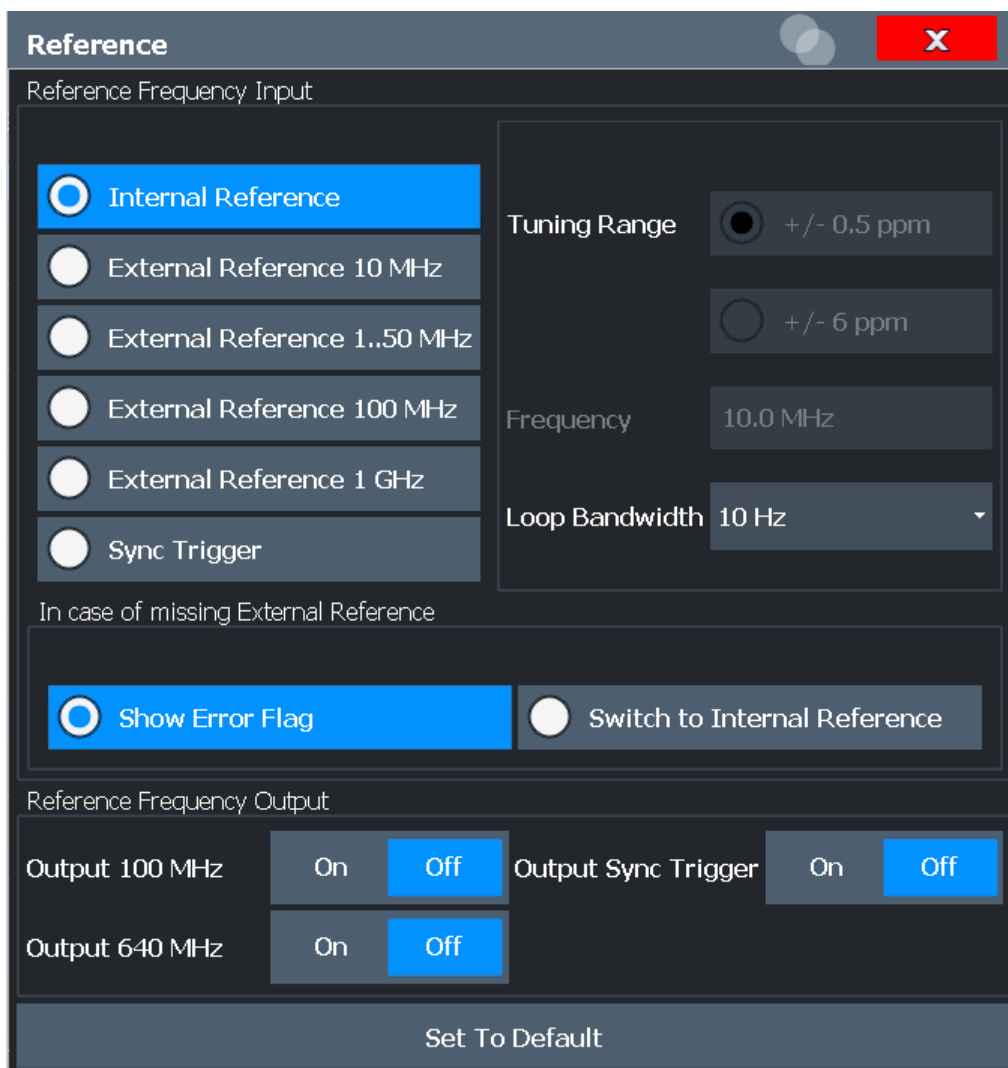

Reference Frequency Input.....780

- L Behavior in case of missing external reference..... 781
- L Tuning Range..... 782
- L Frequency..... 782
- L Loop Bandwidth..... 782

Reference Frequency Output..... 782

Set to Default..... 782

**Reference Frequency Input**

The FSW can use the internal reference source or an external reference source as the frequency standard for all internal oscillators. A 10 MHz crystal oscillator is used as the internal reference source. In the external reference setting, all internal oscillators of the FSW are synchronized to the external reference frequency.

External references are connected to one of the REF INPUT or the SYNC TRIGGER connectors on the rear panel.

**Note:** The optional, and more precise OCXO signal can replace the internal reference source.

The default setting is the internal reference. When an external reference is used, EXT REF is displayed in the status bar.

The following reference inputs are available:

**Table 11-2: Available Reference Frequency Input**

Setting	Source Connector	Frequency	Tuning Range	Loop Bandwidth	Description
Internal	(OCXO)	10 MHz	-	1-100 Hz	Internal reference signal or optional OCXO
External Reference 10 MHz	REF INPUT 1..50 MHz	10 MHz	+/- 6 ppm	1-100 Hz	Fixed external 10 MHz reference frequency Good phase noise performance
External Reference 1..50MHz	REF INPUT 1..50 MHz	1..50 MHz in 1 Hz steps	+/- 0.5 ppm	0.1 Hz (fixed)	Variable external reference frequency in 1 Hz steps Good external phase noise suppression. Small tuning range.
			+/- 6 ppm	1-30 Hz	Variable external reference frequency in 1 Hz steps Wide tuning range.
External Reference 100 MHz	REF INPUT 100 MHz / 1 GHz	100 MHz	+/- 6 ppm	1-300 Hz	External reference Good phase noise performance
External Reference 1 GHz	REF INPUT 100 MHz / 1 GHz	1 GHz	+/- 6 ppm	1-300 Hz	External reference
Sync Trigger	SYNC TRIGGER INPUT	100 MHz	+/- 6 ppm	1-300 Hz	External reference

Remote command:

[\[SENSe:\]ROSCillator:SOURce](#) on page 1391

[SOURce<si>:EXTernal<ext>:ROSCillator:EXTernal:FREQuency](#)  
on page 1391

#### Behavior in case of missing external reference ← Reference Frequency Input

If an external reference is selected but none is available, there are different ways the instrument can react.

"Show Error Flag"      The error message "External reference missing" is displayed if no valid external reference signal is available. Additionally, the flag "NO REF" is displayed to indicate that no synchronization was performed *for the last measurement*.

"Switch to internal reference"      The instrument automatically switches back to the internal reference if no external reference is available. Note that you must re-activate the external reference if it becomes available again at a later time.

Remote command:

[\[SENSe:\]ROSCillator:EXTernal:FALLback](#) on page 1390

**Tuning Range ← Reference Frequency Input**

The tuning range is only available for the variable external reference frequency. It determines how far the frequency may deviate from the defined level in parts per million ( $10^{-6}$ ).

- " $\pm 0.5$  ppm" With this smaller deviation a very narrow fixed loop bandwidth of 0.1 Hz is realized. With this setting the instrument can synchronize to an external reference signal with a very precise frequency. Due to the very narrow loop bandwidth, unwanted noise or spurious components on the external reference input signal are strongly attenuated. Furthermore, the loop requires about 30 seconds to reach a locked state. During this locking process, "NO REF" is displayed in the status bar.
- " $\pm 6$  ppm" The larger deviation allows the instrument to synchronize to less precise external reference input signals.

Remote command:

[\[SENSe:\]ROSCillator:TRANge](#) on page 1393

**Frequency ← Reference Frequency Input**

Defines the external reference frequency to be used (for variable connectors only).

**Loop Bandwidth ← Reference Frequency Input**

Defines the speed of internal synchronization with the reference frequency. The setting requires a compromise between performance and increasing phase noise.

For a variable external reference frequency with a narrow tuning range ( $\pm 0.5$  ppm), the loop bandwidth is fixed to 0.1 Hz and cannot be changed.

Remote command:

[\[SENSe:\]ROSCillator:LBWidth](#) on page 1389

**Reference Frequency Output**

A reference frequency can be provided by the FSW to other devices that are connected to this instrument. If activated, the reference signal is output to the corresponding connector.

"Output 100 MHz"

Provides a 100 MHz reference signal to the REF OUTPUT 100 MHz connector.

"Output 640 MHz"

Provides a 640 MHz reference signal to the REF OUTPUT 640 MHz connector.

"Output Sync Trigger"

Provides a 100 MHz reference signal to the SYNC TRIGGER OUTPUT connector.

Remote command:

[\[SENSe:\]ROSCillator:O640](#) on page 1390

[\[SENSe:\]ROSCillator:OSYNc](#) on page 1391

**Set to Default**

The values for the "Tuning Range", "Frequency" and "Loop Bandwidth" are stored for each source of "Reference Frequency Input".

When you switch the input source, the previously defined settings are restored. You can restore the default values for all input sources using the "Set to Default" function.

## 11.7 System configuration settings

**Access:** [Setup] > "System Configuration"

- [Hardware information](#).....783
- [Licensing, versions and options](#).....784
- [System messages](#).....789
- [Firmware updates](#).....790
- [General configuration settings](#).....791
- [Signal generator settings](#).....793
- [AC power loss behavior](#).....795

### 11.7.1 Hardware information

**Access:** [Setup] > "System Configuration" > "Hardware Info"

An overview of the installed hardware in your FSW is provided.

Every listed component is described by its serial number, part number, model information, hardware code, and hardware revision.

This information can be useful when problems occur with the instrument and you require support from Rohde & Schwarz.

System Configuration						
Hardware Info	Versions + Options	System Messages	Firmware Update	Signal Generator		
COMPONENT	SERIAL #	ORDER #	MODEL	HWC	REV	
MOTHERBOARD	000000	0000000000	02	00	01.00	
MICROWAVE CONVERTER BASE BOARD	000000	0000000000	02	00	00.00	
MICROWAVE CONVERTER FRONTEND UNIT	000000	0000000000	02	00	00.00	
RF ATTENUATOR	000000	0000000000	02	00	00.10	
RF PREAMPLIFIER BOARD	000000	0000000000	26	00	01.00	
OCXO	000000	0000000000	00	00	00.00	
FRONTBOARD	000000	0000000000	02	00	00.00	
BANDWIDTH EXTENSION	000000	0000000000	02	00	01.00	
ADD. INTERFACE BOARD	000000	0000000000	02	00	01.00	
CPU BOARD - SIM	000000	0000000000				
FREQUENCY RESPONSE ALIGNMENT					10.05	
ENHANCED COMPUTING POWER						
DEFAULT IDENTITY						

**Remote command:**

`DIAGnostic:SERVICE:HWInfo?` on page 1447

## 11.7.2 Licensing, versions and options

**Access:** [Setup] > "System Configuration" > "Versions + Options"

Information on the firmware version and additional licensed options on your instrument is provided. The unique Rohde & Schwarz device ID is also indicated here, as it is required for license and option administration.

State	Item	Option	Version	License
	MWC FPGA		2.6.4.1	
	BW EXT FPGA		4.0.0.0	
	FE FPGA		2.10.1.0	
	BB FE FPGA		0.0.4.0	
	Data Sheet		01.00	
	Time Control Management			active
	Smart Card Service			installed
	OXC0 Precision Frequency Reference	B4		
	Add. Interface Board	B5		
	LO/IF Connections For External Mixers	B21		
	Enhanced Computing Power	B114		
...	GSM/EDGE/EDGE Evo/VAMOS Measurements	K10		floating
...	Noise Figure Measurements	K30		floating
...	Phase Noise Measurements	K40		floating
...	Vector Signal Analysis	K70		occupied floating

Buttons at the bottom of the window: Install Option, Install Option by XML, Setup Floating License Server

### Remote commands:

[SYSTEM:FORMat:IDENT](#) on page 1450

[DIAGnostic:SERvice:BIOSinfo?](#) on page 1447

[DIAGnostic:SERvice:VERSinfo?](#) on page 1447

- [Obtaining copyright information on used third-party sources](#).....784
- [License management](#).....784

### 11.7.2.1 Obtaining copyright information on used third-party sources

#### Open Source Acknowledgment: Open

Displays a PDF file containing information on open-source code used by the FSW firmware.

### 11.7.2.2 License management

After installing optional firmware, you must install or enable its license.





### Installing options in secure user mode

Be sure to install any new options before [SecureUser Mode](#) is enabled; see [Chapter 4.2.15, "Protecting data using the secure user mode"](#), on page 39.

For restricted users in secure user mode, this function is not available.

### Expired option licenses

If a timed option license is about to expire, a message box is displayed to inform you. You can then use the "Install Option" function to enter a new license key or you can enable a new floating license.

If a timed option license has already expired, a message box appears for you to confirm. In this case, the optional functions and applications are unavailable until you enter a new license key or enable a floating license.

### Trial license

The trial option (R&S FSW-K0) allows you to use further optional applications that require a separate license from Rohde & Schwarz. It is pre-installed at the factory on request. If enabled, you can use additional applications for a limited period of time (90 days from factory installation). They are accessible from the common "Mode" dialog box (see [Chapter 5.3, "Selecting the operating mode and applications"](#), on page 120).

If the trial option has already expired, a message box appears for you to confirm. In this case, all instrument functions are unavailable (including remote control) until the FSW is rebooted. To continue to use the optional applications, you must acquire a commercial license. Then use the "Install Option" function to enter the new license key or activate a floating license as described in [Chapter 11.7.2, "Licensing, versions and options"](#), on page 784.

### Using a Floating License Server

As an alternative to license key files installed on the FSW, software licenses can now also be provided by an R&S®License Server. In this case, all available licenses are stored on a specified server. When you need a particular application, you obtain a license from the server. When you no longer need the license, you return it to the server and it becomes available to other users again. These licenses are also referred to as *floating licenses*, as opposed to permanently assigned licenses.

If the predefined number of available licenses for a particular option are currently occupied by other users, you cannot open a further instance of the optional application until a license is returned. Per option, you only require a single license for any number of channels.

The R&S®License Server must be set up as described in the R&S®License Server - Managing Floating Licenses - User Manual.

Two different types of licenses are available.

### Common floating license

A common floating license enables you to use an option as long as you need it, but requires a permanent connection to the license server.

The license is retrieved from the license server only when you select the application in the "Mode" dialog box. Only one license per option is retrieved, but the option can be used in multiple channels. It is returned shortly after you close the (last) application channel. The license is blocked for other users only while at least one application channel is in use.

If the connection to the license server is lost for longer than approximately 10 minutes, the FSW assumes no license is available and closes the application.

### Occupied license

An occupied license is retrieved once from the license server and stored locally for up to 7 days, depending on the selected time period. During the occupied period, the license is blocked for other users. After this time, the license automatically expires and becomes available on the license server again. During the occupied period, no further access to the license server is required. The license cannot be returned or disabled manually before it expires, but it can be extended.

When the license expires, you must retrieve a new license from the license server. If the connection to the license server is not available or no more licenses are available, the FSW closes the application.

Occupied licenses are only available for instruments using a Windows 10 operating system.

<a href="#">Install Option</a> .....	786
<a href="#">Install Option by XML</a> .....	786
<a href="#">License state (.....)</a> .....	787
L <a href="#">Enabling/disabling floating licenses</a> .....	787
<a href="#">Setup Floating License Server</a> .....	788
L <a href="#">IP / Host name</a> .....	788
L <a href="#">Port</a> .....	788
L <a href="#">Description</a> .....	788
L <a href="#">Add Server</a> .....	789
L <a href="#">Remove Server</a> .....	789
L <a href="#">Refresh List</a> .....	789

### Install Option

Opens an edit dialog box to enter the (permanently assigned) license key for an option.

Only user accounts with administrator rights are able to install options and enable licenses.

### Install Option by XML

Opens a file selection dialog box to install an additional (permanently assigned) option license to the FSW using an XML file. Enter or browse for the name of an XML file that contains the option license key and select "Select".

Only user accounts with administrator rights are able to install options and enable licenses.

**License state ( )**

Provides functions to enable or disable a floating license for an installed option. These functions are only available if a floating license server is configured (see ["Setup Floating License Server"](#) on page 788).

**Note:** Trial license. If the trial option (R&S FSW-K0) is installed, the "State" column indicates whether an individual trial license is enabled or disabled.

Remote command:

`SYSTem:OPTion:LIcense[:LIST]?` on page 1451

Enable/disable trial option: `SYSTem:OPTion:TRIAL[:STATe]` on page 1452

Determine available trial applications: `SYSTem:OPTion:TRIAL:LIST?` on page 1452

**Enabling/disabling floating licenses ← License state ( )**

If a floating license server is configured (see ["Setup Floating License Server"](#) on page 788), you can enable or disable a license for the selected option in the "License" dialog box. Two different types of licenses are available (see ["Using a Floating License Server"](#) on page 785).

You cannot change a license state that is currently in use by an application. The change in license usage becomes effective when you select "Apply". Restarting the firmware is not necessary.

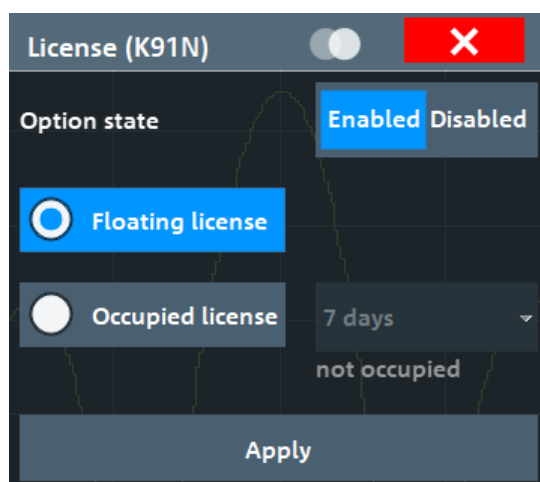

"Enabled"

If enabled, the license is retrieved from the license server when you select the application in the "Mode" dialog box. Some options are available for multiple applications, such as power sensor support. In this case, the license is retrieved if you select any application that supports the option. For options with suboptions, e.g. K91 with suboptions K91AC, K91N, all suboptions are automatically activated together with the main option by default.

"Disabled"

If the license is disabled, it is not retrieved from the server when you open the main application. The option is grayed out in the "Versions + Options" dialog box. Disabling licenses is useful for suboptions (e.g. K91N) or options that are available for multiple applications.

**"Occupied license" period**

Defines the time period that an occupied license is stored locally after it is retrieved from the license server. A time period between 1 and 7 days is available. The license cannot be returned or disabled manually before it expires, but it can be extended.

Remote command:

`SYSTEM:OPTion:LiCense[:LIST]` on page 1450

**Setup Floating License Server**

To use floating licenses, you must set up one or more floating license servers. The FSW software checks the configured servers for available floating licenses when it starts up. Only options for which licenses are found are available in the FSW. After adding new options on the floating license server, you must restart the FSW software before using them.

For details on the floating license concept, see ["Using a Floating License Server"](#) on page 785.

For details on configuring floating license servers, see the R&S® License Server - Managing Floating Licenses - user manual.

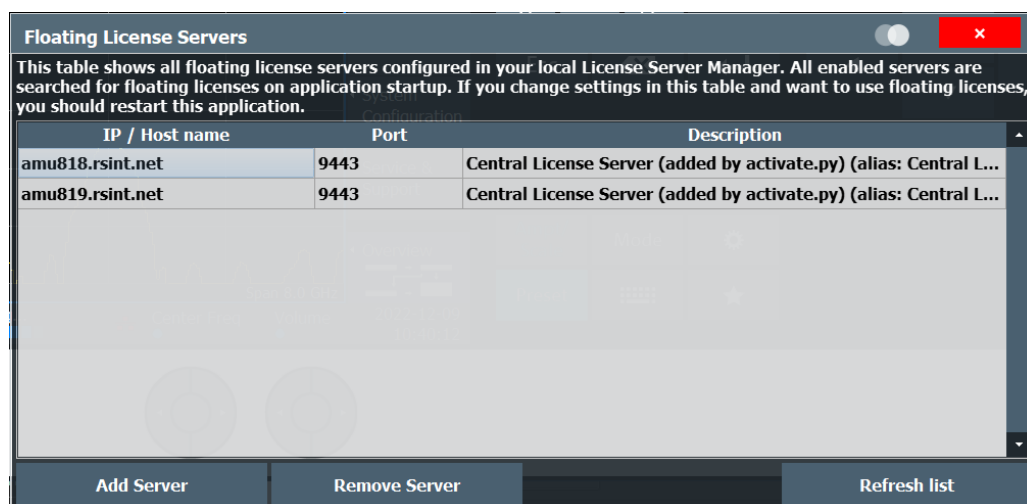

Indicates the currently configured floating license servers. All enabled servers are searched for floating licenses when the FSW software starts. Note that changes to the list of servers only take effect after the FSW software and the local License Manager are restarted. To abort any changes, simply close the dialog box.

**IP / Host name ← Setup Floating License Server**

IP address or host name of the server. Ask your administrator for details.

**Port ← Setup Floating License Server**

Port information for the server. The default port is 9443.

Ask your administrator for details.

**Description ← Setup Floating License Server**

Optional description of the configured server.

**Add Server ← Setup Floating License Server**

Opens a dialog to add a floating license server. The server must be connected to the same network as the FSW software, and set up as described in the R&S® License Server - Managing Floating Licenses - user manual.

Configure the [IP / Host name](#) and [Port](#).

The license server automatically restarts. To update the server list and the list of available licenses, you must also restart the FSW software.

**Remove Server ← Setup Floating License Server**

Removes the selected server permanently. To update the server list and the list of available licenses, you must also restart the FSW software.

**Refresh List ← Setup Floating License Server**

Updates the list of floating license servers, for example after someone changes the configuration via the web application instead of the FSW dialog.

### 11.7.3 System messages

**Access:** [Setup] > "System Configuration" > "System Messages"

The system messages generated by the FSW are displayed.

The messages are displayed in the order of their occurrence; the most recent messages are placed at the top of the list. Messages that have occurred since you last visited the system messages tab are marked with an asterisk '\*'.  
 \*

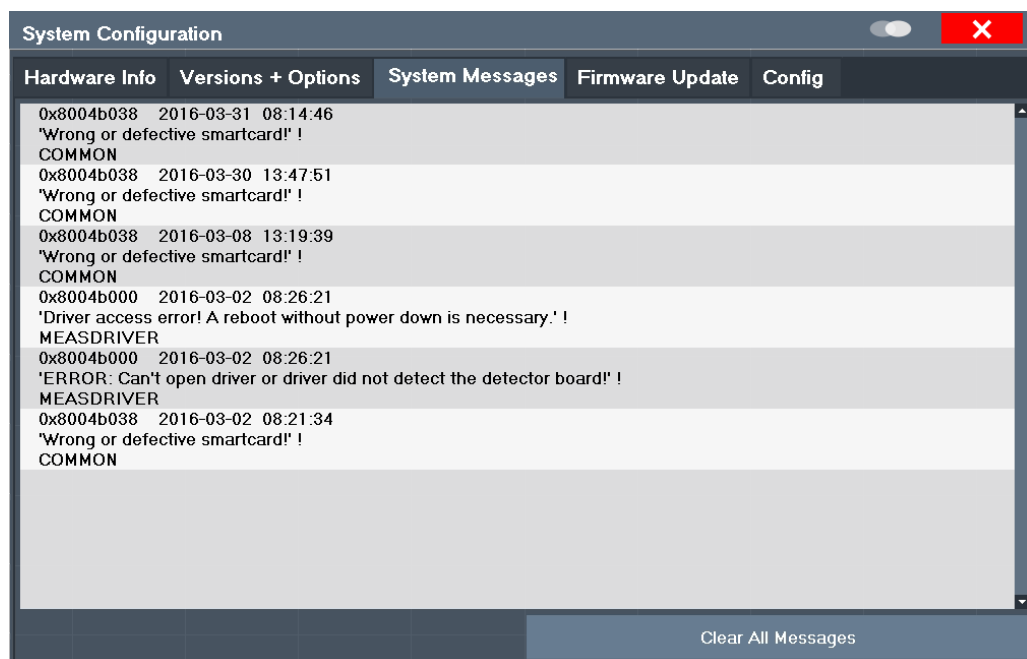

If the number of error messages exceeds the capacity of the error buffer, "Message Buffer Overflow" is displayed. To clear the message buffer, use "Clear All Messages".

The following information is available:

No	device-specific error code
Message	brief description of the message
Component	hardware messages: name of the affected module
	software messages: name of the affected software
Date/Time	date and time of the occurrence of the message

**Remote command:**

[SYSTem:ERRor:LIST?](#) on page 1449

### 11.7.4 Firmware updates

**Access:** [Setup] > "System Configuration" > "Firmware Update"

During instrument start, the FSW checks the installed hardware against the current firmware version to ensure that the hardware is supported. If not, an error message is displayed ("Wrong Firmware Version") and you are asked to update the firmware. Until the firmware version is updated, self-alignment fails. To see which components are not supported, see the [System messages](#).

Possibly, you also have to update the firmware on your FSW to enable additional new features or if reasons for improvement come up. Ask your sales representative or check the Rohde & Schwarz website for availability of firmware updates. A firmware update package includes at least a setup file and release notes.



Before updating the firmware on your instrument, read the release notes delivered with the firmware version.

Administrator rights are no longer required to perform a firmware update.



#### Installing options in secure user mode

Be sure to perform any firmware updates before [SecureUser Mode](#) is enabled; see [Chapter 4.2.15, "Protecting data using the secure user mode"](#), on page 39.

For restricted users in secure user mode, this function is not available.

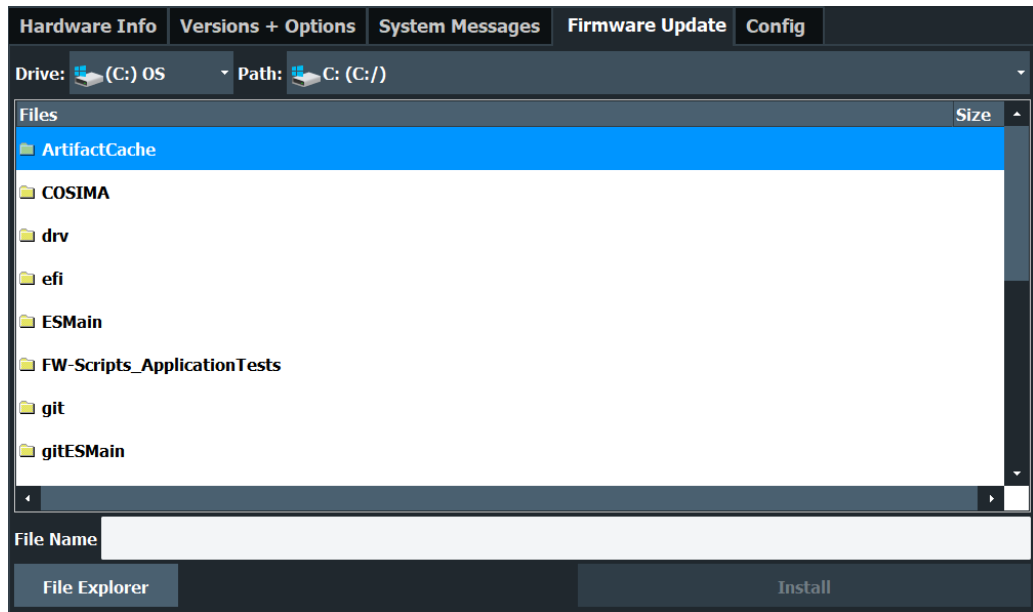

For detailed instructions on installing the firmware, see the product release notes.

**Remote command:**

`SYSTEM:FIRMWARE:UPDATE` on page 1450

### 11.7.5 General configuration settings

**Access:** [Setup] > "System Configuration" > "Config"

General system settings, for example concerning the initial behavior of the FSW after booting, can also be configured.

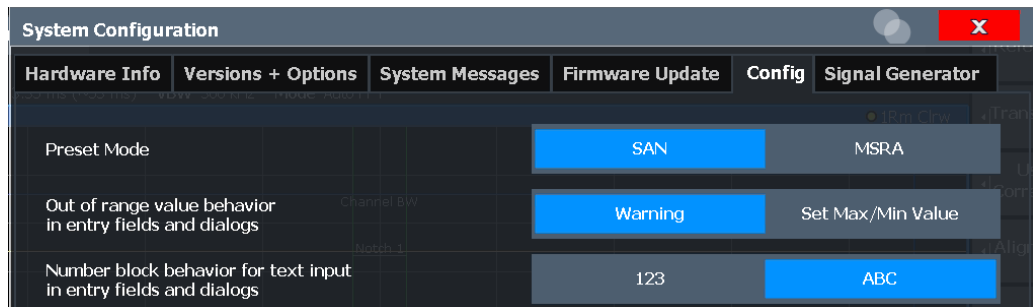

[Preset Mode](#)..... 791

[Out-of-range value behavior](#)..... 792

[SecureUser Mode](#)..... 792

    ↳ [Changing the password](#)..... 792

[Number block behavior](#)..... 793

**Preset Mode**

The presettings can be defined in the "Config" tab of the "System Configuration" dialog box.

"SAN"	Signal and Spectrum Analyzer mode
"MSRA"	Multi-Standard Radio Analysis mode
"MSRT"	Multi-Standard Real-Time mode

Remote command:

[SYSTem:PRESet:COMPAtible](#) on page 1453

### Out-of-range value behavior

By default, if you enter a value that is outside the valid range in an input field for a setting, a warning is displayed and the value is not accepted. Alternatively, entries below the minimum value can automatically be set to the minimum entry, and entries above the maximum value set to the maximum entry. This behavior avoids errors and facilitates setting correct values.

### SecureUser Mode

If activated, the FSW requires a reboot and then automatically logs in using the "SecureUser" account.

Data that the FSW normally stores on the solid-state drive is redirected to volatile memory instead. Data that is stored in volatile memory can be accessed by the user during the current instrument session. However, when the instrument's power is removed, all data in volatile memory is erased.

The Secure User Mode can only be activated or deactivated by a user with administrator rights.

**Note:** Storing instrument settings permanently. Before you activate secure user mode, store any instrument settings that are required beyond the current session, such as predefined instrument settings, transducer files, or self-alignment data.

For details on the secure user mode, see [Chapter 4.2.15, "Protecting data using the secure user mode"](#), on page 39.

Remote command:

[SYSTem:SECurity\[:STATe\]](#) on page 1453

**Note:** Initially after installation of the R&S FSW-K33 option, secure user mode must be enabled manually once before remote control is possible.

### Changing the password ← SecureUser Mode

When the secure user mode is activated the first time after installation, you are prompted to change the passwords for all user accounts to improve system security.





To save the new password, select "Save". The password dialog for the next user is displayed, until you have been prompted to change the password all user accounts.

If you cancel the dialog without changing the password, the password dialog for the next user is displayed, until you have been prompted to change the password for all user accounts. It is possible to continue in secure user mode without changing the passwords, and you will not be prompted to do so again. However, we strongly recommend that you do define a more secure password for all users.

By default, the password characters are not displayed to ensure confidentiality during input. To display the characters, select "Show password".

To display the onscreen keyboard, select "Keyboard".

#### Number block behavior

Defines the default behavior of the keypad on the front panel of the FSW for **text** input. Depending on the type of values you most frequently enter using the keypad, a different default is useful.

"123"	Numeric values are entered when you press a key on the keypad. To enter alphanumeric values, use an external or the on-screen keyboard, or switch this setting.
"ABC"	(Default) Every key on the keypad represents several characters and one number. If you press the key multiple times in quick succession, you toggle through the symbols assigned to the key. For the assignment, refer to <a href="#">Table 4-12</a> .

### 11.7.6 Signal generator settings

**Access:** [Setup] > "System Configuration" > "Signal Generator"

These settings configure a connected signal generator that can then be used for various tasks, for example for external generator control or NPR measurements.

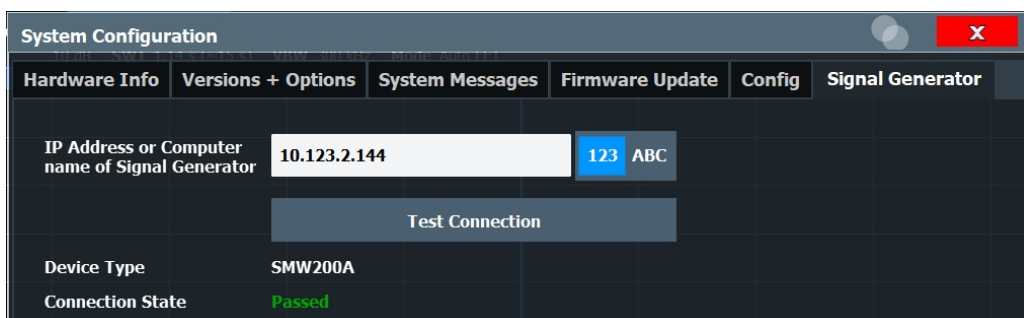

IP Address or Computer name of Signal Generator..... 794

    L 123/ABC.....794

    L Password..... 794

Test Connection..... 794

Connect/Disconnect..... 795

**IP Address or Computer name of Signal Generator**

The IP address or computer name of the signal generator connected to the FSW via LAN.

For tips on how to determine the default computer name, see [Chapter 4.3.2.21, "Device ID"](#), on page 61, or the signal generator's user documentation.

By default, the IP address is expected. To enter the computer name, toggle the "123"/"ABC" button to "ABC".

**Note:** While a connection to a signal generator is established, you cannot change the connection information.

The IP address / computer name is maintained after a [PRESET], and is transferred between applications. However, when you switch applications, the control is disabled in the other applications. Only one application can control a generator at any time.

Select ["Test Connection"](#) on page 794 to establish a temporary connection from the FSW to the specified signal generator.

If a connection to a signal generator is already configured, the connection data is provided for information only.

Remote command:

[CONFigure:GENerator:IPConnection:ADDRESS](#) on page 1455

**123/ABC ← IP Address or Computer name of Signal Generator**

By default, the TCPIP address is expected. To enter the computer name, toggle the "123"/"ABC" button to "ABC".

**Password ← IP Address or Computer name of Signal Generator**

Enter the password required to operate the connected signal generator.

**Test Connection**

The FSW attempts to establish a connection to the signal generator.

If an instrument is connected, the following information is displayed:

- Device type
- Name and serial number
- Connection state

Remote command:

[CONFigure:GENerator:CONNECTION:CState?](#) on page 1454

[CONFigure:GENerator:CONNECTION\[:State\]](#) on page 1454

### Connect/Disconnect

The FSW attempts to establish a connection to the signal generator, or disconnects it.

If an instrument is connected, the following information is displayed:

- Device type
- Name and serial number
- Connection state

Remote command:

[CONFigure:GENerator:CONNECTION\[:State\]](#) on page 1454

[CONFigure:GENerator:CONNECTION:CState?](#) on page 1454

## 11.7.7 AC power loss behavior

**Access:** BIOS

Using a specific configuration setting in the BIOS of the FSW, you can define how the instrument behaves after the AC power supply is interrupted. The setting applies regardless whether the interruption occurs due to an irregular power outage in the mains supply, by removing the power cable, or by switching the instrument power supply off.

The setting supports the following values:

- "Power Off": Instrument remains switched off.
- "Power On": Instrument automatically switches on as soon as power supply is restored.
- "Last State": (Default) Instrument restores the state that it was in before the outage occurred.

### To change the instrument's power loss behavior

Prerequisite: the instrument is switched off and a keyboard is connected.

1. Switch on the power switch on the rear panel of the FSW.
2. Watch for the prompt on the display, then press [DEL] on the keyboard to enter the BIOS setup.
3. In the BIOS menu, select "Chipset" > "PCH-IO Configuration" > "Restore AC Power Loss".
4. Select the required setting as described above.
5. In the BIOS menu, select "Save & Exit" > "Save Changes and Exit".

## 11.8 Service functions

**Access:** [Setup] > "Service"

When unexpected problems arise with the FSW some service functions may help you solve them.

For more helpful information for support, see also [Chapter 14.6, "Collecting information for support"](#), on page 1550

- [R&S support information](#).....796
- [Self-test settings and results](#).....797
- [Calibration signal display](#).....798
- [Service functions](#).....800
- [Hardware diagnostics](#).....802

### 11.8.1 R&S support information

**Access:** [Setup] > "Service" > "R&S Support"

In case of errors you can store useful information for troubleshooting and send it to your Rohde & Schwarz support center.

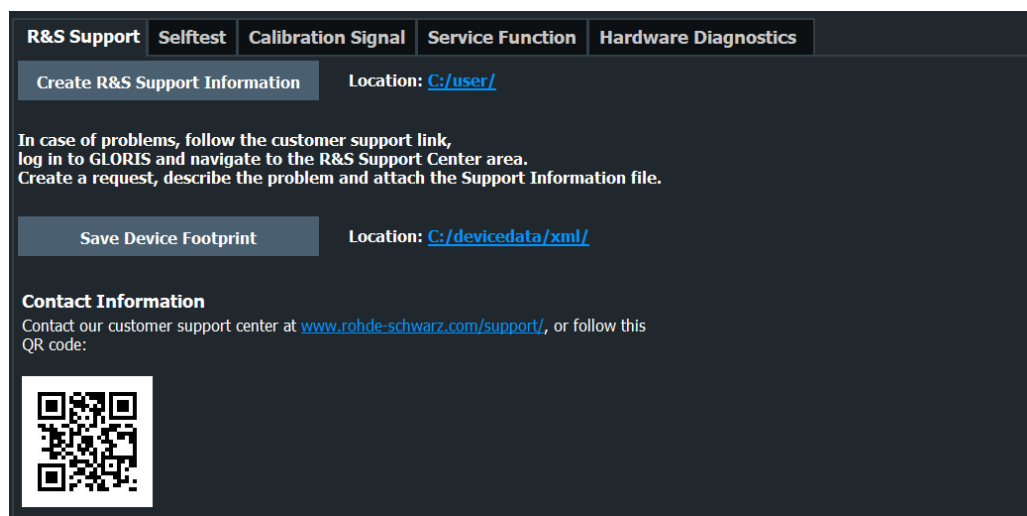

- [Create R&S Support Information](#).....796
- [Save Device Footprint](#).....797
- [Last Service Date](#).....797
- [Last Calibration Date](#).....797
- [Next Calibration Due](#).....797

#### Create R&S Support Information

Creates a \*.zip file with important support information. The \*.zip file contains the system configuration information ("Device Footprint"), the current eeprom data and a screenshot of the screen display.

This data is stored to the C:\R\_S\INSTR\USER directory on the instrument.

The file name consists of the unique device ID and the current date and time of the file creation.

If you contact the Rohde & Schwarz support to get help for a certain problem, send these files to the support in order to identify and solve the problem faster.

Remote command:

[DIAGnostic:SERvice:SINfo?](#) on page 1457

### Save Device Footprint

Creates an \*.xml file with information on installed hardware, software, image and FPGA versions. The \*.xml file is stored under

C:\Program Files (x86)\Rohde-Schwarz\FSW\<version>\devicedata\xml\ on the instrument. It is also included in the service ZIP file (see "[Create R&S Support Information](#)" on page 796).

Remote command:

[SYSTEM:DFPrint](#) on page 1448

### Last Service Date

Opens a calendar to define the date that the FSW was inspected by Rohde & Schwarz service. The service date is updated by the service technicians. For new instruments, the last service date (= date of production) is entered during production.

If the field contains no date, we recommend that you enter the date of last service according to the service certificates you received after the FSW has been serviced.

If the FSW has not been serviced yet, leave the field empty.

Remote command:

[DIAGnostic:SERvice:DATE](#) on page 1446

### Last Calibration Date

Opens a calendar to define the date that the FSW was calibrated. For new instruments, we recommend to enter the factory calibration date specified on the calibration certificate.

Remote command:

[DIAGnostic:SERvice:CALibration:DATE](#) on page 1445

### Next Calibration Due

Opens a calendar to define the date that the FSW needs its next calibration. The recommended calibration interval is specified in a read only field next to this input field.

This date must always be configured by the customer due to ISO17025.

Remote command:

Set date: [DIAGnostic:SERvice:CALibration:DUE:DATE](#) on page 1445

Recommended interval: [DIAGnostic:SERvice:CALibration:INTERval?](#) on page 1445

## 11.8.2 Self-test settings and results

**Access:** [Setup] > "Service" > "Selftest"

If the FSW fails you can perform a self-test of the instrument to identify any defective modules.



Once the self-test is started, all modules are checked consecutively and the test result is displayed. You can abort a running test.

In case of failure a short description of the failed test, the defective module, the associated value range and the corresponding test results are indicated.



A running Sequencer process is aborted when you start a self-test.

If you start a self-test remotely, then select "Local" while the test is still running, the instrument only returns to the manual operation state after the test is completed. In this case, the self-test cannot be aborted.

**Remote command:**

[\\*TST?](#) on page 896

[DIAGnostic:SERVice:STESt:RESult?](#) on page 1401

### 11.8.3 Calibration signal display

**Access:** [Setup] > "Service" > "Calibration Signal"

As an alternative to the RF input signal from the front panel connector, you can use the instrument's calibration signal as the input signal, for example to perform service functions on.

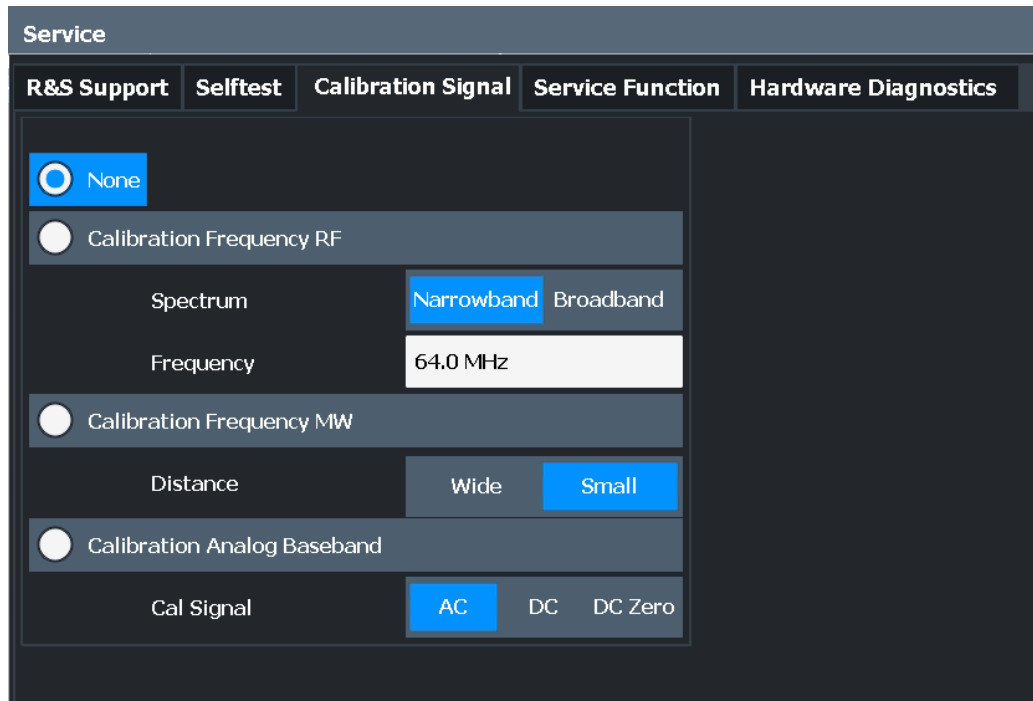

NONE..... 799

Calibration Frequency RF..... 799

    L Spectrum..... 799

    L Frequency..... 800

Calibration Frequency MW..... 800

Calibration Analog Baseband..... 800

    L Calibration Signal Type..... 800

**NONE**

Uses the current RF signal at the input, i.e. no calibration signal (default).

Remote command:

[DIAGnostic:SERVice:INPut\[:SElect\]](#) on page 1401

**Calibration Frequency RF**

Uses the internal calibration signal as the RF input signal.

Remote command:

[DIAGnostic:SERVice:INPut\[:SElect\]](#) on page 1401

[DIAGnostic:SERVice:INPut:PULSed:CFrequency](#) on page 1399

**Spectrum ← Calibration Frequency RF**

Defines whether a broadband or narrowband calibration signal is sent to the RF input.

"Narrowband" Used to calibrate the absolute level of the frontend at 64 MHz.

"Broadband" Used to calibrate the IF filter.

Remote command:

[DIAGnostic:SERVice:INPut:RF\[:SPECTrum\]](#) on page 1400

**Frequency ← Calibration Frequency RF**

Defines the frequency of the internal broadband calibration signal to be used for IF filter calibration (max. 64 MHz).

For narrowband signals, 64 MHz is sent.

**Calibration Frequency MW**

Uses the microwave calibration signal as the RF input (for frequencies higher than 8 GHz). This function is used to calibrate the YIG-filter on the microwave converter. The microwave calibration signal is pulsed.

You can define whether the distance between input pulses is small or wide.

**Note:** For FSW85 models, you can use a microwave calibration signal with a spectrum of 43.5 GHz, or a wideband signal that covers the complete 85 GHz bandwidth. You can define the frequency of the microwave calibration signal. The firmware adapts the defined value to the next possible valid value.



Remote command:

[DIAGnostic:SERVice:INPut\[:SElect\]](#) on page 1401

[DIAGnostic:SERVice:INPut:MC\[:DISTance\]](#) on page 1398

[DIAGnostic:SERVice:INPut:MC:CFrequency](#) on page 1398

[DIAGnostic:SERVice:INPut:MC:RANGe](#) on page 1399

**Calibration Analog Baseband**

Uses an internal calibration signal as input to the optional "Analog Baseband" interface. This signal is only available if the interface option is installed.

For more information on the Analog Baseband Interface, see the FSW I/Q Analyzer and I/Q Input User Manual.

Remote command:

[DIAGnostic:SERVice:INPut\[:SElect\]](#) on page 1401

**Calibration Signal Type ← Calibration Analog Baseband**

Defines the type of calibration signal to be used for the optional "Analog Baseband" interface.

"AC"                    1.5625 MHz square wave AC signal

"DC"                    DC signal

"DC zero"              no signal

Remote command:

[DIAGnostic:SERVice:INPut:AIQ\[:TYPE\]](#) on page 1400

**11.8.4 Service functions**

**Access:** [Setup] > "Service" > "Service Function"



**NOTICE**

**Using service functions**

The service functions are not necessary for normal measurement operation. Incorrect use can affect correct operation and/or data integrity of the FSW.

Therefore, only user accounts with administrator rights can use service functions and many of the functions can only be used after entering a password. These functions are described in the instrument service manual.

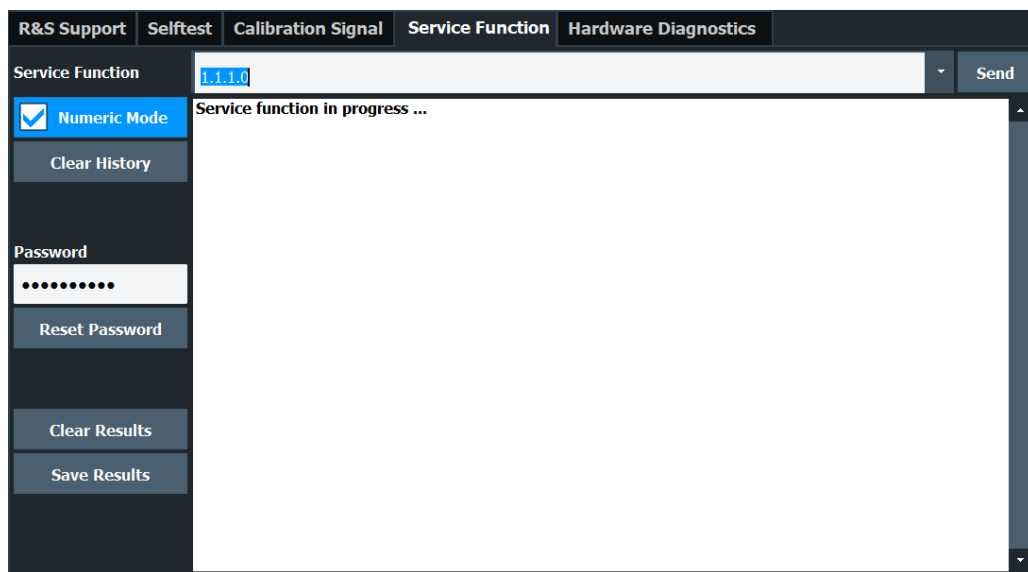

Service Function..... 801  
 Send.....801  
 Numeric Mode.....802  
 Clear History..... 802  
 Password..... 802  
 Clear Results.....802  
 Save Results.....802  
 Result List..... 802

**Service Function**

Selects the service function by its numeric code or textual name.

The selection list includes all functions previously selected (since the last "Clear History" action).

Remote command:

`DIAGnostic:SERvice:SFUNction` on page 1455

**Send**

Starts the selected service function.

Remote command:

`DIAGnostic:SERvice:SFUNction` on page 1455

**Numeric Mode**

If activated, the service function is selected by its numeric code. Otherwise, the function is selected by its textual name.

**Clear History**

Deletes the list of previously selected service functions.

**Password**

Most service functions require a special password as they may disrupt normal operation of the FSW. There are different levels of service functions, depending on how restrictive their use is handled. Each service level has a different password.

"Reset Password" clears any previously entered password and returns to the most restrictive service level.

Remote command:

[SYSTem:PASSword\[:CENable\]](#) on page 1457

[SYSTem:PASSword:RESet](#) on page 1458

**Clear Results**

Clears the result display for all previously performed service functions.

Remote command:

[DIAGnostic:SERvice:SFUNction:RESults:DELeTe](#) on page 1456

**Save Results**

Saves the results of all previously performed service functions to a file stored as C:\R\_S\INSTR\results\ServiceLog.txt.

Remote command:

[DIAGnostic:SERvice:SFUNction:RESults:SAVE](#) on page 1456

**Result List**

The Results List indicates the status and results of the executed service functions.

## 11.8.5 Hardware diagnostics

In case problems occur with the instrument hardware, some diagnostic tools provide information that may support troubleshooting.

The hardware diagnostics tools are available in the "Hardware Diagnostics" tab of the "Service" dialog box.

Service	
R&S Support	Selftest
Relays Cycle Counter	
Type	Counter
Mechanical Attenuation 5 dB	2
Mechanical Attenuation 10 dB	0
Mechanical Attenuation 20 dB	2
Mechanical Attenuation 40 dB	2
Calibration Source	2
AC/DC-Coupling	0
Electronic Attenuation	0
Preamplifier	0

[Relays Cycle Counter](#)..... 803

**Relays Cycle Counter**

The hardware relays built into the FSW may fail after a large number of switching cycles (see specifications document). The counter indicates how many switching cycles the individual relays have performed since they were installed.

Remote command:

[DIAGnostic:INFO:CCOunt?](#) on page 1444

## 11.9 Synchronizing measurement channel configuration

**Access:** [SETUP] > "Parameter Coupling"

Each of the applications of the FSW is usually treated as an independent entity regarding their configuration: changing a setting in one measurement channel does not automatically change the corresponding setting in another channel.

For example, changing the frequency in the spectrum application does not, by default, change the frequency in the vector signal analysis (VSA) application.

However, sharing settings can be convenient for certain measurement tasks. The FSW provides a tool to couple (or synchronize) selected parameters across applications - the coupling manager.

The coupling managers allows you not only to couple parameters, but also markers and lines accross applications.

- [General parameter coupling](#).....804
- [User-defined parameter coupling](#).....806
- [Generator coupling](#).....810
- [How to synchronize parameters](#).....812
- [Example for a user-defined parameter coupling](#)..... 814

### 11.9.1 General parameter coupling

**Access:** [SETUP] > "Parameter Coupling" > "General"

The "General" tab of the coupling manager contains several parameters that you can couple across all (active) measurement channels - if the channel supports the corresponding parameter.

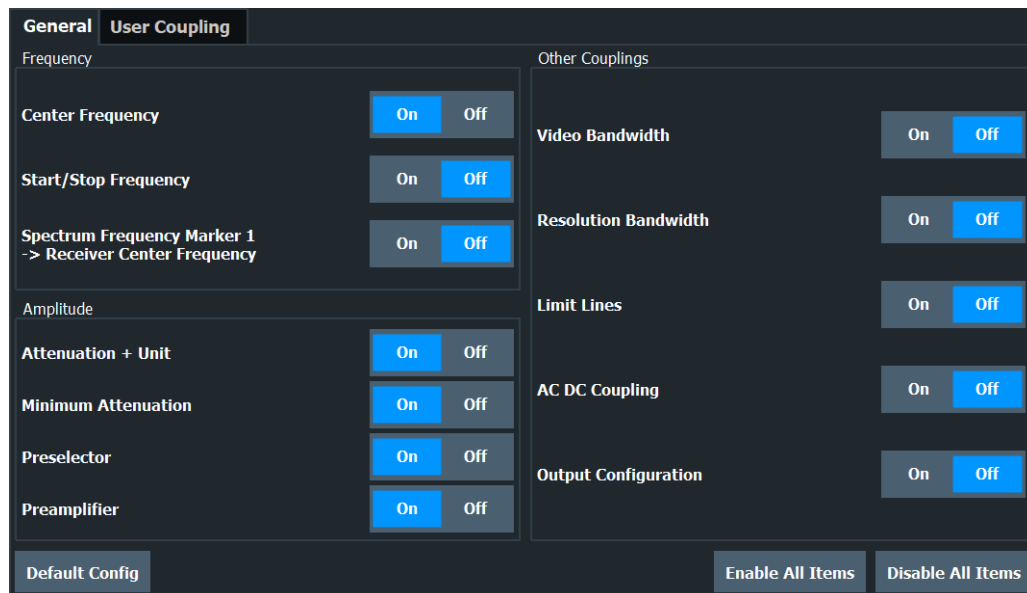

When you couple a parameter across all active measurement channels, a change in the currently selected application is passed on to all other active measurement channels.



In MSRA mode, the data is captured by the MSRA primary only. Thus, parameter coupling is not available for data acquisition parameters. However, it can be useful to couple time or frequency markers between applications. Thus, you can easily determine effects that occur at the same time or frequency in different measurement views.

Note that the accuracy of time marker couplings is  $\pm 1$  sample.

<a href="#">Synchronizing parameters across all measurement channels.....</a>	804
<a href="#">Selecting all or no coupling mechanisms.....</a>	806
<a href="#">Restoring the default configuration.....</a>	806

#### Synchronizing parameters across all measurement channels

To synchronize a specific parameter, turn on the corresponding function.

Note that you cannot synchronize all parameters at the same time, because some parameters are interdependent. For example, you cannot synchronize the resolution and video bandwidth simultaneously, because the video bandwidth depends on the resolution bandwidth and vice versa.

## Synchronizing measurement channel configuration

- "Center Frequency"  
Synchronizes the center frequency  
Remote command:  
[INSTRument:COUPle:CENTer](#) on page 1460
- "Start / Stop Frequency"  
Synchronizes the start and stop frequencies for measurements in the frequency domain  
**Note:** The start and stop frequencies can automatically change when you change another frequency parameter (such as center frequency or span).  
Remote command:  
[INSTRument:COUPle:SPAN](#) on page 1463
- "Reference Level"  
Synchronizes the reference level  
Remote command:  
[INSTRument:COUPle:RLEVel](#) on page 1463
- "Attenuation"  
Synchronizes the attenuation  
Remote command:  
[INSTRument:COUPle:ATTen](#) on page 1459
- "Preamplifier"  
Synchronizes the gain of the optional preamplifier  
Remote command:  
[INSTRument:COUPle:GAIN](#) on page 1461
- "Amplitude Unit"  
Synchronizes the unit of the level axis  
Remote command:  
[INSTRument:COUPle:AUNit](#) on page 1459
- "Video Bandwidth"  
Synchronizes the video bandwidth  
**Note:** You cannot synchronize the video bandwidth and the resolution bandwidth is not possible.  
Remote command:  
[INSTRument:COUPle:VBW](#) on page 1464
- "Resolution Bandwidth"  
Synchronizes the measurement bandwidth  
**Note:** You cannot synchronize the video bandwidth and the resolution bandwidth simultaneously.  
Remote command:  
[INSTRument:COUPle:BANDwidth](#) on page 1460

**"Limit Lines"**

Activates the limit line over all channels

**Note:** Limit lines are only synchronized over channels if the limit line is compatible to the channel configuration (especially units of the x- and y-axis).

Remote command:

[INSTRument:COUPle:LIMit](#) on page 1462

**"AC DC Coupling"**

Synchronizes the [Input Coupling](#)

Remote command:

[INSTRument:COUPle:ACDC](#) on page 1459

**"Impedance"**

Synchronizes the impedance for RF input

Remote command:

[INSTRument:COUPle:IMPedance](#) on page 1461

**"Analog Baseband Impedance"**

Synchronizes the impedance for analog baseband input

Remote command:

[INSTRument:COUPle:ABIMPedance](#) on page 1458

**Selecting all or no coupling mechanisms**

Select all items available in the general coupling manager using "Enable All Items".

Note that you cannot actually select all items, because some of them are mutually exclusive.

Deselect all items available in the coupling manager using "Disable All Items".

Remote command:

not supported

**Restoring the default configuration**

You can restore the default parameter coupling configuration any time with "Default Config".

Remote command:

not supported

**11.9.2 User-defined parameter coupling**

**Access:** [SETUP] > "Parameter Coupling" > "User Coupling"

User couplings allow you to synchronize user-defined parameters, as well as markers and lines, between measurement channels.

Compared to the predefined couplings, user couplings do not necessarily have to synchronize all active measurement channels. Instead you can define specific channels that are synchronized with each other, in any combination, while other channels remain independent.

**Example:**

You currently run two instances of the Spectrum application, two instances of the VSA application, and one instance of the AM/FM/PM Analog Demod application.

You can synchronize only the first instance of the Spectrum application with the first instance of the VSA application, while the other three channels remain independent.

Alternatively, you can synchronize all instances of the VSA application, while the Spectrum and AM/FM/PM Analog Demod applications remain independent.

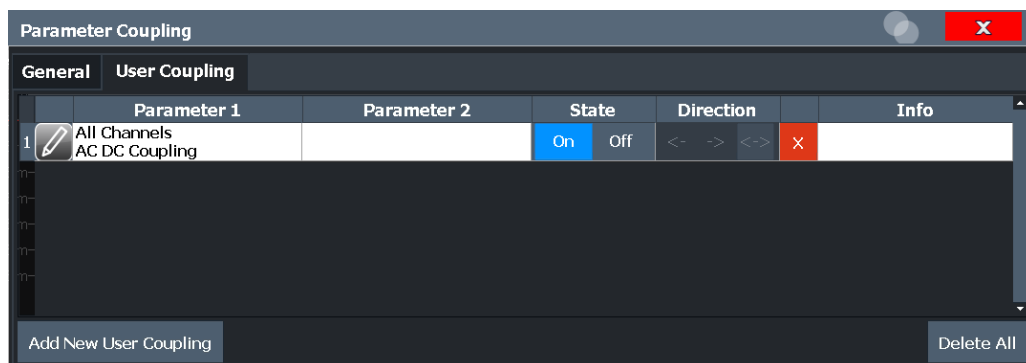

Any existing user-defined couplings are displayed in the dialog box.

- Index..... 807
- Edit coupling definition..... 807
- Parameter 1 / Parameter 2.....808
- State.....808
- Direction.....808
- Delete coupling definition.....808
- Info.....808
- Delete All.....808
- Add New User Coupling.....808
  - L Category.....809
  - L Channel 1 / Channel 2.....809
  - L Specifics for Window.....809
  - L Coupling Element 1 / Coupling Element 2.....809
  - L Couple Selected Parameters.....810

**Index**

Index of the user-defined parameter coupling, used to identify the definition in remote operation.

Remote command:

[INSTrument:COUPlE:USER<uc>:NUMBers:LIST?](#) on page 1470



**Edit coupling definition**

Opens a dialog box to edit the selected coupling. See ["Add New User Coupling"](#) on page 808.

Remote command:

[INSTrument:COUPlE:USER<uc>](#) on page 1464

**Parameter 1 / Parameter 2**

The coupled parameters, markers, or lines.

Remote command:

[INSTrument:COUPle:USER<uc>:NEW?](#) on page 1468

**State**

Enables or disables the coupling.

Remote command:

[INSTrument:COUPle:USER<uc>:STATe](#) on page 1471

**Direction**

Determines which parameter controls the other.

"<-" Parameter 2 controls parameter 1. If parameter 2 is changed, parameter 1 is adapted. If parameter 1 is changed, parameter 2 remains unchanged.

Remote command:

[INST:COUP:USER:REL RTOL](#)

"->" Parameter 1 controls parameter 2. If parameter 1 is changed, parameter 2 is adapted. If parameter 2 is changed, parameter 1 remains unchanged.

Remote command:

[INST:COUP:USER:REL LTOR](#)

"<->" Both parameters are equal. If one parameter is changed, the other parameter is adapted and vice versa.

Remote command:

[INST:COUP:USER:REL BID](#)

**Delete coupling definition**

Deletes the selected coupling definition permanently.

Remote command:

[INSTrument:COUPle:USER<uc>:REMOve](#) on page 1471

**Info**

Shows information for the selected coupling, for example, restrictions regarding the coupling.

Note that usually, no information is displayed.

Remote command:

[INSTrument:COUPle:USER<uc>:INFO](#) on page 1467

**Delete All**

Deletes all current coupling definitions. Parameters are no longer coupled.

Remote command:

[INSTrument:COUPle:USER<uc>:REMOve](#) on page 1471

**Add New User Coupling**

Opens a dialog box to create a new user-defined coupling definition.



## Synchronizing measurement channel configuration

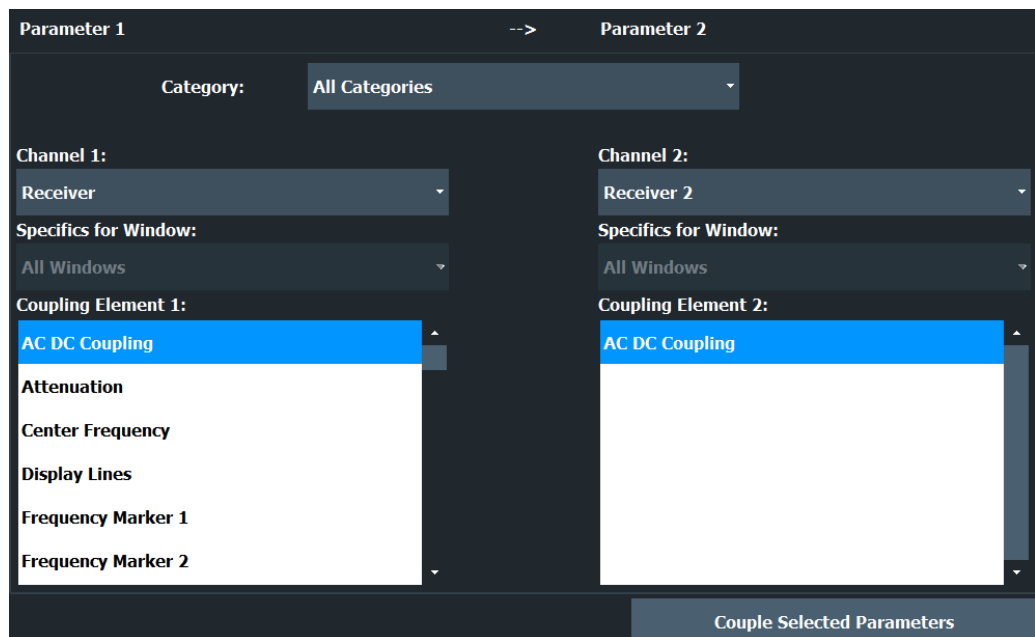

Remote command:

[INSTrument:COUPlE:USER<uc>:NEW?](#) on page 1468

#### Category ← Add New User Coupling

Selects the category of parameters to be displayed in the [Coupling Element 1 / Coupling Element 2](#) selection list.

#### Channel 1 / Channel 2 ← Add New User Coupling

Selects the channels for which the parameters are coupled. Only active channels are available for selection. If no other active measurement channels have the selected parameter, "Channel 2" is not available.

The following selections are possible:

- Individual channels
- All channels of the same type
- All channels

Remote command:

[INSTrument:COUPlE:USER<uc>:CHANnel:LIST?](#) on page 1466

#### Specifics for Window ← Add New User Coupling

Selects the windows of the selected channel for which the parameters are coupled. This setting is only available for AM/FM/PM Analog Demod channels. Individual windows can only be coupled for frequency markers.

Remote command:

[INSTrument:COUPlE:USER<uc>:WINDow:LIST?](#) on page 1472

#### Coupling Element 1 / Coupling Element 2 ← Add New User Coupling

Defines the parameter or marker to be coupled. All available elements in the selected applications are displayed. If no other active measurement channels have the selected "Coupling Element 1", "Coupling Element 2" is not available.

Remote command:

`INSTrument:COUPle:USER<uc>:ELEMeNt:LIST?` on page 1466

**Couple Selected Parameters ← Add New User Coupling**

Closes the dialog box and adds the new user-defined coupling definition to the list.

**11.9.3 Generator coupling**

You cannot only couple parameters between FSW applications, but also between the FSW and a connected signal generator. Coupling parameters is especially useful when you use the SCPI recorder and need to include generator commands (see "[Combined Recording of Spectrum Analyzer and R&S Signal Generator](#)" on page 847).

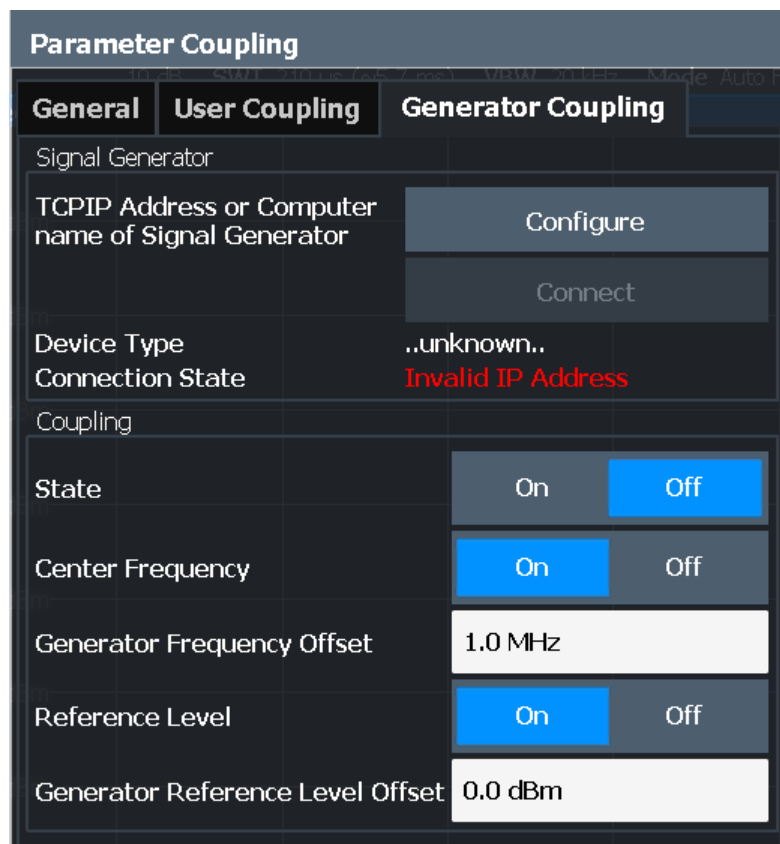

IP Address or Computer name of Signal Generator..... 811

- L 123/ABC..... 811
- L Password..... 811

Connect/Disconnect..... 811

Coupling State..... 811

Center Frequency..... 811

Generator Frequency Offset..... 812

Reference level..... 812

Generator Reference Level Offset..... 812

**IP Address or Computer name of Signal Generator**

The IP address or computer name of the signal generator connected to the FSW via LAN.

For tips on how to determine the default computer name, see [Chapter 4.3.2.21, "Device ID"](#), on page 61, or the signal generator's user documentation.

By default, the IP address is expected. To enter the computer name, toggle the "123"/"ABC" button to "ABC".

**Note:** While a connection to a signal generator is established, you cannot change the connection information.

The IP address / computer name is maintained after a [PRESET], and is transferred between applications. However, when you switch applications, the control is disabled in the other applications. Only one application can control a generator at any time.

Select **"Test Connection"** on page 794 to establish a temporary connection from the FSW to the specified signal generator.

If a connection to a signal generator is already configured, the connection data is provided for information only.

Remote command:

[CONFigure:GENerator:IPConnection:ADDRESS](#) on page 1455

**123/ABC ← IP Address or Computer name of Signal Generator**

By default, the TCPIP address is expected. To enter the computer name, toggle the "123"/"ABC" button to "ABC".

**Password ← IP Address or Computer name of Signal Generator**

Enter the password required to operate the connected signal generator.

**Connect/Disconnect**

The FSW attempts to establish a connection to the signal generator, or disconnects it.

If an instrument is connected, the following information is displayed:

- Device type
- Name and serial number
- Connection state

Remote command:

[CONFigure:GENerator:CONNECTION\[:STATE\]](#) on page 1454

[CONFigure:GENerator:CONNECTION:CSTATE?](#) on page 1454

**Coupling State**

Enables or disables coupling between the FSW and a connected signal generator.

Note that only one channel can control a generator at any time. If a measurement channel already has control of the connected generator and you enable parameter coupling, the control is disabled in the other channel.

Remote command:

[INSTrument:COUple:GENerator:STATE](#) on page 1474

**Center Frequency**

Couples the center frequency of the connected signal generator to the FSW.

This setting requires the [Coupling State](#) to be enabled.

Remote command:

`INSTRument:COUPlE:GENerator:CENTer[:STATe]` on page 1473

#### Generator Frequency Offset

Defines a fixed offset to the center frequency of the FSW for the coupled signal generator.

This setting requires the [Coupling State](#) to be enabled.

Remote command:

`INSTRument:COUPlE:GENerator:CENTer:OFFSet` on page 1473

#### Reference level

Couples the reference level of the connected signal generator to the FSW.

This setting requires the [Coupling State](#) to be enabled.

Remote command:

`INSTRument:COUPlE:GENerator:RLEVel[:STATe]` on page 1474

#### Generator Reference Level Offset

Defines a fixed offset to the reference level of the FSW for the coupled signal generator.

This setting requires the [Coupling State](#) to be enabled.

Remote command:

`INSTRument:COUPlE:GENerator:RLEVel:OFFSet` on page 1473

### 11.9.4 How to synchronize parameters

**Access:** [SETUP] > "Parameter Coupling"

User-defined couplings allow you to couple parameters other than those available in the "General" tab of the coupling manager. Thus, you can create highly customized couplings between measurement channels.

Compared to the predefined couplings, user couplings do not necessarily have to synchronize all active measurement channels. Instead you can define specific channels that are synchronized with each other, in any combination, while other channels remain independent.

#### How to use predefined parameter couplings

1. Select [SETUP].
2. Select "Parameter Coupling".
3. In the "General" tab, set the parameter you want to synchronize over all measurement channels to "On".
4. Close the dialog box.



**How to create user-defined parameter couplings**

1. Select [SETUP].
2. Select "Parameter Coupling".
3. Select the "User Coupling" tab.
4. Select "Add New User Coupling".
5. From the "Channel 1" list, select the channels or type of channel to couple.
6. From the "Coupling Element 1" list, select the parameter or marker to couple for the selected measurement channels.  
To shorten the list and restrict it to a certain type of parameters, select a "Category" first.
7. For AM/FM/PM Analog Demod channels and frequency markers only, select the individual windows (in the frequency domain) to couple.
8. To couple specific channels rather than all channels of a type:
  - a) Select the second channel for coupling from the "Channel 2" list
  - b) Select the parameter to which the first parameter is coupled from the "Coupling Element 2" list.
  - c) For AM/FM/PM Analog Demod channels and frequency markers only, select the individual windows (in the frequency domain) from the second AM/FM/PM Analog Demod channel to couple.
9. Select "Couple Selected Parameters".  
The "Add New User Coupling" dialog box is closed, and the new user-defined coupling is added to the list in the "Parameter Coupling" dialog box.
10. If specific channels are coupled, select the "Direction" to define which channel controls the other, that is: in which channel the parameter is adapted if the other is changed.



11. Close the dialog box.



From now on, if you change a coupled parameter in one channel, the parameter in the coupled channel or channels is set to the same value.

**How to edit user-defined parameter couplings**

1. Select [SETUP].
2. Select "Parameter Coupling".
3. Select the "User Coupling" tab.
4. Select the "Edit" icon for the parameter coupling you want to edit.
5. Continue as described in [How to create user-defined parameter couplings, step 5](#).

**How to deactivate user-defined parameter couplings**

1. Select [SETUP].

2. Select "Parameter Coupling".
3. Select the "User Coupling" tab.
-  4. To deactivate the coupling temporarily, without deleting the coupling definition entirely, set the "State" of the coupling to "Off".  
To delete the coupling permanently, select the "Delete" icon for the parameter coupling you want to remove.
-  5. Close the dialog box.

### 11.9.5 Example for a user-defined parameter coupling

Currently two Spectrum application channels are active, one I/Q analyzer channel, and two AM/FM/PM Analog Demod channels.

#### Synchronizing all Spectrum channels

The following example demonstrates how to synchronize the center frequency in all Spectrum application channels, while the I/Q analyzer and AM/FM/PM Analog Demod applications remain independent.

1. Select [SETUP].
2. Select "Parameter Coupling".
3. Select the "User Coupling" tab.
4. Select "Add New User Coupling".
5. From the "Channel 1" list, select "All Spectrum".
6. From the "Coupling Element 1" list, select "Center Frequency".
7. Select "Couple Selected Parameters".
8. Close the "Parameter Coupling" dialog box.
9. In the first Spectrum channel, change the "Center Frequency" to 1 GHz.
10. Switch to the second Spectrum channel.

The center frequency in the second Spectrum channel is also set to 1 GHz.

#### Synchronizing specific channels

The following example demonstrates how to synchronize the attenuation only for the first Spectrum channel and the first AM/FM/PM Analog Demod channel, while the other three channels remain independent.

1. Select "Add New User Coupling".
2. From the "Channel 1" list, select "Spectrum 1".
3. From the "Coupling Element 1" list, select "Attenuation".

## Synchronizing measurement channel configuration

4. From the "Channel 2" list, select "AnaDemod 1".
5. From the "Coupling Element 2" list, select "Attenuation".
6. Select "Couple Selected Parameters".
7. Close the "Parameter Coupling" dialog box.
8. In the first Spectrum channel, change the "Attenuation" to 15 dB.
9. Switch to the first AM/FM/PM Analog Demod channel.

The attenuation in the second AM/FM/PM Analog Demod channel is also set to 15 dB.

**Synchronizing markers in AM/FM/PM Analog Demod windows**

Now you have two AM/FM/PM Analog Demod channels. AnaDemod1 has an FM Spectrum and an FM Time Domain window. AnaDemod2 has an RF Spectrum and an RF Time Domain window. Only when the frequency marker in the FM Spectrum window is moved, the marker in the RF Spectrum window is to move to the same position.

1. Select "Add New User Coupling".
2. From the "Channel 1" list, select "AnaDemod 1".
3. From the "Coupling Element 1" list, select "Frequency Marker 1".
4. From the "Specifics for Window" list, select window "1" (which is the FM Spectrum window).
5. From the "Channel 2" list, select "AnaDemod 2".
6. From the "Coupling Element 2" list, select "Frequency Marker 1".
7. From the "Specifics for Window" list, select window "1" (which is the RF Spectrum window).
8. Select "Couple Selected Parameters".
9. In the "Parameter Coupling" dialog box, for the coupling definition for the frequency markers in the AM/FM/PM Analog Demod channels, select the "Direction": "->".
10. Close the "Parameter Coupling" dialog box.
11. In the first AnaDemod channel, set the frequency marker in the FM Spectrum to 900 MHz.  
In the second AnaDemod channel, the frequency marker in the RF Spectrum is also at 900 MHz.
12. In the second AnaDemod channel, set the frequency marker in the RF Spectrum to 1100 MHz.  
In the first AnaDemod channel, the frequency marker in the FM Spectrum is still at 900 MHz.

## 12 Network operation and remote control

In addition to working with the FSW interactively, located directly at the instrument, it is also possible to operate and control it from a remote PC. Various methods for remote operation are supported:

- Connecting the instrument to a (LAN) network
- Using the web browser interface in a LAN network
- Using the Windows Remote Desktop application in a LAN network
- Connecting a PC via the GPIB interface (requires the "Additional Interfaces" hardware option R&S FSW-B5)

Basic information on operating the FSW via remote control is provided here. This information applies to all applications and operating modes on the FSW.



For additional information on remote control of spectrum analyzers see the following documents available from the Rohde & Schwarz website:

- [Remote control via SCPI](#)
- [1EF62: Hints and Tricks for Remote Control of Spectrum and Network Analyzers](#)
- [1MA171: How to use Rohde & Schwarz Instruments in MATLAB](#)
- [1MA208: Fast Remote Instrument Control with HiSLIP](#)

How to configure the remote control interfaces is described in [Chapter 12.7, "How to set up a network and remote control"](#), on page 870.

• <a href="#">Remote control interfaces and protocols</a> .....	816
• <a href="#">Status reporting system</a> .....	822
• <a href="#">GPIB languages</a> .....	835
• <a href="#">The IECWIN tool</a> .....	837
• <a href="#">Automating tasks with remote command scripts</a> .....	838
• <a href="#">Network and remote control settings</a> .....	851
• <a href="#">How to set up a network and remote control</a> .....	870

### 12.1 Remote control interfaces and protocols

The instrument supports different interfaces and protocols for remote control. The following table gives an overview.



For a description of the protocols refer to [Remote control via SCPI](#).



Table 12-1: Remote control interfaces and protocols

Interface	Protocols, VISA <sup>*)</sup> address string	Port <sup>**)</sup>	Remarks
Local Area Network (LAN)	<b>HiSLIP</b> High-Speed LAN Instrument Protocol (IVI-6.1) TCPIP::host address::hislip0[::INSTR]	TCP port: 4880	A LAN connector is located on the rear panel of the instrument.
	<b>VXI-11</b> TCPIP::host address::inst0[::INSTR] Library: VISA	TCP or UDP port: 111 TCP port: well-known ports (600 - 1023) for Linux or registered ports (1024 - 49151) for Windows	
	<b>socket communication</b> (Raw Ethernet, simple Telnet) TCPIP::host address[::LAN device name]::<port>::SOCKET Library: VISA or socket controller	SCPI raw, TCP port: 5025, 5125 SCPI telnet, TCP port: 5024, 5124	
	VNC	via VNC client: 5800/5900 Device web: 5850	
	Device web / web control	80	
GPIB (IEC/IEEE Bus Interface)	VISA <sup>*)</sup> address string: GPIB::primary address[::INSTR] (no secondary address)		A GPIB bus interface according to the IEC 625.1/IEEE 488.1 standard is located on the rear panel of the instrument.
USB	VISA <sup>*)</sup> address string: USB::<vendor ID>::<product_ID>::<serial_number>[::INSTR]		USB connectors are located on the front and rear panel of the instrument.

<sup>\*)</sup> VISA is a standardized software interface library providing input and output functions to communicate with instruments. A VISA installation on the controller is a prerequisite for remote control using the indicated interfaces.

<sup>\*\*)</sup> By default, FSW use these ports for communication via LAN control interface. If necessary, adapt your firewall to allow for use of these ports.



Within this interface description, the term GPIB is used as a synonym for the IEC/IEEE bus interface.

### 12.1.1 LAN interface

To be integrated in a LAN, the instrument is equipped with a LAN interface, consisting of a connector, a network interface card and protocols. The network card can be operated with the following interfaces:

- 10 Mbit/s Ethernet IEEE 802.3
- 100 Mbit/s Ethernet IEEE 802.3u
- 1Gbit/s Ethernet IEEE 802.3ab

For remote control via a network, the PC and the instrument must be connected via the LAN interface to a common network with TCP/IP network protocol. They are connected using a commercial RJ45 cable (shielded or unshielded twisted pair category 5). The

TCP/IP network protocol and the associated network services are preconfigured on the instrument. Software for instrument control and the VISA program library must be installed on the controller.

### IP address

Only the IP address or a valid DNS host name is required to set up the connection. The host address is part of the "VISA resource string" used by the programs to identify and control the instrument.

The VISA resource string has the form:

```
TCPIP::::LAN device name>::INSTR]
```

or

```
TCPIP::::port>::SOCKET
```

where:

- **TCPIP** designates the network protocol used
- **host address** is the IP address or host name of the device
- **LAN device name** defines the protocol and the instance number of a subinstrument;
  - `inst0` selects the VXI-11 protocol (default)
  - `hislip0` selects the HiSLIP protocol
- **INSTR** indicates the instrument resource class (optional)
- **port** determines the used port number
- **SOCKET** indicates the raw network socket resource class

### Example:

- Instrument has the IP address *192.1.2.3*; the valid resource string using VXI-11 protocol is:  

```
TCPIP::<192.1.2.3>::INSTR
```
- The DNS host name is *FSW13-123456*; the valid resource string using HiSLIP is:  

```
TCPIP::::hislip0
```
- A raw socket connection can be established using:  

```
TCPIP::<192.1.2.3>::5025>::SOCKET
```



### Identifying instruments in a network

If several instruments are connected to the network, each instrument has its own IP address and associated resource string. The controller identifies these instruments by the resource string.

For details on configuring the LAN connection, see [Chapter 12.7, "How to set up a network and remote control"](#), on page 870.

- [LAN web browser interface](#).....819

### 12.1.1.1 LAN web browser interface

The LAN web browser interface allows for easy configuration of the LAN and remote control of the FSW without additional installation requirements.

The instrument's LAN web browser interface works correctly with all W3C compliant browsers.

Via the web browser interface to the FSW you can control the instrument remotely from another PC. Manual instrument controls are available via the front panel simulation. File upload and download between the instrument and the remote PC is also available. Using this feature, several users can access *and operate* the FSW simultaneously. This is useful for troubleshooting or training purposes.

For details, see [Chapter 12.7.1.4, "How to configure the LAN using the web browser interface"](#), on page 875 and [Chapter 12.7.5, "How to control the FSW via the web browser interface"](#), on page 881.



If you do not want other users in the LAN to be able to access and operate the FSW you can deactivate this function.

See [Chapter 12.7.6, "How to deactivate the web browser interface"](#), on page 882.



#### Restrictions

Only user accounts with administrator rights can use the LAN web browser functionality.

#### To display the LAN web browser interface

- ▶ In the address field of the browser on your PC, type the host name or IP address of the instrument, for example: `http://10.113.10.203`.

The instrument home page (welcome page) opens.

The screenshot shows the 'Instrument Home Page' in a browser window. The page features a navigation pane on the left and a main content area. The navigation pane includes sections for LAN, Instrument Control, License Manager, and Help. The main content area displays 'Instrument Properties' for an R&S FSW Spectrum Analyzer. The properties listed are:

Instrument Model	R&S FSW Spectrum Analyzer
Manufacturer	Rohde & Schwarz GmbH & Co. KG
Serial Number	100015
Description	R&S FSW-100015
DNS Host Name(s)	FSW-XXXXXX-3.local.
MAC Address	[REDACTED]
IP Address	[REDACTED]
Firmware Revision	4.70
Current Time	Wednesday, 2020/05/13, 11:22:37
Current Time source	Operating System
VISA resource string	TCP/IP: [REDACTED]:inst0::INSTR TCP/IP: [REDACTED]:hisip0::INSTR
Device Indicator	<input type="button" value="INACTIVE (press to toggle)"/>

At the bottom of the page, a 'Status' section indicates 'No error'. The footer contains the copyright notice: © 2020 ROHDE&SCHWARZ. All rights reserved.

The navigation pane of the browser interface contains the following elements:

- "LAN"
  - "Home" opens the instrument home page. The home page displays device information, including the VISA resource string in read-only format. "Device Indicator" allows you to physically identify the instrument. This is useful if you have several instruments and want to know which instrument the LAN home page belongs to. To identify the instrument, activate the "Device Indicator". Then check the "LAN Status" indicator of the instruments.
  - "LAN Configuration" allows you to configure LAN parameters and to initiate a ping. (See "LAN configuration" on page 876.)
  - "Utilities" provides access to an event log.
- "Instrument Control"
  - "Web Control" provides remote access to the instrument via VNC (no installation required). Manual instrument controls are available via the front panel simulation.
  - "File Download" downloads files from the instrument.
  - "File Upload" uploads files to the instrument. (See [step 4.](#))
- "License Manager"

- "License Manager" allows you to install or uninstall license keys and to activate, register or unregister licenses.
- "Help"  
"www.rohde-schwarz.com" opens the Rohde & Schwarz home page.

### 12.1.2 GPIB interface (IEC 625/IEEE 418 bus interface)

A GPIB interface is integrated on the rear panel of the instrument.

By connecting a PC to the FSW via the GPIB connection you can send remote commands to control and operate the instrument.

To be able to control the instrument via the GPIB bus, the instrument and the controller must be linked by a GPIB bus cable. A GPIB bus card, the card drivers and the program libraries for the programming language used must be provided in the controller. The controller must address the instrument with the GPIB bus address (see [Chapter 12.7.1.5, "How to change the GPIB instrument address"](#), on page 877). You can set the GPIB address and the ID response string. The GPIB language is set as SCPI by default and cannot be changed for the FSW.

#### Notes and Conditions

In connection with the GPIB interface, note the following:

- Up to 15 instruments can be connected
- The total cable length is restricted to a maximum of 15 m or 2 m times the number of devices, whichever is less; the cable length between two instruments should not exceed 2 m.
- A wired "OR"-connection is used if several instruments are connected in parallel.
- Any connected IEC-bus cables should be terminated by an instrument or controller.

### 12.1.3 USB interface

For remote control via the USB connection, the PC and the instrument must be connected via the USB type B interface.

(Note: the USB type B interface is not available for instruments with CPU board 1206.3874.00 or higher.)

A USB connection requires the VISA library to be installed. VISA detects and configures the R&S instrument automatically when the USB connection is established. You do not have to enter an address string or install a separate driver.

#### USB address

The used USB address string is:

```
USB::<vendor ID>::<product ID>::<serial number>[::INSTR]
```

where:

- `<vendor ID>` is the vendor ID for Rohde & Schwarz (0x0AAD)

- <product ID> is the product ID for the Rohde & Schwarz instrument
- <serial number> is the individual serial number on the rear of the instrument

**Table 12-2: Product IDs for FSW**

Instrument model	Product ID
FSW8	C6
FSW13	C7
FSW26	C8
FSW43	CA
FSW50	CB
FSW67	CC
FSW85	CD

**Example:**

```
USB::0x0AAD::0x00C7::100001::INSTR
```

0x0AAD is the vendor ID for Rohde & Schwarz

0x00C7 is the product ID for the FSW13

100001 is the serial number of the particular instrument

## 12.2 Status reporting system

The status reporting system stores all information on the current operating state of the instrument, and on errors which have occurred. This information is stored in the status registers and in the error queue. Both can be queried via GPIB bus or LAN interface using the `STATus...` commands.

(See [Chapter 13.11, "Using the status register"](#), on page 1478).

For details on the status reporting system, see [Remote control via SCPI](#).

- [Hierarchy of status registers](#)..... 822
- [Contents of the status registers](#)..... 823
- [Reset values of the status reporting system](#)..... 834

### 12.2.1 Hierarchy of status registers

As shown in the following figure, the status information is of hierarchical structure.

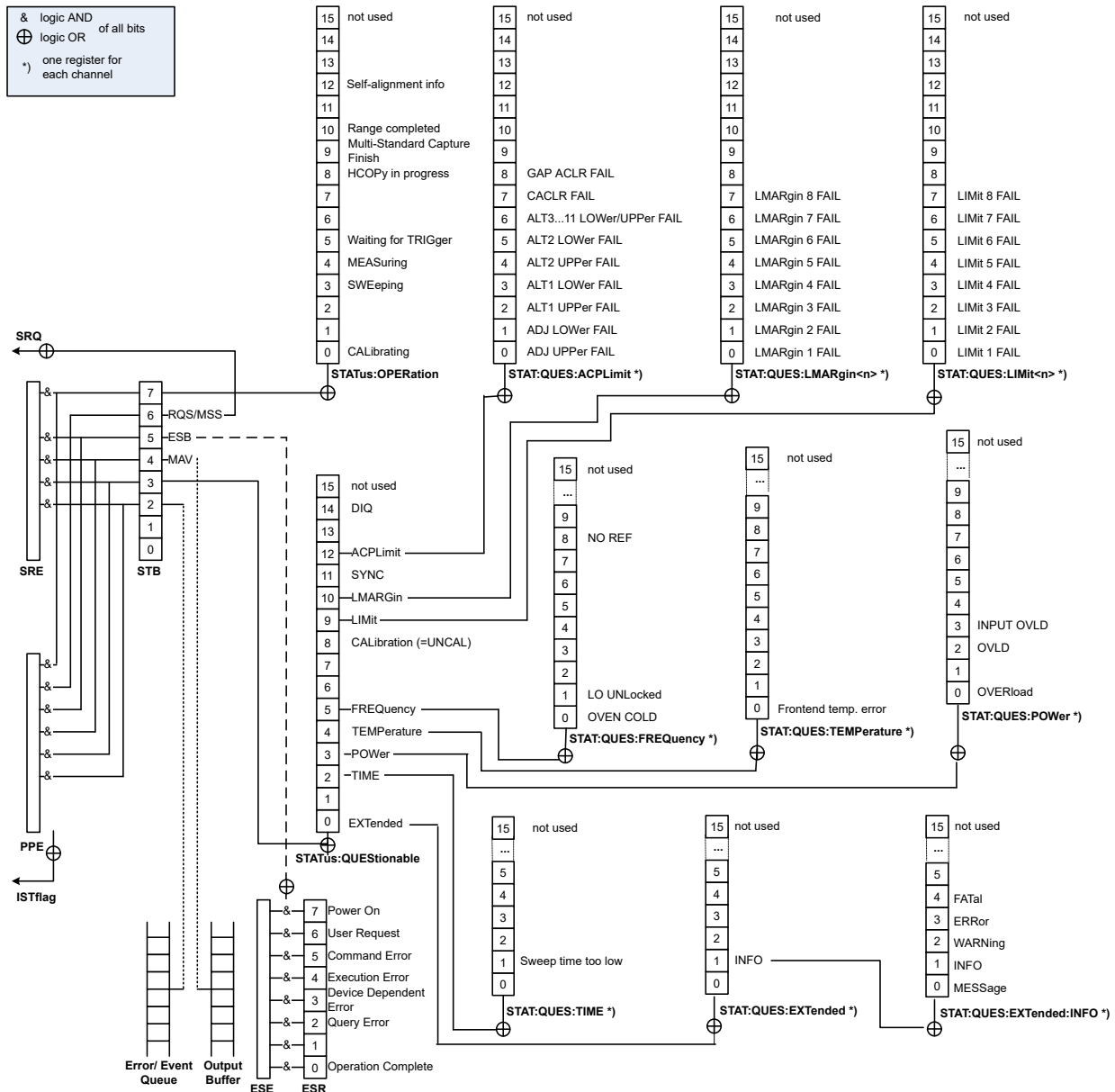

Figure 12-1: Graphical overview of the FSW status registers hierarchy

All status registers have the same internal structure.

### 12.2.2 Contents of the status registers

In the following sections, the contents of the status registers are described in more detail.

**STATus:QUEStionable:DIQ register**

The `STATus:QUEStionable:DIQ` register is used for digital I/Q data from the optional Digital Baseband Interface and is described in the FSW I/Q Analyzer and I/Q Input User Manual.

**STATus:QUEStionable:SYNC register**

The `STATus:QUEStionable:SYNC` register is used by the FSW applications and is described in the individual sections (manuals) for each application.

- [Status byte \(STB\) and service request enable register \(SRE\)](#)..... 824
- [IST flag and parallel poll enable register \(PPE\)](#)..... 825
- [Event status register \(ESR\) and event status enable register \(ESE\)](#)..... 825
- [STATus:OPERation register](#)..... 826
- [STATus:QUEStionable register](#)..... 827
- [STATus:QUEStionable:ACPLimit register](#)..... 829
- [STATus:QUEStionable:EXTended register](#)..... 829
- [STATus:QUEStionable:EXTended:INFO register](#)..... 830
- [STATus:QUEStionable:FREQuency register](#)..... 830
- [STATus:QUEStionable:LIMit register](#)..... 831
- [STATus:QUEStionable:LMARgin register](#)..... 832
- [STATus:QUEStionable:POWer register](#)..... 832
- [STATus:QUEStionable:TEMPerature register](#)..... 833
- [STATus:QUEStionable:TIME register](#)..... 834

**12.2.2.1 Status byte (STB) and service request enable register (SRE)**

The `STatus Byte` (STB) is already defined in IEEE 488.2. It provides a rough overview of the instrument status by collecting the pieces of information of the lower registers. A special feature is that bit 6 acts as the sum bit of the remaining bits of the status byte.

The STB can thus be compared with the `CONDition` part of an SCPI register and assumes the highest level within the SCPI hierarchy.

The STB is read using the command `*STB?` or a serial poll.

The `STatus Byte` (STB) is linked to the `Service Request Enable` (SRE) register. Each bit of the STB is assigned a bit in the SRE. Bit 6 of the SRE is ignored. If a bit is set in the SRE and the associated bit in the STB changes from 0 to 1, a service request (SRQ) is generated. The SRE can be set using the command `*SRE` and read using the command `*SRE?`.



Table 12-3: Meaning of the bits used in the status byte

Bit No.	Meaning
0...1	Not used
2	Error Queue not empty The bit is set when an entry is made in the error queue. If this bit is enabled by the SRE, each entry of the error queue generates a service request. Thus an error can be recognized and specified in greater detail by polling the error queue. The poll provides an informative error message. This procedure is to be recommended since it considerably reduces the problems involved with remote control.
3	QUEStionable status register summary bit The bit is set if an <code>EVENT</code> bit is set in the <code>QUEStionable</code> status register and the associated <code>ENABLe</code> bit is set to 1. A set bit indicates a questionable instrument status, which can be specified in greater detail by querying the <code>STATus:QUEStionable</code> status register.
4	MAV bit (message available) The bit is set if a message is available in the output queue which can be read. This bit can be used to enable data to be automatically read from the instrument to the controller.
5	ESB bit Sum bit of the event status register. It is set if one of the bits in the event status register is set and enabled in the event status enable register. Setting of this bit indicates a serious error which can be specified in greater detail by polling the event status register.
6	MSS bit (main status summary bit) The bit is set if the instrument triggers a service request. This is the case if one of the other bits of this registers is set together with its mask bit in the service request enable register SRE.
7	<code>STATus:OPERation</code> status register summary bit The bit is set if an <code>EVENT</code> bit is set in the <code>OPERation</code> status register and the associated <code>ENABLe</code> bit is set to 1. A set bit indicates that the instrument is just performing an action. The type of action can be determined by querying the <code>STATus:OPERation</code> status register.

### 12.2.2.2 IST flag and parallel poll enable register (PPE)

As with the SRQ, the IST flag combines the entire status information in a single bit. It can be read by means of a parallel poll or using the command `*IST?`.

The parallel poll enable register (PPE) determines which bits of the STB contribute to the IST flag. The bits of the STB are "ANDed" with the corresponding bits of the PPE, with bit 6 being used as well in contrast to the SRE. The IST flag results from the "ORing" of all results. The PPE can be set using commands `*PRE` and read using command `*PRE?`.

### 12.2.2.3 Event status register (ESR) and event status enable register (ESE)

The ESR is defined in IEEE 488.2. It can be compared with the `EVENT` part of a SCPI register. The event status register can be read out using command `*ESR?`.

The ESE corresponds to the `ENABLe` part of a SCPI register. If a bit is set in the ESE and the associated bit in the ESR changes from 0 to 1, the ESB bit in the STB is set. The ESE register can be set using the command `*ESE` and read using the command `*ESE?`.

**Table 12-4: Meaning of the bits used in the event status register**

Bit No.	Meaning
0	Operation Complete This bit is set on receipt of the command *OPC exactly when all previous commands have been executed.
1	Not used
2	Query Error This bit is set if either the controller wants to read data from the instrument without having sent a query, or if it does not fetch requested data and sends new instructions to the instrument instead. The cause is often a query which is faulty and hence cannot be executed.
3	Device-dependent Error This bit is set if a device-dependent error occurs. An error message with a number between -300 and -399 or a positive error number, which denotes the error in greater detail, is entered into the error queue.
4	Execution Error This bit is set if a received command is syntactically correct but cannot be performed for other reasons. An error message with a number between -200 and -300, which denotes the error in greater detail, is entered into the error queue.
5	Command Error This bit is set if a command is received, which is undefined or syntactically incorrect. An error message with a number between -100 and -200, which denotes the error in greater detail, is entered into the error queue.
6	User Request This bit is set when the instrument is switched over to manual control.
7	Power On (supply voltage on) This bit is set on switching on the instrument.

#### 12.2.2.4 STATus:OPERation register

The `STATus:OPERation` register contains information on current activities of the FSW. It also contains information on activities that have been executed since the last read out.

You can read out the register with `STATus:OPERation:CONDition?` or `STATus:OPERation[:EVENT]?`.

**Table 12-5: Meaning of the bits used in the STATus:OPERation register**

Bit No.	Meaning
0	<code>CALibrating</code> This bit is set as long as the instrument is performing a self-alignment.
1-2	Not used
3	<code>SWEEping</code> Sweep is being performed in base unit (applications are not considered); identical to bit 4 In applications, this bit is not used.

Bit No.	Meaning
4	MEASuring Measurement is being performed in base unit (applications are not considered); identical to bit 3 In applications, this bit is not used.
5	Waiting for TRigger Instrument is ready to trigger and waiting for trigger signal.
6-7	Not used
8	HardCOpy in progress This bit is set while the instrument is printing a hardcopy.
9	For data acquisition in MSRA/MSRT mode only: Multi-Standard capture finish This bit is set if a data acquisition measurement was completed successfully in MSRA/MSRT operating mode and data is available for evaluation. For details on the MSRT operating mode see the FSW "Real-Time Spectrum" Application and MSRT Operating Mode User Manual.
10	Range completed This bit is set when a range in the sweep list is completed if "Stop after Sweep" is enabled (see "Stop After Sweep" on page 287).
11	Not used
12	Self-alignment overdue
13-14	Not used
15	This bit is always 0.

### 12.2.2.5 STATus:QUEStionable register

The STATus:QUEStionable register contains information on instrument states that do not meet the specifications.



The STAT:QUES:SYNC register is used by the applications and is thus described in the individual applications' User Manuals.

You can read out the register with STAT:QUES:COND or STAT:QUES:EVEN.



The STATus:QUEStionable register "sums up" the information from all subregisters (e.g. bit 2 sums up the information for all STATus:QUEStionable:TIME registers). For some subregisters, there may be separate registers for each active channel. Thus, if a status bit in the STATus:QUEStionable register indicates an error, the error may have occurred in any of the channel-specific subregisters. In this case, you must check the subregister of each channel to determine which channel caused the error. By default, querying the status of a subregister always returns the result for the currently selected channel.

Table 12-6: Meaning of the bits used in the STATUS:QUESTIONable register

Bit No.	Meaning
0	"EXTended" This bit indicates further status information not covered by the other status registers in any of the active channels.
1	Unused
2	"TIMe" This bit is set if a time error occurs in any of the active channels. The <a href="#">STATUS:QUESTIONable:TIMe register</a> provides more information on the error type.
3	"POWer" This bit is set if the measured power level in any of the active channels is questionable. The <a href="#">STATUS:QUESTIONable:POWer register</a> provides more information on the error type.
4	"TEMPerature" This bit is set if the temperature is questionable.
5	"FREQuency" This bit is set if there is anything wrong with the frequency of the local oscillator or the reference frequency in any of the active channels. The <a href="#">STATUS:QUESTIONable:FREQuency register</a> provides more information on the error type.
6 - 7	Unused
8	"CALibration" This bit is set if the FSW is unaligned ("UNCAL" display)
9	"LIMit" (device-specific) This bit is set if a limit value is violated in any of the active channels in any window. The <a href="#">STATUS:QUESTIONable:LIMit register</a> provides more information on the error type.
10	"LMARgin" (device-specific) This bit is set if a margin is violated in any of the active channels in any window. The <a href="#">STATUS:QUESTIONable:LMARgin register</a> provides more information on the error type.
11	"SYNC" (device-specific) This bit is set if the FSW is not synchronized to the signal that is applied. The FSW is not synchronized if: <ul style="list-style-type: none"> <li>• it cannot synchronize to midamble during a measurement or premeasurement</li> <li>• it cannot find a burst during a measurement or premeasurement</li> <li>• the results deviate too much from the expected value during premeasurements</li> </ul>
12	"ACPLimit" (device-specific) This bit is set if a limit during ACLR measurements is violated in any of the active channels. The <a href="#">STATUS:QUESTIONable:ACPLimit register</a> provides more information on the error type.
13	Unused
14	Digital I/Q (device-specific) This bit is set if a connection error occurs at the optional Digital Baseband Interface. For details see the FSW I/Q Analyzer User Manual.
15	This bit is always 0.

### 12.2.2.6 STATUS:QUESTIONABLE:ACPLimit register

The STATUS:QUESTIONABLE:ACPLimit register contains information about the results of a limit check during ACLR measurements. A separate ACPLimit register exists for each active channel.

You can read out the register with `STATUS:QUESTIONABLE:ACPLimit:CONDITION?` or `STATUS:QUESTIONABLE:ACPLimit[:EVENT]?`

**Table 12-7: Meaning of the bits used in the STATUS:QUESTIONABLE:ACPLimit register**

Bit No.	Meaning
0	ADJ UPPER FAIL This bit is set if the limit is exceeded in the <b>upper adjacent</b> channel
1	ADJ LOWER FAIL This bit is set if the limit is exceeded in the <b>lower adjacent</b> channel.
2	ALT1 UPPER FAIL This bit is set if the limit is exceeded in the <b>upper 1st alternate</b> channel.
3	ALT1 LOWER FAIL This bit is set if the limit is exceeded in the <b>lower 1st alternate</b> channel.
4	ALT2 UPPER FAIL This bit is set if the limit is exceeded in the <b>upper 2nd alternate</b> channel.
5	ALT2 LOWER FAIL This bit is set if the limit is exceeded in the <b>lower 2nd alternate</b> channel.
6	ALT3 ... 11 LOWER/UPPER FAIL This bit is set if the limit is exceeded in one of the lower or upper alternate channels 3 ... 11.
7	CACLR FAIL This bit is set if the CACLR limit is exceeded in one of the gap channels.
8	GAP ACLR FAIL This bit is set if the ACLR limit is exceeded in one of the gap channels.
9 to 14	Unused
15	This bit is always 0.

### 12.2.2.7 STATUS:QUESTIONABLE:EXTended register

The STATUS:QUESTIONABLE:EXTended register contains further status information not covered by the other status registers of the FSW. A separate EXTended register exists for each active channel.

You can read out the register with `STATUS:QUESTIONABLE:EXTended:CONDITION?` or `STATUS:QUESTIONABLE:EXTended[:EVENT]?`

**Table 12-8: Meaning of the bits used in the STATUS:QUESTIONable:EXTended register**

Bit No.	Meaning
0	not used
1	INFO This bit is set if a status message is available for the application. Which type of message occurred is indicated in the <a href="#">STATUS:QUESTIONable:EXTended:INFO register</a> .
2 to 14	Unused
15	This bit is always 0.

### 12.2.2.8 STATUS:QUESTIONable:EXTended:INFO register

The STATUS:QUESTIONable:EXTended:INFO register contains information on the type of messages that occur during operation of the FSW. A separate INFO register exists for each active channel.

You can read out the register with [STATUS:QUESTIONable:EXTended:INFO:CONDition?](#) or [STATUS:QUESTIONable:EXTended:INFO\[:EVENT\]?](#). You can query all messages that occur for a specific channel using the command [SYSTEM:ERRor:EXTended?](#) on page 1448.

**Table 12-9: Meaning of the bits used in the STATUS:QUESTIONable:EXTended:INFO register**

Bit No.	Meaning
0	MESSage This bit is set if event or state has occurred that may lead to an error during further operation.
1	INFO This bit is set if an informational status message is available for the application.
2	WARNing This bit is set if an irregular situation occurs during measurement, e.g. the settings no longer match the displayed results, or the connection to an external device was interrupted temporarily.
3	ERRor This bit is set if an error occurs during a measurement, e.g. due to missing data or wrong settings, so that the measurement cannot be completed correctly.
4	FATal This bit is set if a serious error occurs in the application and regular operation is no longer possible.
5 to 14	Unused
15	This bit is always 0.

### 12.2.2.9 STATUS:QUESTIONable:FREQuency register

The STATUS:QUESTIONable:FREQuency register contains information about the condition of the local oscillator and the reference frequency. A separate frequency register exists for each active channel.

You can read out the register with `STATUS:QUESTIONABLE:FREQUENCY:CONDITION?` or `STATUS:QUESTIONABLE:FREQUENCY[:EVENT]?`.

**Table 12-10: Meaning of the bits used in the STATUS:QUESTIONABLE:FREQUENCY register**

Bit No.	Meaning
0	OVEN COLD This bit is set if the reference oscillator has not yet attained its operating temperature. "OCXO" is displayed.
1	LO UNLocked This bit is set if the local oscillator no longer locks. "LOUNL" is displayed.
2 to 7	Not used
8	EXTernalREFerence This bit is set if you have selected an external reference oscillator but did not connect a useable external reference source. In that case the synthesizer can not lock. The frequency in all probability is not accurate.
9 to 14	Not used
15	This bit is always 0.

#### 12.2.2.10 STATUS:QUESTIONABLE:LIMit register

The STATUS:QUESTIONABLE:LIMit register contains information about the results of a limit check when you are working with limit lines.

A separate LIMit register exists for each active channel and for each window.

You can read out the register with `STATUS:QUESTIONABLE:LIMit<n>:CONDITION?` or `STATUS:QUESTIONABLE:LIMit<n>[:EVENT]?`.

**Table 12-11: Meaning of the bits used in the STATUS:QUESTIONABLE:LIMit register**

Bit No.	Meaning
0	LIMit 1 FAIL This bit is set if limit line 1 is violated.
1	LIMit 2 FAIL This bit is set if limit line 2 is violated.
2	LIMit 3 FAIL This bit is set if limit line 3 is violated.
3	LIMit 4 FAIL This bit is set if limit line 4 is violated.
4	LIMit 5 FAIL This bit is set if limit line 5 is violated.
5	LIMit 6 FAIL This bit is set if limit line 6 is violated.
6	LIMit 7 FAIL This bit is set if limit line 7 is violated.

Bit No.	Meaning
7	LIMit 8 FAIL This bit is set if limit line 8 is violated.
8 to 14	Unused
15	This bit is always 0.

### 12.2.2.11 STATUS:QUESTIONABLE:LMARGIN register

This register contains information about the observance of limit margins.

A separate LMARGIN register exists for each active channel and for each window.

It can be read using the commands

STATUS:QUESTIONABLE:LMARGIN:CONDITION? and

STATUS:QUESTIONABLE:LMARGIN[:EVENT]?.

**Table 12-12: Meaning of the bits used in the STATUS:QUESTIONABLE:LMARGIN register**

Bit No.	Meaning
0	LMARGIN 1 FAIL This bit is set if limit margin 1 is violated.
1	LMARGIN 2 FAIL This bit is set if limit margin 2 is violated.
2	LMARGIN 3 FAIL This bit is set if limit margin 3 is violated.
3	LMARGIN 4 FAIL This bit is set if limit margin 4 is violated.
4	LMARGIN 5 FAIL This bit is set if limit margin 5 is violated.
5	LMARGIN 6 FAIL This bit is set if limit margin 6 is violated.
6	LMARGIN 7 FAIL This bit is set if limit margin 7 is violated.
7	LMARGIN 8 FAIL This bit is set if limit margin 8 is violated.
8 to 14	Not used
15	This bit is always 0.

### 12.2.2.12 STATUS:QUESTIONABLE:POWER register

The STATUS:QUESTIONABLE:POWER register contains information about possible overload situations that may occur during operation of the FSW. A separate power register exists for each active channel.



You can read out the register with `STATUS:QUESTIONABLE:POWER:CONDITION?` or `STATUS:QUESTIONABLE:POWER[:EVENT]?`

**Table 12-13: Meaning of the bits used in the STATUS:QUESTIONABLE:POWER register**

Bit No.	Meaning
0	OVERload This bit is set if an overload occurs at the RF input, causing signal distortion but not yet causing damage to the device. The FSW displays the keyword "RF OVLD".
1	Unused
2	IF_OVERload This bit is set if an overload occurs in the IF path. The FSW displays the keyword "OVLD".
3	Input Overload This bit is set if the signal level at the RF input connector exceeds the maximum. The RF input is disconnected from the input mixer to protect the device. In order to re-enable measurement, decrease the level at the RF input connector and reconnect the RF input to the mixer input. For details on the protection mechanism see "RF Input Protection" on page 363 or <code>INPUT:ATTenuation:PROTection:RESet</code> on page 1110. The FSW displays the keyword "INPUT OVLD".
4 to 14	Unused
15	This bit is always 0.

### 12.2.2.13 STATUS:QUESTIONABLE:TEMPerature register

The STATUS:QUESTIONABLE:TEMPerature register contains information about possible temperature deviations that may occur during operation of the FSW. A separate temperature register exists for each active channel.

You can read out the register with `STATUS:QUESTIONABLE:TEMPerature:CONDITION?` or `STATUS:QUESTIONABLE:TEMPerature[:EVENT]?`

**Table 12-14: Meaning of the bits used in the STATUS:QUESTIONABLE:TEMPerature register**

Bit No.	Meaning
0	This bit is set if the frontend temperature sensor deviates by a certain degree from the self-alignment temperature. During warmup, this bit is always 1. For details see "Temperature check" on page 727.
1 to 14	Unused
15	This bit is always 0.

### 12.2.2.14 STATus:QUEStionable:TIME register

The STATus:QUEStionable:TIME register contains information about possible time errors that may occur during operation of the FSW. A separate time register exists for each active channel.

You can read out the register with `STATus:QUEStionable:TIME:CONDition?` or `STATus:QUEStionable:TIME[:EVENT]?`

**Table 12-15: Meaning of the bits used in the STATus:QUEStionable:TIME register**

Bit No.	Meaning
0	not used
1	Sweep time too low This bit is set if the sweep time is too low.
2 to 14	Unused
15	This bit is always 0.

### 12.2.3 Reset values of the status reporting system

The following table contains the different commands and events causing the status reporting system to be reset. None of the commands, except \*RST and SYSTem:PRESet, influence the functional instrument settings. In particular, DCL does not change the instrument settings.

**Table 12-16: Resetting the status reporting system**

Event	Switching on supply voltage Power-On-Status-Clear		DCL, SDC (Device Clear, Selected Device Clear)	*RST or SYS-Tem:PRE Set	STA-Tus:PRE-Set	*CLS
	0	1				
Clear STB, ESR	-	yes	-	-	-	yes
Clear SRE, ESE	-	yes	-	-	-	-
Clear PPE	-	yes	-	-	-	-
Clear EVENT parts of the registers	-	yes	-	-	-	yes
Clear ENABLE parts of all OPERation and QUEStionable registers; Fill ENABLE parts of all other registers with "1".	-	yes	-	-	yes	-
Fill PTRansition parts with "1"; Clear NTRansition parts	-	yes	-	-	yes	-
Clear error queue	yes	yes	-	-	-	yes

Event	Switching on supply voltage Power-On-Status-Clear		DCL, SDC (Device Clear, Selected Device Clear)	*RST or SYS- Tem:PRE Set	STA- Tus:PRE- Set	*CLS
	0	1				
Clear output buffer	yes	yes	yes	1)	1)	1)
Clear command processing and input buffer	yes	yes	yes	-	-	-

1) The first command in a command line that immediately follows a <PROGRAM MESSAGE TERMINATOR> clears the output buffer.

## 12.3 GPIB languages

The FSW analyzer family supports a subset of the GPIB commands used by other devices. Thus it can emulate other devices in order to use existing remote control programs.

The device model to be emulated is selected manually using "SETUP > Network + Remote > GPIB tab > Language". Via the GPIB interface using the [SYSTEM: LANGUage](#) on page 1489 command.

In order to emulate device models that are not part of the selection list of the GPIB "Language" setting, you can modify the identification string received in response to the ID command ("Identification String" setting). Thus, any device model whose command set is compatible with one of the supported device models can be emulated.

### Supported languages

Language	Comment
SCPI	
71100C	Compatible to 8566A/B
71200C	Compatible to 8566A/B
71209A	Compatible to 8566A/B
8560E	
8561E	
8562E	
8563E	
8564E	
8565E	
8566A	Command sets A and B are available. Command sets A and B differ in the rules regarding the command structure.

Language	Comment
8566B	
8568A	Command sets A and B are available. Command sets A and B differ in the rules regarding the command structure.
8568A_DC	Uses DC input coupling by default if supported by the instrument
8568B	Command sets A and B are available. Command sets A and B differ in the rules regarding the command structure.
8568B_DC	Uses DC input coupling by default if supported by the instrument
8591E	Compatible to 8594E
8594E	Command sets A and B are available. Command sets A and B differ in the rules regarding the command structure.
PSA89600	
PSA	
PXA	
R&S FSEA	
R&S FSEB	
R&S FSEM	
R&S FSEK	
R&S FSP	
R&S FSQ	
R&S FSU	
R&S FSV	

**Notes:**

- If you select a language other than "SCPI", the GPIB address is set to 18 if it was 20 before.
- The Start/stop frequency, reference level and number of sweep points are adapted to the selected instrument model.
- For R&S FSP/FSQ/FSU emulation, HP commands are not automatically also allowed. In this case, set [HP Additional](#) to ON.
- When you switch between remote control languages, the following settings or changes are made:
  - SCPI:**  
The instrument performs a PRESET.
  - 8566A/B, 8568A/B, 8594E; FSEA, FSEB, FSEM; FSEK:**
    - The instrument performs a PRESET.
    - The following instrument settings are changed:

**Table 12-17: Instrument settings for emulation of 8566A/B, 8568A/B, 8594E; FSEA, FSEB, FSEM; FSEK instruments**

Model	# of Trace Points	Start Freq.	Stop Freq.	Ref Level	Input Coupling
8566A/B	1001	2 GHz	22 GHz	0 dBm	AC
8568A/B	1001	0 Hz	1.5 GHz	0 dBm	AC
8560E	601	0 Hz	2.9 GHz	0 dBm	AC
8561E	601	0 Hz	6.5 GHz	0 dBm	AC
8562E	601	0 Hz	13.2 GHz	0 dBm	AC
8563E	601	0 Hz	26.5 GHz	0 dBm	AC
8564E	601	0 Hz	40 GHz	0 dBm	AC
8565E	601	0 Hz	50 GHz	0 dBm	AC
8594E	401	0 Hz	3 GHz	0 dBm	AC
FSEA	500	0 Hz	3.5 GHz	-20 dBm	AC
FSEB	500	0 Hz	7 GHz	-20 dBm	AC
FSEM	500	0 Hz	26.5 GHz	-20 dBm	AC
FSEK	500	0 Hz	40 GHz	-20 dBm	AC

**Note:** The stop frequency indicated in the table may be limited to the corresponding frequency of the FSW, if required.

## 12.4 The IECWIN tool

The FSW is delivered with *IECWIN* installed, an auxiliary tool provided free of charge by R&S. IECWIN is a program to send SCPI commands to a measuring instrument either interactively or from a command script.



The R&S IECWIN32 tool is provided free of charge. The functionality may change in a future version without notice.

IECWIN offers the following features:

- Connection to instrument via several interfaces/protocols (GPIB, VISA, named pipe (if IECWIN is run on the instrument itself), RSIB)
- Interactive command entry
- Browsing available commands on the instrument
- Error checking following every command
- Execution of command scripts
- Storing binary data to a file
- Reading binary data from a file

- Generation of a log file

For command scripts, IECWIN offers the following features:

- Synchronization with the instrument on every command
- Checking expected result for query commands (as string or numeric value)
- Checking for expected errors codes
- Optional pause on error
- Nested command scripts
- Single step mode
- Conditional execution, based on the \*IDN and \*OPT strings



You can use the IECWIN to try out the programming examples provided in the FSW User Manuals.

### Starting IECWIN

IECWIN is available from the Windows "Start" menu on the FSW, or by executing the following file:

```
C:\Program Files (x86)\Rohde-Schwarz\FSW\<version>\iecwin32.exe
```

You can also copy the program to any Windows PC or laptop. Simply copy the `iecwin32.exe`, `iecwin.chm` and `rsib32.dll` files from the location above to the same folder on the target computer.

When the tool is started, a "Connection settings" dialog box is displayed. Define the connection from the computer the IECWIN tool is installed on to the FSW you want to control. If you are using the tool directly on the FSW, you can use an NT Pipe (COM Parser) connection, which requires no further configuration. For help on setting up other connection types, check the tool's online help (by clicking the "Help" button in the dialog box).



The IECWIN offers an online help with extensive information on how to work with the tool.

## 12.5 Automating tasks with remote command scripts

To configure a test setup quickly and make complex test setups or repetitive measurements reproducible, you can automate the required settings with scripts. A script contains a series of SCPI commands corresponding to the settings. When completed, it is converted to an executable format, saved in a file, and can be run whenever needed.

### Creating a SCPI script

Using the SCPI Recorder functions, you can create a SCPI script directly on the instrument and then export the script for use on the controller. You can also edit or write a script manually, using a suitable editor on the controller. For manual creation, the

instrument supports you by showing the corresponding command syntax for the current setting value.

You can create a SCPI script directly on the instrument at any time of operation, in the following ways:

- Recording individual steps manually  
In manual recording mode, you can record an individual SCPI command using the "Add SCPI Command to Recording" function, see ["How to record SCPI commands manually"](#) on page 849.
- Recording all performed steps automatically  
The instrument records the SCPI command and settings value of each step you perform, and then writes the commands to the file system, see ["How to record SCPI commands automatically"](#) on page 848. You can start, stop and resume automatic recording, and also record individual commands manually.
- Copying commands from the context-sensitive SCPI Recorder menu and pasting them into an editor  
The SCPI Recorder enables you to copy the SCPI command and the current setting shown in the context-sensitive menu and paste them into any suitable editor, see ["To edit a SCPI command list"](#) on page 849.

### 12.5.1 The context-sensitive SCPI command menu

The SCPI Recorder provides information on the required SCPI command for the available measurement settings, functions, and results in a context-sensitive menu. The SCPI command menu is displayed when you tap and hold (right-click) any interface element that allows you to define a setting, perform a function, or displays results, for example:

- Softkeys
- Buttons or input fields in dialog boxes
- Traces or markers in a diagram

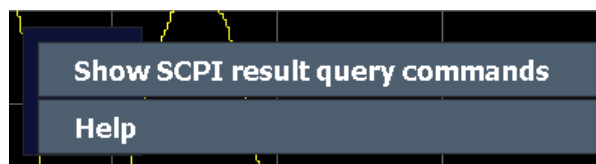

*Figure 12-2: Context-sensitive SCPI command menu for a trace in a result display*

The menu provides the syntax of the remote command with the current setting, and some functions to help you create your script.

<a href="#">Show SCPI result query commands</a> .....	840
<a href="#">Show SCPI command</a> .....	840
L <a href="#">Copy SCPI Command to Clipboard</a> .....	840
L <a href="#">Help</a> .....	840
L <a href="#">Add SCPI Command to Recording</a> .....	840
<a href="#">Help</a> .....	840

**Show SCPI result query commands**

This menu item is displayed if you selected a result display.

All possible commands to query the results in the diagram are displayed. Select the query command you are interested in to display the SCPI command dialog box, as described in ["Show SCPI command"](#) on page 840.

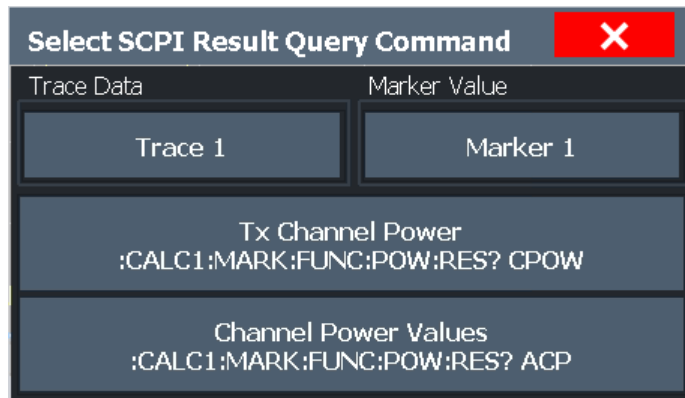

Figure 12-3: Possible result query commands for an ACLR measurement

**Show SCPI command**

This menu item is displayed if you selected a setting or function.

A dialog box displays the SCPI command required to perform the setting or function, or to query the trace or marker results.

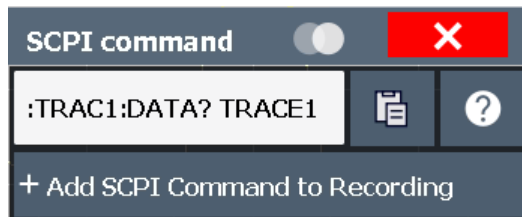

Figure 12-4: SCPI command dialog for a trace in a result display

**Copy SCPI Command to Clipboard ← Show SCPI command**

Copies the command and the current value for the selected setting to the clipboard.

**Help ← Show SCPI command**

Provides help on the displayed SCPI command, its syntax and possible parameter values.

**Add SCPI Command to Recording ← Show SCPI command**

Adds the command and the current value for the selected setting to the recorded SCPI list.

**Help**

Provides help on the selected setting, function, or result display, as opposed to the SCPI command itself. This function is identical to selecting the context-sensitive help icon  in the toolbar and then the interface element.



## 12.5.2 The SCPI recorder



**Access:** Toolbar

The SCPI Recorder displays a list of the currently recorded commands and provides functions to create and export a script of SCPI commands. Some additional settings for recording are provided on a separate tab in the dialog box.

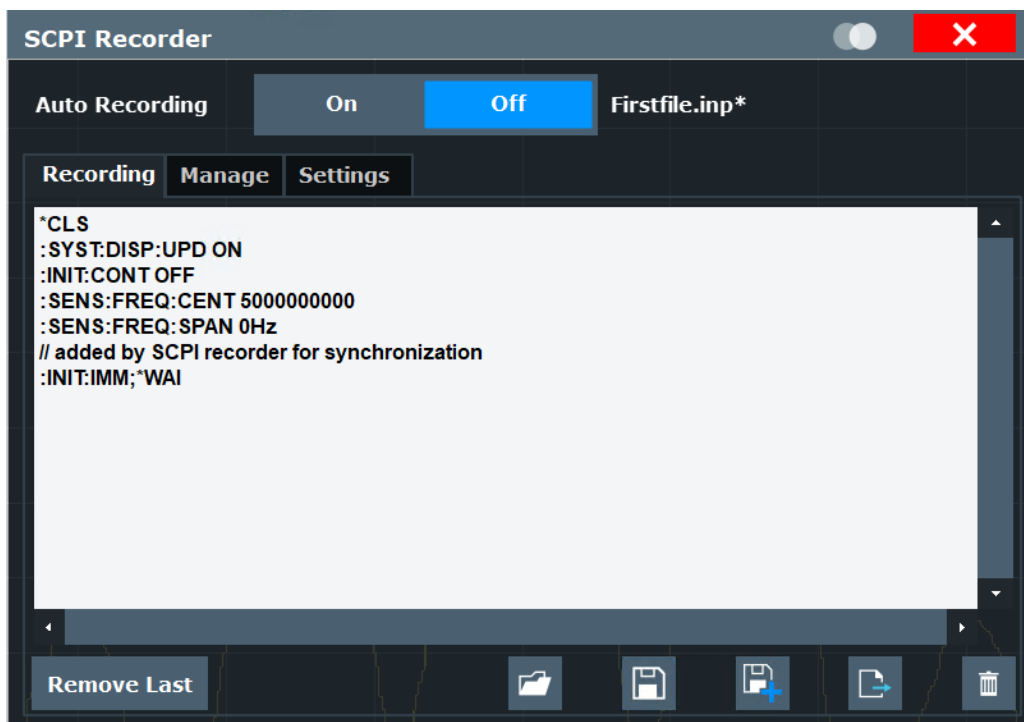

- [Recording](#).....841
- [Managing recordings](#).....844
- [Recording settings](#)..... 846

### 12.5.2.1 Recording

- [Auto Recording](#)..... 841
- [List of recorded commands / script editor](#)..... 842
- [Remove Last](#)..... 842
- [Load Recording](#)..... 842
- [Save](#)..... 842
- [Save As](#)..... 842
- [Export](#)..... 842
- [Clear All](#)..... 843

#### Auto Recording

If enabled, the SCPI Recorder automatically records the required SCPI commands and parameter values for the settings and functions you use while operating the FSW.

To view the list of currently recorded SCPI commands at any time, select the SCPI Recorder icon in the toolbar.

Recording is stopped when you deactivate "Auto Recording".

To continue recording, reactivate "Auto Recording".

To start a new SCPI command list, select  **Clear All** before activating "Auto Recording".

**Note:**

- Some parameters cannot be set by a SCPI command.
- The FSW automatically clears the SCPI command list after booting.

Remote command:

`SYSTem:SRECOder[:AUTO]` on page 1483

**List of recorded commands / script editor**

The currently recorded commands are displayed in a basic editor directly in the SCPI Recorder dialog box. Right-click the editor to display a context-sensitive menu with basic editing functions for the list, such as copy, paste, delete, undo and redo.

Remote command:

`SYSTem:SRECOder:DATA[:ALL]?` on page 1483

**Remove Last**

Deletes the last recorded SCPI command from the list.

 **Load Recording**

Loads an existing script in ASCII format (`*.inp`) from a file to the script editor. If the editor contains recorded commands, you must confirm a message to overwrite them. A file selection dialog box is displayed.

 **Save**

Saves the current SCPI command list to the currently loaded or most recently saved `.inp` recording file.

 **Save As**

Saves the current SCPI command list to a new file in the `C:\R_S\INSTR\ScpiRecordings` directory in ASCII format with the file extension `.inp`.

**Tip:** You can execute the command list in an `.inp` file without further editing using the IECWIN tool provided with the FSW, see [Chapter 12.4, "The IECWIN tool"](#), on page 837. You can also reload `.inp` files to the script editor later.

 **Export**

Exports the current SCPI command list to the specified file and directory in the selected format. By default, the file is stored in the `C:\R_S\INSTR\ScpiRecordings` directory. Besides the recorded commands themselves, the exported script includes all format-specific header data required to execute the script using an external program on the controller.

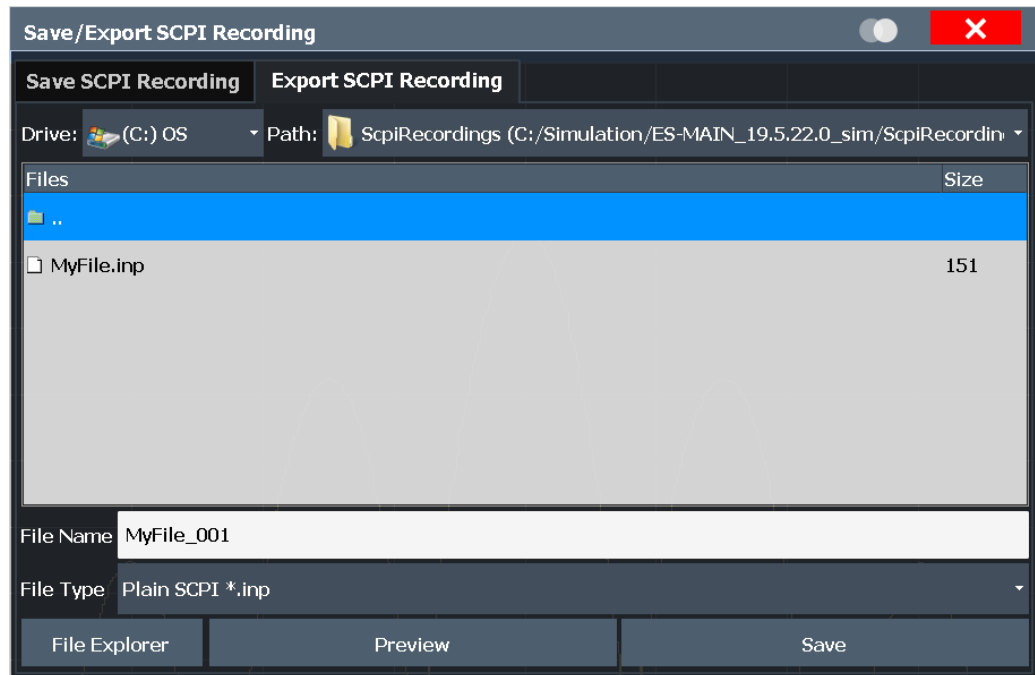

Before storing the file, you can display a **"Preview"** of the file in the selected format.

Currently, the following file formats are supported:

"C#" <ul style="list-style-type: none"> <li>A commonly used general programming language for various applications (*.cs)</li> </ul>	
"C++" <ul style="list-style-type: none"> <li>A commonly used general programming language for various applications (*.cpp)</li> </ul>	
"MATLAB (Instrument Control Toolbox)" <ul style="list-style-type: none"> <li>A programming environment, frequently used in signal processing and test and measurement applications (*.m)</li> <li>You can use this format directly with the MATLAB® Instrument Control Toolbox.</li> </ul>	
"MATLAB (R&S Toolkit)" <ul style="list-style-type: none"> <li>You can use this format directly with the MATLAB® Toolkit.</li> </ul>	
"NICVI" <ul style="list-style-type: none"> <li>An ANSI C programming environment designed for measurements and tests (*.cvi)</li> <li>You can use this format directly with National Instruments LabWindows CVI.</li> </ul>	
"Plain SCPI" <ul style="list-style-type: none"> <li>Represents SCPI base format, that is ASCII format, saved as a text file (*.inp); contains no additional header data</li> <li>Use this format to load a recorded script back to the editor later.</li> </ul>	
"Python" <ul style="list-style-type: none"> <li>A commonly used general programming language for various applications (.py)</li> </ul>	

Remote command:

[SYSTEM:SRECOOrder:EXPort](#) on page 1485

#### Clear All

Removes all recorded commands from the current SCPI command list.

Remote command:

`SYSTEM:SRERecorder:CLEar` on page 1483

### 12.5.2.2 Managing recordings

You can manage existing recordings in the `C:\R_S\INSTR\ScpiRecordings` directory directly from the SCPI recorder.

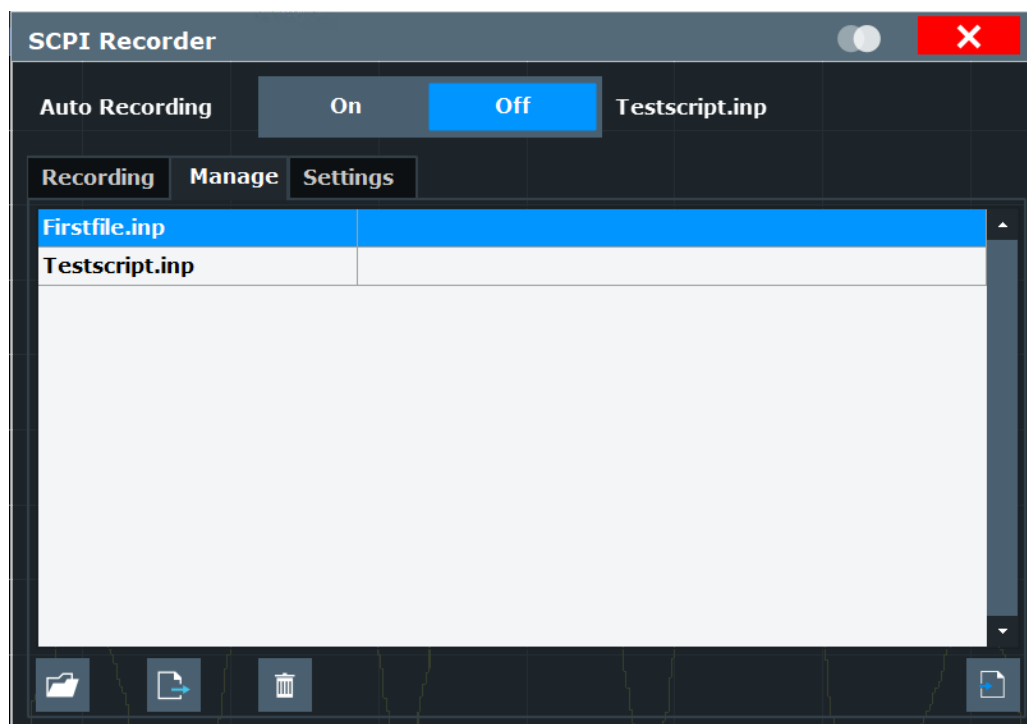

Load Recording.....	844
Export.....	844
Delete Recording.....	845
Import Recording.....	846

#### Load Recording

Loads an existing script in ASCII format (\*.inp) from a file to the script editor. If the editor contains recorded commands, you must confirm a message to overwrite them. A file selection dialog box is displayed.

#### Export

Exports the current SCPI command list to the specified file and directory in the selected format. By default, the file is stored in the `C:\R_S\INSTR\ScpiRecordings` directory. Besides the recorded commands themselves, the exported script includes all format-specific header data required to execute the script using an external program on the controller.

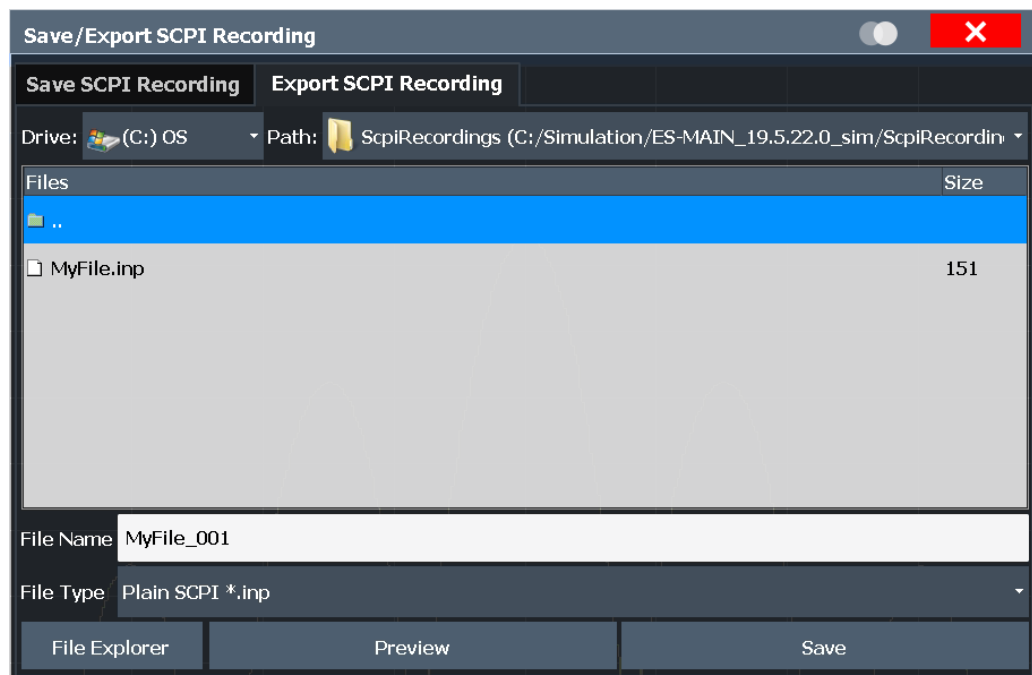

Before storing the file, you can display a **"Preview"** of the file in the selected format.

Currently, the following file formats are supported:

"C#" <ul style="list-style-type: none"> <li>A commonly used general programming language for various applications (*.cs)</li> </ul>	
"C++" <ul style="list-style-type: none"> <li>A commonly used general programming language for various applications (*.cpp)</li> </ul>	
"MATLAB (Instrument Control Toolbox)" <ul style="list-style-type: none"> <li>A programming environment, frequently used in signal processing and test and measurement applications (*.m)</li> <li>You can use this format directly with the MATLAB® Instrument Control Toolbox.</li> </ul>	
"MATLAB (R&S Toolkit)" <ul style="list-style-type: none"> <li>You can use this format directly with the MATLAB® Toolkit.</li> </ul>	
"NICVI" <ul style="list-style-type: none"> <li>An ANSI C programming environment designed for measurements and tests (*.cvi)</li> <li>You can use this format directly with National Instruments LabWindows CVI.</li> </ul>	
"Plain SCPI" <ul style="list-style-type: none"> <li>Represents SCPI base format, that is ASCII format, saved as a text file (*.inp); contains no additional header data</li> <li>Use this format to load a recorded script back to the editor later.</li> </ul>	
"Python" <ul style="list-style-type: none"> <li>A commonly used general programming language for various applications (.py)</li> </ul>	

Remote command:

[SYSTEM:SREcorder:EXPort](#) on page 1485

### Delete Recording

Deletes the selected recording file.

### Import Recording

Imports the specified file to the script editor.

#### 12.5.2.3 Recording settings

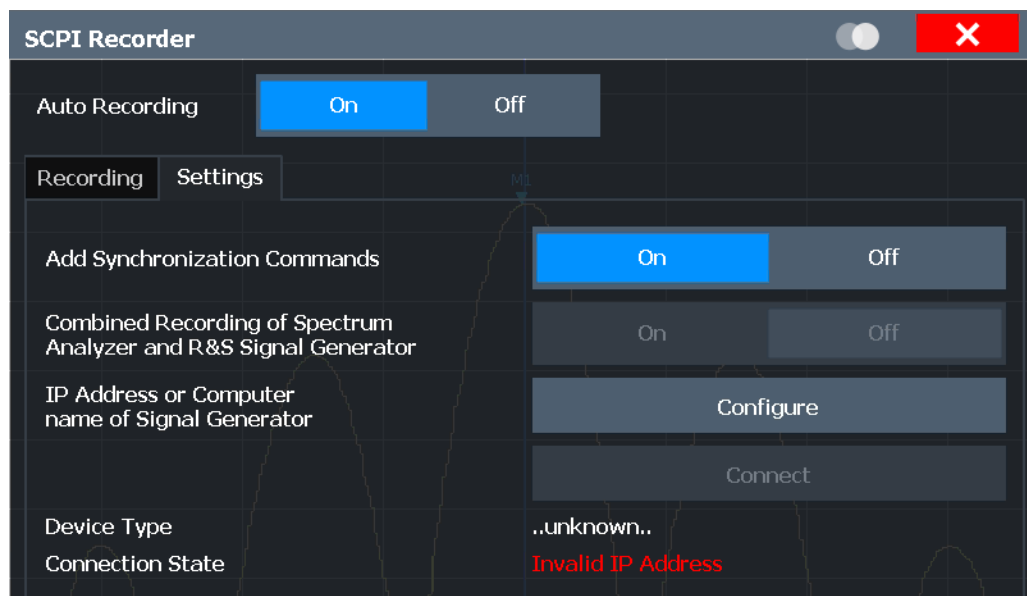

Some additional settings are available to configure the exported SCPI command files.

Add Synchronization Commands.....	846
Recording Format.....	846
Combined Recording of Spectrum Analyzer and R&S Signal Generator.....	847
IP Address or Computer name of Signal Generator.....	847
L 123/ABC.....	847
L Password.....	847
Test Connection.....	847

#### Add Synchronization Commands

If enabled, additional commands are included in the script to synchronize the recorded commands when necessary. For instance, when a measurement is started, a `*WAIT` command is inserted to ensure that the next command is only executed after the measurement has finished.

Remote command:

`SYSTEM:SREcorder:SYNC` on page 1487

#### Recording Format

Defines whether the commands are recorded using the short or long SCPI notation.

"Short"	The shortform of the keyword is used. Example: <code>FREQ:CENT</code>
"Long"	The entire keyword is used. Example: <code>FREQuency:CENTer</code>

Remote command:

[SYSTem:SRECOder:FORMat](#) on page 1486

### Combined Recording of Spectrum Analyzer and R&S Signal Generator

Records commands both from the FSW and from a connected Rohde & Schwarz signal generator.

Remote command:

[CONFigure:GENErator:RECOding:COMBine](#) on page 1487

### IP Address or Computer name of Signal Generator

The IP address or computer name of the signal generator connected to the FSW via LAN.

For tips on how to determine the default computer name, see [Chapter 4.3.2.21, "Device ID"](#), on page 61, or the signal generator's user documentation.

By default, the IP address is expected. To enter the computer name, toggle the "123"/"ABC" button to "ABC".

**Note:** While a connection to a signal generator is established, you cannot change the connection information.

The IP address / computer name is maintained after a [PRESET], and is transferred between applications. However, when you switch applications, the control is disabled in the other applications. Only one application can control a generator at any time.

Select ["Test Connection"](#) on page 794 to establish a temporary connection from the FSW to the specified signal generator.

If a connection to a signal generator is already configured, the connection data is provided for information only.

Remote command:

[CONFigure:GENErator:IPConnection:ADDRESS](#) on page 1455

### 123/ABC ← IP Address or Computer name of Signal Generator

By default, the TCPIP address is expected. To enter the computer name, toggle the "123"/"ABC" button to "ABC".

### Password ← IP Address or Computer name of Signal Generator

Enter the password required to operate the connected signal generator.

### Test Connection

The FSW attempts to establish a connection to the signal generator.

If an instrument is connected, the following information is displayed:

- Device type
- Name and serial number
- Connection state

Remote command:

[CONFigure:GENErator:CONNECTION:CSTATE?](#) on page 1454

[CONFigure:GENErator:CONNECTION\[:STATE\]](#) on page 1454

### 12.5.3 How to determine the required SCPI command

The SCPI Recorder provides information on the required SCPI command for the available measurement settings, functions, and results in a context-sensitive menu.

1. Define the setting or navigate to the function you need the SCPI command for. To find the query command for trace or marker results, select the result diagram.
2. On the screen, tap and hold, or right-click the measurement setting, function, or result display.

The context-sensitive menu for that particular setting, function, or result is displayed.

**Tip:** If the SCPI command menu is not displayed, you probably tapped outside of a softkey or input field, for example in a block diagram. Tap within the corresponding softkey, button or input field, or in a result display, to display the context-sensitive SCPI command menu.

3. Select "Show SCPI result query commands" or "Show SCPI command", depending on which item you selected.

A dialog box with the required command and some functions is displayed. If multiple commands are possible, for example to query different measurement results, all possible commands are displayed.

4. To display the SCPI command dialog box for a query command, select the query command you are interested in from the list.

### 12.5.4 How to create and export SCPI scripts

Using the SCPI Recorder functions, you can create a SCPI script directly on the instrument and then export the script for use on the controller. The SCPI Recorder allows you to record SCPI command lists either automatically or manually.

#### How to record SCPI commands automatically

The following procedure explains how to record SCPI commands automatically during operation.



1. On the toolbar, select the SCPI Recorder icon.  
The SCPI Recorder dialog box is displayed.
2. Select "Auto Recording": "On".  
From now on, the commands required to execute all steps you perform on the instrument are recorded.
3. To query results in the SCPI script:
  - a) Right-click (or tap and hold) in the result display.  
All possible commands to query the results in the diagram are displayed in the SCPI command menu.
  - b) Select the results you want to query.



- c) Select "Add SCPI Command to Recording".
4. To stop SCPI recording, select the SCPI Recorder icon again.  
The SCPI Recorder dialog box with the recorded command list is displayed.
5. Select "Auto Recording": "Off".
6. Save the recorded command list to a file for later use.
  - a) Select "Save As".
  - b) Define a file name for the script file.

### How to record SCPI commands manually

1. Determine the required SCPI command as described in [Chapter 12.5.3, "How to determine the required SCPI command"](#), on page 848.
2. From the SCPI command dialog box, select "Add SCPI Command to Recording".  
The command is added to the SCPI Recorder command list.
3. Repeat these steps for any settings, functions, or results you want to record.



4. To check the progress of the recording, select the SCPI Recorder icon in the toolbar.  
The SCPI Recorder dialog box with the currently recorded command list is displayed.
5. Save the recorded command list to a file for later use.
  - a) Select "Save As".
  - b) Define a file name for the script file.

### To edit a SCPI command list

All command lists can be edited after recording, either directly on the instrument or in any suitable editor on the controller. The following functions describe how to edit the SCPI command list directly in the SCPI Recorder dialog box.



1. On the toolbar, select the SCPI Recorder icon.  
The SCPI Recorder dialog box with the currently recorded command list is displayed.



2. To load a stored script in ASCII format:
  - a) Select "Load Recording" in the SCPI Recorder dialog box.
  - b) If necessary, confirm the message to overwrite existing commands in the editor.
  - c) Select the stored \*.inp file.
  - d) Select "Select".

The stored commands are displayed in the editor.

3. To remove the most recently recorded command, select "Remove Last" in the SCPI Recorder dialog box.

4. To remove any other command in the recorded command list:
  - a) Select the command by tapping it or using the arrow keys.
  - b) Press [BACK SPACE] on the front panel of the instrument, or press [Delete] on a connected keyboard.
5. To insert a command within the recorded command list:
  - a) Define the setting or navigate to the function you want to record.
  - b) Select "Copy SCPI Command to ClipBoard".
  - c) Tap and hold or right-click the position in the SCPI command list at which you want to insert the new command.
  - d) From the context menu, select "Paste".
6. Select "Save As" to store the changes to the script.

### How to check a SCPI script

The easiest way to check a script is to execute it, for example in the auxiliary tool IECWIN, which is provided with the FSW firmware (see [Chapter 12.4, "The IECWIN tool"](#), on page 837).

The tool shows an error message if a command could not be executed.

Some suggestions on how you can check and improve a recorded SCPI script:

- Remove unnecessary commands written after a preset.
- Rearrange the commands to a reasonable order. For example, if you move a `STATE` command to the end of your script, you can avoid intermediate calculations of the signal.
- Check the script for completeness by comparing its results with the modified settings in manual mode.

### How to export a SCPI script

When you save a command list to a file, only the recorded commands are stored in a text file. However, to execute a script in an external programming environment, it requires additional header data according to the specific format.



1. On the toolbar, select the SCPI Recorder icon.

The SCPI Recorder dialog box with the currently recorded command list is displayed.



2. Select "Export".
3. Define a file name and storage location for the script file.
4. Select the "File Type" which defines the format of the script.
5. Select "Save".

A script with the required header data for the selected format is stored to a file.

### 12.5.5 Example for a recorded SCPI script

The following example shows a recorded SCPI script in python format. The script configures the ACLR measurement example described in [Chapter 6.2.7.1, "Measurement example 1 – ACPR measurement on a CDMA2000 signal"](#), on page 197.

```
# python script created by FSW: 29:11:2017 09:08:53

import visa

# connect to instrument (MU717225)
VisaResourceManager = visa.ResourceManager()
FSW = VisaResourceManager.open_resource("TCPIP::10.124.0.195::INSTR")

# Display update ON
FSW.write("SYST:DISP:UPD ON")

FSW.write("*RST")
FSW.write("INIT:CONT OFF")
FSW.write("SENS:FREQ:CENT 850000000")
FSW.write("SENS:FREQ:SPAN 4000000")
FSW.write("DISP:WIND:SUBW:TRAC:Y:SCAL:RLEV 10")
FSW.write("CALC:MARK:FUNC:POW:SEL ACP")
FSW.write("CALC:MARK:FUNC:POW:PRES S2CD")
FSW.write("SENS:ADJ:LEV;*WAI")
FSW.write("SENS:POW:HSP ON")
FSW.write("TRAC1:DATA? TRACE1")
FSW.query("CALC1:MARK:Y?")
FSW.write("CALC1:MARK:FUNC:POW:RES? CPOW")

# Back to local mode
FSW.write("SYST:COMM:INT:REM OFF")
```

## 12.6 Network and remote control settings

**Access:** [SETUP] > "Network + Remote"



### Network settings in secure user mode

Be sure to store all network settings before [SecureUser Mode](#) is enabled; see [Chapter 4.2.15, "Protecting data using the secure user mode"](#), on page 39.

If the currently stored network settings are not suitable, you must correct them each time you switch on the FSW in secure user mode, as the settings are not stored permanently in this case.

The remote commands required to define these settings are described in [Chapter 13.10.7, "Configuring the network and remote control"](#), on page 1433.

Step-by-step instructions are provided in [Chapter 12.7, "How to set up a network and remote control"](#), on page 870.

• <a href="#">General network settings</a> .....	852
• <a href="#">GPIB settings</a> .....	854
• <a href="#">Compatibility settings</a> .....	857
• <a href="#">LAN settings</a> .....	861
• <a href="#">HUMS settings</a> .....	862
• <a href="#">Remote errors</a> .....	868
• <a href="#">Returning to manual mode ("local")</a> .....	870

### 12.6.1 General network settings

**Access:** [SETUP] > "Network + Remote" > "Network" tab

The FSW can be operated in a local area network (LAN), for example to control the instrument from a remote PC or use a network printer.



Network settings can only be edited in the firmware if a LAN cable is connected to the FSW.

#### **NOTICE**

##### **Risk of network problems**

All parameters can be edited here; however, beware that changing the computer name has major effects in a network.

For details, see [Chapter 12.7, "How to set up a network and remote control"](#), on page 870.



##### **Network settings in secure user mode**

Be sure to store all network settings before [SecureUser Mode](#) is enabled; see [Chapter 4.2.15, "Protecting data using the secure user mode"](#), on page 39.

If the currently stored network settings are not suitable, you must correct them each time you switch on the FSW in secure user mode, as the settings are not stored permanently in this case.

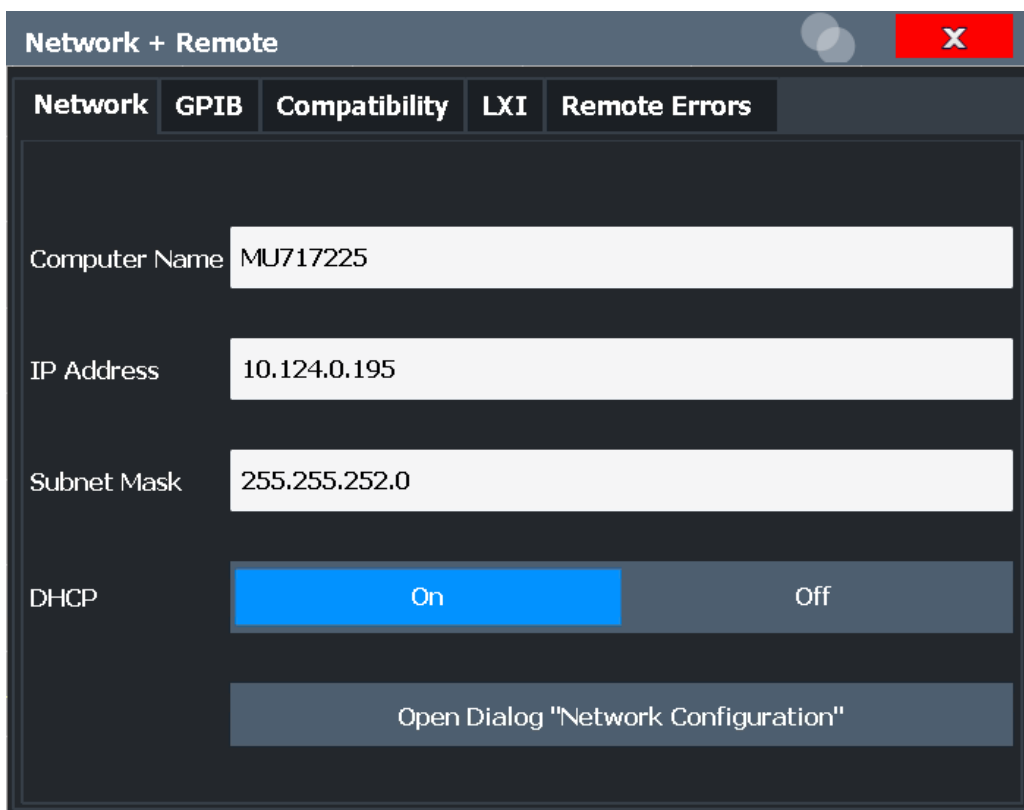

Computer Name.....853  
 IP Address.....854  
 Subnet Mask.....854  
 DHCP.....854  
 Network Configuration.....854

**Computer Name**

Each instrument is delivered with an assigned computer name, but this name can be changed. The naming conventions of Windows apply. If too many characters and/or numbers are entered, an error message is displayed in the status line.

The default instrument name is a non-case-sensitive string with the following syntax:

<Type><variant>-<serial\_number>

For example FSW13-123456

The serial number can be found on the rear panel of the instrument. It is the third part of the device ID printed on the bar code sticker:



**IP Address**

Defines the IP address. The TCP/IP protocol is preinstalled with the IP address 10.0.0.10. If the DHCP server is available ("DHCP On"), the setting is read-only.

The IP address consists of four number blocks separated by dots. Each block contains 3 numbers in maximum (e.g. 100.100.100.100), but also one or two numbers are allowed in a block (as an example see the preinstalled address).

**Subnet Mask**

Defines the subnet mask. The TCP/IP protocol is preinstalled with the subnet mask 255.255.255.0. If the DHCP server is available ("DHCP On"), this setting is read-only.

The subnet mask consists of four number blocks separated by dots. Each block contains 3 numbers in maximum (e.g. 100.100.100.100), but also one or two numbers are allowed in a block (as an example see the preinstalled address).

**DHCP**

Switches between DHCP server available (On) or not available (Off). If a DHCP server is available in the network, the IP address and subnet mask of the instrument are obtained automatically from the DHCP server.

**Network Configuration**

Opens the standard Windows "Network Configuration" dialog box for further configuration.

## 12.6.2 GPIB settings

**Access:** [SETUP] > "Network + Remote" > "GPIB" tab

Alternatively to connecting the FSW to a LAN, the GPIB interface can be used to connect a remote PC. For details see [Chapter 12.1, "Remote control interfaces and protocols"](#), on page 816).

Network	GPIB	Compatibility	LXI	Remote Errors
GPIB Address	18			
Identification String	arz,FSW-26,1312.8000K26/100005,4.50-19.8.4.0 Beta			
	Reset to Factory String			
Remote Display Update	On	Off		
GPIB Terminator	LFEOI	EOI		
*IDN Format	New	Legacy		
I/O Logging	On	Off		
Display Remote Errors	On	Off		
Set Hardware Immediately	On	Off		

GPIB Address..... 855  
 Identification String.....855  
 Reset to Factory String..... 855  
 Remote Display Update..... 856  
 GPIB Terminator.....856  
 \*IDN Format..... 856  
 I/O Logging.....856  
 Display Remote Errors..... 857  
 Set Hardware Immediately..... 857

**GPIB Address**

Defines the GPIB address. Values from 0 to 30 are allowed. The default address is 20.

Remote command:

`SYSTem:COMMunicate:GPIB[:SELF]:ADDRess` on page 1433

**Identification String**

Defines the identification string for the FSW which is provided as a response to the \*IDN? query. Maximum 36 characters are allowed.

Remote command:

`SYSTem:IDENTify[:STRing]` on page 1435

**Reset to Factory String**

Restores the default identification string. Each FSW has a unique ID according to the following syntax:

Rohde&Schwarz,FSW,<Unique number>,1.00

Remote command:

[SYSTem:IDENTify:FACTory](#) on page 1435

### Remote Display Update

Defines whether the display of the FSW is updated when changing from manual operation to remote control.

Turning off the display update function improves performance during remote control.

**Note:** Usually, this function remains available on the display during remote operation. However, it can be disabled remotely. In this case, the display is not updated during remote operation, and cannot be turned on again locally until local operation is resumed.

Remote command:

[SYSTem:DISPlay:UPDate](#) on page 1435

[SYSTem:DISPlay:LOCK](#) on page 1434

### GPIB Terminator

Changes the GPIB receive terminator.

"LFEOI" According to the standard, the terminator in ASCII is <LF> and/or <EOI>.

"EOI" For binary data transfers (e.g. trace data) from the control computer to the instrument, the binary code used for <LF> might be included in the binary data block, and therefore should not be interpreted as a terminator in this particular case. This can be avoided by using only the receive terminator `EOI`.

Remote command:

[SYSTem:COMMunicate:GPIB\[:SELF\]:RTERminator](#) on page 1433

### \*IDN Format

Defines the response format to the remote command `*IDN?` (see [\\*IDN?](#) on page 894). This function is intended for re-use of existing control programs together with the FSW.

"Leg" Legacy format, as in the R&S FSP/FSU/FSQ family.

"New" FSW format.

Remote command:

[SYSTem:FORMat:IDENT](#) on page 1450

### I/O Logging

Activates or deactivates the SCPI error log function. All remote control commands received by the FSW are recorded in a log file. The files are named according to the following syntax:

```
C:\R_S\INSTR\ScpiLogging\ScpiLog.<no.>
```

where <no.> is a sequential number

A new log file is started each time logging was stopped and is restarted.

Logging the commands may be extremely useful for debug purposes, e.g. in order to find misspelled keywords in control programs.



Remote command:

[SYSTem:CLOGging](#) on page 1482

### Display Remote Errors

Activates and deactivates the display of errors that occur during remote operation of the FSW. If activated, the FSW displays a message box at the bottom of the screen that contains the type of error and the command that caused the error.



The error message remains in place when you switch to "Local" mode. To close the message box, select the  "Close" icon.

Only the most recent error is displayed in remote mode. However, in local mode, all errors that occurred during remote operation are listed in a separate tab of the "Network + Remote" dialog box (see [Chapter 12.6.6, "Remote errors"](#), on page 868).

Remote command:

[SYSTem:ERRor:DISPlay](#) on page 1435

[SYSTem:ERRor:CLEar:REMote](#) on page 1448

### Set Hardware Immediately

Determines when the remote commands that change hardware settings on the FSW are executed.

If enabled (default), remote commands are always executed immediately when they are received by the instrument.

If disabled, remote commands that cause changes to the hardware are only executed when an appropriate command is executed explicitly.

Regardless of this setting, the firmware automatically sets the hardware when a sweep is started.

Postponing hardware changes is useful, for example, when switching measurement channels. When you switch channels, the settings from the previous channel are used by default. However, if you have to change the frequency and level values for the new channel measurement, the default settings cause unnecessary hardware settling times.

This setting is not changed by the preset function.

Remote command:

[SYSTem:SHIMmediate:STATe](#) on page 1437

[SYSTem:SHIMmediate ONCE](#) on page 1437

## 12.6.3 Compatibility settings

The FSW can emulate the GPIB interface of other signal and spectrum analyzers, e.g. in order to use existing control applications.



**Compatibility with former R&S signal and spectrum analyzers**

As a rule, the FSW supports most commands from previous R&S signal and spectrum analyzers such as the FSQ, FSP, FSU, or FSV. However, the default values, in particular the number of sweep points or particular bandwidths, may vary. Therefore, the FSW can emulate these other devices, including their default values, in order to repeat previous measurements or support existing control applications as in legacy systems.

The required settings are configured in the "Compatibility" tab of the "Network + Remote" dialog box.

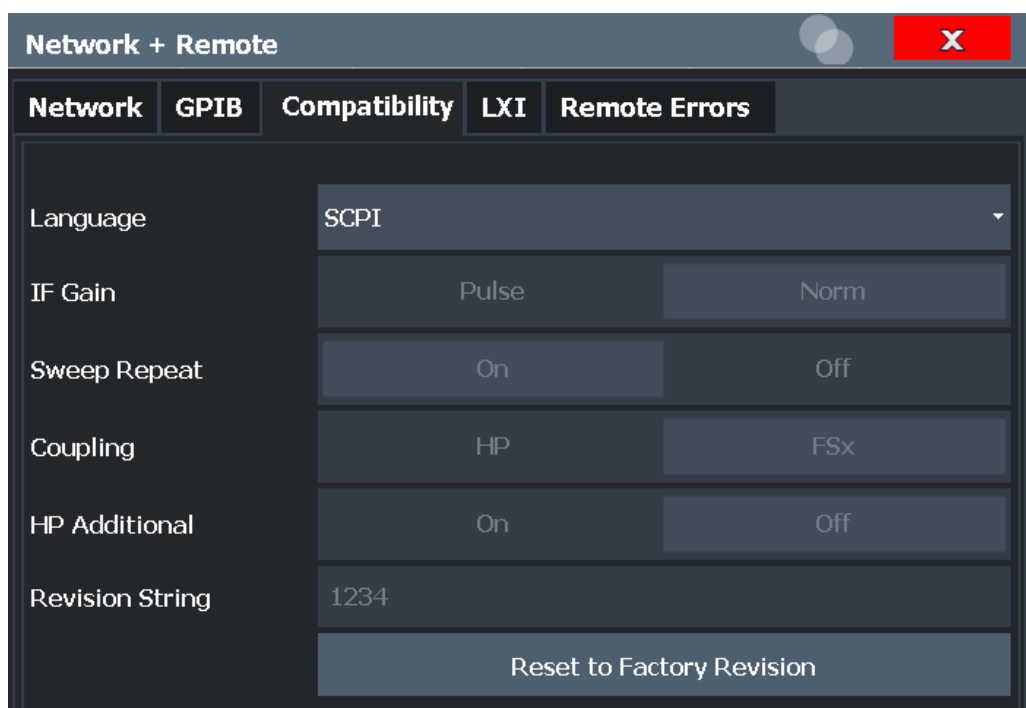

Language..... 858  
 IF Gain..... 859  
 Sweep Repeat..... 859  
 Coupling..... 859  
 Wideband..... 860  
 FSU/FSQ Preamplifier..... 860  
 HP Additional..... 860  
 Revision String..... 860  
 Resetting the Factory Revision..... 860

**Language**

Defines the system language used to control the instrument.

For details on the available GPIB languages, see [Chapter 13.14.2, "Reference: GPIB commands of emulated HP models"](#), on page 1491.

**Note:** This function is also used to emulate previous R&S signal and spectrum analyzers.

As a rule, the FSW supports most commands from previous R&S signal and spectrum analyzers such as the FSQ, FSP, FSU, or FSV. However, the default values, in particular the number of sweep points or particular bandwidths, may vary. Therefore, the FSW can emulate these other devices, including their default values, in order to repeat previous measurements or support existing control applications as in legacy systems.

For R&S FSP/FSQ/FSU emulation, HP commands are not automatically also allowed. In this case, set `SYSTem:HPADditional` to ON.

**Note:** For PSA89600 emulation, the option is indicated as "B7J" for the `*OPT?` query ("B7J, 140" or "B7J, 122" if `Wideband` is activated, see `SYSTem:PSA:WIDeband` on page 1490).

Remote command:

`SYSTem:LANGuage` on page 1489

### IF Gain

Configures the internal IF gain settings in HP emulation mode due to the application needs. This setting is only taken into account for resolution bandwidth < 300 kHz.

NORM	Optimized for high dynamic range, overload limit is close to reference level.
PULS	Optimized for pulsed signals, overload limit up to 10 dB above reference level.

This setting is only available if an HP language is selected (see `"Language"` on page 858).

Remote command:

`SYSTem:IFGain:MODE` on page 1489

### Sweep Repeat

Controls a repeated sweep of the E1 and MKPK HI HP model commands (for details on the commands refer to [Chapter 13.14.2, "Reference: GPIB commands of emulated HP models"](#), on page 1491). If the repeated sweep is OFF, the marker is set without sweeping before.

**Note:** In single sweep mode, switch off this setting before you set the marker via the E1 and MKPK HI commands in order to avoid sweeping again.

This setting is only available if a HP language is selected (see `"Language"` on page 858).

Remote command:

`SYSTem:RSweep` on page 1491

### Coupling

Controls the default coupling ratios in the HP emulation mode for:

- span and resolution bandwidth (Span/RBW)
- resolution bandwidth and video bandwidth (RBW/VBW)

For FSx, the standard parameter coupling of the instrument is used. As a result, in most cases a shorter sweep time is used than in case of HP.

This setting is only available if a HP language is selected (see `"Language"` on page 858).

Remote command:

[SYSTem:HPCoupling](#) on page 1488

### Wideband

This setting defines which option is returned when the \*OPT? query is executed, depending on the state of the wideband option.

It is only available for PSA89600 emulation.

"Off"	No wideband is used. The option is indicated as "B7J".
"40 MHz"	The 40 MHz wideband is used. The option is indicated as "B7J, 140".
"80 MHz"	The 80 MHz wideband is used. The option is indicated as "B7J, 122".

Remote command:

[SYSTem:PSA:WIDeband](#) on page 1490

### FSU/FSQ Preamp

This setting defines which option is returned when the \*OPT? query is executed, depending on the used preamp.

It is only available for FSU/FSQ emulation, and only if a preamp is used by the FSW (-B24/-B25 option).

Remote command:

[SYSTem:PREamp](#) on page 1490

### HP Additional

Allows the use of HP commands *in addition to* SCPI commands for R&S FSP/FSQ/FSU emulation (see [Language](#)).

Remote command:

[SYSTem:HPADditional](#) on page 1489

### Revision String

Defines the response to the REV? query for the revision number.

(HP emulation only, see [Language](#) on page 858).

Max. 36 characters are allowed.

Remote command:

[SYSTem:REVision\[:STRing\]](#) on page 1491

### Resetting the Factory Revision

Resets the response to the REV? query for the revision number to the factory default (HP emulation only, see [Language](#) on page 858).

Remote command:

[SYSTem:REVision:FACTory](#) on page 1436

### 12.6.4 LAN settings

**Access:** [SETUP] > "Network + Remote" > "LAN" tab

In a LAN network, the FSW can be accessed via any web browser (e.g. the Microsoft Internet Explorer) to perform the following tasks:

- Modifying network configurations
- Modifying device configurations
- Monitoring connections from the device to other devices

The "LAN" tab of the "Network + Remote" dialog box provides basic LAN configuration functions and information for the FSW.

Alternatively, you can change the LAN settings using the web browser interface.

For details see "[LAN configuration](#)" on page 876.

Only user accounts with administrator rights are able to use LAN configuration and web browser functionality.

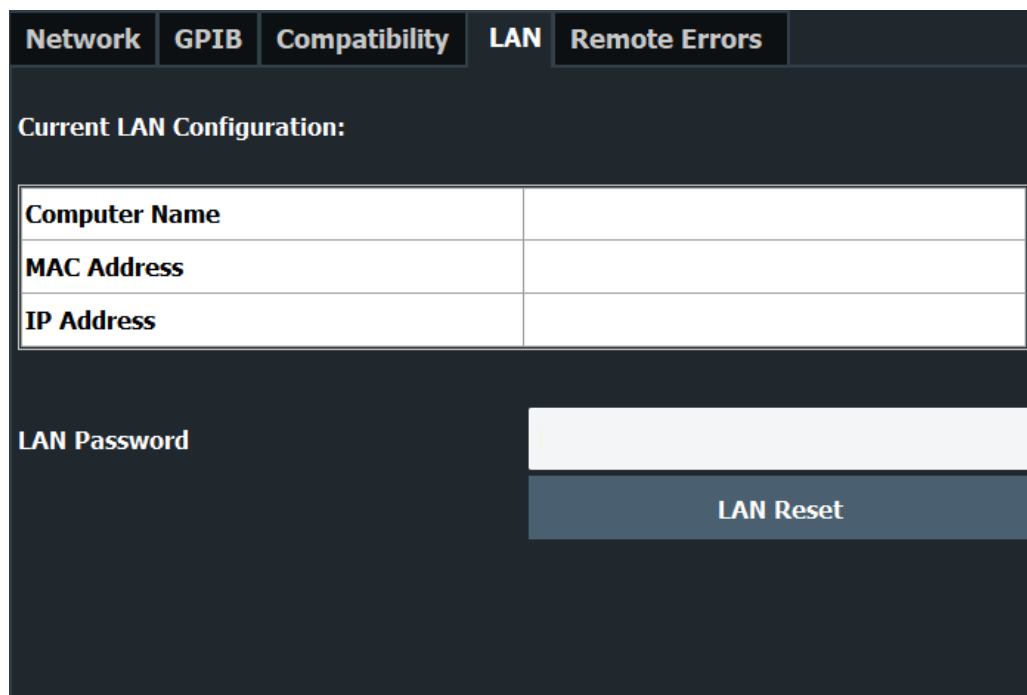

<a href="#">Current LAN Configuration</a> .....	861
<a href="#">LAN Password</a> .....	862
<a href="#">LAN Reset</a> .....	862

#### Current LAN Configuration

Displays the current LAN information from the FSW (read-only).

- "Computer name" Name of the FSW as defined in the operating system (see also "[Computer Name](#)" on page 853)
- "MAC address" Media Access Control address (MAC address), a unique identifier for the network card in the FSW

"IP address" IP address of the FSW as defined in the operating system (see also "IP Address" on page 854).

#### LAN Password

Password for LAN configuration. The default password is *LxiWeblfc*.

Remote command:

[SYSTem:LXI:PASSword](#) on page 1436

#### LAN Reset

Resets the "LAN" configuration to its default settings (LCI function).

Parameter	Value
TCP/IP Mode	DHCP + Auto IP Address
Dynamic DNS	Enabled
ICMP Ping	Enabled
Password for "LAN" configuration	LxiWeblfc

The LAN settings are configured in the "Network" tab of the "Network + Remote" dialog box or using the instrument's "LAN" web browser interface.

Remote command:

[SYSTem:LXI:LANReset](#) on page 1436

## 12.6.5 HUMS settings

Available with option R&S FSW-K980.

The FSW comes with a health and utilization monitoring system (HUMS) providing information about the FSW. The aim is to increase the overall utilization, to avoid downtime and to increase the overall security level of a fleet of instruments.

HUMS provides, for example, information about:

- Instrument identification, hardware components, software packages, licenses
- Usage of remote control, usage via keyboard / mouse, usage of test applications
- Hardware utilization and status, including S.M.A.R.T. data of the system drive
- User-defined static information, for example, an inventory code

#### Interfaces and protocols

The HUMS installation on the FSW includes an SNMP agent and a REST service with HTTP endpoints. So you can access the health and usage information via LAN, using the SNMP protocol or the REST protocol. Accessing the data does not interfere with remote control via SCPI commands or with measurement execution.

Reference information for both protocols is available on the FSW at the address <http://<instrument>/api/hums/v1/documents?name=<interface>>.

For *<instrument>*, enter the host name (e.g. *fsw8-123456*) or the IP address (e.g. *10.121.0.34*) of your instrument, as for access to the GUI.

For *<interface> = snmp*, you get a .zip file containing the MIB files for SNMP. For *<interface> = rest*, you get a .yaml file with the OpenAPI specification of the REST API.

Address example: *http://fsw8-123456/api/hums/v1/documents?name=snmp*.

The following table lists the REST endpoints and the SNMP MIB filenames.

For further information about the HUMS service itself, see R&S HUMS user manual. You can download or view the manual [on the internet](#).

- [Basic settings](#).....863
- [Protocol settings](#).....864
- [Device tags](#).....867

### 12.6.5.1 Basic settings

**Access:** [SETUP] > "Network + Remote" > "HUMS" tab

The "HUMS" tab of the "Network + Remote" dialog provides basic R&S HUMS configuration functions.

To export the complete HUMS history, use the REST API with the endpoint:

`http://<IP>/api/hums/v1/dump`

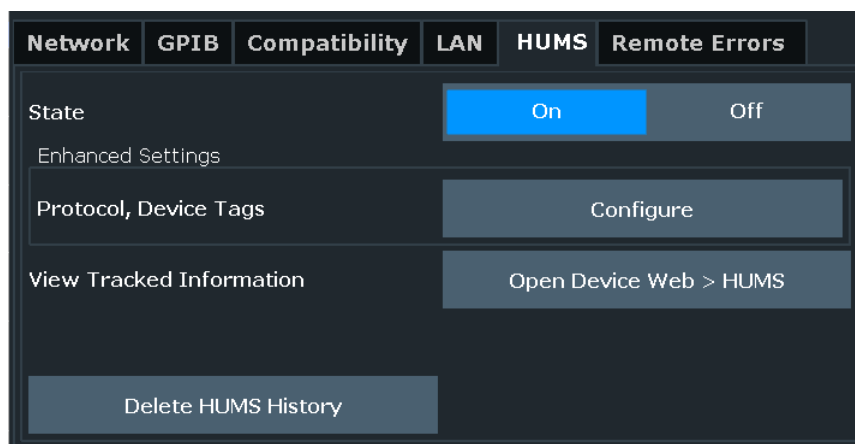

The remote commands to configure HUMS are described in [Chapter 13.10.8, "Configuring HUMS"](#), on page 1438.

- [State](#).....863
- [Enhanced Settings](#).....864
- [View Tracked Information](#).....864
- [Delete HUMS History](#).....864

#### State

Turns HUMS on or off.

If you want to track HUMS data, turn on this function.

If HUMS has been used before, turning on restores the previous [protocol settings](#).

Remote command:

[DIAGnostic:HUMS:STATE](#) on page 1439

**Enhanced Settings**

Opens the dialog to configure the [protocol settings](#) and [device tags](#).

**View Tracked Information**

Opens the R&S HUMS device web in the web browser of the FSW.

For more information about the R&S HUMS device web, see its user manual.

You can also reach the device web from a remote PC by entering the following address into a browser's address bar:

<http://<instrumentaddress>/hums/>

The <instrumentaddress> is either the IP address of the instrument or the instrument name.

**Delete HUMS History**

Deletes complete HUMS data which includes the device history, device tags, SCPI connections, utilization history, utilization (table values).

Remote command:

[DIAGnostic:HUMS:DElete:ALL](#) on page 1438

**12.6.5.2 Protocol settings**

**Access:** [SETUP] > "Network + Remote" > "HUMS" > "Enhanced Settings" > "Configure" > "Protocol"

The "Protocol" tab of the "Enhanced Settings" dialog provides protocol settings for SNMP or REST protocol.

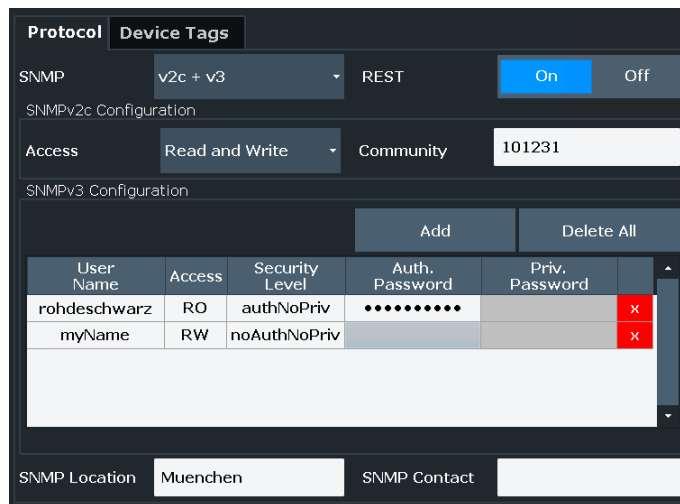

[SNMP](#) ..... 865

[REST](#) ..... 865

[SNMPv2c Configuration](#) ..... 865

    L [Access](#) ..... 865



L Community.....	865
SNMPv3 Configuration.....	866
L User Name.....	866
L Access.....	866
L Security Level.....	866
L Passwords.....	866
SNMP Location.....	867
SNMP Contact.....	867

## SNMP

Selects the SNMP version to communicate with the service.

"None"	Do not use SNMP.
"v2c"	Select SNMP version v2c, which also activates v1. Unlocks the <a href="#">settings</a> available for SNMP v2c.
"v3"	Select SNMP version v3. Unlocks the <a href="#">settings</a> available for SNMP v3.
"v2c + v3"	Select both SNMP versions v2c and v3. Unlocks the settings for both SNMP v2c and v3.

Remote command:

[SYSTem:COMMunicate:SNMP:VERSion](#) on page 1443

## REST

Turns communication via REST API on or off.

Remote command:

[SYSTem:COMMunicate:REST:ENABLE](#) on page 1440

## SNMPv2c Configuration

For SNMPv2c/v1 authentication, you can define the "Access" and "Community".

### Access ← SNMPv2c Configuration

Defines the access an SNMP user can have for a specific SNMP community: read-write = RW, read-only = RO.

"RW"	Read-write access allows the user to read and change information. By default, the user has read-write access rights.
"RO"	Read-only access allows the user to only read information.

Remote command:

[SYSTem:COMMunicate:SNMP:COMMunity:RO](#) on page 1441

[SYSTem:COMMunicate:SNMP:COMMunity:RW](#) on page 1441

### Community ← SNMPv2c Configuration

Defines the SNMP community string. An SNMP community represents a collection of devices and agents grouped to monitor them. Authorized managers and the managed devices belong to an SNMP community.

You can define an individual community for each read-write and read-only access.

The default community is the serial number of the instrument (same community for read-only and for read-write).

Entering a community is mandatory.

### SNMPv3 Configuration

For SNMPv3 authentication, you can define user profiles. You can manage them via a table.

To add a new user, select "Add" and enter the data.

To delete all user profiles, select "Delete All".

To delete a single user profile, select the "x" in the appropriate user line of the table.

Remote command:

Create user: `SYSTem:COMMunicate:SNMP:USM:USER` on page 1442

Query all users: `SYSTem:COMMunicate:SNMP:USM:USER:ALL?` on page 1442

Delete a single user: `SYSTem:COMMunicate:SNMP:USM:USER:DELeTe`  
on page 1443

Delete all users: `SYSTem:COMMunicate:SNMP:USM:USER:DELeTe:ALL`  
on page 1443

### User Name ← SNMPv3 Configuration

Defines the name of the user who should have specific user rights.

Entering a user name is mandatory.

### Access ← SNMPv3 Configuration

Defines the access right a user can have: read-write = RW, read-only = RO.

"RW" Read-write access allows the user to read and change information.

"RO" Read-only access allows the user to only read information.

### Security Level ← SNMPv3 Configuration

Defines the security level for access: noAuthNoPriv, authNoPriv or authPriv.

For security reasons, we recommend that you only allow access via passwords.

"noAuthNo-Priv" Low security level: no authentication, no data transfer encryption, user name query only.  
No [authentication password](#) and no [privacy password](#) to be defined.

"authNoPriv" Medium security level: authentication, no data transfer encryption, user name and password query.  
Authentication password to be defined, privacy password is not available.

"authPriv" High security level: authentication, data transfer encryption, user name, password and encryption password query.  
Authentication password and privacy password to be defined.  
If no privacy password is defined, the HUMS service uses the authentication password as privacy password.

### Passwords ← SNMPv3 Configuration

Depending on the selected [Security Level](#), you have to define specific passwords: authentication password (Auth. Password) and privacy password (Priv. Password).

- "Auth. Password" For authentication, you have to define an authentication password. For authentication password, the FSW supports the MD5 protocol. Authentication passwords must have 8 to 12 characters with any combination of ASCII characters.
- "Priv. Password" For stronger encryption, you have to define a second password, the privacy password. For privacy password, the FSW supports the DES protocol. Private passwords must have at least 8 characters with any combination of ASCII characters.

**SNMP Location**

"SNMP Location" defines the SNMP location information. This information complies with the server's physical location and is used for identification of the SNMP server. By default, this input field is empty.

Remote command:

[SYSTem:COMMunicate:SNMP:LOCation](#) on page 1442

**SNMP Contact**

"SNMP Contact" defines the SNMP contact information. This information complies with the person who manages the SNMP server and is used for identification of the SNMP server. By default, this input field is empty.

Remote command:

[SYSTem:COMMunicate:SNMP:CONtact](#) on page 1441

**12.6.5.3 Device tags**

**Access:** [SETUP] > "Network + Remote" > "HUMS" > "Enhanced Settings" > "Configure" > "Device Tags"

The "Device Tags" tab of the "Enhanced Settings" dialogs displays the defined device tags. You can also add or delete device tags here.

A device tag is a label to assign to your instrument. You can create any device tag for your instrument and define it by a specific key and value.



[Add](#).....868

[Index](#)..... 868

[Key](#).....868

[Value](#)..... 868

[Delete All](#).....868

**Add**

Adds a new device tag.

Remote command:

[DIAGnostic:HUMS:TAGS\[:VALue\]](#) on page 1440

**Index**

Index (ID) of the created device tag. You can change the ID if necessary.

**Key**

Defines a key for your device tag. A device tag key represents the type of tag.

**Value**

Defines the actual value of the device tag or key.

**Example:**

- "Key" = Location
- "Value" = Building 1

Remote command:

[DIAGnostic:HUMS:TAGS:ALL?](#) on page 1439

**Delete All**

Deletes all defined device tags.

Remote command:

Delete all device tags:[DIAGnostic:HUMS:TAGS:DELeTe:ALL](#) on page 1439

Delete a single device tag:[DIAGnostic:HUMS:TAGS:DELeTe](#) on page 1440

## 12.6.6 Remote errors

**Access:** [SETUP] > "Network + Remote" > "Remote Errors" tab

The error messages generated by the FSW during remote operation are displayed here.

The messages are displayed in the order of their occurrence; the most recent messages are placed at the top of the list.

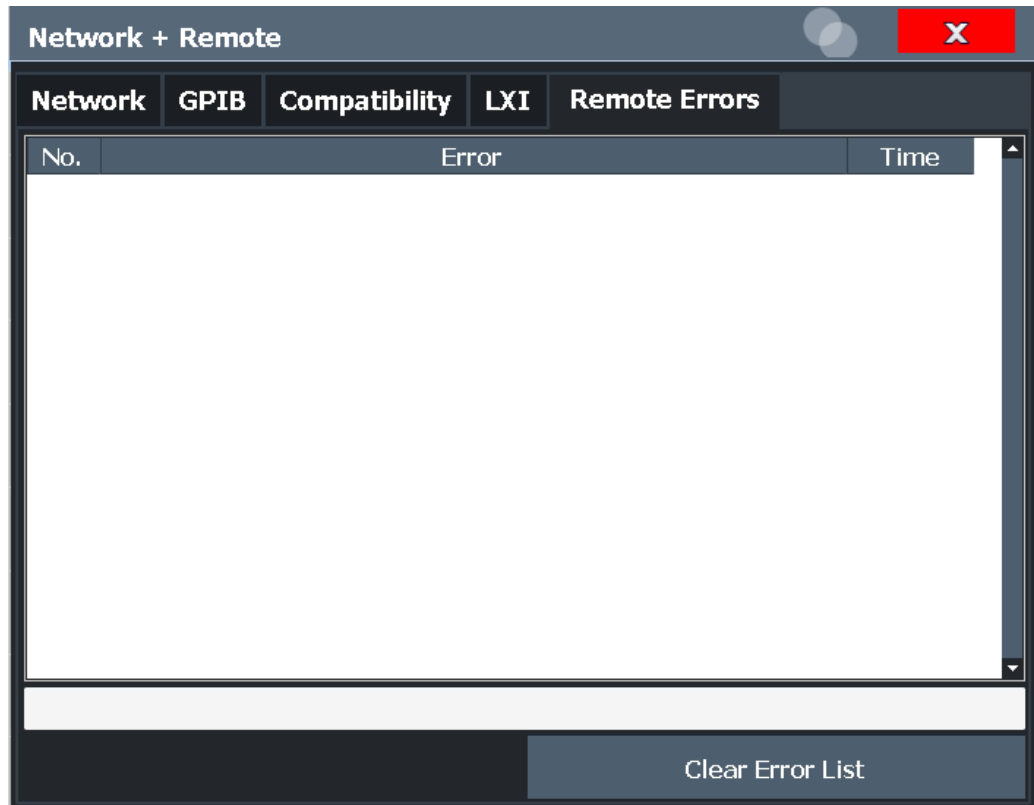

The most recent error message during remote operation can be displayed on the screen, see "[Display Remote Errors](#)" on page 857.

If the number of error messages exceeds the capacity of the error buffer, the oldest error message is removed before the newest one is inserted. To clear the message buffer use "Clear Error List". It is automatically cleared when the FSW is shut down.

The following information is available:

No	Device-specific error code
Error	Brief description of the error
Date/Time	Time the message occurred

**Remote command:**

[SYSTem:ERRor:LIST?](#) on page 1449

**Clear Error List**

Deletes the error message buffer for remote operation.

**Note:** The remote error list is automatically cleared when the FSW is shut down.

Remote command:

[SYSTem:ERRor:CLEar:REMOte](#) on page 1448

### 12.6.7 Returning to manual mode ("local")

When switched on, the instrument is always in the manual measurement mode and can be operated via the front panel. As soon as the instrument receives a remote command, it is switched to the remote control mode.

In remote control mode, all keys of the instrument are disabled. The "LOCAL" softkey and the [Remote Display Update](#) softkey are displayed.

#### Local

The instrument switches from remote to manual operation.

#### Note:

- If the local lockout function (`LLO` or `SYST:KLOC ON`) is activated in the remote control mode, manual operation is no longer available until `GTL` (or `SYST:KLOC OFF`) is executed.
- Before you switch back to manual operation, all remote command processing must be completed. Otherwise, the instrument will switch back to remote control immediately.
- If you select "Local" while a self-alignment or a self-test is still running (which was started remotely), the instrument only returns to the manual operation state when the alignment or test is completed.

Furthermore, when you return to manual operation, the following happens:

- All front panel keys are enabled.
- The main softkey menu of the current mode is displayed.
- The measurement diagrams, traces and display fields are displayed again.
- If, at the time of pressing "LOCAL", the synchronization mechanism via `*OPC`, `*OPC?` or `*WAI` is active, the currently running measurement procedure is aborted and synchronization is achieved by setting the corresponding bits in the registers of the status reporting system.
- Bit 6 (`User Request`) of the `Event` status register is set.  
If the status reporting system is configured accordingly, this bit immediately causes the generation of a service request (SRQ) to inform the control software that the user wishes to return to front panel control. For example, this can be used to interrupt the control program and to correct instrument settings manually. This bit is set each time you select "LOCAL".

Remote command:

`SYST:COMM:INT:REM OFF`, see [SYSTEM:COMMunicate:INTernal:REMote](#) on page 1434

## 12.7 How to set up a network and remote control

### Remote operation

You can operate the instrument remotely from a connected computer using SCPI commands. Before you send remote commands, configure the instrument in a LAN network or connect it to a PC via the GPIB interface as described in [Chapter 12.7.1, "How to configure a network"](#), on page 871.

## Remote Desktop

In production test and measurement, a common requirement is central monitoring of the T&M instruments for remote maintenance and remote diagnostics. Equipped with the Remote Desktop software of Windows, the FSW ideally meets requirements for use in production. The computer that is used for remote operation is called "controller" here.

The following tasks can be performed using Remote Desktop:

- Access to the control functions via a virtual front panel (soft front panel)
- Printout of measurement results directly from the controller
- Storage of measured data on the controller's hard disk

This documentation provides basic instructions on setting up the Remote Desktop for the FSW. For details refer to the Windows 10 operating system documentation.

## 12.7.1 How to configure a network

A precondition for operating or monitoring the instrument remotely is that it is connected to a LAN network or a PC connected to the GPIB interface. Setup is described here.



### Windows Firewall Settings

A firewall protects an instrument by preventing unauthorized users from gaining access to it through a network. We highly recommend using the firewall on your instrument. Rohde & Schwarz instruments are shipped with the Windows firewall enabled and pre-configured in such a way that all ports and connections for remote control are enabled. For more details on firewall configuration, see the Windows 10 help system and the Rohde & Schwarz white paper (available from the Rohde & Schwarz website):

[1EF96: Malware Protection Windows 10](#)

### 12.7.1.1 How to connect the instrument to the network

There are two methods to establish a LAN connection to the instrument:

- A non-dedicated network (Ethernet) connection from the instrument to an existing network made with an ordinary RJ-45 network cable. The instrument is assigned an IP address and can coexist with a computer and with other hosts on the same network.
- A dedicated network connection (Point-to-point connection) between the instrument and a single computer made with a (crossover) RJ-45 network cable. The computer must be equipped with a network adapter and be directly connected to the instrument. The use of hubs, switches, or gateways is not required, however, data transfer is still performed using the TCP/IP protocol. You have to assign an IP address to the instrument and the computer, see [Chapter 12.7.1.2, "How to assign the IP address"](#), on page 872.

**Note:** As the FSW uses a 1 GBit LAN, a crossover cable is not necessary (due to Auto-MDI(X) functionality).

► **NOTICE!** Network environment.

Before connecting the product to a local area network (LAN), consider the following:

- Install the latest firmware to reduce security risks.
- For internet or remote access, use secured connections, if applicable.
- Ensure that the network settings comply with the security policies of your company. Contact your local system administrator or IT department before connecting your product to your company LAN.
- When connected to the LAN, the product may potentially be accessed from the internet, which may be a security risk. For example, attackers might misuse or damage the product.

To establish a non-dedicated network connection, connect a commercial RJ-45 cable to one of the LAN ports.

To establish a dedicated connection, connect a (crossover) RJ-45 cable between the instrument and a single PC.

If the instrument is connected to the LAN, Windows automatically detects the network connection and activates the required drivers.

The network card can be operated with a 1 GBit Ethernet IEEE 802.3u interface.

#### 12.7.1.2 How to assign the IP address

Depending on the network capacities, the TCP/IP address information for the instrument can be obtained in different ways.

- If the network supports dynamic TCP/IP configuration using the Dynamic Host Configuration Protocol (DHCP), all address information can be assigned automatically.
- If the network does not support DHCP, or if the instrument is set to use alternate TCP/IP configuration, the addresses must be set manually.

By default, the instrument is configured to use dynamic TCP/IP configuration and obtain all address information automatically. Thus, it is safe to establish a physical connection to the LAN without any previous instrument configuration.



When a DHCP server is used, a new IP address can be assigned each time the PC is restarted. You have to determine this address on the PC itself. Thus, when using a DHCP server, we recommend using the permanent computer name, which determines the address via the DNS server (see ["Using a DNS server to determine the IP address"](#) on page 873).

#### Assigning the IP address on the instrument

**Note: Risk of network errors.** Connection errors can affect the entire network. Contact your network administrator to obtain a valid IP address.

1. Press [SETUP].
2. Press "Network + Remote".



3. Select the "Network" tab.
4. In the "Network + Remote" dialog, toggle the "DHCP On/Off" setting to the required mode.  
If DHCP is "Off", you must enter the IP address manually, as described in the following steps.  
**Note:** When you switch DHCP from "On" to "Off", the previously set IP address and subnet mask are retrieved.  
If DHCP is "On", the instrument obtains the IP address of the DHCP server automatically. The configuration is saved, and the FSW prompts you to restart the instrument. You can skip the remaining steps.  
**Note:** When a DHCP server is used, a new IP address can be assigned each time you restart the instrument. You have to determine this address on the instrument itself. Thus, when using a DHCP server, we recommend using the permanent computer name. Then the address is determined via the DNS server.  
(See ["Using a DNS server to determine the IP address"](#) on page 873 and [Chapter 12.7.1.3, "How to change the instrument name"](#), on page 874).
5. Enter the "IP Address", for example *192.0.2.0*. The IP address consists of four number blocks separated by dots. Every block contains a maximum of 3 numbers.
6. Enter the "Subnet Mask", for example *255.255.255.0*. The subnet mask consists of four number blocks separated by dots. Every block contains a maximum of 3 numbers.
7. Close the dialog box.  
If you have entered an invalid IP address or subnet mask, the message "out of range" is displayed in the status line. If the settings are correct, the configuration is saved, and you are prompted to restart the instrument.
8. Confirm the displayed message to restart the instrument.

### Using a DNS server to determine the IP address

If a DNS server is configured on the FSW, the server can determine the current IP address for the connection using the permanent computer name.

1. Obtain the name of your DNS domain and the IP addresses of the DNS and WINS servers on your network (see [Chapter 12.7.1.3, "How to change the instrument name"](#), on page 874).
2. Select [Setup] > "Network + Remote".
3. In the "Network" tab, select "Open Dialog 'Network Connections'".
4. Double-tap "Ethernet".
5. In the "Ethernet Status" dialog box, select "Properties".  
The items used by the Ethernet connection are displayed.
6. Tap the entry named "Internet Protocol Version 4 (TCP/IPv4)" to highlight it.

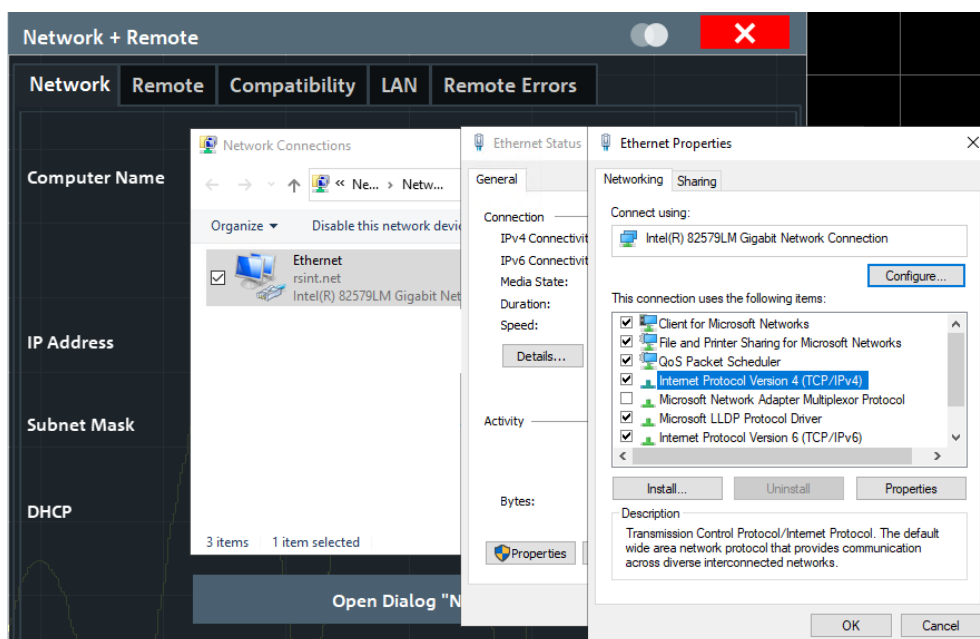

7. Select "Properties".
8. On the "General" tab, select "Use the following DNS server addresses".
9. Enter your own DNS addresses.

For more information, refer to the Windows 10 operating system Help.

### 12.7.1.3 How to change the instrument name

In a LAN that uses a DNS server, each PC or instrument connected in the LAN can be accessed via an unambiguous computer name instead of the IP address. The DNS server translates the host name to the IP address. Using the computer name is especially useful when a DHCP server is used, as a new IP address can be assigned each time the instrument is restarted.

Each instrument is delivered with an assigned computer name, but you can change this name.

#### To change the instrument's computer name

1. Press [Setup] and then "Network + Remote".  
The current "Computer Name" is displayed in the "Network" tab.
2. Enter the new computer name.
3. Close the dialog box.  
The configuration is saved, and you are prompted to restart the instrument.
4. Confirm the displayed message to restart the instrument.

#### 12.7.1.4 How to configure the LAN using the web browser interface

The instrument's "LAN" web browser interface works correctly with all W3C compliant browsers.

- ▶ In the web browser, open the `http://<instrument-hostname>` or `http://<instrument-ip-address>` page, e.g. `http://10.113.10.203`.  
The default password to change "LAN" configurations is *LxiWebIfc*.  
The "Instrument Home Page" (welcome page) opens.

The screenshot shows the 'Instrument Home Page' in a web browser. The page has a blue header with the Rohde & Schwarz logo. On the left, there is a navigation pane with sections: LAN (Home, Lan Configuration, Utilities), Instrument Control (Web Control, File Download, File Upload), License Manager (Manage Licenses), and Help (Glossary, www.rohde-schwarz.com). The main content area is titled 'Instrument Properties' and lists the following information:

Instrument Model	R&S FSW Spectrum Analyzer
Manufacturer	Rohde & Schwarz GmbH & Co. KG
Serial Number	100015
Description	R&S FSW-100015
DNS Host Name(s)	FSW-XXXXXX-3.local
MAC Address	[REDACTED]
IP Address	[REDACTED]
Firmware Revision	4.70
Current Time	Wednesday, 2020/05/13, 11:22:37
Current Time source	Operating System
Operating System	
VISA resource string	TCPIP::[REDACTED]:inst0::INSTR TCPIP::[REDACTED]:hislip0::INSTR
Device Indicator	<input type="button" value="INACTIVE (press to toggle)"/>

At the bottom, a 'Status' bar shows 'No error' and a copyright notice: © 2020 ROHDE&SCHWARZ. All rights reserved.

The instrument home page displays device information, including the VISA resource string, in read-only format.



- ▶ On the "Instrument Home Page", select "Device Indicator" to activate or deactivate the "LAN" status icon on the status bar of the FSW. The "Device Indicator" setting is not password-protected.

A green "LAN" status symbol indicates that a LAN connection is established.  
A red symbol indicates an error, for example, that no LAN cable is connected.  
When a device is connecting to the instrument, the "LAN" icon blinks.

The most important control elements in the navigation pane of the browser interface are the following:

- "LAN Configuration" opens the menu with configuration pages.
- "Status" displays information about the "LAN" status of the instrument.

### LAN configuration

The LAN configuration consists of three parts:

- "IP configuration" provides all mandatory LAN parameters.
- "Advanced LAN Configuration" provides further LAN settings.
- "Ping Client" provides the ping utility to verify the connection between the instrument and other devices.

### IP configuration

The "LAN Configuration > IP configuration" web page displays all mandatory LAN parameters and allows their modification.

The "TCP/IP Mode" configuration field controls how the IP address for the instrument gets assigned (see also [Chapter 12.7.1.2, "How to assign the IP address"](#), on page 872).

For the manual configuration mode, the static IP address, subnet mask, and default gateway are used to configure the LAN. The automatic configuration mode uses DHCP server or Dynamic Link Local Addressing (Automatic IP) to obtain the instrument IP address.



Changing the LAN configuration is password-protected. The default password is *Lxi-WebIfc* (notice upper and lower case characters).

You can change the LAN password in the "Network + Remote" dialog box, see [Chapter 12.6.4, "LAN settings"](#), on page 861.

### Advanced LAN configuration

The "LAN Configuration > Advanced LAN Configuration" parameters are used as follows:

- "mDNS and DNS-SD" are two additional protocols: Multicast DNS and DNS Service Discovery. They are used for device communication in zero configuration networks working without DNS and DHCP
- "ICMP Ping" must be enabled to use the ping utility.
- "VXI-11" is the protocol that is used to detect the instrument in the LAN.

### Ping client

Ping is a utility that verifies the connection between the instrument and another device. The ping command uses the ICMP echo request and echo reply packets to determine whether the LAN connection is functional. Ping is useful for diagnosing IP network or router failures. The ping utility is not password-protected.

To initiate a ping between the instrument and a second connected device:

**To initiate a ping between the instrument and a second connected device**

1. Enable "ICMP Ping" on the "Advanced LAN Configuration" page (enabled after an LCI).
2. Enter the IP address of the second device **without the ping command and without any further parameters** into the "Destination Address" field (e.g. *10.113.10.203*).
3. Select "Submit".

**12.7.1.5 How to change the GPIB instrument address**

To operate the instrument via remote control, it must be addressed using the GPIB address. The remote control address is factory-set to 20, but it can be changed if it does not fit in the network environment. For remote control, addresses 0 through 30 are allowed. The GPIB address is maintained after a reset of the instrument settings.

**Setting the GPIB address**

1. On the FSW, press [SETUP].
2. Press "Network + Remote".
3. In the "Network + Remote" dialog box, select the "GPIB" tab.
4. In the "GPIB Address" field, enter a value between 0 and 30.

**Remote command:**

```
SYST:COMM:GPIB:ADDR 18
```

**12.7.2 How to operate the instrument without a network**

To operate the instrument without a network connection either temporarily or permanently, no special measures are necessary. Windows 10 automatically detects the interruption of the network connection and does not set up the connection when the instrument is switched on.

If you are not prompted to enter the user name and password, proceed as described in [Chapter 12.7.3.3, "How to configure the automatic login mechanism"](#), on page 879.

**12.7.3 How to log on to the network**

Windows 10 requires that users identify themselves by entering a user name and password in a login window. You can set up two types of user accounts, either an administrator account with unrestricted access to the computer/domain or a standard user account with limited access.

The instrument provides an auto-login function for the administrator account, i.e. login with unrestricted access is carried out automatically in the background. By default, the

user name for the administrator account is "Instrument", and the user name for the standard user account is "NormalUser".

In both cases the initial password is "894129". You can change the password in Windows 10 for any user at any time. Some administrative tasks require administrator rights (e.g. firmware updates or the configuration of a LAN network). If so, it is mentioned in the function descriptions.

At the same time you log on to the operating system, you are automatically logged on to the network. As a prerequisite, the user name and the password must be identical on the instrument and on the network.

### 12.7.3.1 How to create users

After the software for the network has been installed, the instrument issues an error message the next time it is switched on because there is no user named "instrument" (= default user ID for Windows auto-login) in the network. Thus, a matching user must be created in the FSW and in the network, the password must be adapted to the network password, and the auto-login mechanism must then be deactivated.

The network administrator is responsible for creating new users in the network.

1.



Select the "Windows" icon in the toolbar to access the operating system.

2. Select "Start > Settings > Accounts > Other users".
3. Select "Add someone else to this PC".
4. In the "Microsoft account" dialog box, enter the new user name and password.
5. Select "OK".
6. Select "Finish".  
The new user is created.

### 12.7.3.2 How to change the user password

After the new user has been created on the instrument, the password must be adapted to the network password.

1.



Select the "Windows" icon in the toolbar to access the operating system.

2. Press [Ctrl + Alt + Delete], then select "Change a password".
3. Enter the user account name.
4. Enter the old password.

5. Enter the new password twice.
6. Press [Enter].  
The new password is now active.

### 12.7.3.3 How to configure the automatic login mechanism

#### Adapting the auto-login function to a new password

If you change the password that is used during auto-login, this function no longer works. Adapt the settings for the auto-login function first.



Changing the password for auto-login requires administrator rights.



1. Select the "Windows" icon in the toolbar to access the operating system of the FSW (see also ["To access the "Start" menu"](#) on page 35).
2. Open the `C:\R_S\INSTR\USER\AUTOLOGIN.REG` file in any text editor (e.g. Notepad).
3. In the line `"DefaultPassword"="894129"`, replace the default password (894129) by the new password for automatic login.
4. Save the changes to the file.
5. In the Windows "Start" menu, select "Run".  
The "Run" dialog box is displayed.
6. Enter the command `C:\R_S\INSTR\USER\AUTOLOGIN.REG`.
7. Press [ENTER] to confirm.  
The auto-login function is reactivated with the changed password. It is applied the next time you switch on the instrument.

#### Switching users when using the auto-login function

Which user account is used is defined during login. If auto-login is active, the login window is not displayed. However, you can switch the user account to be used even when the auto-login function is active.



1. Select the "Windows" icon in the toolbar to access the operating system of the FSW (see also ["To access the "Start" menu"](#) on page 35).
2. Press [CTRL] + [ALT] + [DEL], then select "Sign out".  
The "Login" dialog box is displayed, in which you can enter the different user account name and password.

### Deactivating the auto-login function

When shipped, the instrument is already configured to log on the "instrument" user automatically under Windows 10. To deactivate the auto-login function, perform the following steps:

1. In the "Start" menu, select "Run".  
The "Run" dialog box is displayed.
2. Enter the command `C:\R_S\INSTR\USER\NO_AUTOLOGIN.REG`.
3. Press [ENTER] to confirm.  
The auto-login function is deactivated. The next time you switch on the instrument, the FSW prompts you to enter your user name and password before the firmware is started.

### Reactivating the auto-login function

To reactivate the auto-login function after manually deactivating it, perform the following steps:

1. In the "Start" menu, select "Run".  
The "Run" dialog box is displayed.
2. Enter the command `C:\R_S\INSTR\USER\AUTOLOGIN.REG`.
3. Press [ENTER] to confirm.  
The auto-login function is reactivated. It is applied the next time you switch on the instrument.

## 12.7.4 How to share directories (only with Microsoft networks)

Sharing directories makes data available for other users. Sharing directories is only possible in Microsoft networks. Sharing is a property of a file or directory.

1. In the "Start" menu, select "Programs" > "Accessories" > "Windows Explorer".
2. Right-click the desired folder.
3. In the context menu, select "Sharing with" > "Specific people".  
The dialog box for sharing a directory is displayed.
4. Select a user from the list or add a new name.
5. Select "Add".
6. Select "Share".
7. Select "Done" to close the dialog box.  
The drive is shared and the selected users can access it.



## 12.7.5 How to control the FSW via the web browser interface

Via the LAN web browser interface to the FSW, one or more users can control the instrument remotely from another PC without additional installation. Most instrument controls are available via the front panel simulation. File upload and download between the instrument and the remote PC is also available.

### To access the FSW via the web browser interface

1. Start a web browser that supports html5 (W3C compliant).
2. Enter the IP address of the FSW in the browser's address bar.  
The FSW's Welcome page is displayed.
3. In the navigation pane, select "Instrument Control > Web Control".  
The instrument's display is shown in a new browser window, with a software front panel displayed beside or below it.
4. Use the mouse cursor to access the functionality in the software front panel or in the display as you would directly on the instrument's front panel.

### To exchange files with the FSW

You can download files, for example stored measurement data, from the FSW to the remote PC, or upload files, for example limit line definitions, from the PC to the FSW.

1. In the web browser, select the Welcome page window.
2. In the navigation pane, select "Instrument Control" > "File Upload" or "File Download".

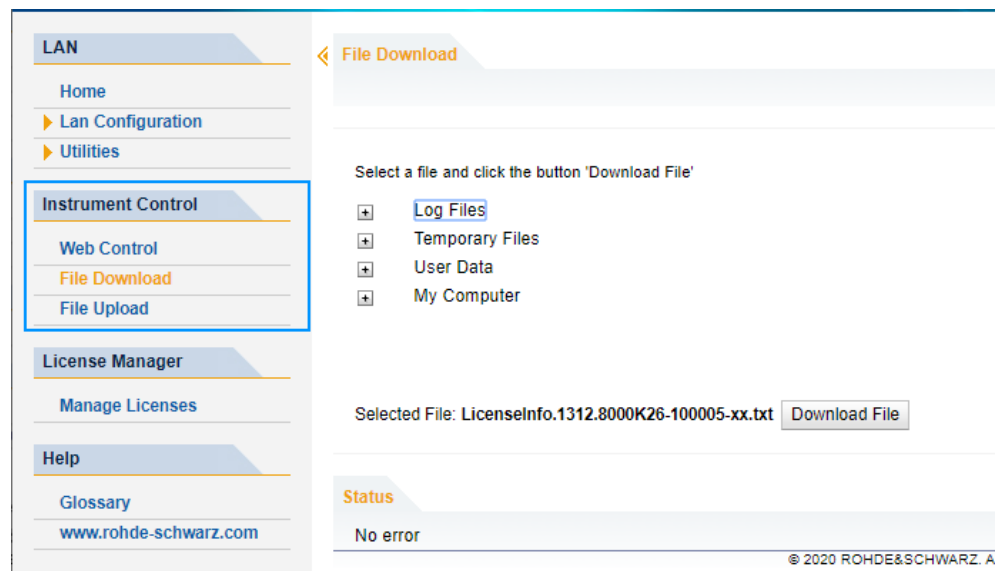

The most commonly used folders on the instrument are displayed. For example, folders that contain user data. From the top-most folder, *My Computer*, you can access all other folders on the instrument.

3. To download a file from the FSW:
  - a) Select the file from the displayed folders.
  - b) Select "Download File".
4. To upload a file to the FSW:
  - a) From the displayed folders in the web browser window, select the folder on the FSW to which you want to copy a file.
  - b) Under "File to Upload", select "Browse".
  - c) From the file selection dialog box, select the required file on the PC.
  - d) Select "Upload" to copy the file from the PC to the defined folder on the FSW.

### 12.7.6 How to deactivate the web browser interface

If you want to prevent other users in the LAN from accessing or operating the FSW via its LAN web browser interface, you must deactivate this function. Note that **after a firmware update** the function is **automatically active** again until you deactivate it manually.

#### To deactivate the LAN web browser interface

1. 

Select the "Windows" icon in the toolbar to access the operating system.
2. In the "Start" menu, select "Control Panel".
3. Select "System and Security" > "Administrative Tools".
4. From the list on the right, select "Services".
5. From the list of local services, select "R&S TightVNC Server".

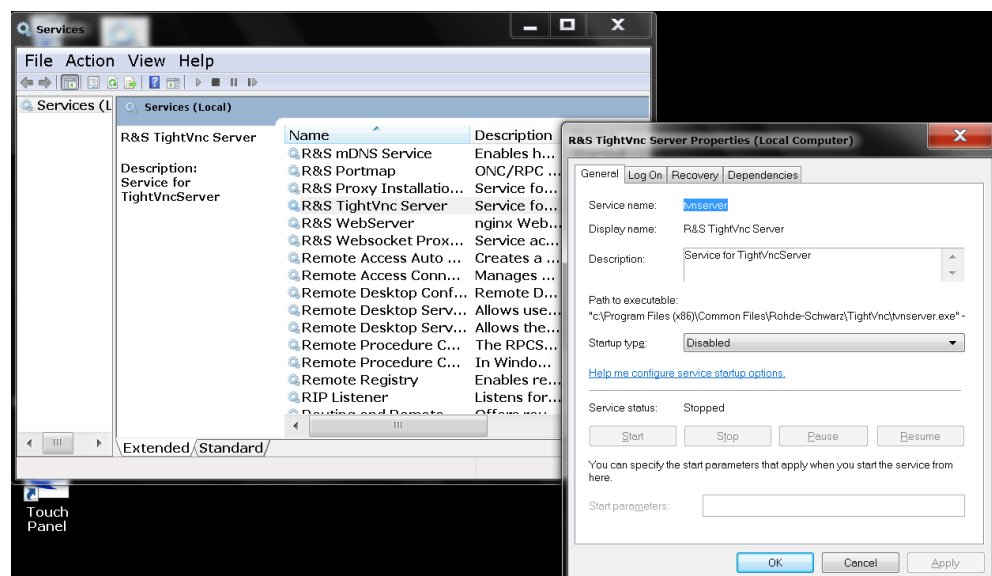

6. Set "Startup type" to "Disabled".
7. Select "Stop".
8. Select "Apply".

The next time a user enters the IP address of the instrument in a web browser, an error message is displayed:

```
Failed to connect to server (code. 1006)
```

## 12.7.7 How to set up remote desktop

Remote Desktop is a Windows application which can be used to access and control the instrument from a remote computer through a LAN connection. While the instrument is in operation, the instrument screen contents are displayed on the remote computer, and Remote Desktop provides access to all of the applications, files, and network resources of the instrument. Thus, remote operation of the FSW is possible.

With Windows 10, Remote Desktop Client is part of the operating system. For other versions of Windows, Microsoft offers the Remote Desktop Client as an add-on. For details refer to the Windows 10 operating system documentation.

With the factory settings, the default "instrument" user can connect to the FSW with the Remote Desktop program of the controller immediately. No further configuration is required. However, if the connection fails or other users need to connect, this section provides basic instructions on setting up the Remote Desktop for the FSW.

### 12.7.7.1 How to configure the FSW for remote operation via remote desktop

1. Create a fixed IP address for the TCP/IP protocol as described in [Chapter 12.7.1.2, "How to assign the IP address"](#), on page 872.

**Note:** To avoid problems, use a fixed IP address.

When a DHCP server is used, a new IP address is assigned each time the instrument is restarted. This address must first be determined on the instrument itself. Thus, using a DHCP server is not suitable for remote operation of the FSW via Remote Desktop.

2. 

Select the "Windows" icon in the toolbar to access the operating system.

3. In the Windows "Start" menu, select "Settings > System".
4. Search for "remote access".
5. Select "Allow remote access to your computer".
6. Define which users can access the FSW via Remote Desktop.

**Note:** The currently used user account is automatically enabled for Remote Desktop.

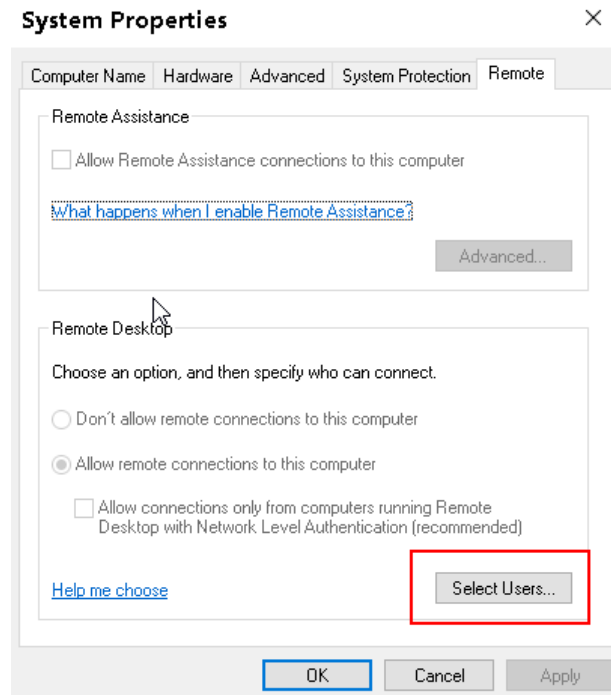

- a) Select "Select Users".
  - b) Select the users or create new user accounts as described in [Chapter 12.7.3.1, "How to create users"](#), on page 878.
  - c) Select "OK" to confirm the settings.
7. The FSW is now ready for connection setup with the Remote Desktop program of the controller.

### 12.7.7.2 How to configure the controller



#### Remote Desktop Client

With Windows 10, Remote Desktop Client is part of the operating system and can be accessed via "Start > Programs > Accessories > Remote Desktop Connection".

For other versions of Windows, Microsoft offers the Remote Desktop Client as an add-on.

1. 

Select the "Windows" icon in the toolbar to access the operating system.

2. From the "Start" menu, select "All Programs" > "Accessories" > "Remote Desktop Connection".  
The "Remote Desktop Connection" dialog box is displayed.
3. Select "Options >>".

The dialog box is expanded to display the configuration data.

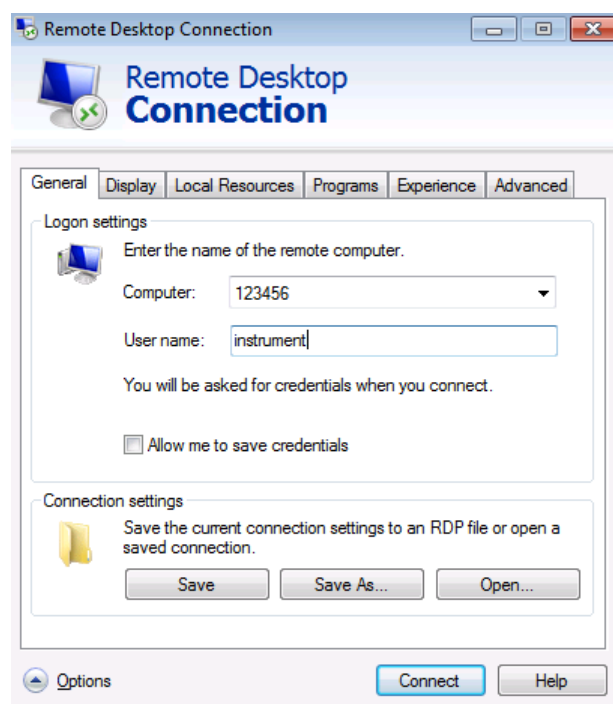

4. Open the "Experience" tab.  
The settings on this tab select and optimize the connection speed.
5. In the list, select the appropriate connection (for example: "LAN (10 Mbps or higher)").  
Depending on your selection (and how powerful the connection is), the options are activated or deactivated.
6. To improve the performance, you can deactivate the "Desktop background", "Show contents of window while dragging" and "Menu and window animation" options.
7. Open the "Local Resources" tab to enable printers, local drives and serial interfaces.
8. To access drives of the controller from the FSW, e.g. to store settings or to copy files from the controller to the FSW:

a) Select "More".

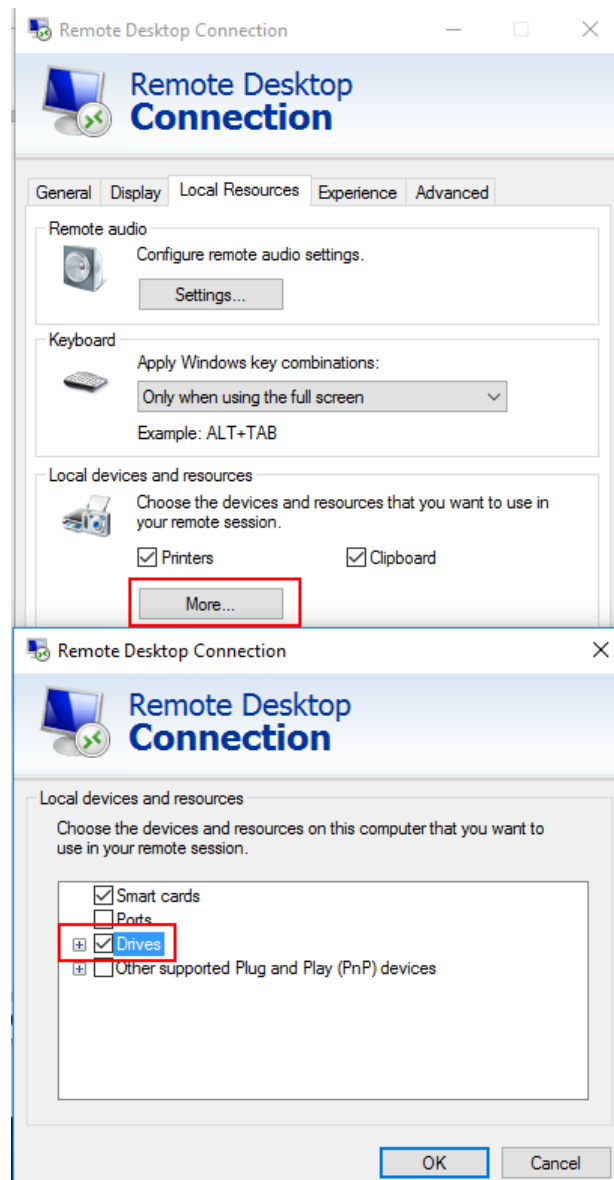

b) Enable the "Drives" option.

Windows maps drives of the controller to the corresponding network drives.

9. To use printers connected to the controller while accessing them from the FSW, activate the "Printers" option. Do not change the remaining settings.
10. Open the "Display" tab.  
The options for configuring the FSW screen display are displayed.
11. Under "Remote desktop size", you can set the size of the FSW window on the desktop of the controller.
12. Under "Colors", do not change the settings.
13. Set the "Display the connection bar when I use the full screen" option:

- If activated, a bar showing the network address of the FSW appears at the top edge of the screen. You can use this bar to reduce, minimize or close the window.
- If deactivated, the only way you can return to the controller desktop from the FSW screen in full screen mode is to select "Disconnect" from the "Start" menu.

### 12.7.7.3 How to start and close the remote desktop

#### To set up a connection to the FSW

1. In the "Remote Desktop Connection" dialog box (see [Chapter 12.7.7.2, "How to configure the controller"](#), on page 884), open the "General" tab.
2. In the "Computer" field, enter the IP address of the FSW.  
In the "User name" field, enter *instrument* to log in as an administrator, or *Normal User* to log in as a standard user.  
In the "Password" field, enter *894129*.
3. To save the connection configuration for later use:
  - a) Select "Save As".  
The "Save As" dialog box is displayed.
  - b) Enter the name for the connection information (\*.RDP).
4. To load an existing connection configuration:
  - a) Select "Open".  
The "Open" dialog box is displayed.
  - b) Select the \*.rdp file.
5. Select "Connect".  
The connection is set up.
6. If the "Disk drives" option is enabled on the "Local Resources" tab, a warning is displayed indicating that the drives are enabled for access from the FSW.  
Select "OK" to confirm the warning.  
After a few moments, the FSW screen is displayed.
7. If a dark screen appears or a dark square appears in the upper left-hand corner of the screen, restart the FSW to see the modified screen resolution.
  - a) Press the key combination [ALT] + [F4].  
The FSW firmware is shut down, which can take a few seconds.
  - b) The icon shows a black square with a white graph of a sine wave and a small white square in the bottom-left corner. Below the square, the word "Analyzer" is written in white text.

On the desktop, double-tap the "Analyzer" icon.

## How to set up a network and remote control

The firmware restarts and then automatically opens the "Softfrontpanel", i.e. the user interface on which all front panel controls and the rotary knob are mapped to buttons.

For more information, see [Chapter 11.2.3, "How to work with the soft front panels"](#), on page 746.

8. To deactivate or activate the "Softfrontpanel", press [F6].

After the connection is established, the FSW screen is displayed in the "Remote Desktop" application window.

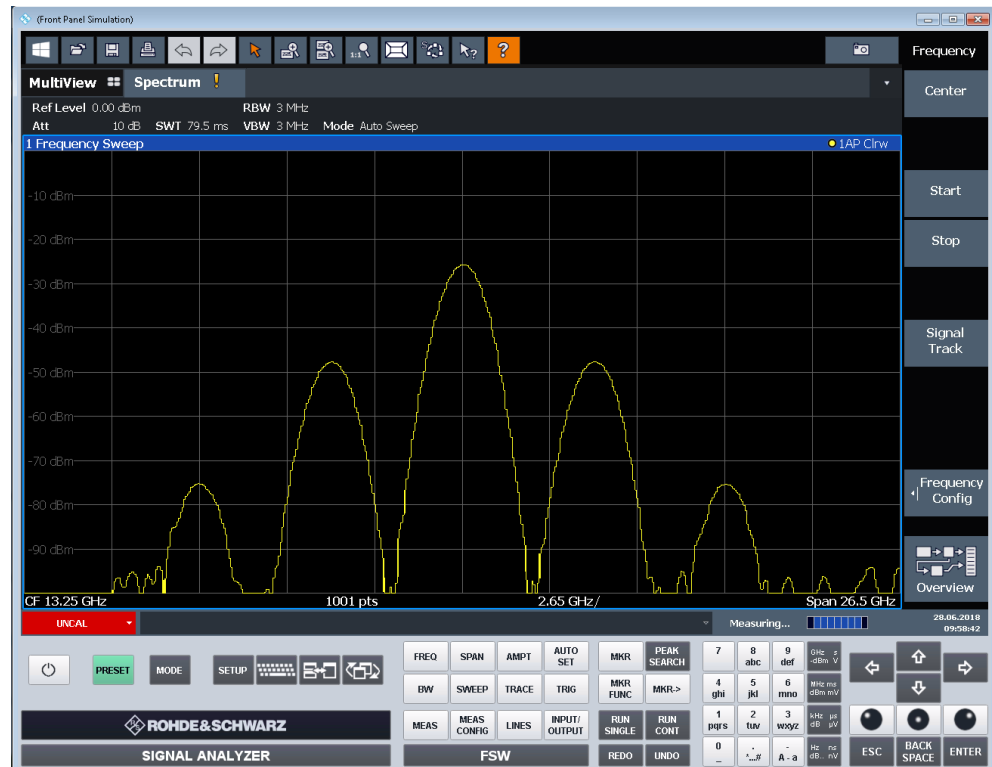

To access the Windows "Start" menu, expand the "Remote Desktop" window to full size.

During the connection with the controller, the login dialog box is displayed on the FSW screen.

### To terminate Remote Desktop control

The controller or a user at the FSW can terminate the remote connection:

- ▶ ● On the controller, close the "Remote Desktop" window at any time.  
The connection to the FSW is terminated.
- On the FSW, log on.  
The connection to the controller is terminated. A message is displayed on the controller display indicating that another user has assumed control of the instrument.



### Restoring the connection to the FSW

Follow the instructions above to set up a connection to the FSW. If the connection is terminated and then restored, the FSW remains in the same state.

#### 12.7.7.4 How to shut down the FSW via remote operation

1. Select the FSW softfrontpanel.
2. Close the application with the key combination [ALT] + [F4].
3. Select the desktop.
4. Press the key combination [ALT] + [F4].  
A safety query is displayed to warn you that the instrument cannot be reactivated via remote operation and asks you whether you want to continue the shutdown process.
5. Respond to the safety query with "Yes".  
The connection with the controller is terminated and the FSW is shut down.

#### 12.7.8 How to start a remote control session from a PC

When you switch on the FSW, it is always in manual operation state ("local" state) and can be operated via the front panel.

##### To start remote control

1. Send an addressed command (`GTR` - Go to Remote) from a controller to the instrument.  
  
The instrument is switched to remote control ("remote" state). Operation via the front panel is disabled. Only the "Local" softkey is displayed to return to manual operation. The instrument remains in the remote state until it is reset to the manual state via the instrument or via remote control interfaces. Switching from manual operation to remote control and vice versa does not affect the other instrument settings.
2. During program execution, send the `SYSTem:DISPlay:UPDate ON` command to activate the display of results (see `SYSTem:DISPlay:UPDate` on page 1435).  
  
The changes in the device settings and the recorded measurement values are displayed on the instrument screen.
3. To obtain optimum performance during remote control, send the `SYSTem:DISPlay:UPDate OFF` command to hide the display of results and diagrams again (default setting in remote control).
4. To prevent unintentional return to manual operation, disable the keys of the instrument using the universal command `LLO`.

Switching to manual mode is only possible via remote control then. This function is only available for the GPIB interface.

5. To enable the keys of the FSW again, switch the instrument to local mode (`GTL - Go to Local`), i.e. deactivate the `REN` line of the remote control interface.



If the instrument is operated exclusively in remote control, it is recommended that you switch off the display. For details see ["Remote Display Update"](#) on page 856.

### 12.7.9 How to return to manual operation

Before you switch back to manual operation, all remote command processing must be completed. Otherwise, the instrument switches back to remote control immediately.

- ▶ ● Manual operation: Select "Local".
- Remote operation: Use the following GPIB command:

```
status = viGpibControlREN(vi, VI_GPIB_REN_ADDRESS_GTL)
```



If you select "Local" while a self-alignment or a self-test is still running (which was started remotely), the instrument only returns to the manual operation state when the alignment or test is completed.

## 13 Remote commands

The commands required to perform measurements in the Spectrum application in a remote environment are described here.

It is assumed that the FSW has already been set up for remote operation in a network as described in [Chapter 12.7, "How to set up a network and remote control"](#), on page 870.



### Compatibility with former R&S signal and spectrum analyzers

As a rule, the FSW supports most commands from previous R&S signal and spectrum analyzers such as the FSQ, FSP, FSU, or FSV. However, the default values, in particular the number of sweep points or particular bandwidths, may vary. Therefore, the FSW can emulate these other devices, including their default values, in order to repeat previous measurements or support existing control applications as in legacy systems.

• <a href="#">Conventions used in SCPI command descriptions</a> .....	891
• <a href="#">Common suffixes</a> .....	892
• <a href="#">Common commands</a> .....	892
• <a href="#">Selecting the operating mode and application</a> .....	897
• <a href="#">Configuring and performing measurements</a> .....	907
• <a href="#">Configuring the result display</a> .....	1098
• <a href="#">Setting basic measurement parameters</a> .....	1109
• <a href="#">Analyzing measurements (basics)</a> .....	1236
• <a href="#">Managing settings and results</a> .....	1347
• <a href="#">Configuring the FSW</a> .....	1389
• <a href="#">Using the status register</a> .....	1478
• <a href="#">Commands for remote instrument operation</a> .....	1482
• <a href="#">Recording SCPI Commands Automatically</a> .....	1482
• <a href="#">Emulating other instruments' commands</a> .....	1487
• <a href="#">Deprecated commands</a> .....	1527
• <a href="#">Programming examples</a> .....	1531

### 13.1 Conventions used in SCPI command descriptions

The following conventions are used in the remote command descriptions:

- *Command usage*  
If not specified otherwise, commands can be used both for setting and for querying parameters.  
If a command can be used for setting or querying only, or if it initiates an event, the usage is stated explicitly.
- *Parameter usage*  
If not specified otherwise, a parameter can be used to set a value, and it is the result of a query.  
Parameters required only for setting are indicated as "Setting parameters".  
Parameters required only to refine a query are indicated as "Query parameters".

Parameters that are only returned as the result of a query are indicated as "Return values".

- *Conformity*  
Commands that are taken from the SCPI standard are indicated as "SCPI confirmed". All commands used by the FSW follow the SCPI syntax rules.
- *Asynchronous commands*  
A command which does not automatically finish executing before the next command starts executing (overlapping command) is indicated as an "Asynchronous command".
- *Reset values (\*RST)*  
Default parameter values that are used directly after resetting the instrument (\*RST command) are indicated as "\*RST" values, if available.
- *Default unit*  
The default unit is used for numeric values if no other unit is provided with the parameter.
- *Manual operation*  
If the result of a remote command can also be achieved in manual operation, a link to the description is inserted.

## 13.2 Common suffixes

In the Spectrum application, the following common suffixes are used in remote commands:

*Table 13-1: Common suffixes used in remote commands in the Spectrum application*

Suffix	Value range	Description
<m>	1 to 16	Marker
<n>	1 to 16	Window (in the currently selected channel)
<t>	1 to 6	Trace
<li>	1 to 8	Limit line

## 13.3 Common commands

Common commands are described in the IEEE 488.2 (IEC 625-2) standard. These commands have the same effect and are employed in the same way on different devices. The headers of these commands consist of "\*" followed by three letters. Many common commands are related to the Status Reporting System.

Available common commands:

*CAL?	893
*CLS	893
*ESE	893
*ESR?	893

*IDN?	894
*IST?	894
*OPC	894
*OPT?	894
*PCB	895
*PRE	895
*PSC	895
*RST	896
*SRE	896
*STB?	896
*TRG	896
*TST?	896
*WAI	897

---

**\*CAL?**

Calibration query

Initiates a calibration of the instrument and then queries the calibration status. Responses > 0 indicate errors.

**Note:** If you start a self-alignment remotely, then select the "Local" softkey while the alignment is still running, the instrument only returns to the manual operation state after the alignment is completed.

**Usage:** Query only

**Manual operation:** See ["Start Self Alignment"](#) on page 730

---

**\*CLS**

Clear status

Sets the status byte (STB), the standard event register (ESR) and the `EVENT` part of the `QUESTIONABLE` and the `OPERATION` registers to zero. The command does not alter the mask and transition parts of the registers. It clears the output buffer.

**Usage:** Setting only

---

**\*ESE <Value>**

Event status enable

Sets the event status enable register to the specified value. The query returns the contents of the event status enable register in decimal form.

**Parameters:**

<Value> Range: 0 to 255

---

**\*ESR?**

Event status read

Returns the contents of the event status register in decimal form and then sets the register to zero.

**Return values:**

<Contents>                      Range:      0 to 255

**Usage:**                              Query only

---

**\*IDN?**

Identification

Returns the instrument identification.

**Return values:**

<ID>                                      "Rohde&Schwarz,<device type>,<part number>/<serial number>,<firmware version>"

**Example:**                              Rohde&Schwarz,FSW-26,1312.8000K26/100005,1.30

**Usage:**                              Query only

---

**\*IST?**

Individual status query

Returns the contents of the IST flag in decimal form. The IST flag is the status bit which is sent during a parallel poll.

**Return values:**

<ISTflag>                              0 | 1

**Usage:**                              Query only

---

**\*OPC**

Operation complete

Sets bit 0 in the event status register when all preceding commands have been executed. This bit can be used to initiate a service request. The query writes a "1" into the output buffer when all preceding commands have been executed, which is useful for command synchronization.

---

**\*OPT?**

Option identification query

Queries the options included in the instrument. For a list of all available options and their description, refer to the specifications document.

**Return values:**

<Options>                              The query returns a list of all installed and activated options, separated by commas, where:  
B<number> describes hardware options.

K<number> describes software options.

For PSA89600 emulation, the option is indicated as "B7J" for the \*OPT? query ("B7J, 140" if SYST:PSA:WID is activated).

(See [SYSTem:PSA:WIDeband](#) on page 1490.)

Note that B3 (Audio demodulator), K9 (Power Meter) and K14 (Spectrograms) are displayed for compatibility reasons only; in fact they are standard functionality of the FSW base unit and do not require additional ordering.

**Usage:** Query only

**\*PCB <Address>**

Pass control back

Indicates the controller address to which remote control is returned after termination of the triggered action.

**Setting parameters:**

<Address> Range: 0 to 30

**Usage:** Setting only

**\*PRE <Value>**

Parallel poll register enable

Sets parallel poll enable register to the indicated value. The query returns the contents of the parallel poll enable register in decimal form.

**Parameters:**

<Value> Range: 0 to 255

**\*PSC <Action>**

Power on status clear

Determines whether the contents of the `ENABLE` registers are preserved or reset when the instrument is switched on. Thus a service request can be triggered when the instrument is switched on, if the status registers ESE and SRE are suitably configured. The query reads out the contents of the "power-on-status-clear" flag.

**Parameters:**

<Action> 0 | 1

**0**

The contents of the status registers are preserved.

**1**

Resets the status registers.

---

**\*RST**

Reset

Sets the instrument to a defined default status. The default settings are indicated in the description of commands.

The command is equivalent to `SYSTem:PRESet`.

Note that the factory set default values can be modified to user-defined settings (see [MMEMory:LOAD:STATe](#) on page 1358). For more details on default values, see [Chapter 10.1, "Restoring the default instrument configuration \(preset\)"](#), on page 674.

**Usage:**                    Setting only

---

**\*SRE <Contents>**

Service request enable

Sets the service request enable register to the indicated value. This command determines under which conditions a service request is triggered.

**Parameters:**

<Contents>                    Contents of the service request enable register in decimal form.  
Bit 6 (MSS mask bit) is always 0.  
Range:                    0 to 255

---

**\*STB?**

Status byte query

Reads the contents of the status byte in decimal form.

**Usage:**                    Query only

---

**\*TRG**

Trigger

Triggers all actions waiting for a trigger event. In particular, \*TRG generates a manual trigger signal. This common command complements the commands of the `TRIGger` subsystem.

\*TRG corresponds to the `INITiate:IMMEDIATE` command.

(See [INITiate<n>\[:IMMEDIATE\]](#) on page 910.)

**Usage:**                    Event

---

**\*TST?**

Self-test query

Initiates self-tests of the instrument and returns an error code.



**Note:** If you start a self-test remotely, then select the "Local" softkey while the test is still running, the instrument only returns to the manual operation state after the test is completed. In this case, the self-test cannot be aborted.

**Return values:**

<ErrorCode>            **integer > 0 (in decimal format)**  
 An error occurred.  
 (For details, see the Service Manual supplied with the instrument).  
**0**  
 No errors occurred.

**Usage:**                Query only

**\*WAI**

Wait to continue

Prevents servicing of the subsequent commands until all preceding commands have been executed and all signals have settled (see also command synchronization and [\\*OPC](#)).

**Usage:**                Event

## 13.4 Selecting the operating mode and application

The following commands are required to select the operating mode or the application and to configure a Sequencer in a remote environment.

The tasks for manual operation are described in [Chapter 5, "Applications, measurement channels, and operating modes"](#), on page 109.

- [Selecting the mode and applications](#)..... 897
- [Performing a sequence of measurements](#)..... 903
- [Programming example: performing a sequence of measurements](#)..... 905

### 13.4.1 Selecting the mode and applications

<a href="#">DISPlay:ATAB</a> .....	898
<a href="#">INSTrument:CREate:DUPLicate</a> .....	898
<a href="#">INSTrument:CREate[:NEW]</a> .....	898
<a href="#">INSTrument:CREate:REPLace</a> .....	899
<a href="#">INSTrument:DELeTe</a> .....	899
<a href="#">INSTrument:LIST?</a> .....	899
<a href="#">INSTrument:MODE</a> .....	901
<a href="#">INSTrument:REName</a> .....	902
<a href="#">INSTrument[:SELeCt]</a> .....	902

**DISPlay:ATAB** <State>

This command switches between the MultiView tab and the most recently displayed channel. If only one channel is active, this command has no effect.

**Parameters:**

<State>                    ON | OFF | 0 | 1  
                               **OFF | 0**  
                               Switches off the function.  
                               **ON | 1**  
                               Switches on the function.

**INSTrument:CREate:DUPLicate**

Duplicates the currently selected channel, i.e creates a new channel of the same type and with the identical measurement settings. The name of the new channel is the same as the copied channel, extended by a consecutive number (e.g. "IQAnalyzer" -> "IQAnalyzer 2").

The channel to be duplicated must be selected first using the `INST:SEL` command.

Is not available if the MSRA/MSRT primary channel is selected.

**Example:**                    `INST:SEL 'IQAnalyzer'`  
                                   `INST:CRE:DUPL`  
                                   Duplicates the channel named 'IQAnalyzer' and creates a new channel named 'IQAnalyzer2'.

**Usage:**                     Event

**Manual operation:**    See "[Duplicate Current Channel](#)" on page 122

**INSTrument:CREate[:NEW]** <ChannelType>, <ChannelName>

Adds a measurement channel. You can configure up to 10 measurement channels at the same time (depending on available memory).

See also

- [INSTrument\[:SElect\]](#) on page 902
- [INSTrument:DElete](#) on page 899

**Parameters:**

<ChannelType>            Channel type of the new channel.  
                               For a list of available channel types, see [INSTrument:LIST?](#) on page 899.

<ChannelName>            String containing the name of the channel.  
                               Note that you cannot assign an existing channel name to a new channel. If you do, an error occurs.

**Example:**                    `INST:CRE SAN, 'Spectrum 2'`  
                                   Adds a spectrum display named "Spectrum 2".

**Manual operation:** See ["New Channel"](#) on page 121

---

**INSTrument:CREate:REPLace** <ChannelName1>, <ChannelType>, <ChannelName2>

Replaces a channel with another one.

**Setting parameters:**

<ChannelName1> String containing the name of the channel you want to replace.

<ChannelType> Channel type of the new channel.  
For a list of available channel types, see [INSTrument:LIST?](#) on page 899.

<ChannelName2> String containing the name of the new channel.  
**Note:** If the specified name for a new channel already exists, the default name, extended by a sequential number, is used for the new channel (see [INSTrument:LIST?](#) on page 899). Channel names can have a maximum of 31 characters, and must be compatible with the Windows conventions for file names. In particular, they must not contain special characters such as ":", "\*", "?".

**Example:** `INST:CRE:REPL 'IQAnalyzer2', IQ, 'IQAnalyzer'`  
Replaces the channel named "IQAnalyzer2" by a new channel of type "IQ Analyzer" named "IQAnalyzer".

**Usage:** Setting only

**Manual operation:** See ["Replace Current Channel"](#) on page 122

---

**INSTrument:DELeTe** <ChannelName>

Deletes a channel.

If you delete the last channel, the default "Spectrum" channel is activated.

**Setting parameters:**

<ChannelName> String containing the name of the channel you want to delete.  
A channel must exist to delete it.

**Example:** `INST:DEL 'IQAnalyzer4'`  
Deletes the channel with the name 'IQAnalyzer4'.

**Usage:** Setting only

**Manual operation:** See ["Closing an application"](#) on page 122

---

**INSTrument:LIST?**

Queries all active channels. The query is useful to obtain the names of the existing channels, which are required to replace or delete the channels.

## Selecting the operating mode and application

**Return values:**

<ChannelType>  
<ChannelName>

For each channel, the command returns the channel type and channel name (see tables below).

Tip: to change the channel name, use the [INSTrument:REName](#) command.

**Example:**

```
INST:LIST?
```

Result for 3 channels:

```
'ADEM', 'Analog Demod', 'IQ', 'IQ  
Analyzer', 'IQ', 'IQ Analyzer2'
```

**Usage:**

Query only

**Table 13-2: Available channel types and default channel names in Signal and Spectrum Analyzer mode**

Application	<ChannelType> parameter	Default Channel name*)
Spectrum	SANALYZER	Spectrum
1xEV-DO BTS (R&S FSW-K84)	BDO	1xEV-DO BTS
1xEV-DO MS (R&S FSW-K85)	MDO	1xEV-DO MS
3GPP FDD BTS (R&S FSW-K72)	BWCD	3G FDD BTS
3GPP FDD UE (R&S FSW-K73)	MWCD	3G FDD UE
802.11ad (R&S FSW-K95)	WIGIG	802.11ad
802.11ay (R&S FSW-K97)	EDMG	802.11ay EDMG
Amplifier Measurements (R&S FSW-K18)	AMPLifier	Amplifier
AM/FM/PM Modulation Analysis (R&S FSW-K7)	ADEM	Analog Demod
Avionics (R&S FSW-K15)	AVIonics	Avionics
Bluetooth (R&S FSW-K8)	BTO	Bluetooth
cdma2000 BTS (R&S FSW-K82)	BC2K	CDMA2000 BTS
cdma2000 MS (R&S FSW-K83)	MC2K	CDMA2000 MS
DOCSIS 3.1 (R&S FSW-K192/193)	DOCSis	DOCSIS 3.1
Fast Spur Search (R&S FSW-K50)	SPUR	Spurious
GSM (R&S FSW-K10)	GSM	GSM
HRP UWB (R&S FSW-K149)	UWB	HRP UWB
I/Q Analyzer	IQ	IQ Analyzer
LTE (R&S FSW-K10x)	LTE	LTE
Multi-Carrier "Group Delay" (R&S FSW-K17)	MCGD	MC "Group Delay"
NB-IoT (R&S FSW-K106)	NIOT	NB-IoT
Noise (R&S FSW-K30)	NOISE	Noise
*) If the specified name for a new channel already exists, the default name, extended by a sequential number, is used for the new channel.		

## Selecting the operating mode and application

Application	<ChannelType> parameter	Default Channel name*)
5G NR (R&S FSW-K144)	NR5G	5G NR
OFDM VSA (R&S FSW-K96)	OFDMVSA	OFDM VSA
OneWeb (R&S FSW-K201)	OWEB	OneWeb
Phase Noise (R&S FSW-K40)	PNOISE	Phase Noise
Pulse (R&S FSW-K6)	PULSE	Pulse
"Real-Time Spectrum"	RTIM	"Real-Time Spectrum"
TD-SCDMA BTS (R&S FSW-K76)	BTDS	TD-SCDMA BTS
TD-SCDMA UE (R&S FSW-K77)	MTDS	TD-SCDMA UE
Transient Analysis (R&S FSW-K60)	TA	Transient Analysis
Verizon 5GTF Measurement Application (V5GTF, R&S FSW-K118)	V5GT	V5GT
VSA (R&S FSW-K70)	DDEM	VSA
WLAN (R&S FSW-K91)	WLAN	WLAN
*) If the specified name for a new channel already exists, the default name, extended by a sequential number, is used for the new channel.		

**INSTrument:MODE** <OpMode>

The operating mode of the FSW determines which applications are available and active. Whenever you change the operating mode, the currently active channels are closed. The default operating mode is Signal and Spectrum Analyzer mode, however, the presetting can be changed.

For details on operating modes and applications see [Chapter 5, "Applications, measurement channels, and operating modes"](#), on page 109.

**Parameters:**

&lt;OpMode&gt;

**SANalyzer**

Signal and Spectrum Analyzer mode

**MSRanalyzer**

Multi-Standard Radio Analysis (MSRA) mode

**RTMStandard**

Multi-Standard Real-Time (MSRT) mode

Only available if one of the real-time options is installed.

\*RST: SAN

**Example:**

INST:MODE MSR

Switches to Multi-Standard Radio Analysis (MSRA) mode.

**Manual operation:** See ["Switching the operating mode"](#) on page 121

---

**INSTrument:REName** <ChannelName1>, <ChannelName2>

Renames a channel.

**Setting parameters:**

<ChannelName1> String containing the name of the channel you want to rename.

<ChannelName2> String containing the new channel name.

Note that you cannot assign an existing channel name to a new channel. If you do, an error occurs.

Channel names can have a maximum of 31 characters, and must be compatible with the Windows conventions for file names. In particular, they must not contain special characters such as ":", "\*", "?".

**Example:**

```
INST:REN 'IQAnalyzer2', 'IQAnalyzer3'
```

Renames the channel with the name 'IQAnalyzer2' to 'IQAnalyzer3'.

**Usage:** Setting only

**Manual operation:** See ["Changing the Channel Name"](#) on page 84

---

**INSTrument[:SElect]** <ChannelType> | <ChannelName>

Activates a new channel with the defined channel type, or selects an existing channel with the specified name.

Also see

- [INSTrument:CREate\[:NEW\]](#) on page 898
- [Chapter 13.4.3, "Programming example: performing a sequence of measurements"](#), on page 905

**Parameters:**

<ChannelType> Channel type of the new channel.  
For a list of available channel types see [INSTrument:LIST?](#) on page 899.

<ChannelName> String containing the name of the channel.

**Example:**

```
INST IQ
```

Activates a channel for the I/Q Analyzer application (evaluation mode).

```
INST 'MyIQSpectrum'
```

Selects the channel named 'MyIQSpectrum' (for example before executing further commands for that channel).

<b>Manual operation:</b>	See <a href="#">"Spectrum"</a> on page 113
	See <a href="#">"1xEV-DO BTS"</a> on page 113
	See <a href="#">"1xEV-DO MS"</a> on page 113
	See <a href="#">"3G FDD BTS"</a> on page 114
	See <a href="#">"3G FDD UE"</a> on page 114
	See <a href="#">"5G NR"</a> on page 114
	See <a href="#">"802.11ad"</a> on page 114
	See <a href="#">"802.11ay"</a> on page 114
	See <a href="#">"Amplifier"</a> on page 115
	See <a href="#">"AM/FM/PM Modulation Analysis"</a> on page 115
	See <a href="#">"Avionics"</a> on page 115
	See <a href="#">"Bluetooth"</a> on page 115
	See <a href="#">"cdma2000 BTS"</a> on page 115
	See <a href="#">"cdma2000 MS"</a> on page 116
	See <a href="#">"Fast Spur Search"</a> on page 116
	See <a href="#">"(Multi-Carrier) Group Delay"</a> on page 116
	See <a href="#">"GSM"</a> on page 116
	See <a href="#">"HRP UWB"</a> on page 116
	See <a href="#">"I/Q Analyzer"</a> on page 116
	See <a href="#">"LTE"</a> on page 117
	See <a href="#">"NB-IoT"</a> on page 117
	See <a href="#">"Noise Figure"</a> on page 117
	See <a href="#">"OFDM Vector Signal Analysis (OFDM VSA)"</a> on page 117
	See <a href="#">"OneWeb"</a> on page 117
	See <a href="#">"Phase Noise"</a> on page 117
	See <a href="#">"Pulse Measurements"</a> on page 118
	See <a href="#">"Real-Time Spectrum"</a> on page 118
	See <a href="#">"TD-SCDMA BTS"</a> on page 118
	See <a href="#">"TD-SCDMA UE"</a> on page 118
	See <a href="#">"Transient Analysis"</a> on page 118
	See <a href="#">"Verizon 5GTF Measurement Application (V5GTF)"</a> on page 119
	See <a href="#">"Vector Signal Analysis (VSA)"</a> on page 119
	See <a href="#">"WLAN"</a> on page 119
	See <a href="#">"DOCSIS 3.1"</a> on page 119
	See <a href="#">"Selecting an application"</a> on page 121
	See <a href="#">"New Channel"</a> on page 121

### 13.4.2 Performing a sequence of measurements

The following commands control the sequencer.

For details on the Sequencer see [Chapter 5.4.1, "The sequencer concept"](#), on page 122.

<a href="#">INITiate:SEQuencer:ABORT</a> .....	904
<a href="#">INITiate:SEQuencer:IMMEDIATE</a> .....	904
<a href="#">INITiate:SEQuencer:MODE</a> .....	904
<a href="#">SYSTem:SEQuencer</a> .....	905

---

**INITiate:SEQuencer:ABORt**

Stops the currently active sequence of measurements.

You can start a new sequence any time using `INITiate:SEQuencer:IMMediate` on page 904.

**Usage:** Event

**Manual operation:** See "[Sequencer State](#)" on page 125

---

**INITiate:SEQuencer:IMMediate**

Starts a new sequence of measurements by the Sequencer.

Its effect is similar to the `INITiate<n>[:IMMediate]` command used for a single measurement.

Before this command can be executed, the Sequencer must be activated (see `SYSTem:SEQuencer` on page 905).

**Example:**

```
SYST:SEQ ON
Activates the Sequencer.
INIT:SEQ:MODE SING
Sets single sequence mode so each active measurement is performed once.
INIT:SEQ:IMM
Starts the sequential measurements.
```

**Manual operation:** See "[Sequencer State](#)" on page 125

---

**INITiate:SEQuencer:MODE <Mode>**

Defines the capture mode for the entire measurement sequence and all measurement groups and channels it contains.

**Note:** To synchronize to the end of a measurement sequence using `*OPC`, `*OPC?` or `*WAI`, use `SINGle` Sequencer mode.

**Parameters:**

<Mode>

**SINGle**

Each measurement group is started one after the other in the order of definition. All measurement channels in a group are started simultaneously and performed once. After *all* measurements are completed, the next group is started. After the last group, the measurement sequence is finished.

**CONTInuous**

Each measurement group is started one after the other in the order of definition. All measurement channels in a group are started simultaneously and performed once. After *all* measurements are completed, the next group is started. After the last group, the measurement sequence restarts with the first one and continues until it is stopped explicitly.



\*RST: CONTInuous

**Manual operation:** See "[Sequencer Mode](#)" on page 125

---

### SYSTem:SEQuencer <State>

Turns the Sequencer on and off. The Sequencer must be active before any other Sequencer commands (INIT:SEQ. . .) are executed, otherwise an error occurs.

A detailed programming example is provided in [Chapter 13.4.3, "Programming example: performing a sequence of measurements"](#), on page 905.

#### Parameters:

<State> ON | OFF | 0 | 1

#### ON | 1

The Sequencer is activated and a sequential measurement is started immediately.

#### OFF | 0

The Sequencer is deactivated. Any running sequential measurements are stopped. Further Sequencer commands (INIT:SEQ. . .) are not available.

\*RST: 0

#### Example:

```
SYST:SEQ ON
```

Activates the Sequencer.

```
INIT:SEQ:MODE SING
```

Sets single Sequencer mode so each active measurement is performed once.

```
INIT:SEQ:IMM
```

Starts the sequential measurements.

```
SYST:SEQ OFF
```

**Manual operation:** See "[Sequencer State](#)" on page 125

### 13.4.3 Programming example: performing a sequence of measurements

This example demonstrates how to perform several measurements in a sequence in a remote environment.

```
//2xSpectrumAnalyzer + 2xIQ, start Sequencer at the end, test OPC?
// -----

//-----Preparing the instrument and first and second channel -----
*RST
//Activate new IQ channel
INSTRUMENT:CREate:NEW IQ,'IQ 1'
//Set sweep count for new IQ channel
SENS:SWEEP:COUNT 6
//Change trace modes for IQ channel
```

## Selecting the operating mode and application

```

DISP:TRAC1:MODE BLANK
DISP:TRAC2:MODE MAXH
DISP:TRAC3:MODE MINH
//Switch to single sweep mode
INIT:CONT OFF
//switch back to first (default) analyzer channel
INST:SEL 'Spectrum';*WAI
//Switch into SEM
SENSE:SWEep:MODE ESpectrum
//Load Sem standard file for W-CDMA
SENSE:ESpectrum:PRESet:STANdard 'WCDMA\3GPP\DL\3GPP_DL.xml'
//Set sweep count in Spectrum channel
SENS:SWEEP:COUNT 5

//-----Creating a third measurement channel -----

//Create second IQ channel
INSTrument:CREate:NEW IQ,'IQ 2'
//Set sweep count
SENS:SWEEP:COUNT 2
//Change trace modes
DISP:TRAC1:MODE MAXH
DISP:TRAC2:MODE MINH
//Create new analyzer channel
INSTrument:CREate:NEW SANalyzer,'Spectrum 2'
//Activate ACLR measurement in channel 'Spectrum 2'
CALCulate:MARKer:FUNCTion:POWer:SElect ACPower
//Load W-CDMA Standard
CALCulate:MARKer:FUNCTion:POWer:PRESet FW3Gppcdma
//Change trace modes
DISP:TRAC2:MODE MAXH
DISP:TRAC1:MODE MINH

//-----Performing a sweep and retrieving results-----

//Change sweep count
SENS:SWEep:COUNT 7
//Single Sweep mode
INIT:CONT OFF
//Switch back to first IQ channel
INST:SEL 'IQ 1';*WAI
//Perform a measurement
INIT:IMM;*OPC?
//Retrieve results
CALC:MARK:Y?
//Activate Multiview
DISPlay:ATAB ON

//-----Performing a sequence of measurements with the Sequencer-----
//Activate Sequencer

```

```

SYSTEM:SEQuencer ON
//Start sweep in Sequencer
INITiate:SEQuencer:IMMediate;*OPC?
//Switch into first IQ channel to get results
INST:SEL 'IQ 1';*WAI
CALCulate:MARKer:MAXimum
CALC:MARK:Y?
//Change sweep time in IQ
SENS:SWE:TIME 300us
//Switch to single Sequencer mode
INITiate:SEQuencer:MODE SINGLE
//Sweep all channels once, taking the sweep count in each channel into account
INITiate:SEQuencer:IMMediate;*OPC?
//Set marker to maximum in IQ1 and query result
CALCulate:MARKer:MAXimum
CALC:MARK:Y?
//Switch to second IQ channel and retrieve results
INST:SEL 'IQ 2';*WAI
CALCulate:MARKer:MIN
CALC:MARK:Y?
//Switch to first Spectrum channel
INST:SEL 'Spectrum';*WAI
//Query one of the SEM results
CALCulate:MARKer:FUNCTion:POWer:RESult? CPOWer
//Switch to second Spectrum channel
INST:SEL 'Spectrum 2';*WAI
//Query channel power result
CALCulate:MARKer:FUNCTion:POWer:RESult? ACPower

```

## 13.5 Configuring and performing measurements

The following commands are required to configure measurements in a remote environment. The tasks for manual operation are described in [Chapter 6, "Measurements and results"](#), on page 127.

• <a href="#">Performing measurements</a> .....	908
• <a href="#">Configuring power measurements</a> .....	911
• <a href="#">Measuring the channel power and ACLR</a> .....	915
• <a href="#">Measuring the carrier-to-noise ratio</a> .....	979
• <a href="#">Measuring the occupied bandwidth</a> .....	980
• <a href="#">Remote commands for noise power ratio (NPR) measurements</a> .....	982
• <a href="#">Measuring the spectrum emission mask</a> .....	998
• <a href="#">Measuring spurious emissions</a> .....	1035
• <a href="#">Analyzing statistics (APD, CCDF)</a> .....	1051
• <a href="#">Measuring the time domain power</a> .....	1061
• <a href="#">Measuring the harmonic distortion</a> .....	1071
• <a href="#">Measuring the third order intercept point</a> .....	1075
• <a href="#">Measuring the AM modulation depth</a> .....	1078

- [Remote commands for EMI measurements](#).....1080
- [List evaluations](#)..... 1089
- [Measuring the pulse power](#)..... 1093

## 13.5.1 Performing measurements

### Useful commands for performing measurements described elsewhere

- [INITiate<n>:ESpectrum](#) on page 1000
- [INITiate<n>:SPURious](#) on page 1036

### Remote commands exclusive for performing measurements:

<a href="#">ABORt</a> .....	908
<a href="#">INITiate&lt;n&gt;:CONMeas</a> .....	909
<a href="#">INITiate&lt;n&gt;:CONTinuous</a> .....	909
<a href="#">INITiate&lt;n&gt;:[IMMediate]</a> .....	910
<a href="#">[SENSe:]SWEp:COUNT:CURRent?</a> .....	911

---

### ABORt

Aborts the measurement in the current channel and resets the trigger system.

To prevent overlapping execution of the subsequent command before the measurement has been aborted successfully, use the `*OPC?` or `*WAI` command after `ABOR` and before the next command.

For details on overlapping execution see [Remote control via SCPI](#).

#### Note on blocked remote control programs:

If a sequential command cannot be completed, for example because a triggered sweep never receives a trigger, the remote control program will never finish and the remote channel to the FSW is blocked for further commands. In this case, you must interrupt processing on the remote channel first in order to abort the measurement.

To do so, send a "Device Clear" command from the control instrument to the FSW on a parallel channel to clear all currently active remote channels. Depending on the used interface and protocol, send the following commands:

- **Visa:** `viClear()`
- **GPIB:** `ibclr()`
- **RSIB:** `RSDLLibclr()`

Now you can send the `ABORt` command on the remote channel performing the measurement.

#### Example:

```
ABOR; :INIT:IMM
```

Aborts the current measurement and immediately starts a new one.

**Example:**            `ABOR; *WAI`  
                       `INIT: IMM`  
 Aborts the current measurement and starts a new one once  
 abortion has been completed.

**Usage:**            Event

### **INITiate<n>:CONMeas**

Restarts a (single) measurement that has been stopped (using `ABORT`) or finished in single sweep mode.

The measurement is restarted at the beginning, not where the previous measurement was stopped.

As opposed to `INITiate<n>[:IMMEDIATE]`, this command does not reset traces in maxhold, minhold or average mode. Therefore it can be used to continue measurements using maxhold or averaging functions.

**Suffix:**

<n>                    irrelevant

**Example:**            `INIT:CONT OFF`  
 Switches to single sweep mode.  
                       `DISP:WIND:TRAC:MODE AVER`  
 Switches on trace averaging.  
                       `SWE:COUN 20`  
 Setting the sweep counter to 20 sweeps.  
                       `INIT; *WAI`  
 Starts the measurement and waits for the end of the 20 sweeps.  
                       `INIT:CONM; *WAI`  
 Continues the measurement (next 20 sweeps) and waits for the  
 end.  
 Result: Averaging is performed over 40 sweeps.

**Usage:**            Asynchronous command

**Manual operation:** See "[Continue Single Sweep](#)" on page 507

### **INITiate<n>:CONTInuous <State>**

Controls the sweep mode for an individual channel.

Note that in single sweep mode, you can synchronize to the end of the measurement with `*OPC`, `*OPC?` or `*WAI`. In continuous sweep mode, synchronization to the end of the measurement is not possible. Thus, it is not recommended that you use continuous sweep mode in remote control, as results like trace data or markers are only valid after a single sweep end synchronization.

For details on synchronization see [Remote control via SCPI](#).

<b>Suffix:</b>	
<n>	irrelevant
<b>Parameters:</b>	
<State>	ON   OFF   0   1
	<b>ON   1</b> Continuous sweep
	<b>OFF   0</b> Single sweep
	*RST: 1 (some applications can differ)
<b>Example:</b>	INIT:CONT OFF Switches the sweep mode to single sweep. INIT:CONT ON Switches the sweep mode to continuous sweep.
<b>Manual operation:</b>	See " <a href="#">Frequency Sweep</a> " on page 129 See " <a href="#">Zero Span</a> " on page 129 See " <a href="#">Continuous Sweep / Run Cont</a> " on page 506

---

#### INITiate<n>[:IMMediate]

Starts a (single) new measurement.

With sweep count or average count > 0, this means a restart of the corresponding number of measurements. With trace mode MAXHold, MINHold and AVERage, the previous results are reset on restarting the measurement.

You can synchronize to the end of the measurement with \*OPC, \*OPC? or \*WAI.

For details on synchronization see [Remote control via SCPI](#).

<b>Suffix:</b>	
<n>	irrelevant
<b>Example:</b>	INIT:CONT OFF Switches to single sweep mode. DISP:WIND:TRAC:MODE AVER Switches on trace averaging. SWE:COUN 20 Sets the sweep counter to 20 sweeps. INIT;*WAI Starts the measurement and waits for the end of the 20 sweeps.
<b>Usage:</b>	Asynchronous command
<b>Manual operation:</b>	See " <a href="#">Frequency Sweep</a> " on page 129 See " <a href="#">Zero Span</a> " on page 129 See " <a href="#">Single Sweep / Run Single</a> " on page 506

**[SENSe:]SWEep:COUNT:CURRent?**

This query returns the current number of started sweeps or measurements. This command is only available if a sweep count value is defined and the instrument is in single sweep mode.

**Return values:**

<CurrentCount>

**Example:**

```
SWE:COUNT 64
Sets sweep count to 64
INIT:CONT OFF
Switches to single sweep mode
INIT
Starts a sweep (without waiting for the sweep end!)
SWE:COUNT:CURR?
Queries the number of started sweeps
```

**Usage:** Query only

### 13.5.2 Configuring power measurements

The following commands work for several power measurements.

<a href="#">CALCulate&lt;n&gt;:MARKer&lt;m&gt;:FUNCTION:POWER&lt;sb&gt;:MODE</a> .....	911
<a href="#">CALCulate&lt;n&gt;:MARKer&lt;m&gt;:FUNCTION:POWER&lt;sb&gt;:RESult?</a> .....	912
<a href="#">CALCulate&lt;n&gt;:MARKer&lt;m&gt;:FUNCTION:POWER&lt;sb&gt;:SElect</a> .....	913
<a href="#">CALCulate&lt;n&gt;:MARKer&lt;m&gt;:FUNCTION:POWER&lt;sb&gt;[:STATe]</a> .....	914
<a href="#">[SENSe:]POWER:ACHannel:PRESet</a> .....	914
<a href="#">[SENSe:]POWER:ACHannel:PRESet:RLEVel</a> .....	915
<a href="#">[SENSe:]POWER:TRACe</a> .....	915

---

**CALCulate<n>:MARKer<m>:FUNCTION:POWER<sb>:MODE <Mode>**

Selects the trace display mode for power measurements.

**Suffix:**

<n> [Window](#)  
 <m> [Marker](#)  
 <sb> irrelevant

**Parameters:**

<Mode> WRITe | MAXHold

**WRITe**

The power is calculated from the current trace.

**MAXHold**

The power is calculated from the current trace and compared with the previous power value using a maximum algorithm.

**Manual operation:** See "[Power Mode](#)" on page 170

**CALCulate<n>:MARKer<m>:FUNCTION:POWer<sb>:RESult? <Measurement>**

Queries the results of power measurements.

To get a valid result, you have to perform a complete measurement with synchronization to the end of the measurement before reading out the result. This is only possible for single sweep mode.

See also [INITiate<n>:CONTinuous](#) on page 909.

**Suffix:**

<n>	irrelevant
<m>	irrelevant
<sb>	Sub block in a Multi-standard radio measurement; MSR ACLR: 1 to 8 Multi-SEM: 1 to 8 for all other measurements: irrelevant

**Parameters:**

<Measurement>

**ACPower | MCACpower**

ACLR measurements (also known as adjacent channel power or multicarrier adjacent channel measurements).

Returns the power for every active transmission and adjacent channel. The order is:

- power of the transmission channels
- power of adjacent channel (lower, upper)
- power of alternate channels (lower, upper)

**MSR ACLR results:**

For MSR ACLR measurements, the order of the returned results is slightly different:

- power of the transmission channels
- total power of the transmission channels for each sub block
- power of adjacent channels (lower, upper)
- power of alternate channels (lower, upper)
- power of gap channels (lower1, upper1, lower2, upper2)

The unit of the return values depends on the scaling of the y-axis:

- logarithmic scaling returns the power in the current unit
- linear scaling returns the power in W

**GACLR**

For MSR ACLR measurements only: returns a list of ACLR values for each gap channel (lower1, upper1, lower2, upper2)

**MACM**

For MSR ACLR measurements only: returns a list of CACLR values for each gap channel (lower1, upper1, lower2, upper2)

**CN**

Carrier-to-noise measurements.

Returns the C/N ratio in dB.



**CNO**

Carrier-to-noise measurements.

Returns the C/N ratio referenced to a 1 Hz bandwidth in dBm/Hz.

**CPOWer**

Channel power measurements.

Returns the channel power. The unit of the return values depends on the scaling of the y-axis:

- logarithmic scaling returns the power in the current unit
- linear scaling returns the power in W

For SEM measurements, the return value is the channel power of the reference range (in the specified sub block).

**PPOWer**

Peak power measurements.

Returns the peak power. The unit of the return values depends on the scaling of the y-axis:

- logarithmic scaling returns the power in the current unit
- linear scaling returns the power in W

For SEM measurements, the return value is the peak power of the reference range (in the specified sub block).

Note that this result is only available if the power reference type is set to peak power (see [\[SENSe:\]ESpectrum<sb>:RTYPE](#) on page 1019).

**OBANdwidth | OBWidth**

Occupied bandwidth.

Returns the occupied bandwidth in Hz.

**COBAndwidth | COBWidth**

<Centroid frequency>,<Frequency offset>

See [Chapter 6.4.2, "OBW results"](#), on page 212

**Manual operation:** See ["C/N"](#) on page 208  
See ["C/NO"](#) on page 209

**CALCulate<n>:MARKer<m>:FUNction:POWer<sb>:SElect <MeasType>**

Selects a power measurement and turns the measurement on.

**Suffix:**

<n>	<a href="#">Window</a>
<m>	<a href="#">Marker</a>
<sb>	irrelevant

**Parameters:**

<MeasType>

**ACPower | MCACpower**

Adjacent channel leakage ratio (ACLR), also known as adjacent channel power or multicarrier adjacent channel.

The FSW performs the measurement on the trace selected with [\[SENSe:\]POWer:TRACe](#).

**CPOWer**

Channel power measurement with a single carrier.

The FSW performs the measurement on the trace selected with [\[SENSe:\]POWer:TRACe](#).

**OBANdwidth | OBWidth**

Occupied bandwidth measurement.

The FSW performs the measurement on the trace that marker 1 is positioned on.

**CN**

Carrier-to-noise ratio measurement.

**CNO**

Carrier-to-noise ratio measurement referenced to 1 Hz bandwidth

**Manual operation:** See "[C/N](#)" on page 208  
See "[C/NO](#)" on page 209

**CALCulate<n>:MARKer<m>:FUNction:POWer<sb>[:STATe] <State>**

Turns a power measurement off. To switch on the power measurement again, use [CALCulate<n>:MARKer<m>:FUNction:POWer<sb>:SElect](#) on page 913.

A standard frequency sweep is activated.

**Suffix:**

<n>	irrelevant
<m>	irrelevant
<sb>	irrelevant

**Parameters:**

<State>	OFF
---------	-----

**Manual operation:** See "[C/N](#)" on page 208  
See "[C/NO](#)" on page 209

**[SENSe:]POWer:ACHannel:PRESet <Measurement>**

Determines the ideal span, bandwidths and detector for the current power measurement.

To get a valid result, you have to perform a complete measurement with synchronization to the end of the measurement before reading out the result. This is only possible for single sweep mode.

See also [INITiate<n>:CONTinuous](#) on page 909.

**Parameters:**

<Measurement>	<b>ACPower   MCACpower</b> ACLR measurement
	<b>CPOWer</b> channel power measurement

**OBANdwidth | OBWidth**

Occupied bandwidth measurement

**CN**

Carrier to noise ratio

**CNO**

Carrier to noise ration referenced to a 1 Hz bandwidth

**Manual operation:** See ["Optimized Settings \(Adjust Settings\)"](#) on page 170  
 See ["Adjust Settings"](#) on page 209  
 See ["Adjust Settings"](#) on page 214

**[SENSe:]POWer:ACHannel:PRESet:RLEVel**

This command determines the ideal reference level for the current measurement.

This automatic routine makes sure that the that the signal power level does not over-load the FSW or limit the dynamic range by too small a S/N ratio.

To determine the best reference level, the FSW aborts current measurements and performs a series of test sweeps. After it has finished the test, it continues with the actual measurement.

To get a valid result, you have to perform a complete sweep with synchronization to the sweep end. This is only possible in single sweep mode.

**[SENSe:]POWer:TRACe <TraceNumber>**

Selects the trace channel power measurements are performed on.

For the measurement to work, the corresponding trace has to be active.

**Parameters:**

<TraceNumber>      Range:      1 to 6  
                          \*RST:        1

**Example:**

POW:TRAC 2  
 Assigns the measurement to trace 2.

**Manual operation:** See ["Selected Trace"](#) on page 169

### 13.5.3 Measuring the channel power and ACLR

All remote control commands specific to channel power or ACLR measurements are described here.



See also [Chapter 13.5.2, "Configuring power measurements"](#), on page 911.

- [Managing measurement configurations](#)..... 916
- [Configuring the channels](#)..... 918
- [Defining weighting filters](#)..... 922

- [Selecting the reference channel](#).....924
- [Checking limits](#)..... 925
- [Checking limits \(total limit pass mode\)](#)..... 932
- [General ACLR measurement settings](#)..... 937
- [Configuring MSR ACLR measurements](#)..... 938
- [Performing an ACLR measurement](#)..... 967
- [Retrieving and analyzing measurement results](#)..... 968
- [Programming examples for channel power measurements](#).....971

### 13.5.3.1 Managing measurement configurations

The following commands control measurement configurations for ACLR measurements.

<a href="#">CALCulate&lt;n&gt;:MARKer&lt;m&gt;:FUNction:POWer&lt;sb&gt;:PRESet</a> .....	916
<a href="#">CALCulate&lt;n&gt;:MARKer&lt;m&gt;:FUNction:POWer&lt;sb&gt;:STANdard:CATalog?</a> .....	916
<a href="#">CALCulate&lt;n&gt;:MARKer&lt;m&gt;:FUNction:POWer&lt;sb&gt;:STANdard:DELeTe</a> .....	917
<a href="#">CALCulate&lt;n&gt;:MARKer&lt;m&gt;:FUNction:POWer&lt;sb&gt;:STANdard:SAVE</a> .....	917

---

#### **CALCulate<n>:MARKer<m>:FUNction:POWer<sb>:PRESet <Standard>**

Loads a measurement configuration.

The measurement configuration for power measurements consists of weighting filter, channel bandwidth and spacing, resolution and video bandwidth, detector and sweep time.

If the "Multi-Standard Radio" standard is selected (see "[Standard](#)" on page 166), different commands are required to configure ACLR measurements (see [Chapter 13.5.3.8, "Configuring MSR ACLR measurements"](#), on page 938).

#### **Suffix:**

<code>&lt;n&gt;</code>	<a href="#">Window</a>
<code>&lt;m&gt;</code>	<a href="#">Marker</a>
<code>&lt;sb&gt;</code>	irrelevant

#### **Parameters:**

<code>&lt;Standard&gt;</code>	For more information see <a href="#">Chapter 6.2.9, "Reference: predefined CP/ACLR standards"</a> , on page 204. If you want to load a customized configuration, the parameter is a string containing the file name.
-------------------------------	-------------------------------------------------------------------------------------------------------------------------------------------------------------------------------------------------------------------------

**Manual operation:** See "[Predefined Standards](#)" on page 166  
See "[User Standards](#)" on page 166

---

#### **CALCulate<n>:MARKer<m>:FUNction:POWer<sb>:STANdard:CATalog?**

Queries all xml files containing ACLR standards in the  
C:\Program Files (x86)\Rohde-Schwarz\FSW\<version>\acp\_std directory. Note that subdirectories are not searched.

**Suffix:**

<n>	<a href="#">Window</a>
<m>	<a href="#">Marker</a>
<sb>	Sub block in a Multi-standard radio measurement; MSR ACLR: 1 to 8 Multi-SEM: 1 to 8 for all other measurements: irrelevant

**Return values:**

<Standards> List of standard files.

**Usage:** Query only

**Manual operation:** See "[User Standards](#)" on page 166

**CALCulate<n>:MARKer<m>:FUNCTION:POWer<sb>:STANdard:DELete**  
<Standard>

Deletes a file containing an ACLR standard.

**Suffix:**

<n>	<a href="#">Window</a>
<m>	<a href="#">Marker</a>
<sb>	irrelevant

**Parameters:**

<Standard> String containing the file name of the standard.

**Manual operation:** See "[User Standards](#)" on page 166

**CALCulate<n>:MARKer<m>:FUNCTION:POWer<sb>:STANdard:SAVE** <Standard>

Saves the current ACLR measurement configuration as a new ACLR standard.

The measurement configuration for power measurements consists of weighting filter, channel bandwidth and spacing, resolution and video bandwidth, detector and sweep time.

**Suffix:**

<n>	<a href="#">Window</a>
<m>	<a href="#">Marker</a>
<sb>	irrelevant

**Parameters:**

<Standard> String containing the file name. The file format is xml.

**Manual operation:** See "[User Standards](#)" on page 166

### 13.5.3.2 Configuring the channels

The following commands configure channels for channel power and ACLR measurements.

[SENSe:]POWer:ACHannel:ACPairs.....	918
[SENSe:]POWer:ACHannel:BWIDth:ACHannel.....	918
[SENSe:]POWer:ACHannel:BANDwidth:ACHannel.....	918
[SENSe:]POWer:ACHannel:BWIDth:ALternate<ch>.....	919
[SENSe:]POWer:ACHannel:BANDwidth:ALternate<ch>.....	919
[SENSe:]POWer:ACHannel:BWIDth[:CHANnel<ch>].....	919
[SENSe:]POWer:ACHannel:BANDwidth[:CHANnel<ch>].....	919
[SENSe:]POWer:ACHannel:NAME:ACHannel.....	919
[SENSe:]POWer:ACHannel:NAME:ALternate<ch>.....	920
[SENSe:]POWer:ACHannel:NAME:CHANnel<ch>.....	920
[SENSe:]POWer:ACHannel:SPACing[:ACHannel].....	920
[SENSe:]POWer:ACHannel:SPACing:ALternate<ch>.....	921
[SENSe:]POWer:ACHannel:SPACing:CHANnel<ch>.....	921
[SENSe:]POWer:ACHannel:TXCHannel:COUNT.....	922

---

#### [SENSe:]POWer:ACHannel:ACPairs <ChannelPairs>

Defines the number of pairs of adjacent and alternate channels.

##### Parameters:

<ChannelPairs>      Range:      0 to 12  
                          \*RST:        1

**Manual operation:**    See "Number of channels: Tx, Adj" on page 167  
                               See "Number of Adjacent Channels (Adj Count)" on page 185

---

#### [SENSe:]POWer:ACHannel:BWIDth:ACHannel <Bandwidth>

#### [SENSe:]POWer:ACHannel:BANDwidth:ACHannel <Bandwidth>

Defines the channel bandwidth of the adjacent channels.

The adjacent channels are the first channels to the left and right of the transmission channels. If you set the channel bandwidth for these channels, the FSW sets the bandwidth of the alternate channels to the same value (not for MSR signals).

For asymmetrical MSR signals, this command defines the bandwidth of the lower adjacent channel. To configure the bandwidth for the upper adjacent channel, use the [SENSe:]POWer:ACHannel:BANDwidth:UACHannel command.

Steep-edged channel filters are available for fast ACLR measurements.

##### Parameters:

<Bandwidth>          Range:        100 Hz to 1000 MHz  
                          \*RST:        14 kHz  
                          Default unit: Hz

**Manual operation:**    See "Channel Bandwidth" on page 172  
                               See "Adjacent Channel Bandwidths" on page 185

---

```
[SENSe:]POWer:ACHannel:BWIDth:ALTerNate<ch> <Bandwidth>
```

```
[SENSe:]POWer:ACHannel:BANDwidth:ALTerNate<ch> <Bandwidth>
```

Defines the channel bandwidth of the alternate channels.

For MSR signals, this command defines the bandwidth of the lower alternate channels in asymmetrical configurations. To configure the bandwidth for the upper alternate channel, use the `[SENSe:]POWer:ACHannel:BANDwidth:UALTerNate<ch>` command.

If you set the channel bandwidth for the first alternate channel, the FSW sets the bandwidth of the other alternate channels to the same value, but not the other way round (not for MSR signals). The command works hierarchically: to set a bandwidth of the 3rd and 4th channel, you have to set the bandwidth of the 3rd channel first.

Steep-edged channel filters are available for fast ACLR measurements.

**Suffix:**

<ch>	1..n
	Alternate channel number

**Parameters:**

<Bandwidth>	Range: 100 Hz to 1000 MHz
	*RST: 14 kHz
	Default unit: Hz

**Manual operation:** See ["Channel Bandwidth"](#) on page 172  
See ["Adjacent Channel Bandwidths"](#) on page 185

---

```
[SENSe:]POWer:ACHannel:BWIDth[:CHANnel<ch>] <Bandwidth>
```

```
[SENSe:]POWer:ACHannel:BANDwidth[:CHANnel<ch>] <Bandwidth>
```

Defines the channel bandwidth of the transmission channels.

Steep-edged channel filters are available for fast ACLR measurements.

**Suffix:**

<ch>	1..n
	Tx channel number

**Parameters:**

<Bandwidth>	Range: 100 Hz to 1000 MHz
	*RST: 14 kHz
	Default unit: Hz

**Manual operation:** See ["Channel Bandwidth"](#) on page 172  
See ["Channel Bandwidth"](#) on page 209  
See ["Channel Bandwidth"](#) on page 214

---

```
[SENSe:]POWer:ACHannel:NAME:ACHannel <Name>
```

Defines a name for the adjacent channel.

For MSR ACLR measurements, this command defines the name for the lower adjacent channel in asymmetric channel definitions. To define the name for the upper adjacent channel use the `[SENSe:]POWer:ACHannel:NAME:UACHannel` command.

**Parameters:**

<Name> String containing the name of the channel  
 \*RST: ADJ

**Manual operation:** See "[Channel Names](#)" on page 175

**[SENSe:]POWer:ACHannel:NAME:ALTErnate<ch> <Name>**

Defines a name for an alternate channel.

For MSR ACLR measurements, this command defines the name for the lower alternate channel in asymmetric channel definitions. To define the name for the upper alternate channels use the `[SENSe:]POWer:ACHannel:NAME:UALTErnate<ch>` command.

**Suffix:**

<ch> 1..n  
 Alternate channel number

**Parameters:**

<Name> String containing the name of the channel  
 \*RST: ALT<1...11>

**Manual operation:** See "[Channel Names](#)" on page 175

**[SENSe:]POWer:ACHannel:NAME:CHANnel<ch> <Name>**

Defines a name for a transmission channel.

**Suffix:**

<ch> 1..n  
 Tx channel number

**Parameters:**

<Name> String containing the name of the channel  
 \*RST: TX<1...12>

**Manual operation:** See "[Channel Names](#)" on page 175

**[SENSe:]POWer:ACHannel:SPACing[:ACHannel] <Spacing>**

Defines the distance from transmission channel to adjacent channel.

For MSR signals, this command defines the distance from the CF of the first Tx channel in the first sub block to the lower adjacent channel. To configure the spacing for the upper adjacent channel in asymmetrical configurations, use the `[SENSe:]POWer:ACHannel:SPACing:UACHannel` command.

A change of the adjacent channel spacing causes a change in the spacing of all alternate channels below the adjacent channel (not for MSR signals).



**Parameters:**

<Spacing>                    Range:        100 Hz to 2000 MHz  
                                  \*RST:        14 kHz  
                                  Default unit: Hz

**Manual operation:**    See "[Channel Spacings](#)" on page 172  
                                  See "[Adjacent Channel Spacings](#)" on page 185

**[SENSe:]POWer:ACHannel:SPACing:ALternate<ch>** <Spacing>

Defines the distance from transmission channel to alternate channels.

For MSR signals, this command defines the distance from the CF of the first Tx channel in the first sub block to the lower alternate channel. To configure the spacing for the upper alternate channel in asymmetrical configurations, use the [\[SENSe:\]POWer:ACHannel:SPACing:UALternate<ch>](#) command.

If you set the channel spacing for the first alternate channel, the FSW adjusts the spacing of alternate channels of a lower order, but not the other way round (not for MSR signals). The command works hierarchically: to set a distance from the transmission channel to the 2nd and 3rd alternate channel, you have to define a spacing for the 2nd alternate channel first.

**Suffix:**

<ch>                            1..n  
                                  Alternate channel number

**Parameters:**

<Spacing>                    Range:        100 Hz to 2000 MHz  
                                  \*RST:        40 kHz (ALT1), 60 kHz (ALT2), 80 kHz (ALT3), ...  
                                  Default unit: Hz

**Manual operation:**    See "[Channel Spacings](#)" on page 172  
                                  See "[Adjacent Channel Spacings](#)" on page 185

**[SENSe:]POWer:ACHannel:SPACing:CHANnel<ch>** <Spacing>

Defines the distance between transmission channels.

If you set the channel spacing for a transmission channel, the FSW sets the spacing of the lower transmission channels to the same value, but not the other way round. The command works hierarchically: to set a distance between the 2nd and 3rd and 3rd and 4th channel, you have to set the spacing between the 2nd and 3rd channel first.

**Suffix:**

<ch>                            1..n  
                                  Tx channel number

**Parameters:**

<Spacing>                    Range:        14 kHz to 2000 MHz  
                                  \*RST:        20 kHz  
                                  Default unit: Hz

**Manual operation:**    See "[Channel Spacings](#)" on page 172

---

**[SENSe:]POWer:ACHannel:TXChannel:COUNT <Number>**

Defines the number of transmission channels.

The command works for measurements in the frequency domain.

**Parameters:**

<Number>	Range:	1 to 18
	*RST:	1

**Manual operation:** See "Number of channels: Tx, Adj" on page 167

### 13.5.3.3 Defining weighting filters

The following commands define weighting filters for ACLR measurements.

[SENSe:]POWer:ACHannel:FILTer:ALPHa:ACHannel.....	922
[SENSe:]POWer:ACHannel:FILTer:ALPHa[:ALL].....	922
[SENSe:]POWer:ACHannel:FILTer:ALPHa:ALTErnate<ch>.....	922
[SENSe:]POWer:ACHannel:FILTer:ALPHa:CHANnel<ch>.....	923
[SENSe:]POWer:ACHannel:FILTer[:STATE]:ACHannel.....	923
[SENSe:]POWer:ACHannel:FILTer[:STATE][:ALL].....	923
[SENSe:]POWer:ACHannel:FILTer[:STATE]:ALTErnate<ch>.....	924
[SENSe:]POWer:ACHannel:FILTer[:STATE]:CHANnel<ch>.....	924

---

**[SENSe:]POWer:ACHannel:FILTer:ALPHa:ACHannel <Alpha>**

Defines the roll-off factor for the adjacent channel weighting filter.

For asymmetrical MSR signals, this command defines the roll-off factor for the lower adjacent channel. To configure the factor for the upper adjacent channel, use the `[SENSe:]POWer:ACHannel:FILTer:ALPHa:UACHannel` command.

**Parameters:**

<Alpha>	Roll-off factor
	Range: 0 to 1
	*RST: 0.22

**Manual operation:** See "Weighting Filters" on page 175  
See "Weighting Filters" on page 186

---

**[SENSe:]POWer:ACHannel:FILTer:ALPHa[:ALL] <Value>**

Defines the alpha value for the weighting filter for all channels.

**Parameters:**

<Value>	*RST: 0.22
---------	------------

**Example:** `POW:ACH:FILT:ALPH:ALL 0.35`

---

**[SENSe:]POWer:ACHannel:FILTer:ALPHa:ALTErnate<ch> <Alpha>**

Defines the roll-off factor for the alternate channel weighting filter.

For asymmetrical MSR signals, this command defines the roll-off factor for the lower alternate channels. To configure the factor for the upper alternate channels, use the `[SENSe:]POWer:ACHannel:FILTer:ALPHa:UALTernate<ch>` command.

**Suffix:**

<ch> 1..n  
Alternate channel number

**Parameters:**

<Alpha> Roll-off factor  
Range: 0 to 1  
\*RST: 0.22

**Manual operation:** See "Weighting Filters" on page 175  
See "Weighting Filters" on page 186

`[SENSe:]POWer:ACHannel:FILTer:ALPHa:CHANnel<ch>` <Alpha>

Defines the roll-off factor for the transmission channel weighting filter.

**Suffix:**

<ch> 1..n  
Tx channel number

**Parameters:**

<Alpha> Roll-off factor  
Range: 0 to 1  
\*RST: 0.22

**Manual operation:** See "Weighting Filters" on page 175

`[SENSe:]POWer:ACHannel:FILTer[:STATe]:ACHannel` <State>

Turns the weighting filter for the adjacent channel on and off.

For asymmetrical MSR signals, this command turns the weighting filter for the lower adjacent channel on and off. To configure the filter state for the upper adjacent channel, use the `[SENSe:]POWer:ACHannel:FILTer[:STATe]:UACHannel` command.

**Parameters:**

<State> ON | OFF | 1 | 0  
\*RST: 0

**Manual operation:** See "Weighting Filters" on page 175  
See "Weighting Filters" on page 186

`[SENSe:]POWer:ACHannel:FILTer[:STATe][:ALL]` <State>

Turns the weighting filters for all channels on and off.

**Parameters:**

<State> ON | OFF | 1 | 0  
 \*RST: 0

---

**[SENSe:]POWer:ACHannel:FiLTer[:STATe]:ALTeRnate<ch> <State>**

Turns the weighting filter for an alternate channel on and off.

For asymmetrical MSR signals, this command turns the weighting filter for the lower alternate channels on and off. To configure the filter state for the upper alternate channels, use the `[SENSe:]POWer:ACHannel:FiLTer[:STATe]:UALTeRnate<ch>` command.

**Suffix:**

<ch> 1..n  
 Alternate channel number

**Parameters:**

<State> ON | OFF | 1 | 0  
 \*RST: 0

**Manual operation:** See ["Weighting Filters"](#) on page 175  
 See ["Weighting Filters"](#) on page 186

---

**[SENSe:]POWer:ACHannel:FiLTer[:STATe]:CHANnel<ch> <State>**

Turns the weighting filter for a transmission channel on and off.

**Suffix:**

<ch> 1..n  
 Tx channel number

**Parameters:**

<State> ON | OFF | 1 | 0  
 \*RST: 0

**Manual operation:** See ["Weighting Filters"](#) on page 175

### 13.5.3.4 Selecting the reference channel

The following commands define the reference channel for relative ACLR measurements.

<a href="#">[SENSe:]POWer:ACHannel:REFeRence:AUTO ONCE</a> .....	924
<a href="#">[SENSe:]POWer:ACHannel:REFeRence:TXCHannel:AUTO</a> .....	925
<a href="#">[SENSe:]POWer:ACHannel:REFeRence:TXCHannel:MANual</a> .....	925

---

**[SENSe:]POWer:ACHannel:REFeRence:AUTO ONCE**

This command sets the channel power as the reference for relative ACLR measurements.

- Example:** POW:ACH:REF:AUTO ONCE
- Usage:** Event
- Manual operation:** See "[Setting a fixed reference for Channel Power measurements \(Set CP Reference\)](#)" on page 170

**[SENSe:]POWer:ACHannel:REFerence:TXCHannel:AUTO** <RefChannel>

Selects the reference channel for relative measurements.

You need at least one channel for the command to work.

**Parameters:**

<RefChannel> MINimum | MAXimum | LHIGHest

**MINimum**

Transmission channel with the lowest power

**MAXimum**

Transmission channel with the highest power

**LHIGHest**

Lowest transmission channel for lower adjacent channels and highest transmission channel for upper adjacent channels

- Example:** POW:ACH:REF:TXCH:AUTO MAX  
Selects the channel with the peak power as reference channel.

**Manual operation:** See "[Reference Channel](#)" on page 168

**[SENSe:]POWer:ACHannel:REFerence:TXCHannel:MANual** <ChannelNumber>

Defines a reference channel for relative ACLR measurements.

You need at least one channel for the command to work.

Note that this command is not available for MSR ACLR measurements (see [CALCulate<n>:MARKer<m>:FUNCTION:POWer<sb>:PRESet](#) on page 916).

**Parameters:**

<ChannelNumber> Range: 1 to 18  
\*RST: 1

**Manual operation:** See "[Reference Channel](#)" on page 168

### 13.5.3.5 Checking limits

The following commands configure and query limit checks for channel power and ACLR measurements.



The results of the power limit checks are also indicated in the STAT:QUES:ACPL status registry (see [Chapter 12.2.2.6, "STATus:QUESTionable:ACPLimit register"](#), on page 829).

CALCulate<n>:LIMit<li>:ACPowEr:ACHannel:ABSolute.....	926
CALCulate<n>:LIMit<li>:ACPowEr:ACHannel:ABSolute:STATe.....	926
CALCulate<n>:LIMit<li>:ACPowEr:ACHannel[:RELative].....	927
CALCulate<n>:LIMit<li>:ACPowEr:ACHannel:RESult?.....	927
CALCulate<n>:LIMit<li>:ACPowEr:ACHannel[:RELative]:STATe.....	928
CALCulate<n>:LIMit<li>:ACPowEr:ALTernate<ch>:ABSolute.....	929
CALCulate<n>:LIMit<li>:ACPowEr:ALTernate<ch>:ABSolute:STATe.....	929
CALCulate<n>:LIMit<li>:ACPowEr:ALTernate<ch>[:RELative].....	930
CALCulate<n>:LIMit<li>:ACPowEr:ALTernate<ch>:RESult?.....	930
CALCulate<n>:LIMit<li>:ACPowEr:ALTernate<ch>[:RELative]:STATe.....	931
CALCulate<n>:LIMit<li>:ACPowEr:PMODE.....	931
CALCulate<n>:LIMit<li>:ACPowEr[:STATe].....	932

---

**CALCulate<n>:LIMit<li>:ACPowEr:ACHannel:ABSolute** <LowerLimit>[,  
<UpperLimit>]

Defines the absolute limit of the adjacent channels.

If you have defined an absolute limit as well as a relative limit, the FSW uses the lower value for the limit check.

**Suffix:**

<n>                    irrelevant  
<li>                    irrelevant

**Parameters:**

<LowerLimit>        The limit of the lower adjacent channel.  
Range:                -200 dBm to 200 dBm  
\*RST:                 -200 dBm  
Default unit: dBm

<UpperLimit>        The limit of the upper adjacent channel.  
Range:                -200 dBm to 200 dBm  
\*RST:                 -200 dBm  
Default unit: dBm

**Manual operation:** See "[Limit Check](#)" on page 173  
See "[Limit Checking](#)" on page 186

---

**CALCulate<n>:LIMit<li>:ACPowEr:ACHannel:ABSolute:STATe** <State>[, <State>]

This command turns the absolute limit check for the adjacent channels on and off.

You have to activate the general ACLR limit check before using this command with [CALCulate<n>:LIMit<li>:ACPowEr\[:STATe\]](#).

**Suffix:**

<n>                    irrelevant  
<li>                    irrelevant

**Parameters:**

<State>	ON   OFF   1   0
	Absolute limit check for lower adjacent channel
	*RST: 0
<State>	ON   OFF   1   0
	Absolute limit check for upper adjacent channel
	*RST: 0

**Manual operation:** See "[Limit Check](#)" on page 173  
See "[Limit Checking](#)" on page 186

**CALCulate<n>:LIMit<li>:ACPowEr:ACHannel[:RELative] <LowerLimit>[, <UpperLimit>]**

Defines the relative limit of the adjacent channels. The reference value for the relative limit is the measured channel power.

If you have defined an absolute limit as well as a relative limit, the FSW uses the lower value for the limit check.

**Suffix:**

<n>	irrelevant
<li>	irrelevant

**Parameters:**

<LowerLimit>	The limit of the lower adjacent channel.
	Range: 0 dB to 100 dB
	*RST: 0 dB
	Default unit: dB
<UpperLimit>	The limit of the upper adjacent channel.
	Range: 0 dB to 100 dB
	*RST: 0 dB
	Default unit: dB

**Manual operation:** See "[Limit Check](#)" on page 173  
See "[Limit Checking](#)" on page 186

**CALCulate<n>:LIMit<li>:ACPowEr:ACHannel:RESult?**

Queries the state of the limit check for the adjacent channels in an ACLR measurement.

To get a valid result, you have to perform a complete measurement with synchronization to the end of the measurement before reading out the result. This is only possible for single sweep mode.

See also [INITiate<n>:CONTinuous](#) on page 909.

**Suffix:**

<n>	irrelevant
-----	------------

<li>	irrelevant
<b>Return values:</b>	
<LowerACH>	text value The state of the limit check for the lower adjacent channels. <b>PASSED</b> Limit check has passed. <b>FAIL</b> Limit check has failed.
<UpperACH>	text value The state of the limit check for the upper adjacent channels. <b>PASSED</b> Limit check has passed. <b>FAIL</b> Limit check has failed.
<b>Example:</b>	INIT: IMM; *WAI; CALC: LIM: ACP: ACH: RES? PASSED, PASSED
<b>Usage:</b>	Query only
<b>Manual operation:</b>	See <a href="#">"Limit Check"</a> on page 173 See <a href="#">"Limit Checking"</a> on page 186

---

**CALCulate<n>:LIMit<li>:ACPpower:ACHannel[:RELative]:STATe <State>[, <State>]**

This command turns the relative limit check for the adjacent channels on and off.

You have to activate the general ACLR limit check before using this command with [CALCulate<n>:LIMit<li>:ACPpower\[:STATe\]](#).

**Suffix:**

<n>	irrelevant
<li>	irrelevant

**Parameters:**

<State>	ON   OFF   1   0 Relative limit check for lower adjacent channel *RST: 0
<State>	ON   OFF   1   0 Relative limit check for upper adjacent channel *RST: 0

**Manual operation:** See ["Limit Check"](#) on page 173  
See ["Limit Checking"](#) on page 186



---

```
CALCulate<n>:LIMit<li>:ACPpower:ALternate<ch>:ABSolute <LowerLimit>[,
    <UpperLimit>]
```

Defines the absolute limit of the alternate channels.

If you have defined an absolute limit as well as a relative limit, the FSW uses the lower value for the limit check.

**Suffix:**

<n>	irrelevant
<li>	irrelevant
<ch>	1..n Alternate channel number

**Parameters:**

<LowerLimit>	The limit of the lower adjacent channel. Range: -200 dBm to 200 dBm *RST: -200 dBm Default unit: dBm
<UpperLimit>	The limit of the upper adjacent channel. Range: -200 dBm to 200 dBm *RST: -200 dBm Default unit: dBm

**Manual operation:** See "[Limit Check](#)" on page 173  
See "[Limit Checking](#)" on page 186

---

```
CALCulate<n>:LIMit<li>:ACPpower:ALternate<ch>:ABSolute:STATe <State>[,
    <State>]
```

This command turns the absolute limit check for the alternate channels on and off.

You have to activate the general ACLR limit check before using this command with [CALCulate<n>:LIMit<li>:ACPpower\[:STATe\]](#).

**Suffix:**

<n>	irrelevant
<li>	irrelevant
<ch>	1..n Alternate channel number

**Parameters:**

<State>	ON   OFF   1   0 Absolute limit check for lower alternate channel *RST: 0
<State>	ON   OFF   1   0 Absolute limit check for upper alternate channel *RST: 0

**Manual operation:** See "[Limit Check](#)" on page 173  
See "[Limit Checking](#)" on page 186

---

**CALCulate<n>:LIMit<li>:ACPpower:ALternate<ch>[:RELative] <LowerLimit>[, <UpperLimit>]**

Defines the relative limit of the alternate channels. The reference value for the relative limit is the measured channel power.

If you have defined an absolute limit as well as a relative limit, the FSW uses the lower value for the limit check.

**Suffix:**

<n>	irrelevant
<li>	irrelevant
<ch>	1..n Alternate channel number

**Parameters:**

<LowerLimit>	The limit of the lower alternate channel. Range: 0 dB to 100 dB *RST: 0 dB Default unit: dB
<UpperLimit>	The limit of the upper alternate channel. Range: 0 dB to 100 dB *RST: 0 dB Default unit: dB

**Manual operation:** See "[Limit Check](#)" on page 173  
See "[Limit Checking](#)" on page 186

---

**CALCulate<n>:LIMit<li>:ACPpower:ALternate<ch>:RESult?**

Queries the state of the limit check for the adjacent or alternate channels in an ACLR measurement.

To get a valid result, you have to perform a complete measurement with synchronization to the end of the measurement before reading out the result. This is only possible for single sweep mode.

See also [INITiate<n>:CONTinuous](#) on page 909.

**Suffix:**

<n>	irrelevant
<li>	irrelevant
<ch>	Alternate channel number

**Return values:**

<LowerChan>	text value
-------------	------------

The state of the limit check for the lower alternate or adjacent channels.

**PASSED**

Limit check has passed.

**FAIL**

Limit check has failed.

<UpperChan>

text value

The state of the limit check for the upper alternate or adjacent channels.

**PASSED**

Limit check has passed.

**FAIL**

Limit check has failed.

**Example:**

```
INIT: IMM; *WAI;
CALC: LIM: ACP: ACH: RES?
PASSED, PASSED
```

**Usage:**

Query only

**CALCulate<n>:LIMit<li>:ACPpower:ALternate<ch>[:RELative]:STATe <State>[, <State>]**

This command turns the relative limit check for the alternate channels on and off.

You have to activate the general ACLR limit check before using this command with [CALCulate<n>:LIMit<li>:ACPpower\[:STATe\]](#).

**Suffix:**

<n> irrelevant

<li> irrelevant

<ch> 1..n  
Alternate channel number

**Parameters:**

<State> ON | OFF | 1 | 0

Relative limit check for lower alternate channel

\*RST: 0

<State> ON | OFF | 1 | 0

Relative limit check for upper alternate channel

\*RST: 0

**Manual operation:** See ["Limit Check"](#) on page 173  
See ["Limit Checking"](#) on page 186

**CALCulate<n>:LIMit<li>:ACPpower:PMODE <Mode>**

Selects the limit evaluation mode for ACLR measurements.

Supported for ACLR measurements in the LTE and 5G applications.

**Suffix:**

<n> irrelevant

<li> irrelevant

**Parameters:**

<Mode> **AND**  
Overall limit check passes if both absolute and relative limit checks pass.

**OR**

Overall limit check passes if either absolute or relative limit checks pass.

\*RST: AND

**Example:**

```
//Select evaluation mode
CALC:LIM:ACP:PMOD AND
```

**Manual operation:** See ["Total Limit Pass Mode"](#) on page 174

**CALCulate<n>:LIMit<li>:ACPpower[:STATe] <State>**

Turns the limit check for ACLR measurements on and off.

In addition, limits must be defined and activated individually for each channel (see [CALCulate<n>:LIMit<li>:ACPpower:ACHannel\[:RELative\]:STATe](#), [CALCulate<n>:LIMit<li>:ACPpower:ALternate<ch>\[:RELative\]:STATe](#), [CALCulate<n>:LIMit<li>:ACPpower:GAP<gap>\[:AUTO\]:ABSolute:STATe](#), [CALCulate<n>:LIMit<li>:ACPpower:GAP<gap>\[:AUTO\]:ACLR\[:RELative\]:STATe](#) and [CALCulate<n>:LIMit<li>:ACPpower:GAP<gap>\[:AUTO\]:CACLR\[:RELative\]:STATe](#)).

**Suffix:**

<n> irrelevant

<li> irrelevant

**Parameters:**

<State> ON | OFF | 1 | 0

\*RST: 0

**Manual operation:** See ["Limit Check"](#) on page 173  
See ["Limit Checking"](#) on page 181  
See ["Limit Checking"](#) on page 186

### 13.5.3.6 Checking limits (total limit pass mode)

The following commands are only available in the ACLR measurements of the LTE and 5G applications.

Depending on the syntax, the commands return the limit check results for:

- adjacent channels

- alternate channels
- gap channels in multi carrier ACLR measurements (LTE and 5G downlink only)
- gap channels in cumulative ACLR measurement (LTE downlink and 5G downlink only)

<code>CALCulate&lt;n&gt;:LIMit&lt;li&gt;:ACPpower:ACHannel:RESult:ABSolute</code> .....	933
<code>CALCulate&lt;n&gt;:LIMit&lt;li&gt;:ACPpower:ACHannel:RESult:RELative</code> .....	933
<code>CALCulate&lt;n&gt;:LIMit&lt;li&gt;:ACPpower:ALternate&lt;ch&gt;:RESult:ABSolute</code> .....	934
<code>CALCulate&lt;n&gt;:LIMit&lt;li&gt;:ACPpower:ALternate&lt;ch&gt;:RESult:RELative</code> .....	934
<code>CALCulate&lt;n&gt;:LIMit&lt;li&gt;:ACPpower:GAP&lt;gap&gt;:ACLR:RESult:ABSolute?</code> .....	935
<code>CALCulate&lt;n&gt;:LIMit&lt;li&gt;:ACPpower:GAP&lt;gap&gt;:ACLR:RESult:RELative?</code> .....	935
<code>CALCulate&lt;n&gt;:LIMit&lt;li&gt;:ACPpower:GAP&lt;gap&gt;[:CACLR]:RESult:ABSolute?</code> .....	936
<code>CALCulate&lt;n&gt;:LIMit&lt;li&gt;:ACPpower:GAP&lt;gap&gt;[:CACLR]:RESult:RELative?</code> .....	936

---

### **CALCulate<n>:LIMit<li>:ACPpower:ACHannel:RESult:ABSolute**

Queries the absolute limit check results for adjacent channels (ACLR measurements).

Prerequisites for this command

- Select absolute limit check mode  
evaluation mode  
ACLR: `CALCulate<n>:LIMit<li>:ACPpower:PMODE`.

#### **Suffix:**

<n> irrelevant

<li> irrelevant

#### **Return values:**

<LimitCheck> Returns two values, one for the upper and one for the lower adjacent channel.

#### **PASSED**

Limit check has passed.

#### **FAILED**

Limit check has failed.

**Example:** `//Query results of the adjacent channel limit check`  
`CALC:LIM:ACP:ACH:RES:ABS?`

---

### **CALCulate<n>:LIMit<li>:ACPpower:ACHannel:RESult:RELative**

Queries the relative limit check results for the adjacent channels (ACLR measurements).

Prerequisites for this command

- Select relative limit check mode  
ACLR: `CALCulate<n>:LIMit<li>:ACPpower:PMODE`.

#### **Suffix:**

<n> irrelevant

<li> irrelevant

**Return values:**

<LimitCheck> Returns two values, one for the upper and one for the lower adjacent channel.

**PASSED**

Limit check has passed.

**FAILED**

Limit check has failed.

**Example:**

```
//Query results of the adjacent channel limit check
CALC:LIM:ACP:ACH:RES:REL?
```

**CALCulate<n>:LIMit<li>:ACPpower:ALternate<ch>:RESult:ABSolute**

Queries the absolute limit check results for the alternate channels (MC ACLR measurements).

Prerequisites for this command

- Select absolute limit check mode  
ACLR: `CALCulate<n>:LIMit<li>:ACPpower:PMODE.`

**Suffix:**

<n> irrelevant

<li> irrelevant

<ch> irrelevant

**Return values:**

<LimitCheck> Returns two values, one for the upper and one for the lower adjacent channel.

**PASSED**

Limit check has passed.

**FAILED**

Limit check has failed.

**Example:**

```
//Query results of the alternate channel limit check
CALC:LIM:ACP:ALT:RES:ABS?
```

**CALCulate<n>:LIMit<li>:ACPpower:ALternate<ch>:RESult:RELative**

Queries the relative limit check results for the alternate channels (MC ACLR measurements).

Prerequisites for this command

- Select relative limit check mode  
ACLR: `CALCulate<n>:LIMit<li>:ACPpower:PMODE.`

**Suffix:**

<n> irrelevant

<li> irrelevant

<ch> irrelevant

**Return values:**

<LimitCheck> Returns two values, one for the upper and one for the lower adjacent channel.

**PASSED**

Limit check has passed.

**FAILED**

Limit check has failed.

**Example:**

```
//Query results of the alternate channel limit check
CALC:LIM:ACP:ALT:RES:REL?
```

**CALCulate<n>:LIMit<li>:ACPower:GAP<gap>:ACLR:RESult:ABSolute?**

Queries the absolute power limit check results for the gap channels (MC ACLR measurements).

Prerequisites for this command

- Select absolute limit check mode evaluation mode

ACLR: [CALCulate<n>:LIMit<li>:ACPower:PMODE.](#)

**Suffix:**

<n> irrelevant

<li> irrelevant

<gap> irrelevant

**Return values:**

<LimitCheck> Returns two values, one for the upper and one for the lower adjacent channel.

**PASSED**

Limit check has passed.

**FAILED**

Limit check has failed.

**Example:**

```
//Query results of the gap channel limit check
CALC:LIM:ACP:GAP:ACLR:RES:ABS?
```

**Usage:**

Query only

**CALCulate<n>:LIMit<li>:ACPower:GAP<gap>:ACLR:RESult:RELative?**

Queries the relative power limit check results for the gap channels (MC ACLR measurements).

Prerequisites for this command

- Select relative limit check mode evaluation mode

ACLR: [CALCulate<n>:LIMit<li>:ACPower:PMODE.](#)

<b>Suffix:</b>	
<n>	irrelevant
<li>	irrelevant
<gap>	irrelevant
<b>Return values:</b>	
<LimitCheck>	Returns two values, one for the upper and one for the lower adjacent channel.
	<b>PASSED</b> Limit check has passed.
	<b>FAILED</b> Limit check has failed.
<b>Example:</b>	//Query results of the gap channel limit check CALC:LIM:ACP:GAP:ACLR:RES:REL?
<b>Usage:</b>	Query only

#### **CALCulate<n>:LIMit<li>:ACPpower:GAP<gap>[:CACLR]:RESult:ABSolute?**

Queries the absolute limit check results for the gap channels (MC ACLR measurements).

Prerequisites for this command

- Select absolute limit check mode evaluation mode  
ACLR: `CALCulate<n>:LIMit<li>:ACPpower:PMODE.`

<b>Suffix:</b>	
<n>	irrelevant
<li>	irrelevant
<gap>	irrelevant
<b>Return values:</b>	
<LimitCheck>	Returns two values, one for the upper and one for the lower adjacent channel.
	<b>PASSED</b> Limit check has passed.
	<b>FAILED</b> Limit check has failed.
<b>Example:</b>	//Query results of the gap channel limit check CALC:LIM:ACP:GAP:RES:ABS?
<b>Usage:</b>	Query only

#### **CALCulate<n>:LIMit<li>:ACPpower:GAP<gap>[:CACLR]:RESult:RELative?**

Queries the relative limit check results for the gap channels (MC ACLR measurements).



Prerequisites for this command

- Select relative limit check mode evaluation mode  
ACL: `CALCulate<n>:LIMit<li>:ACPower:PMODE.`

**Suffix:**

<n>	irrelevant
<li>	irrelevant
<gap>	irrelevant

**Return values:**

<LimitCheck> Returns two values, one for the upper and one for the lower adjacent channel.

**PASSED**

Limit check has passed.

**FAILED**

Limit check has failed.

**Example:**

```
//Query results of the gap channel limit check
CALC:LIM:ACP:GAP:RES:REL?
```

**Usage:**

Query only

### 13.5.3.7 General ACLR measurement settings

The following commands control the measurement algorithm.

Useful commands for the ACLR measurement described elsewhere:

- `[SENSe:]POWer:NCORrection` on page 1208
- `[SENSe:]POWer:ACHannel:PRESet` on page 914
- `[SENSe:]POWer:ACHannel:PRESet:RLEVel` on page 915
- `[SENSe:]POWer:TRACe` on page 915
- `CALCulate<n>:MARKer<m>:FUNCTion:POWer<sb>:MODE` on page 911

#### Remote commands exclusive to ACLR measurement

`[SENSe:]POWer:HSPeed`..... 937

---

**[SENSe:]POWer:HSPeed <State>**

Turns high speed ACLR and channel power measurements on and off.

If on, the FSW performs a measurement on each channel in the time domain. It returns to the frequency domain when the measurement is done.

In some telecommunications standards, high speed measurements use weighting filters with characteristic or steep-edged channel filters for band limitation.

**Parameters:**

<State> ON | OFF | 1 | 0  
 \*RST: 0

**Example:**

POW:HSP ON

**Manual operation:** See "Fast ACLR" on page 169

**13.5.3.8 Configuring MSR ACLR measurements**

If the "Multi-Standard Radio" standard is selected (see [CALCulate<n>:MARKer<m>:FUNction:POWer<sb>:PRESet](#) on page 916), the channels for the ACLR measurement are configured differently. (For more information see [Chapter 6.2.3.4, "Measurement on multi-standard radio \(MSR\) signals"](#), on page 159.)

In this case, use the following commands.

- [General MSR ACLR measurement settings](#)..... 938
- [MSR sub block and Tx channel setup](#).....938
- [MSR adjacent channel setup](#)..... 941
- [General gap channel setup](#)..... 946
- [Automatic \(symmetrical\) configuration](#)..... 947
- [Manual \(asymmetrical\) configuration](#)..... 952
- [MSR channel names](#).....966

**General MSR ACLR measurement settings**

Useful commands for configuring general MSR ACLR settings described elsewhere:

- [CALCulate<n>:MARKer<m>:FUNction:POWer<sb>:PRESet](#) on page 916
- [CALCulate<n>:MARKer<m>:FUNction:POWer<sb>:RESult?](#) on page 912
- [CALCulate<n>:MARKer<m>:FUNction:POWer<sb>:RESult:PHZ](#) on page 970
- [CALCulate<n>:MARKer<m>:FUNction:POWer<sb>:MODE](#) on page 911
- [CALCulate<n>:LIMit<li>:ACPower\[:STATe\]](#) on page 932
- [\[SENSe:\]POWER:ACHannel:REFerence:TXCHannel:AUTO](#) on page 925
- [\[SENSe:\]POWER:NCORrection](#) on page 1208
- [\[SENSe:\]POWER:TRACe](#) on page 915
- [\[SENSe:\]POWER:ACHannel:MODE](#) on page 971
- [\[SENSe:\]POWER:ACHannel:PRESet](#) on page 914
- [\[SENSe:\]POWER:ACHannel:SSETup](#) on page 943

**MSR sub block and Tx channel setup**

The functions for manual operation are described in [Chapter 6.2.5.2, "MSR sub block and TX channel definition"](#), on page 181.

Useful commands for configuring Tx channels described elsewhere:

- `[SENSe:]POWer:ACHannel:SBLock<sb>:NAME[:CHANnel<ch>]`  
on page 967

### Remote commands exclusive to configuring sub blocks and Tx channels

<code>[SENSe:]POWer:ACHannel:FILTer:ALPHA:SBLock&lt;sb&gt;:CHANnel&lt;ch&gt;</code> .....	939
<code>[SENSe:]POWer:ACHannel:FILTer[:STATe]:SBLock&lt;sb&gt;:CHANnel&lt;ch&gt;</code> .....	939
<code>[SENSe:]POWer:ACHannel:SBCount</code> .....	939
<code>[SENSe:]POWer:ACHannel:SBLock&lt;sb&gt;:BWIDth[:CHANnel&lt;ch&gt;]</code> .....	940
<code>[SENSe:]POWer:ACHannel:SBLock&lt;sb&gt;:BANDwidth[:CHANnel&lt;ch&gt;]</code> .....	940
<code>[SENSe:]POWer:ACHannel:SBLock&lt;sb&gt;:CENTer[:CHANnel&lt;ch&gt;]</code> .....	940
<code>[SENSe:]POWer:ACHannel:SBLock&lt;sb&gt;:FREQuency:CENTer</code> .....	941

---

#### `[SENSe:]POWer:ACHannel:FILTer:ALPHA:SBLock<sb>:CHANnel<ch>` <Alpha>

Defines the roll-off factor for the specified transmission channel's weighting filter.

##### Suffix:

<sb>	1 to 8 sub block number
<ch>	1..n Tx channel number

##### Parameters:

<Alpha>	Roll-off factor
	Range: 0 to 1
	*RST: 0.22

**Manual operation:** See "[Weighting Filters](#)" on page 183

---

#### `[SENSe:]POWer:ACHannel:FILTer[:STATe]:SBLock<sb>:CHANnel<ch>` <State>

Turns the weighting filter for the specified transmission channel on and off.

##### Suffix:

<sb>	1 to 8 sub block number
<ch>	1..n Tx channel number

##### Parameters:

<State>	ON   OFF   1   0
	*RST: W-CDMA: 1, other technologies: 0

**Manual operation:** See "[Weighting Filters](#)" on page 183

---

#### `[SENSe:]POWer:ACHannel:SBCount` <Number>

Defines the number of sub blocks, i.e. groups of transmission channels in an MSR signal.

For more information see [Chapter 6.2.3.4, "Measurement on multi-standard radio \(MSR\) signals"](#), on page 159.

**Parameters:**

<Number>                    Range:        1 to 8  
                                  \*RST:        1

**Manual operation:**    See "[Number of Sub Blocks](#)" on page 178

**[SENSe:]POWer:ACHannel:SBLock<sb>:BWIDth[:CHANnel<ch>] <Bandwidth>**  
**[SENSe:]POWer:ACHannel:SBLock<sb>:BANDwidth[:CHANnel<ch>]**  
                                  <Bandwidth>

Defines the bandwidth of the specified MSR Tx channel.

Is for MSR signals only (see [CALCulate<n>:MARKer<m>:FUNction:POWer<sb>:PRESet](#) on page 916).

**Suffix:**

<sb>                            1 to 8  
                                  sub block number

<ch>                            1..n  
                                  Tx channel number

**Parameters:**

<Bandwidth>                Bandwidth in Hz  
                                  Default unit: Hz

**Manual operation:**    See "[Tx Channel Bandwidth](#)" on page 183

**[SENSe:]POWer:ACHannel:SBLock<sb>:CENTer[:CHANnel<ch>] <Frequency>**

Defines the (absolute) center frequency of the specified MSR Tx channel.

Note that the position of the first Tx channel in the first sub block and the last Tx channel in the last sub block also affect the position of the adjacent channels.

Is for MSR signals only (see [CALCulate<n>:MARKer<m>:FUNction:POWer<sb>:PRESet](#) on page 916).

**Suffix:**

<sb>                            1 to 8  
                                  sub block number

<ch>                            1..n  
                                  Tx channel number

**Parameters:**

<Frequency>                absolute frequency in Hz  
                                  Default unit: Hz

**Manual operation:**    See "[Tx Center Frequency](#)" on page 183

---

**[SENSe:]POWer:ACHannel:SBLock<sb>:FREQUency:CENTer <Frequency>**

Defines the center of the specified MSR sub block. Note that the position of the sub block also affects the position of the adjacent gap (CACLR) channels.

Is for MSR signals only (see [CALCulate<n>:MARKer<m>:FUNction:POWer<sb>:PRESet](#) on page 916).

**Suffix:**

<sb>                                    1 to 8  
                                          sub block number

**Parameters:**

<Frequency>                           absolute frequency in Hz  
                                          Default unit: Hz

**Manual operation:**    See "[Sub Block / Center Freq](#)" on page 182

**MSR adjacent channel setup**

The functions for manual operation are described in [Chapter 6.2.5, "MSR ACLR configuration"](#), on page 175.

Useful commands for MSR adjacent channel setup described elsewhere:

- [Chapter 13.5.3.5, "Checking limits"](#), on page 925
- "[MSR channel names](#)" on page 966

**Remote commands exclusive to MSR adjacent channel setup:**

<a href="#">[SENSe:]POWer:ACHannel:SBLock&lt;sb&gt;:RFBWidth</a> .....	941
<a href="#">[SENSe:]POWer:ACHannel:SBLock&lt;sb&gt;:TECHnology[:CHANnel&lt;ch&gt;]</a> .....	942
<a href="#">[SENSe:]POWer:ACHannel:SBLock&lt;sb&gt;:TXCHannel:COUNT</a> .....	942
<a href="#">[SENSe:]POWer:ACHannel:SPACing:UACHannel</a> .....	943
<a href="#">[SENSe:]POWer:ACHannel:SPACing:UALTernate&lt;ch&gt;</a> .....	943
<a href="#">[SENSe:]POWer:ACHannel:SSETup</a> .....	943
<a href="#">[SENSe:]POWer:ACHannel:BWIDth:UACHannel</a> .....	944
<a href="#">[SENSe:]POWer:ACHannel:BANDwidth:UACHannel</a> .....	944
<a href="#">[SENSe:]POWer:ACHannel:BANDwidth:UALTernate&lt;ch&gt;</a> .....	944
<a href="#">[SENSe:]POWer:ACHannel:BANDwidth:UALTernate&lt;ch&gt;</a> .....	944
<a href="#">[SENSe:]POWer:ACHannel:FILTer:ALPHa:UACHannel</a> .....	945
<a href="#">[SENSe:]POWer:ACHannel:FILTer:ALPHa:UALTernate&lt;ch&gt;</a> .....	945
<a href="#">[SENSe:]POWer:ACHannel:FILTer[:STATE]:UACHannel</a> .....	945
<a href="#">[SENSe:]POWer:ACHannel:FILTer[:STATE]:UALTernate&lt;ch&gt;</a> .....	945

---

**[SENSe:]POWer:ACHannel:SBLock<sb>:RFBWidth <Bandwidth>**

Defines the bandwidth of the individual MSR sub block. Note that sub block ranges also affect the position of the adjacent gap channels (CACLR).

Is for MSR signals only (see [CALCulate<n>:MARKer<m>:FUNction:POWer<sb>:PRESet](#) on page 916).

**Suffix:**

<sb> 1 to 8  
sub block number

**Parameters:**

<Bandwidth> Bandwidth in Hz  
Default unit: Hz

**Manual operation:** See "[RF Bandwidth](#)" on page 182

**[SENSe:]POWer:ACHannel:SBLock<sb>:TECHnology[:CHANnel<ch>]**  
<Standard>

Defines the technology used for transmission by the specified MSR Tx channel.

Is for MSR signals only (see [CALCulate<n>:MARKer<m>:FUNction:POWer<sb>:PRESet](#) on page 916).

**Suffix:**

<sb> 1 to 8  
sub block number

<ch> 1..n  
Tx channel number

**Parameters:**

<Standard> Technology used for transmission

**GSM**

Transmission according to GSM standard

**WCDMa**

Transmission according to W-CDMA standard

**LTE\_1\_40 | LTE\_3\_00 | LTE\_5\_00 | LTE\_10\_00 | LTE\_15\_00 |  
LTE\_20\_00**

Transmission according to LTE standard for different channel bandwidths

**NR5G\_fr1\_5 | NR5G\_fr1\_10 | NR5G\_fr1\_15 | NR5G\_fr1\_20 |  
NR5G\_fr1\_25 | NR5G\_fr1\_30 | NR5G\_fr1\_40 | NR5G\_fr1\_50 |  
NR5G\_fr1\_60 | NR5G\_fr1\_70 | NR5G\_fr1\_80 | NR5G\_fr1\_90 |  
NR5G\_fr1\_100 | NR5G\_fr2\_50 | NR5G\_fr2\_100 |  
NR5G\_fr2\_200 | NR5G\_fr2\_400**

Transmission according to new radio 5G standard

**USER**

User-defined transmission; no automatic preconfiguration possible

**Manual operation:** See "[Technology Used for Transmission](#)" on page 183

**[SENSe:]POWer:ACHannel:SBLock<sb>:TXCHannel:COUNT** <Number>

Defines the number of transmission channels the specific sub block contains.

Is for MSR signals only (see [CALCulate<n>:MARKer<m>:FUNCTION:POWER<sb>:PRESet](#) on page 916).

**Suffix:**

<sb>                    1 to 8  
                              sub block number

**Parameters:**

<Number>                Range:        1 to 18  
                              \*RST:        1

**Manual operation:** See "[Number of Tx Channels \(Tx Count\)](#)" on page 182

**[SENSe:]POWER:ACHannel:SPACing:UACHannel <Spacing>**

Defines the distance from the transmission channel to the upper adjacent channel.

For MSR signals, this command defines the distance from the CF of the last Tx channel in the last sub block to the upper adjacent channel in asymmetrical configurations. To configure the spacing for the lower adjacent channel use the [\[SENSe:\]POWER:ACHannel:SPACing\[:ACHannel\]](#) command.

**Parameters:**

<Spacing>                Range:        100 Hz to 2000 MHz  
                              \*RST:        14 kHz  
                              Default unit: Hz

**Manual operation:** See "[Adjacent Channel Spacings](#)" on page 185

**[SENSe:]POWER:ACHannel:SPACing:UALternate<ch> <Spacing>**

Defines the distance from transmission channel to the upper alternate channels.

For MSR signals, this command defines the distance from the CF of the last Tx channel in the last sub block to the upper alternate channel in asymmetrical configurations. To configure the spacing for the lower alternate channel, use the [\[SENSe:\]POWER:ACHannel:SPACing:ALternate<ch>](#) command.

**Suffix:**

<ch>                    1..n  
                              Alternate channel number

**Parameters:**

<Spacing>                Range:        100 Hz to 2000 MHz  
                              \*RST:        40 kHz (ALT1), 60 kHz (ALT2), 80 kHz (ALT3), ...  
                              Default unit: Hz

**Manual operation:** See "[Adjacent Channel Spacings](#)" on page 185

**[SENSe:]POWER:ACHannel:SSETup <State>**

Defines whether adjacent channels are defined symmetrically or not.

For more information see [Chapter 6.2.3.4, "Measurement on multi-standard radio \(MSR\) signals"](#), on page 159.

**Parameters:**

<State> ON | OFF | 1 | 0

**ON | 1**  
The upper and lower adjacent and alternate channels are defined symmetrically. This is the default behaviour and corresponds to the behavior in firmware versions before 2.10.

**OFF | 0**  
The upper and lower channels can be configured differently.

\*RST: 1

**Manual operation:** See "[Symmetrical Adjacent Setup](#)" on page 180

**[SENSe:]POWer:ACHannel:BWIDth:UACHannel <Bandwidth>**  
**[SENSe:]POWer:ACHannel:BANDwidth:UACHannel <Bandwidth>**

Defines the channel bandwidth of the upper adjacent channel in asymmetrical configurations.

The adjacent channel is the first pair of channels next to the transmission channels. To configure the bandwidth for the lower adjacent channel, use the [\[SENSe:\]POWer:ACHannel:BANDwidth:ACHannel](#) command.

Steep-edged channel filters are available for fast ACLR measurements.

**Parameters:**

<Bandwidth> Range: 100 Hz to 1000 MHz  
 \*RST: 14 kHz  
 Default unit: Hz

**Manual operation:** See "[Adjacent Channel Bandwidths](#)" on page 185

**[SENSe:]POWer:ACHannel:BWIDth:UALTernate<ch> <Bandwidth>**  
**[SENSe:]POWer:ACHannel:BANDwidth:UALTernate<ch> <Bandwidth>**

Defines the channel bandwidth of the upper alternate channels in asymmetrical configurations. To configure the bandwidth for the lower alternate channel, use the [\[SENSe:\]POWer:ACHannel:BANDwidth:ALTernate<ch>](#) command.

Steep-edged channel filters are available for fast ACLR measurements.

**Suffix:**

<ch> 1..n  
 Alternate channel number

**Parameters:**

<Bandwidth> Range: 100 Hz to 1000 MHz  
 \*RST: 14 kHz  
 Default unit: Hz

**Manual operation:** See "[Adjacent Channel Bandwidths](#)" on page 185



**[SENSe:]POWer:ACHannel:FILTer:ALPHa:UACHannel <Alpha>**

Defines the roll-off factor for the upper adjacent channel weighting filter for asymmetrical MSR signals. To configure the factor for the upper adjacent channel, use the [\[SENSe:\]POWer:ACHannel:FILTer:ALPHa:ACHannel](#) command.

**Parameters:**

<Alpha>                      Roll-off factor  
                                  Range:        0 to 1  
                                  \*RST:        0.22

**Manual operation:**    See "[Weighting Filters](#)" on page 186

**[SENSe:]POWer:ACHannel:FILTer:ALPHa:UALTernate<ch> <Alpha>**

Defines the roll-off factor for the upper alternate channels' weighting filter for asymmetrical MSR signals. To configure the factor for the upper alternate channels, use the [\[SENSe:\]POWer:ACHannel:FILTer:ALPHa:ALTernate<ch>](#) command.

**Suffix:**

<ch>                            1..n  
                                  Alternate channel number

**Parameters:**

<Alpha>                      Roll-off factor  
                                  Range:        0 to 1  
                                  \*RST:        0.22

**Manual operation:**    See "[Weighting Filters](#)" on page 186

**[SENSe:]POWer:ACHannel:FILTer[:STATe]:UACHannel <State>**

Turns the weighting filter for the upper adjacent channel on and off for asymmetrical MSR signals. To configure the factor for the lower adjacent channel, use the [\[SENSe:\]POWer:ACHannel:FILTer\[:STATe\]:ACHannel](#) command.

**Parameters:**

<State>                      ON | OFF | 1 | 0  
                                  \*RST:        0

**Manual operation:**    See "[Weighting Filters](#)" on page 186

**[SENSe:]POWer:ACHannel:FILTer[:STATe]:UALTernate<ch> <State>**

Turns the weighting filter for the upper alternate channels on and off for asymmetrical MSR signals. To configure the factor for the lower alternate channels, use the [\[SENSe:\]POWer:ACHannel:FILTer\[:STATe\]:ALTernate<ch>](#) command.

**Suffix:**

<ch>                            1..n  
                                  Alternate channel number

**Parameters:**

<State> ON | OFF | 1 | 0  
 \*RST: 0

**Manual operation:** See ["Weighting Filters"](#) on page 186

**General gap channel setup**

[SENSe:]POWer:ACHannel:AGCHannels..... 946  
 [SENSe:]POWer:ACHannel:GAP<gap>:MODE..... 946

**[SENSe:]POWer:ACHannel:AGCHannels <State>**

Activates or deactivates gap channels in an MSR signal.

For more information see [Chapter 6.2.3.4, "Measurement on multi-standard radio \(MSR\) signals"](#), on page 159.

**Parameters:**

<State> ON | OFF | 1 | 0

**ON | 1**

The gap channels are displayed and channel power results are calculated and displayed in the Result Summary.

**OFF | 0**

The gap channels are not displayed in the diagram and channel power results are not calculated nor displayed in the Result Summary.

\*RST: 1

**Manual operation:** See ["Activate Gaps"](#) on page 188

**[SENSe:]POWer:ACHannel:GAP<gap>:MODE <Mode>**

Defines how gap channels are configured.

**Suffix:**

<gap> 1..n  
 irrelevant

**Parameters:**

<Mode> AUTO | MANual

**AUTO**

In "Auto" mode, upper and lower gap channels are configured identically, so only two channels need to be configured (gap 1, gap 2). Gap channels are configured identically for all gaps, if more than two sub blocks are defined. Depending on the defined minimum gap size, the actual number of evaluated gap channels is determined automatically.

See also [\[SENSe:\]POWer:ACHannel:GAP<gap>\[:AUTO\]:MSIZe](#) on page 951.

**MANual**

In "Manual" mode, up to four channels can be configured individually for each gap. Active gap channels are always evaluated, regardless of the gap size.

See also `[SENSe:]POWer:ACHannel:GCHannel[:STATe]:GAP<gap>:MANual:LOWer` on page 964 and `[SENSe:]POWer:ACHannel:GCHannel[:STATe]:GAP<gap>:MANual:UPPer` on page 964.

\*RST: AUTO

**Example:** `SENS:POW:ACH:GAP:MODE MAN`

**Example:** See "Example: configuring and performing an asymmetrical MSR ACLR measurement" on page 975

**Manual operation:** See "Gap Mode" on page 188

**Automatic (symmetrical) configuration**

The following commands are only available for symmetrical (automatic) configuration of gap channels (see `[SENSe:]POWer:ACHannel:GAP<gap>:MODE` on page 946).

<code>CALCulate&lt;n&gt;:LIMit&lt;li&gt;:ACPower:GAP&lt;gap&gt;[:AUTO]:ABSolute</code> .....	947
<code>CALCulate&lt;n&gt;:LIMit&lt;li&gt;:ACPower:GAP&lt;gap&gt;[:AUTO]:ABSolute:STATe</code> .....	948
<code>CALCulate&lt;n&gt;:LIMit&lt;li&gt;:ACPower:GAP&lt;gap&gt;[:AUTO]:ACLR[:RELative]</code> .....	948
<code>CALCulate&lt;n&gt;:LIMit&lt;li&gt;:ACPower:GAP&lt;gap&gt;[:AUTO]:ACLR[:RELative]:STATe</code> .....	949
<code>CALCulate&lt;n&gt;:LIMit&lt;li&gt;:ACPower:GAP&lt;gap&gt;[:AUTO]:CACLR[:RELative]</code> .....	949
<code>CALCulate&lt;n&gt;:LIMit&lt;li&gt;:ACPower:GAP&lt;gap&gt;[:AUTO]:CACLR[:RELative]:STATe</code> .....	949
<code>[SENSe:]POWer:ACHannel:BWIDth:GAP&lt;gap&gt;[:AUTO]</code> .....	950
<code>[SENSe:]POWer:ACHannel:BANDwidth:GAP&lt;gap&gt;[:AUTO]</code> .....	950
<code>[SENSe:]POWer:ACHannel:FILTer:ALPHa:GAP&lt;gap&gt;[:AUTO]</code> .....	950
<code>[SENSe:]POWer:ACHannel:FILTer[:STATe]:GAP&lt;gap&gt;[:AUTO]</code> .....	951
<code>[SENSe:]POWer:ACHannel:GAP&lt;gap&gt;[:AUTO]:MSIZe</code> .....	951
<code>[SENSe:]POWer:ACHannel:SPACing:GAP&lt;gap&gt;[:AUTO]</code> .....	951

---

**CALCulate<n>:LIMit<li>:ACPower:GAP<gap>[:AUTO]:ABSolute** <Limit>[, <Reserved>]

Defines the absolute limit of the specified gap (CACLR) channel.

If you define both an absolute limit and a relative limit, the FSW uses the lower value for the limit check.

**Suffix:**

<n>	irrelevant
<li>	irrelevant
<gap>	1   2 Gap (CACLR) channel number

**Parameters:**

<Limit>	Defines the absolute limit of the specified gap channel. Default unit: dBm
---------	-------------------------------------------------------------------------------

<Reserved> Ignored.

**Example:** `CALC:LIM:ACP:GAP2:ABS 44.2dBm`

**CALCulate<n>:LIMit<li>:ACPpower:GAP<gap>[:AUTO]:ABSolute:STATe <State>**

Turns the absolute limit check for the specified gap (CACLR) channel on and off.

You have to activate the general ACLR limit check before using this command with `CALCulate<n>:LIMit<li>:ACPpower[:STATe]`.

**Suffix:**

<n> irrelevant

<li> irrelevant

<gap> 1 | 2  
Gap (CACLR) channel number

**Parameters:**

<State> ON | OFF | 1 | 0

\*RST: 0

**Example:** `CALC:LIM:ACP:GAP1:ABS:STAT ON`

**CALCulate<n>:LIMit<li>:ACPpower:GAP<gap>[:AUTO]:ACLR[:RELative] <Limit>[, <UpperLimit>]**

Defines the relative limit for the ACLR power in the specified gap channel. The reference value for the relative limit is the measured channel power.

If you define both an absolute limit and a relative limit, the FSW uses the lower value for the limit check.

**Suffix:**

<n> irrelevant

<li> irrelevant

<gap> 1 | 2  
Gap (CACLR) channel number

**Parameters:**

<Limit> Defines the relative limit for the ACLR power in the specified gap channel in dB.

Default unit: DB

<UpperLimit> Ignored.

Default unit: DB

**Example:** `CALC:LIM:ACP:GAP1:ACLR:REL 3dB`

---

**CALCulate<n>:LIMit<li>:ACPpower:GAP<gap>[:AUTO]:ACLR[:RELative]:STATe**  
 <State>

Turns the relative limit check for the specified gap (CACLR) channel on and off.

You have to activate the general ACLR limit check before using this command with `CALCulate<n>:LIMit<li>:ACPpower[:STATe]`.

**Suffix:**

<n>                    irrelevant  
 <li>                    irrelevant  
 <gap>                 1 | 2  
                           Gap (CACLR) channel number

**Parameters:**

<State>                ON | OFF | 1 | 0  
 \*RST:                 0

**Example:**            `CALC:LIM:ACP:GAP1:ACLR:REL:STAT ON`

---

**CALCulate<n>:LIMit<li>:ACPpower:GAP<gap>[:AUTO]:CACLR[:RELative]**  
 <Limit>, <UpperLimit>

Defines the relative limit of the specified gap (CACLR) channel. The reference value for the relative limit is the measured channel power.

If you define both an absolute limit and a relative limit, the FSW uses the lower value for the limit check.

**Suffix:**

<n>                    irrelevant  
 <li>                    irrelevant  
 <gap>                 1 | 2  
                           Gap (CACLR) channel number

**Parameters:**

<Limit>                Defines the relative limit of the specified gap channel in dB.  
                           Default unit: DB  
 <UpperLimit>        Optional: Defines the relative upper limit of the specified gap  
                           channel.  
                           Default unit: dB

**Example:**            `CALC:LIM:ACP:GAP1:REL 3dB,0`

---

**CALCulate<n>:LIMit<li>:ACPpower:GAP<gap>[:AUTO]:CACLR[:RELative]:STATe**  
 <State>

Turns the relative limit check for the specified gap (CACLR) channel on and off.

You have to activate the general ACLR limit check before using this command with `CALCulate<n>:LIMit<li>:ACPower[:STATe]`.

**Suffix:**

<n> irrelevant  
 <li> irrelevant  
 <gap> 1 | 2  
 Gap (CACLR) channel number

**Parameters:**

<State> ON | OFF | 0 | 1  
**OFF | 0**  
 Switches the function off  
**ON | 1**  
 Switches the function on

**Example:** `CALC:LIM:ACP:GAP1:REL:STAT ON`

**[SENSe:]POWer:ACHannel:BWIDth:GAP<gap>[:AUTO] <Bandwidth>**  
**[SENSe:]POWer:ACHannel:BANDwidth:GAP<gap>[:AUTO] <Bandwidth>**

Defines the bandwidth of the MSR gap (CACLR) channel in all sub block gaps.

Is for MSR signals only (see `CALCulate<n>:MARKer<m>:FUNction:POWer<sb>:PRESet` on page 916).

**Suffix:**

<gap> 1 | 2  
 Gap (CACLR) channel number

**Parameters:**

<Bandwidth> numeric value in Hz  
 \*RST: 3.84 MHz  
 Default unit: Hz

**Example:** `SENS:POW:ACH:BAND:GAP2 5MHZ`

**Manual operation:** See "Gap Channel Bandwidths" on page 190

**[SENSe:]POWer:ACHannel:FILTer:ALPHA:GAP<gap>[:AUTO] <Alpha>**

Defines the roll-off factor for the specified gap (CACLR) channel's weighting filter in all sub block gaps.

**Suffix:**

<gap> 1 | 2  
 Gap (CACLR) channel number

**Parameters:**

<Alpha> Roll-off factor  
 Range: 0 to 1  
 \*RST: 0.22

**Example:** `SENS:POW:ACH:FILT:ALPH:GAP2 0.2`

**Manual operation:** See ["Weighting Filters"](#) on page 191

**[SENSe:]POWer:ACHannel:FILTer[:STATe]:GAP<gap>[:AUTO] <State>**

Turns the weighting filter for the specified gap (CACLR) channel in all sub block gaps on and off.

**Suffix:**

<gap> 1 | 2  
Gap (CACLR) channel number

**Parameters:**

<State> ON | OFF | 1 | 0  
\*RST: 0

**Example:** `SENS:POW:ACH:FILT:GAP2 ON`

**Manual operation:** See ["Weighting Filters"](#) on page 191

**[SENSe:]POWer:ACHannel:GAP<gap>[:AUTO]:MSIZe <Bandwidth>**

If the gap between the sub blocks does not exceed the specified bandwidth, the gap channels are not displayed in the diagram, and the gap channel results are not calculated in the result summary.

Is only available for symmetrical gap channels in "Auto" gap mode (see [\[SENSe:\]POWer:ACHannel:GAP<gap>:MODE](#) on page 946).

**Suffix:**

<gap> 1 | 2  
Gap channel number

**Parameters:**

<Bandwidth> numeric value in Hz  
\*RST: gap1: 5 MHz; gap2: 10 MHz  
Default unit: Hz

**Example:** `POW:ACH:GAP2:MSIZ 5 MHz`  
Gap channel 2 is only evaluated if the gap is wider than 5 MHz.

**Manual operation:** See ["Minimum gap size to show Gap 1/ Minimum gap size to show Gap 2"](#) on page 189

**[SENSe:]POWer:ACHannel:SPACing:GAP<gap>[:AUTO] <Spacing>**

Defines the distance from sub block to the specified gap channel.

In "Auto" gap mode, channels in the upper gap are identical to those in the lower gap. Thus, only 2 gap channels are configured.

The spacing for gap channels is defined in relation to the outer edges of the surrounding sub blocks, i.e.

## Configuring and performing measurements

Spacing = [CF of the gap channel] - [left sub block center] + ([RF bandwidth of left sub block] / 2)

(See also [Figure 6-24](#) and [Figure 6-26](#).)

**Suffix:**

<gap> 1 | 2  
Gap channel number

**Parameters:**

<Spacing> numeric value in Hz  
\*RST: 2.5 MHz  
Default unit: HZ

**Example:** SENS:POW:ACH:SPAC:GAP2 5MHZ

**Manual operation:** See "[Gap Channel Spacing](#)" on page 189

**Manual (asymmetrical) configuration**

The following commands are only available for asymmetrical (manual) configuration of gap channels (see [[SENSe](#)]:[[POWer](#)]:[[ACHannel](#)]:[[GAP](#)<gap>]:[[MODE](#)] on page 946).

CALCulate<n>:LIMit<li>:ACPower:GAP<gap>:MANual:LOWer:ABSolute.....	953
CALCulate<n>:LIMit<li>:ACPower:GAP<gap>:MANual:LOWer:ABSolute:STATe.....	953
CALCulate<n>:LIMit<li>:ACPower:GAP<gap>:MANual:LOWer:ACLR[:RELative].....	954
CALCulate<n>:LIMit<li>:ACPower:GAP<gap>:MANual:LOWer:ACLR[:RELative]:STATe.....	955
CALCulate<n>:LIMit<li>:ACPower:GAP<gap>:MANual:LOWer[:CACLR][:RELative].....	955
CALCulate<n>:LIMit<li>:ACPower:GAP<gap>:MANual:LOWer[:CACLR][:RELative]:STATe....	956
CALCulate<n>:LIMit<li>:ACPower:GAP<gap>:MANual:UPPer:ABSolute.....	957
CALCulate<n>:LIMit<li>:ACPower:GAP<gap>:MANual:UPPer:ABSolute:STATe.....	957
CALCulate<n>:LIMit<li>:ACPower:GAP<gap>:MANual:UPPer:ACLR[:RELative].....	958
CALCulate<n>:LIMit<li>:ACPower:GAP<gap>:MANual:UPPer:ACLR[:RELative]:STATe.....	958
CALCulate<n>:LIMit<li>:ACPower:GAP<gap>:MANual:UPPer[:CACLR][:RELative].....	959
CALCulate<n>:LIMit<li>:ACPower:GAP<gap>:MANual:UPPer[:CACLR][:RELative]:STATe.....	960
[SENSe]:[POWer]:[ACHannel]:[BWIDth]:[GAP<gap>]:[MANual]:[LOWer].....	960
[SENSe]:[POWer]:[ACHannel]:[BANDwidth]:[GAP<gap>]:[MANual]:[LOWer].....	960
[SENSe]:[POWer]:[ACHannel]:[BWIDth]:[GAP<gap>]:[MANual]:[UPPer].....	961
[SENSe]:[POWer]:[ACHannel]:[BANDwidth]:[GAP<gap>]:[MANual]:[UPPer].....	961
[SENSe]:[POWer]:[ACHannel]:[FILTer[:STATe]][:GAP<gap>]:[MANual]:[LOWer].....	961
[SENSe]:[POWer]:[ACHannel]:[FILTer[:STATe]][:GAP<gap>]:[MANual]:[UPPer].....	962
[SENSe]:[POWer]:[ACHannel]:[FILTer:ALPHa]:[GAP<gap>]:[MANual]:[LOWer].....	963
[SENSe]:[POWer]:[ACHannel]:[FILTer:ALPHa]:[GAP<gap>]:[MANual]:[UPPer].....	963
[SENSe]:[POWer]:[ACHannel]:[GCHannel[:STATe]][:GAP<gap>]:[MANual]:[LOWer].....	964
[SENSe]:[POWer]:[ACHannel]:[GCHannel[:STATe]][:GAP<gap>]:[MANual]:[UPPer].....	964
[SENSe]:[POWer]:[ACHannel]:[SPACing]:[GAP<gap>]:[MANual]:[LOWer].....	965
[SENSe]:[POWer]:[ACHannel]:[SPACing]:[GAP<gap>]:[MANual]:[UPPer].....	965



---

**CALCulate<n>:LIMit<li>:ACPpower:GAP<gap>:MANual:LOWer:ABSolute**  
 <SBGaps>, <Limit>

**CALCulate<n>:LIMit<li>:ACPpower:GAP<gap>:MANual:LOWer:ABSolute?**  
 <SBGaps>

Defines the absolute limit of the specified lower gap (CACLR) channel.

If you define both an absolute limit and a relative limit, the FSW uses the lower value for the limit check.

**Suffix:**

<n>                    irrelevant  
 <li>                    irrelevant  
 <gap>                 1 | 2  
                           Gap (CACLR) channel number

**Parameters:**

<Limit>                Defines the absolute limit of the specified gap channel.  
                           Default unit: dBm

**Parameters for setting and query:**

<SBGaps>             AB | BC | CD | DE | EF | FG | GH  
                           Name of the gap, defined by the letters of the surrounding sub  
                           blocks (e.g. "AB" for the gap between sub blocks A and B).

**Example:**            CALC:LIM:ACP:GAP2:MAN:LOW:ABS AB,44.2dBm

**Example:**            CALC:LIM:ACP:GAP:MAN:LOW:ABS? BC,DEF

**Example:**            See ["Example: configuring and performing an asymmetrical MSR ACLR measurement"](#) on page 975

---

**CALCulate<n>:LIMit<li>:ACPpower:GAP<gap>:MANual:LOWer:ABSolute:STATe**  
 <SBGaps>, <State>

**CALCulate<n>:LIMit<li>:ACPpower:GAP<gap>:MANual:LOWer:ABSolute:STATe?**  
 <SBGaps>

Turns the absolute limit check for the specified lower gap (CACLR) channel on and off.

You have to activate the general ACLR limit check before using this command with [CALCulate<n>:LIMit<li>:ACPpower\[:STATe\]](#).

**Suffix:**

<n>                    1..n  
 <li>                    1..n  
 <gap>                 1 | 2  
                           Gap (CACLR) channel number

**Parameters:**

<State>                ON | OFF | 0 | 1  
                           **OFF | 0**  
                           Switches the function off

**ON | 1**

Switches the function on

\*RST: 0

**Parameters for setting and query:**

&lt;SBGaps&gt; AB | BC | CD | DE | EF | FG | GH

Name of the gap, defined by the letters of the surrounding sub blocks (e.g. "AB" for the gap between sub blocks A and B).

**Example:**

CALC:LIM:ACP:GAP2:MAN:LOW:ABS:STAT BC,ON

**Example:**See ["Example: configuring and performing an asymmetrical MSR ACLR measurement"](#) on page 975**CALCulate<n>:LIMit<li>:ACPpower:GAP<gap>:MANual:LOWer:ACLR[:RELative]**  
<SBGaps>, <Limit>**CALCulate<n>:LIMit<li>:ACPpower:GAP<gap>:MANual:LOWer:ACLR[:RELative]?**  
<SBGaps>

Defines the relative limit for the ACLR power in the specified lower gap channel. The reference value for the relative limit is the measured channel power.

If you define both an absolute limit and a relative limit, the FSW uses the lower value for the limit check.

**Suffix:**

&lt;n&gt; irrelevant

&lt;li&gt; irrelevant

<gap> 1 | 2  
Gap channel number**Parameters:**

&lt;Limit&gt; Defines the relative limit for the ACLR power in the specified gap channel.

Default unit: DB

**Parameters for setting and query:**

&lt;SBGaps&gt; AB | BC | CD | DE | EF | FG | GH

Name of the gap, defined by the letters of the surrounding sub blocks (e.g. "AB" for the gap between sub blocks A and B).

**Example:**

CALC:LIM:ACP:GAP1:MAN:LOW:ACLR:REL AB,3dB

**Example:**See ["Example: configuring and performing an asymmetrical MSR ACLR measurement"](#) on page 975

---

```
CALCulate<n>:LIMit<li>:ACPower:GAP<gap>:MANual:LOWer:ACLR[:RELative]:  
STATe <SBGaps>, <State>
```

```
CALCulate<n>:LIMit<li>:ACPower:GAP<gap>:MANual:LOWer:ACLR[:RELative]:  
STATe? <SBGaps>
```

Turns the relative limit check for the specified lower gap (CACLR) channel on and off.

You have to activate the general ACLR limit check before using this command with [CALCulate<n>:LIMit<li>:ACPpower\[:STATe\]](#).

**Suffix:**

<n>	irrelevant
<li>	irrelevant
<gap>	1   2 Gap (CACLR) channel number

**Parameters:**

<State>	ON   OFF   0   1 <b>OFF   0</b> Switches the function off <b>ON   1</b> Switches the function on *RST: 0
---------	-------------------------------------------------------------------------------------------------------------------------

**Parameters for setting and query:**

<SBGaps>	AB   BC   CD   DE   EF   FG   GH Name of the gap, defined by the letters of the surrounding sub blocks (e.g. "AB" for the gap between sub blocks A and B).
----------	---------------------------------------------------------------------------------------------------------------------------------------------------------------

**Example:** `CALC:LIM:ACP:GAP2:MAN:LOW:ACLR:STAT BC,ON`

**Example:** See ["Example: configuring and performing an asymmetrical MSR ACLR measurement"](#) on page 975

---

```
CALCulate<n>:LIMit<li>:ACPower:GAP<gap>:MANual:LOWer[:CACLR][:  
RELative] <SBGaps>, <Limit>
```

```
CALCulate<n>:LIMit<li>:ACPower:GAP<gap>:MANual:LOWer[:CACLR][:  
RELative]? <SBGaps>
```

Defines the relative limit of the specified lower gap (CACLR) channel. The reference value for the relative limit is the measured channel power.

If you define both an absolute limit and a relative limit, the FSW uses the lower value for the limit check.

**Suffix:**

<n>	irrelevant
<li>	irrelevant
<gap>	1   2 Gap (CACLR) channel number

**Parameters:**

<Limit> Defines the relative limit of the specified gap channel in dB.  
Default unit: DB

**Parameters for setting and query:**

<SBGaps> AB | BC | CD | DE | EF | FG | GH  
Name of the gap, defined by the letters of the surrounding sub blocks (e.g. "AB" for the gap between sub blocks A and B).

**Example:** `CALC:LIM:ACPower:GAP2:MANual:LOWer BC, 5`

**Example:** See ["Example: configuring and performing an asymmetrical MSR ACLR measurement"](#) on page 975

**CALCulate<n>:LIMit<li>:ACPower:GAP<gap>:MANual:LOWer[:CACLR][:RELative]:STATe <SBGaps>, <State>**

**CALCulate<n>:LIMit<li>:ACPower:GAP<gap>:MANual:LOWer[:CACLR][:RELative]:STATe? <SBGaps>**

Turns the relative limit check for the specified lower gap (CACLR) channel on and off.

You have to activate the general ACLR limit check before using this command with `CALCulate<n>:LIMit<li>:ACPower[:STATe]`.

**Suffix:**

<n> irrelevant  
<li> irrelevant  
<gap> 1 | 2  
Gap (CACLR) channel number

**Parameters:**

<State> ON | OFF | 0 | 1  
**OFF | 0**  
Switches the function off  
**ON | 1**  
Switches the function on  
\*RST: 0

**Parameters for setting and query:**

<SBGaps> AB | BC | CD | DE | EF | FG | GH  
Name of the gap, defined by the letters of the surrounding sub blocks (e.g. "AB" for the gap between sub blocks A and B).

**Example:** `CAL:LIMit:ACPower:GAP2:MAN:LOW:STAT BC, ON`

**Example:** See ["Example: configuring and performing an asymmetrical MSR ACLR measurement"](#) on page 975

---

```
CALCulate<n>:LIMit<li>:ACPower:GAP<gap>:MANual:UPPer:ABSolute
    <SBGaps>, <Limit>
```

```
CALCulate<n>:LIMit<li>:ACPower:GAP<gap>:MANual:UPPer:ABSolute?
    <SBGaps>
```

Defines the absolute limit of the specified upper gap (CACLR) channel.

If you define both an absolute limit and a relative limit, the FSW uses the lower value for the limit check.

**Suffix:**

<n>	irrelevant
<li>	irrelevant
<gap>	1   2 Gap (CACLR) channel number

**Parameters:**

<Limit>	Defines the absolute limit of the specified gap channel. Default unit: dBm
---------	-------------------------------------------------------------------------------

**Parameters for setting and query:**

<SBGaps>	AB   BC   CD   DE   EF   FG   GH Name of the gap, defined by the letters of the surrounding sub blocks (e.g. "AB" for the gap between sub blocks A and B).
----------	---------------------------------------------------------------------------------------------------------------------------------------------------------------

**Example:**            `CALC:LIM:ACP:GAP2:MAN:UPP:ABS AB,44.2dBm`

**Example:**            See ["Example: configuring and performing an asymmetrical MSR ACLR measurement"](#) on page 975

---

```
CALCulate<n>:LIMit<li>:ACPower:GAP<gap>:MANual:UPPer:ABSolute:STATe
    <SBGaps>, <State>
```

```
CALCulate<n>:LIMit<li>:ACPower:GAP<gap>:MANual:UPPer:ABSolute:STATe?
    <SBGaps>
```

Turns the absolute limit check for the specified upper gap (CACLR) channel on and off.

You have to activate the general ACLR limit check before using this command with `CALCulate<n>:LIMit<li>:ACP[[:STATe]]`.

**Suffix:**

<n>	irrelevant
<li>	irrelevant
<gap>	1   2 Gap (CACLR) channel number

**Parameters:**

<State>	ON   OFF   0   1 <b>OFF   0</b> Switches the function off
---------	-----------------------------------------------------------------

**ON | 1**

Switches the function on

\*RST: 0

**Parameters for setting and query:**

&lt;SBGaps&gt; AB | BC | CD | DE | EF | FG | GH

Name of the gap, defined by the letters of the surrounding sub blocks (e.g. "AB" for the gap between sub blocks A and B).

**Example:**

CALC:LIM:ACP:GAP2:MAN:UPP:ABS:STAT BC,ON

**Example:**See ["Example: configuring and performing an asymmetrical MSR ACLR measurement"](#) on page 975**CALCulate<n>:LIMit<li>:ACPpower:GAP<gap>:MANual:UPPer:ACLR[:RELative]**  
<SBGaps>, <Limit>**CALCulate<n>:LIMit<li>:ACPpower:GAP<gap>:MANual:UPPer:ACLR[:RELative]?**  
<SBGaps>

Defines the relative limit for the ACLR power in the specified upper gap channel. The reference value for the relative limit is the measured channel power.

If you define both an absolute limit and a relative limit, the FSW uses the lower value for the limit check.

**Suffix:**

&lt;n&gt; irrelevant

&lt;li&gt; irrelevant

<gap> 1 | 2  
Gap channel number**Parameters:**

&lt;Limit&gt; Defines the relative limit for the ACLR power in the specified gap channel in dB.

Default unit: DB

**Parameters for setting and query:**

&lt;SBGaps&gt; AB | BC | CD | DE | EF | FG | GH

Name of the gap, defined by the letters of the surrounding sub blocks (e.g. "AB" for the gap between sub blocks A and B).

**Example:**

CALC:LIM:ACP:GAP1:MAN:UPP:ACLR:REL AB,3dB

**CALCulate<n>:LIMit<li>:ACPpower:GAP<gap>:MANual:UPPer:ACLR[:RELative]:**  
**STATe** <SBGaps>, <State>**CALCulate<n>:LIMit<li>:ACPpower:GAP<gap>:MANual:UPPer:ACLR[:RELative]:**  
**STATe?** <SBGaps>

Turns the relative limit check for the specified upper gap (CACLR) channel on and off.

You have to activate the general ACLR limit check before using this command with `CALCulate<n>:LIMit<li>:ACPowEr[:STATe]`.

**Suffix:**

<n> irrelevant  
 <li> irrelevant  
 <gap> 1 | 2  
 Gap (CACLR) channel number

**Parameters:**

<State> ON | OFF | 0 | 1  
**OFF | 0**  
 Switches the function off  
**ON | 1**  
 Switches the function on  
 \*RST: 0

**Parameters for setting and query:**

<SBGaps> AB | BC | CD | DE | EF | FG | GH  
 Name of the gap, defined by the letters of the surrounding sub blocks (e.g. "AB" for the gap between sub blocks A and B).

**Example:**

`CALC:LIM:ACP:GAP2:MAN:UPP:ACLR:STAT BC,ON`

`CALCulate<n>:LIMit<li>:ACPowEr:GAP<gap>:MANual:UPPer[:CACLR][:RELative] <SBGaps>, <Limit>`

`CALCulate<n>:LIMit<li>:ACPowEr:GAP<gap>:MANual:UPPer[:CACLR][:RELative]? <SBGaps>`

Defines the relative limit of the specified upper gap (CACLR) channel. The reference value for the relative limit is the measured channel power.

If you define both an absolute limit and a relative limit, the FSW uses the lower value for the limit check.

**Suffix:**

<n> irrelevant  
 <li> irrelevant  
 <gap> 1 | 2  
 Gap (CACLR) channel number

**Parameters:**

<Limit> Defines the relative limit of the specified gap channel in dB.  
 Default unit: DB

**Parameters for setting and query:**

<SBGaps> AB | BC | CD | DE | EF | FG | GH  
 Name of the gap, defined by the letters of the surrounding sub blocks (e.g. "AB" for the gap between sub blocks A and B).

**Example:** `CALC:LIM:ACPower:GAP2:MANual:UPPer BC, 5`

---

**CALCulate<n>:LIMit<li>:ACPower:GAP<gap>:MANual:UPPer[:CACLR][:RELative]:STATe <SBGaps>, <State>**  
**CALCulate<n>:LIMit<li>:ACPower:GAP<gap>:MANual:UPPer[:CACLR][:RELative]:STATe? <SBGaps>**

Turns the relative limit check for the specified upper gap (CACLR) channel on and off.

You have to activate the general ACLR limit check before using this command with `CALCulate<n>:LIMit<li>:ACPower[:STATe]`.

**Suffix:**

<n> 1..n  
 <li> 1..n  
 <gap> 1 | 2  
 Gap (CACLR) channel number

**Parameters:**

<State> ON | OFF | 0 | 1  
**OFF | 0**  
 Switches the function off  
**ON | 1**  
 Switches the function on  
 \*RST: 0

**Parameters for setting and query:**

<SBGaps> AB | BC | CD | DE | EF | FG | GH  
 Name of the gap, defined by the letters of the surrounding sub blocks (e.g. "AB" for the gap between sub blocks A and B).

**Example:** `CAL:LIMit:ACPower:GAP2:MAN:UPP:STATe BC,ON`

---

**[SENSe:]POWer:ACHannel:BWIDth:GAP<gap>:MANual:LOWer <SBGaps>, <Bandwidth>**

**[SENSe:]POWer:ACHannel:BWIDth:GAP<gap>:MANual:LOWer? <SBGaps>**

**[SENSe:]POWer:ACHannel:BANDwidth:GAP<gap>:MANual:LOWer <SBGaps>, <Bandwidth>**

**[SENSe:]POWer:ACHannel:BANDwidth:GAP<gap>:MANual:LOWer? <SBGaps>**

Defines the bandwidth of the lower gap channel in the specified gap.

**Suffix:**

<gap> 1 | 2  
 Gap channel number

**Parameters:**

<Bandwidth> \*RST: 3.84 MHz  
 Default unit: HZ



**Parameters for setting and query:**

<SBGaps> AB | BC | CD | DE | EF | FG | GH  
 Name of the gap, defined by the letters of the surrounding sub blocks (e.g. "AB" for the gap between sub blocks A and B).

**Example:** POW:ACH:BAND:GAP:MAN:LOW BC, 5MHz

**Example:** POW:ACH:BWIDth:GAP:MAN:LOW? AB, MIN

**Example:** See ["Example: configuring and performing an asymmetrical MSR ACLR measurement"](#) on page 975

**Manual operation:** See ["Gap Channel Bandwidths"](#) on page 190

[SENSe:]POWer:ACHannel:BWIDth:GAP<gap>:MANual:UPPer <SBGaps>, <Bandwidth>

[SENSe:]POWer:ACHannel:BWIDth:GAP<gap>:MANual:UPPer? <SBGaps>

[SENSe:]POWer:ACHannel:BANDwidth:GAP<gap>:MANual:UPPer <SBGaps>, <Bandwidth>

[SENSe:]POWer:ACHannel:BANDwidth:GAP<gap>:MANual:UPPer? <SBGaps>

Defines the bandwidth of the upper gap channel in the specified gap.

**Suffix:**

<gap> 1 | 2  
 Gap channel number

**Parameters:**

<Bandwidth> \*RST: 3.84 MHz  
 Default unit: HZ

**Parameters for setting and query:**

<SBGaps> AB | BC | CD | DE | EF | FG | GH

Name of the gap, defined by the letters of the surrounding sub blocks (e.g. "AB" for the gap between sub blocks A and B).

**Example:** POW:ACH:BAND:GAP:MAN:UPP BC, 5MHz

**Example:** See ["Example: configuring and performing an asymmetrical MSR ACLR measurement"](#) on page 975

**Manual operation:** See ["Gap Channel Bandwidths"](#) on page 190

[SENSe:]POWer:ACHannel:FILTer[:STATe]:GAP<gap>:MANual:LOWer <SBGaps>, <State>

[SENSe:]POWer:ACHannel:FILTer[:STATe]:GAP<gap>:MANual:LOWer? <SBGaps>

Turns the weighting filter for the specified lower gap channel on and off.

**Suffix:**

<gap> 1 | 2  
Gap channel number

**Parameters:**

<State> ON | OFF | 0 | 1  
**OFF | 0**  
Switches the function off  
**ON | 1**  
Switches the function on  
\*RST: 0

**Parameters for setting and query:**

<SBGaps> AB | BC | CD | DE | EF | FG | GH  
Name of the gap, defined by the letters of the surrounding sub blocks (e.g. "AB" for the gap between sub blocks A and B).

**Example:** SENS:POW:ACH:FILT:GAB:MAN:LOW BC,ON

**Example:** See ["Example: configuring and performing an asymmetrical MSR ACLR measurement"](#) on page 975

**Manual operation:** See ["Weighting Filters"](#) on page 191

[SENSe:]POWer:ACHannel:FILTer[:STATe]:GAP<gap>:MANual:UPPer <SBGaps>,  
<State>

[SENSe:]POWer:ACHannel:FILTer[:STATe]:GAP<gap>:MANual:UPPer? <SBGaps>

Turns the weighting filter for the specified upper gap channel on and off.

**Suffix:**

<gap> 1 | 2  
Gap channel number

**Parameters:**

<State> ON | OFF | 0 | 1  
**OFF | 0**  
Switches the function off  
**ON | 1**  
Switches the function on  
\*RST: 0

**Parameters for setting and query:**

<SBGaps> AB | BC | CD | DE | EF | FG | GH  
Name of the gap, defined by the letters of the surrounding sub blocks (e.g. "AB" for the gap between sub blocks A and B).

**Example:** SENS:POW:ACH:FILT:GAP:MAN:UPP BC,ON

**Example:** See ["Example: configuring and performing an asymmetrical MSR ACLR measurement"](#) on page 975

**Manual operation:** See ["Weighting Filters"](#) on page 191

---

```
[SENSe:]POWer:ACHannel:FILTer:ALPHA:GAP<gap>:MANual:LOWer <SBGaps>,
<Alpha>
```

```
[SENSe:]POWer:ACHannel:FILTer:ALPHA:GAP<gap>:MANual:LOWer? <SBGaps>
```

Defines the roll-off factor for the specified lower gap channel's weighting filter.

**Suffix:**

```
<gap>          1 | 2
                Gap channel number
```

**Parameters:**

```
<Alpha>        Roll-off factor
                Range:    0 to 1
                *RST:    0.22
```

**Parameters for setting and query:**

```
<SBGaps>       AB | BC | CD | DE | EF | FG | GH
                Name of the gap, defined by the letters of the surrounding sub
                blocks (e.g. "AB" for the gap between sub blocks A and B).
```

**Example:**            `SENS:POW:ACH:FILT-ALPH:GAP:MAN:LOW BC,0.25`

**Example:**            See ["Example: configuring and performing an asymmetrical MSR ACLR measurement"](#) on page 975

**Manual operation:** See ["Weighting Filters"](#) on page 191

---

```
[SENSe:]POWer:ACHannel:FILTer:ALPHA:GAP<gap>:MANual:UPPer <SBGaps>,
<Alpha>
```

```
[SENSe:]POWer:ACHannel:FILTer:ALPHA:GAP<gap>:MANual:UPPer? <SBGaps>
```

Defines the roll-off factor for the specified upper gap channel's weighting filter.

Is only available for for asymmetrical (manual) configuration of gap channels (see [\[SENSe:\]POWer:ACHannel:GAP<gap>:MODE](#) on page 946).

**Suffix:**

```
<gap>          1 | 2
                Gap channel number
```

**Parameters:**

```
<Alpha>        Roll-off factor
                Range:    0 to 1
                *RST:    0.22
```

**Parameters for setting and query:**

```
<SBGaps>       AB | BC | CD | DE | EF | FG | GH
                Name of the gap, defined by the letters of the surrounding sub
                blocks (e.g. "AB" for the gap between sub blocks A and B).
```

**Example:**            `SENS:POW:ACH:FILT:ALPH:GAP2:MAN:UPP BC,0.25`

**Example:**            See ["Example: configuring and performing an asymmetrical MSR ACLR measurement"](#) on page 975

**Manual operation:** See ["Weighting Filters"](#) on page 191

---

```
[SENSe:]POWer:ACHannel:GCHannel[:STATe]:GAP<gap>:MANual:LOWer
<SBGaps>, <State>
```

```
[SENSe:]POWer:ACHannel:GCHannel[:STATe]:GAP<gap>:MANual:LOWer?
<SBGaps>
```

Defines which lower gap channels are active in the specified gap.

**Suffix:**

```
<gap>          1 | 2
                gap channel
```

**Parameters:**

```
<State>        ON | OFF | 0 | 1
                OFF | 0
                Switches the function off
                ON | 1
                Switches the function on
                *RST:      0
```

**Parameters for setting and query:**

```
<SBGaps>       AB | BC | CD | DE | EF | FG | GH
                Name of the gap, defined by the letters of the surrounding sub
                blocks (e.g. "AB" for the gap between sub blocks A and B).
```

**Example:**           SENS:POW:ACH:GCH:GAP2:MAN:LOW BC, ON  
Enables the second lower gap channel in the gap between sub blocks B and C.

**Example:**           See ["Example: configuring and performing an asymmetrical MSR ACLR measurement"](#) on page 975

**Manual operation:** See ["Gap Channel Active"](#) on page 189

---

```
[SENSe:]POWer:ACHannel:GCHannel[:STATe]:GAP<gap>:MANual:UPPer
<SBGaps>, <State>
```

```
[SENSe:]POWer:ACHannel:GCHannel[:STATe]:GAP<gap>:MANual:UPPer?
<SBGaps>
```

Defines which upper gap channels are active in the specified gap.

**Suffix:**

```
<gap>          1 | 2
                gap channel
```

**Parameters:**

```
<State>        ON | OFF | 0 | 1
                OFF | 0
                Switches the function off
```

**ON | 1**

Switches the function on

\*RST: 0

**Parameters for setting and query:**

&lt;SBGaps&gt; AB | BC | CD | DE | EF | FG | GH

Name of the gap, defined by the letters of the surrounding sub blocks (e.g. "AB" for the gap between sub blocks A and B).

**Example:**

SENS:POW:ACH:GCH:GAP2:MAN:UPP BC, ON

Enables the second upper gap channel in the gap between sub blocks B and C.

**Example:**See ["Example: configuring and performing an asymmetrical MSR ACLR measurement"](#) on page 975**Manual operation:** See ["Gap Channel Active"](#) on page 189**[SENSe:]POWer:ACHannel:SPACing:GAP<gap>:MANual:LOWer <SBGaps>, <Spacing>****[SENSe:]POWer:ACHannel:SPACing:GAP<gap>:MANual:LOWer? <SBGaps>**

Defines the distance from sub block to the specified lower gap channel.

The required spacing can be determined according to the following formula:

Spacing = [CF of the gap channel] - [left sub block center] + ([RF bandwidth of left sub block] / 2)

**Suffix:**<gap> 1 | 2  
Gap channel number**Parameters:**

&lt;Spacing&gt; Default unit: HZ

**Parameters for setting and query:**

&lt;SBGaps&gt; AB | BC | CD | DE | EF | FG | GH

Name of the gap, defined by the letters of the surrounding sub blocks (e.g. "AB" for the gap between sub blocks A and B).

**Example:**

POW:ACH:SPAC:GAP:MAN:LOW AB, 5MHz

**Example:**See ["Example: configuring and performing an asymmetrical MSR ACLR measurement"](#) on page 975**Manual operation:** See ["Gap Channel Spacing"](#) on page 189**[SENSe:]POWer:ACHannel:SPACing:GAP<gap>:MANual:UPPer <SBGaps>, <Spacing>****[SENSe:]POWer:ACHannel:SPACing:GAP<gap>:MANual:UPPer? <SBGaps>**

Defines the distance from the sub block to the specified upper gap channel.

The required spacing can be determined according to the following formula:

*Spacing = [right sub block CF] - [CF of gap channel] - ([RF bandwidth of right sub block] / 2)*

**Suffix:**

<gap> 1 | 2  
irrelevant

**Parameters:**

<Spacing> Default unit: HZ

**Parameters for setting and query:**

<SBGaps> AB | BC | CD | DE | EF | FG | GH  
Name of the gap, defined by the letters of the surrounding sub blocks (e.g. "AB" for the gap between sub blocks A and B).

**Example:** POW:ACH:SPAC:GAP:MAN:UPP AB, 5MHz

**Example:** See ["Example: configuring and performing an asymmetrical MSR ACLR measurement"](#) on page 975

**Manual operation:** See ["Gap Channel Spacing"](#) on page 189

**MSR channel names**

The functions for manual operation are described in [Chapter 6.2.5.5, "MSR channel names"](#), on page 191.

[SENSe:]POWer:ACHannel:NAME:GAP<gap>.....966  
[SENSe:]POWer:ACHannel:NAME:UACHannel..... 966  
[SENSe:]POWer:ACHannel:NAME:UALTernate<ch>..... 967  
[SENSe:]POWer:ACHannel:SBLock<sb>:NAME[:CHANnel<ch>].....967

---

**[SENSe:]POWer:ACHannel:NAME:GAP<gap> <Name>**

This command queries the name of the GAP channel.

**Suffix:**

<gap> 1 | 2  
Gap (CACLR) channel number

**Parameters:**

<Name> String containing the name of the channel  
\*RST: 'Gap1', 'Gap2'

---

**[SENSe:]POWer:ACHannel:NAME:UACHannel <Name>**

Defines the name for the upper adjacent channel in asymmetrical MSR channel definitions. To define the name for the lower adjacent channel use the [\[SENSe:\]POWer:ACHannel:NAME:ACHannel](#) command.

**Parameters:**

<Name> String containing the name of the channel  
\*RST: ADJ

---

**[SENSe:]POWer:ACHannel:NAME:UALternate<ch> <Name>**

Defines the name for the specified upper alternate channel in asymmetrical MSR channel definitions. To define the name for the lower adjacent channels use the [\[SENSe:\]POWer:ACHannel:NAME:ALternate<ch>](#) command.

**Suffix:**

<ch> 1..n  
Alternate channel number

**Parameters:**

<Name> String containing the name of the channel  
\*RST: ALT<1...11>

---

**[SENSe:]POWer:ACHannel:SBLock<sb>:NAME[:CHANnel<ch>] <Name>**

Defines the name of the specified MSR Tx channel.

Is for MSR signals only.

In MSR ACLR measurements, the default TX channel names correspond to the specified technology, followed by a consecutive number. The assigned sub block (A,B,C,D,E,F,G,H) is indicated as a prefix (e.g. A: WCDMA1).

Is for MSR signals only (see [CALCulate<n>:MARKer<m>:FUNction:POWer<sb>:PRESet](#) on page 916).

**Suffix:**

<sb> 1 to 8  
sub block number  
  
<ch> 1 to 18  
Tx channel number

**Parameters:**

<Name> String containing the name of the channel

**Example:**

POW:ACH:SBL2:NAME:CHAN2?  
Result:  
'B:WCDMA'

**Manual operation:** See "[Tx Channel Definition](#)" on page 182

### 13.5.3.9 Performing an ACLR measurement

The following commands are required to perform an ACLR measurement:

- [CALC:MARK:FUNC:POW:SEL ACP](#), see [CALCulate<n>:MARKer<m>:FUNction:POWer<sb>:SElect](#) on page 913
- [CALCulate<n>:MARKer<m>:FUNction:POWer<sb>\[:STATe\]](#) on page 914
- [INITiate<n>\[:IMMediate\]](#) on page 910

### 13.5.3.10 Retrieving and analyzing measurement results

The following commands retrieve and analyze measurement results for ACLR measurements.

#### Useful commands for channel power measurements described elsewhere

- `CALCulate<n>:MARKer<m>:FUNCTION:POWer<sb>:RESult?` on page 912
- `TRACe<n>[:DATA]` on page 1258
- `CALCulate<n>:LIMit<li>:ACPower:ACHannel:RESult?` on page 927
- `CALCulate<n>:LIMit<li>:ACPower:ALternate<ch>:RESult?` on page 930

#### Remote commands exclusive to channel power measurements

<code>CALCulate&lt;n&gt;:LIMit&lt;li&gt;:ACPower:GAP&lt;gap&gt;:ACLR:RESult?</code> .....	968
<code>CALCulate&lt;n&gt;:LIMit&lt;li&gt;:ACPower:GAP&lt;gap&gt;[:CACLR]:RESult?</code> .....	969
<code>CALCulate&lt;n&gt;:MARKer&lt;m&gt;:FUNCTION:POWer&lt;sb&gt;:RESult:PHZ</code> .....	970
<code>CALCulate&lt;n&gt;:MARKer&lt;m&gt;:FUNCTION:POWer&lt;sb&gt;:RESult:UNIT</code> .....	970
<code>[SENSe:]POWer:ACHannel:MODE</code> .....	971

#### `CALCulate<n>:LIMit<li>:ACPower:GAP<gap>:ACLR:RESult?`

The command returns the ACLR power limit check results for the selected gap channel in an MSR ACLR measurement.

To get a valid result, you have to perform a complete measurement with synchronization to the end of the measurement before reading out the result. This is only possible for single sweep mode.

See also `INITiate<n>:CONTinuous` on page 909.

The results of the power limit checks are also indicated in the `STAT:QUES:ACPL` status registry (see [Chapter 12.2.2.6, "STATus:QUESTIONable:ACPLimit register"](#), on page 829).

#### Suffix:

<code>&lt;n&gt;</code>	1..n
<code>&lt;li&gt;</code>	1..n irrelevant
<code>&lt;gap&gt;</code>	1   2 Gap (CACLR) channel number

#### Return values:

`<LowerGap_AB>`  
`<UpperGap_AB>`  
`<LowerGap_BC>`  
`<UpperGap_BC>`  
`<LowerGap_CD>`



<UpperGap\_CD>

<LowerGap\_DE>

<UpperGap\_DE>

**Example:**           INIT:IMM;\*WAI;  
                  CALC:LIM:ACP:GAP2:ACLR:RES?  
                  PASSED,PASSED

**Usage:**            Query only

### CALCulate<n>:LIMit<li>:ACPower:GAP<gap>[:CACLR]:RESult?

The command returns the limit check results for the upper and lower gap (CACLR) channels for the selected gap in an MSR ACLR measurement.

To get a valid result, you have to perform a complete measurement with synchronization to the end of the measurement before reading out the result. This is only possible for single sweep mode.

See also [INITiate<n>:CONTinuous](#) on page 909.

The results of the power limit checks are also indicated in the `STAT:QUES:ACPL` status registry (see [Chapter 12.2.2.6, "STATus:QUESTionable:ACPLimit register"](#), on page 829).

**Suffix:**

<n>	irrelevant
<li>	irrelevant
<gap>	1   2 Gap (CACLR) channel number

#### Return values:

<LowerGap\_AB>,           Limit check results for the CACLR power in the upper and lower  
<UpperGap\_AB>           gap channels for the selected gap. Results are only returned for  
[,<LowerGap\_BC>,       the available sub blocks.

<UpperGap\_BC>,       **PASSED**  
<LowerGap\_CD>,       Limit check has passed.

<UpperGap\_CD>,       **FAIL**  
<LowerGap\_DE>,       Limit check has failed.

<UpperGap\_DE>,       **NONE**  
<LowerGap\_EF>,       No results available, e.g. because limit checking was deactiva-  
<UpperGap\_EF>,       ted  
<LowerGap\_FG>

<UpperGap\_FG>,  
<LowerGap\_GH>,  
<UpperGap\_GH>]

**Example:**           INIT:IMM;\*WAI;  
                  CALC:LIM:ACP:GAP2:RES?  
                  PASSED,PASSED

**Usage:**            Query only

**CALCulate<n>:MARKer<m>:FUNction:POWer<sb>:RESult:PHZ <State>**

Selects the unit the FSW returns results for power measurements.

You can query results with `CALCulate<n>:MARKer<m>:FUNction:POWer<sb>:RESult?`.

For LTE and 5G applications, use the command `CALCulate<n>:MARKer<m>:FUNction:POWer<sb>:RESult:UNIT`.

**Suffix:**

<n> [Window](#)

<m> [Marker](#)

<sb> irrelevant

**Parameters:**

<State> ON | OFF | 1 | 0

**ON | 1**

Channel power density in dBm/Hz

**OFF | 0**

Channel power in dBm

\*RST: 0

**Example:**

`CALC:MARK:FUNC:POW:RES:PHZ ON`

Output of results referred to the channel bandwidth.

**Manual operation:** See ["Channel power level and density \(Power Unit\)"](#) on page 169

**CALCulate<n>:MARKer<m>:FUNction:POWer<sb>:RESult:UNIT <Measurement>**

LTE and 5G applications only.

Selects the unit the FSW returns results for power measurements.

You can query results with `CALCulate<n>:MARKer<m>:FUNction:POWer<sb>:RESult?`.

**Suffix:**

<n> [Window](#)

<m> irrelevant

<sb> irrelevant

**Parameters:**

<Measurement>

**ABS**

Channel power in dBm

**PHZ**

Channel power density in dBm/Hz

**MPHZ**

Channel power density in dBm/MHz

\*RST: ABS

**Example:** //Select unit for power measurements  
CALC:MARK:FUNC:POW:RES:UNIT PHZ

**Manual operation:** See ["Channel power level and density \(Power Unit\)"](#) on page 169

**[SENSe:]POWer:ACHannel:MODE <Mode>**

Selects the way the FSW displays the power of adjacent channels.

You need at least one adjacent channel for the command to work.

**Parameters:**

<Mode> ABSolute | RELative

**ABSolute**

Shows the absolute power of all channels

**RELative**

Shows the power of adjacent and alternate channels in relation to the transmission channel

\*RST: RELative

**Manual operation:** See ["Absolute and Relative Values \(ACLR Mode\)"](#) on page 169

### 13.5.3.11 Programming examples for channel power measurements

The following programming examples are meant to demonstrate the most important commands to perform channel power measurements in a remote environment.

- [Example: configuring and performing an ACLR measurement.....](#)971
- [Example: configuring and performing an MSR ACLR measurement.....](#)973
- [Example: configuring and performing an asymmetrical MSR ACLR measurement .....](#)975

#### **Example: configuring and performing an ACLR measurement**

In this example we will configure and perform an adjacent-channel power measurement. Note that this example is primarily meant to demonstrate the remote control commands, it does not necessarily reflect a useful measurement task. For most common measurement standards, the FSW performs the measurement optimally with the predefined settings, without further configuration.

```
//-----Preparing the measurement -----
//Reset the instrument
*RST

//-----Preparing the measurement-----

//Activate adjacent-channel power measurement.
CALC:MARK:FUNC:POW:SEL ACP
//Select the user standard "GSM"
CALC:MARK:FUNC:POW:PRES GSM
```

## Configuring and performing measurements

```

//-----Setting Up Channels-----
//Create one transmission channel.
POW:ACH:TXCH:COUN 1
//Name the first transmission channel 'TX Channel'.
POW:ACH:NAME:CHAN1 'TX Channel'
//Create two adjacent channels - one adjacent channel and one alternate channel.
POW:ACH:ACP 2
//Name the adjacent channel 'ABC'
POW:ACH:NAME:ACH 'ABC'
//Name the first alternate channel 'XYZ'.
POW:ACH:NAME:ALT1 'XYZ'
//Define a bandwidth of 30 kHz for the transmission channel.
POW:ACH:BWID:CHAN1 30kHz
//Define a bandwidth of 30 kHz for the adjacent channel.
POW:ACH:BWID:ACH 30kHz
//Define a bandwidth of 30 kHz for the first alternate channel.
POW:ACH:BWID:ALT1 30kHz
//Define a distance of 33 kHz from the center of the transmission channel to the
//center of the adjacent channel.
//Also adjust the distance to the alternate channels (66 kHz).
POW:ACH:SPAC 33kHz
//Define a distance of 100 kHz from the center of the transmission channel to the
//center of the first alternate channel.
POW:ACH:SPAC:ALT1 100kHz

//-----Selecting a Reference Channel--
//Select relative display of the channel power.
POW:ACH:MODE REL
//Define transmission channel 1 as the reference channel.
POW:ACH:REF:TXCH:MAN 1

//-----Saving the settings as a user standard-----
//Save the user standard with the name "my_aclr_standard".
//Weighting filters can only be defined for user-defined standards.
CALC:MARK:FUNC:POW:STAN:SAVE 'my_aclr_standard'

//-----Defining Weighting Filters-----
//Define a roll-off factor of 0.35 for the weighting filter of the first
//transmission channel.
POW:ACH:FILT:ALPH:CHAN1 0.35
//Turn the weighting filter for the first transmission channel on.
POW:ACH:FILT:CHAN1 ON
//Define a roll-off factor of 0.35 for the weighting filter of the adjacent
//channel.
POW:ACH:FILT:ALPH:ACH 0.35
//Turn the weighting filter for the adjacent channel on.
POW:ACH:FILT:ACH ON
//Define a roll-off factor of 0.35 for the weighting filter of the first
//alternate channel.
POW:ACH:FILT:ALPH:ALT1 0.35

```

## Configuring and performing measurements

```

//Turn the weighting filter for the first alternate channel on.
POW:ACH:FILT:ALT1 ON

//-----Working with Limits-----
//Define a relative limit of 30 dB below the power of the reference channel
//for both adjacent channels.
CALC:LIM:ACP:ACH 30DB,30DB
//Define a relative limit of 25 dB below the power of the reference channel
//for the first alternate channels.
CALC:LIM:ACP:ALT1 25DB,25DB
//Define an absolute limit of -35 dBm for both adjacent channels.
CALC:LIM:ACP:ACH:ABS -35DBM,-35DBM
//Turn the ACLR limit check on.
CALC:LIM:ACP ON
//Turn the relative limit check for adjacent channels on.
CALC:LIM:ACP:ACH:STAT ON
//Turn the absolute limit check for adjacent channels on.
CALC:LIM:ACP:ACH:ABS:STAT ON
//Turn the absolute limit check for the first alternate channel on.
CALC:LIM:ACP:ALT1:ABS:STAT ON

//-----Performing the Measurement-----
//Determine the ideal ACLR measurement configuration.
POW:ACH:PRES ACP;*WAI
//Determine the ideal reference level for the measurement.
POW:ACH:PRES:RLEV;*WAI
//Initiate a new measurement and waits until the sweep has finished.
INIT;*WAI

//-----Limit Check-----
//Query the results of the limit check for the adjacent channels.
CALC:LIM:ACP:ACH:RES?
//Query the results of the limit check for the first alternate channels.
CALC:LIM:ACP:ALT1:RES?

//-----Retrieving Results-----
//Query the results for the ACLR measurement.
CALC:MARK:FUNC:POW:RES? ACP

```

**Example: configuring and performing an MSR ACLR measurement**

This example demonstrates how to configure and perform an ACLR measurement on a multi-standard radio signal in a remote environment.

```

//-----Preparing the measurement -----
//Reset the instrument
*RST

// Select ACLR measurement
:CALCulate:MARKer:FUNCTION:POWer:SElect ACPower

```

## Configuring and performing measurements

```
// Select MSR Standard :CALCulate:MARKer:FUNction:POWer:PRESet MSR

//Configure general measurement settings
:SENSe:FREQuency:CENTer 1.25GHz
:SENSe:FREQuency:SPAN 62.0MHz
:SENSe:POWer:ACHannel:SBCount 3

//----- Configuring Sub block A

:SENSe:POWer:ACHannel:SBLOCK1:TXChannel:COUNT 3
:SENSe:POWer:ACHannel:SBLOCK1:FREQuency:CENTer 1.230GHZ
:SENSe:POWer:ACHannel:SBLOCK1:RFBWidth 12MHZ

:SENSe:POWer:ACHannel:SBLOCK1:CENTer:CHANnel1 1.226GHZ
:SENSe:POWer:ACHannel:SBLOCK1:CENTer:CHANnel2 1.230GHZ
:SENSe:POWer:ACHannel:SBLOCK1:CENTer:CHANnel3 1.234GHZ

:SENSe:POWer:ACHannel:SBLOCK1:TECHnology:CHANnel1 WCDMA
:SENSe:POWer:ACHannel:SBLOCK1:TECHnology:CHANnel2 WCDMA
:SENSe:POWer:ACHannel:SBLOCK1:TECHnology:CHANnel3 GSM

:SENSe:POWer:ACHannel:SBLOCK1:BANDwidth:CHANnel1 2.5MHZ
:SENSe:POWer:ACHannel:SBLOCK1:BANDwidth:CHANnel2 2.5MHZ
:SENSe:POWer:ACHannel:SBLOCK1:BANDwidth:CHANnel3 2.5MHZ

//----- Configuring Sub block B

:SENSe:POWer:ACHannel:SBLOCK2:TXChannel:COUNT 1
:SENSe:POWer:ACHannel:SBLOCK2:FREQuency:CENTer 1.255GHZ
:SENSe:POWer:ACHannel:SBLOCK2:RFBWidth 4MHZ

:SENSe:POWer:ACHannel:SBLOCK2:CENTer:CHANnel1 1.255GHZ

:SENSe:POWer:ACHannel:SBLOCK2:TECHnology:CHANnel1 LTE_1_40

:SENSe:POWer:ACHannel:SBLOCK2:BANDwidth:CHANnel1 3.25MHZ

//----- Configuring Sub block C

:SENSe:POWer:ACHannel:SBLOCK3:TXChannel:COUNT 2
:SENSe:POWer:ACHannel:SBLOCK3:FREQuency:CENTer 1.268GHZ
:SENSe:POWer:ACHannel:SBLOCK3:RFBWidth 8MHZ

:SENSe:POWer:ACHannel:SBLOCK3:CENTer:CHANnel1 1.266GHZ
:SENSe:POWer:ACHannel:SBLOCK3:CENTer:CHANnel2 1.270GHZ

:SENSe:POWer:ACHannel:SBLOCK3:BANDwidth:CHANnel1 2.75MHZ
```

## Configuring and performing measurements

```

:SENSe:POWer:ACHannel:SBLOCK3:BANDwidth:CHANnel2 2.75MHZ

//----- Configuring ADJ channels

:SENSe:POWer:ACHannel:BANDwidth:ACHannel 1.60MHZ
:SENSe:POWer:ACHannel:BANDwidth:ALternate1 1.60MHZ

:SENSe:POWer:ACHannel:SPACing:ACHannel 3MHZ
:SENSe:POWer:ACHannel:SPACing:ALternate1 5MHZ

//----- Configuring gap (CACLR) channels

:SENSe:POWer:ACHannel:SPACing:GAP1 2.0MHZ
:SENSe:POWer:ACHannel:SPACing:GAP2 5.0MHZ

:SENSe:POWer:ACHannel:BANDwidth:GAP1 2.0MHZ
:SENSe:POWer:ACHannel:BANDwidth:GAP2 2.0MHZ

//-----Performing the Measurement-----

//Select single sweep mode.
INIT:CONT OFF
//Initiate a new measurement and wait until the sweep has finished.
INIT;*WAI

//-----Retrieving Results-----

//Return the results for the ACLR measurement.
CALC:MARK:FUNC:POW:RES? MCAC
//Results:
//Transmission channels in sub block A
//-13.2346727385,-13.2346723793,-13.2390131759,
//Transmission channels in sub block B
//-17.0863336597,
//Transmission channels in sub block C
//-13.2390127767,-13.2390134744,
//Totals for each sub block
//-8.4649064021,-17.0863336597,-10.2287131689,
//Adjacent channels
//-67.9740721019,-67.9740728014,-0.00434041734,-0.00434041734,
//CACLR channels
//-0.52933512766,-64.9990115835,-64.5012521492,-0.33507330922,
//-64.4924159646,-0.52932552499,-0.52932552495,-64.4934163414

```

**Example: configuring and performing an asymmetrical MSR ACLR measurement**

This example demonstrates how to configure and perform an ACLR measurement on an asymmetrical multi-standard radio signal in a remote environment.

## Configuring and performing measurements

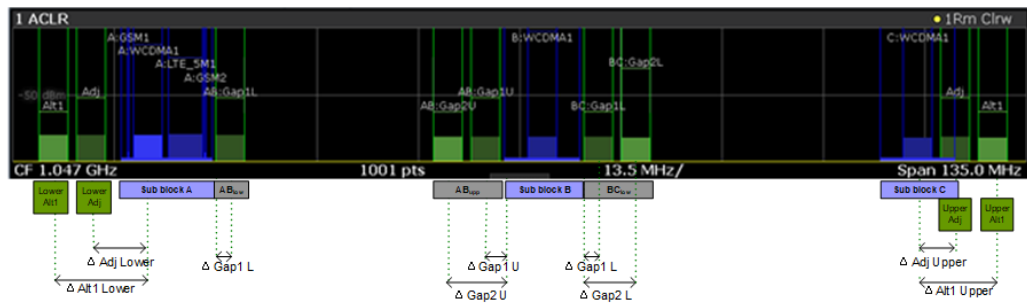

**Figure 13-1: Asymmetrical MSR signal structure**

```
//-----Preparing the measurement -----
//Reset the instrument
*RST

// Select ACLR measurement
:CALCulate:MARKer:FUNCTION:POWER:SELEct ACPower

// Select MSR Standard
:CALCulate:MARKer:FUNCTION:POWER:PRESet MSR

//Configure general measurement settings
:SENSe:FREQuency:CENTer 1.25GHz
:SENSe:FREQuency:SPAN 62.0MHz
:SENSe:POWER:ACHannel:SBCount 3

//----- Configuring Sub block A

:SENSe:POWER:ACHannel:SBLOCK1:TXChannel:COUNT 3
:SENSe:POWER:ACHannel:SBLOCK1:FREQuency:CENTer 1.230GHZ
:SENSe:POWER:ACHannel:SBLOCK1:RFBWidth 12MHZ

:SENSe:POWER:ACHannel:SBLOCK1:CENTer:CHANnel1 1.226GHZ
:SENSe:POWER:ACHannel:SBLOCK1:CENTer:CHANnel2 1.230GHZ
:SENSe:POWER:ACHannel:SBLOCK1:CENTer:CHANnel3 1.234GHZ

:SENSe:POWER:ACHannel:SBLOCK1:TECHnology:CHANnel1 WCDMA
:SENSe:POWER:ACHannel:SBLOCK1:TECHnology:CHANnel2 WCDMA
:SENSe:POWER:ACHannel:SBLOCK1:TECHnology:CHANnel3 GSM

:SENSe:POWER:ACHannel:SBLOCK1:BANDwidth:CHANnel1 2.5MHZ
:SENSe:POWER:ACHannel:SBLOCK1:BANDwidth:CHANnel2 2.5MHZ
:SENSe:POWER:ACHannel:SBLOCK1:BANDwidth:CHANnel3 2.5MHZ

//----- Configuring Sub block B

:SENSe:POWER:ACHannel:SBLOCK2:TXChannel:COUNT 1
:SENSe:POWER:ACHannel:SBLOCK2:FREQuency:CENTer 1.255GHZ
```



## Configuring and performing measurements

```

:SENSe:POWer:ACHannel:SBLOCK2:RFBWidth 4MHZ

:SENSe:POWer:ACHannel:SBLOCK2:CENTer:CHANnel1 1.255GHZ

:SENSe:POWer:ACHannel:SBLOCK2:TECHnology:CHANnel1 LTE_1_40

:SENSe:POWer:ACHannel:SBLOCK2:BANDwidth:CHANnel1 3.25MHZ

//----- Configuring Sub block C

:SENSe:POWer:ACHannel:SBLOCK3:TXCHannel:COUNT 2
:SENSe:POWer:ACHannel:SBLOCK3:FREQuency:CENTer 1.268GHZ
:SENSe:POWer:ACHannel:SBLOCK3:RFBWidth 8MHZ

:SENSe:POWer:ACHannel:SBLOCK3:CENTer:CHANnel1 1.266GHZ
:SENSe:POWer:ACHannel:SBLOCK3:CENTer:CHANnel2 1.270GHZ

:SENSe:POWer:ACHannel:SBLOCK3:BANDwidth:CHANnel1 2.75MHZ
:SENSe:POWer:ACHannel:SBLOCK3:BANDwidth:CHANnel2 2.75MHZ

//----- Configuring ADJ channels

:SENSe:POWer:ACHannel:BANDwidth:ACHannel 1.60MHZ
:SENSe:POWer:ACHannel:BANDwidth:ALternate1 1.60MHZ

:SENSe:POWer:ACHannel:SPACing:ACHannel 3MHZ
:SENSe:POWer:ACHannel:SPACing:ALternate1 5MHZ

//----- Configuring gap channels manually
:SENSe:POWer:ACHannel:AGCHannels ON
:SENSe:POWer:ACHannel:GAP:MODE MAN

//----- Configuring AB gap channels
// 1 lower, 2 upper

:SENSe:POWer:ACHannel:GCH:GAP1:MAN:LOW AB, ON
:SENSe:POWer:ACHannel:GCH:GAP1:MAN:UPP AB, ON
:SENSe:POWer:ACHannel:GCH:GAP2:MAN:UPP AB, ON

:SENSe:POWer:ACHannel:SPACing:GAP1:MAN:LOW AB,2.0MHZ
:SENSe:POWer:ACHannel:SPACing:GAP1:MAN:UPP AB,2.0MHZ
:SENSe:POWer:ACHannel:SPACing:GAP2:MAN:UPP AB,4.2MHZ

:SENSe:POWer:ACHannel:BANDwidth:GAP1:MAN:LOW AB,2.0MHZ
:SENSe:POWer:ACHannel:BANDwidth:GAP1:MAN:UPP AB,2.0MHZ
:SENSe:POWer:ACHannel:BANDwidth:GAP2:MAN:UPP AB,2.0MHZ

:SENSe:POWer:ACHannel:FILTer:STATe:GAP1:MAN:LOW AB,ON
:SENSe:POWer:ACHannel:FILTer:STATe:GAP1:MAN:UPP AB,ON

```

## Configuring and performing measurements

```

:SENSe:POWer:ACHannel:FILTer:STATe:GAP2:MAN:UPP AB,ON

:SENSe:POWer:ACHannel:FILTer:ALPHa:GAP1:MAN:LOW AB,0.25
:SENSe:POWer:ACHannel:FILTer:ALPHa:GAP1:MAN:UPP AB,0.25
:SENSe:POWer:ACHannel:FILTer:ALPHa:GAP2:MAN:UPP AB,0.25

//Limit check
:CALC:LIM:ACP ON
:CALC:LIM:ACP:GAP1:MAN:UPP:ABS:STAT AB,ON
:CALC:LIM:ACP:GAP1:MAN:UPP:ABS AB,3DBM
:CALC:LIM:ACP:GAP2:MAN:UPP:ABS:STAT AB,ON
:CALC:LIM:ACP:GAP2:MAN:UPP:ABS AB,3DBM

//----- Configuring BC gap channels
// 2 lower, 0 upper

:SENSe:POWer:ACHannel:GCH:GAP1:MAN:LOW AB, ON
:SENSe:POWer:ACHannel:GCH:GAP2:MAN:LOW AB, ON

:SENSe:POWer:ACHannel:SPACing:GAP1:MAN:LOW BC,2.0MHZ
:SENSe:POWer:ACHannel:SPACing:GAP2:MAN:LOW BC,4.2MHZ

:SENSe:POWer:ACHannel:BANDwidth:GAP1:MAN:LOW BC,2.0MHZ
:SENSe:POWer:ACHannel:BANDwidth:GAP2:MAN:LOW BC,2.0MHZ

//Limit check
:CALC:LIM:ACP ON
:CALC:LIM:ACP:GAP1:MAN:LOW:ABS:STAT BC,ON
:CALC:LIM:ACP:GAP1:MAN:LOW:ABS BC,3DBM
:CALC:LIM:ACP:GAP1:MAN:LOW:CACL:REL:STAT BC,ON
:CALC:LIM:ACP:GAP1:MAN:LOW:CACL:REL BC,-3DB

:CALC:LIM:ACP:GAP2:MAN:LOW:ACLR:REL:STAT BC,ON
:CALC:LIM:ACP:GAP2:MAN:LOW:ACLR:REL BC,-3DB

//-----Performing the Measurement-----

//Select single sweep mode.
INIT:CONT OFF
//Initiate a new measurement and wait until the sweep has finished.
INIT;*WAI

//-----Retrieving Results-----

//Return the results for the ACLR measurement.
CALC:MARK:FUNC:POW:RES? MCAC
//Results:
//Transmission channels in sub block A
//-13.2346727385,-13.2346723793,-13.2390131759,
//Transmission channels in sub block B

```

```

// -17.0863336597,
// Transmission channels in sub block C
// -13.2390127767, -13.2390134744,
// Totals for each sub block
// -8.4649064021, -17.0863336597, -10.2287131689,
// Adjacent channels
// -67.9740721019, -67.9740728014, -0.00434041734, -0.00434041734,
// ACLR channels (AB2L, BC1U, BC2U invalid)
// -0.52933512766, -64.9990115835 9.91e37, -0.33507330922,
// -64.4924159646, 9.91e37, -0.52932552495, 9.91e37

// Limit check
CALC:LIM:ACP:GAP1:ACLR:RES?
// Result for gap 1 channels: ABGap1L, ABGap1U, BCGap1L, ( BCGap1U invalid )
// PASSED, PASSED, PASSED, NONE
CALC:LIM:ACP:GAP2:ACLR:RES?
// Result for gap 2 channels: (ABGap2L invalid ), ABGap2U, BCGap2L, ( BCGap2U invalid )
// NONE, PASSED, PASSED, NONE

```

### 13.5.4 Measuring the carrier-to-noise ratio

The following commands are necessary to perform carrier-to-noise measurements.

- `CALC:MARK:FUNC:POW:SEL CN | CN0`, see `CALCulate<n>:MARKer<m>:FUNCTION:POWER<sb>:SElect`
- `CALCulate<n>:MARKer<m>:FUNCTION:POWER<sb>[:STATE]`
- `CALCulate<n>:MARKer<m>:FUNCTION:POWER<sb>:RESult?`
- `[SENSe:]POWER:ACHannel:BANDwidth[:CHANnel<ch>]`
- `[SENSe:]POWER:ACHannel:PRESet`

#### Programming example: Measuring the carrier-to-noise ratio

This programming example demonstrates how to perform a Carrier-to-noise measurement in a remote environment.

```

//-----Preparing the measurement-----
*RST
//Reset the instrument
FREQ:CENT 800MHz
//Sets the center frequency to the carrier frequency of 800 MHz.
CALC:MARK:FUNC:POW:SEL CN
//Activates carrier-to-noise ratio measurement.
POW:ACH:PRES CN
//Optimizes the instrument settings according to the channel bandwidth.
POW:ACH:PRES:RLEV
//Determines the ideal reference level for the measurement.

//-----Performing the Measurement-----
INIT:CONT OFF

```

```
//Selects single sweep mode.
INIT;*WAI
//Initiates a new measurement and waits until the sweep has finished.

// Now turn off the carrier signal and repeat the measurement:
INIT;*WAI
//Initiates a new measurement and waits until the sweep has finished.

//-----Retrieving Results-----
CALC:MARK:FUNC:POW:RES? CN
//Returns the carrier-to-noise ratio.
```

### 13.5.5 Measuring the occupied bandwidth

All remote control commands specific to occupied bandwidth measurements are described here.

- [Configuring the measurement](#).....980
- [Programming example: OBW measurement](#)..... 981

#### 13.5.5.1 Configuring the measurement

The following commands configure measurements of the occupied bandwidth.

##### Useful commands for occupied bandwidth measurements described elsewhere

Configuring the channel:

- [\[SENSe:\]POWer:ACHannel:BANDwidth\[:CHANnel<ch>\]](#)
- [\[SENSe:\]POWer:ACHannel:PRESet](#)
- [\[SENSe:\]POWer:ACHannel:PRESet:RLEVel](#)

Defining search limits:

- [CALCulate<n>:MARKer<m>:X:SLIMits\[:STATe\]](#) on page 1278
- [CALCulate<n>:MARKer<m>:X:SLIMits:LEFT](#) on page 1278
- [CALCulate<n>:MARKer<m>:X:SLIMits:RIGHT](#) on page 1279

Performing the measurement:

- [CALCulate<n>:MARKer<m>:FUNCTion:POWer<sb>:SElect](#) on page 913
- [CALCulate<n>:MARKer<m>:FUNCTion:POWer<sb>\[:STATe\]](#) on page 914

Retrieving results:

- [CALCulate<n>:MARKer<m>:FUNCTion:POWer<sb>:RESult?](#) on page 912

##### Remote commands exclusive to occupied bandwidth measurements:

- [\[SENSe:\]POWer:BWIDth](#)..... 981
- [\[SENSe:\]POWer:BANDwidth](#).....981

**[SENSe:]POWer:BWIDth <Percentage>**

**[SENSe:]POWer:BANDwidth <Percentage>**

Selects the percentage of the total power that defines the occupied bandwidth.

**Parameters:**

<Percentage>      Range:      10 PCT to 99.9 PCT  
                          \*RST:      99 PCT  
                          Default unit: PCT

**Example:**              POW:BAND 95PCT

**Manual operation:**    See "["% Power Bandwidth"](#)" on page 213

### 13.5.5.2 Programming example: OBW measurement

This programming example demonstrates the measurement example described in [Chapter 6.4.5, "Measurement example"](#), on page 216 in a remote environment.

```
//-----Preparing the measurement -----
//Reset the instrument
*RST

//-----Configuring the Measurement-----
//Set the center frequency to 800 MHz.
FREQ:CENT 800MHz
//Set the reference level to -10 dBm.
DISP:TRAC:Y:RLEV -10dBm
//Activate occupied bandwidth measurement.
CALC:MARK:FUNC:POW:SEL OBW
//Set the percentage of power to 99%.
POW:BWID 99PCT
//Set the channel bandwidth to 21 kHz.
POW:ACH:BAND 21kHz
//Optimize the instrument settings according to the channel bandwidth.
POW:ACH:PRES OBW
//Determine the ideal reference level for the measurement.
POW:ACH:PRES:RLEV
//Set the trace detector to positive peak.
DET APE

//-----Performing the Measurement-----
//Select single sweep mode.INIT:CONT OFF

//Initiate a new measurement and waits until the sweep has finished.
INIT;*WAI

//-----Retrieving Results-----
//Return the occupied bandwidth.
CALC:MARK:FUNC:POW:RES? OBW
```

### 13.5.6 Remote commands for noise power ratio (NPR) measurements

- [Activating an NPR measurement](#)..... 982
- [Configuring an NPR measurement](#)..... 982
- [Configuring signal generator control](#)..... 985
- [Retrieving results from an NP measurement](#)..... 996
- [Programming example: measuring the noise power ratio](#)..... 997

#### 13.5.6.1 Activating an NPR measurement

[\[SENSe:\]NPRatio:STATe](#)..... 982

---

**[SENSe:]NPRatio:STATe** <State>

Activates or deactivates the noise power ratio (NPR) measurement.

**Parameters:**

<State>                    ON | OFF | 0 | 1

**OFF | 0**  
Deactivates the NPR measurement (returns to common frequency sweep)

**ON | 1**  
Activates the NPR measurement

\*RST:                    0

**Example:**                    NPR:STAT ON

#### 13.5.6.2 Configuring an NPR measurement

[\[SENSe:\]NPRatio:CHANnel:BWIDth](#)..... 982

[\[SENSe:\]NPRatio:CHANnel:INTEgration:AUTO](#)..... 983

[\[SENSe:\]NPRatio:CHANnel:INTEgration:BWIDth](#)..... 983

[\[SENSe:\]NPRatio:CHANnel:INTEgration:FREQUency:OFFSet](#)..... 984

[\[SENSe:\]NPRatio:MODE](#)..... 984

[\[SENSe:\]NPRatio:NOTCh<notch>:BWIDth:RELative](#)..... 984

[\[SENSe:\]NPRatio:NOTCh<notch>:BWIDth\[:ABSolute\]](#)..... 985

[\[SENSe:\]NPRatio:NOTCh<notch>:COUNT](#)..... 985

[\[SENSe:\]NPRatio:NOTCh<notch>:FREQUency:OFFSet](#)..... 985

---

**[SENSe:]NPRatio:CHANnel:BWIDth** <Frequency>

Defines the channel bandwidth as an absolute value. Bandwidths covered by defined notches are deducted from this value.

**Parameters:**

<Frequency>                    \*RST:            72 MHz  
Default unit: HZ

**Example:** NPR:CHAN:BWID 100000000  
 NPR:NOTC:COUN 2  
 NPR:NOTC1:BWID 5000000  
 A bandwidth of 100000000 - (2\*5000000) = 90000000 Hz is used as a basis for the total power density.

**Manual operation:** See "[Channel Bandwidth](#)" on page 221

### [SENSe:]NPRatio:CHANnel:INTegration:AUTO <State>

Determines which bandwidth is used for total power density calculation.

**Parameters:**

<State> ON | OFF | 0 | 1

**OFF | 0**

The integration bandwidth and its position is defined manually using [SENSe:]NPRatio:CHANnel:INTegration:BWIDth on page 983 and [SENSe:]NPRatio:CHANnel:INTegration:FREQuency:OFFSet on page 984.

The entire specified bandwidth is used, including any defined notches.

**ON | 1**

The integration bandwidth is defined automatically as the channel bandwidth, without the notches, centered around the center frequency (see [SENSe:]NPRatio:CHANnel:BWIDth on page 982).

\*RST: 1

**Example:** NPR:CHAN:INT:AUTO ON

**Manual operation:** See "[Integration Bandwidth](#)" on page 221

### [SENSe:]NPRatio:CHANnel:INTegration:BWIDth <Frequency>

Defines the bandwidth to be used for total power calculation as an absolute value. This value is only considered for [SENSe:]NPRatio:CHANnel:INTegration:AUTOOFF.

The entire specified bandwidth is used, including any defined notches.

**Parameters:**

<Frequency> \*RST: 72 MHz  
 Default unit: HZ

**Example:** NPR:CHAN:INT:AUTO OFF  
 Selects manual definition of the integration bandwidth.  
 NPR:CHAN:INT:BWID 100000000  
 Sets the integration bandwidth to 100 MHz.

**Manual operation:** See "[Integration Bandwidth](#)" on page 221

**[SENSe:]NPRatio:CHANnel:INTegration:FREQuency:OFFSet <Frequency>**

Shifts the bandwidth to be used for total power density calculation away from the currently defined center frequency.

**Parameters:**

<Frequency>            \*RST:        0  
                               Default unit: HZ

**Example:**

NPR:CHAN:INT:FREQ:OFFS 10000000  
 Shifts the integration bandwidth by 10 MHz from the center frequency.

**Manual operation:** See ["Integration Bandwidth"](#) on page 221

**[SENSe:]NPRatio:MODE <Mode>**

Determines whether the power measured in a channel or notch is indicated as a power or a density value.

**Parameters:**

<Mode>                    POWer | DENSIty

**DENSIty**

Power measured in channel or notch divided by the "Channel BW"/"Integration BW" in dBm/Hz

**POWer**

Absolute power measured in channel or notch in current amplitude unit

\*RST:                    DENSIty

**Example:**

NPR:MODE DENS

**Manual operation:** See ["Result Power Mode"](#) on page 224

**[SENSe:]NPRatio:NOTCh<notch>:BWIth:RELative <Percentage>**

Defines the bandwidth of the individual notch as a percentage of the defined channel frequency.

**Suffix:**

<notch>                    1..n

**Parameters:**

<Percentage>            Range:        0 to 100  
                               \*RST:        5

**Example:**

NPR:CHAN:BWID 100000000  
 NPR:NOTC2:BWID:REL 5  
 Defines a notch bandwidth of 5% of channel bandwidth (100 MHz) = 5 MHz

**Manual operation:** See ["Notch Bandwidth \(Absolute / Relative to Channel BW\)"](#) on page 222



**[SENSe:]NPRatio:NOTCh<notch>:BWIDth[:ABSolute] <Frequency>**

Defines the bandwidth of the individual notch as an absolute value.

**Suffix:**

<notch> 1..n

**Parameters:**

<Frequency> Default unit: HZ

**Example:**

NPR:NOTC1:BWID 50000000

**Manual operation:** See ["Notch Bandwidth \(Absolute / Relative to Channel BW\)"](#) on page 222

**[SENSe:]NPRatio:NOTCh<notch>:COUNT <Amount>**

Defines the number of notches for which results are determined. Note that even if bandwidths for further notches are defined, only the number specified here are actually calculated and displayed.

**Suffix:**

<notch> 1..n  
irrelevant

**Parameters:**

<Amount> integer  
Range: 1 to 25  
\*RST: 1

**Example:**

NPR:NOTC:COUN 2

**Manual operation:** See ["Number of Notches"](#) on page 222

**[SENSe:]NPRatio:NOTCh<notch>:FREQuency:OFFSet <Frequency>**

Defines the center position of the notch in relation to the currently defined center frequency.

**Suffix:**

<notch> 1..n

**Parameters:**

<Frequency> Default unit: HZ

**Example:**

NPR:NOTC1:FREQ:OFFS -100000000

**Manual operation:** See ["Frequency Offset per Notch"](#) on page 222

**13.5.6.3 Configuring signal generator control**

Useful commands for controlling generators described elsewhere:

- [CONFigure:GENerator:CONNECTION:CState?](#) on page 1454
- [CONFigure:GENerator:IPConnection:ADDRESS](#) on page 1455

**Remote commands exclusive to controlling generators for NPR measurements**

CONFigure:GENerator:EXTernal:ROSCillator.....	986
CONFigure:GENerator:FREQuency:CENTer.....	987
CONFigure:GENerator:NPRatio:BB:ARbitrary:WAVEform:SElect?	987
CONFigure:GENerator:NPRatio:BB:STANdard?	987
CONFigure:GENerator:NPRatio:CONNection:CSTate?	987
CONFigure:GENerator:NPRatio:CONTRol[:STATe].....	988
CONFigure:GENerator:NPRatio:EXTernal:ROSCillator:CSTate?	988
CONFigure:GENerator:NPRatio:FREQuency:CENTer:CSTate?	988
CONFigure:GENerator:NPRatio:FREQuency:COUPling[:STATe].....	989
CONFigure:GENerator:NPRatio:FREQuency:OFFSet.....	989
CONFigure:GENerator:NPRatio:FREQuency[:FACTor]:DENominator.....	989
CONFigure:GENerator:NPRatio:FREQuency[:FACTor]:NUMerator.....	990
CONFigure:GENerator:NPRatio:NOTCh<notch>:BWiDth:ABSolute:CSTate?	990
CONFigure:GENerator:NPRatio:NOTCh<notch>:FREQuency:OFFSet:CSTate?	990
CONFigure:GENerator:NPRatio:NOTCh<notch>:STATe:CSTate?	991
CONFigure:GENerator:NPRatio:NOTCh<notch>[:STATe].....	991
CONFigure:GENerator:NPRatio:NOTCh<notch>:CLOCK?	992
CONFigure:GENerator:NPRatio:NOTCh<notch>:COUNT:CSTate?	992
CONFigure:GENerator:NPRatio:POWer:LEVel:CSTate?	992
CONFigure:GENerator:NPRatio:POWer:LEVel:OFFSet:CSTate?	993
CONFigure:GENerator:NPRatio:RFOutput:STATe:CSTate?	993
CONFigure:GENerator:NPRatio:SETTings:NOTCh:UPDate.....	994
CONFigure:GENerator:NPRatio:SETTings:UPDate.....	994
CONFigure:GENerator:NPRatio:STATe:CSTate?	994
CONFigure:GENerator:NPRatio[:STATe].....	994
CONFigure:GENerator:POWer:LEVel.....	995
CONFigure:GENerator:POWer:LEVel:OFFSet.....	995
CONFigure:GENerator:RFOutput[:STATe].....	995
CONFigure:GENerator:TARGet:PATH:BB?	995
CONFigure:GENerator:TARGet:PATH:RF.....	996
CONFigure:SETTings:NPRatio.....	996
CONFigure:SETTings:NPRatio:NOTCh.....	996

**CONFigure:GENerator:EXTernal:ROSCillator <ReferenceType>**

Selects the source of the generator reference frequency.

**Parameters:**

<ReferenceType>    EXTernal | INTernal

**EXTernal**

An external reference is provided via the EXT connectors on the generator, for example by the FSW.

**INTernal**

The internal reference is that of the signal generator itself.

**Manual operation:**    See "[Reference Frequency](#)" on page 228

---

**CONFigure:GENerator:FREQUENCY:CENTer** <Frequency>

Defines the frequency of the signal provided by the signal generator.

**Parameters:**

<Frequency>            Default unit: HZ

**Example:**            CONF:GEN:FREQ:CENT 1GHZ

**Manual operation:**   See "[Frequency](#)" on page 228  
See "[f<sub>Gen</sub>](#)" on page 230

---

**CONFigure:GENerator:NPRatio:BB:ARBitrary:WAVEform:SELEct?**

Queries the ARB waveform file currently used by the signal generator.

**Return values:**

<ArbWaveform>

**Example:**            CONF:GEN:NPR:BB:ARB:WAV:SEL?

**Usage:**                Query only

**Manual operation:**   See "[ARB Waveform File](#)" on page 228

---

**CONFigure:GENerator:NPRatio:BB:STANdard?**

Queries the standard currently used by the signal generator.

**Return values:**

<Standard>

**Example:**            CONF:GEN:NPR:BB:STAN?

**Usage:**                Query only

**Manual operation:**   See "[Standard](#)" on page 228

---

**CONFigure:GENerator:NPRatio:CONNEction:CState?**

Queries the state of the connected signal generator and its availability for the Spectrum application.

**Return values:**

<ControlState>        OFF | SUCCessful | ERRor

**OFF**

No signal generator defined

**SUCCessful**

Connection established to compatible generator

**ERRor**

Connection error, for example due to an incompatible generator

**Usage:**                Query only

**CONFigure:GENerator:NPRatio:CONTrol[:STATe]** <State>

Activates or deactivates control of the signal generator by the FSW.

**Parameters:**

<State>                    ON | OFF | 0 | 1  
                               **OFF | 0**  
                               Switches the function off  
                               **ON | 1**  
                               Switches the function on  
                               \*RST:        0

**Example:**                    CONF:GEN:NPR:CONT:STAT ON

**Manual operation:**    See "[Generator Control State](#)" on page 227

**CONFigure:GENerator:NPRatio:EXTernal:ROSCillator:CSTate?**

Queries the state of the generator reference frequency.

**Return values:**

<ControlState>            OFF | SUCCessful | ERRor  
                               **OFF**  
                               Signal generator control off  
                               **SUCCessful**  
                               Setting successfully applied on the signal generator  
                               **ERRor**  
                               Control error, for example because a specified value cannot be  
                               applied on the signal generator

**Example:**                    CONF:GEN:NPR:EXT:ROSC:CST?

**Usage:**                    Query only

**Manual operation:**    See "[Reference Frequency](#)" on page 228

**CONFigure:GENerator:NPRatio:FREQuency:CENTER:CSTate?**

Queries the state of the generator center frequency.

**Return values:**

<ControlState>            OFF | SUCCessful | ERRor  
                               **OFF**  
                               Signal generator control off  
                               **SUCCessful**  
                               Setting successfully applied on the signal generator  
                               **ERRor**  
                               Control error, for example because a specified value cannot be  
                               applied on the signal generator

**Example:**                    CONF:GEN:NPR:FREQ:CENT:CST?

**Usage:** Query only

**Manual operation:** See ["Frequency"](#) on page 228  
See ["f<sub>Gen</sub>"](#) on page 230

#### **CONFigure:GENerator:NPRatio:FREQUENCY:COUPling[:STATe]** <State>

Enables or disables frequency coupling between the FSW and the connected generator.

**Parameters:**

<State> ON | OFF | 0 | 1

**OFF | 0**  
Switches the function off  
A fixed frequency is used by the generator.

**ON | 1**  
Switches the function on  
The frequency defined on the analyzer is automatically also used by the generator.

\*RST: 0

**Example:** CONF:GEN:NPR:FREQ:COUP:STAT ON

**Manual operation:** See ["Generator Frequency Coupling State"](#) on page 230

#### **CONFigure:GENerator:NPRatio:FREQUENCY:OFFSet** <FrequencyOffset>

Defines a fixed offset to be applied to the generator frequency.

**Parameters:**

<FrequencyOffset> numeric value  
Default unit: HZ

**Example:** CONF:GEN:NPR:FREQ:OFFS 5

**Manual operation:** See ["Frequency Offset"](#) on page 231

#### **CONFigure:GENerator:NPRatio:FREQUENCY[:FACTor]:DENominator** <Denominator>

Defines the denominator of the frequency-defining factor for the generator frequency (see ["f<sub>Gen</sub>"](#) on page 230).

**Parameters:**

<Denominator> numeric value

**Example:** CONF:GEN:NPR:FREQ:FACT:DEN 5

**Manual operation:** See ["Denominator"](#) on page 231

**CONFigure:GENerator:NPRatio:FREQUENCY[:FACTor]:NUMerator** <Numerator>

Defines the numerator of the frequency-defining factor for the generator frequency (see "f<sub>Gen</sub>" on page 230).

**Parameters:**

<Numerator>            numeric value

**Example:**            CONF:GEN:NPR:REQ:FACT:NUM 1

**Manual operation:** See "[Numerator](#)" on page 231

**CONFigure:GENerator:NPRatio:NOTCh<notch>:BWIDth:ABSolute:CState?**

Queries the state of the absolute notch bandwidth for the specified notch.

**Suffix:**

<notch>                1..n

**Return values:**

<ControlState>        OFF | SUCCEssful | ERRor

**OFF**

Signal generator control off

**SUCCEssful**

Setting successfully applied on the signal generator

**ERRor**

Control error, for example because a specified value cannot be applied on the signal generator

**Example:**            CONF:GEN:NPR:NOTC1:STAT?

**Usage:**                Query only

**Manual operation:** See "[Notch Bandwidth \(Absolute / Relative to Channel BW\)](#)" on page 222

**CONFigure:GENerator:NPRatio:NOTCh<notch>:FREQUENCY:OFFSet:CState?**

Queries the state of the frequency offset for the specified notch.

**Suffix:**

<notch>                1..n

**Return values:**

<ControlState>        OFF | SUCCEssful | ERRor

**OFF**

Signal generator control off

**SUCCEssful**

Setting successfully applied on the signal generator

**ERRor**

Control error, for example because a specified value cannot be applied on the signal generator

**Example:** `CONF:GEN:NPR:NOTC1:FREQ:OFFS:CST?`  
**Usage:** Query only  
**Manual operation:** See "[Frequency Offset per Notch](#)" on page 222

### **CONFigure:GENerator:NPRatio:NOTCh<notch>:STATe:CSTate?**

Queries the state of the generator notch setting for the specified notch.

**Suffix:**

<notch> 1..n

**Return values:**

<ControlState> OFF | SUCCEssful | ERRor

**OFF**

Signal generator control off

**SUCCEssful**

Setting successfully applied on the signal generator

**ERRor**

Control error, for example because a specified value cannot be applied on the signal generator

**Example:** `CONF:GEN:NPR:NOTC:STAT:CST?`

**Usage:** Query only

**Manual operation:** See "[Generator Notch State](#)" on page 223

### **CONFigure:GENerator:NPRatio:NOTCh<notch>[:STATe] <State>**

Enables or disables the specified notch on the signal generator.

**Suffix:**

<notch> 1..n

**Parameters:**

<State> ON | OFF | 0 | 1

**OFF | 0**

The notch is not considered for signal generation on the connected signal generator.

**ON | 1**

The notch is considered for signal generation on the connected signal generator.

\*RST: 0

**Example:** `CONF:GEN:NPR:NOTC2:STAT ON`

**Manual operation:** See "[Generator Notch State](#)" on page 223

---

**CONFigure:GENerator:NPRatio:NOTCh<notch>:CLOCK?**

Queries the generator clock frequency.

**Suffix:**

<notch>                    1..n  
                                 irrelevant

**Return values:**

<ClockFrequency>

**Example:**

CONF:GEN:NPR:NOTC:CLOC?

**Usage:**

Query only

---

**CONFigure:GENerator:NPRatio:NOTCh<notch>:COUNT:CState?**

Queries the state of the number of notches.

**Suffix:**

<notch>                    1..n  
                                 irrelevant

**Return values:**

<ControlState>            OFF | SUCCEssful | ERRor

**OFF**

Signal generator control off

**SUCCEssful**

Setting successfully applied on the signal generator

**ERRor**

Control error, for example because a specified value cannot be applied on the signal generator

**Example:**

CONF:GEN:NPR:NOTC:COUN:CST?

**Usage:**

Query only

**Manual operation:**

See "[Number of Notches](#)" on page 222

---

**CONFigure:GENerator:NPRatio:POWER:LEVEL:CState?**

Queries the state of the generator power level.

**Return values:**

<ControlState>            OFF | SUCCEssful | ERRor

**OFF**

Signal generator control off

**SUCCEssful**

Setting successfully applied on the signal generator



**ERRor**

Control error, for example because a specified value cannot be applied on the signal generator

**Example:** `CONF:GEN:NPR:POW:LEV:CST?`

**Usage:** Query only

**Manual operation:** See "[Level \(RMS\)](#)" on page 228

**CONFigure:GENerator:NPRatio:POWer:LEVel:OFFSet:CStAte?**

Queries the state of the generator level offset.

**Return values:**

<ControlState> OFF | SUCCessful | ERRor

**OFF**

Signal generator control off

**SUCCessful**

Setting successfully applied on the signal generator

**ERRor**

Control error, for example because a specified value cannot be applied on the signal generator

**Example:** `CONF:GEN:NPR:POW:LEV:OFFS:CST?`

**Usage:** Query only

**Manual operation:** See "[Level Offset](#)" on page 228

**CONFigure:GENerator:NPRatio:RFOutput:STATe:CStAte?**

Queries the state of the generator RF output.

**Return values:**

<ControlState> OFF | SUCCessful | ERRor

**OFF**

Signal generator control off

**SUCCessful**

Setting successfully applied on the signal generator

**ERRor**

Control error, for example because a specified value cannot be applied on the signal generator

**Example:** `CONF:GEN:NPR:RFO:STAT:CST?`

**Usage:** Query only

**Manual operation:** See "[RF Output State](#)" on page 227

---

**CONFigure:GENerator:NPRatio:SETTings:NOTCh:UPDate**

Applies all notch settings to the connected signal generator once.

**Example:** `CONF:GEN:NPR:SETT:NOTC:UPD`

**Usage:** Event

**Manual operation:** See "[Upload all Notch Settings to Generator](#)" on page 223

---

**CONFigure:GENerator:NPRatio:SETTings:UPDate**

Applies all generator setup settings to the connected signal generator once.

**Example:** `CONF:GEN:NPR:SETT:UPD`

**Usage:** Event

**Manual operation:** See "[Upload all Generator Setup Settings to Generator](#)" on page 229

---

**CONFigure:GENerator:NPRatio:STATe:CSTate?**

Queries the state of the generator notch filter.

**Return values:**

<ControlState> OFF | SUCCEssful | ERRor

**OFF**

Signal generator control off

**SUCCEssful**

Setting successfully applied on the signal generator

**ERRor**

Control error, for example because a specified value cannot be applied on the signal generator

**Example:** `CONF:GEN:NPR:STAT:CST?`

**Usage:** Query only

**Manual operation:** See "[Generator Notch Filter State](#)" on page 222

---

**CONFigure:GENerator:NPRatio[:STATe] <State>**

Activates or deactivates a notch filter on the signal generator.

**Parameters:**

<State> ON | OFF | 0 | 1

**OFF | 0**

Switches the function off

**ON | 1**

Switches the function on

\*RST: 0

---

**Example:** `CONF:GEN:NPR:STAT ON`  
Enables a notch filter on the connected generator.

**Manual operation:** See "[Generator Notch Filter State](#)" on page 222

#### **CONFigure:GENerator:POWer:LEVel** <Level>

Defines the output power level used by the connected signal generator.

**Parameters:**

<Level>                    numeric value  
Default unit: DBM

**Example:** `CONF:GEN:POW:LEV 25`

**Manual operation:** See "[Level \(RMS\)](#)" on page 228

#### **CONFigure:GENerator:POWer:LEVel:OFFSet** <LevelOffset>

Defines a fixed offset in the power level used by the generator, for example due to a gain from the DUT.

**Parameters:**

<LevelOffset>            numeric value  
Default unit: DBM

**Example:** `CONF:GEN:POW:LEV:OFFS 5`

**Manual operation:** See "[Level Offset](#)" on page 228

#### **CONFigure:GENerator:RFOutput[:STATe]** <State>

Enables or disables RF output on the connected generator.

**Parameters:**

<State>                    ON | OFF | 0 | 1  
**OFF | 0**  
Switches the function off  
**ON | 1**  
Switches the function on  
\*RST:                    0

**Example:** `CONF:GEN:RFO:STAT ON`

**Manual operation:** See "[RF Output State](#)" on page 227

#### **CONFigure:GENerator:TARGet:PATH:BB?**

Queries the BB signal path of the generator used for signal generation.

**Return values:**

<Path>                    A | B

**Example:** `CONF:GEN:TARG:PATH:BB?`  
**Usage:** Query only  
**Manual operation:** See "[Path RF/ Path BB](#)" on page 227

#### **CONFigure:GENerator:TARGet:PATH:RF <Path>**

Selects the RF signal path of the generator to be used for signal generation.

**Parameters:**

<Path> A | B

**Example:** `CONF:GEN:TARG:PATH:RF B`

**Manual operation:** See "[Path RF/ Path BB](#)" on page 227

#### **CONFigure:SETTings:NPRatio**

**Usage:** Event

**Manual operation:** See "[Query all Generator Setup Settings from Generator](#)" on page 229

#### **CONFigure:SETTings:NPRatio:NOTCh**

**Usage:** Event

**Manual operation:** See "[Query all Notch Settings from Generator](#)" on page 223

### 13.5.6.4 Retrieving results from an NP measurement

[CALCulate<n>:NPRatio:RESult?](#)..... 996

#### **CALCulate<n>:NPRatio:RESult? <ResultType>**

Queries the power results of the noise power ratio measurement.

**Suffix:**

<n> irrelevant

**Query parameters:**

<ResultType> CPOWER | NPOWER | NPRatio | ALL

**CPOWER**

Returns the total measured power divided by the channel bandwidth (without notches) or integration bandwidth (with notches) in dBm/Hz

**NPOWER**

Returns the power measured in each notch divided by the notch bandwidth in dBm/Hz

**NPRatio**

Returns the ratio of the total channel power density divided by the notch power density for each notch in dB

**ALL**

Returns all power results for the channel and <n> defined notches in the following order:

<ChannelPowerDens>,<NotchPowerDens1>,...,<NotchPowerDens<n>>,<NPR1>,...,<NPR<n>>

**Return values:**

<ResultTypeResult>

**Example:**

```
CALC:NPR:RES? NPR
```

Returns the power ratio in dB for each notch.

**Usage:**

Query only

**13.5.6.5 Programming example: measuring the noise power ratio**

This example demonstrates how to determine the noise power ratio for the [Chapter 6.5.8, "Measurement example"](#), on page 232 in a remote environment.

```
//-----Configuring the measurement -----
//Reset the instrument
*RST
//Set the center frequency to 500 MHz
FREQ:CENT 500000000
FREQ:SPAN 80000000

//Activate NPR measurement.
NPR:STAT ON

//Specify the channel bandwidth to be used = 72 MHz
NPR:CHAN:BWID 72000000
NPR:CHAN:INT:AUTO ON
//Define the two notches at +/- 12.2 MHz from the CF,
//with a bandwidth of 3.6 MHz
NPR:NOTC:COUN 2
NPR:NOTC1:FREQ:OFFS -12200000
NPR:NOTC1:BWID 3.600000
NPR:NOTC2:FREQ:OFFS 12200000
NPR:NOTC2:BWID:REL 5

//-----Performing the Measurement-----
//Select single sweep mode.
INIT:CONT OFF

//Initiate a new measurement and wait until the sweep has finished.
INIT;*WAI
```

```
//-----Retrieving Results-----
//Query the noise power ratio for each notch.
CALC:NPR:RES? ALL
//Result:
//9.38,-51.73,-4685,-61.10,-56.26

//Query the measured power in each trace point
TRAC:DATA? TRACe1
//Returns 1001 power values
```

### 13.5.7 Measuring the spectrum emission mask

All remote control commands specific to spectrum emission mask measurements are described here.



See also [Chapter 13.5.2, "Configuring power measurements"](#), on page 911.

#### Remote commands exclusive to spectrum emission mask measurements:

- [Managing measurement configurations](#)..... 998
- [Controlling the measurement](#)..... 1000
- [Configuring a multi-sem measurement](#)..... 1000
- [Configuring a sweep list](#)..... 1001
- [Configuring the reference range](#)..... 1018
- [Configuring the power classes](#)..... 1019
- [Configuring MSR SEM measurements](#)..... 1024
- [Configuring the list evaluation](#)..... 1030
- [Performing an SEM measurement](#)..... 1032
- [Retrieving results](#)..... 1032
- [Example: SEM measurement](#)..... 1032

#### 13.5.7.1 Managing measurement configurations

The following commands control measurement configurations for SEM measurements.

<a href="#">CALCulate&lt;n&gt;:LIMit&lt;li&gt;:ESPectrum&lt;sb&gt;:RESTore</a> .....	998
<a href="#">[SENSe:]ESPectrum&lt;sb&gt;:PRESet[:STANdard]</a> .....	999
<a href="#">[SENSe:]ESPectrum&lt;sb&gt;:PRESet:RESTore</a> .....	999
<a href="#">[SENSe:]ESPectrum&lt;sb&gt;:PRESet:STORe</a> .....	999

---

#### **CALCulate<n>:LIMit<li>:ESPectrum<sb>:RESTore**

Restores the predefined limit lines for the selected Spectrum Emission Mask standard.

All modifications made to the predefined limit lines are lost and the factory-set values are restored.

**Suffix:**

<n>	irrelevant
<lj>	irrelevant
<sb>	1 to 8 Subblock in a multi-SEM measurement

**Example:**

```
CALC:LIM:ESP:REST
```

Resets the limit lines for the current Spectrum Emission Mask standard to the default setting.

**[SENSe:]ESpectrum<sb>:PRESet[:STANdard] <Standard>**

Loads a measurement configuration.

Standard definitions are stored in an xml file. The default directory for SEM standards is C:\R\_S\INSTR\sem\_std.

**Suffix:**

<sb>	1 to 8 Subblock in a multi-SEM measurement
------	-----------------------------------------------

**Parameters:**

<Standard>	String containing the file name. If you have stored the file in a subdirectory of the directory mentioned above, you have to include the relative path to the file.
------------	------------------------------------------------------------------------------------------------------------------------------------------------------------------------

**Manual operation:** See "[Standard / MSR Settings](#)" on page 255  
See "[Load Standard](#)" on page 263

**[SENSe:]ESpectrum<sb>:PRESet:RESTore**

Restores the default configurations of predefined SEM standards.

Note that the command will overwrite customized standards that have the same name as predefined standards.

**Suffix:**

<sb>	1 to 8 Subblock in a multi-SEM measurement
------	-----------------------------------------------

**Manual operation:** See "[Restore Standard Files](#)" on page 264

**[SENSe:]ESpectrum<sb>:PRESet:STORE <Standard>**

Saves the current SEM measurement configuration.

Standard definitions are stored in an xml file. The default directory for SEM standards is C:\R\_S\INSTR\sem\_std.

**Suffix:**

<sb>	1 to 8 Subblock in a multi-SEM measurement
------	-----------------------------------------------

**Parameters:**

<Standard> String containing the file name.  
 You can save the file in a subdirectory of the directory mentioned above. In that case, you have to include the relative path to the file.

**Manual operation:** See "Save Standard" on page 263

**13.5.7.2 Controlling the measurement**

The following commands control the measurement itself.

`INITiate<n>:ESpectrum`..... 1000  
`[SENSe:]SWEep:MODE`..... 1000

**INITiate<n>:ESpectrum**

Initiates a Spectrum Emission Mask measurement.

**Suffix:**

<n> irrelevant

**Usage:**

Asynchronous command

**[SENSe:]SWEep:MODE <Mode>**

Selects the spurious emission and spectrum emission mask measurements.

You can select other measurements with

- `CALCulate<n>:MARKer<m>:FUNCTION:POWer<sb>[:STATe]`

**Parameters:**

<Mode> LIST | AUTO | ESpectrum

**AUTO**

Turns on basic spectrum measurements.

**ESpectrum**

Turns on spectrum emission mask measurements.

**LIST**

Turns on spurious emission measurements.

\*RST: AUTO

**Example:**

`SWE:MODE ESP`

**13.5.7.3 Configuring a multi-sem measurement**

In the Spectrum application only, spectrum emissions can be measured for multiple sub blocks of channels (see [Chapter 6.6.4.5, "SEM with multiple sub blocks \("Multi-SEM"\)](#)", on page 244). Up to 8 sub blocks (with 7 gaps) can be defined. For each sub block, the familiar configuration settings concerning ranges, limit lines etc. can be



defined in individual tabs (select the sub block using the <sb> suffix in the corresponding commands). In addition, settings on the sub blocks themselves must be configured.

Useful commands for multi-SEM measurements described elsewhere:

- [\[SENSe:\]ESpectrum<sb>:RANGe<ri>:MLCalc](#) on page 1015

#### Remote commands exclusive to multi-SEM measurements

<a href="#">[SENSe:]ESpectrum&lt;sb&gt;:SCENter</a> .....	1001
<a href="#">[SENSe:]ESpectrum&lt;sb&gt;:SCOunt</a> .....	1001

#### **[SENSe:]ESpectrum<sb>:SCENter** <Frequency>

Defines the center frequency of the selected sub block in a Multi-SEM measurement.

##### Suffix:

<sb> 1 to 8  
Subblock in a multi-SEM measurement

##### Parameters:

<Frequency> Frequency within the currently defined global span (see [\[SENSe:\]FREQuency:SPAN](#) on page 1194 and [\[SENSe:\]FREQuency:CENTer](#) on page 1192).

Range: 1 to 3

\*RST: 1

Default unit: Hz

**Example:** ESP1:SCEN 1GHZ

**Manual operation:** See "[Sub Block / Center Freq](#)" on page 255

#### **[SENSe:]ESpectrum<sb>:SCOunt** <Subblocks>

Defines the number of sub blocks in the SEM measurement.

##### Suffix:

<sb> 1 to 8  
Subblock in a multi-SEM measurement

##### Parameters:

<Subblocks> Number of sub blocks in the SEM measurement.

Range: 1 to 8

\*RST: 1

**Example:** ESP:SCO 2

**Manual operation:** See "[Sub Block Count](#)" on page 255

#### 13.5.7.4 Configuring a sweep list

The following commands define a sweep list for SEM measurements.



The sweep list cannot be configured using remote commands during an on-going sweep operation.

See also:

- `CALCulate<n>:LIMit<li>:ESpectrum<sb>:PCLass<pc>:LIMit[:STATe]` on page 1023

<code>[SENSe:]ESpectrum&lt;sb&gt;:HSPeEd</code> .....	1002
<code>[SENSe:]ESpectrum&lt;sb&gt;:RANGe&lt;ri&gt;:BANDwidth:RESolution</code> .....	1003
<code>[SENSe:]ESpectrum&lt;sb&gt;:RANGe&lt;ri&gt;:BANDwidth:VIDeo</code> .....	1003
<code>[SENSe:]ESpectrum&lt;sb&gt;:RANGe&lt;ri&gt;:COUNT?</code> .....	1004
<code>[SENSe:]ESpectrum&lt;sb&gt;:RANGe&lt;ri&gt;:DELete</code> .....	1004
<code>[SENSe:]ESpectrum&lt;sb&gt;:RANGe&lt;ri&gt;:FILTer:TYPE</code> .....	1004
<code>[SENSe:]ESpectrum&lt;sb&gt;:RANGe&lt;ri&gt;[:FREquency]:START</code> .....	1005
<code>[SENSe:]ESpectrum&lt;sb&gt;:RANGe&lt;ri&gt;[:FREquency]:STOP</code> .....	1006
<code>[SENSe:]ESpectrum&lt;sb&gt;:RANGe&lt;ri&gt;:INPut:ATTenuation</code> .....	1006
<code>[SENSe:]ESpectrum&lt;sb&gt;:RANGe&lt;ri&gt;:INPut:ATTenuation:AUTO</code> .....	1006
<code>[SENSe:]ESpectrum&lt;sb&gt;:RANGe&lt;ri&gt;:INPut:GAIN[:VALue]</code> .....	1007
<code>[SENSe:]ESpectrum&lt;sb&gt;:RANGe&lt;ri&gt;:INPut:GAIN:STATe</code> .....	1007
<code>[SENSe:]ESpectrum&lt;sb&gt;:RANGe&lt;ri&gt;:INPut:SANalyzer:ATTenuation</code> .....	1008
<code>[SENSe:]ESpectrum&lt;sb&gt;:RANGe&lt;ri&gt;:INPut:SANalyzer:ATTenuation:AUTO</code> .....	1008
<code>[SENSe:]ESpectrum&lt;sb&gt;:RANGe&lt;ri&gt;:INsert</code> .....	1009
<code>[SENSe:]ESpectrum&lt;sb&gt;:RANGe&lt;ri&gt;:LIMit&lt;li&gt;:ABSolute:START</code> .....	1009
<code>[SENSe:]ESpectrum&lt;sb&gt;:RANGe&lt;ri&gt;:LIMit&lt;li&gt;:ABSolute:STOP</code> .....	1010
<code>[SENSe:]ESpectrum&lt;sb&gt;:RANGe&lt;ri&gt;:LIMit&lt;li&gt;:RELative:START</code> .....	1010
<code>[SENSe:]ESpectrum&lt;sb&gt;:RANGe&lt;ri&gt;:LIMit&lt;li&gt;:RELative:START:ABS</code> .....	1011
<code>[SENSe:]ESpectrum&lt;sb&gt;:RANGe&lt;ri&gt;:LIMit&lt;li&gt;:RELative:START:FUNCTion</code> .....	1011
<code>[SENSe:]ESpectrum&lt;sb&gt;:RANGe&lt;ri&gt;:LIMit&lt;li&gt;:RELative:STOP</code> .....	1012
<code>[SENSe:]ESpectrum&lt;sb&gt;:RANGe&lt;ri&gt;:LIMit&lt;li&gt;:RELative:STOP:ABS</code> .....	1013
<code>[SENSe:]ESpectrum&lt;sb&gt;:RANGe&lt;ri&gt;:LIMit&lt;li&gt;:RELative:STOP:FUNCTion</code> .....	1013
<code>[SENSe:]ESpectrum&lt;sb&gt;:RANGe&lt;ri&gt;:LIMit&lt;li&gt;:STATe</code> .....	1014
<code>[SENSe:]ESpectrum&lt;sb&gt;:RANGe&lt;ri&gt;:POINts:MINimum[:VALue]</code> .....	1015
<code>[SENSe:]ESpectrum&lt;sb&gt;:RANGe&lt;ri&gt;:MLCalc</code> .....	1015
<code>[SENSe:]ESpectrum&lt;sb&gt;:RANGe&lt;ri&gt;:RLEVel</code> .....	1015
<code>[SENSe:]ESpectrum&lt;sb&gt;:RANGe&lt;ri&gt;:SWEep:TIME</code> .....	1016
<code>[SENSe:]ESpectrum&lt;sb&gt;:RANGe&lt;ri&gt;:SWEep:TIME:AUTO</code> .....	1016
<code>[SENSe:]ESpectrum&lt;sb&gt;:RANGe&lt;ri&gt;:TRANSDucer</code> .....	1017
<code>[SENSe:]ESpectrum&lt;sb&gt;:SSETup</code> .....	1017

---

#### `[SENSe:]ESpectrum<sb>:HSPeEd <State>`

Turns high speed mode for SEM measurements on and off.

For more information including restrictions see [Chapter 6.6.4.3, "Fast SEM measurements"](#), on page 242.

**Suffix:**  
 <sb> 1 to 8  
 Subblock in a multi-SEM measurement

**Parameters:**  
 <State> ON | OFF | 0 | 1  
**OFF | 0**  
 Switches the function off  
**ON | 1**  
 Switches the function on

**Example:** ESP:HSP ON

**Manual operation:** See "[Fast SEM](#)" on page 250

### [SENSe:]ESpectrum<sb>:RANGe<ri>:BANDwidth:RESolution <RBW>

Defines the resolution bandwidth for a SEM range.

In case of high speed measurements, the resolution bandwidth has to be identical for all ranges.

**Suffix:**  
 <sb> 1 to 8  
 Subblock in a multi-SEM measurement

<ri> 1..n  
 Selects the measurement range.

**Parameters:**  
 <RBW> Resolution bandwidth.  
 Refer to the specifications document for available resolution bandwidths.  
 \*RST: 30.0 kHz  
 Default unit: Hz

**Manual operation:** See "[RBW](#)" on page 250

### [SENSe:]ESpectrum<sb>:RANGe<ri>:BANDwidth:VIDeo <VBW>

Defines the video bandwidth for a SEM range.

In case of high speed measurements, the video bandwidth has to be identical for all ranges.

**Suffix:**  
 <sb> 1 to 8  
 Subblock in a multi-SEM measurement

<ri> 1..n  
 Selects the measurement range.

**Parameters:**

<VBW> Video bandwidth.  
Refer to the specifications document for available video bandwidths.

\*RST: 10.0 MHz  
Default unit: Hz

**Manual operation:** See "[VBW](#)" on page 250

**[SENSe:]ESpectrum<sb>:RANGe<ri>:COUNT?**

Queries the number of ranges in the sweep list.

**Suffix:**

<sb> 1 to 8  
Subblock in a multi-SEM measurement

<ri> irrelevant

**Return values:**

<Ranges> Number of ranges in the sweep list.

**Usage:** Query only

**[SENSe:]ESpectrum<sb>:RANGe<ri>:DELeTe**

Removes a range from the sweep list.

Note that

- you cannot delete the reference range
- a minimum of three ranges is mandatory.

**Suffix:**

<sb> 1 to 8  
Subblock in a multi-SEM measurement

<ri> Selects the measurement range.

**Manual operation:** See "[Delete Range](#)" on page 254

**[SENSe:]ESpectrum<sb>:RANGe<ri>:FILTer:TYPE <FilterType>**

This command selects the filter type for an SEM range.

In case of high speed measurements, the filter has to be identical for all ranges.

The EMI-specific filter types are available if the EMI (R&S FSW-K54) measurement option is installed, even if EMI measurement is not active. For details see [Chapter 6.13.3.1, "Resolution bandwidth and filter types"](#), on page 335.

**Suffix:**

<sb> 1 to 8  
Subblock in a multi-SEM measurement

<ri> 1...30  
Selects the measurement range.

**Parameters:**

<FilterType> **NORMal**  
Gaussian filters

**CFILter**  
channel filters

**RRC**  
RRC filters

**CISPr | PULSe**  
CISPR (6 dB) - requires EMI (R&S FSW-K54) option  
Return value for query is always `PULS`.

**MIL**  
MIL Std (6 dB) - requires EMI (R&S FSW-K54) option

**P5**  
5 Pole filters

\*RST: NORM  
Refer to the specifications document for available filter bandwidths.

**Manual operation:** See "[Filter Type](#)" on page 250

**[SENSe:]ESpectrum<sb>:RANGe<ri>[:FREQUENCY]:STARt <Frequency>**

Defines the start frequency of a SEM range.

Make sure to set an appropriate span. If you set a span that is

- smaller than the span the SEM sweep list covers, the FSW will not measure the ranges that are outside the span - results may be invalid.
- greater than the span the SEM sweep list covers, the FSW will adjust the start frequency of the first SEM range and the stop frequency of the last SEM range to the span

For more information see [Chapter 6.6.4.1, "Ranges and range settings"](#), on page 238.

**Suffix:**

<sb> 1 to 8  
Subblock in a multi-SEM measurement

<ri> 1..n  
Selects the measurement range.

**Parameters:**

<Frequency> Numeric value. Note that the minimum frequency range of a SEM range is 20 Hz.

\*RST: -12.75 MHz (range 1), -2.515 MHz (range 2), 2.515 MHz (range 3)

Default unit: Hz

**Manual operation:** See "[Range Start / Range Stop](#)" on page 249

---

**[SENSe:]ESpectrum<sb>:RANGe<ri>[:FREQUENCY]:STOP <Frequency>**

Defines the stop frequency of a SEM range.

Make sure to set an appropriate span. If you set a span that is

- smaller than the span the SEM sweep list covers, the FSW will not measure the ranges that are outside the span - results may be invalid.
- greater than the span the SEM sweep list covers, the FSW will adjust the start frequency of the first SEM range and the stop frequency of the last SEM range to the span

For more information see [Chapter 6.6.4.1, "Ranges and range settings"](#), on page 238.

**Suffix:**

<sb>                    1 to 8  
Subblock in a multi-SEM measurement

<ri>                    1..n  
Selects the measurement range.

**Parameters:**

<Frequency>            Numeric value.  
\*RST:                -2.52 MHz (range 1), 2.52 MHz (range 2), 250.0 MHz (range 3)  
Default unit: Hz

**Manual operation:**    See ["Range Start / Range Stop"](#) on page 249

---

**[SENSe:]ESpectrum<sb>:RANGe<ri>:INPut:ATTenuation <Attenuation>**

Defines the input attenuation for a SEM range.

In case of high speed measurements, the input attenuation has to be identical for all ranges.

**Suffix:**

<sb>                    1 to 8  
Subblock in a multi-SEM measurement

<ri>                    1..n  
Selects the measurement range.

**Parameters:**

<Attenuation>            Numeric value.  
Refer to the specifications document for the attenuation range.  
\*RST:                10 dB  
Default unit: dB

**Manual operation:**    See ["RF Attenuation"](#) on page 251

---

**[SENSe:]ESpectrum<sb>:RANGe<ri>:INPut:ATTenuation:AUTO <State>**

Turns automatic selection of the input attenuation for a SEM range on and off.

In case of high speed measurements, the input attenuation has to be identical for all ranges.

**Suffix:**

<sb> 1 to 8  
Subblock in a multi-SEM measurement

<ri> 1..n  
Selects the measurement range.

**Parameters:**

<State> ON | OFF | 0 | 1  
\*RST: 1

**Example:**

```
ESP:RANG2:INP:ATT:AUTO OFF
```

Deactivates the RF attenuation auto mode for range 2.

**Manual operation:** See "[RF Att Mode](#)" on page 251

**[SENSe:]ESpectrum<sb>:RANGe<ri>:INPut:GAIN[:VALue] <Gain>**

This command selects the gain for a SEM range.

In case of high speed measurements, the level of the preamplifier has to be identical for all ranges.

**Suffix:**

<sb> 1 to 8  
Subblock in a multi-SEM measurement

<ri> 1..30  
Selects the measurement range.

**Parameters:**

<Gain> 15 dB | 30 dB  
The availability of preamplification levels depends on the FSW model.

- FSW8/13: 15dB and 30 dB
- FSW26 or higher: 30 dB

All other values are rounded to the nearest of these two.

\*RST: OFF

**[SENSe:]ESpectrum<sb>:RANGe<ri>:INPut:GAIN:STATe <State>**

Turns the preamplifier for a SEM range on and off.

In case of high speed measurements, the state of the preamplifier has to be identical for all ranges.

**Suffix:**

<sb> 1 to 8  
Subblock in a multi-SEM measurement

<ri> 1..n  
Selects the measurement range.

**Parameters:**

<State> ON | OFF | 1 | 0  
\*RST: 0

**Manual operation:** See "[Preamp](#)" on page 252

**[SENSe:]ESpectrum<sb>:RANGe<ri>:INPut:SANalyzer:ATTenuation**  
<Attenuation>

This command defines the input attenuation for a SEM range.

If an external frontend is active (see [[SENSe:\]EFRontend\[:STATe\]](#) on page 1124), you can configure attenuation settings for the external frontend and the analyzer separately. This setting defines the attenuation for the analyzer.

In case of high speed measurements, the input attenuation has to be identical for all ranges.

**Suffix:**

<sb> 1 to 8  
Subblock in a multi-SEM measurement

<ri> 1..n  
Selects the measurement range.

**Parameters:**

<Attenuation> Numeric value.  
Refer to the specifications document for the attenuation range.  
\*RST: 10 dB  
Default unit: dB

**Example:**

```
ESP:RANG2:INP:SAN:ATT:AUTO OFF
Deactivates the RF attenuation auto mode at the analyzer for
range 2.
ESP:RANG2:INP:SAN:ATT 5
```

**Manual operation:** See "[SPA: RF Attenuation Mode / SPA: RF Attenuation](#)" on page 251

**[SENSe:]ESpectrum<sb>:RANGe<ri>:INPut:SANalyzer:ATTenuation:AUTO**  
<State>

This command turns automatic selection of the input attenuation for a SEM range on and off.

If an external frontend is active (see [[SENSe:\]EFRontend\[:STATe\]](#) on page 1124), you can configure attenuation settings for the external frontend and the analyzer separately. This setting defines the attenuation for the analyzer.

In case of high speed measurements, the input attenuation has to be identical for all ranges.



**Suffix:**

<sb> 1 to 8  
Subblock in a multi-SEM measurement

<ri> 1..n  
Selects the measurement range.

**Parameters:**

<State> ON | OFF | 0 | 1  
\*RST: 1

**Example:**

```
ESP:RANG2:INP:SAN:ATT:AUTO OFF
```

Deactivates the RF attenuation auto mode at the analyzer for range 2.

```
ESP:RANG2:INP:SAN:ATT 5
```

**Manual operation:** See "[SPA: RF Attenuation Mode / SPA: RF Attenuation](#)" on page 251

**[SENSe:]ESpectrum<sb>:RANGe<ri>:INSert <Mode>**

Inserts a new SEM range and updates the range numbers accordingly.

**Suffix:**

<sb> 1 to 8  
Subblock in a multi-SEM measurement

<ri> 1..n  
Selects the SEM range.

**Parameters:**

<Mode> AFTer | BEFore

**AFTer**

Inserts a range after the selected range.

**BEFore**

Inserts a range before the selected range.

**Manual operation:** See "[Insert before Range / Insert after Range](#)" on page 254

**[SENSe:]ESpectrum<sb>:RANGe<ri>:LIMit<li>:ABSolute:STARt <Level>**

Defines an absolute limit for a SEM range.

Unlike manual operation, you can define an absolute limit anytime and regardless of the limit check mode.

**Suffix:**

<sb> 1 to 8  
Subblock in a multi-SEM measurement

<ri> 1..n  
Selects the measurement range.

<li> 1..n  
Power class for which the limit is defined.

**Parameters:**

<Level> Absolute limit at the start frequency of a SEM range.  
Range: -400 to 400  
\*RST: -13  
Default unit: dBm

**Example:** `SENSe:ESpectrum:RANGe:LIMit:ABSolute:START -10`  
For a detailed example see [Chapter 13.5.7.11, "Example: SEM measurement"](#), on page 1032.

**Manual operation:** See "[Abs Limit Start / Stop <n>](#)" on page 253

**[SENSe:]ESpectrum<sb>:RANGe<ri>:LIMit<li>:ABSolute:STOP <Level>**

Defines an absolute limit for a SEM range.

Unlike manual operation, you can define an absolute limit anytime and regardless of the limit check mode.

**Suffix:**

<sb> 1 to 8  
Subblock in a multi-SEM measurement

<ri> 1..n  
Selects the measurement range.

<li> 1..n  
Power class for which the limit is defined.

**Parameters:**

<Level> Absolute limit at the stop frequency of a SEM range.  
Range: -400 to 400  
\*RST: -13  
Default unit: dBm

**Example:** `SENSe:ESpectrum:RANGe:LIMit:ABSolute:STOP -15`  
For a detailed example see [Chapter 13.5.7.11, "Example: SEM measurement"](#), on page 1032.

**Manual operation:** See "[Abs Limit Start / Stop <n>](#)" on page 253

**[SENSe:]ESpectrum<sb>:RANGe<ri>:LIMit<li>:RELative:STARt <Level>**

Defines a relative limit for a SEM range.

Unlike manual operation, you can define a relative limit regardless of the limit check mode.

**Suffix:**

<sb> 1 to 8  
Subblock in a multi-SEM measurement

<ri> 1..n  
Selects the SEM range.

<li> 1..n  
Power class for which the limit is defined.

**Parameters:**

<Level> Relative limit at the start frequency of a SEM range.  
Range: -400 to 400  
\*RST: -50  
Default unit: dBc

**Example:** SENS:ESP:RANG:LIM:REL:STAR -10

**Manual operation:** See "[Rel Limit Start / Stop <n>](#)" on page 253

**[SENSe:]ESpectrum<sb>:RANGe<ri>:LIMit<li>:RELative:STARt:ABS <Level>**

Defines an absolute limit for the MAX function of the relative limit for a SEM range.

For more information see "[Relative limit line functions](#)" on page 241.

**Suffix:**

<sb> 1 to 8  
Subblock in a multi-SEM measurement

<ri> 1..n  
Selects the SEM range.

<li> 1..n  
Power class for which the limit is defined.

**Parameters:**

<Level> Absolute limit at the start frequency of a SEM range to be used in addition to the relative limit if the MAX function is enabled (see [\[SENSe:\]ESpectrum<sb>:RANGe<ri>:LIMit<li>:RELative:STARt:FUNCTION](#) on page 1011).  
Range: -400 to 400  
\*RST: -13  
Default unit: dBm

**Example:** SENSe:ESpectrum:RANGe:LIMit:RELative:STARt:ABSolute -10

For a detailed example see [Chapter 13.5.7.11, "Example: SEM measurement"](#), on page 1032.

**Manual operation:** See "[Rel Limit Start / Stop <n>](#)" on page 253

**[SENSe:]ESpectrum<sb>:RANGe<ri>:LIMit<li>:RELative:STARt:FUNCTION <Function>**

**Suffix:**

<sb> 1 to 8  
Subblock in a multi-SEM measurement

<ri>	1..n Selects the SEM range.
<li>	1..n Power class for which the limit is defined.
<b>Parameters:</b>	
<Function>	OFF   MAX Defines the function to be used to determine the relative limit line start value <b>MAX</b> The maximum of the relative <i>and</i> the absolute level is used as the limit start value. Use the [SENSe:]ESpectrum<sb>:RANGe<ri>:LIMit<li>:RELative:START and [SENSe:]ESpectrum<sb>:RANGe<ri>:LIMit<li>:RELative:START:ABS commands to define these values. <b>OFF</b> No function is used, the relative limit line is defined by a fixed relative start value. Use the [SENSe:]ESpectrum<sb>:RANGe<ri>:LIMit<li>:RELative:START command to define this value. *RST: OFF
<b>Example:</b>	SENSe:ESpectrum:RANGe:LIMit:RELative:START:FUNCTION MAX For a detailed example see <a href="#">Chapter 13.5.7.11, "Example: SEM measurement"</a> , on page 1032.
<b>Manual operation:</b>	See " <a href="#">Rel Limit Start / Stop &lt;n&gt;</a> " on page 253

---

### [SENSe:]ESpectrum<sb>:RANGe<ri>:LIMit<li>:RELative:STOP <Level>

Defines a relative limit for a SEM range.

Unlike manual operation, you can define a relative limit anytime and regardless of the limit check mode.

**Suffix:**

<sb>	1 to 8 Subblock in a multi-SEM measurement
<ri>	1..n Selects the SEM range.
<li>	1..n Power class for which the limit is defined.

**Parameters:**

<Level>	Relative limit at the stop frequency of a SEM range. Range: -400 to 400 *RST: -50 Default unit: dBc
---------	--------------------------------------------------------------------------------------------------------------

**Example:** `SENSe:ESpectrum:RANGe:LIMit:RELative:STOP -15`  
 For a detailed example see [Chapter 13.5.7.11, "Example: SEM measurement"](#), on page 1032.

**Manual operation:** See ["Rel Limit Start / Stop <n>"](#) on page 253

**[SENSe:]ESpectrum<sb>:RANGe<ri>:LIMit<li>:RELative:STOP:ABS <Level>**

Defines an absolute limit for the MAX function of the relative limit for a SEM range.

For more information see ["Relative limit line functions"](#) on page 241.

**Suffix:**

<sb> 1 to 8  
 Subblock in a multi-SEM measurement

<ri> 1..n  
 Selects the SEM range.

<li> 1..n  
 Power class for which the limit is defined.

**Parameters:**

<Level> Absolute limit at the stop frequency of a SEM range to be used in addition to the relative limit if the MAX function is enabled (see [\[SENSe:\]ESpectrum<sb>:RANGe<ri>:LIMit<li>:RELative:STOP:FUNCTION](#) on page 1013).

Range: -400 to 400  
 \*RST: -13  
 Default unit: dBm

**Example:** `SENSe:ESpectrum:RANGe:LIMit:RELative:STOP:ABSolute -15`  
 For a detailed example see [Chapter 13.5.7.11, "Example: SEM measurement"](#), on page 1032.

**Manual operation:** See ["Rel Limit Start / Stop <n>"](#) on page 253

**[SENSe:]ESpectrum<sb>:RANGe<ri>:LIMit<li>:RELative:STOP:FUNCTION <Function>**

Enables the use of a function when defining the relative limit for a SEM range.

**Suffix:**

<sb> 1 to 8  
 Subblock in a multi-SEM measurement

<ri> 1..n  
 Selects the SEM range.

<li> 1..n  
 Power class for which the limit is defined.

**Parameters:**

<Function> OFF | MAX

Defines the function to be used to determine the relative limit line stop value

#### MAX

The maximum of the relative *and* the absolute level is used as the limit stop value. Use the `[SENSe:]ESpectrum<sb>:RANGe<ri>:LIMit<li>:RELative:STOP` and `[SENSe:]ESpectrum<sb>:RANGe<ri>:LIMit<li>:RELative:STOP:ABS` commands to define these values.

#### OFF

No function is used, the relative limit line is defined by a fixed relative stop value. Use the `[SENSe:]ESpectrum<sb>:RANGe<ri>:LIMit<li>:RELative:STOP` command to define this value.

\*RST: OFF

#### Example:

```
SENSe:ESpectrum:RANGe:LIMit:RELative:STOP:
FUNction MAX
```

For a detailed example see [Chapter 13.5.7.11, "Example: SEM measurement"](#), on page 1032.

**Manual operation:** See "Rel Limit Start / Stop <n>" on page 253

**[SENSe:]ESpectrum<sb>:RANGe<ri>:LIMit<li>:STATe <State>**

Selects the limit check mode for *all* SEM ranges (<range> is irrelevant).

#### Suffix:

<sb>	1 to 8 Subblock in a multi-SEM measurement
<ri>	1..n Selects the SEM range.
<li>	1..n Power class for which the limit is defined.

#### Parameters:

<State> ABSolute | RELative | AND | OR

#### ABSolute

Checks only the absolute limits defined.

#### RELative

Checks only the relative limits. Relative limits are defined as relative to the measured power in the reference range.

#### AND

Combines the absolute and relative limit. The limit check fails when both limits are violated.

#### OR

Combines the absolute and relative limit. The limit check fails when one of the limits is violated.

\*RST: RELative

**Manual operation:** See "[Limit Check <n>](#)" on page 252

---

**[SENSe:]ESpectrum<sb>:RANGe<ri>:POINTs:MINimum[:VALue] <SweepPoint>**

Defines the minimum number of sweep points for the range.

**Suffix:**

<sb>                    1 to 8  
Subblock in a multi-SEM measurement

<ri>                    Selects the measurement range.

**Parameters:**

<SweepPoint>        Minimum number of sweep points per range

Range:                1 to 32001

\*RST:                 1

**Example:**            SENSe1:ESpectrum:RANGe3:POINTs:MIN:VALue 400

**Manual operation:** See "[Min Sweep Points](#)" on page 254

---

**[SENSe:]ESpectrum<sb>:RANGe<ri>:MLCalc <Function>**

Defines the function used to calculate the limit line for the n-th power class for overlapping ranges in Multi-SEM measurements. For details see "[Limit calculation for individual ranges](#)" on page 245.

**Suffix:**

<sb>                    1 to 8  
Subblock in a multi-SEM measurement

<ri>                    1..n  
Selects the measurement range.

**Parameters:**

<Function>            NONE | MAX | SUM

**NONE**  
(reference ranges only:) the limit of the reference range is used; Reference ranges always use the function "NONE".

**SUM**  
sum of the two limit lines (calculated for linear powers) is used

**MAX**  
maximum of the two limit lines is used

\*RST:                 SUM (reference range: NONE)

**Manual operation:** See "[Multi-Limit Calc <n>](#)" on page 253

---

**[SENSe:]ESpectrum<sb>:RANGe<ri>:RLEVel <RefLevel>**

Defines the reference level for a SEM range.

In case of high speed measurements, the reference level has to be identical for all ranges.

**Suffix:**

<sb> 1 to 8  
Subblock in a multi-SEM measurement

<ri> 1..n  
Selects the measurement range.

**Parameters:**

<RefLevel> Reference level.  
Refer to the specifications document for the reference level range.

\*RST: 0 dBm  
Default unit: dBm

**Manual operation:** See "[Ref Level](#)" on page 251

**[SENSe:]ESpectrum<sb>:RANGe<ri>:SWEep:TIME <SweepTime>**

Defines the sweep time for a SEM range.

In case of high speed measurements, the sweep time has to be identical for all ranges.

**Suffix:**

<sb> 1 to 8  
Subblock in a multi-SEM measurement

<ri> 1..n  
Selects the measurement range.

**Parameters:**

<SweepTime> Sweep time.  
The range depends on the ratios of the span to the RBW and the RBW to the VBW. Refer to the specifications document for more information.

Default unit: s

**Manual operation:** See "[Sweep Time](#)" on page 251

**[SENSe:]ESpectrum<sb>:RANGe<ri>:SWEep:TIME:AUTO <State>**

Turns automatic selection of the sweep time for a SEM range on and off.

In case of high speed measurements, the sweep time has to be identical for all ranges.

**Suffix:**

<sb> 1 to 8  
Subblock in a multi-SEM measurement

<ri> 1..n  
Selects the measurement range.



**Parameters:**

<State> ON | OFF | 0 | 1  
 \*RST: 1

**Example:**

ESP:RANG3:SWE:TIME:AUTO OFF  
 Deactivates the sweep time auto mode for range 3.

**Manual operation:** See "[Sweep Time Mode](#)" on page 250

**[SENSe:]ESpectrum<sb>:RANGe<ri>:TRANsducer <Transducer>**

Selects a transducer factor for a SEM range.

Note that

- the transducer must cover at least the span of the range
- the x-axis has to be linear
- the unit has to be dB

**Suffix:**

<sb> 1 to 8  
 Subblock in a multi-SEM measurement

<ri> 1..n  
 Selects the measurement range.

**Parameters:**

<Transducer> String containing the transducer file name, including the path information.

**Manual operation:** See "[Transducer Factor](#)" on page 252

**[SENSe:]ESpectrum<sb>:SSETup <State>**

Enables or disables symmetrical configuration of the range settings.

See [Chapter 6.6.4.1, "Ranges and range settings"](#), on page 238.

**Suffix:**

<sb> 1 to 8  
 Subblock in a multi-SEM measurement

**Parameters:**

<State> ON | OFF | 0 | 1  
**OFF | 0**  
 Switches the function off

**ON | 1**  
 Switches the function on

\*RST: 0

**Manual operation:** See "[Symmetrical Setup](#)" on page 254

### 13.5.7.5 Configuring the reference range

The following commands define the reference range for the SEM sweep list.

[SENSe:]ESpectrum<sb>:BWID.....	1018
[SENSe:]ESpectrum<sb>:FILTer[:RRC]:ALPHa.....	1018
[SENSe:]ESpectrum<sb>:FILTer[:RRC][:STATe].....	1018
[SENSe:]ESpectrum<sb>:RRANge?.....	1019
[SENSe:]ESpectrum<sb>:RTYPe.....	1019

---

#### [SENSe:]ESpectrum<sb>:BWID <Bandwidth>

Defines the channel bandwidth of the reference range.

The bandwidth is available if the power reference is the channel power.

##### Suffix:

<sb>                                    1 to 8  
Subblock in a multi-SEM measurement

##### Parameters:

<Bandwidth>                        minimum span ≤ value ≤ span of reference range  
\*RST:                                3.84 MHz  
Default unit: Hz

**Manual operation:**    See "[Tx Bandwidth](#)" on page 257

---

#### [SENSe:]ESpectrum<sb>:FILTer[:RRC]:ALPHa <Alpha>

Defines the roll-off factor for the RRC filter.

The RRC filter is available if the power reference is the channel power.

##### Suffix:

<sb>                                    1 to 8  
Subblock in a multi-SEM measurement

##### Parameters:

<Alpha>                                Range:        0 to 1  
\*RST:                                0.22

**Manual operation:**    See "[Alpha:](#)" on page 257

---

#### [SENSe:]ESpectrum<sb>:FILTer[:RRC][:STATe] <State>

Turns the RRC filter in the reference range on and off.

The RRC filter is available if the power reference is the channel power.

##### Suffix:

<sb>                                    1 to 8  
Subblock in a multi-SEM measurement

**Parameters:**

<State> ON | OFF | 0 | 1  
 \*RST: 1

**Manual operation:** See "[RRC Filter State](#)" on page 257

**[SENSe:]ESpectrum<sb>:RRANge?**

Queries the reference range.

**Suffix:**

<sb> 1 to 8  
 Subblock in a multi-SEM measurement

**Return values:**

<RefRange> Number of the current reference range.  
 Range: 1 to 30

**Usage:** Query only

**[SENSe:]ESpectrum<sb>:RTYPE <Type>**

Defines the type of the power reference.

**Suffix:**

<sb> 1 to 8  
 Subblock in a multi-SEM measurement

**Parameters:**

<Type> PEAK | CPOWer

**PEAK**

Measures the highest peak within the reference range.

**CPOWer**

Measures the channel power within the reference range (integral bandwidth method).

\*RST: CPOWer

**Manual operation:** See "[Power Reference Type](#)" on page 256

**13.5.7.6 Configuring the power classes**

The following commands define the power classes for SEM measurements.

<a href="#">CALCulate&lt;n&gt;:LIMit&lt;li&gt;:ESpectrum&lt;sb&gt;:LIMits</a> .....	1020
<a href="#">CALCulate&lt;n&gt;:LIMit&lt;li&gt;:ESpectrum&lt;sb&gt;:MODE</a> .....	1021
<a href="#">CALCulate&lt;n&gt;:LIMit&lt;li&gt;:ESpectrum&lt;sb&gt;:VALue</a> .....	1021
<a href="#">CALCulate&lt;n&gt;:LIMit&lt;li&gt;:ESpectrum&lt;sb&gt;:PCLass&lt;pc&gt;:COUNT</a> .....	1022
<a href="#">CALCulate&lt;n&gt;:LIMit&lt;li&gt;:ESpectrum&lt;sb&gt;:PCLass&lt;pc&gt;[:EXCLusive]</a> .....	1022
<a href="#">CALCulate&lt;n&gt;:LIMit&lt;li&gt;:ESpectrum&lt;sb&gt;:PCLass&lt;pc&gt;:LIMit[:STATe]</a> .....	1023
<a href="#">CALCulate&lt;n&gt;:LIMit&lt;li&gt;:ESpectrum&lt;sb&gt;:PCLass&lt;pc&gt;:MAXimum</a> .....	1023
<a href="#">CALCulate&lt;n&gt;:LIMit&lt;li&gt;:ESpectrum&lt;sb&gt;:PCLass&lt;pc&gt;:MINimum</a> .....	1024

**CALCulate<n>:LIMit<li>:ESPectrum<sb>:LIMits <Max1>,<Max2>,<Max3>**

This command sets or queries up to 4 power classes in one step. You can only define values for the number of power classes defined by [CALCulate<n>:LIMit<li>:ESPectrum<sb>:PCLass<pc>:COUNT](#) on page 1022.

**Suffix:**

<n>	irrelevant
<li>	irrelevant
<sb>	1 to 8 Subblock in a multi-SEM measurement

**Setting parameters:**

<Max1>	<p>Defines the value range for power class 1 as -200 to &lt;Max1&gt;.</p> <p>Only available for <code>CALC:LIM:ESP:PCL:COUNT &gt;=2</code>            If only 2 power classes are defined, the value range for power class 2 is defined as &lt;Max1&gt; to 200.</p> <p>Range: -199 to + 199            Default unit: DBM</p>
<Max2>	<p>Defines the value range for power class 2 as &lt;Max1&gt; to &lt;Max2&gt;.</p> <p>Only available for <code>CALC:LIM:ESP:PCL:COUNT &gt;=3</code>            If only 3 power classes are defined, the value range for power class 3 is defined as &lt;Max2&gt; to 200.</p> <p>Range: -199 to + 199, &lt;Max2&gt; must be higher than &lt;Max1&gt;</p>
<Max3>	<p>Defines the value range for power class 3 as &lt;Max2&gt; to &lt;Max3&gt;.</p> <p>The value range for power class 4 is defined as &lt;Max3&gt; to 200.</p> <p>Only available for <code>CALC:LIM:ESP:PCL:COUNT = 4</code></p> <p>Range: -199 to + 199, &lt;Max3&gt; must be higher than &lt;Max2&gt;</p>

**Example:**

```
CALC:LIM:ESP:LIM -50,50,70
Defines the following power classes:
<-200, -50>
<-50, 50>
<50, 70>
<70, 200>
Query:
CALC:LIM:ESP:LIM?
Response:
-200,-50,50,70,200
```

**CALCulate<n>:LIMit<li>:ESPectrum<sb>:MODE <Mode>**

Which limit line is to be used for an SEM measurement depends on the power class the input signal power belongs to. This command defines whether the power class is determined automatically or manually.

**Suffix:**

<n>	irrelevant
<li>	irrelevant
<sb>	1 to 8 Subblock in a multi-SEM measurement

**Parameters:**

<Mode>	<b>AUTO</b> The power class (and thus the limit line) is assigned dynamically according to the currently measured channel power.
	<b>MANUAL</b> One of the specified power classes is selected manually for the entire measurement. The selection is made with the <a href="#">CALCulate&lt;n&gt;:LIMit&lt;li&gt;:ESPectrum&lt;sb&gt;:PCLass&lt;pc&gt;[:EXCLUSIVE]</a> command.
*RST:	AUTO

**Example:**

```
CALC:LIM:ESP:MODE AUTO
```

Activates automatic selection of the limit line.

**CALCulate<n>:LIMit<li>:ESPectrum<sb>:VALue <Power>**

Activates the manual limit line selection as and specifies the expected power as a value. Depending on the entered value, the associated predefined limit lines is selected.

Has the same effect as a combination of the [CALC:LIM:ESP:MODE MAN](#) and the [CALCulate<n>:LIMit<li>:ESPectrum<sb>:PCLass<pc>\[:EXCLUSIVE\]](#) commands; however, the power class to be used is not defined directly, but via the expected power. As opposed to [CALC:LIM:ESP:MODE AUTO](#), the power class is not re-assigned to the input signal power dynamically, but only once when the command is executed.

**Suffix:**

<n>	irrelevant
<li>	irrelevant
<sb>	1 to 8 Subblock in a multi-SEM measurement

**Parameters:**

<Power>	integer
Range:	-200 to 199
*RST:	0

**Example:** `CALC:LIM:ESP:VAL 33`  
 Activates manual selection of the limit line and selects the limit line for P = 33.

---

**CALCulate<n>:LIMit<li>:ESpectrum<sb>:PCLass<pc>:COUNT <NoPowerClasses>**

Sets the number of power classes to be defined.

Must be executed before any new power class values can be defined using `CALCulate<n>:LIMit<li>:ESpectrum<sb>:PCLass<pc>:MAXimum` and `CALCulate<n>:LIMit<li>:ESpectrum<sb>:PCLass<pc>:MINimum`.

**Suffix:**

<n>	irrelevant
<li>	irrelevant
<sb>	1 to 8 Subblock in a multi-SEM measurement
<pc>	irrelevant

**Parameters:**

<NoPowerClasses>	1 to 4
*RST:	1

**Example:** `CALC:LIM:ESP:PCL:COUN 2`  
 Two power classes can be defined.

**Manual operation:** See ["Adding or Removing a Power Class"](#) on page 259

---

**CALCulate<n>:LIMit<li>:ESpectrum<sb>:PCLass<pc>[:EXCLusive] <State>**

Selects the power class used by the measurement if `CALCulate<n>:LIMit<li>:ESpectrum<sb>:MODE` is set to manual.

Note that:

- You can only use power classes for which limits are defined.

**Suffix:**

<n>	irrelevant
<li>	irrelevant
<sb>	1 to 8 Subblock in a multi-SEM measurement
<pc>	1..n power class

**Parameters:**

<State>	ON   OFF   1   0
*RST:	0

**Example:** `CALC:LIM:ESP:PCL1 ON`  
Activates the first defined power class.

**Manual operation:** See "[Used Power Classes:](#)" on page 258

**CALCulate<n>:LIMit<li>:ESPectrum<sb>:PCLass<pc>:LIMit[:STATe] <State>**

Selects the limit check mode for each power class.

**Suffix:**

<n>	irrelevant
<li>	irrelevant
<sb>	1 to 8 Subblock in a multi-SEM measurement
<pc>	1..n power class

**Parameters:**

<State> ABSolute | RELative | AND | OR

**ABSolute**

Evaluates only limit lines with absolute power values

**RELative**

Evaluates only limit lines with relative power values

**AND**

Evaluates limit lines with relative and absolute power values. A negative result is returned if both limits fail.

**OR**

Evaluates limit lines with relative and absolute power values. A negative result is returned if at least one limit failed.

\*RST: REL

**Example:** `CALC:LIM:ESP:PCL:LIM ABS`

**Manual operation:** See "[Used Power Classes:](#)" on page 258

**CALCulate<n>:LIMit<li>:ESPectrum<sb>:PCLass<pc>:MAXimum <Level>**

Defines the upper limit of a particular power class.

Note:

- The last power class always has an upper limit of 200 dBm.
- The upper limit of a power class must always be the same as the lower limit of the subsequent power class.
- The power class must already exist (see [CALCulate<n>:LIMit<li>:ESPectrum<sb>:PCLass<pc>:COUNT](#) on page 1022).

**Suffix:**

<n>	irrelevant
-----	------------

<li>	irrelevant
<sb>	1 to 8 Subblock in a multi-SEM measurement
<pc>	1..n power class

**Parameters:**

<Level> Range: -199.9 dBm to 200 dBm  
Default unit: dBm

**Example:**

CALC:LIM:ESP:PCL1:MAX -40 dBm  
Sets the maximum power value of the first power class to -40 dBm.

**Manual operation:** See "PMin/ PMax" on page 258

**CALCulate<n>:LIMit<li>:ESPectrum<sb>:PCLass<pc>:MINimum <Level>**

Defines the lower limit of a particular power class.

Note:

- The first power class always has a lower limit of -200 dBm.
- The lower limit of a power class must always be the same as the upper limit of the previous power class.
- The power class must already exist (see [CALCulate<n>:LIMit<li>:ESPectrum<sb>:PCLass<pc>:COUNT](#) on page 1022).

**Suffix:**

<n>	irrelevant
<li>	irrelevant
<sb>	1 to 8 Subblock in a multi-SEM measurement
<pc>	1..n power class

**Parameters:**

<Level> Range: -200 dBm to 199.9 dBm  
Default unit: dBm

**Example:**

CALC:LIM:ESP:PCL2:MIN -40 dBm  
Sets the minimum power value of the second power class to -40 dBm.

**Manual operation:** See "PMin/ PMax" on page 258

**13.5.7.7 Configuring MSR SEM measurements**

The following commands configure MSR SEM measurements. For details see [Chapter 6.6.4.4, "Multi-standard radio \(MSR\) SEM measurements"](#), on page 243.



For manual operation see [Chapter 6.6.5.5, "MSR settings"](#), on page 259.

[SENSe:]ESpectrum<sb>:MSR:APPLY.....	1025
[SENSe:]ESpectrum<sb>:MSR:BAND.....	1025
[SENSe:]ESpectrum<sb>:MSR:BCATegory.....	1026
[SENSe:]ESpectrum<sb>:MSR:CLASs.....	1027
[SENSe:]ESpectrum<sb>:MSR:GSM:CARRier.....	1027
[SENSe:]ESpectrum<sb>:MSR:GSM:CPResent.....	1028
[SENSe:]ESpectrum<sb>:MSR:LTE:CPResent.....	1029
[SENSe:]ESpectrum<sb>:MSR:MPOWer.....	1029
[SENSe:]ESpectrum<sb>:MSR:RFBWidth.....	1030

---

### [SENSe:]ESpectrum<sb>:MSR:APPLY

Configures the SEM sweep list according to the MSR settings defined by previous commands.

#### Suffix:

<sb>                    1 to 8  
Subblock in a multi-SEM measurement

#### Example:

```
//Select the band category 1
ESP2:MSR:BCAT 1
//Set the base station class to medium range
ESP2:MSR:CLAS MED
//Set the maximum output power to 10 dBm.
ESP2:MSR:MPOW 10
//Set the frequency range of the base station to > 3 GHz
ESP2:MSR:BAND:HIGH
//Set the base station RF bandwidth to 20 MHz
ESP2:MSR:RFBW 20MHZ
//Calculate limits for MSR SEM
ESP2:MSR:APPL
```

**Manual operation:** See ["Apply to SEM"](#) on page 262

---

### [SENSe:]ESpectrum<sb>:MSR:BAND <Range>

Defines the frequency range of the bands used by the base station.

#### Suffix:

<sb>                    1 to 8  
Subblock in a multi-SEM measurement

#### Parameters:

<Range>                LOW | HIGH  
**LOW**  
≤ 3 GHz  
**HIGH**  
> 3 GHz  
\*RST:                LOW

**Example:**

```
//Select the band category 1
ESP2:MSR:BCAT 1
//Set the base station class to medium range
ESP2:MSR:CLAS MED
//Set the maximum output power to 10 dBm.
ESP2:MSR:MPOW 10
//Set the frequency range of the base station to > 3 GHz
ESP2:MSR:BAND:HIGH
//Set the base station RF bandwidth to 20 MHz
ESP2:MSR:RFBW 20MHZ
//Calculate limits for MSR SEM
ESP2:MSR:APPL
```

**Manual operation:** See ["Bands"](#) on page 261

---

### [SENSe:]ESpectrum<sb>:MSR:BCATegory <Category>

Defines the band category for MSR measurements, i.e. the combination of available carriers to measure.

**Suffix:**

<sb>                    1 to 8  
Subblock in a multi-SEM measurement

**Parameters:**

<Category>            1 | 2 | 3  
**1**  
2 carriers: LTE FDD and W-CDMA  
**2**  
3 carriers: LTE FDD, W-CDMA and GSM/EDGE  
**3**  
2 carriers: LTE TDD and TD-SCDMA  
**\*RST:**                1

**Example:**

```
//Select the band category 1
ESP2:MSR:BCAT 1
//Set the base station class to medium range
ESP2:MSR:CLAS MED
//Set the maximum output power to 10 dBm.
ESP2:MSR:MPOW 10
//Set the frequency range of the base station to > 3 GHz
ESP2:MSR:BAND:HIGH
//Set the base station RF bandwidth to 20 MHz
ESP2:MSR:RFBW 20MHZ
//Calculate limits for MSR SEM
ESP2:MSR:APPL
```

**Manual operation:** See ["Band Category"](#) on page 260

**[SENSe:]ESpectrum<sb>:MSR:CLASs <Class>**

Defines the class of the base station according to its sending range.

**Suffix:**

<sb> 1 to 8  
Subblock in a multi-SEM measurement

**Parameters:**

<Class> WIDE | MEDium | LOCal

**WIDE**

Wide Area

**MEDium**

Medium Range

**LOCal**

Local Area

\*RST: WIDE

**Example:**

```
//Select the band category 1
ESP2:MSR:BCAT 1
//Set the base station class to medium range
ESP2:MSR:CLAS MED
//Set the maximum output power to 10 dBm.
ESP2:MSR:MPOW 10
//Set the frequency range of the base station to > 3 GHz
ESP2:MSR:BAND:HIGH
//Set the base station RF bandwidth to 20 MHz
ESP2:MSR:RFBW 20MHZ
//Calculate limits for MSR SEM
ESP2:MSR:APPL
```

**Manual operation:** See "[Base Station Class](#)" on page 260

**[SENSe:]ESpectrum<sb>:MSR:GSM:CARRier <Power>**

Defines the power of the GSM carrier (if available, see [\[SENSe:\]ESpectrum<sb>:MSR:GSM:CPResent](#) on page 1028).

Is only available for band category 2 (see [\[SENSe:\]ESpectrum<sb>:MSR:BCATegory](#) on page 1026).

**Suffix:**

<sb> 1 to 8  
Subblock in a multi-SEM measurement

**Parameters:**

<Power> Range: 0 dBm to 100 dBm  
\*RST: 39.0 dBm  
Default unit: dBm

**Example:**

```
//Select the band category 2
ESP2:MSR:BCAT BC2
//Set the base station class to medium range
ESP2:MSR:CLAS MED
//Set the maximum output power to 10 dBm.
ESP2:MSR:MPOW 10
//Set the base station RF bandwidth to 20 MHz
ESP2:MSR:RFBW 20MHZ
//GSM/Edge present
ESP2:MSR:GSM:CPR ON
//Power of the GSM carrier is 20dBm
ESP2:MSR:GSM:CARR 20
//Calculate limits for MSR SEM
ESP2:MSR:APPL
```

**Manual operation:** See ["Power GSM Carrier"](#) on page 261

---

#### [SENSe:]ESpectrum<sb>:MSR:GSM:CPResent <State>

Defines whether a GSM/Edge carrier is located at the edge of the specified RF bandwidth. In this case, the specification demands specific limits for the SEM ranges.

Is only available for band category 2 (see [\[SENSe:\]ESpectrum<sb>:MSR:BCATegory](#) on page 1026).

#### Suffix:

<sb> 1 to 8  
Subblock in a multi-SEM measurement

#### Parameters:

<State> ON | OFF | 1 | 0  
\*RST: 0

**Example:**

```
//Select the band category 2
ESP2:MSR:BCAT BC2
//Set the base station class to medium range
ESP2:MSR:CLAS MED
//Set the maximum output power to 10 dBm.
ESP2:MSR:MPOW 10
//Set the base station RF bandwidth to 20 MHz
ESP2:MSR:RFBW 20MHZ
//GSM/Edge present
ESP2:MSR:GSM:CPR ON
//Power of the GSM carrier is 20dBm
ESP2:MSR:GSM:CARR 20
```

**Manual operation:** See ["Carrier Adjacent to RF Bandwidth Edge"](#) on page 261

**[SENSe:]ESpectrum<sb>:MSR:LTE:CPResent <State>**

Defines whether an LTE FDD 1.4 MHz or 3 MHz carrier is located at the edge of the specified RF bandwidth. In this case, the specification demands specific limits for the SEM ranges.

Is only available for band category 2 (see [\[SENSe:\]ESpectrum<sb>:MSR:BCATegory](#) on page 1026).

**Suffix:**

<sb>                    1 to 8  
Subblock in a multi-SEM measurement

**Parameters:**

<State>                ON | OFF | 1 | 0  
\*RST:                 0

**Example:**

```
//Select the band category 2
ESP2:MSR:BCAT BC2
//Set the base station class to medium range
ESP2:MSR:CLAS MED
//Set the maximum output power to 10 dBm.
ESP2:MSR:MPOW 10
//Set the base station RF bandwidth to 20 MHz
ESP2:MSR:RFBW 20MHZ
//LTE present
ESP2:MSR:LTE:CPR ON
//Calculate limits for MSR SEM
ESP2:MSR:APPL
```

**Manual operation:** See "[Carrier Adjacent to RF Bandwidth Edge](#)" on page 261

**[SENSe:]ESpectrum<sb>:MSR:MPOWER <Power>**

Defines the maximum output power of the base station.

This setting is only available for base stations with a medium range base station class (see [\[SENSe:\]ESpectrum<sb>:MSR:CLASSs](#) on page 1027).

**Suffix:**

<sb>                    1 to 8  
Subblock in a multi-SEM measurement

**Parameters:**

<Power>                Range:        0 dBm to 100 dBm  
Increment:    1 dB  
Default unit: dBm

**Example:**

```
//Select the band category 1
ESP2:MSR:BCAT 1
//Set the base station class to medium range
ESP2:MSR:CLAS MED
//Set the maximum output power to 10 dBm.
ESP2:MSR:MPOW 10
//Set the frequency range of the base station to > 3 GHz
ESP2:MSR:BAND:HIGH
//Set the base station RF bandwidth to 20 MHz
ESP2:MSR:RFBW 20MHZ
```

**Manual operation:** See "[Base Station Maximum Output Power](#)" on page 261

---

**[SENSe:]ESpectrum<sb>:MSR:RFBWidth <Bandwidth>**

Defines the RF bandwidth of the base station for MSR measurements.

**Suffix:**

<sb>                    1 to 8  
Subblock in a multi-SEM measurement

**Parameters:**

<Bandwidth>            Bandwidth in Hz  
\*RST:                    10.0 MHz  
Default unit: Hz

**Example:**

```
//Select the band category 1
ESP2:MSR:BCAT 1
//Set the base station class to medium range
ESP2:MSR:CLAS MED
//Set the maximum output power to 10 dBm.
ESP2:MSR:MPOW 10
//Set the frequency range of the base station to > 3 GHz
ESP2:MSR:BAND:HIGH
//Set the base station RF bandwidth to 20 MHz
ESP2:MSR:RFBW 20MHZ
//Calculate limits for MSR SEM
ESP2:MSR:APPL
```

**Manual operation:** See "[Base Station RF Bandwidth](#)" on page 261

### 13.5.7.8 Configuring the list evaluation

The following commands configure the list evaluation.

**Useful commands for SEM measurements described elsewhere**

- [MMEMory:STORe<n>:LIST](#) on page 1373

**Remote commands exclusive to SEM measurements**

CALCulate<n>:ESpectrum:PSEarch:AUTO.....	1031
CALCulate<n>:ESpectrum:PEAKsearch:AUTO.....	1031
CALCulate<n>:ESpectrum:PSEarch[:IMMEDIATE].....	1031
CALCulate<n>:ESpectrum:PEAKsearch[:IMMEDIATE].....	1031
CALCulate<n>:ESpectrum:PSEarch:MARGIN.....	1031
CALCulate<n>:ESpectrum:PEAKsearch:MARGIN.....	1031
CALCulate<n>:ESpectrum:PSEarch:PSHOW.....	1032
CALCulate<n>:ESpectrum:PEAKsearch:PSHOW.....	1032

---

**CALCulate<n>:ESpectrum:PSEarch:AUTO <State>**

**CALCulate<n>:ESpectrum:PEAKsearch:AUTO <State>**

Turns the list evaluation on and off.

**Suffix:**

<n> [Window](#)

**Parameters:**

<State> ON | OFF | 0 | 1

\*RST: 1

**Example:**

CALC:ESP:PSE:AUTO OFF

Deactivates the list evaluation.

**Manual operation:** See "[List Evaluation State \(result summary\)](#)" on page 265

---

**CALCulate<n>:ESpectrum:PSEarch[:IMMEDIATE]**

**CALCulate<n>:ESpectrum:PEAKsearch[:IMMEDIATE]**

Initiates a list evaluation.

**Suffix:**

<n> [Window](#)

---

**CALCulate<n>:ESpectrum:PSEarch:MARGIN <Threshold>**

**CALCulate<n>:ESpectrum:PEAKsearch:MARGIN <Margin>**

Defines the threshold of the list evaluation.

**Suffix:**

<n> [Window](#)

**Parameters:**

<Margin> Range: -200 to 200

\*RST: 200

Default unit: dB

**Example:**

CALC:ESP:PSE:MARG 100

Sets the margin to 100 dB.

**Manual operation:** See "[Margin](#)" on page 265

**CALCulate<n>:ESPectrum:PSEarch:PSHow <State>**

**CALCulate<n>:ESPectrum:PEAKsearch:PSHow <State>**

Turns the peak labels in the diagram on and off.

Peak labels are blue squares.

**Suffix:**

<n> [Window](#)

**Parameters:**

<State> ON | OFF | 1 | 0

\*RST: 0

**Example:**

CALC:ESP:PSE:PSH ON

Marks all peaks with blue squares.

**Manual operation:** See ["Show Peaks"](#) on page 265

### 13.5.7.9 Performing an SEM measurement

The following commands are required to perform an SEM measurement:

- [SENS:SWE:MODE ESP](#), see [\[SENSe:\]SWEep:MODE](#) on page 1000
- [INITiate<n>\[:IMMediate\]](#) on page 910

### 13.5.7.10 Retrieving results

The following commands analyze and retrieve measurement results for SEM measurements.

- [CALCulate<n>:LIMit<li>:FAIL?](#) on page 1344
- [TRACe<n>\[:DATA\]](#) on page 1258
- [TRACe<n>\[:DATA\]:MEMory?](#) on page 1260
- [TRACe<n>\[:DATA\]:X?](#) on page 1261
- [CALCulate<n>:MARKer<m>:FUNCTion:POWer<sb>:RESult?](#) on page 912

### 13.5.7.11 Example: SEM measurement

In this example we will configure and perform an SEM measurement. Note that this example is primarily meant to demonstrate the remote control commands, it does not necessarily reflect a useful measurement task. For most common measurement standards, the FSW performs the measurement optimally with the predefined settings, without further configuration.

```
//-----Preparing the measurement -----
//Reset the instrument
*RST

//----- Preparing the measurement-----
//Activate SEM Measurement
```



## Configuring and performing measurements

```

SWE:MODE ESP

//Selects single sweep mode.
//SEM has to be in single sweep mode to be configured and no sweep operation
//may be running!
// If required, a sweep stop can be ensured by INIT:IMM;*WAI
INIT:CONT OFF

//----- Managing Measurement Configurations-----
//Load the 3GPP configuration stored in the file '3GPP_UL.xml'
ESP:PRES 'WCDMA\3GPP\UL\3GPP_UL.xml'

//----- Defining the Reference Range-----
//Query the current reference range.
ESP:RRAN?
//Select the channel power as the power reference.
ESP:RTYP CPOW
//Define a channel bandwidth of 4 MHz for the power reference.
ESP:BWID 4 MHZ
//Use an RRC filter with a roll-off factor of 0.5 when measuring
//the reference power.
ESP:FILT:RRC ON
ESP:FILT:ALPH 0.5

//----- Configuring Power Classes-----
//Define 3 power classes.
CALC:LIM:ESP:PCL:COUN 3
//Define the value ranges of the three power classes as [dBm]:
//power class 1: -200 to -100
//power class 2: -100 to 0
//power class 3: 0 to 200
CALC:LIM:ESP:LIM -100,0
//Define an absolute limit check for class 1.
CALC:LIM:ESP:PCL1:LIM ABS
//Define a relative limit check for class 2.
CALC:LIM:ESP:PCL2:LIM REL
//Define a manual selection of the power class.
CALC:LIM:ESP:MODE MAN
//Activate the use of the second power class for the entire measurement.
CALC:LIM:ESP:PCL2 ON

//----- Configuring a Sweep List-----
//Insert a range after range 2.
ESP:RANG2:INS AFT
//Insert a range before range 1.
ESP:RANG1:INS BEF
//Query the number of measurement ranges in the sweep list (currently 11).
ESP:RANG:COUNT?
//Delete the 11th range.

```

## Configuring and performing measurements

```

ESP:RANG5:DEL

//Define a stop frequency of -9 MHz for range 1.
ESP:RANG1:STOP -10000000

//Define a start frequency of -10 MHz for range 2.
ESP:RANG2:STAR -9000000

//Switch off Fast SEM mode so the ranges can be configured individually.
ESP:HSP OFF

//Define a resolution bandwidth of 1 MHz for range 2.
ESP:RANG2:BAND:RES 1000000

//Select an RRC filter for range 2.
ESP:RANG2:FILT:TYPE RRC

//Define a video bandwidth of 5 MHz for range 2.
ESP:RANG2:BAND:VID 5000000
//Define a sweep time of 1 second for range 2.
ESP:RANG2:SWE:TIME 1
//Define a reference level of 0 dBm for range 2.
ESP:RANG2:RLEV 0
//Define an input attenuation of 10 dB for range 2.
ESP:RANG2:INP:ATT 10

// Create a transducer that can be used.
// It has to cover the corresponding frequency range

SENSE1:CORREction:TRANSDUCER:SElect 'Transducer'
SENSE1:CORREction:TRANSDUCER:UNIT 'DB'
SENSE1:CORREction:TRANSDUCER:COMMENT 'Test Transducer'
// Frequency Span 0 MHz bis 20 Ghz
SENSE1:CORREction:TRANSDUCER:DATA 0e6,5, 20e9,3

//Include a transducer called 'transducer' for range 2.
ESP:RANG2:TRAN 'Transducer'

//----- Configuring the limit check-----

//Check the absolute and relative limits for all ranges in power class 1 and
//fails if both limits are violated. Since power class 2 is set to be used for
//the entire measurement, values for Limit Check 1 are irrelevant. They are
//defined here to demonstrate the use of the MAX function for relative limits.
ESP:RANG:LIM1:STAT AND
//Enable the use of maximum function for relative limit start. If the value
//exceeds the larger of the absolute (-13 dBm) and relative (-10 dBc) start
//values, the check fails.
ESP:RANG2:LIM1:REL:STAR:FUNC MAX

```

## Configuring and performing measurements

```

ESP:RANG2:LIM1:REL:STAR -10
ESP:RANG2:LIM1:REL:STAR:ABS -13
ESP:RANG2:LIM1:REL:STOP:FUNC MAX
ESP:RANG2:LIM1:REL:STOP -10
ESP:RANG2:LIM1:REL:STOP:ABS -13

//Check the absolute and relative limits for all ranges in power class 2 and
//fails if either limit is violated. Since power class 2 is set to be used for
//the entire measurement, values for Limit Check 1 are irrelevant.
ESP:RANG:LIM2:STAT OR
//Define an absolute limit of 10 dBm for the entire range 2 for power class 2.
ESP:RANG2:LIM2:ABS:STAR 10
ESP:RANG2:LIM2:ABS:STOP 10
//Define a relative limit of -20 dBc for the entire range 2 for power class 2.
ESP:RANG2:LIM2:REL:STAR -20
ESP:RANG2:LIM2:REL:STOP -20

//----- Configuring List Evaluation-----
//Activate list evaluation, i.e. the peak is determined for each range
//after each sweep.
CALC:ESP:PSE:AUTO ON
//Define a peak threshold of 10 dB.
CALC:ESP:PSE:MARG 10dB

//----- Managing Measurement Configurations-----

//Save the current configuration in a new file named '3GPP_UL_User'
//in the same directory so the standard is not overwritten.
ESP:PRES:STOR 'WCDMA\3GPP\UL\3GPP_UL_User.xml'

//----- Performing the measurement-----
//One sweep
INIT:ESP

//----- Checking the Results-----
//Query the result of the limit check for all ranges.
CALC:LIM:FAIL?
//Query the peak for each range of the SEM measurement as a list.
TRAC:DATA? LIST

```

### 13.5.8 Measuring spurious emissions

The following commands are required to perform spurious emissions measurements.

- [Initializing the measurement](#)..... 1036
- [Configuring a sweep list](#)..... 1036
- [Configuring the list evaluation](#)..... 1046
- [Adjusting the X-axis to the range definitions](#)..... 1048

- [Performing a spurious measurement](#)..... 1048
- [Retrieving and saving settings and results](#)..... 1048
- [Programming example: spurious emissions measurement](#)..... 1048

### 13.5.8.1 Initializing the measurement

Note that with the FSW, the spurious measurement must be initialized before you can start configuring the sweep list or list evaluation.

[INITiate<n>:SPURious](#)..... 1036

---

#### INITiate<n>:SPURious

Initiates a Spurious Emission measurement.

#### Suffix:

<n>

**Usage:** Asynchronous command

### 13.5.8.2 Configuring a sweep list

The following commands configure the sweep list for spurious emission measurements.



The sweep list cannot be configured using remote commands during an on-going sweep operation.

Useful commands for configuring the sweep described elsewhere:

- [\[SENSe:\]SWEep:MODE](#) on page 1000

#### Remote commands exclusive to spurious measurements:

<a href="#">[SENSe:]LIST:RANGe&lt;ri&gt;:BANDwidth:RESolution</a> .....	1037
<a href="#">[SENSe:]LIST:RANGe&lt;ri&gt;:BANDwidth:VIDeo</a> .....	1037
<a href="#">[SENSe:]LIST:RANGe&lt;ri&gt;:BREak</a> .....	1037
<a href="#">[SENSe:]LIST:RANGe&lt;ri&gt;:COUNT?</a> .....	1038
<a href="#">[SENSe:]LIST:RANGe&lt;ri&gt;:DELete</a> .....	1038
<a href="#">[SENSe:]LIST:RANGe&lt;ri&gt;:DETector</a> .....	1038
<a href="#">[SENSe:]LIST:RANGe&lt;ri&gt;[:FREQuency]:START</a> .....	1039
<a href="#">[SENSe:]LIST:RANGe&lt;ri&gt;[:FREQuency]:STOP</a> .....	1039
<a href="#">[SENSe:]LIST:RANGe&lt;ri&gt;:FILTer:TYPE</a> .....	1040
<a href="#">[SENSe:]LIST:RANGe&lt;ri&gt;:INPut:ATTenuation</a> .....	1041
<a href="#">[SENSe:]LIST:RANGe&lt;ri&gt;:INPut:ATTenuation:AUTO</a> .....	1041
<a href="#">[SENSe:]LIST:RANGe&lt;ri&gt;:INPut:GAIN:STATe</a> .....	1041
<a href="#">[SENSe:]LIST:RANGe&lt;ri&gt;:INPut:GAIN[:VALue]</a> .....	1042
<a href="#">[SENSe:]LIST:RANGe&lt;ri&gt;:INPut:SANalyzer:ATTenuation</a> .....	1042
<a href="#">[SENSe:]LIST:RANGe&lt;ri&gt;:INPut:SANalyzer:ATTenuation:AUTO</a> .....	1042
<a href="#">[SENSe:]LIST:RANGe&lt;ri&gt;:LIMit:START</a> .....	1043
<a href="#">[SENSe:]LIST:RANGe&lt;ri&gt;:LIMit:STATe</a> .....	1043

[SENSe:]LIST:RANGe<ri>:LIMit:STOP.....	1044
[SENSe:]LIST:RANGe<ri>:POINts[:VALue].....	1044
[SENSe:]LIST:RANGe<ri>:RLEVel.....	1044
[SENSe:]LIST:RANGe<ri>:SWEep:TIME.....	1045
[SENSe:]LIST:RANGe<ri>:SWEep:TIME:AUTO.....	1045
[SENSe:]LIST:RANGe<ri>:TRANsducer.....	1045

---

### [SENSe:]LIST:RANGe<ri>:BANDwidth:RESolution <RBW>

Defines the resolution bandwidth for a spurious emission measurement range.

**Suffix:**

<ri>                    1..n  
Selects the measurement range.

**Parameters:**

<RBW>                Resolution bandwidth.  
Refer to the specifications document for available resolution bandwidths.  
Default unit: Hz

**Example:**            LIST:RANG2:BAND:RES 3KHZ

**Manual operation:** See "RBW" on page 285

---

### [SENSe:]LIST:RANGe<ri>:BANDwidth:VIDeo <VBW>

Defines the video bandwidth for a spurious emission measurement range.

**Suffix:**

<ri>                    1..n  
Selects the measurement range.

**Parameters:**

<VBW>                Video bandwidth.  
Refer to the specifications document for available video bandwidths.  
Default unit: Hz

**Example:**            LIST:RANG2:BAND:VID 3KHZ

**Manual operation:** See "VBW" on page 285

---

### [SENSe:]LIST:RANGe<ri>:BREak <State>

Controls the sweep for all ranges.

**Suffix:**

<ri>                    irrelevant

**Parameters:**

<State>

**ON | 1**

The FSW stops after measuring one range, and the status bit number 10 in the `STAT:OPER` register is set.

(See [Chapter 12.2.2.4, "STATus:OPERation register"](#), on page 826.)

To continue with the next range, use `INITiate<n>:CONMeas`.

**OFF | 0**

The FSW sweeps all ranges in one go.

\*RST: 0

**Example:** `LIST:RANG2:BRE ON`

**Manual operation:** See ["Stop After Sweep"](#) on page 287

**[SENSe:]LIST:RANGe<ri>:COUNt?**

Queries the number of ranges in the sweep list.

**Suffix:**

<ri> irrelevant

**Return values:**

<Ranges> Number of ranges in the sweep list.

**Example:** `LIST:RANG:COUN?`

**Usage:** Query only

**[SENSe:]LIST:RANGe<ri>:DELete**

Removes a range from the sweep list.

Note that

- you cannot delete the reference range
- a minimum of three ranges is mandatory.

**Suffix:**

<ri> 1..n  
Selects the measurement range.

**Example:** `LIST:RANG2:DEL`

**[SENSe:]LIST:RANGe<ri>:DETector <Detector>**

This command selects the detector for a spurious emission measurement range.

**Suffix:**

<ri> 1..n  
Selects the measurement range.

**Parameters:**

<Detector> **APEak**  
Autopeak

**NEGative**

minimum peak detector

**POSitive**

peak detector

**SAMPLE**

sample detector

**RMS**

RMS detector

**AVERage**

average detector

\*RST: RMS

**Example:** LIST:RANG2:DET AVER**Manual operation:** See "[Detector](#)" on page 285**[SENSe:]LIST:RANGe<ri>[:FREQUENCY]:START <Frequency>**

Defines the start frequency of a spurious emission measurement range.

Make sure to set an appropriate span. If you set a span that is

- smaller than the span the sweep list covers, the FSW will not measure the ranges that are outside the span - results may be invalid.
- greater than the span the sweep list covers, the FSW will adjust the start frequency of the first range and the stop frequency of the last range to the span

For more information see [Chapter 6.7, "Spurious emissions measurement"](#), on page 279 .**Suffix:**

<ri> 1..n  
Selects the measurement range.

**Parameters:**

<Frequency> Numeric value.  
\*RST: -12.75 MHz (range 1), -2.515 MHz (range 2), 2.515 MHz (range 3)  
Default unit: Hz

**Example:** LIST:RANG2:STAR 2MHZ**Manual operation:** See "[Range Start / Range Stop](#)" on page 284**[SENSe:]LIST:RANGe<ri>[:FREQUENCY]:STOP <Frequency>**

Defines the stop frequency of a spurious emission measurement range.

Make sure to set an appropriate span. If you set a span that is

- smaller than the span the sweep list covers, the FSW will not measure the ranges that are outside the span - results may be invalid.

- greater than the span the sweep list covers, the FSW will adjust the start frequency of the first range and the stop frequency of the last range to the span

For more information see [Chapter 6.7, "Spurious emissions measurement"](#), on page 279 .

**Suffix:**

<ri> 1..n  
Selects the measurement range.

**Parameters:**

<Frequency> Numeric value.  
\*RST: -2.52 MHz (range 1), 2.52 MHz (range 2), 250.0 MHz (range 3)  
Default unit: Hz

**Example:** LIST:RANG2:STOP 5MHZ

**Manual operation:** See "[Range Start / Range Stop](#)" on page 284

**[SENSe:]LIST:RANGe<ri>:FILTer:TYPE <FilterType>**

This command selects the filter type for a spurious emission measurement range.

The EMI-specific filter types are available if the EMI (R&S FSW-K54) measurement option is installed, even if EMI measurement is not active. For details see [Chapter 6.13.3.1, "Resolution bandwidth and filter types"](#), on page 335.

**Suffix:**

<ri> 1..30  
Selects the measurement range.

**Parameters:**

<FilterType> **NORMal**  
Gaussian filters  
**CFILter**  
channel filters  
**RRC**  
RRC filters  
**CISPr | PULSe**  
CISPR (6 dB) - requires EMI (R&S FSW-K54) option  
Return value for query is always PULS.  
**MIL**  
MIL Std (6 dB) - requires EMI (R&S FSW-K54) option  
**P5**  
5 Pole filters  
\*RST: NORM  
The available bandwidths of the filters are specified in the specifications document.

**Example:** LIST:RANG2:FILT:TYPE NORM

**Manual operation:** See "[Filter Type](#)" on page 285



**[SENSe:]LIST:RANGe<ri>:INPut:ATTenuation <Attenuation>**

Defines the input attenuation for a spurious emission measurement range.

**Suffix:**

<ri> 1..n  
Selects the measurement range.

**Parameters:**

<Attenuation> Numeric value.  
Refer to the specifications document for the attenuation range.

\*RST: 10 dB

Default unit: dB

**Example:** LIST:RANG2:INP:ATT 5

**Manual operation:** See "[RF Attenuation](#)" on page 286

**[SENSe:]LIST:RANGe<ri>:INPut:ATTenuation:AUTO <State>**

Turns automatic selection of the input attenuation for a spurious emission measurement range on and off.

**Suffix:**

<ri> 1..n  
Selects the measurement range.

**Parameters:**

<State> ON | OFF | 0 | 1

\*RST: 1

**Example:** LIST:RANG2:INP:ATT:AUTO ON

**Manual operation:** See "[RF Attenuation Mode](#)" on page 286

**[SENSe:]LIST:RANGe<ri>:INPut:GAIN:STATe <State>**

Turns the preamplifier for a spurious emission measurement range on and off.

The gain level is defined by [\[SENSe:\]LIST:RANGe<ri>:INPut:GAIN\[:VALue\]](#) on page 1042.

**Suffix:**

<ri> 1..n  
Selects the measurement range.

**Parameters:**

<State> ON | OFF | 1 | 0

\*RST: 0

**Example:** LIST:RANG2:INP:GAIN:STAT ON

**Manual operation:** See "[Preamp](#)" on page 287

---

**[SENSe:]LIST:RANGe<ri>:INPut:GAIN[:VALue] <Gain>**

This command selects the preamplification level for the range.

The command requires option R&S FSW-B24.

**Suffix:**

<ri>                                    1..n  
Selects the measurement range.

**Parameters:**

<Gain>                                    15 dB | 30 dB  
The availability of preamplification levels depends on the FSW model.  
•FSW8/13: 15dB and 30 dB  
•FSW26 or higher: 30 dB  
All other values are rounded to the nearest of these two.  
\*RST:                    OFF

**Example:**                                LIST:RANG2:INP:GAIN 15

---

**[SENSe:]LIST:RANGe<ri>:INPut:SANalyzer:ATTenuation <Attenuation>**

This command defines the input attenuation for a spurious emission measurement range.

If an external frontend is active (see [External frontend settings](#)), you can configure attenuation settings for the external frontend and the analyzer separately. This setting defines the attenuation for the analyzer.

**Suffix:**

<ri>                                    1..n  
Selects the measurement range.

**Parameters:**

<Attenuation>                            Numeric value.  
Refer to the specifications document for the attenuation range.  
\*RST:                    10 dB  
Default unit: dB

**Example:**                                LIST:RANG2:INP:SAN:ATT:AUTO OFF  
LIST:RANG2:INP:SAN:ATT 5

**Manual operation:**                    See "[SPA: RF Attenuation Mode / SPA: RF Attenuation](#)" on page 286

---

**[SENSe:]LIST:RANGe<ri>:INPut:SANalyzer:ATTenuation:AUTO <State>**

This command turns automatic selection of the input attenuation for a spurious emission measurement range on and off.

If an external frontend is active (see [External frontend settings](#)), you can configure attenuation settings for the external frontend and the analyzer separately. This setting defines the attenuation for the analyzer.

**Suffix:**

<ri> 1..n  
Selects the measurement range.

**Parameters:**

<State> ON | OFF | 0 | 1  
**OFF | 0**  
Switches the function off  
**ON | 1**  
Switches the function on  
\*RST: 0

**Example:**

```
LIST:RANG2:INP:SAN:ATT:AUTO OFF
LIST:RANG2:INP:SAN:ATT 5
```

**Manual operation:** See "[SPA: RF Attenuation Mode / SPA: RF Attenuation](#)" on page 286

**[SENSe:]LIST:RANGe<ri>:LIMit:STARt <Level>**

Defines an absolute limit for a spurious emission measurement range.

**Suffix:**

<ri> 1..n  
Selects the measurement range.

**Parameters:**

<Level> Absolute limit at the start frequency of a SEM range.  
Range: -400 to 400  
\*RST: 13  
Default unit: dBm

**Example:**

```
LIST:RANG2:LIM:STAR 200
```

**Manual operation:** See "[Abs Limit Start/ Abs Limit Stop](#)" on page 288

**[SENSe:]LIST:RANGe<ri>:LIMit:STATe <State>**

Turns the limit check for all spurious emission measurement ranges on and off.

**Suffix:**

<ri> irrelevant

**Parameters:**

<State> ON | OFF | 1 | 0  
\*RST: 0

**Example:**

```
LIST:RANG2:LIM:STAT ON
```

**Manual operation:** See "[Limit Check](#)" on page 287

---

**[SENSe:]LIST:RANGe<ri>:LIMit:STOP <Level>**

Defines an absolute limit for a spurious emission measurement range.

**Suffix:**

<ri> 1..n  
Selects the measurement range.

**Parameters:**

<Level> Absolute limit at the stop frequency of a SEM range.  
Range: -400 to 400  
\*RST: 13  
Default unit: dBm

**Example:** LIST:RANG2:LIM:STOP 200

**Manual operation:** See "[Abs Limit Start/ Abs Limit Stop](#)" on page 288

---

**[SENSe:]LIST:RANGe<ri>:POINts[:VALue] <Points>**

Defines the number of sweep points in a spurious emission measurement range.

**Suffix:**

<ri> 1..n  
Selects the measurement range.

**Parameters:**

<Points> For more information on sweep points see [Chapter 7.5.1.8, "How much data is measured: sweep points and sweep count"](#), on page 497.  
\*RST: 1001

**Example:** LIST:RANG2:POIN 1000

**Manual operation:** See "[Sweep Points](#)" on page 287

---

**[SENSe:]LIST:RANGe<ri>:RLEVel <RefLevel>**

Defines the reference level for a spurious emission measurement range.

**Suffix:**

<ri> 1..n  
Selects the measurement range.

**Parameters:**

<RefLevel> Reference level.  
Refer to the specifications document for the reference level range.  
\*RST: 0 dBm  
Default unit: dBm

**Example:** LIST:RANG2:RLEV 1DBM

**Manual operation:** See "[Reference Level](#)" on page 286

---

**[SENSe:]LIST:RANGe<ri>:SWEep:TIME <SweepTime>**

Defines the sweep time for a spurious emission measurement range.

**Suffix:**

<ri> 1..n  
Selects the measurement range.

**Parameters:**

<SweepTime> Sweep time.  
The range depends on the ratios of the span to the RBW and the RBW to the VBW. Refer to the specifications document for more information.

**Example:** LIST:RANG2:SWE:TIME 2MS

**Manual operation:** See "[Sweep Time](#)" on page 285

---

**[SENSe:]LIST:RANGe<ri>:SWEep:TIME:AUTO <State>**

Turns automatic selection of the sweep time for a spurious emission measurement range on and off.

**Suffix:**

<ri> 1..n  
Selects the measurement range.

**Parameters:**

<State> ON | OFF | 0 | 1  
\*RST: 1

**Example:** LIST:RANG2:SWE:TIME:AUTO ON

**Manual operation:** See "[Sweep Time Mode](#)" on page 285

---

**[SENSe:]LIST:RANGe<ri>:TRANsducer <Transducer>**

Selects a transducer factor for a spurious emission measurement range.

Note the following prerequisites for the selected transducer:

- The transducer must cover at least the span of the range.
- The x-axis has to be linear.
- The unit has to be dB.

**Suffix:**

<ri> 1..n  
Selects the measurement range.

**Parameters:**

<Transducer> String containing the transducer file name. Do not include a file extension or the file path.  
The file must be located in the C:\R\_S\INSTR\trd directory.

**Example:** LIST:RANG2:TRAN 'MYTRANS'

**Manual operation:** See ["Transducer"](#) on page 287

### 13.5.8.3 Configuring the list evaluation

The following commands configure the list evaluation.

#### Useful commands for spurious emission measurements described elsewhere

- [MMEMory:STORe<n>:LIST](#) on page 1373

#### Remote commands exclusive to spurious emission measurements

<a href="#">CALCulate&lt;n&gt;:PSEarch:AUTO</a> .....	1046
<a href="#">CALCulate&lt;n&gt;:PEAKsearch:AUTO</a> .....	1046
<a href="#">CALCulate&lt;n&gt;:ESpectrum:PSEarch:DEtails</a> .....	1046
<a href="#">CALCulate&lt;n&gt;:ESpectrum:PEAKsearch:DEtails</a> .....	1046
<a href="#">CALCulate&lt;n&gt;:PSEarch:MARGin</a> .....	1047
<a href="#">CALCulate&lt;n&gt;:PEAKsearch:MARGin</a> .....	1047
<a href="#">CALCulate&lt;n&gt;:PSEarch:PSHow</a> .....	1047
<a href="#">CALCulate&lt;n&gt;:PEAKsearch:PSHow</a> .....	1047
<a href="#">CALCulate&lt;n&gt;:PSEarch:SUBRanges</a> .....	1047
<a href="#">CALCulate&lt;n&gt;:PEAKsearch:SUBRanges</a> .....	1047

---

**CALCulate<n>:PSEarch:AUTO** <State>

**CALCulate<n>:PEAKsearch:AUTO** <State>

Turns the list evaluation

on and off.

**Suffix:**

<n> [Window](#)

**Parameters:**

<State> ON | OFF | 0 | 1  
\*RST: 1

**Example:**

CALC:PSE:AUTO OFF  
Deactivates the list evaluation.

**Manual operation:** See ["List Evaluation State"](#) on page 289

---

**CALCulate<n>:ESpectrum:PSEarch:DEtails** <State>

**CALCulate<n>:ESpectrum:PEAKsearch:DEtails** <State>

Configures how detailed the list in the Result Summary is.

**Suffix:**

<n> [Window](#)

**Parameters:**

<State> ON | OFF | 1 | 0

**ON | 1**

Includes all detected peaks (up to a maximum defined by [CALCulate<n>:PEAKsearch:SUBRanges](#) on page 1047).

**OFF | 0**

Includes only one peak per range.

\*RST: 0

**Example:**

CALC:ESP:PSE:DET ON

CALC:PSE:SUBR 10

Includes up to 10 peaks per range in the list.

**Manual operation:** See "[Details](#)" on page 290

**CALCulate<n>:PSEarch:MARGin <Threshold>**

**CALCulate<n>:PEAKsearch:MARGin <Margin>**

Defines the threshold of the list evaluation.

**Suffix:**

<n> [Window](#)

**Parameters:**

<Margin> Range: -200 to 200

Default unit: dB

**Example:**

CALC:PSE:MARG 100

Sets the threshold to 100 dB.

**Manual operation:** See "[Margin](#)" on page 289

**CALCulate<n>:PSEarch:PSHow <State>**

**CALCulate<n>:PEAKsearch:PSHow <State>**

Turns the peak labels in the diagram on and off.

Peak labels are blue squares.

**Suffix:**

<n> [Window](#)

**Parameters:**

<State> ON | OFF | 1 | 0

\*RST: 0

**Example:**

CALC:PSE:PSH ON

Marks all peaks with blue squares.

**Manual operation:** See "[Show Peaks](#)" on page 289

**CALCulate<n>:PSEarch:SUBRanges <NumberPeaks>**

**CALCulate<n>:PEAKsearch:SUBRanges <NumberPeaks>**

Defines the number of peaks included in the peak list.

After this number of peaks has been found, the FSW stops the peak search and continues the search in the next measurement range.

**Suffix:**

<n> [Window](#)

**Parameters:**

<NumberPeaks> Range: 1 to 50  
\*RST: 25

**Example:**

CALC:PSE:SUBR 10  
Sets 10 peaks per range to be stored in the list.

**Manual operation:** See ["Peaks per Range"](#) on page 290

#### 13.5.8.4 Adjusting the X-axis to the range definitions

---

##### [SENSe:]LIST:XADJust

Sets the x-axis range for the spurious emission measurement from the start frequency of the first sweep range to the stop frequency of the last sweep range.

**Example:** SENS:LIST:XADJ

**Usage:** Event

#### 13.5.8.5 Performing a spurious measurement

The following commands are required to perform a Spurious measurement:

SENS:SWE:MODE LIST, see [\[SENSe:\]SWEep:MODE](#) on page 1000

[INITiate<n>\[:IMMediate\]](#) on page 910, see [Chapter 13.5.1, "Performing measurements"](#), on page 908

#### 13.5.8.6 Retrieving and saving settings and results

The following commands analyze and retrieve measurement results for Spurious measurements.

##### Useful commands for spurious emission measurements described elsewhere

- [CALCulate<n>:LIMit<li>:FAIL?](#) on page 1344
- [TRACe<n>\[:DATA\]](#) on page 1258
- [TRACe<n>\[:DATA\]:MEMory?](#) on page 1260
- [TRACe<n>\[:DATA\]:X?](#) on page 1261

#### 13.5.8.7 Programming example: spurious emissions measurement

In the following example, the Spurious Emissions measurement is configured by defining ranges and parameters to create the following sweep list.



Spurious Emissions			
	Range 1	Range 2	Range 3
Range Start	10 MHz	100 MHz	100.0000...
Range Stop	100 MHz	100.0000...	1 GHz
Filter Type	RRC	Normal(3...	Normal(3...
Res BW	24.3 kHz	10 kHz	100 kHz
Video BW	5 MHz	30 kHz	300 kHz
Sweep Time Mode	Manual	Auto	Auto
Sweep Time	1 s	4.01 ms	32.1 ms
Detector	Sample	RMS	RMS
Ref. Level	-20 dBm	0 dBm	0 dBm
RF Att. Mode	Manual	Auto	Auto
RF Attenuator	10 dB	10 dB	10 dB
Preamp	On	Off	Off
Sweep Points	601	4001	32001
Stop After Sweep	Off	Off	Off
Transducer	None	None	None
Limit Check	Absolute	Absolute	Absolute
Abs Limit Start	10 dBm	-13 dBm	-13 dBm
Abs Limit Stop	10 dBm	-13 dBm	-13 dBm

Note that this example is primarily meant to demonstrate the remote control commands, it does not necessarily reflect a useful measurement task.

```
//-----Preparing the measurement-----
*RST
//Resets the instrument

SWE:MODE LIST
//Activates spurious emissions measurement

INIT:CONT OFF
//Selects single sweep mode.

//Spurious measurement has to be in single sweep mode to be configured
//and no sweep operation may be running!

// If required, a sweep stop can be ensured by INIT:IMM;*WAI

//-----Configuring a Sweep List-----

LIST:RANG:COUNT?
//Returns the number of measurement ranges in the sweep list.
LIST:RANG4:DEL
```

## Configuring and performing measurements

```

//Deletes the fourth range.
LIST:RANG1:STAR 10000000
//Defines a start frequency of 10 MHz for range 1.
LIST:RANG1:STOP 100000000
//Defines a stop frequency of 100 MHz for range 1.
LIST:RANG1:BAND 500000
//Defines a resolution bandwidth of 500 kHz in range 1.
LIST:RANG1:BAND:VID 5000000
//Defines a video bandwidth of 5 MHz for range 1.
LIST:RANG1:INP:ATT:AUTO OFF
//Turns automatic selection of the input attenuation in range 1 off.

LIST:RANG1:INP:ATT 10
//Defines a input attenuation of 10 dBm for range 1.

LIST:RANG1:FILT:TYPE CFILter
//Selects an Channel filter for range 1.
LIST:RANG1:DET SAMP
//Selects a sample detector for range 1.
LIST:RANG1:POIN 601
//Defines 601 sweep points for range 1.
LIST:RANG1:RLEV -20
//Defines a reference level of -20 dBm for range 1.
LIST:RANG1:SWE:TIME 5
//Defines a manual sweep time of 5 second for range 1.

// Create a transducer that can be used.
// It has to cover the corresponding frequency range
//
SENSE1:CORRection:TRANsdUCer:SElect 'Test'
SENSE1:CORRection:TRANsdUCer:UNIT 'DB'
SENSE1:CORRection:TRANsdUCer:COMment 'Test Transducer'
// Frequency Span 0 MHz to 20 Ghz
SENSE1:CORRection:TRANsdUCer:DATA 0e6,5, 20e9,3

SENS:LIST:RANG1:TRAN 'Test'
//Includes a transducer called 'Test' for range 1.

LIST:RANG1:LIM:STAR 10
LIST:RANG1:LIM:STOP 10
//Defines an absolute limit of 10 dBm at the start and stop frequencies of range 1.
LIST:RANG:LIM:STAT ON
//Turns the limit check for all ranges on.

//-----Configuring the List Evaluation-----
CALC:PSE:MARG 100
//Sets the threshold to 100 dB.
CALC:PSE:PSH ON
//Marks all peaks in the diagram with blue squares.

```

```

CALC:PSE:SUBR 10
//Sets 10 peaks per range to be stored in the list.

//-----Performing the Measurement-----

INIT:SPUR; *WAI
//Performs a spurious emission measurement and waits until the sweep has finished.

//-----Retrieving Results-----
CALC:LIM1:FAIL?
//Queries the result of the check for limit line 1.
TRAC? SPUR
//Queries the peak list of the spurious emission measurement.

```

### 13.5.9 Analyzing statistics (APD, CCDF)

All remote control commands specific to statistical measurements are described here.

- [Activating statistical measurements](#)..... 1051
- [Configuring statistical measurements](#)..... 1052
- [Using gate ranges for statistical measurements](#)..... 1053
- [Scaling the diagram](#)..... 1056
- [Performing a statistical measurement](#)..... 1058
- [Retrieving results](#)..... 1058
- [Programming example: measuring statistics](#)..... 1060

#### 13.5.9.1 Activating statistical measurements

The following commands activate statistical measurements.

```

CALCulate<n>:STATistics:APD[:STATe]..... 1051
CALCulate<n>:STATistics:CCDF[:STATe]..... 1051

```

---

#### **CALCulate<n>:STATistics:APD[:STATe] <State>**

Turns the APD measurement on and off.

**Suffix:**

<n> [Window](#)

**Parameters:**

<State> ON | OFF | 1 | 0  
 \*RST: 0

**Example:**

CALC:STAT:APD ON  
 Switches on the APD measurement.

---

#### **CALCulate<n>:STATistics:CCDF[:STATe] <State>**

Turns the "CCDF" on and off.

**Suffix:**  
 <n> irrelevant

**Parameters:**  
 <State> ON | OFF | 1 | 0  
 \*RST: 0

**Example:** CALC:STAT:CCDF ON  
 Switches on the "CCDF" measurement.

### 13.5.9.2 Configuring statistical measurements

The following commands configure the measurement.

Useful commands for configuring statistical measurements described elsewhere:

- [SENSe:]BANDwidth[:RESolution] on page 1198
- DISPLAY[:WINDow<n>][:SUBWindow<w>]:TRACe<t>:Y[:SCALE]:RLEVel on page 1207  
 (Make sure the specified reference level is higher than the measured peak value, see CALCulate<n>:MARKer<m>:Y? on page 1288).

#### Remote commands exclusive to statistical measurements:

CALCulate<n>:MARKer<m>:Y:PERCent.....	1052
CALCulate<n>:STATistics:NSAMples.....	1053
DISPLAY[:WINDow<n>]:STATistics:CCDF:GAUSS.....	1053

---

#### CALCulate<n>:MARKer<m>:Y:PERCent <Probability>

Sets a marker to a particular probability value. You can query the corresponding level with CALCulate<n>:MARKer<m>:X.

Using the command turns delta markers into normal markers.

Is available for CCDF measurements.

**Suffix:**  
 <n> Window  
 <m> Marker

**Parameters:**  
 <Probability> Range: 0 % to 100 %  
 Default unit: %

**Example:** CALC1:MARK:Y:PERC 95PCT  
 Positions marker 1 to a probability of 95 %.

**Manual operation:** See "Percent Marker (CCDF only)" on page 298

**CALCulate<n>:STATistics:NSAMples <Samples>**

Defines the number of samples included in the analysis of statistical measurement functions.

**Suffix:**

<n> [Window](#)

**Parameters:**

<Samples> Range: Min: 100, Max: depends on the RBW filter  
\*RST: 100000

**Example:**

CALC:STAT:NSAM 500

Sets the number of measurement points to be acquired to 500.

**Manual operation:** See "[Number of Samples](#)" on page 299

**DISPlay[:WINDow<n>]:STATistics:CCDF:GAUSs <State>**

Enables or disables the red trace in the CCDF display indicating the normal distribution.

**Suffix:**

<n> 1..n  
[Window](#)

**Parameters:**

<State> ON | OFF | 0 | 1  
**OFF | 0**  
Switches the function off  
**ON | 1**  
Switches the function on  
\*RST: 1

**Example:**

DISP:WIND:STAT:CCDF:GAUS OFF

**Manual operation:** See "[Normal Distribution](#)" on page 299

**13.5.9.3 Using gate ranges for statistical measurements**

The following commands control gated statistical measurements.

<a href="#">[SENSe:]SWEep:EGATe:TRACe&lt;t&gt;:COMMeNt</a> .....	1053
<a href="#">[SENSe:]SWEep:EGATe:TRACe&lt;t&gt;:PERiod</a> .....	1054
<a href="#">[SENSe:]SWEep:EGATe:TRACe&lt;t&gt;:STARt&lt;gr&gt;</a> .....	1054
<a href="#">[SENSe:]SWEep:EGATe:TRACe&lt;t&gt;[:STATe&lt;gr&gt;]</a> .....	1055
<a href="#">[SENSe:]SWEep:EGATe:TRACe&lt;t&gt;:STOP&lt;gr&gt;</a> .....	1055

**[SENSe:]SWEep:EGATe:TRACe<t>:COMMeNt <Comment>**

Defines a comment for the gate of a particular trace.

**Suffix:**

&lt;t&gt; Trace

**Parameters:**

&lt;Comment&gt; String containing the comment.

**Example:**

```
SWE:EGAT:TRAC1:COMM 'MyComment'
```

Defines a comment for the gate in trace 1.

**Manual operation:** See "[Comment](#)" on page 300**[SENSe:]SWEep:EGATe:TRACe<t>:PERiod <Length>**

Defines the length of the gate for all traces.

The gate length applies to all traces.

**Suffix:**

&lt;t&gt; irrelevant

**Parameters:**

<Length> Range: 100 ns to 1000 s  
 \*RST: 2 ms  
 Default unit: s

**Example:**

```
SWE:EGAT:TRAC:PER 5ms
```

Defines the period for gated triggering to 5 ms.

**Manual operation:** See "[Period](#)" on page 300**[SENSe:]SWEep:EGATe:TRACe<t>:START<gr> <Time>**

Defines the start time for a gate range.

**Suffix:**

&lt;t&gt; Trace

<gr> 1..n  
 gate range

**Parameters:**

<Time> The value range depends on the gate period you have set for the selected trace with `[SENSe:]SWEep:EGATe:TRACe<t>:PERiod`. The following rules apply:

- the start time may not be higher than the length of the gate
- the start time may not be lower than the stop time of the gate range of a lower order

The reset values depend on the gate range.

- for gate range 1, the start time is 0 ms
- for gate range 3, the start time is 2 ms
- for gate range 5, the start time is 4 ms

Default unit: s

**Example:** `SWE:EGAT:TRAC1:STAR1 3ms`  
Sets the Starting point for range 1 on trace 1 at 3 ms.

**Manual operation:** See "[Range <x> Start/Stop](#)" on page 301

**[SENSe:]SWEep:EGATe:TRACe<t>[:STATe<gr>] <State>**

Includes or excludes a gate range for a particular trace.

**Suffix:**

<t> [Trace](#)  
<gr> gate range

**Parameters:**

<State> ON | OFF | 0 | 1  
**OFF | 0**  
Switches the function off  
**ON | 1**  
Switches the function on

**Example:** `SWE:EGAT:TRAC1:STAT1 ON`  
Activates gate range 1 for trace 1.

**Manual operation:** See "[Range <x> Use](#)" on page 301

**[SENSe:]SWEep:EGATe:TRACe<t>:STOP<gr> <Time>**

Defines the stop time for a gate range.

**Suffix:**

<t> [Trace](#)  
<gr> 1..n  
gate range

**Parameters:**

<Time> The value range depends on the gate period you have set for the selected trace with [\[SENSe:\]SWEep:EGATe:TRACe<t>:PERiod](#). The following rules apply:

- the stop time may not be higher than the length of the gate
- the stop time may not be lower than the start time

The reset values depend on the gate range.

- for gate range 1, the stop time is 1 ms
- for gate range 3, the stop time is 3 ms
- for gate range 5, the stop time is 5 ms

Default unit: s

**Example:** `SWE:EGAT:TRAC1:STOP1 5ms`  
Sets the stopping point for range 1 on trace 1 at 5 ms.

**Manual operation:** See "[Range <x> Start/Stop](#)" on page 301

### 13.5.9.4 Scaling the diagram

The following commands set up the diagram for statistical measurements.

<a href="#">CALCulate&lt;n&gt;:STATistics:PRESet</a> .....	1056
<a href="#">CALCulate&lt;n&gt;:STATistics:SCALE:AUTO ONCE</a> .....	1056
<a href="#">CALCulate&lt;n&gt;:STATistics:SCALE:X:RANGe</a> .....	1057
<a href="#">CALCulate&lt;n&gt;:STATistics:SCALE:X:RLEVel</a> .....	1057
<a href="#">CALCulate&lt;n&gt;:STATistics:SCALE:Y:LOWer</a> .....	1057
<a href="#">CALCulate&lt;n&gt;:STATistics:SCALE:Y:UNIT</a> .....	1058
<a href="#">CALCulate&lt;n&gt;:STATistics:SCALE:Y:UPPer</a> .....	1058

---

#### **CALCulate<n>:STATistics:PRESet**

Resets the scale of the diagram (x- and y-axis).

- Reference level (x-axis)  
0.0 dBm
- Display range (x-axis) for APD measurements  
100 dB
- Display range (x-axis) for CCDF measurements  
20 dB
- Upper limit of the y-axis  
1.0
- Lower limit of the y-axis  
1E-6

**Suffix:**

<n> [Window](#)

**Example:**

`CALC:STAT:PRES`

Resets the scaling for statistical functions

**Manual operation:** See "[Default Settings](#)" on page 303

---

#### **CALCulate<n>:STATistics:SCALE:AUTO ONCE**

Initiates an automatic scaling of the diagram (x- and y-axis).

To obtain maximum resolution, the level range is set as a function of the measured spacing between peak power and the minimum power for the APD measurement and of the spacing between peak power and mean power for the CCDF measurement. In addition, the probability scale for the number of test points is adapted.

To get valid results, you have to perform a complete sweep with synchronization to the end of the auto range process. This is only possible in single sweep mode.

Note this command is not available when using an external frontend.

**Suffix:**

<n> [Window](#)

**Manual operation:** See "[Adjust Settings](#)" on page 299



**CALCulate<n>:STATistics:SCALE:X:RANGe <Range>**

Defines the display range of the x-axis for statistical measurements.

The effects are identical to `DISPlay[:WINDow<n>][:SUBWindow<w>]:TRACe<t>:Y[:SCALE]`.

**Suffix:**

<n> [Window](#)

**Parameters:**

<Range>            Range:        1 dB to 200 dB  
                      \*RST:        100 dB  
                      Default unit: dB

**Example:**            `CALC:STAT:SCAL:X:RANG 20dB`

**Manual operation:** See "[Range](#)" on page 302

**CALCulate<n>:STATistics:SCALE:X:RLEVel <RefLevel>**

Sets the reference level for statistical measurements. The effects are identical to `DISPlay[:WINDow<n>][:SUBWindow<w>]:TRACe<t>:Y[:SCALE]:RLEVel`.

Note that in case of statistical measurements the reference level applies to the x-axis.

**Suffix:**

<n> [Window](#)

**Parameters:**

<RefLevel>            The unit is variable.  
                      If a reference level offset is included, the range is adjusted by that offset.  
                      Range:        -130 dBm to 30 dBm  
                      \*RST:        0 dBm  
                      Default unit: dBm

**Example:**            `CALC:STAT:SCAL:X:RLEV -60dBm`

**Manual operation:** See "[Ref Level](#)" on page 302

**CALCulate<n>:STATistics:SCALE:Y:LOWer <Magnitude>**

Defines the lower vertical limit of the diagram.

**Suffix:**

<n> [Window](#)

**Parameters:**

<Magnitude>            The number is a statistical value and therefore dimensionless.  
                      Range:        1E-9 to 0.1  
                      \*RST:        1E-6

**Example:**            `CALC:STAT:SCAL:Y:LOW 0.001`

**Manual operation:** See ["Y-Max/ Y-Min"](#) on page 303

---

#### **CALCulate<n>:STATistics:SCALE:Y:UNIT <Unit>**

Selects the unit of the y-axis.

**Suffix:**

<n> [Window](#)

**Parameters:**

<Unit> PCT | ABS  
\*RST: ABS

**Example:** CALC:STAT:SCALE:Y:UNIT PCT  
Sets the percentage scale.

**Manual operation:** See ["Y-Unit"](#) on page 303

---

#### **CALCulate<n>:STATistics:SCALE:Y:UPPer <Magnitude>**

Defines the upper vertical limit of the diagram.

**Suffix:**

<n> [Window](#)

**Parameters:**

<Magnitude> The number is a statistical value and therefore dimensionless.  
Range: 1E-5 to 1.0  
\*RST: 1.0

**Example:** CALC:STAT:SCALE:Y:UPP 0.01

**Manual operation:** See ["Y-Max/ Y-Min"](#) on page 303

### **13.5.9.5 Performing a statistical measurement**

The following commands are required to perform a statistical measurement:

[INITiate<n>\[:IMMediate\]](#) on page 910, see [Chapter 13.5.1, "Performing measurements"](#), on page 908

### **13.5.9.6 Retrieving results**

The following commands are required to retrieve the measurement results.

Useful commands for retrieving results described elsewhere:

- [CALCulate<n>:MARKer<m>:X](#) on page 1275

#### **Remote commands exclusive to statistical results**

[CALCulate<n>:STATistics:CCDF:X<t>?](#)..... 1059  
[CALCulate<n>:STATistics:RESult<res>?](#)..... 1059

**CALCulate<n>:STATistics:CCDF:X<t>? <Probability>**

Queries the results of the CCDF.

**Suffix:**

<n> [Window](#)

<t> [Trace](#)

**Query parameters:**

<Probability> **P0\_01**  
Level value for 0.01 % probability

**P0\_1**  
Level value for 0.1 % probability

**P1**  
P1: Level value for 1 % probability

**P10**  
Level value for 10 % probability

**Return values:**

<CCDF Result>

**Example:**

`CALC:STAT:CCDF:X1? P10`

Returns the level values that are over 10 % above the mean value.

**Usage:**

Query only

**CALCulate<n>:STATistics:RESult<res>? <ResultType>**

Queries the results of a measurement for a specific trace.

**Suffix:**

<n> [Window](#)

<res> [Trace](#)

**Query parameters:**

<ResultType> **MEAN**  
Average (=RMS) power in dBm measured during the measurement time.

**PEAK**  
Peak power in dBm measured during the measurement time.

**CFACTOR**  
Determined crest factor (= ratio of peak power to average power) in dB.

**ALL**  
Results of all three measurements mentioned before, separated by commas: <mean power>,<peak power>,<crest factor>

**Example:** `CALC:STAT:RES2? ALL`  
 Reads out the three measurement results of trace 2. Example of answer string: 5.56,19.25,13.69 i.e. mean power: 5.56 dBm, peak power 19.25 dBm, crest factor 13.69 dB

**Usage:** Query only

### 13.5.9.7 Programming example: measuring statistics

This example demonstrates how to determine statistical values for a measurement in a remote environment using the gated statistics example described in [Chapter 6.8.4, "APD and CCDF basics - gated triggering"](#), on page 296.

Gate Ranges	
	Trace 1
Comment	GSM - use...
Period	4.615 ms
Range 1 Use	On
Range 1 Start	15 $\mu$ s
Range 1 Stop	557.8 $\mu$ s
Range 2 Use	Off
Range 2 Start	2 ms
Range 2 Stop	3 ms
Range 3 Use	Off
Range 3 Start	4 ms
Range 3 Stop	5 ms

```
//-----Configuring the measurement -----
*RST
//Reset the instrument
TRIG:SOUR EXT
//Defines the use of an external trigger.
TRIG:HOLD 25us
//Defines a trigger offset of 25  $\mu$ s.
CALC:STAT:APD ON
//Activates APD measurement.
CALC:STAT:NSAM 1000
//Sets the number of samples to be included in the statistical evaluation to 1000.

//-----Defining Gate ranges -----

SWE:EGAT:TRAC1:COMM 'GSM - useful part'
//Defines a comment for the gate
SWE:EGAT:TRAC1:PER 4.61536ms
//Sets the gate period to 4.61536ms.
SWE:EGAT:TRAC1:STAR1 15us
```

## Configuring and performing measurements

```

//Sets the start of range 1 to 15 µs.
SWE:EGAT:TRAC1:STOP1 557.8us
//Sets the end of range 1 to 15 µs (start time) + 542.77 µs (useful part) = 557.8 µs.
SWE:EGAT:TRAC1:STAT1 ON
//Activates the use of range 1.

//-----Performing the Measurement-----
INIT:CONT OFF
//Selects single sweep mode.
INIT;*WAI
//Initiates a new measurement and waits until the sweep has finished.

//-----Retrieving Results-----
CALC:STAT:RES1? MEAN
//Returns the mean average power for the useful part of the GSM signal.

//----- Determining the CCDF values-----

CALC:STAT:CCDF ON
//Activates CCDF measurement.
CALC:MARK2:Y:PERC 95PCT
//Sets marker 2 to the 95% probability value.
INIT;*WAI
//Initiates a new measurement and waits until the sweep has finished.
CALC:STAT:CCDF:X? P1
//Returns the level value for 10% probability for the CCDF.
CALC:MARK2:X?
//Returns the level for a probability of 95%.

//----- Scaling the diagram -----
CALC:STAT:SCAL:X:RLEV -70dBm
//Sets the reference level to -70 dBm (x-axis!)
CALC:STAT:SCAL:X:RANG 20dB
//Defines a power level range of 20 dB for the x-axis
CALC:STAT:SCAL:Y:LOW 0.0001
//Sets the minimum of the y-axis to 0.01% probability
CALC:STAT:SCAL:Y:UPP 1.0
//Sets the maximum of the y-axis to 100% probability
CALC:STAT:SCAL:Y:UNIT PCT
//Displays percentage values on y-axis scale

```

### 13.5.10 Measuring the time domain power

All remote control commands specific to time domain power measurements are described here.

- [Configuring the measurement](#)..... 1062
- [Performing a time domain power measurement](#)..... 1065
- [Retrieving measurement results](#)..... 1065
- [Programming example: time domain power](#)..... 1070

### 13.5.10.1 Configuring the measurement

The following remote commands measure the time domain power.

#### Useful commands for time domain power measurements described elsewhere

- `CALCulate<n>:MARKer<m>:X:SLIMits:LEFT`
- `CALCulate<n>:MARKer<m>:X:SLIMits:RIGHT`
- `CALCulate<n>:MARKer<m>:X:SLIMits[:STATe]`

#### Remote commands exclusive to time domain power measurements

<code>CALCulate&lt;n&gt;:MARKer&lt;m&gt;:FUNCTION:SUMMARY:AOFF</code> .....	1062
<code>CALCulate&lt;n&gt;:MARKer&lt;m&gt;:FUNCTION:SUMMARY:AVERAGE</code> .....	1062
<code>CALCulate&lt;n&gt;:MARKer&lt;m&gt;:FUNCTION:SUMMARY:PHOLD</code> .....	1063
<code>CALCulate&lt;n&gt;:MARKer&lt;m&gt;:FUNCTION:SUMMARY[:STATe]</code> .....	1063
<code>CALCulate&lt;n&gt;:MARKer&lt;m&gt;:FUNCTION:SUMMARY:MEAN[:STATe]</code> .....	1063
<code>CALCulate&lt;n&gt;:MARKer&lt;m&gt;:FUNCTION:SUMMARY:PPEAK[:STATe]</code> .....	1064
<code>CALCulate&lt;n&gt;:MARKer&lt;m&gt;:FUNCTION:SUMMARY:RMS[:STATe]</code> .....	1064
<code>CALCulate&lt;n&gt;:MARKer&lt;m&gt;:FUNCTION:SUMMARY:SDEVIATION[:STATe]</code> .....	1064

---

#### `CALCulate<n>:MARKer<m>:FUNCTION:SUMMARY:AOFF`

Turns all time domain power evaluation modes off.

##### Suffix:

<n>                      [Window](#)

<m>                      [Marker](#)

---

#### `CALCulate<n>:MARKer<m>:FUNCTION:SUMMARY:AVERAGE <State>`

Switches on or off averaging for the active power measurement in zero span in the window specified by the suffix <n>. If activated, a time domain value is calculated from the trace after each sweep; in the end, all values are averaged to calculate the final result.

The number of results required for the calculation of average is defined with [\[SENSe:\]AVERAGE<n>:COUNT](#).

Averaging is reset by switching it off and on again.

Synchronization to the end of averaging is only possible in single sweep mode.

##### Suffix:

<n>                      [Window](#)

<m> [Marker](#)

**Parameters:**

<State> ON | OFF | 1 | 0  
\*RST: 0

**Example:**

```
INIT:CONT OFF
Switches to single sweep mode.
CALC:MARK:FUNC:SUMM:AVER ON
Switches on the calculation of average.
AVER:COUN 200
Sets the measurement counter to 200.
INIT;*WAI
Starts a sweep and waits for the end.
```

**CALCulate<n>:MARKer<m>:FUNCTion:SUMMary:PHOLd <State>**

Switches on or off the peak-hold function for the active power measurement in zero span in the window specified by the suffix <n>. If activated, the peak for each sweep is compared to the previously stored peak; the maximum of the two is stored as the current peak.

The peak-hold function is reset by switching it off and on again.

**Suffix:**

<n> [Window](#)

<m> [Marker](#)

**Parameters:**

<State> ON | OFF | 1 | 0  
\*RST: 0

**CALCulate<n>:MARKer<m>:FUNCTion:SUMMary[:STATe] <State>**

Turns time domain power measurements on and off. This measurement is only available in zero span.

When you turn the measurement on, the FSW activates a marker and positions it on the peak power level in the marker search range.

**Suffix:**

<n> [Window](#)

<m> [Marker](#)

**Parameters:**

<State> ON | OFF | 1 | 0  
\*RST: 0

**CALCulate<n>:MARKer<m>:FUNCTion:SUMMary:MEAN[:STATe] <State>**

Turns the evaluation to determine the mean time domain power on and off.

The FSW performs the measurement on the trace marker 1 is positioned on.

**Suffix:**

<n> [Window](#)

<m> [Marker](#)

**Parameters:**

<State> ON | OFF | 1 | 0

\*RST: 0

**Manual operation:** See ["Results"](#) on page 311

**CALCulate<n>:MARKer<m>:FUNction:SUMMary:PPEak[:STATe] <State>**

Turns the evaluation to determine the positive peak time domain power on and off.

The FSW performs the measurement on the trace marker 1 is positioned on.

**Suffix:**

<n> [Window](#)

<m> [Marker](#)

**Parameters:**

<State> ON | OFF | 1 | 0

\*RST: 0

**Manual operation:** See ["Results"](#) on page 311

**CALCulate<n>:MARKer<m>:FUNction:SUMMary:RMS[:STATe] <State>**

Turns the evaluation to determine the RMS time domain power on and off.

The FSW performs the measurement on the trace marker 1 is positioned on.

**Suffix:**

<n> [Window](#)

<m> [Marker](#)

**Parameters:**

<State> ON | OFF | 1 | 0

\*RST: 0

**Manual operation:** See ["Results"](#) on page 311

**CALCulate<n>:MARKer<m>:FUNction:SUMMary:SDEVIation[:STATe] <State>**

Turns the evaluation to determine the standard deviation of the time domain power on and off.

The FSW performs the measurement on the trace marker 1 is positioned on.

**Suffix:**

<n> [Window](#)



<m>                    [Marker](#)

**Parameters:**

<State>                ON | OFF | 1 | 0

                         \*RST:        0

### 13.5.10.2 Performing a time domain power measurement

The following commands are required to perform a Time Domain Power measurement:

[INITiate<n>\[:IMMEDIATE\]](#) on page 910

See [Chapter 13.5.1, "Performing measurements"](#), on page 908

### 13.5.10.3 Retrieving measurement results

The following commands query the results for time domain measurements.

#### Measuring the mean power

[CALCulate<n>:MARKer<m>:FUNCTION:SUMMARY:MEAN:AVERAGE:RESULT?](#)..... 1065

[CALCulate<n>:MARKer<m>:FUNCTION:SUMMARY:MEAN:PHOLD:RESULT?](#)..... 1065

[CALCulate<n>:MARKer<m>:FUNCTION:SUMMARY:MEAN:RESULT?](#)..... 1066

---

#### **CALCulate<n>:MARKer<m>:FUNCTION:SUMMARY:MEAN:AVERAGE:RESULT?**

Queries the average mean time domain power. The query is only possible if averaging has been activated previously using [CALCulate<n>:MARKer<m>:FUNCTION:SUMMARY:AVERAGE](#) on page 1062.

To get a valid result, you have to perform a complete measurement with synchronization to the end of the measurement before reading out the result. This is only possible for single sweep mode.

See also [INITiate<n>:CONTinuous](#) on page 909.

#### **Suffix:**

<n>                    [Window](#)

<m>                    [Marker](#)

#### **Return values:**

<MeanPower>        Mean power of the signal during the measurement time.

**Usage:**                Query only

---

#### **CALCulate<n>:MARKer<m>:FUNCTION:SUMMARY:MEAN:PHOLD:RESULT?**

Queries the maximum mean time domain power. The query is only possible if the peak hold function has been activated previously using [CALCulate<n>:MARKer<m>:FUNCTION:SUMMARY:PHOLD](#).

To get a valid result, you have to perform a complete measurement with synchronization to the end of the measurement before reading out the result. This is only possible for single sweep mode.

See also [INITiate<n>:CONTInuous](#) on page 909.

**Suffix:**

<n> [Window](#)

<m> [Marker](#)

**Return values:**

<MeanPower> Mean power of the signal during the measurement time.

**Usage:** Query only

**CALCulate<n>:MARKer<m>:FUNction:SUMMary:MEAN:RESult?**

Queries the mean time domain power.

To get a valid result, you have to perform a complete measurement with synchronization to the end of the measurement before reading out the result. This is only possible for single sweep mode.

See also [INITiate<n>:CONTInuous](#) on page 909.

**Suffix:**

<n> [Window](#)

<m> [Marker](#)

**Return values:**

<MeanPower> Mean power of the signal during the measurement time.

**Usage:** Query only

**Manual operation:** See ["Results"](#) on page 311

**Measuring the peak power**

**CALCulate<n>:MARKer<m>:FUNction:SUMMary:PPEak:AVERage:RESult?**

Queries the average positive peak time domain power. The query is only possible if averaging has been activated previously using [CALCulate<n>:MARKer<m>:FUNction:SUMMary:AVERage](#) on page 1062.

To get a valid result, you have to perform a complete measurement with synchronization to the end of the measurement before reading out the result. This is only possible for single sweep mode.

See also [INITiate<n>:CONTInuous](#) on page 909.

**Suffix:**

<n> [Window](#)

<m> [Marker](#)

**Return values:**

<PeakPower> Peak power of the signal during the measurement time.

**Usage:** Query only

**CALCulate<n>:MARKer<m>:FUNCTION:SUMMARY:PPEak:PHOLD:RESult?**

Queries the maximum positive peak time domain power. The query is only possible if the peak hold function has been activated previously using [CALCulate<n>:MARKer<m>:FUNCTION:SUMMARY:PHOLD](#).

[MARKer<m>:FUNCTION:SUMMARY:PHOLD](#).

To get a valid result, you have to perform a complete measurement with synchronization to the end of the measurement before reading out the result. This is only possible for single sweep mode.

See also [INITiate<n>:CONTinuous](#) on page 909.

**Suffix:**

<n> [Window](#)

<m> [Marker](#)

**Return values:**

<PeakPower> Peak power of the signal during the measurement time.

**Usage:** Query only

**CALCulate<n>:MARKer<m>:FUNCTION:SUMMARY:PPEak:RESult?**

Queries the positive peak time domain power.

To get a valid result, you have to perform a complete measurement with synchronization to the end of the measurement before reading out the result. This is only possible for single sweep mode.

See also [INITiate<n>:CONTinuous](#) on page 909.

**Suffix:**

<n> [Window](#)

<m> [Marker](#)

**Return values:**

<PeakPower> Peak power of the signal during the measurement time.

**Usage:** Query only

**Manual operation:** See "[Results](#)" on page 311

**Measuring the RMS power****CALCulate<n>:MARKer<m>:FUNCTION:SUMMARY:RMS:AVERAge:RESult?**

Queries the average RMS of the time domain power. The query is only possible if averaging has been activated previously using [CALCulate<n>:MARKer<m>:FUNCTION:SUMMARY:AVERAge](#) on page 1062.

To get a valid result, you have to perform a complete measurement with synchronization to the end of the measurement before reading out the result. This is only possible for single sweep mode.

See also [INITiate<n>:CONTInuous](#) on page 909.

**Suffix:**

<n> [Window](#)

<m> [Marker](#)

**Return values:**

<RMSPower> RMS power of the signal during the measurement time.

**Usage:** Query only

**CALCulate<n>:MARKer<m>:FUNction:SUMMary:RMS:PHOLd:RESult?**

Queries the maximum RMS of the time domain power. The query is only possible if the peak hold function has been activated previously using [CALCulate<n>:MARKer<m>:FUNction:SUMMary:PHOLd](#).

To get a valid result, you have to perform a complete measurement with synchronization to the end of the measurement before reading out the result. This is only possible for single sweep mode.

See also [INITiate<n>:CONTInuous](#) on page 909.

**Suffix:**

<n> [Window](#)

<m> [Marker](#)

**Return values:**

<RMSPower> RMS power of the signal during the measurement time.

**Usage:** Query only

**CALCulate<n>:MARKer<m>:FUNction:SUMMary:RMS:RESult?**

Queries the RMS of the time domain power.

To get a valid result, you have to perform a complete measurement with synchronization to the end of the measurement before reading out the result. This is only possible for single sweep mode.

See also [INITiate<n>:CONTInuous](#) on page 909.

**Suffix:**

<n> [Window](#)

<m> [Marker](#)

**Return values:**

<RMSPower> RMS power of the signal during the measurement time.

**Usage:** Query only

**Manual operation:** See ["Results"](#) on page 311

### Measuring the standard deviation

---

#### **CALCulate<n>:MARKer<m>:FUNCTion:SUMMary:SDEViation:AVERage:RESult?**

Queries the average standard deviation of the time domain power. The query is only possible if averaging has been activated previously using [CALCulate<n>:MARKer<m>:FUNCTion:SUMMary:AVERage](#) on page 1062.

To get a valid result, you have to perform a complete measurement with synchronization to the end of the measurement before reading out the result. This is only possible for single sweep mode.

See also [INITiate<n>:CONTInuous](#) on page 909.

**Suffix:**

<n> [Window](#)

<m> [Marker](#)

**Return values:**

<StandardDeviation> Standard deviation of the signal during the measurement time.

**Usage:** Query only

---

#### **CALCulate<n>:MARKer<m>:FUNCTion:SUMMary:SDEViation:PHOLd:RESult?**

Queries the maximum standard deviation of the time domain power. The query is only possible if the peak hold function has been activated previously using [CALCulate<n>:MARKer<m>:FUNCTion:SUMMary:PHOLd](#).

To get a valid result, you have to perform a complete measurement with synchronization to the end of the measurement before reading out the result. This is only possible for single sweep mode.

See also [INITiate<n>:CONTInuous](#) on page 909.

**Suffix:**

<n> [Window](#)

<m> [Marker](#)

**Return values:**

<StandardDeviation> Standard deviation of the signal during the measurement time.

**Usage:** Query only

---

#### **CALCulate<n>:MARKer<m>:FUNCTion:SUMMary:SDEViation:RESult?**

Queries the standard deviation of the time domain power.

To get a valid result, you have to perform a complete measurement with synchronization to the end of the measurement before reading out the result. This is only possible for single sweep mode.

See also [INITiate<n>:CONTinuous](#) on page 909.

**Suffix:**

<n> [Window](#)

<m> [Marker](#)

**Return values:**

<StandardDeviation> Standard deviation of the signal during the measurement time.

**Usage:** Query only

#### 13.5.10.4 Programming example: time domain power

This programming example demonstrates the measurement example described in [Chapter 6.9.6, "Measurement example"](#), on page 312 in a remote environment.

```
//-----Configuring the Measurement-----
*RST
//Resets the instrument

INIT:CONT OFF
//Turns on single sweep mode.

FREQ:CENT 1.8GHz
//Sets the center frequency to 1.8 GHz.

BAND:RES 100kHz
//Sets the bandwidth to 100 kHz.

SWE:TIME 10ms
//Sets the sweep time to 640 µs.

FREQ:SPAN 0
//Sets the instrument to zero span.

CALC:MARK:FUNC:SUMM:STAT ON
//Turns on time domain power measurements.

CALC:MARK:FUNC:SUMM:MEAN ON
CALC:MARK:FUNC:SUMM:PPE ON
CALC:MARK:FUNC:SUMM:RMS ON
//Turns the evaluation of the mean, peak and RMS time domain power.

CALC:MARK:X:SLIM ON
//Activates limit lines for evaluation.

CALC:MARK:X:SLIM:LEFT 1ms
//Sets the left limit line to 326 µs.

CALC:MARK:X:SLIM:RIGH 6ms
```

```
//Sets the right limit line to 538 μs.

//-----Performing the Measurement-----

INIT;*WAI
//Initiates the measurement and waits until the measurement is finished.

//-----Retrieving the Results-----
CALC:MARK:FUNC:SUMM:MEAN:RES?
CALC:MARK:FUNC:SUMM:PPE:RES?
CALC:MARK:FUNC:SUMM:RMS:RES?
//Queries the mean, peak and RMS time domain power.
```

### 13.5.11 Measuring the harmonic distortion

All remote control commands specific to harmonic distortion measurements are described here.

- [Activating the measurement](#).....1071
- [Configuring the measurement](#).....1072
- [Performing the measurement](#).....1073
- [Retrieving results](#).....1073
- [Example: measuring the harmonic distortion](#).....1074

#### 13.5.11.1 Activating the measurement

The following command activates harmonic distortion measurement.

[CALCulate<n>:MARKer<m>:FUNCTION:HARMonics\[:STATe\]](#)..... 1071

---

**CALCulate<n>:MARKer<m>:FUNCTION:HARMonics[:STATe] <State>**

Turns the harmonic distortion measurement on and off.

Note the following:

- If you perform the measurement in the frequency domain, the search range for the frequency of the first harmonic, whose power is determined, is defined by the last span.
- If you perform the measurement in the time domain, the current center frequency is used as the frequency of the first harmonic. Thus, the frequency search is bypassed. The first harmonic frequency is set by a specific center frequency in zero span before the harmonic measurement is started.

**Suffix:**

<n>                      [Window](#)

<m>                      [Marker](#)

**Parameters:**

<State> ON | OFF | 1 | 0  
 \*RST: 0

**Example:**

CALC:MARK:FUNC:HARM ON  
 Activates the harmonic distortion measurement.

**13.5.11.2 Configuring the measurement**

The following commands control the harmonic distortion measurement.

**Useful commands for harmonic distortion measurements described elsewhere**

- [CALCulate<n>:MARKer<m>:FUNction:CENTer](#) on page 1190
- [\[SENSe:\]SWEep:TIME:AUTO](#) on page 1205

**Remote commands exclusive to harmonic distortion measurements**

<a href="#">CALCulate&lt;n&gt;:MARKer&lt;m&gt;:FUNction:HARMonics:BANDwidth:AUTO</a> .....	1072
<a href="#">CALCulate&lt;n&gt;:MARKer&lt;m&gt;:FUNction:HARMonics:NHARmonics</a> .....	1072
<a href="#">CALCulate&lt;n&gt;:MARKer&lt;m&gt;:FUNction:HARMonics:PRESet</a> .....	1073

**CALCulate<n>:MARKer<m>:FUNction:HARMonics:BANDwidth:AUTO <State>**

Selects the resolution bandwidth of the harmonic in respect to the bandwidth of the first harmonic.

**Suffix:**

<n> [Window](#)

<m> [Marker](#)

**Parameters:**

<State> ON | OFF | 0 | 1  
**OFF | 0**  
 identical  
**ON | 1**  
 a multiple  
 \*RST: 1

**Manual operation:** See "[Harmonic RBW Auto](#)" on page 318

**CALCulate<n>:MARKer<m>:FUNction:HARMonics:NHARmonics <NoHarmonics>**

Selects the number of harmonics that the FSW looks for.

**Suffix:**

<n> [Window](#)

<m> [Marker](#)



**Parameters:**

<NoHarmonics>      Range:      1 to 26  
                          \*RST:        10

**Manual operation:**    See "[Number of Harmonics](#)" on page 318

**CALCulate<n>:MARKer<m>:FUNctio:n:HARMonics:PRESet**

Initiates a measurement to determine the ideal configuration for the harmonic distortion measurement.

The method depends on the span.

- Frequency domain (span > 0)  
     Frequency and level of the first harmonic are determined and used for the measurement list.
- Time domain (span = 0)  
     The level of the first harmonic is determined. The frequency remains unchanged.

**Suffix:**

<n>                      [Window](#)

<m>                      [Marker](#)

**Manual operation:**    See "[Adjust Settings](#)" on page 318

**13.5.11.3 Performing the measurement**

The following commands are required to perform a harmonic distortion measurement:

[INITiate<n>\[:IMMediate\]](#) on page 910, see [Chapter 13.5.1, "Performing measurements"](#), on page 908

**13.5.11.4 Retrieving results**

The following commands retrieve the results of the harmonic distortion measurement.

[CALCulate<n>:MARKer<m>:FUNctio:n:HARMonics:DISToRTion?](#)..... 1073  
[CALCulate<n>:MARKer<m>:FUNctio:n:HARMonics:LIST](#).....1074

**CALCulate<n>:MARKer<m>:FUNctio:n:HARMonics:DISToRTion?**

Queries the total harmonic distortion of the signal.

To get a valid result, you have to perform a complete measurement with synchronization to the end of the measurement before reading out the result. This is only possible for single sweep mode.

See also [INITiate<n>:CONTinuous](#) on page 909.

**Suffix:**

<n>                      [Window](#)

<m>                      [Marker](#)

**Query parameters:**

&lt;Result&gt;           TOTal

**Return values:**

&lt;DistortionPct&gt;

&lt;DistortionDb&gt;

**Usage:**            Query only**CALCulate<n>:MARKer<m>:FUNCtion:HARMonics:LIST**

Queries the position of the harmonics.

To get a valid result, you have to perform a complete measurement with synchronization to the end of the measurement before reading out the result. This is only possible for single sweep mode.

See also [INITiate<n>:CONTinuous](#) on page 909.

**Suffix:**<n>                    [Window](#)<m>                    [Marker](#)**Return values:**

<Harmonics>           Returns one value for every harmonic.  
 The first value is the absolute power of the first harmonic. The unit is variable.  
 The other values are power levels relative to the first harmonic. The unit for these is dB.

**13.5.11.5 Example: measuring the harmonic distortion**

```
//-----Configuring the Measurement-----
*RST
//Resets the instrument.

INIT:CONT OFF
//Turns on single sweep mode.

CALC:MARK:FUNC:HARM ON
//Turns on the harmonic distortion measurement.
CALC:MARK:FUNC:HARM:NHAR 3
//Defines three harmonics to be found.

CALC:MARK:FUNC:HARM:BAND:AUTO OFF
//Turns off automatic bandwidth selection.
CALC:MARK:FUNC:HARM:PRES
//Determines the ideal configuration.

//-----Performing the Measurement-----
```

```

INIT;*WAI
//Initiates the measurement and finishes the sweep.

//-----Retrieving the Results-----
CALC:MARK:FUNC:HARM:LIST?
//Queries the position of the harmonics.
CALC:MARK:FUNC:HARM:DIST? TOT
//Queries the total harmonic distortion.

```

## 13.5.12 Measuring the third order intercept point

- [Determining the TOI](#)..... 1075
- [Programming example: measuring the TOI](#)..... 1078

### 13.5.12.1 Determining the TOI

All remote control commands specific to TOI measurements are described here.

#### Useful commands for TOI measurements described elsewhere

- [CALCulate<n>:DELTaMarker<m>:X](#) on page 1272
- [CALCulate<n>:DELTaMarker<m>:X:RELative?](#) on page 1288
- [CALCulate<n>:DELTaMarker<m>:Y?](#) on page 1288
- [CALCulate<n>:MARKer<m>:X](#) on page 1275
- [CALCulate<n>:MARKer<m>:Y?](#) on page 1288

#### Remote commands exclusive to TOI measurements

<a href="#">CALCulate&lt;n&gt;:MARKer&lt;m&gt;:FUNCTION:TOI[:STATe]</a> .....	1075
<a href="#">CALCulate&lt;n&gt;:MARKer&lt;m&gt;:FUNCTION:TOI:SEARChsignal ONCE</a> .....	1076
<a href="#">CALCulate&lt;n&gt;:MARKer&lt;m&gt;:FUNCTION:TOI:RESult?</a> .....	1076
<a href="#">CALCulate&lt;n&gt;:MARKer&lt;m&gt;:FUNCTION:TOI:RESult:MAXimum?</a> .....	1076
<a href="#">CALCulate&lt;n&gt;:MARKer&lt;m&gt;:FUNCTION:TOI:RESult:MINimum?</a> .....	1077

---

#### **CALCulate<n>:MARKer<m>:FUNCTION:TOI[:STATe] <State>**

Initiates a measurement to determine the third intercept point.

A two-tone signal with equal carrier levels is expected at the RF input of the instrument. Marker 1 and marker 2 (both normal markers) are set to the maximum of the two signals. Delta marker 3 and delta marker 4 are positioned to the intermodulation products. The delta markers can be modified separately afterwards with the [CALCulate<n>:DELTaMarker<m>:X](#) command.

The third-order intercept is calculated from the level spacing between the normal markers and the delta markers.

#### **Suffix:**

<n> [Window](#)

<m> [Marker](#)

**Parameters:**

<State> ON | OFF | 1 | 0  
\*RST: 0

**Example:**

CALC:MARK:FUNC:TOI ON  
Switches on the measurement of the third-order intercept.

**CALCulate<n>:MARKer<m>:FUNCTION:TOI:SEARChsignal ONCE**

This command initiates a search for signals in the current trace to determine the third intercept point.

**Suffix:**

<n> irrelevant

<m> irrelevant

**Manual operation:** See "[Search Signals](#)" on page 326

**CALCulate<n>:MARKer<m>:FUNCTION:TOI:RESult?**

Queries the results for the third order intercept point measurement.

To get a valid result, you have to perform a complete measurement with synchronization to the end of the measurement before reading out the result. This is only possible for single sweep mode.

See also [INITiate<n>:CONTinuous](#) on page 909.

**Suffix:**

<n> [Window](#)

<m> [Marker](#)

**Return values:**

<TOI> Third order intercept point.

**Example:**

INIT:CONT OFF  
Switches to single sweep mode.  
CALC:MARK:FUNC:TOI ON  
Switches the intercept measurement.  
INIT;\*WAI  
Starts a sweep and waits for the end.  
CALC:MARK:FUNC:TOI:RES?  
Outputs the measured value.

**Usage:** Query only

**CALCulate<n>:MARKer<m>:FUNCTION:TOI:RESult:MAXimum?**

Queries the results for the maximum third order intercept point measurement (see [Chapter 6.11.3, "TOI results"](#), on page 324).

To get a valid result, you have to perform a complete measurement with synchronization to the end of the measurement before reading out the result. This is only possible for single sweep mode.

See also [INITiate<n>:CONTinuous](#) on page 909.

**Suffix:**

<n> [Window](#)

<m> [Marker](#)

**Return values:**

<TOI> Maximum third order intercept point.

**Example:**

```
INIT:CONT OFF
```

Switches to single sweep mode.

```
CALC:MARK:FUNC:TOI ON
```

Switches the intercept measurement.

```
INIT;*WAI
```

Starts a sweep and waits for the end.

```
CALC:MARK:FUNC:TOI:RES:MAX?
```

Returns the maximum TOI.

**Usage:** Query only

**CALCulate<n>:MARKer<m>:FUNCTION:TOI:RESult:MINimum?**

Queries the results for the minimum third order intercept point measurement (see [Chapter 6.11.3, "TOI results"](#), on page 324).

To get a valid result, you have to perform a complete measurement with synchronization to the end of the measurement before reading out the result. This is only possible for single sweep mode.

See also [INITiate<n>:CONTinuous](#) on page 909.

**Suffix:**

<n> [Window](#)

<m> [Marker](#)

**Return values:**

<TOI> Minimum third order intercept point.

**Example:**

```
INIT:CONT OFF
```

Switches to single sweep mode.

```
CALC:MARK:FUNC:TOI ON
```

Switches the intercept measurement.

```
INIT;*WAI
```

Starts a sweep and waits for the end.

```
CALC:MARK:FUNC:TOI:RES:MIN?
```

Returns the minimum TOI.

**Usage:** Query only

### 13.5.12.2 Programming example: measuring the TOI

This example demonstrates how to determine the TOI in a remote environment.

```
//-----Configuring the measurement -----
*RST
//Reset the instrument
CALC:MARK:FUNC:TOI ON
//Activate TOI measurement.

//-----Performing the Measurement-----
INIT:CONT OFF
//Selects single sweep mode.

CALC:MARK:FUNC:TOI:SEAR ONCE
//Initiates a search for signals in the current trace.

//-----Retrieving Results-----
CALC:MARK:FUNC:TOI:RES?
//Returns the TOI.
```

### 13.5.13 Measuring the AM modulation depth

All remote control commands specific to AM modulation depth measurements are described here.

- [Configuring and performing the measurement](#)..... 1078
- [Example: measuring the AM modulation depth](#)..... 1079

#### 13.5.13.1 Configuring and performing the measurement

The following commands control the measurement.

##### Useful commands for AM modulation depth described elsewhere

- [CALCulate<n>:DELTamarker<m>:X](#) on page 1272
- [CALCulate<n>:DELTamarker<m>:X:RELative?](#) on page 1288
- [CALCulate<n>:MARKer<m>:X](#) on page 1275

##### Remote commands exclusive to AM modulation depth measurements

[CALCulate<n>:MARKer<m>:FUNCTion:MDEPth\[:STATe\]](#)..... 1078  
[CALCulate<n>:MARKer<m>:FUNCTion:MDEPth:SEARChsignal ONCE](#)..... 1079  
[CALCulate<n>:MARKer<m>:FUNCTion:MDEPth:RESult<t>?](#)..... 1079

---

##### **CALCulate<n>:MARKer<m>:FUNCTion:MDEPth[:STATe]** <State>

Turns the AM Modulation Depth measurement on and off.

To work correctly, the measurement requires an AM modulated signal.

**Suffix:**<n> [Window](#)<m> [Marker](#)**Parameters:**

&lt;State&gt; ON | OFF | 1 | 0

\*RST: 0

**CALCulate<n>:MARKer<m>:FUNctio:n:MDEPth:SEARChsignal ONCE**

This command initiates a search for the signals required for the AM depth measurement.

Note that the command does not perform a new measurement, but looks for the signals on the current trace.

**Suffix:**<n> [Window](#)<m> [Marker](#)**Example:**

CALC:MARK:FUNC:MDEP:SEAR ONCE

Executes the search of an AM modulated signal at the currently available trace.

**Manual operation:** See "[Search Signals](#)" on page 331

**CALCulate<n>:MARKer<m>:FUNctio:n:MDEPth:RESult<t>?**

Queries the results of the AM modulation depth measurement.

To get a valid result, you have to perform a complete measurement with synchronization to the end of the measurement before reading out the result. This is only possible for single sweep mode.

See also [INITiate<n>:CONTinuous](#) on page 909.

**Suffix:**<n> [Window](#)<m> [Marker](#)<t> [Trace](#)**Return values:**

&lt;ModulationDepth&gt; Modulation depth in %.

**Usage:** Query only

**13.5.13.2 Example: measuring the AM modulation depth**

This example demonstrates how to determine the AM modulation depth in a remote environment. Note that without a real input signal this measurement will not return useful results.

## Configuring and performing measurements

```

//-----Configuring the measurement -----
*RST
//Reset the instrument
FREQ:CENT 100MHz
//Set center frequency
FREQ:SPAN 10KHz
// Set span
CALC:MARK:FUNC:MDEP ON
//Activate AM modulation depth measurement.

//-----Performing the Measurement-----
INIT:CONT OFF
//Selects single sweep mode.
INIT:IMM
// Perform a single measurement
CALC:MARK:FUNC:MDEP:SEAR ONCE
//Initiates a search for signals in the current trace.

//-----Retrieving Results-----
CALC:MARK:FUNC:MDEP:RES?
//Queries the measurement results.

//If the results are not accurate, change the position of the
//the temporary markers manually.

//----Changing the position of the temp markers-----
CALC:MARK:X 100MHZ
//Positions the reference marker on 100 MHz.
CALC:DELT2:X 5KHZ
//Positions delta marker 2 and 3 at a distance of 5 kHz to the reference marker.
CALC:DELT3:X 1KHZ
//Corrects the position of delta marker 3 by 1 kHz.

CALC:MARK:FUNC:MDEP:RES?
//Queries the measurement results for the repositioned markers.

```

### 13.5.14 Remote commands for EMI measurements

The following commands are required to perform EMI measurements in a remote environment. This measurement requires the R&S FSW-K54 option.

The following tasks specific to the EMI application are described here:

- [Activating EMI measurement](#)..... 1081
- [Configuring EMI markers](#)..... 1081
- [Configuring the EMI final test](#)..... 1082
- [Configuring EMI limit lines](#).....1083
- [Controlling LISN](#).....1083



- [Retrieving EMI results](#)..... 1085
- [Evaluating the results](#)..... 1087
- [Programming example: EMI measurement](#)..... 1087

#### 13.5.14.1 Activating EMI measurement

EMI measurement must be activated explicitly.

- [CALCulate<n>:DELTamarker<m>:FUNCTION:FMEasurement\[:STATE\]](#)..... 1081
- [CALCulate<n>:MARKer<m>:FUNCTION:FMEasurement\[:STATE\]](#)..... 1081

---

**CALCulate<n>:DELTamarker<m>:FUNCTION:FMEasurement[:STATE]** <State>  
**CALCulate<n>:MARKer<m>:FUNCTION:FMEasurement[:STATE]** <State>

Turns the EMI measurement marker functionality on and off.

**Suffix:**

<n>                                          irrelevant

<m>                                          irrelevant

**Parameters:**

<State>                                      ON | OFF | 1 | 0

#### 13.5.14.2 Configuring EMI markers

The commands required to configure EMI markers are described here.

Useful commands for configuring EMI markers described elsewhere:

- [CALCulate<n>:MARKer<m>\[:STATE\]](#) on page 1274
- [CALCulate<n>:DELTamarker<m>\[:STATE\]](#) on page 1271
- [CALCulate<n>:MARKer<m>\[:STATE\]](#) on page 1274
- [CALCulate<n>:DELTamarker<m>\[:STATE\]](#) on page 1271
- [CALCulate<n>:DELTamarker<m>:MREference](#) on page 1271
- [CALCulate<n>:MARKer<ms>:LINK:TO:MARKer<md>](#) on page 1273
- [CALCulate<n>:DELTamarker<ms>:LINK:TO:MARKer<md>](#) on page 1270
- [CALCulate<n>:DELTamarker<m>:LINK](#) on page 1269
- [CALCulate<n>:MARKer<m>:TRACe](#) on page 1274

**Remote commands exclusive to configuring EMI markers**

- [CALCulate<n>:DELTamarker<m>:FUNCTION:FMEasurement:DETECTOR](#)..... 1081
- [CALCulate<n>:MARKer<m>:FUNCTION:FMEasurement:DETECTOR](#)..... 1081

---

**CALCulate<n>:DELTamarker<m>:FUNCTION:FMEasurement:DETECTOR** <Detector>  
**CALCulate<n>:MARKer<m>:FUNCTION:FMEasurement:DETECTOR** <Detector>

Selects the detector for a specific marker during the final measurement.

If the marker is not yet active, the command also turns the marker on.

**Suffix:**<n> [Window](#)<m> [Marker](#)**Parameters:**

<Detector>      **OFF**  
no final measurement is performed

**AVER**  
average detector

**CAV**  
CISPR Average detector

**CRMS**  
RMS Average detector

**POS**  
maximum peak detector

**QPE**  
quasipeak detector

\*RST:            OFF

**Manual operation:** See "[Final Test Detector](#)" on page 344

**13.5.14.3 Configuring the EMI final test**

The commands required to configure the EMI final test are described here.

Useful commands for configuring EMI final tests described elsewhere:

- [\[SENSe:\]BANDwidth\[:RESolution\]:TYPE](#) on page 1199
- [\[SENSe:\]BANDwidth\[:RESolution\]](#) on page 1198
- [DISPlay\[:WINDow<n>\]\[:SUBWindow<w>\]:TRACe<t>:X:SPACing](#) on page 1191

**Remote commands exclusive to configuring EMI final tests**

<a href="#">CALCulate&lt;n&gt;:MARKer&lt;m&gt;:FUNCTION:FMEasurement:PEAKsearch:AUTO</a> .....	1082
<a href="#">CALCulate&lt;n&gt;:DELTamarker&lt;m&gt;:FUNCTION:FMEasurement:PSEarch:AUTO</a> .....	1082
<a href="#">CALCulate&lt;n&gt;:MARKer&lt;m&gt;:FUNCTION:FMEasurement:PSEarch:AUTO</a> .....	1083
<a href="#">CALCulate&lt;n&gt;:DELTamarker&lt;m&gt;:FUNCTION:FMEasurement:PEAKsearch:AUTO</a> .....	1083
<a href="#">CALCulate&lt;n&gt;:DELTamarker&lt;m&gt;:FUNCTION:FMEasurement:DWELI</a> .....	1083
<a href="#">CALCulate&lt;n&gt;:MARKer&lt;m&gt;:FUNCTION:FMEasurement:DWELI</a> .....	1083

---

**CALCulate<n>:MARKer<m>:FUNCTION:FMEasurement:PEAKsearch:AUTO**  
<State>

**CALCulate<n>:DELTamarker<m>:FUNCTION:FMEasurement:PSEarch:AUTO**  
<State>

**CALCulate<n>:MARKer<m>:FUNCTION:FMEasurement:PSEarch:AUTO** <State>  
**CALCulate<n>:DELTamarker<m>:FUNCTION:FMEasurement:PEAKsearch:AUTO**  
 <State>

**Suffix:**

&lt;n&gt; 1..n

&lt;m&gt; 1..n

**Parameters:**

&lt;State&gt;

**CALCulate<n>:DELTamarker<m>:FUNCTION:FMEasurement:DWELI** <Time>  
**CALCulate<n>:MARKer<m>:FUNCTION:FMEasurement:DWELI** <Time>

Defines the dwell time during the final measurement.

**Suffix:**

&lt;n&gt; irrelevant

&lt;m&gt; irrelevant

**Parameters:**

<Time> Range: 100 us to 100 s  
 \*RST: 1 s  
 Default unit: s

**Manual operation:** See "[Dwell Time](#)" on page 348

#### 13.5.14.4 Configuring EMI limit lines

The commands required to define limit lines for EMI measurements are described in [Chapter 13.8.4, "Configuring display lines"](#), on page 1328.

#### 13.5.14.5 Controlling LISN

The commands required to control a LISN are described here.

[INPut:LISN:FILTer:HPASs\[:STATe\]](#)..... 1083  
[INPut:LISN:PHASe](#).....1084  
[INPut:LISN\[:TYPE\]](#)..... 1084

**INPut:LISN:FILTer:HPASs[:STATe]** <State>

Turns the 150 kHz highpass filter for the ENV216 network on and off.

**Parameters:**

&lt;State&gt; ON | OFF | 0 | 1

**OFF | 0**

Switches the function off

**ON | 1**

Switches the function on

\*RST: 0

**Example:** //Turn on high pass filter  
 INP:LISN:TYPE ENV216  
 INP:LISN:FILT:HPAS ON

**Manual operation:** See "[150 kHz Highpass](#)" on page 350

#### **INPut:LISN:PHASe** <Phase>

Selects one LISN phase to be measured.

#### **Parameters:**

<Phase>            **L1**  
**L2**  
 Available for networks with four phases (R&S ESH2Z5,  
 R&S ENV4200 and R&S ENV432)  
**L3**  
 Available for networks with four phases (R&S ESH2Z5,  
 R&S ENV4200 and R&S ENV432)  
**N**  
 \*RST:            L1

**Example:** //Select phase L1  
 INP:LISN:PHAS L1

**Manual operation:** See "[Phase](#)" on page 350

#### **INPut:LISN[:TYPE]** <Type>

Turns automatic control of a LISN on and off. It also selects the type of network.

#### **Parameters:**

<Type>            **ENV216**  
 R&S ENV 216 / AMN6500: two phases and highpass are con-  
 trollable.  
**ENV432**  
 R&S ENV 432: four phases are controllable.  
**ENV4200**  
 R&S ENV 4200: four phases are controllable.  
**ESH2Z5**  
 R&S ESH2-Z5: four phases (incl. protective earth) are controlla-  
 ble.  
**ESH3Z5**  
 R&S ESH3-Z5: two phases (incl. protective earth) are controlla-  
 ble.  
**FOURphase**  
 R&S ESH2-Z5: four phases (incl. protective earth) are controlla-  
 ble.  
**OFF**  
 Turns off remote control of the LISN.

**TWOPhase**

R&S ESH3-Z5: two phases (incl. protective earth) are controllable.

\*RST: OFF

**Example:** //Select LISN  
INP:LISN:TYPE TWOP

**Manual operation:** See "[LISN Type](#)" on page 350

**13.5.14.6 Retrieving EMI results**

The commands required to retrieve EMI measurement results are described here.

Useful commands for retrieving EMI measurement results described elsewhere:

- [CALCulate<n>:MARKer<m>:X](#) on page 1275  
[CALCulate<n>:DELTamarker<m>:X](#) on page 1272
- [CALCulate<n>:MARKer<m>:Y?](#) on page 1288  
[CALCulate<n>:DELTamarker<m>:Y?](#) on page 1288

**Remote commands exclusive to retrieving EMI measurement results**

<a href="#">CALCulate&lt;n&gt;:DELTamarker&lt;m&gt;:FUNCTION:FMEasurement:RESult?</a> .....	1085
<a href="#">CALCulate&lt;n&gt;:MARKer&lt;m&gt;:FUNCTION:FMEasurement:RESult?</a> .....	1085
<a href="#">CALCulate&lt;n&gt;:DELTamarker&lt;m&gt;:FUNCTION:FMEasurement:LIMit&lt;li&gt;:LCONDition?</a> .....	1086
<a href="#">CALCulate&lt;n&gt;:MARKer&lt;m&gt;:FUNCTION:FMEasurement:LIMit&lt;li&gt;:LCONDition?</a> .....	1086
<a href="#">CALCulate&lt;n&gt;:DELTamarker&lt;m&gt;:FUNCTION:FMEasurement:LIMit&lt;li&gt;:LDELta?</a> .....	1086
<a href="#">CALCulate&lt;n&gt;:MARKer&lt;m&gt;:FUNCTION:FMEasurement:LIMit&lt;li&gt;:LDELta?</a> .....	1086

**CALCulate<n>:DELTamarker<m>:FUNCTION:FMEasurement:RESult? <Result>**  
**CALCulate<n>:MARKer<m>:FUNCTION:FMEasurement:RESult? <Result>**

Queries the result of the EMI measurement at the marker position.

**Suffix:**

<n> [Window](#)

<m> [Marker](#)

**Return values:**

<Result> Power level. The unit depends on the one you have currently set.

**Example:** CALC:MARK1:FUNC:FME:RES?  
Queries the result of marker 1.

**Usage:** Query only

---

**CALCulate<n>:DELTamarker<m>:FUNction:FMEasurement:LIMit<li>:  
LCONdition? <Condition>**  
**CALCulate<n>:MARKer<m>:FUNction:FMEasurement:LIMit<li>:LCONdition?  
<Condition>**

Queries the condition of a marker position in relation to a certain limit line.

**Suffix:**

<n> [Window](#)  
<m> [Marker](#)  
<li> [Limit line](#)

**Return values:**

<Condition> **0**  
The marker has passed the limit check.  
**1**  
The marker is inside the margins of a limit line.  
**2**  
The marker has failed the limit check.

**Example:**

CALC:MARK1:FUNC:FME:LIM2:LCON?  
Queries the condition of marker 1 in relation to limit line 2.

**Usage:**

Query only

---

**CALCulate<n>:DELTamarker<m>:FUNction:FMEasurement:LIMit<li>:LDELta?  
CALCulate<n>:MARKer<m>:FUNction:FMEasurement:LIMit<li>:LDELta?  
<Amplitude>**

Queries the vertical distance from the marker position to the limit line. The unit is dB.

If the marker has been assigned to a different trace than the limit line, or if no limit line is defined for the marker position, the command returns -200.

**Suffix:**

<n> [Window](#)  
<m> [Marker](#)  
<li> [1..n](#)  
[Limit line](#)

**Return values:**

<Amplitude> Vertical distance to the limit line in dB.

**Example:**

CALC:MARK3:FUNC:FME:LIM2:LDEL?  
Queries the distance of marker 3 to the second limit line.

**Usage:**

Query only

### 13.5.14.7 Evaluating the results

The commands required to control the demodulation of signals at the marker position are described in [Chapter 13.8.3.14, "Marker demodulation"](#), on page 1316.

### 13.5.14.8 Programming example: EMI measurement

This example demonstrates how to detect electromagnetic interferences (EMI) in a remote environment.

```
//----- Preparing the measurement -----
//Reset the instrument
*RST
//Define the span to be analyzed
FREQ:STAR 150kHz
FREQ:STOP 1GHz
//Configure two traces, one with peak detector, one with average detector
DISP:TRAC1 ON
DISP:TRAC2 ON
DET1 POS
DET2 AVER

//----- Configuring the measurement -----
//Select EMI measurement
CALC:MARK:FUNC:FME:STAT ON
//Configure CISPR filter and RBW
BAND:TYPE CISP
BAND:RES 1MHz
//Define the dwell time
CALC:MARK:FUNC:FME:DWEL 1ms
//Configure an auto peak search
CALC:MARK:FUNC:FME:PEAK:AUTO ON
//Configure a logarithmic frequency scaling
DISP:TRAC:X:SPAC LOG
//Configure marker demodulation for marker 1
CALC:MARK:FUNC:DEM ON
//Increase the number of sweep points
SWE:POIN 200000
//Set the unit to V
CALC:UNIT:POW V

//----- Configuring EMI markers -----
//Activate 6 normal EMI markers
CALC:MARK1 ON
CALC:MARK2 ON
CALC:MARK3 ON
CALC:MARK4 ON
CALC:MARK5 ON
CALC:MARK6 ON
```

## Configuring and performing measurements

```

//Set markers 1 to 3 on trace 1. Set markers 4 to 6 on trace 2.
CALC:MARK1:TRAC 1
CALC:MARK2:TRAC 1
CALC:MARK3:TRAC 1
CALC:MARK4:TRAC 2
CALC:MARK5:TRAC 2
CALC:MARK6:TRAC 2
//Use CISPR average detector for all markers during final test
CALC:MARK1:FUNC:FME:DET CAV
CALC:MARK2:FUNC:FME:DET CAV
CALC:MARK3:FUNC:FME:DET CAV
CALC:MARK4:FUNC:FME:DET CAV
CALC:MARK5:FUNC:FME:DET CAV
CALC:MARK6:FUNC:FME:DET CAV

//----- Configuring a limit check -----
//Select EN55011A.LIN as limit line 1
CALC:LIM1:NAME "EN55011A.LIN"
//Configure trace 1 to be checked against limit line 1
CALC:LIM1:TRAC1:CHEC ON
//Clear the results of all previous limit checks
CALC:LIM:CLE

//----- Performing the Measurement -----
//Select single sweep mode.
INIT:CONT OFF
//Initiate a new measurement and wait until the sweep has finished.
INIT;*WAI

//----- Retrieving Results -----
//Query the results for the EMI measurement
//First marker frequency, then final test level
CALC:MARK1:X?
CALC:MARK1:FUNC:FME:RES?
CALC:MARK2:X?
CALC:MARK2:FUNC:FME:RES?
CALC:MARK3:X?
CALC:MARK3:FUNC:FME:RES?
CALC:MARK4:X?
CALC:MARK4:FUNC:FME:RES?
CALC:MARK5:X?
CALC:MARK5:FUNC:FME:RES?
CALC:MARK6:X?
CALC:MARK6:FUNC:FME:RES?

//Query the result of the limit check for trace 1
CALC:LIM1:FAIL?
//Query the result of the limit check and the distance from the limit lines
//for each marker

```



```

CALC:MARK1:FUNC:FME:LIM:COND?
CALC:MARK1:FUNC:FME:LIM:DELT?
CALC:MARK2:FUNC:FME:LIM:COND?
CALC:MARK2:FUNC:FME:LIM:DELT?
CALC:MARK3:FUNC:FME:LIM:COND?
CALC:MARK3:FUNC:FME:LIM:DELT?
CALC:MARK4:FUNC:FME:LIM:COND?
CALC:MARK4:FUNC:FME:LIM:DELT?
CALC:MARK5:FUNC:FME:LIM:COND?
CALC:MARK5:FUNC:FME:LIM:DELT?
CALC:MARK6:FUNC:FME:LIM:COND?
CALC:MARK6:FUNC:FME:LIM:DELT?

```

### 13.5.15 List evaluations

A list evaluation is a multiple power measurement that measures the power at up to 200 frequencies. The measurement itself is a time domain measurement. Note that if you set a span greater than 0, the FSW aborts the list evaluation.



#### Noise cancellation in list evaluations

Noise cancellation is also available in zero span and thus also for list evaluations. See "[Noise Cancellation](#)" on page 168 for details.

List evaluations allow for a different instrument setup for each frequency you want to measure. You can define most of the settings with the commands described here. Settings not covered by the commands listed below can be controlled with the common commands (see [Chapter 13.7, "Setting basic measurement parameters"](#), on page 1109. Note that these commands have to be sent prior to the commands that control the list evaluation.

In case of a triggered measurement, a separate trigger event is required for each frequency to initiate that measurement. Note that you have to make changes to the trigger level in the time domain in order for it to take effect for the List Evaluation commands.



The list evaluation is incompatible to other measurement functions (e.g. marker functionality or statistics). If you use a command that controls those functions, the FSW aborts the list evaluation.

The FSW also aborts the list evaluation if you end the remote session.

The commands can be used in two different ways.

- Instrument setup, measurement and querying of the results in a single command line. This method causes the least delay between the measurement and the result output. However, it requires the control computer to wait for the response from the instrument.
- Instrument setup and querying of the result list at the end of the measurement: With this method, the control computer may be used for other activities while the

measurement is being performed. However, more time is needed for synchronization via service request.

### 13.5.15.1 Performing list evaluations

All remote control commands specific to list evaluations (which are available via remote control only) are described here.

Useful commands for list evaluation described elsewhere:

- [\[SENSe:\]POWer:NCORrection](#) on page 1208

#### Remote commands exclusive to list evaluation

<a href="#">[SENSe:]LIST:POWer:RESult?</a> .....	1090
<a href="#">[SENSe:]LIST:POWer[:SEquence]</a> .....	1090
<a href="#">[SENSe:]LIST:POWer:SET</a> .....	1091
<a href="#">[SENSe:]LIST:POWer:STATe</a> .....	1092

---

#### **[SENSe:]LIST:POWer:RESult?**

Queries the results of the list evaluation.

May be used to obtain measurement results in an asynchronous way, using the service request mechanism for synchronization to the end of the measurement.

If there are no results, the command returns an error.

#### **Return values:**

<PowerLevel>      Power level for each frequency included in the measurement. The command returns up to 3 power levels for each frequency, depending on the number of evaluation modes you have turned on with [\[SENSe:\]LIST:POWer:SET](#). The result is a list of floating point values separated by commas. The unit depends on [CALCulate<n>:UNIT:POWer](#).

**Usage:**              Query only

---

**[SENSe:]LIST:POWer[:SEquence]** {<Frequency>, <RefLevel>, <RFAttenuation>, <FilterType>, <RBW>, <VBW>, <MeasTime>, <TriggerLevel>, <PowerLevel>}...

Configures and initiates the List Evaluation measurement.

The list can contain up to 200 entries (frequencies). You can define a different instrument setup for each frequency that is in the list.

If you synchronize the measurement with \*OPC, the FSW produces a service request when all frequencies have been measured and the number of individual measurements has been performed.

Note that using the command as a query initiates the measurement and returns the results if all frequencies have been measured. For more information on querying the results see [\[SENSe:\]LIST:POWer:RESult?](#).

<b>Parameters:</b>	
<Frequency>	Defines the frequency. Each frequency corresponds to one list entry. Range: 0 to Fmax Default unit: Hz
<RefLevel>	Defines the reference level for a list entry. Range: -130 to 30 Increment: 0.01 Default unit: dBm
<RFAttenuation>	Defines the RF attenuation for a list entry. Range: 0 to 70 Increment: 1 Default unit: dB
<FilterType>	Selects the filter type for a list entry. For more information see <a href="#">[SENSe:]BANDwidth[:RESolution]:TYPE</a> .
<RBW>	Defines the resolution bandwidth for a list entry.
<VBW>	Defines the measurement time for a list entry.
<MeasTime>	Defines the measurement time for a list entry. Range: 1 $\mu$ s to 16000 s Default unit: s
<TriggerLevel>	Reserved for future use; currently: must be 0.
<PowerLevel>	Default unit: PCT
<b>Example:</b>	See <a href="#">Chapter 13.5.15.2, "Example: performing list evaluation"</a> , on page 1092.
<b>Usage:</b>	Asynchronous command

---

**[SENSe:]LIST:POWer:SET** <State>, <State>, <State>, <TriggerSource>, <TriggerSlope>, <TriggerOffset>, <GateLength>

Defines global List Evaluation parameters.

These parameters are valid for every frequency you want to measure.

The state of the first three parameters (<PeakPower>, <RMSPower> and <AVG-Power>) define the number of results for each frequency in the list.

Note that you have to set the trigger level *after* sending this command.

**Parameters:**

<State>	ON   OFF   0   1 Turns peak power evaluation on and off.
*RST:	1

<State>	ON   OFF   0   1 Turns RMS power evaluation on and off. *RST: 0
<State>	ON   OFF   0   1 Turns average power evaluation on and off. *RST: 0
<TriggerSource>	EXTernal   EXT2   EXT3   IMMEDIATE   IFPower   RFPower   VIDEO Selects a trigger source. For more information see <a href="#">Configuring triggered and gated measurements</a> .
<TriggerSlope>	POSitive   NEGative Selects the trigger slope.
<TriggerOffset>	Defines the trigger delay. Range: negative measurement time to 30 s *RST: 0 Default unit: s
<GateLength>	Defines the gate length for gated measurements. Setting 0 seconds turns gated measurements off. To perform gated measurements, the trigger source must be different from IMMEDIATE. Range: 31.25 ns to 30 s *RST: 0 s Default unit: s

---

**[SENSe:]LIST:POWer:STATe <State>**

Turns the List Evaluation off.

**Parameters:**

<State>	OFF   0 *RST: 0
---------	--------------------

**13.5.15.2 Example: performing list evaluation**

The following example shows a list evaluation with the following configuration.

No	Freq [MHz]	Ref Level [dBm]	RF Attenuation [dB]	EI Attenuation [dB]	Filter	RBW	VBW	Meas Time	Trigger Level
1	935.2	0	10	---	Normal	1 MHz	3 MHz	440 $\mu$ s	0
2	935.4	0	10	10	Channel	30 kHz	100 kHz	440 $\mu$ s	0
3	935.6	0	10	20	Channel	30 kHz	100 kHz	440 $\mu$ s	0

## Configuring and performing measurements

```

-----Measurement with synchronization via service request-----
*ESE 1
*SRE 32
// Configures the status reporting system to produce a service request.
LIST:POW:SET ON,ON,OFF,EXT,POS,10us,434us
//Turns on the list evaluation, configures the global list evaluation settings and
//evaluates the peak and RMS power.
LIST:POW
935.2MHZ,0,10,OFF,NORM,1MHZ,3MHZ,440us,0,
935.4MHZ,0,10,10,CFIL,30KHZ,100KHZ,440us,0,
935.6MHZ,0,10,20,CFIL,30KHZ,100KHZ,440us,0;
*OPC
//Defines a list with 3 entries and initiates the measurement with synchronization to the end
//Analyzer produces a service request
//On service request:
SENS:LIST:POW:RES?
//Returns the results of the measurements, two for each frequency (peak and RMS power).

-----Initiliazing the measurement and querying results simultaneously-----
LIST:POW?
935.2MHZ,0,10,OFF,NORM,1MHZ,3MHZ,440us,0,
935.4MHZ,0,10,10,CFIL,30KHZ,100KHZ,440us,0,
935.6MHZ,0,10,20,CFIL,30KHZ,100KHZ,440us,0
//Defines a list with 3 entries, initiates the measurement and queries the results.
//Result example:
-28.3,-30.6,-38.1

```

### 13.5.16 Measuring the pulse power

All remote control commands specific to measuring the mean or peak pulse power (e.g. bursts in various telecommunications standards) are described here. This measurement is available via remote control only.

The Pulse Power measurement is a gated measurement that determines the power over a particular number of pulses. The measurement is controlled by an external trigger or the video signal. A separate trigger event is required for each burst included in the measurement. In case of an external trigger source, the trigger level corresponds to the TTL level. In case of a video signal, you can define any threshold.

The figure below shows the relations between the available trigger settings.

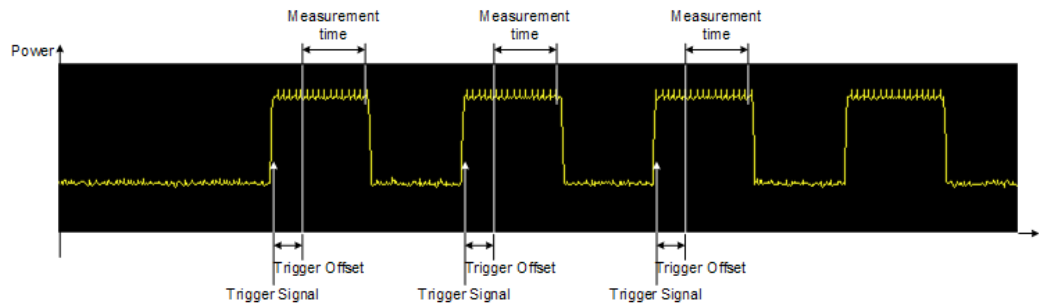

The measurement is always on trace 1, either with the peak detector to determine the peak power or the RMS detector to determine the RMS power. Overall, you can configure the measurement independent of the instrument setup with the commands listed below only, which results in faster measurements.



The Pulse Power measurement is incompatible to other measurement functions (e.g. marker functionality or statistics). If you use a command that controls those functions, the FSW aborts the Pulse Power measurement.

The FSW also aborts the Pulse Power measurement if you end the remote session.

The commands can be used in two different ways.

- Instrument setup, measurement and querying of the results in a single command line. With this method, there is the least delay between the measurement and the result output. However, it requires the control computer to wait for the response from the instrument.
- Instrument setup and querying of the result list at the end of the measurement: With this method, the control computer may be used for other activities while the measurement is being performed. However, more time is needed for synchronization via service request.

### 13.5.16.1 Performing pulse power measurements

The following commands control pulse power measurements.

<a href="#">CALCulate&lt;n&gt;:MARKer&lt;m&gt;:FUNCTION:MSUMmary</a> .....	1094
<a href="#">[SENSe:]MPOWER:FTYPE</a> .....	1095
<a href="#">[SENSe:]MPOWER:RESult[:LIST]?</a> .....	1096
<a href="#">[SENSe:]MPOWER[:SEQUence]</a> .....	1096
<a href="#">[SENSe:]MPOWER:RESult:MIN?</a> .....	1097

---

**CALCulate<n>:MARKer<m>:FUNCTION:MSUMmary** <TimeOffset>, <MeasTime>, <PulsePeriod>, <OfPulses>

Configures power measurements on pulses in the time domain.

To evaluate the pulse power, the FSW uses the data captured during a previous measurement. The data recorded during the set measurement time is combined to a measured value for each pulse according to the detector specified and the indicated number of results is output as a list.

## Configuring and performing measurements

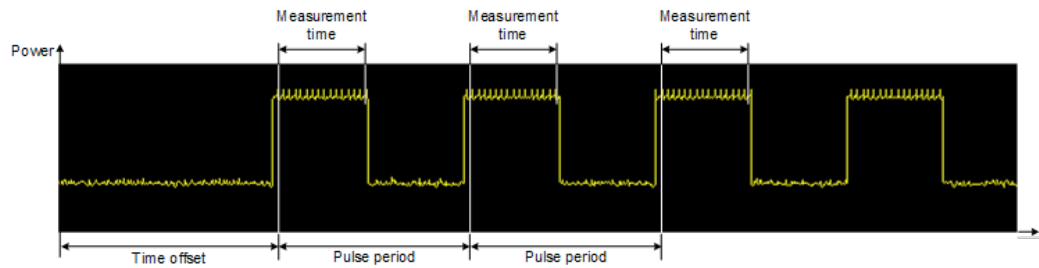

To get a valid result, you have to perform a complete measurement with synchronization to the end of the measurement before reading out the result. This is only possible for single sweep mode.

See also `INITiate<n>:CONTinuous` on page 909.

**Suffix:**

<n> [Window](#)

<m> [Marker](#)

**Parameters:**

<TimeOffset> Defines a time offset to start the measurement at the first pulse of a trace.

\*RST: 0

Default unit: s

<MeasTime> Defines the measurement time.

Default unit: s

<PulsePeriod> Defines the pulse period.

Default unit: s

<OfPulses> Defines the number of pulses to measure.

**Example:**

```
CALC:MARK:FUNC:MSUM 50US,450US,576.9US,8
```

Evaluates data that contains 8 pulses during a measurement time of 450  $\mu$ s and a pulse period of 576.9  $\mu$ s. The evaluation starts with an offset of 50  $\mu$ s.

**[SENSe:]MPOWER:FTYPE <FilterType>**

This command selects the filter type for pulse power measurements.

The EMI-specific filter types are available if the EMI (R&S FSW-K54) measurement option is installed, even if EMI measurement is not active. For details see [Chapter 6.13.3.1, "Resolution bandwidth and filter types"](#), on page 335.

**Parameters:**

<FilterType> **CFILter**  
**NORMAL**  
**P5**  
**RRC**

**CISPr | PULSe**

CISPR (6 dB) - requires EMI (R&S FSW-K54) option

Return value for query is always `PULS`.

**MIL**

MIL Std (6 dB) - requires EMI (R&S FSW-K54) option

**[SENSe:]MPOWer:RESult[:LIST]?**

Queries the results of the pulse power measurement.

May be used to obtain measurement results in an asynchronous way, using the service request mechanism for synchronization to the end of the measurement.

If there are no results, the command returns an error.

**Return values:**

<PulsePower> List of pulse powers.  
The number of values depends on the number of pulses you have been measuring.  
The unit is dBm.

**Usage:** Query only

**[SENSe:]MPOWer[:SEQuence] <Frequency>, <RBW>, <MeasTime>, <TriggerSource>, <TriggerLevel>, <TriggerOffset>, <Detector>, <NoPulses>**

Configures and initiates the pulse power measurement.

The FSW caches all measurement parameters that you can set with this command. If you use the command repeatedly, the FSW only changes those settings that you have actually changed before initiating the measurement. Thus, measurement times are kept as low as possible.

If you synchronize the measurement with `*OPC`, the FSW produces a service request when all frequencies have been measured and the number of individual measurements has been performed.

Note that using the command as a query initiates the measurement and returns the results if all frequencies have been measured. For more information on querying the results see [\[SENSe:\]LIST:POWer:RESult?](#).

**Parameters:**

<Frequency> Defines the pulse frequency.  
Range: 0 to Fmax  
Default unit: Hz

<RBW> Defines the resolution bandwidth.  
Default unit: HZ

<MeasTime> Defines the measurement time.  
Range: 1  $\mu$ s to 30 s  
Default unit: S



<TriggerSource>	<p>EXTernal   EXT2   EXT3   VIDEo   IFPower</p> <p>Selects a trigger source. For more information see <a href="#">Configuring triggered and gated measurements</a>.</p>
<TriggerLevel>	<p>Defines a trigger level. The trigger level is available for the video trigger or IF power trigger. For a video trigger, the level is a percentage (0 to 100) of the diagram height. For an IF power trigger, the level is a dBm value. See the specifications document for available trigger levels and trigger bandwidths. For an external trigger, the FSW uses a fixed TTL level.</p>
<TriggerOffset>	<p>Defines the trigger delay.</p> <p>Range: 0 s to 30 s *RST: 0 s Default unit: s</p>
<Detector>	<p>Selects the detector and therefore the way the measurement is evaluated.</p> <p><b>MEAN</b> Calculates the RMS pulse power.</p> <p><b>PEAK</b> Calculates the peak pulse power.</p>
<OfPulses>	<p>Defines the number of pulses included in the measurement.</p> <p>Range: 1 to 32001</p>
<b>Return values:</b>	
<PowerLevel>	<p>Pulse power level. The result is a list of floating point values separated by commas. The unit is dBm.</p>
<b>Usage:</b>	Asynchronous command

---

#### [SENSe:]MPOWer:RESult:MIN?

Queries the lowest pulse power that has been measured during a pulse power measurement.

If there are no results, the command returns an error.

**Return values:**

<PulsePower> Lowest power level of the pulse power measurement.  
The unit is dBm.

**Usage:** Query only

### 13.5.16.2 Example: performing a pulse power measurement

The following example shows a pulse power measurement.

```

-----Measurement with synchronization via service request-----
*ESE 1
*SRE 32
// Configures the status reporting system to produce a service request.
MPOW:FTYP NORM
//Selects a Gaussian filter for the measurement.
MPOW 935.2MHZ,1MHZ,434us,VID,50,5us,MEAN,20;
*OPC
//Configures and initiates a measurement on 20 pulses with synchronization to the end.
//Analyzer produces a service request
//On service request:
MPOW:RES?
//Returns the results of the measurements (20 power levels).
MPOW:RES:MIN?
//Returns the lowest of the 20 power level that have been measured.

-----Initiliazing the measurement and querying results simultaneously-----
MPOW? 935.2MHZ,1MHZ,434us,VID,50,5us,MEAN,20
//Configures, initiates and queries the results of the measurement.
//Result example:
-105.225059509,-105.656074524,-105.423065186,-104.374649048,-103.059822083,-101.29511261,
-99.96534729,-99.7452468872,-99.6610794067,-100.327224731,-100.96686554,-101.450386047,
-102.150642395,-103.240142822,-105.95476532,-110.583129883,-115.7760849,-126.279388428,
-124.620399475,-116.97366333

```

## 13.6 Configuring the result display

The commands required to configure the screen display in a remote environment are described here.

The tasks for manual operation are described in [Chapter 8.1, "Result display configuration"](#), on page 534.

- [General window commands](#)..... 1098
- [Working with windows in the display](#)..... 1099
- [Examples: configuring the result display](#)..... 1106

### 13.6.1 General window commands

The following commands are required to configure general window layout, independent of the application.

Note that the suffix <n> always refers to the window *in the currently selected channel* (see [INSTrument\[:SElect\]](#) on page 902).

<a href="#">DISPlay:FORMat</a> .....	1099
<a href="#">DISPlay[:WINDow&lt;n&gt;]:SIZE</a> .....	1099

---

### **DISPlay:FORMat** <Format>

Determines which tab is displayed.

#### **Parameters:**

<Format>

#### **SPLit**

Displays the MultiView tab with an overview of all active channels

(See [Chapter 5.2, "R&S multiview"](#), on page 119).

#### **SINGLE**

Displays the measurement channel that was previously focused.

\*RST: SING

#### **Example:**

DISP:FORM SPL

---

### **DISPlay[:WINDow<n>]:SIZE** <Size>

Maximizes the size of the selected result display window *temporarily*. To change the size of several windows on the screen permanently, use the [LAY:SPL](#) command (see [LAYout:SPLitter](#) on page 1103).

#### **Suffix:**

<n>

[Window](#)

#### **Parameters:**

<Size>

#### **LARGE**

Maximizes the selected window to full screen.

Other windows are still active in the background.

#### **SMALI**

Reduces the size of the selected window to its original size.

If more than one measurement window was displayed originally, these are visible again.

\*RST: SMALI

#### **Example:**

DISP:WIND2:SIZE LARG

## 13.6.2 Working with windows in the display

The following commands are required to change the evaluation type and rearrange the screen layout for a channel as you do using the SmartGrid in manual operation. Since the available evaluation types depend on the selected application, some parameters for the following commands also depend on the selected channel.

Note that the suffix <n> always refers to the window *in the currently selected channel*.

(See `INSTrument[:SElect]` on page 902).

<code>LAYout:ADD[:WINDow]?</code> .....	1100
<code>LAYout:CATalog[:WINDow]?</code> .....	1101
<code>LAYout:IDENtify[:WINDow]?</code> .....	1101
<code>LAYout:MOVE[:WINDow]</code> .....	1102
<code>LAYout:REMove[:WINDow]</code> .....	1102
<code>LAYout:REPLace[:WINDow]</code> .....	1102
<code>LAYout:SPLitter</code> .....	1103
<code>LAYout:WINDow&lt;n&gt;:ADD?</code> .....	1104
<code>LAYout:WINDow&lt;n&gt;:IDENtify?</code> .....	1105
<code>LAYout:WINDow&lt;n&gt;:REMove</code> .....	1105
<code>LAYout:WINDow&lt;n&gt;:REPLace</code> .....	1105
<code>LAYout:WINDow&lt;n&gt;:TYPE</code> .....	1106

---

### **LAYout:ADD[:WINDow]?** <WindowName>, <Direction>, <WindowType>

Adds a window to the display in the active channel.

Is always used as a query so that you immediately obtain the name of the new window as a result.

To replace an existing window, use the `LAYout:REPLace[:WINDow]` command.

#### **Query parameters:**

<WindowName>	String containing the name of the existing window the new window is inserted next to. By default, the name of a window is the same as its index. To determine the name and index of all active windows, use the <code>LAYout:CATalog[:WINDow]?</code> query.
<Direction>	LEFT   RIGHT   ABOVE   BELOW Direction the new window is added relative to the existing window.
<WindowType>	text value Type of result display (evaluation method) you want to add. See the table below for available parameter values.

#### **Return values:**

<NewWindowName>	When adding a new window, the command returns its name (by default the same as its number) as a result.
-----------------	---------------------------------------------------------------------------------------------------------

#### **Example:**

```
LAY:ADD? '1', LEFT, MTAB
```

Result:

```
'2'
```

Adds a new window named '2' with a marker table to the left of window 1.

#### **Usage:**

Query only

**Manual operation:** See "Diagram" on page 535  
 See "Marker Table" on page 535  
 See "Marker Peak List" on page 536  
 See "Result Summary" on page 536  
 See "Spectrogram" on page 536

**Table 13-3:** <WindowType> parameter values for the Spectrum application

Parameter value	Window type
DIAGram	"Diagram"
MTABLE	"Marker table"
PEAKlist	"Marker peak list"
RSUMmary	"Result summary"
SGRam	"Spectrogram"

### LAYout:CATalog[:WINDow]?

Queries the name and index of all active windows in the active channel from top left to bottom right. The result is a comma-separated list of values for each window, with the syntax:

<WindowName\_1>,<WindowIndex\_1>..<WindowName\_n>,<WindowIndex\_n>

**Return values:**

<WindowName>      string  
 Name of the window.  
 In the default state, the name of the window is its index.

<WindowIndex>    **numeric value**  
 Index of the window.

**Example:**

LAY:CAT?

Result:

'2',2,'1',1

Two windows are displayed, named '2' (at the top or left), and '1' (at the bottom or right).

**Usage:**            Query only

### LAYout:IDENTify[:WINDow]? <WindowName>

Queries the **index** of a particular display window in the active channel.

**Note:** to query the **name** of a particular window, use the `LAYout:WINDow<n>:IDENTify?` query.

**Query parameters:**

<WindowName>      String containing the name of a window.

**Return values:**

<WindowIndex>    Index number of the window.

**Example:** `LAY:IDEN:WIND? '2'`  
 Queries the index of the result display named '2'.  
**Response:**  
 2

**Usage:** Query only

**LAYout:MOVE[:WINDow] <WindowName>, <WindowName>, <Direction>**

**Setting parameters:**

<WindowName> String containing the name of an existing window that is to be moved.  
 By default, the name of a window is the same as its index. To determine the name and index of all active windows in the active channel, use the `LAYout:CATalog[:WINDow]?` query.

<WindowName> String containing the name of an existing window the selected window is placed next to or replaces.  
 By default, the name of a window is the same as its index. To determine the name and index of all active windows in the active channel, use the `LAYout:CATalog[:WINDow]?` query.

<Direction> LEFT | RIGHT | ABOVE | BELOW | REPLACE  
 Destination the selected window is moved to, relative to the reference window.

**Example:** `LAY:MOVE '4', '1', LEFT`  
 Moves the window named '4' to the left of window 1.

**Example:** `LAY:MOVE '1', '3', REPL`  
 Replaces the window named '3' by window 1. Window 3 is deleted.

**Usage:** Setting only

**LAYout:REMOve[:WINDow] <WindowName>**

Removes a window from the display in the active channel.

**Setting parameters:**

<WindowName> String containing the name of the window. In the default state, the name of the window is its index.

**Example:** `LAY:REM '2'`  
 Removes the result display in the window named '2'.

**Usage:** Setting only

**LAYout:REPLace[:WINDow] <WindowName>, <WindowType>**

Replaces the window type (for example from "Diagram" to "Result Summary") of an already existing window in the active channel while keeping its position, index and window name.

To add a new window, use the `LAYout:ADD[:WINDow]?` command.

#### Setting parameters:

<WindowName> String containing the name of the existing window.  
By default, the name of a window is the same as its index. To determine the name and index of all active windows in the active channel, use the `LAYout:CATalog[:WINDow]?` query.

<WindowType> Type of result display you want to use in the existing window.  
See `LAYout:ADD[:WINDow]?` on page 1100 for a list of available window types.

**Example:** `LAY:REPL:WIND '1',MTAB`  
Replaces the result display in window 1 with a marker table.

**Usage:** Setting only

---

#### `LAYout:SPLitter` <Index1>, <Index2>, <Position>

Changes the position of a splitter and thus controls the size of the windows on each side of the splitter.

Compared to the `DISPlay[:WINDow<n>]:SIZE` on page 1099 command, the `LAYout:SPLitter` changes the size of all windows to either side of the splitter permanently, it does not just maximize a single window temporarily.

Note that windows must have a certain minimum size. If the position you define conflicts with the minimum size of any of the affected windows, the command does not work, but does not return an error.

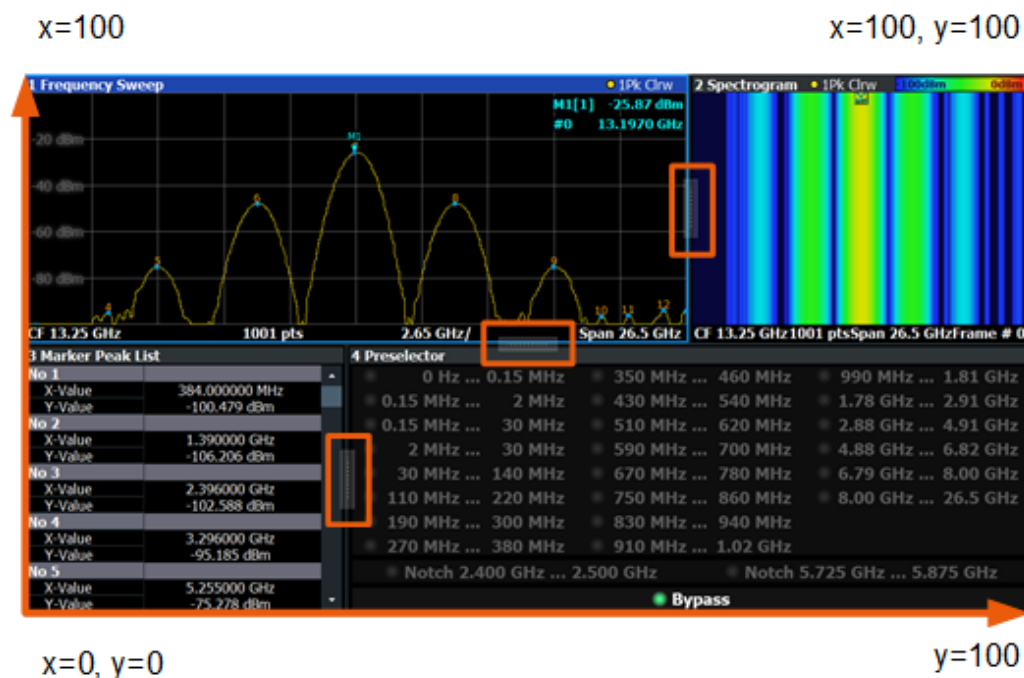

Figure 13-2: SmartGrid coordinates for remote control of the splitters

**Setting parameters:**

<Index1>	The index of one window the splitter controls.
<Index2>	The index of a window on the other side of the splitter.
<Position>	New vertical or horizontal position of the splitter as a fraction of the screen area (without channel and status bar and softkey menu). The point of origin (x = 0, y = 0) is in the lower left corner of the screen. The end point (x = 100, y = 100) is in the upper right corner of the screen. (See <a href="#">Figure 13-2</a> .) The direction in which the splitter is moved depends on the screen layout. If the windows are positioned horizontally, the splitter also moves horizontally. If the windows are positioned vertically, the splitter also moves vertically. Range: 0 to 100

**Example:**

```
LAY:SPL 1,3,50
```

Moves the splitter between window 1 ('Frequency Sweep') and 3 ('Marker Table') to the center (50%) of the screen, i.e. in the figure above, to the left.

**Example:**

```
LAY:SPL 1,4,70
```

Moves the splitter between window 1 ('Frequency Sweep') and 3 ('Marker Peak List') towards the top (70%) of the screen.

The following commands have the exact same effect, as any combination of windows above and below the splitter moves the splitter vertically.

```
LAY:SPL 3,2,70
```

```
LAY:SPL 4,1,70
```

```
LAY:SPL 2,1,70
```

**Usage:**

Setting only

**LAYout:WINDow<n>:ADD? <Direction>,<WindowType>**

Adds a measurement window to the display. Note that with this command, the suffix <n> determines the existing window next to which the new window is added. Unlike [LAYout:ADD\[:WINDow\]?](#), for which the existing window is defined by a parameter.

To replace an existing window, use the [LAYout:WINDow<n>:REPLace](#) command.

Is always used as a query so that you immediately obtain the name of the new window as a result.

**Suffix:**

<n> [Window](#)

**Query parameters:**

<Direction> LEFT | RIGHT | ABOVE | BELOW

<WindowType> Type of measurement window you want to add.

See [LAYout:ADD\[:WINDow\]?](#) on page 1100 for a list of available window types.



**Return values:**

<NewWindowName> When adding a new window, the command returns its name (by default the same as its number) as a result.

**Example:**

```
LAY:WIND1:ADD? LEFT,MTAB
```

Result:

```
'2'
```

Adds a new window named '2' with a marker table to the left of window 1.

**Usage:**

Query only

**LAYout:WINDow<n>:IDENtify?**

Queries the **name** of a particular display window (indicated by the <n> suffix) in the active channel.

**Note:** to query the **index** of a particular window, use the [LAYout:IDENtify\[:WINDow\]?](#) command.

**Suffix:**

<n> [Window](#)

**Return values:**

<WindowName> String containing the name of a window.  
In the default state, the name of the window is its index.

**Example:**

```
LAY:WIND2:IDEN?
```

Queries the name of the result display in window 2.

Response:

```
'2'
```

**Usage:**

Query only

**LAYout:WINDow<n>:REMOve**

Removes the window specified by the suffix <n> from the display in the active channel.

The result of this command is identical to the [LAYout:REMOve\[:WINDow\]](#) command.

**Suffix:**

<n> [Window](#)

**Example:**

```
LAY:WIND2:REM
```

Removes the result display in window 2.

**Usage:**

Event

**LAYout:WINDow<n>:REPLace <WindowType>**

Changes the window type of an existing window (specified by the suffix <n>) in the active channel.

The effect of this command is identical to the `LAYout:REPLace[:WINDow]` command.

To add a new window, use the `LAYout:WINDow<n>:ADD?` command.

**Suffix:**

<n> [Window](#)

**Setting parameters:**

<WindowType> Type of measurement window you want to replace another one with.  
See `LAYout:ADD[:WINDow]?` on page 1100 for a list of available window types.

**Example:**

`LAY:WIND2:REPL MTAB`

Replaces the result display in window 2 with a marker table.

**Usage:**

Setting only

**LAYout:WINDow<n>:TYPE <WindowType>**

Queries or defines the window type of the window specified by the index <n>. The window type determines which results are displayed. For a list of possible window types, see `LAYout:ADD[:WINDow]?` on page 1100.

Note that this command is not available in all applications and measurements.

**Suffix:**

<n> 1..n  
[Window](#)

**Parameters:**

<WindowType>

**Example:**

`LAY:WIND2:TYPE?`

### 13.6.3 Examples: configuring the result display

The following example demonstrates how to configure result displays in a remote environment.

#### 13.6.3.1 Example 1: adding and arranging windows

Starting from the default initial display in the Spectrum application (Frequency Sweep), we will configure the following result displays:

1 Frequency Sweep	3 "Marker Table"
2 Spectrogram	4 "Marker Peak List"

## Configuring the result display

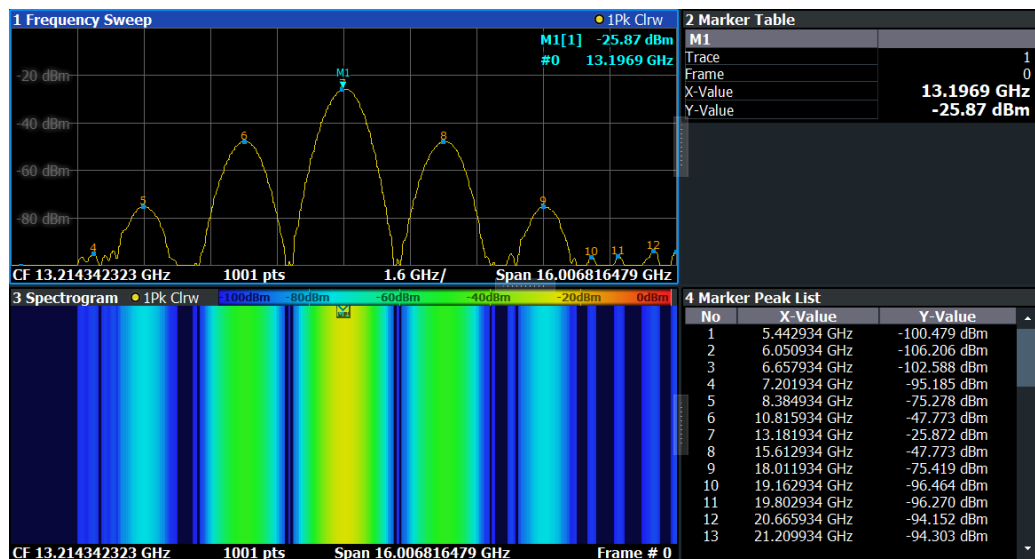

```
//-----Resetting the instrument -----
*RST

//----- Adding new windows -----
//Add a Spectrogram window beneath the Frequency Sweep window
LAY:ADD? '1',BEL,SGR
//Result: window number: '2'
//Add a Marker Table window to the right of the Frequency Sweep window
LAY:ADD? '1',RIGH,MTAB
//Result: window number: '3'
//Add a Marker Peak List window to the right of the Spectrogram window
LAY:WIND2:ADD? RIGH,PEAK
//Result: window number: '4'

//----- Changing the size of individual windows -----
//Move the splitter between the Frequency Sweep window and the Marker Table
//window to enlarge the spectrum display to 60% of the entire width.
LAY:SPL 1,3,60
//Move the splitter between the Spectrogram window and the Marker Peak List
//window to enlarge the Spectrogram display to 60% of the entire width.
LAY:SPL 2,4,60

//----- Querying all displayed windows -----
//Query the name and number of all displayed windows
//(from top left to bottom right)
LAY:CAT?
//Result : '1',1,'2',2,'3',3,'4',4

//----- Maximizing a Window -----
//Maximize the window "2 Spectrogram"
DISP:WIND2:SIZE LARG
```

## Configuring the result display

```
//-----Restore multiple window display -----
DISP:WIND2:SIZE SMAL
```

### 13.6.3.2 Example 2: replacing and removing windows

Starting from the display configured in [Example 1: adding and arranging windows](#), we will remove and replace result displays to obtain the following configuration:

1 Frequency Sweep
4 "Marker Table"

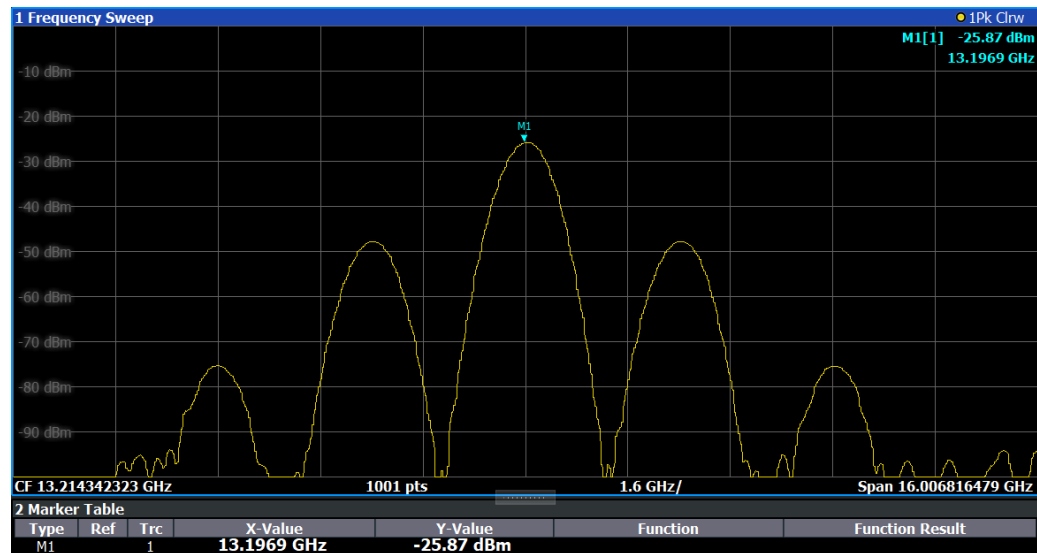

```
//----- Preparing the configuration from example 1 -----
*RST
LAY:ADD? '1',BEL,SGR
LAY:ADD? '1',RIGH,MTAB
LAY:WIND2:ADD? RIGH,PEAK
LAY:CAT?
//Result : '1',1,'2',2,'3',3,'4',4
//Remove Spectrogram
LAY:WIND2:REM //Remove Marker Table window
LAY:REM '3'
//Replace Marker Peak List window by Marker Table
LAY:REPL '4',MTAB

//----- Querying all displayed windows -----
//Query the name and number of all displayed windows (from top left to bottom right)
LAY:CAT?
//Result : '1',1,'4',4
```

```
//----- Changing the size of individual windows -----
//Move the splitter between the Frequency Sweep window and the Marker Table window
//to enlarge the spectrum display to 80% of the entire height.
LAY:SPL 1,4,80
```

## 13.7 Setting basic measurement parameters

All commands that set measurement-independent parameters are described here.

- [Configuring the data input and output](#)..... 1109
- [Defining the frequency and span](#)..... 1190
- [Configuring bandwidth and sweep settings](#)..... 1197
- [Configuring the vertical axis \(amplitude, scaling\)](#)..... 1206
- [Configuring triggered and gated measurements](#)..... 1217
- [Adjusting settings automatically](#)..... 1232

### 13.7.1 Configuring the data input and output

The following commands are required to configure data input and output.

- [RF input](#)..... 1109
- [Remote commands for external frontend control](#)..... 1115
- [Configuring digital I/Q input and output](#)..... 1139
- [Configuring input via the optional Analog Baseband interface](#)..... 1141
- [Using external mixers](#)..... 1144
- [Setting up probes](#)..... 1159
- [External generator control](#)..... 1165
- [Working with power sensors](#)..... 1176
- [Configuring the outputs](#)..... 1187

#### 13.7.1.1 RF input

<a href="#">CALibration:PADJust[:STATe]</a> .....	1110
<a href="#">INPut:ATTenuation:PROTection:RESet</a> .....	1110
<a href="#">INPut:CONNector</a> .....	1110
<a href="#">INPut:COUPling</a> .....	1110
<a href="#">INPut:DPATH</a> .....	1111
<a href="#">INPut:FILTer:HPASs[:STATe]</a> .....	1111
<a href="#">INPut:FILTer:YIG[:STATe]</a> .....	1112
<a href="#">INPut:IMPedance</a> .....	1112
<a href="#">INPut:IMPedance:PTYPE</a> .....	1112
<a href="#">INPut:SELEct</a> .....	1113
<a href="#">INPut:TYPE</a> .....	1114
<a href="#">INPut:UPORt:STATe</a> .....	1114
<a href="#">INPut:UPORt[:VALue]</a> .....	1114

**CALibration:PADJust[:STATe]**

Activates or deactivates the preselector adjustment.

Is only available for instrument models FSW43/50/67, for frequency sweeps in the Spectrum application.

**Parameters:**

<State>                    ON | OFF | 0 | 1  
                               **OFF | 0**  
                               Switches the function off  
                               **ON | 1**  
                               Switches the function on

**Manual operation:** See "[Preselector Adjust](#)" on page 366

**INPut:ATTenuation:PROTection:RESet**

Resets the attenuator and reconnects the RF input with the input mixer for the FSW after an overload condition occurred and the protection mechanism intervened. The error status bit (bit 3 in the `STAT:QUES:POW` status register) and the `INPUT OVLD` message in the status bar are cleared.

(See `STATus:QUEStionable:POWer[:EVENT]?` on page 1479 and [Chapter 12.2.2.12, "STATus:QUEStionable:POWer register"](#), on page 832).

The command works only if the overload condition has been eliminated first.

For details on the protection mechanism, see "[RF Input Protection](#)" on page 363.

**Example:**                    `INP:ATT:PROT:RES`

**INPut:CONNector <ConnType>**

Determines which connector the input for the measurement is taken from.

If an external frontend is active, the connector is automatically set to `RF`.

**Parameters:**

<ConnType>                **RF**  
                               RF input connector  
                               **RFProbe**  
                               Active RF probe  
                               \*RST:        RF

**Example:**                    `INP:CONN RF`  
                               Selects input from the RF input connector.

**Manual operation:** See "[Input Connector](#)" on page 366

**INPut:COUPling <CouplingType>**

Selects the coupling type of the RF input.

If an external frontend is active, the coupling is automatically set to AC.

**Parameters:**

<CouplingType> AC | DC  
**AC**  
 AC coupling  
**DC**  
 DC coupling  
 \*RST: AC

**Example:** INP:COUP DC

**Manual operation:** See "[Input Coupling](#)" on page 364

**INPut:DPATH** <DirectPath>

Enables or disables the use of the direct path for frequencies close to 0 Hz.

If an external frontend is active, the direct path is always used.

**Parameters:**

<DirectPath> AUTO | OFF  
**AUTO | 1**  
 (Default) the direct path is used automatically for frequencies close to 0 Hz.  
**OFF | 0**  
 The analog mixer path is always used.

**Example:** INP:DPAT OFF

**Manual operation:** See "[Direct Path](#)" on page 365

**INPut:FILTer:HPASs[:STATe]** <State>

Activates an additional internal high-pass filter for RF input signals from 1 GHz to 3 GHz. This filter is used to remove the harmonics of the FSW to measure the harmonics for a DUT, for example.

Requires an additional high-pass filter hardware option.

(Note: for RF input signals outside the specified range, the high-pass filter has no effect. For signals with a frequency of approximately 4 GHz upwards, the harmonics are suppressed sufficiently by the YIG-preselector, if available.)

**Parameters:**

<State> ON | OFF | 0 | 1  
**OFF | 0**  
 Switches the function off  
**ON | 1**  
 Switches the function on  
 \*RST: 0

**Example:** `INP:FILT:HPAS ON`  
Turns on the filter.

**Manual operation:** See ["High Pass Filter 1 to 3 GHz"](#) on page 365

#### **INPut:FILTer:YIG[:STATE] <State>**

Enables or disables the YIG filter.

For details and restrictions, see ["YIG-Preselector"](#) on page 365

**Parameters:**

<State> ON | OFF | 0 | 1

**Example:** `INP:FILT:YIG OFF`  
Deactivates the YIG-preselector.

**Manual operation:** See ["YIG-Preselector"](#) on page 365

#### **INPut:IMPedance <Impedance>**

Selects the nominal input impedance of the RF input. In some applications, only 50  $\Omega$  are supported.

**Parameters:**

<Impedance> 50 | 75

**numeric value**

User-defined impedance from 50 Ohm to 100000000 Ohm (=100 MOhm)

User-defined values are only available for the Spectrum application, the I/Q Analyzer, and some optional applications. (In MSRA mode, primary only)

\*RST: 50  $\Omega$

Default unit: OHM

**Example:** `INP:IMP 75`

**Manual operation:** See ["Impedance"](#) on page 364  
See ["Unit"](#) on page 485

#### **INPut:IMPedance:PTYPe <PadType>**

Defines the type of matching pad used for impedance conversion for RF input.

**Parameters:**

<PadType> SRESistor | MLPad

**SRESistor**

Series-R

**MLPad**

Minimum Loss Pad

\*RST: SRESistor



**Example:**            `INP:IMP 100`  
                       `INP:IMP:PTYP MLP`

**Manual operation:** See "[Impedance](#)" on page 364

### **INPut:SElect** <Source>

Selects the signal source for measurements, i.e. it defines which connector is used to input data to the FSW.

If no additional input options are installed, only RF input is supported.

For FSW85 models with two RF input connectors, you must select the input connector to configure first using `INPut:TYPE`.

#### **Parameters:**

<Source>

#### **OBB**

Oscilloscope Baseband signal

For details on Oscilloscope Baseband Input see the FSW I/Q Analyzer User Manual.

Not available for Input2.

#### **RF**

Radio Frequency ("RF INPUT" connector)

#### **FIQ**

I/Q data file

Not available for Input2.

#### **DIQ**

Digital IQ data (only available with optional "Digital Baseband" interface)

For details on I/Q input see the FSW I/Q Analyzer User Manual.  
 Not available for Input2.

#### **AIQ**

Analog Baseband signal (only available with optional "Analog Baseband" interface)

For details on Analog Baseband input, see the FSW I/Q Analyzer User Manual.

Not available for Input2.

\*RST:        RF

**Example:**            `INP:TYPE INP1`  
                       For FSW85 models with two RF input connectors: selects the  
                       1.00 mm RF input connector for configuration.  
                       `INP:SEL RF`

**Manual operation:** See "[Radio Frequency State](#)" on page 363

---

**INPut:TYPE** <Input>

The command selects the input path.

**Parameters:**

&lt;Input&gt;

**INPUT1**

Selects RF input 1.

1 mm [RF Input] connector

**INPUT2**

Selects RF input 2.

For FSW85 models with two RF input connectors:

1.85 mm [RF2 Input] connector

For all other models: not available

\*RST: INPUT1

**Example:**

```
//Select input path
INP:TYPE INPUT1
```

**Manual operation:** See "[Radio Frequency State](#)" on page 363

---

**INPut:UPORt:STATe** <State>

Toggles the control lines of the user ports for the **AUX PORT** connector. This SUB-D male connector is located on the rear panel of the FSW.

See the FSW Getting Started manual for details.

**Parameters:**

&lt;State&gt;

**ON | 1**

User port is switched to INPut

**OFF | 0**

User port is switched to OUTPut

\*RST: 1

---

**INPut:UPORt[:VALue]**

Queries the control lines of the user ports.

For details see [OUTPut:UPORt\[:VALue\]](#) on page 1189.

**Return values:**

&lt;Level&gt;

bit values in hexadecimal format

TTL type voltage levels (max. 5V)

Range: #B00000000 to #B00111111

**Example:**

```
INP:UPOR?
//Result: #B00100100
Pins 5 and 7 are active.
```

### 13.7.1.2 Remote commands for external frontend control

The following commands are available and required only if the external frontend control option (R&S FSW-K553) is installed.

Further commands for external frontend control described elsewhere:

- `INPut:SElect RF`; see `INPut:SElect` on page 1113
- `[SENSe:]FREQuency:CENTer` on page 1192
- `DISPlay[:WINDow<n>][:SUBWindow<w>]:TRACe<t>:Y[:SCALe]:RLEVel` on page 1207
- `INPut:ATTenuation:AUTO` on page 1210
- `INPut:ATTenuation` on page 1209
- `INPut:SANalyzer:ATTenuation:AUTO` on page 1212
- `SYSTem:ERRor[:NEXT]?` on page 1450
- [Commands for initial configuration](#)..... 1115
- [Commands for test, alignment, and diagnosis](#)..... 1125
- [Commands for external devices](#)..... 1127
- [Format of selftest result file](#)..... 1131
- [Programming example: Configuring an external frontend](#)..... 1136
- [Programming example 2: Configuring an external frontend with a connected amplifier](#)..... 1137

#### Commands for initial configuration

The following commands are required when you initially set up an external frontend.

<code>[SENSe:]EFRontend:CONNection[:STATe]</code> .....	1116
<code>[SENSe:]EFRontend:CONNection:CONFig</code> .....	1116
<code>[SENSe:]EFRontend:CONNection:CSTate?</code> .....	1117
<code>[SENSe:]EFRontend:FREQuency:BAND:COUNT?</code> .....	1117
<code>[SENSe:]EFRontend:FREQuency:BAND&lt;b&gt;:LOWer?</code> .....	1117
<code>[SENSe:]EFRontend:FREQuency:BAND&lt;b&gt;:UPPer?</code> .....	1118
<code>[SENSe:]EFRontend:FREQuency:BCONfig:AUTO</code> .....	1118
<code>[SENSe:]EFRontend:FREQuency:BCONfig:LIST?</code> .....	1119
<code>[SENSe:]EFRontend:FREQuency:BCONfig:SElect</code> .....	1119
<code>[SENSe:]EFRontend:FREQuency:IFRequency:MAXimum?</code> .....	1120
<code>[SENSe:]EFRontend:FREQuency:IFRequency:MINimum?</code> .....	1120
<code>[SENSe:]EFRontend:FREQuency:IFRequency:SIDeband?</code> .....	1120
<code>[SENSe:]EFRontend:FREQuency:IFRequency[:VALue]?</code> .....	1121
<code>[SENSe:]EFRontend:FREQuency:LOSCillator:INPut:FREQuency?</code> .....	1121
<code>[SENSe:]EFRontend:FREQuency:LOSCillator:MODE</code> .....	1121
<code>[SENSe:]EFRontend:FREQuency:LOSCillator:OUTPut:FREQuency?</code> .....	1122
<code>[SENSe:]EFRontend:FREQuency:LOSCillator:OUTPut:STATe</code> .....	1122
<code>[SENSe:]EFRontend:FREQuency:REFerence</code> .....	1123
<code>[SENSe:]EFRontend:FREQuency:REFerence:LIST?</code> .....	1123
<code>[SENSe:]EFRontend:IDN?</code> .....	1123
<code>[SENSe:]EFRontend:NETWork</code> .....	1123
<code>[SENSe:]EFRontend[:STATe]</code> .....	1124

---

**[SENSe:]EFRontend:CONNection[:STate]** <State>

Queries the external frontend connection state in the firmware.

Note: to query the physical connection state of the external frontend, use [\[SENSe:\]EFRontend:CONNection:CSTate?](#) on page 1117.

**Parameters:**

<State>

ON | OFF | 0 | 1

**OFF | 0**

The connection to the frontend is deactivated temporarily. The frontend is thus available for use elsewhere, for example by a signal generator. The measurement settings on the FSW remain untouched.

**ON | 1**

Frontend connection enabled.

The frontend is reserved for exclusive use by the FSW.

\*RST: 0

**Example:**

```
//Global activation of external frontend
EFR ON
//Configure frontend
EFR:CONN:CONF "FE44S", "123.456.789"
//Activate exclusive use of frontend by FSW.
EFR:CONN ON
```

**Manual operation:** See ["External Frontend Connection State"](#) on page 450

---

**[SENSe:]EFRontend:CONNection:CONFig** <Type>, <IPAddress>[, <DeviceID>, <SymbolicName>]

Configures the connection to the external frontend.

**Parameters:**

<Type>

| "FE44S" | "FE50DTR" | "FE170SR" | "FE110SR"

String in double quotes containing the type of frontend to be connected.

<IPAddress>

string in double quotes

The IP address or computer name of the frontend connected to the FSW via LAN. The IP address and computer name are indicated on the electronic ink display on the side panel of the frontend.

<DeviceID>

string in double quotes

Unique device ID consisting of <type>-<serialnumber>  
Not required or relevant for the FSW.

<SymbolicName>

string in double quotes

Symbolic name of the external frontend.  
Not required or relevant for the FSW.

## Setting basic measurement parameters

**Example:**

```
//Global activation of external frontend
EFR ON
//Configure frontend
EFR:CONN:CONF "FE44S","123.456.789"
//Activate exclusive use of frontend by FSW.
EFR:CONN ON
```

**Manual operation:** See ["Frontend Type"](#) on page 451  
See ["IP Address/ Computer Name"](#) on page 451

**[SENSe:]EFRontend:CONNECTION:CState?**

Queries the status of the physical connection to the external frontend.

**Return values:**

<State> ON | OFF | 0 | 1  
**OFF | 0**  
Frontend not connected; connection error  
**ON | 1**  
Frontend connected

**Usage:** Query only

**Manual operation:** See ["External Frontend Connection State"](#) on page 450

**[SENSe:]EFRontend:FREQUENCY:BAND:COUNT?**

Queries the number of frequency bands provided by the selected frontend.

**Return values:**

<NoBands> integer  
Number of frequency bands

**Example:**

```
//Query number of frequency bands
EFR:FREQ:BAND:COUN?
//Result: 2
```

**Usage:** Query only

**Manual operation:** See ["Frequency Band"](#) on page 453

**[SENSe:]EFRontend:FREQUENCY:BAND<b>:LOWer?**

Queries the start of the frequency range supported by the selected frontend frequency band.

**Suffix:**

<b> 1..n  
Band for multi-band frontends  
Use [\[SENSe:\]EFRontend:FREQUENCY:BAND:COUNT?](#)  
on page 1117 to determine the number of available bands.

**Return values:**

<StartFreq> Start frequency of the specified band

**Example:**

```
//Query start frequency of second band
EFR:FREQ:BAND2:LOW?
//Result: 24000000000
```

**Usage:**

Query only

**Manual operation:** See "[Frequency Band](#)" on page 453

**[SENSe:]EFRontend:FREQUENCY:BAND<b>:UPPer?**

Queries the end of the frequency range supported by the selected frontend frequency band.

**Suffix:**

<b> 1..n  
Band for multi-band frontends  
Use [\[SENSe:\]EFRontend:FREQUENCY:BAND:COUNT?](#)  
on page 1117 to determine the number of available bands.

**Return values:**

<StopFreq> End frequency of the specified band

**Example:**

```
//Query end frequency of second band
EFR:FREQ:BAND2:UPP?
//Result: 44000000000
```

**Usage:**

Query only

**Manual operation:** See "[Frequency Band](#)" on page 453

**[SENSe:]EFRontend:FREQUENCY:BCONfig:AUTO <State>**

Determines whether the frequency band of the external frontend is configured automatically or manually.

**Parameters:**

<State> ON | OFF | 0 | 1  
**OFF | 0**  
Uses the frequency band configured by [\[SENSe:\]EFRontend:FREQUENCY:BCONfig:SElect](#) on page 1119.  
**ON | 1**  
Configures the frequency band automatically  
Currently, auto mode always applies the "IF Low" range.  
\*RST: 1

**Example:**

```
//Configures the use of the IF high band manually.
EFR:FREQ:BCON:AUTO 0
EFR:FREQ:BCON:SEL "IF HIGH"
```

**Manual operation:** See "[Frequency Band Configuration](#)" on page 452

**[SENSe:]EFRontend:FREQUENCY:BCONfig:LIST?**

Returns the intermediate frequency (output) range of the external frontend.

**Return values:**

<BandConfigs>	string
	<b>"IF LOW"</b>
	(Not for R&S FE170SR/R&S FE110SR frontends.) A higher intermediate frequency is used on the external frontend, resulting in a higher input frequency at the FSW.
	<b>"IF HIGH"</b>
	(Not for R&S FE170SR/R&S FE110SR frontends.) A lower intermediate frequency is used on the external frontend, resulting in a lower input frequency at the FSW.
	<b>"Spur Optimized"</b>
	The selected IF range avoids unwanted spurious effects.
	<b>"EVM Optimized"</b>
	The selected IF range provides an optimal EVM result.

**Example:**

```
EFR:FREQ:BCON:LIST?
//Result: "IF HIGH", "IF LOW"
EFR:FREQ:BCON:SEL "IF HIGH"
```

**Usage:** Query only

**Manual operation:** See ["Frequency Band Configuration"](#) on page 452

**[SENSe:]EFRontend:FREQUENCY:BCONfig:SElect <BandConfig>**

Defines the intermediate frequency (output) range of the external frontend.

**Parameters:**

<BandConfig>	<b>"IF HIGH"</b>
	(R&S FE44S/ R&S FE50DTR) A higher intermediate frequency is used on the external frontend, resulting in a higher input frequency at the FSW.
	<b>"IF LOW"</b>
	(R&S FE44S/ R&S FE50DTR) A lower intermediate frequency is used on the external frontend, resulting in a lower input frequency at the FSW.
	<b>"Spur Optimized"</b>
	(R&S FE170SR/R&S FE110SR only) The selected IF range avoids unwanted spurious effects.
	<b>"EVM Optimized"</b>
	(R&S FE170SR/R&S FE110SR only) The selected IF range provides an optimal EVM result.

**"Shared LO"**

(R&amp;S FE170SR/R&amp;S FE110SR only)

Ensures that multiple external frontends (R&S FE170SR/R&S FE170ST or R&S FE110SR/R&S FE110ST) use the same LO frequencies for upconversion and downconversion.

**Example:**

```
EFR:FREQ:BCON:LIST?
//Result: "IF HIGH", "IF LOW"
EFR:FREQ:BCON:SEL "IF HIGH"
```

**Manual operation:** See ["Frequency Band Configuration"](#) on page 452

**[SENSe:]EFRontend:FREQuency:IFRequency:MAXimum?**

Queries the maximum used intermediate frequency (IF) for frequency conversion for a frequency span.

**Return values:**

<IFFrequency> numeric

**Example:**

```
EFR:FREQ:IFR:MAX?
```

**Usage:**

Query only

**Manual operation:** See ["Intermediate Frequency"](#) on page 454

**[SENSe:]EFRontend:FREQuency:IFRequency:MINimum?**

Queries the minimum used intermediate frequency (IF) for frequency conversion for a frequency span.

**Return values:**

<IFFrequency> numeric

**Example:**

```
EFR:FREQ:IFR:MIN?
```

**Usage:**

Query only

**Manual operation:** See ["Intermediate Frequency"](#) on page 454

**[SENSe:]EFRontend:FREQuency:IFRequency:SIDeband?**

Queries the currently used sideband for frequency conversion.

**Return values:**

<Sideband> "USB" | "LSB"  
**"USB"**  
 Upper sideband  
**"LSB"**  
 Lower sideband

**Example:**

```
EFR:FREQ:IFR?
EFR:FREQ:IFR:SID?
```



**Usage:** Query only  
**Manual operation:** See "[Intermediate Frequency](#)" on page 454

#### [SENSe:]EFRontend:FREQuency:IFRequency[:VALue]?

Queries the currently used intermediate frequency (IF) for frequency conversion.

To query the maximum and minimum IF for the selected frequency range, use [\[SENSe:\]EFRontend:FREQuency:IFRequency:MAXimum?](#) on page 1120 and [\[SENSe:\]EFRontend:FREQuency:IFRequency:MINimum?](#) on page 1120.

**Return values:**

<IFFrequency> numeric

**Example:** EFR:FREQ:IFR?

**Usage:** Query only

**Manual operation:** See "[Intermediate Frequency](#)" on page 454

#### [SENSe:]EFRontend:FREQuency:LOSCillator:INPut:FREQuency?

Queries the frequency of the LO input for [\[SENSe:\]EFRontend:FREQuency:LOSCillator:MODE](#) EXT.

**Return values:**

<LOInFreq> Default unit: Hz

**Example:** The external frontend uses the external LO provided at the "LO IN" connector.

```
EFR:FREQ:LOSC:MODE EXT
```

Query the frequency that the external LO must be provided at.

```
EFR:FREQ:LOSC:INP:FREQ?
```

```
//Result: 10615000000
```

**Usage:** Query only

**Manual operation:** See "[Mandatory LO IN Frequency](#)" on page 455

#### [SENSe:]EFRontend:FREQuency:LOSCillator:MODE <Type>

Determines whether the external frontend uses its internal LO or an external LO.

**Parameters:**

<Type> EXTernal | INTernal

**EXTernal**

Uses the external LO provided at the LO input connector of the external frontend. Query the frequency at which the LO must be input to the external frontend using [\[SENSe:\]EFRontend:FREQuency:LOSCillator:INPut:FREQuency?](#) on page 1121.

**INTernal**

Uses the internal LO.

\*RST: EXTernal

**Example:**

```
EFR:FREQ:LOSC:MODE EXT
EFR:FREQ:LOSC:INP:FREQ?
//Result: 10615000000
```

**Manual operation:** See "[LO Mode](#)" on page 454

**[SENSe:]EFRontend:FREQUENCY:LOSCillator:OUTPut:FREQUENCY?**

Queries the frequency of the LO output for `[SENSe:]EFRontend:FREQUENCY:LOSCillator:OUTPut:STATe ON`.

**Return values:**

<LOOutFreq> Default unit: Hz

**Example:**

The external frontend uses the internal LO and provides it as output to the "LO OUT" connector.

```
EFR:FREQ:LOSC:MODE INT
EFR:FREQ:LOSC:OUTP:STAT ON
Query the frequency of the LO output.
EFR:FREQ:LOSC:OUTP:FREQ?
//Result: 10615000000
```

**Usage:** Query only

**Manual operation:** See "[LO OUT Frequency](#)" on page 455

**[SENSe:]EFRontend:FREQUENCY:LOSCillator:OUTPut:STATe <State>**

Enables or disables output of the LO by the external frontend. The output frequency is returned by `[SENSe:]EFRontend:FREQUENCY:LOSCillator:OUTPut:FREQUENCY?` on page 1122.

**Parameters:**

<State> ON | OFF | 0 | 1  
**OFF | 0**  
 Switches the function off  
**ON | 1**  
 Switches the function on  
 \*RST: 0

**Example:**

The external frontend provides the LO as output at the "LO OUT" connector.

```
EFR:FREQ:LOSC:OUTP:STAT ON
Query the frequency of the LO output.
EFR:FREQ:LOSC:OUTP:FREQ?
//Result: 10615000000
```

**Manual operation:** See "[LO Out State](#)" on page 454

**[SENSe:]EFRontend:FREQUENCY:REference <Frequency>**

Sets the reference frequency that is used for frequency conversion on the frontend. Depending on the connected type of frontend, different values are available. To determine which reference levels are available, use [\[SENSe:\]EFRontend:FREQUENCY:REference:LIST?](#) on page 1123.

**Parameters:**

<Frequency>            Default unit: HZ

**Example:**

```
//Query the available reference levels
EFR:FREQ:REF:LIST?
//Result: 10000000,640000000,1000000000
//Use 640 MHz reference
EFR:FREQ:REF 640000000
```

**Manual operation:** See ["Reference Frequency"](#) on page 453

**[SENSe:]EFRontend:FREQUENCY:REference:LIST?**

Queries the available reference signals for the connected frontend type.

**Return values:**

<References>            10000000 | 640000000 | 1000000000

**Example:**

```
//Query the available reference levels
EFR:FREQ:REF:LIST?
//Result: 10000000,640000000,1000000000
//Use 640 MHz reference
EFR:FREQ:REF 640000000
```

**Usage:**

Query only

**Manual operation:** See ["Reference Frequency"](#) on page 453

**[SENSe:]EFRontend:IDN?**

Queries the device identification information (\*IDN?) of the frontend.

**Return values:**

<DevInfo>                string without quotes  
Rohde&Schwarz,<device type>,<part number>/<serial number>,<firmware version>

**Example:**

```
EFR:IDN?
//Result: Rohde&Schwarz,FE44S,
1234.5678K00/123456,0.8.0
```

**Usage:**

Query only

**[SENSe:]EFRontend:NETWork <IPAddress>, <Subnet>, <DHCP State>**

Sets or queries the network information for the frontend.

## Setting basic measurement parameters

This information is also indicated on the electronic paper display on the side panel of the device.

Beware that if you change the network setting to DHCP = ON, the connection is aborted and you must re-establish a connection to the frontend (see [\[SENSe:\]EFRontend:CONNECTION\[:STATe\]](#) on page 1116).

**Parameters:**

<IPAddress>	string in double quotes IP address of the frontend
<Subnet>	string in double quotes Subnet mask of the frontend
<DHCP State>	ON   OFF   0   1 Indicates whether a DHCP server is used. <b>OFF   0</b> DHCP off <b>ON   1</b> DHCP on *RST: 0

**Example:**

```
EFR:NETW?
//Result: "123.456.78.90", "255.255.255.0", ON
```

**Manual operation:**

See ["IP Address"](#) on page 457  
See ["Subnet Mask"](#) on page 457  
See ["DHCP"](#) on page 457  
See ["Apply Network Settings"](#) on page 457

**[SENSe:]EFRontend[:STATe] <State>**

Enables or disables the general use of an external frontend for the application.

For details, see ["Global activation"](#) on page 450.

**Parameters:**

<State>	ON   OFF   0   1 <b>OFF   0</b> The frontend is disconnected. The application adapts the measurement settings to the common settings supported by the FSW. <b>ON   1</b> The FSW allows you to configure and connect an external frontend for the application. The application adapts the available measurement settings to the connected frontend. The channel bar indicates "Inp: ExtFe". *RST: 0
---------	--------------------------------------------------------------------------------------------------------------------------------------------------------------------------------------------------------------------------------------------------------------------------------------------------------------------------------------------------------------------------------------------------------------------

**Example:**

```
EFR ON
```

**Manual operation:**

See ["Global activation"](#) on page 450

### Commands for test, alignment, and diagnosis

The following commands are required to test and optimize the connection after it has initially been set up.

[SENSe:]EFRontend:ALIGnment<ch>:FILE.....	1125
[SENSe:]EFRontend:ALIGnment<ch>:STATe.....	1125
[SENSe:]EFRontend:FWUPdate.....	1126
[SENSe:]EFRontend<fe>:SELfTest?.....	1126
[SENSe:]EFRontend<fe>:SELfTest:RESult?.....	1126

---

#### [SENSe:]EFRontend:ALIGnment<ch>:FILE <File>

Selects or queries the touchstone file that contains correction data to compensate for signal losses in the cable occurring at different IF signal frequencies.

##### Suffix:

<ch>                    1..n  
 Currently irrelevant

##### Parameters:

<File>                    string in double quotes  
 Path and file name of the correction data file. The file must be in s2p format.  
 If the specified file is not found or does not have the correct format, an error message is returned (-256, "File name not found", -150, "String data error").

**Example:**                    EFR:ALIG:FILE "FE44S.s2p"

**Manual operation:**    See "[Load Cable Correction S2P File](#)" on page 455

---

#### [SENSe:]EFRontend:ALIGnment<ch>:STATe <State>

Activates correction of the IF signal due to cable loss from the frontend to the analyzer. Specify the file with correction data using [SENSe:]EFRontend:ALIGnment<ch>:FILE on page 1125.

##### Suffix:

<ch>                    1..n  
 Currently irrelevant

##### Parameters:

<State>                    ON | OFF | 0 | 1  
**OFF | 0**  
 Switches the function off  
**ON | 1**  
 Switches the function on  
 \*RST:                    0

**Manual operation:**    See "[Correction State](#)" on page 455

---

**[SENSe:]EFRontend:FWUpdate**

Updates the firmware on the external frontend. Note that this process can take some time.

**Usage:** Event

**Manual operation:** See "[FW Update](#)" on page 451

---

**[SENSe:]EFRontend<fe>:SELFtest?**

Performs a selftest on the frontend to compare the current performance and characteristic values with the specified values for the frontend.

As a result, the success is returned.

**Suffix:**

<fe> 1  
Connected frontend

**Return values:**

<Result> 0  
No error  
>0  
Error  
\*RST: 0

**Example:** EFR:SELF?  
//Result: 0

**Usage:** Query only

**Manual operation:** See "[Start Selftest](#)" on page 456

---

**[SENSe:]EFRontend<fe>:SELFtest:RESult?**

Queries the results of the selftest on the frontend.

**Suffix:**

<fe> 1  
Connected frontend

**Return values:**

<Result> string containing xml data in double quotes  
For details, see "[Format of selftest result file](#)" on page 1131.

**Example:** EFR:SELF:RES?  
For details, see "[Format of selftest result file](#)" on page 1131.

**Usage:** Query only

**Manual operation:** See "[Selftest Results](#)" on page 456

---

### Commands for external devices

You can insert additional external devices in the signal path between the DUT and the external frontend, such as preamplifiers or filters. The external frontend must then consider the additional gain or correction values.

[SENSe:]EFRontend[:CHANnel<ch>]:EXTDevice<di>:CORRection:FILE.....	1127
[SENSe:]EFRontend[:CHANnel<ch>]:EXTDevice<di>:CORRection:STATe.....	1127
[SENSe:]EFRontend[:CHANnel<ch>]:EXTDevice<di>:CORRection:VALid?.....	1128
[SENSe:]EFRontend[:CHANnel<ch>]:EXTDevice<di>:LIST?.....	1128
[SENSe:]EFRontend[:CHANnel<ch>]:EXTDevice<di>:REFResh.....	1129
[SENSe:]EFRontend[:CHANnel<ch>]:EXTDevice<di>:FREQuency:MAXimum?.....	1129
[SENSe:]EFRontend[:CHANnel<ch>]:EXTDevice<di>:FREQuency:MINimum?.....	1130
[SENSe:]EFRontend[:CHANnel<ch>]:EXTDevice<di>:GAIN?.....	1130
[SENSe:]EFRontend[:CHANnel<ch>]:EXTDevice<di>:NAME?.....	1130
[SENSe:]EFRontend[:CHANnel<ch>]:EXTDevice<di>:TYPE?.....	1131

---

#### [SENSe:]EFRontend[:CHANnel<ch>]:EXTDevice<di>:CORRection:FILE <File>

Defines the correction file to compensate for signal losses by the external devices occurring at different IF signal frequencies.

To query whether the loaded file is valid or not, use [SENSe:]EFRontend[:CHANnel<ch>]:EXTDevice<di>:CORRection:VALid? on page 1128.

#### Suffix:

<ch>	1..n For future use.
<di>	1..n irrelevant

#### Parameters:

<File>

**Example:**           SENS:EFR:CHAN:EXTD:CORR:FILE 'ExtDev\_Corr.s2p'  
                      SENS:EFR:CHAN:EXTD:CORR:STAT ON  
                      SENS:EFR:CHAN:EXTD:CORR:FILE:VAL?

**Manual operation:** See "Load S2P File" on page 459

---

#### [SENSe:]EFRontend[:CHANnel<ch>]:EXTDevice<di>:CORRection:STATe <State>

Enables or disables the use of a correction file for the connected external devices. The file is defined by [SENSe:]EFRontend[:CHANnel<ch>]:EXTDevice<di>:CORRection:FILE on page 1127.

#### Suffix:

<ch>	1..n For future use.
------	-------------------------

## Setting basic measurement parameters

<di> 1..n  
irrelevant

**Parameters:**

<State> ON | OFF | 0 | 1  
**OFF | 0**  
Switches the function off  
**ON | 1**  
Switches the function on  
\*RST: 0

**Example:** SENS:EFR:CHAN:EXTD:CORR:FILE 'ExtDev\_Corr.s2p'  
SENS:EFR:CHAN:EXTD:CORR:STAT ON

**Manual operation:** See "[Correction State](#)" on page 459

**[SENSe:]EFRontend[:CHANnel<ch>]:EXTDevice<di>:CORRection:VALid?**

Queries whether the loaded correction file for an external device is valid or not.

**Suffix:**

<ch> 1..n  
For future use.

<di> 1..n  
irrelevant

**Return values:**

<Result> ON | OFF | 0 | 1  
**OFF | 0**  
File is valid.  
**ON | 1**  
File is not valid.

**Example:** SENS:EFR:CHAN:EXTD:CORR:STAT ON  
SENS:EFR:CHAN:EXTD:CORR:FILE 'ExtDev\_Corr.s2p'  
SENS:EFR:CHAN:EXTD:CORR:VAL?

**Usage:** Query only

**Manual operation:** See "[Load S2P File](#)" on page 459

**[SENSe:]EFRontend[:CHANnel<ch>]:EXTDevice<di>:LIST?**

Queries the names of all detected connected devices at the external frontend.

**Suffix:**

<ch> 1..n  
For future use.

<di> 1..n  
irrelevant



## Setting basic measurement parameters

**Return values:**  
 <Devices> Comma-separated list of the names of the devices.

**Example:**           :SENSe1:EFRontend1:CHANnel1:EXTDevice1:LIST?  
 //Result:  
 //"fe170\_z50", "fe170\_z01"

**Usage:**            Query only

**Manual operation:** See ["Name"](#) on page 458

**[SENSe:]EFRontend[:CHANnel<ch>]:EXTDevice<di>:REFresh**

Scans the ports of the external frontend and refreshes the display with detected information on connected devices. This function is useful after connecting a new device to the frontend.

**Suffix:**

<ch>                   1..n  
 For future use.

<di>                   1..n  
 irrelevant

**Example:**           SENSe1:EFRontend1:CHANnel:EXTDevice1:REFresh

**Usage:**            Event

**Manual operation:** See ["Refresh External Devices"](#) on page 459

**[SENSe:]EFRontend[:CHANnel<ch>]:EXTDevice<di>:FREQuency:MAXimum?**

Queries the upper limit of the supported frequency range of the connected device.

**Suffix:**

<ch>                   1..n  
 For future use.

<di>                   1..n  
 Connected external device

**Return values:**  
 <RFFrequency>       numeric value  
 Maximum frequency  
 Default unit: Hz

**Example:**           SENS:EFR:EXTD1:FREQ:MAX?  
 //Result:  
 1700000000000

**Usage:**            Query only

**Manual operation:** See ["Frequency Range"](#) on page 459

---

**[SENSe:]EFRontend[:CHANnel<ch>]:EXTDevice<di>:FREQUENCY:MINimum?**

Queries the lower limit of the supported frequency range of the connected device.

**Suffix:**

<ch>	1..n For future use.
<di>	1..n Connected external device

**Return values:**

<RFFrequency>	numeric value Minimum frequency Default unit: Hz
---------------	--------------------------------------------------------

**Example:**           SENS:EFR:EXTD1:FREQ:MIN?  
                      //Result:  
                      110000000000

**Usage:**             Query only

**Manual operation:** See "[Frequency Range](#)" on page 459

---

**[SENSe:]EFRontend[:CHANnel<ch>]:EXTDevice<di>:GAIN?**

Queries the gain provided by a connected external amplifier.

**Suffix:**

<ch>	1..n For future use.
<di>	1..n Connected external device

**Return values:**

<Gain>	numeric value Default unit: dB
--------	-----------------------------------

**Example:**           SENSE1:EFRontend1:CHANnel1:EXTDevice1:GAIN?  
                      //Result:  
                      //10

**Usage:**             Query only

**Manual operation:** See "[Gain](#)" on page 459

---

**[SENSe:]EFRontend[:CHANnel<ch>]:EXTDevice<di>:NAME?**

Queries the name of the external device for reference.

**Suffix:**

<ch>	1..n For future use.
------	-------------------------

<di> 1..n  
Connected external device

**Return values:**

<Type> string

**Example:**

```
SENS:EFR:CHAN:EXTD1:NAME?
//Result:
//'fe170_z50'
```

**Usage:** Query only

**Manual operation:** See ["Name"](#) on page 458

**[SENSe:]EFRontend[:CHANnel<ch>]:EXTDevice<di>:TYPE?**

Queries the type of the detected device for reference.

**Suffix:**

<ch> 1..n  
For future use.

<di> 1..n  
Connected external device

**Return values:**

<Type> 'Amplifier' | 'Filter'

**Example:**

```
SENSe1:EFRontend1:CHANnel1:EXTDevice1:TYPE?
//Result:
//'Filter'
```

**Usage:** Query only

**Manual operation:** See ["Type"](#) on page 459

**Format of selftest result file**

As a result of the selftest, an XML file with test details is created. It contains the following information in the specified order. Mandatory elements and attributes are indicated in bold font.

Element	Attributes	Description
<Sequence>		Main element
	<b>Name</b>	="Selftest"
	Description	Optional description of the test process
	<b>FirmwareVersion</b>	Firmware version of the controlling instrument (FSW)
	<b>FrontendLibrary-Version</b>	Version of the control.dll with the format x.y.z
	FrontendServerVersion	Version of the RRH server with the format x.y.z (FE44A only)

## Setting basic measurement parameters

Element	Attributes	Description
	<b>Date</b>	Date the selftest was performed, with the format dd/mm/yyyy
	<b>Time</b>	Time the selftest was performed, with the format hh:mm:ss
	<b>State</b>	Test result state, combined result of all <SequenceCategory>s: "PASSED"/ "FAILED"
	<b>Version</b>	For internal use.
	Comment	Optional comment on the test process
<SequenceCategory>		Set of test steps
	<b>Name</b>	Name of the test sequence, e.g. "Frontend voltages"
	Description	Optional description of the test sequence
	<b>State</b>	Test sequence result state, combined result of all <SequenceStep>s: "PASSED"/ "FAILED"
	<b>Version</b>	For internal use.
	Comment	Optional comment on the test sequence
<SequenceStep>		Subelement of <SequenceCategory> for an individual test step
	<b>Name</b>	Name of the individual test step, e.g. FE1_3V3
	Description	Optional description of the test step
	LimitLow	Optional: lower limit to be checked
	LimitHigh	Optional: upper limit to be checked
	MeasValue	Optional: measured value
	Unit	Optional: unit of the measured value
	<b>State</b>	Test step result state: "PASSED"/ "FAILED"
	<b>Version</b>	For internal use.
	Comment	Optional comment on the test step

## Example for selftest result xml file

```
<?xml version="1.0" encoding="UTF-8"?>
<Sequence xmlns:xsi="http://www.w3.org/2001/XMLSchema-instance"
  xsi:noNamespaceSchemaLocation="SelfTest_Schema.xsd">
  <Name>DeviceCheck</Name>
  <FirmwareVersion>1.50-21.1.1.0 Beta</FirmwareVersion>
  <FrontendLibraryVersion>0.8.0</FrontendLibraryVersion>
  <Date>15/01/2021</Date>
  <Time>08:51:35</Time>
  <State>FAILED</State>
  <Version>1.0.0</Version>
  <SequenceCategory>
    <Name>Frontend Voltages</Name>
    <Description>test description</Description>
```

## Setting basic measurement parameters

```

<State>FAILED</State>
<Version>1.0.0</Version>
<Type>Diagnose</Type>
<SequenceStep>
  <Name>FE1_3V3</Name>
  <LimitLow>3.000</LimitLow>
  <LimitHigh>3.600</LimitHigh>
  <MeasValue>3.311</MeasValue>
  <State>PASSED</State>
  <Version>1.0.0</Version>
</SequenceStep>
<SequenceStep>
  <Name>FE1_5V</Name>
  <LimitLow>4.250</LimitLow>
  <LimitHigh>5.750</LimitHigh>
  <MeasValue>5.027</MeasValue>
  <State>PASSED</State>
  <Version>1.0.0</Version>
</SequenceStep>
<SequenceStep>
  <Name>FE1_6V5</Name>
  <LimitLow>6.000</LimitLow>
  <LimitHigh>7.000</LimitHigh>
  <MeasValue>5.893</MeasValue>
  <State>FAILED</State>
  <Version>1.0.0</Version>
</SequenceStep>
<SequenceStep>
  <Name>FE1_M3V3</Name>
  <LimitLow>-3.600</LimitLow>
  <LimitHigh>-3.000</LimitHigh>
  <MeasValue>3.347</MeasValue>
  <State>FAILED</State>
  <Version>1.0.0</Version>
</SequenceStep>
</SequenceCategory>
<SequenceCategory>
  <Name>Frontend Temperature</Name>
  <Description>test description</Description>
  <State>PASSED</State>
  <Version>1.0.0</Version>
  <Type>Diagnose</Type>
  <SequenceStep>
    <Name>TEMP_FE1</Name>
    <LimitLow>0.000</LimitLow>
    <LimitHigh>60.000</LimitHigh>
    <MeasValue>39.300</MeasValue>
    <State>PASSED</State>
    <Version>1.0.0</Version>
  </SequenceStep>

```

## Setting basic measurement parameters

```

</SequenceCategory>
<SequenceCategory>
  <Name>Synthesizer Voltage</Name>
  <Description>test description</Description>
  <State>PASSED</State>
  <Version>1.0.0</Version>
  <Type>Diagnose</Type>
  <SequenceStep>
    <Name>SYNTH_3V4</Name>
    <LimitLow>3.200</LimitLow>
    <LimitHigh>3.910</LimitHigh>
    <MeasValue>3.576</MeasValue>
    <State>PASSED</State>
    <Version>1.0.0</Version>
  </SequenceStep>
  <SequenceStep>
    <Name>SYNTH_5V4_SYN</Name>
    <LimitLow>4.860</LimitLow>
    <LimitHigh>5.940</LimitHigh>
    <MeasValue>5.405</MeasValue>
    <State>PASSED</State>
    <Version>1.0.0</Version>
  </SequenceStep>
  <SequenceStep>
    <Name>SYNTH_5V4_YIG</Name>
    <LimitLow>4.860</LimitLow>
    <LimitHigh>5.940</LimitHigh>
    <MeasValue>5.438</MeasValue>
    <State>PASSED</State>
    <Version>1.0.0</Version>
  </SequenceStep>
  <SequenceStep>
    <Name>SYNTH_M5V</Name>
    <LimitLow>-5.500</LimitLow>
    <LimitHigh>-4.500</LimitHigh>
    <MeasValue>-4.948</MeasValue>
    <State>PASSED</State>
    <Version>1.0.0</Version>
  </SequenceStep>
  <SequenceStep>
    <Name>SYNTH_REF5V</Name>
    <LimitLow>4.500</LimitLow>
    <LimitHigh>5.500</LimitHigh>
    <MeasValue>5.031</MeasValue>
    <State>PASSED</State>
    <Version>1.0.0</Version>
  </SequenceStep>
</SequenceCategory>
<SequenceCategory>
  <Name>Supply Voltage</Name>

```

## Setting basic measurement parameters

```
<Description>test description</Description>
<State>PASSED</State>
<Version>1.0.0</Version>
<Type>Diagnose</Type>
<SequenceStep>
  <Name>SUPPLY_12V</Name>
  <LimitLow>10.800</LimitLow>
  <LimitHigh>13.200</LimitHigh>
  <MeasValue>11.909</MeasValue>
  <State>PASSED</State>
  <Version>1.0.0</Version>
</SequenceStep>
<SequenceStep>
  <Name>SUPPLY_3V3D</Name>
  <LimitLow>2.970</LimitLow>
  <LimitHigh>3.630</LimitHigh>
  <MeasValue>3.318</MeasValue>
  <State>PASSED</State>
  <Version>1.0.0</Version>
</SequenceStep>
<SequenceStep>
  <Name>SUPPLY_4V</Name>
  <LimitLow>3.650</LimitLow>
  <LimitHigh>4.460</LimitHigh>
  <MeasValue>4.053</MeasValue>
  <State>PASSED</State>
  <Version>1.0.0</Version>
</SequenceStep>
<SequenceStep>
  <Name>SUPPLY_6V</Name>
  <LimitLow>5.400</LimitLow>
  <LimitHigh>6.600</LimitHigh>
  <MeasValue>6.076</MeasValue>
  <State>PASSED</State>
  <Version>1.0.0</Version>
</SequenceStep>
<SequenceStep>
  <Name>SUPPLY_M5V</Name>
  <LimitLow>-6.050</LimitLow>
  <LimitHigh>-4.950</LimitHigh>
  <MeasValue>-5.507</MeasValue>
  <State>PASSED</State>
  <Version>1.0.0</Version>
</SequenceStep>
</SequenceCategory>
</Sequence>
```

### Programming example: Configuring an external frontend

The following example describes how to configure RF frontend settings in remote operation.

```
// Prepare the instrument
// Preset
*RST
// Create new IQ-Analyzer channel
:INST:SEL IQ
// Enable 640MHz Reference
:ROSC:O640 ON

//Enable general use of external frontend
SENSE:EFRontend:STATe ON
//Configure connection to ext. FE named "FE44S-1000826"
SENSE:EFRontend:CONNECTION:CONFig "FE44S","FE44S-1000826"
//Activate exclusive use of frontend by FSW.
SENSE:EFRontend:CONNECTION:STATe ON

//For demonstration purposes only: assign a static IP address
SENSE:EFRontend:NETWork "123.456.7.8", "255.255.255.00", OFF

// Query information about the connected RF frontend.
SENSE:EFRontend:CONNECTION:CSTATe?
// Response: 1 (connected)
SENSE:EFRontend:IDN?
////Result: Rohde&Schwarz,FE44S,1234.5678K00/123456,0.8.0

// Specify frontend settings
//Query available intermediate frequency bands
SENSE:EFRontend:FREQuency:BCONfig:LIST?
//Result: "IF HIGH", "IF LOW"
//Use high IF
SENSE:EFRontend:FREQuency:BCONfig:SElect "IF HIGH"
//Query used intermediate frequency
SENSE:EFRontend:FREQuency:IFREquency?
//Result: 8.595000000

//Query available reference frequencies
SENSE:EFRontend:FREQuency:REFerence:LIST?
//Result: 10000000,640000000,1000000000
//Use 640 MHz reference
SENSE:EFRontend:FREQuency:REFerence 640000000

// Query ranges of the operating frequency band.
SENSE:EFRontend:FREQuency:BAND1:LOWer?
// Response in Hz: "24000000000" (= 24 GHz)
SENSE:EFRontend:FREQuency:BAND1:UPPer?
// Response in Hz: "44000000000" (= 44 GHz)
```



## Setting basic measurement parameters

```
// Add cable correction data by loading an *.s2p file.
SENSe:EFRontend:ALIGnment:FILE "C:\R_S\Instr\user\external_frontends\FE44S\
touchstonefiles\if_default_cable_1347_7552_00.s2p"
SENSe:EFRontend:ALIGnment:STATe ON

//Update FW version on frontend (only available if external frontend firmware
//is incompatible to FSW firmware)
SENSe:EFRontend:FWUPdate
//Perform a selftest on the frontend and query results
SENSe:EFRontend:SELftest?
//Result: 0 (no errors)
SENSe:EFRontend:SELftest:RESult?
//Result: "<?xml version="1.0" encoding="UTF-8"?>
//<Sequence xmlns:xsi="http://www.w3.org/2001/XMLSchema-instance"
//xsi:noNamespaceSchemaLocation="
//<Name>DeviceCheck</Name>
//<FirmwareVersion>1.50-21.1.1.0 Beta</FirmwareVersion>
//..."
```

### Programming example 2: Configuring an external frontend with a connected amplifier

The following example demonstrates how to configure an R&S FE170SR external frontend with a connected amplifier.

Some commands may not be necessary as they reflect the default settings; however, they are included to demonstrate the command usage.

```
// Prepare the instrument
// Preset
*RST
// Create new IQ-Analyzer channel
:INST:SEL IQ
// Enable 640MHz Reference
:ROSC:O640 ON

//Enable general use of external frontend
SENSe:EFRontend:STATe ON
//Configure connection to ext. FE named "FE170SR-123456"
SENSe:EFRontend:CONNection:CONFig "FE170SR","FE170SR-123456"
//Activate exclusive use of frontend by FSW.
SENSe:EFRontend:CONNection:STATe ON

// Query information about the connected RF frontend.
SENSe:EFRontend:CONNection:CSTATe?
// Response: 1 (connected)
SENSe:EFRontend:IDN?
////Result: Rohde&Schwarz,FE170SR,1234.5678K00/123456,0.8.0

// Specify frontend settings
//Query available intermediate frequency bands
SENSe:EFRontend:FREQuency:BCONfig:LIST?
```

## Setting basic measurement parameters

```

//Result: "Spur Optimized","EVM Optimized"
//Use spur optimized
SENSe:EFRontend:FREQuency:BCONfig:SElect "Spur Optimized"
//Query used intermediate frequency
SENSe:EFRontend:FREQuency:IFREquency?
//Result: 9940000000

//Query available reference frequencies
SENSe:EFRontend:FREQuency:REFeRence:LIST?
//Result: 10000000,640000000,1000000000
//Use 1 GHz reference
SENSe:EFRontend:FREQuency:REFeRence 1000000000

// Query ranges of the operating frequency band.
SENSe:EFRontend:FREQuency:BAND1:LOWer?
// Response in Hz: "110000000000" (= 110 GHz)
SENSe:EFRontend:FREQuency:BAND1:UPPer?
// Response in Hz: "170000000000" (= 170 GHz)

// Add cable correction data by loading an *.s2p file.
SENSe:EFRontend:ALIGnment:FILE "C:\R_S\Instr\user\external_frontends\FE170SR\
touchstonefiles\if_default_cable_1348_3850_00.s2p"
SENSe:EFRontend:ALIGnment:STATe ON

//Configure external amplifier named "fe170_z50" connected to frontend
//Refresh and query the list of detected external devices
SENSe:EFRontend:EXTDevice:REFresh
SENSe:EFRontend:EXTDevice:LIST?
//Result:
//"fe170_z50"
//Query the type of the external device
SENSe:EFRontend:EXTDevice:TYPE?
//Result:
//'Amplifier'
//Query the supported frequency range of the amplifier
SENSe:EFRontend:EXTDevice1:FREQuency:MINimum?
//Result:
//110000000000
SENSe:EFRontend:EXTDevice1:FREQuency:MAXimum?
//Result:
//170000000000
//Query the gain of the amplifier
SENSe:EFRontend:EXTDevice1:GAIN?
//Result:
//10
//Only for demonstration purposes:
//Load and enable a correction file for the amplifier.
//The correction file is automatically considered if the IX cable is used to connect
//the external device to the frontend.
SENSe:EFRontend:EXTDevice1:CORRection:FILE 'C:\temp\ExtDev_Corr.s2p'
SENSe:EFRontend:EXTDevice1:CORRection:STATe ON

```

```
//Check if the loaded file is valid
SENSe:EFrontend:EXTDevice1:CORRection:VALid?
```

### 13.7.1.3 Configuring digital I/Q input and output

#### Remote commands exclusive to digital I/Q data input and output

INPut:DIQ:CDEvice.....	1139
INPut:DIQ:RANGe:COUPling.....	1139
INPut:DIQ:RANGe[:UPPer].....	1139
INPut:DIQ:RANGe[:UPPer]:AUTO.....	1140
INPut:DIQ:RANGe[:UPPer]:UNIT.....	1140
INPut:DIQ:SRATe.....	1140
INPut:DIQ:SRATe:AUTO.....	1140

---

#### INPut:DIQ:CDEvice

Queries the current configuration and the status of the digital I/Q input from the optional "Digital Baseband" interface.

For details see the section "Interface Status Information" for the optional "Digital Baseband" interface in the FSW I/Q Analyzer User Manual.

#### Return values:

<Value>

#### Example:

```
INP:DIQ:CDEV?
```

Result:

```
1, SMW200A, 101190, BBMM 1 OUT,
100000000, 200000000, Passed, Passed, 1, 1. #QNAN
```

---

#### INPut:DIQ:RANGe:COUPling <State>

If enabled, the reference level for digital input is adjusted to the full scale level automatically if the full scale level changes.

Is only available if the optional "Digital Baseband" interface is installed.

#### Parameters:

<State> ON | OFF | 1 | 0

\*RST: 0

---

#### INPut:DIQ:RANGe[:UPPer] <Level>

Defines or queries the "Full Scale Level", i.e. the level that corresponds to an I/Q sample with the magnitude "1".

Is only available if the optional "Digital Baseband" interface is installed.

**Parameters:**

<Level>                    Range:     1  $\mu$ V to 7.071 V  
                               \*RST:     1 V  
                               Default unit: DBM

**INPut:DIQ:RANGe[:UPPer]:AUTO <State>**

If enabled, the digital input full scale level is automatically set to the value provided by the connected device (if available).

Is only available if the optional "Digital Baseband" interface is installed.

**Parameters:**

<State>                    ON | OFF | 1 | 0  
                               \*RST:     0

**INPut:DIQ:RANGe[:UPPer]:UNIT <Level>**

Defines the unit of the full scale level. The availability of units depends on the measurement application you are using.

Is only available if the optional "Digital Baseband" interface is installed.

**Parameters:**

<Level>                    DBM | DBPW | WATT | DBUV | DBMV | VOLT | DBUA | AMPere  
                               \*RST:     Volt

**INPut:DIQ:SRATe <SampleRate>**

Specifies or queries the sample rate of the input signal from the optional "Digital Baseband" interface.

**Parameters:**

<SampleRate>            Range:     1 Hz to 20 GHz  
                               \*RST:     32 MHz  
                               Default unit: HZ

**Example:**                INP:DIQ:SRAT 200 MHz

**INPut:DIQ:SRATe:AUTO <State>**

If enabled, the sample rate of the digital I/Q input signal is set automatically by the connected device.

Is only available if the optional "Digital Baseband" interface is installed.

**Parameters:**

<State>                    ON | OFF | 1 | 0  
                               \*RST:     0

### 13.7.1.4 Configuring input via the optional Analog Baseband interface

The following commands are required to control the optional "Analog Baseband" interface in a remote environment. They are only available if this option is installed.

Useful commands for Analog Baseband data described elsewhere:

- `INP:SEL AIQ` (see `INPut:SElect` on page 1113)
- `[SENSe:]FREQuency:CENTer` on page 1192

Commands for the Analog Baseband calibration signal are described in the FSW User Manual.

#### Remote commands exclusive to Analog Baseband data input and output

<code>INPut:IQ:BALanced[:STATe]</code> .....	1141
<code>INPut:IQ:FULLscale:AUTO</code> .....	1141
<code>INPut:IQ:FULLscale[:LEVel]</code> .....	1142
<code>INPut:IQ:IMPedance</code> .....	1142
<code>INPut:IQ:IMPedance:PTYPE</code> .....	1142
<code>INPut:IQ:TYPE</code> .....	1143
<code>CALibration:AIQ:HATiming[:STATe]</code> .....	1143

---

#### `INPut:IQ:BALanced[:STATe]` <State>

Defines whether the input is provided as a differential signal via all 4 Analog Baseband connectors or as a plain I/Q signal via 2 single-ended lines.

##### Parameters:

<State>                    `ON | OFF | 1 | 0`  
                               **ON | 1**  
                               Differential  
                               **OFF | 0**  
                               Single ended  
                               \*RST:        1

**Example:**                `INP:IQ:BAL OFF`

---

#### `INPut:IQ:FULLscale:AUTO` <State>

Defines whether the full scale level (i.e. the maximum input power on the Baseband Input connector) is defined automatically according to the reference level, or manually.

##### Parameters:

<State>                    **ON | 1**  
                               Automatic definition  
                               **OFF | 0**  
                               Manual definition according to `INPut:IQ:FULLscale[:LEVel]` on page 1142  
                               \*RST:        1

**Example:**                `INP:IQ:FULL:AUTO OFF`

**INPut:IQ:FULLscale[:LEVel]** <PeakVoltage>

Defines the peak voltage at the Baseband Input connector if the full scale level is set to manual mode (see [INPut:IQ:FULLscale:AUTO](#) on page 1141).

**Parameters:**

<PeakVoltage> 0.25 V | 0.5 V | 1 V | 2 V  
 Peak voltage level at the connector.  
 For probes, the possible full scale values are adapted according to the probe's attenuation and maximum allowed power.  
 \*RST: 1V  
 Default unit: V

**Example:** INP:IQ:FULL 0.5V

**INPut:IQ:IMPedance** <Impedance>

Selects the nominal input impedance of the analog baseband input.

Not available for input from the optional "Digital Baseband" interface.

For input from the RF input, use the [INPut:IMPedance](#) command.

**Parameters:**

<Impedance> 50 | 75  
**numeric value**  
 User-defined impedance from 50 Ohm to 100000000 Ohm (=100 MOhm)  
 User-defined values are only available for:  
 Spectrum application  
 I/Q Analyzer  
 \*RST: 50  
 Default unit: OHM

**Example:** INP:IQ:IMP 75

**Manual operation:** See "[Impedance](#)" on page 364

**INPut:IQ:IMPedance:PTYPe** <PadType>

Defines the type of matching pad used for impedance conversion for analog baseband input.

For RF input, use the [INPut:IMPedance:PTYPe](#) command.

**Parameters:**

<PadType> SRESistor | MLPad  
**SRESistor**  
 Series-R  
**MLPad**  
 Minimum Loss Pad  
 \*RST: SRESistor

**Example:**            `INP:IQ:IMP 100`  
                          `INP:IQ:IMP:PTYP MLP`

**Manual operation:** See "[Impedance](#)" on page 364

### **INPut:IQ:TYPE** <DataType>

Defines the format of the input signal.

**Parameters:**

<DataType>            `IQ | I | Q`

**IQ**

The input signal is filtered and resampled to the sample rate of the application.

Two input channels are required for each input signal, one for the in-phase component, and one for the quadrature component.

**I**

The in-phase component of the input signal is filtered and resampled to the sample rate of the application. If the center frequency is not 0, the in-phase component of the input signal is down-converted first (Low IF I).

**Q**

The quadrature component of the input signal is filtered and resampled to the sample rate of the application. If the center frequency is not 0, the quadrature component of the input signal is down-converted first (Low IF Q).

\*RST:            `IQ`

**Example:**            `INP:IQ:TYPE Q`

### **CALibration:AIQ:HATiming[:STATe]** <State>

Activates a mode with enhanced timing accuracy between analog baseband, RF and external trigger signals.

**Parameters:**

<State>            `ON | OFF | 0 | 1`

**OFF | 0**

Switches the function off

**ON | 1**

Switches the function on

**Example:**            `CAL:AIQ:HAT:STAT ON`

### 13.7.1.5 Using external mixers

The commands required to work with external mixers in a remote environment are described here. Note that these commands require the FSW to have an external mixer option installed and an external mixer to be connected to the FSW.

In MSRA/MSRT mode, external mixers are not supported.

For details on working with external mixers see [Chapter 7.2.6.1, "Basics on external mixers"](#), on page 411.

- [Basic settings](#)..... 1144
- [Mixer settings](#)..... 1146
- [Conversion loss table settings](#)..... 1153
- [Programming example: working with an external mixer](#)..... 1157

#### Basic settings

The basic settings concern general usage of an external mixer.

<a href="#">[SENSe:]MIXer&lt;x&gt;[:STATe]</a> .....	1144
<a href="#">[SENSe:]MIXer&lt;x&gt;:BIAS:HIGH</a> .....	1144
<a href="#">[SENSe:]MIXer&lt;x&gt;:BIAS[:LOW]</a> .....	1145
<a href="#">[SENSe:]MIXer&lt;x&gt;:LOPower</a> .....	1145
<a href="#">[SENSe:]MIXer&lt;x&gt;:SIGNal</a> .....	1145
<a href="#">[SENSe:]MIXer&lt;x&gt;:THReshold</a> .....	1146

---

#### [\[SENSe:\]MIXer<x>\[:STATe\]](#) <State>

Activates or deactivates the use of a connected external mixer as input for the measurement. This command is only available if the optional External Mixer is installed and an external mixer is connected.

##### Suffix:

<x>                    1..n  
                         irrelevant

##### Parameters:

<State>                ON | OFF | 1 | 0  
                         \*RST:        0

**Example:**            MIX ON

**Manual operation:** See "[External Mixer \(State\)](#)" on page 424

---

#### [\[SENSe:\]MIXer<x>:BIAS:HIGH](#) <BiasSetting>

Defines the bias current for the high (last) range.

Is only available if the external mixer is active (see [\[SENSe:\]MIXer<x>\[:STATe\]](#) on page 1144).

##### Suffix:

<x>                    1..n  
                         irrelevant



**Parameters:**

<BiasSetting>            \*RST:        0.0 A  
                               Default unit: A

**Manual operation:**    See "[Bias Value](#)" on page 429

**[SENSe:]MIXer<x>:BIAS[:LOW] <BiasSetting>**

Defines the bias current for the low (first) range.

Is only available if the external mixer is active (see [\[SENSe:\]MIXer<x>\[:STATE\]](#) on page 1144).

**Suffix:**

<x>                        1..n  
                               irrelevant

**Parameters:**

<BiasSetting>            \*RST:        0.0 A  
                               Default unit: A

**Manual operation:**    See "[Bias Value](#)" on page 429

**[SENSe:]MIXer<x>:LOPower <Level>**

Specifies the LO level of the external mixer's LO port.

**Suffix:**

<x>                        1..n  
                               irrelevant

**Parameters:**

<Level>                    Range:        13.0 dBm to 17.0 dBm  
                               Increment:  0.1 dB  
                               \*RST:        15.5 dBm  
                               Default unit: DBM

**Example:**                MIX:LOP 16.0dBm

**Manual operation:**    See "[LO Level](#)" on page 428

**[SENSe:]MIXer<x>:SIGNal <State>**

Specifies whether automatic signal detection is active or not.

Note that automatic signal identification is only available for measurements that perform frequency sweeps (not in vector signal analysis or the I/Q Analyzer, for instance).

The "Auto ID" function is now also available for [Spectrum emission mask \(SEM\) measurement](#) and [Spurious emissions measurement](#) using an external mixer.

**Suffix:**

<x> 1..n  
irrelevant

**Parameters:**

<State> OFF | ON | AUTO | ALL  
**OFF | ON | AUTO | ALL**  
**OFF**  
No automatic signal detection is active.  
**ON**  
Automatic signal detection (Signal ID) is active.  
**AUTO**  
Automatic signal detection (Auto ID) is active.  
**ALL**  
Both automatic signal detection functions (Signal ID+Auto ID) are active.  
\*RST: OFF

**Manual operation:** See "Signal ID" on page 428  
See "Auto ID" on page 428

**[SENSe:]MIXer<x>:THReshold <Value>**

Defines the maximum permissible level difference between test sweep and reference sweep to be corrected during automatic comparison (see [SENSe:]MIXer<x>:SIGNal on page 1145).

**Suffix:**

<x> 1..n  
irrelevant

**Parameters:**

<Value> <numeric value>  
Range: 0.1 dB to 100 dB  
\*RST: 10 dB  
Default unit: DB

**Example:** MIX:PORT 3

**Manual operation:** See "Auto ID Threshold" on page 429

**Mixer settings**

The following commands are required to configure the band and specific mixer settings.

[SENSe:]MIXer<x>:FREQuency:HANdOver.....	1147
[SENSe:]MIXer<x>:FREQuency:STARt.....	1147
[SENSe:]MIXer<x>:FREQuency:STOP.....	1147
[SENSe:]MIXer<x>:HARMonic:BAND:PRESet.....	1148
[SENSe:]MIXer<x>:HARMonic:BAND.....	1148

[SENSe:]MIXer<x>:HARMonic:HIGH:STATe.....	1149
[SENSe:]MIXer<x>:HARMonic:HIGH[:VALue].....	1149
[SENSe:]MIXer<x>:HARMonic:TYPE.....	1149
[SENSe:]MIXer<x>:HARMonic[:LOW].....	1150
[SENSe:]MIXer<x>:IF?.....	1150
[SENSe:]MIXer<x>:LOSS:HIGH.....	1150
[SENSe:]MIXer<x>:LOSS:TABLE:HIGH.....	1151
[SENSe:]MIXer<x>:LOSS:TABLE[:LOW].....	1151
[SENSe:]MIXer<x>:LOSS[:LOW].....	1152
[SENSe:]MIXer<x>:PORTs.....	1152
[SENSe:]MIXer<x>:RFOVerrange[:STATe].....	1152

---

### [SENSe:]MIXer<x>:FREQuency:HANDOver <Frequency>

Defines the frequency at which the mixer switches from one range to the next (if two different ranges are selected). The handover frequency for each band can be selected freely within the overlapping frequency range.

Is only available if the external mixer is active (see [SENSe:]MIXer<x>[:STATe] on page 1144).

#### Suffix:

<x>	1..n
	irrelevant

#### Parameters:

<Frequency>	Default unit: HZ
-------------	------------------

#### Example:

```
MIX ON
Activates the external mixer.
MIX:FREQ:HAND 78.0299GHz
Sets the handover frequency to 78.0299 GHz.
```

**Manual operation:** See "Handover Freq" on page 425

---

### [SENSe:]MIXer<x>:FREQuency:STARt

Sets or queries the frequency at which the external mixer band starts.

#### Suffix:

<x>	1..n
	irrelevant

#### Example:

```
MIX:FREQ:STAR?
Queries the start frequency of the band.
```

**Manual operation:** See "RF Start / RF Stop" on page 424

---

### [SENSe:]MIXer<x>:FREQuency:STOP

Sets or queries the frequency at which the external mixer band stops.

**Suffix:**

<x> 1..n  
irrelevant

**Example:**

MIX:FREQ:STOP?  
Queries the stop frequency of the band.

**Manual operation:** See "RF Start / RF Stop" on page 424

**[SENSe:]MIXer<x>:HARMonic:BAND:PRESet**

Restores the preset frequency ranges for the selected standard waveguide band.

**Note:** Changes to the band and mixer settings are maintained even after using the [PRESET] function. Use this command to restore the predefined band ranges.

**Suffix:**

<x> 1..n  
irrelevant

**Example:**

MIX:HARM:BAND:PRESet  
Presets the selected waveguide band.

**Manual operation:** See "Preset Band" on page 425

**[SENSe:]MIXer<x>:HARMonic:BAND <Band>**

Selects the external mixer band. The query returns the currently selected band.

Is only available if the external mixer is active (see [SENSe:]MIXer<x>[:STATe] on page 1144).

**Suffix:**

<x> 1..n  
irrelevant

**Parameters:**

<Band> KA|Q|U|V|E|W|F|D|G|Y|J|USER  
Standard waveguide band or user-defined band.

**Manual operation:** See "Band" on page 425

**Table 13-4: Frequency ranges for pre-defined bands**

Band	Frequency start [GHz]	Frequency stop [GHz]
KA (A) *)	26.5	40.0
Q	33.0	50.0
U	40.0	60.0
V	50.0	75.0
E	60.0	90.0
W	75.0	110.0

\*) The band formerly referred to as "A" is now named "KA".

## Setting basic measurement parameters

Band	Frequency start [GHz]	Frequency stop [GHz]
F	90.0	140.0
D	110.0	170.0
G	140.0	220.0
J	220.0	325.0
Y	325.0	500.0
USER	32.18 (default)	68.22 (default)

\*) The band formerly referred to as "A" is now named "KA".

**[SENSe:]MIXer<x>:HARMonic:HIGH:STATe <State>**

Specifies whether a second (high) harmonic is to be used to cover the band's frequency range.

**Suffix:**

<x> 1..n

**Parameters:**

<State> ON | OFF  
\*RST: ON

**Example:** MIX:HARM:HIGH:STAT ON

**Manual operation:** See "[Range 1/Range 2](#)" on page 426

**[SENSe:]MIXer<x>:HARMonic:HIGH[:VALue] <HarmOrder>**

Specifies the harmonic order to be used for the high (second) range.

**Suffix:**

<x> 1..n  
irrelevant

**Parameters:**

<HarmOrder> Range: 2 to 128 (USER band); for other bands: see band definition

**Example:** MIX:HARM:HIGH:STAT ON  
MIX:HARM:HIGH 3

**Manual operation:** See "[Harmonic Order](#)" on page 426

**[SENSe:]MIXer<x>:HARMonic:TYPE <OddEven>**

Specifies whether the harmonic order to be used should be odd, even, or both.

Which harmonics are supported depends on the mixer type.

**Suffix:**

<x> 1..n  
irrelevant

**Parameters:**

<OddEven> ODD | EVEN | EODD  
**ODD | EVEN | EODD**  
\*RST: EVEN

**Example:** MIX:HARM:TYPE ODD

**Manual operation:** See "[Harmonic Type](#)" on page 426

**[SENSe:]MIXer<x>:HARMonic[:LOW] <HarmOrder>**

Specifies the harmonic order to be used for the low (first) range.

**Suffix:**

<x> 1..n  
irrelevant

**Parameters:**

<HarmOrder> Range: 2 to 128 (USER band); for other bands: see band definition  
\*RST: 2 (for band F)

**Example:** MIX:HARM 3

**Manual operation:** See "[Harmonic Order](#)" on page 426

**[SENSe:]MIXer<x>:IF?**

Queries the intermediate frequency currently used by the external mixer.

**Suffix:**

<x> 1..n  
irrelevant

**Example:** MIX:IF?

**Example:** See "[Programming example: working with an external mixer](#)" on page 1157.

**Usage:** Query only

**Manual operation:** See "[IF](#)" on page 426

**[SENSe:]MIXer<x>:LOSS:HIGH <Average>**

Defines the average conversion loss to be used for the entire high (second) range.

**Suffix:**

<x> 1..n  
irrelevant

## Setting basic measurement parameters

**Parameters:**

<Average>                    Range:        0 to 100  
                                  \*RST:        24.0 dB  
                                  Default unit: dB

**Example:**                    MIX:LOSS:HIGH 20dB

**Manual operation:**    See "[Conversion Loss](#)" on page 427

**[SENSe:]MIXer<x>:LOSS:TABLE:HIGH <FileName>**

Defines the conversion loss table to be used for the high (second) range.

**Suffix:**

<x>                                1..n  
                                       irrelevant

**Parameters:**

<FileName>                    String containing the path and name of the file, or the serial number of the external mixer whose file is required. The FSW automatically selects the correct cvl file for the current IF. As an alternative, you can also select a user-defined conversion loss table (.acl file).

**Example:**

```
MIX:LOSS:TABLE:HIGH '101567'
MIX:LOSS:TABLE:HIGH?
//Result for installed B5000, bw<= 4.4 GHz: 101567_B5000_2G8.B5G:
//'101567_MAG_6_B5000_2G8.B5G'
//Result for installed B5000, bw> 4.4 GHz: 101567_B5000_2G8.B5G:
//'101567_MAG_6_B5000_3G5.B5G'
//Result for installed B2001 and bw> 80 MHz:
//'101567_MAG_6_B1200_B2001.B2G'
//Result for installed B2001 and bw<= 80 MHz:
//'101567_MAG_6.ACL'
```

**Manual operation:**    See "[Conversion Loss](#)" on page 427

**[SENSe:]MIXer<x>:LOSS:TABLE[:LOW] <FileName>**

Defines the file name of the conversion loss table to be used for the low (first) range.

**Suffix:**

<x>                                1..n  
                                       irrelevant

**Parameters:**

<FileName>                    String containing the path and name of the file, or the serial number of the external mixer whose file is required. The FSW automatically selects the correct cvl file for the current IF. As an alternative, you can also select a user-defined conversion loss table (.acl file).

**Example:**

```
MIX:LOSS:TABL '101567'
MIX:LOSS:TABL?
//Result:
'101567_MAG_6_B5000_3G5.B5G'
```

**Manual operation:** See "[Conversion Loss](#)" on page 427

### [SENSe:]MIXer<x>:LOSS[:LOW] <Average>

Defines the average conversion loss to be used for the entire low (first) range.

**Suffix:**

<x>                    1..n  
                         irrelevant

**Parameters:**

<Average>            Range:        0 to 100  
                         \*RST:        24.0 dB  
                         Default unit: dB

**Example:**            MIX:LOSS 20dB

**Manual operation:** See "[Conversion Loss](#)" on page 427

### [SENSe:]MIXer<x>:PORTs <PortType>

Selects the mixer type.

**Suffix:**

<x>                    1..n  
                         irrelevant

**Parameters:**

<PortType>            **2 | 3**  
                         **2**  
                         Two-port mixer.  
                         **3**  
                         Three-port mixer.  
                         \*RST:        2

**Example:**            MIX:PORT 3

**Manual operation:** See "[Mixer Type](#)" on page 426

### [SENSe:]MIXer<x>:RFOVerrange[:STATe] <State>

If enabled, the band limits are extended beyond "RF Start" and "RF Stop" due to the capabilities of the used harmonics.

**Suffix:**

<x>                    1..n  
                         irrelevant



**Parameters:**

<State> ON | OFF | 1 | 0  
 \*RST: 0

**Manual operation:** See "RF Overrange" on page 425

**Conversion loss table settings**

The following settings are required to configure and manage conversion loss tables.

[SENSe:]CORRection:CVL:BAND.....	1153
[SENSe:]CORRection:CVL:BIAS.....	1153
[SENSe:]CORRection:CVL:CATalog?.....	1154
[SENSe:]CORRection:CVL:CLEar.....	1154
[SENSe:]CORRection:CVL:COMMent.....	1154
[SENSe:]CORRection:CVL:DATA.....	1155
[SENSe:]CORRection:CVL:HARMonic.....	1155
[SENSe:]CORRection:CVL:MIXer.....	1155
[SENSe:]CORRection:CVL:PORTs.....	1156
[SENSe:]CORRection:CVL:SElect.....	1156
[SENSe:]CORRection:CVL:SNUMber.....	1157

**[SENSe:]CORRection:CVL:BAND <Band>**

Defines the waveguide band for which the conversion loss table is to be used. This setting is checked against the current mixer setting before the table can be assigned to the range.

Before this command can be performed, the conversion loss table must be selected (see [SENSe:]CORRection:CVL:SElect on page 1156).

Is only available with option B21 (External Mixer) installed.

**Parameters:**

<Band> K | KA | Q | U | V | E | W | F | D | G | Y | J | USER  
 Standard waveguide band or user-defined band.  
 For a definition of the frequency range for the pre-defined bands, see Table 13-4).  
 \*RST: F (90 GHz - 140 GHz)

**Example:**

```
CORR:CVL:SEL 'LOSS_TAB_4'
Selects the conversion loss table.
CORR:CVL:BAND KA
Sets the band to KA (26.5 GHz - 40 GHz).
```

**Manual operation:** See "Band" on page 433

**[SENSe:]CORRection:CVL:BIAS <BiasSetting>**

Defines the bias setting to be used with the conversion loss table.

Before this command can be performed, the conversion loss table must be selected (see [SENSe:]CORRection:CVL:SElect on page 1156).

Is only available with option B21 (External Mixer) installed.

**Parameters:**

<BiasSetting> \*RST: 0.0 A  
Default unit: A

**Example:**

```
CORR:CVL:SEL 'LOSS_TAB_4'
Selects the conversion loss table.
CORR:CVL:BIAS 3A
```

**Manual operation:** See ["Write to CVL table"](#) on page 429  
See ["Bias"](#) on page 433

**[SENSe:]CORRection:CVL:CATalog?**

Queries all available conversion loss tables saved in the C:\R\_S\INSTR\USER\cv1\ directory on the instrument.

Is only available with option B21 (External Mixer) installed.

**Return values:**

<Files> 'string'  
Comma-separated list of strings containing the file names.

**Example:** CORR:CVL:CAT?

**Usage:** Query only

**[SENSe:]CORRection:CVL:CLEar**

Deletes the selected conversion loss table. Before this command can be performed, the conversion loss table must be selected (see [\[SENSe:\]CORRection:CVL:SELEct](#) on page 1156).

Is only available with option B21 (External Mixer) installed.

**Example:** CORR:CVL:SEL 'LOSS\_TAB\_4'  
Selects the conversion loss table.  
CORR:CVL:CLE

**Manual operation:** See ["Delete Table"](#) on page 430

**[SENSe:]CORRection:CVL:COMMent <Text>**

Defines a comment for the conversion loss table. Before this command can be performed, the conversion loss table must be selected (see [\[SENSe:\]CORRection:CVL:SELEct](#) on page 1156).

Is only available with option B21 (External Mixer) installed.

**Parameters:**

<Text>

## Setting basic measurement parameters

**Example:**           CORR:CVL:SEL 'LOSS\_TAB\_4'  
                           Selects the conversion loss table.  
                           CORR:CVL:COMM 'Conversion loss table for  
                           FS\_Z60'

**Manual operation:** See "[Comment](#)" on page 433

### [SENSe:]CORRection:CVL:DATA {<Freq>, <Level>}...

Defines the reference values of the selected conversion loss tables. The values are entered as a set of frequency/level pairs. You can define a maximum of 500 frequency/level pairs. Before this command can be performed, you must select the conversion loss table (see [\[SENSe:\]CORRection:CVL:SELEct](#) on page 1156).

Is only available with option B21 (External Mixer) installed.

**Parameters:**

<Freq>                The frequencies have to be sent in ascending order.

Default unit: HZ

<Level>               Default unit: DB

**Example:**           CORR:CVL:SEL 'LOSS\_TAB\_4'  
                           Selects the conversion loss table.  
                           CORR:CVL:DATA 1MHZ,-30DB,2MHZ,-40DB

**Manual operation:** See "[Position/Value](#)" on page 434

### [SENSe:]CORRection:CVL:HARMonic <HarmOrder>

Defines the harmonic order for which the conversion loss table is to be used. This setting is checked against the current mixer setting before the table can be assigned to the range.

Before this command can be performed, the conversion loss table must be selected (see [\[SENSe:\]CORRection:CVL:SELEct](#) on page 1156).

Is only available with option B21 (External Mixer) installed.

**Parameters:**

<HarmOrder>        Range:     2 to 65

**Example:**           CORR:CVL:SEL 'LOSS\_TAB\_4'  
                           Selects the conversion loss table.  
                           CORR:CVL:HARM 3

**Manual operation:** See "[Harmonic Order](#)" on page 433

### [SENSe:]CORRection:CVL:MIXer <Type>

Defines the mixer name in the conversion loss table. This setting is checked against the current mixer setting before the table can be assigned to the range.

Before this command can be performed, the conversion loss table must be selected (see [\[SENSe:\]CORRection:CVL:SElect](#) on page 1156).

Is only available with option B21 (External Mixer) installed.

**Parameters:**

<Type> string  
Name of mixer with a maximum of 16 characters

**Example:**

```
CORR:CVL:SEL 'LOSS_TAB_4'
Selects the conversion loss table.
CORR:CVL:MIX 'FS_Z60'
```

**Manual operation:** See ["Mixer Name"](#) on page 433

**[SENSe:]CORRection:CVL:PORTs <PortType>**

Defines the mixer type in the conversion loss table. This setting is checked against the current mixer setting before the table can be assigned to the range.

Before this command can be performed, the conversion loss table must be selected (see [\[SENSe:\]CORRection:CVL:SElect](#) on page 1156).

Is only available with option B21 (External Mixer) installed.

**Parameters:**

<PortType> 2 | 3  
\*RST: 2

**Example:**

```
CORR:CVL:SEL 'LOSS_TAB_4'
Selects the conversion loss table.
CORR:CVL:PORT 3
```

**Manual operation:** See ["Mixer Type"](#) on page 434

**[SENSe:]CORRection:CVL:SElect <FileName>**

Selects the conversion loss table with the specified file name. If <file\_name> is not available, a new conversion loss table is created.

Is only available with option B21 (External Mixer) installed.

**Parameters:**

<FileName> String containing the path and name of the file.

**Example:**

```
CORR:CVL:SEL 'LOSS_TAB_4'
```

**Manual operation:**

See ["New Table"](#) on page 430  
See ["Edit Table"](#) on page 430  
See ["File Name"](#) on page 432

**[SENSe:]CORRection:CVL:SNUMber <SerialNo>**

Defines the serial number of the mixer for which the conversion loss table is to be used. This setting is checked against the current mixer setting before the table can be assigned to the range.

Before this command can be performed, the conversion loss table must be selected (see [SENSe:]CORRection:CVL:SElect on page 1156).

Is only available with option B21 (External Mixer) installed.

**Parameters:**

<SerialNo> Serial number with a maximum of 16 characters

**Example:**

```
CORR:CVL:SEL 'LOSS_TAB_4'
Selects the conversion loss table.
CORR:CVL:MIX '123.4567'
```

**Manual operation:** See "Mixer S/N" on page 433

**Programming example: working with an external mixer**

This example demonstrates how to work with an external mixer in a remote environment. It is performed in the Spectrum application in the default layout configuration. Note that without a real input signal and connected mixer, this measurement will not return useful results.

```
//-----Preparing the instrument -----
//Reset the instrument
*RST
//Activate the use of the connected external mixer.
SENS:MIX ON
//----- Configuring basic mixer behavior -----
//Set the LO level of the mixer's LO port to 15 dBm.
SENS:MIX:LOP 15dBm
//Set the bias current to -1 mA .
SENS:MIX:BIAS:LOW -1mA
//----- Configuring the mixer and band settings -----
//Use band "V" to full possible range extent for assigned harmonic (6).
SENS:MIX:HARM:BAND V
SENS:MIX:RFOV ON
//Query the possible range
SENS:MIX:FREQ:STAR?
//Result: 47480000000 (47.48 GHz)
SENS:MIX:FREQ:STOP?
//Result: 138020000000 (138.02 GHz)
//Use a 3-port mixer type
SENS:MIX:PORT 3
//Split the frequency range into two ranges;
//range 1 covers 47.48 GHz GHz to 80 GHz; harmonic 6, average conv. loss of 20 dB
//range 2 covers 80 GHz to 138.02 GHz; harmonic 8, average conv.loss of 30 dB
SENS:MIX:HARM:TYPE EVEN
SENS:MIX:HARM:HIGH:STAT ON
```

## Setting basic measurement parameters

```

SENS:MIX:FREQ:HAND 80GHz
SENS:MIX:HARM:LOW 6
SENS:MIX:LOSS:LOW 20dB
SENS:MIX:HARM:HIGH 8
SENS:MIX:LOSS:HIGH 30dB
//----- Activating automatic signal identification functions -----
//Activate both automatic signal identification functions.
SENS:MIX:SIGN ALL
//Use auto ID threshold of 8 dB.
SENS:MIX:THR 8dB

//-----Performing the Measurement-----
//Select single sweep mode.
INIT:CONT OFF
//Initiate a basic frequency sweep and wait until the sweep has finished.
INIT;*WAI
//-----Retrieving Results-----
//Return the trace data for the input signal without distortions
//(default screen configuration)
TRAC:DATA? TRACE3

```

**Configuring a conversion loss table for a user-defined band**

```

//-----Preparing the instrument -----
//Reset the instrument
*RST
//Activate the use of the connected external mixer.
SENS:MIX ON
//-----Configuring a new conversion loss table -----
//Define cvl table for range 1 of band as described in previous example
// (extended V band)
SENS:CORR:CVL:SEL 'UserTable'
SENS:CORR:CVL:COMM 'User-defined conversion loss table for USER band'
SENS:CORR:CVL:BAND USER
SENS:CORR:CVL:HARM 6
SENS:CORR:CVL:BIAS -1mA
SENS:CORR:CVL:MIX 'FS_Z60'
SENS:CORR:CVL:SNUM '123.4567'
SENS:CORR:CVL:PORT 3
//Conversion loss is linear from 55 GHz to 75 GHz
SENS:CORR:CVL:DATA 55GHZ,-20DB,75GHZ,-30DB
//----- Configuring the mixer and band settings -----
//Use user-defined band and assign new cvl table.
SENS:MIX:HARM:BAND USER
//Define band by two ranges;
//range 1 covers 47.48 GHz to 80 GHz; harmonic 6, cvl table 'UserTable'
//range 2 covers 80 GHz to 138.02 GHz; harmonic 8, average conv.loss of 30 dB
SENS:MIX:HARM:TYPE EVEN
SENS:MIX:HARM:HIGH:STAT ON

```

## Setting basic measurement parameters

```

SENS:MIX:FREQ:HAND 80GHz
SENS:MIX:HARM:LOW 6
SENS:MIX:LOSS:TABL:LOW 'UserTable'
SENS:MIX:HARM:HIGH 8

SENS:MIX:LOSS:HIGH 30dB
//Query the possible range
SENS:MIX:FREQ:STAR?
//Result: 47480000000 (47.48 GHz)
SENS:MIX:FREQ:STOP?
//Result: 138020000000 (138.02 GHz)

//-----Performing the Measurement-----
//Select single sweep mode.
INIT:CONT OFF
//Initiate a basic frequency sweep and wait until the sweep has finished.
INIT;*WAI
//-----Retrieving Results-----
//Return the trace data (default screen configuration)
TRAC:DATA? TRACel

```

### 13.7.1.6 Setting up probes

Modular probes can be connected to the RF input connector of the FSW.

For details see [Chapter 7.2.5.1, "Using probes"](#), on page 403.

Probes can also be connected to the optional "Baseband Input" connectors, if the "Analog Baseband" interface ( option FSW-B71) is installed.

[SENSe:]PROBe<pb>:ID:PARTnumber?	1159
[SENSe:]PROBe<pb>:ID:SRNumber?	1160
[SENSe:]PROBe<pb>:SETup:ATTRatio	1160
[SENSe:]PROBe<pb>:SETup:CMOOffset	1161
[SENSe:]PROBe<pb>:SETup:DMOOffset	1161
[SENSe:]PROBe<pb>:SETup:MODE	1162
[SENSe:]PROBe<pb>:SETup:NAME?	1162
[SENSe:]PROBe<pb>:SETup:NMOOffset	1162
[SENSe:]PROBe<pb>:SETup:PMODE	1163
[SENSe:]PROBe<pb>:SETup:PMOOffset	1164
[SENSe:]PROBe<pb>:SETup:STATE?	1164
[SENSe:]PROBe<pb>:SETup:TYPE?	1164

---

#### [SENSe:]PROBe<pb>:ID:PARTnumber?

Queries the R&S part number of the probe.

**Suffix:**

<pb> 1..n  
 Selects the connector:  
 1 = Baseband Input I  
 2 = Baseband Input Q  
 3 = RF

**Return values:**

<PartNumber>

**Example:** //Query part number  
 PROB3:ID:PART?

**Usage:** Query only

**Manual operation:** See "[Part Number](#)" on page 409

**[SENSe:]PROBe<pb>:ID:SRNumber?**

Queries the serial number of the probe.

**Suffix:**

<pb> 1..n  
 Selects the connector:  
 1 = Baseband Input I  
 2 = Baseband Input Q  
 3 = RF

**Return values:**

<SerialNo>

**Example:** //Query serial number  
 PROB3:ID:SRN?

**Usage:** Query only

**Manual operation:** See "[Serial Number](#)" on page 409

**[SENSe:]PROBe<pb>:SETup:ATTRatio <AttenuationRatio>**

Defines the attenuation applied to the input at the probe. This setting is only available for modular probes.

**Suffix:**

<pb> 1..n  
 Selects the connector:  
 1 = Baseband Input I  
 2 = Baseband Input Q  
 3 = RF

**Parameters:**

<AttenuationRatio> **10**  
 Attenuation by 20 dB (ratio= 10:1)



2

Attenuation by 6 dB (ratio= 2:1)

\*RST: 10

Default unit: DB

**Manual operation:** See "[Attenuation](#)" on page 410**[SENSe:]PROBe<pb>:SETup:CMOffset <CMOffset>**

Sets the common mode offset. The setting is only available if a differential probe in CM-mode is connected to the FSW.

If the probe is disconnected, the common mode offset of the probe is reset to 0.0 V.

Note that if the offset for DM-mode or CM-mode is changed, the offsets for the P-mode and N-mode are adapted accordingly, and vice versa.

For details see [Chapter 7.2.5.1, "Using probes"](#), on page 403.

**Suffix:**

<pb> 1..n  
 Selects the connector:  
 1 = Baseband Input I  
 2 = Baseband Input Q  
 3 = RF

**Parameters:**

<CMOffset> Offset of the mean voltage between the positive and negative input terminal vs. ground  
 Range: -16 V to +16 V  
 Default unit: V

**Manual operation:** See "[Common Mode Offset / Diff. Mode Offset / P Offset / N Offset /](#)" on page 410**[SENSe:]PROBe<pb>:SETup:DMOffset <DMOffset>**

Sets the DM-mode offset. The setting is only available if a modular probe in DM-mode is connected to the FSW.

If the probe is disconnected, the DM-mode offset of the probe is reset to 0.0 V.

Note that if the offset for DM-mode or CM-mode is changed, the offsets for the P-mode and N-mode are adapted accordingly, and vice versa.

For details see [Chapter 7.2.5.1, "Using probes"](#), on page 403.

**Suffix:**

<pb> 1..n  
 Selects the connector:  
 1 = Baseband Input I  
 2 = Baseband Input Q  
 3 = RF

## Setting basic measurement parameters

**Parameters:**

<DMOffset> Voltage offset between the positive and negative input terminal  
Default unit: V

**Manual operation:** See "[Common Mode Offset / Diff. Mode Offset / P Offset / N Offset /](#)" on page 410

**[SENSe:]PROBe<pb>:SETup:MODE <Mode>**

**Suffix:**

<pb> 1..n  
Selects the connector:  
1 = Baseband Input I  
2 = Baseband Input Q  
3 = RF

**Parameters:**

<Mode> RSINgle | NOAction  
**RSINgle**  
Run single: starts one data acquisition.  
**NOAction**  
Nothing is started on pressing the micro button.

**Manual operation:** See "[Microbutton Action](#)" on page 411

**[SENSe:]PROBe<pb>:SETup:NAME?**

Queries the name of the probe.

**Suffix:**

<pb> 1..n  
Selects the connector:  
1 = Baseband Input I  
2 = Baseband Input Q  
3 = RF

**Return values:**

<Name> String containing the name of the probe.

**Example:** //Query name of the probe  
PROB3:SET:NAME?

**Usage:** Query only

**Manual operation:** See "[Name](#)" on page 409

**[SENSe:]PROBe<pb>:SETup:NMOffset <NMOffset>**

Sets the N-mode offset. The setting is only available if a modular probe in N-mode is connected to the FSW. The maximum voltage difference between the positive and negative input terminals is 16 V.

If the probe is disconnected, the N-mode offset of the probe is reset to 0.0 V.

Note that if the offset for DM-mode or CM-mode is changed, the offsets for the P-mode and N-mode are adapted accordingly, and vice versa.

For details see [Chapter 7.2.5.1, "Using probes"](#), on page 403.

**Suffix:**

<pb> 1..n  
 Selects the connector:  
 1 = Baseband Input I  
 2 = Baseband Input Q  
 3 = RF

**Parameters:**

<NMOffset> The voltage offset between the negative input terminal and ground.  
 Default unit: V

**Manual operation:** See "[Common Mode Offset / Diff. Mode Offset / P Offset / N Offset /](#)" on page 410

**[SENSe:]PROBe<pb>:SETUp:PMODE <Mode>**

Determines the mode of a multi-mode modular probe.

For details see [Chapter 7.2.5.1, "Using probes"](#), on page 403.

**Suffix:**

<pb> 1..n  
 Selects the connector:  
 1 = Baseband Input I  
 2 = Baseband Input Q  
 3 = RF

**Parameters:**

<Mode> CM | DM | PM | NM

**DM**  
 Voltage between the positive and negative input terminal

**CM**  
 Mean voltage between the positive and negative input terminal vs. ground

**PM**  
 Voltage between the positive input terminal and ground

**NM**  
 Voltage between the negative input terminal and ground

**Example:** SENS:PROB:SETU:PMOD PM  
 Sets the probe to P-mode.

**Manual operation:** See "[Mode](#)" on page 410

**[SENSe:]PROBe<pb>:SETup:PMOffset <PMOffset>**

Sets the P-mode offset. The setting is only available if a modular probe in P-mode is connected to the FSW. The maximum voltage difference between the positive and negative input terminals is 16 V.

If the probe is disconnected, the P-mode offset of the probe is reset to 0.0 V.

Note that if the offset for DM-mode or CM-mode is changed, the offsets for the P-mode and N-mode are adapted accordingly, and vice versa.

For details see [Chapter 7.2.5.1, "Using probes"](#), on page 403.

**Suffix:**

<pb> 1..n  
 Selects the connector:  
 1 = Baseband Input I  
 2 = Baseband Input Q  
 3 = RF

**Parameters:**

<PMOffset> The voltage offset between the positive input terminal and ground.  
 Default unit: V

**Manual operation:** See "[Common Mode Offset / Diff. Mode Offset / P Offset / N Offset /](#)" on page 410

**[SENSe:]PROBe<pb>:SETup:STATe?**

Queries if the probe at the specified connector is active (detected) or not active (not detected).

To switch the probe on, i.e. activate input from the connector, use `INP:SEL:AIQ` (see [INPut:SElect](#) on page 1113).

**Suffix:**

<pb> 1..n  
 Selects the connector:  
 1 = Baseband Input I  
 2 = Baseband Input Q  
 3 = RF

**Return values:**

<State> DETected | NDETECTED

**Example:** //Query connector state  
`PROB3:SET:STAT?`

**Usage:** Query only

**[SENSe:]PROBe<pb>:SETup:TYPE?**

Queries the type of the probe.

<b>Suffix:</b>	
<pb>	1..n Selects the connector: 1 = Baseband Input I 2 = Baseband Input Q 3 = RF
<b>Return values:</b>	
<Type>	String containing one of the following values: –"None" (no probe detected) –"active differential" –"active single-ended" –"active modular"
<b>Example:</b>	//Query probe type PROB3:SET:TYPE?
<b>Usage:</b>	Query only
<b>Manual operation:</b>	See " <a href="#">Type</a> " on page 410

### 13.7.1.7 External generator control

External generator control commands are available if the FSW External Generator Control option (R&S FSW-B10) is installed.

For each measurement channel, you can configure one external generator. To switch between different configurations, define multiple measurement channels.

For more information on external generator control, see [Chapter 7.2.4.2, "Basics on external generator control"](#), on page 376.

- [Measurement configuration](#)..... 1165
- [Interface configuration](#)..... 1169
- [Source calibration](#)..... 1171
- [Programming example for external generator control](#)..... 1174

#### Measurement configuration

The following commands are required to activate external generator control and to configure a calibration measurement with an external tracking generator.

<a href="#">SOURce&lt;si&gt;:EXTernal&lt;gen&gt;:FREQuency</a> .....	1165
<a href="#">SOURce&lt;si&gt;:EXTernal&lt;gen&gt;:FREQuency:COUPling[:STATe]</a> .....	1166
<a href="#">SOURce&lt;si&gt;:EXTernal&lt;gen&gt;:FREQuency[:FACTor]:DENominator</a> .....	1166
<a href="#">SOURce&lt;si&gt;:EXTernal&lt;gen&gt;:FREQuency[:FACTor]:NUMerator</a> .....	1167
<a href="#">SOURce&lt;si&gt;:EXTernal&lt;gen&gt;:FREQuency:OFFSet</a> .....	1167
<a href="#">SOURce&lt;si&gt;:EXTernal&lt;gen&gt;:POWer[:LEVel]</a> .....	1168
<a href="#">SOURce&lt;si&gt;:EXTernal&lt;gen&gt;[:STATe]</a> .....	1168
<a href="#">SOURce&lt;si&gt;:POWer[:LEVel][:IMMediate]:OFFSet</a> .....	1169

---

**SOURce<si>:EXTernal<gen>:FREQuency <Frequency>**

Defines a fixed source frequency for the external generator.

**Suffix:**

<si> irrelevant

<gen>

**Parameters:**

<Frequency> Source frequency of the external generator.

\*RST: 1100050000

Default unit: HZ

**Example:**

//Define frequency of the generator

SOUR:EXT:FREQ 10MHz

**Manual operation:** See "(Manual) Source Frequency" on page 387

**SOURce<si>:EXTernal<gen>:FREQuency:COUPling[:STATe] <State>**

Couples the frequency of the external generator output to the FSW.

**Suffix:**

<si> irrelevant

<gen>

**Parameters:**

<State> ON | OFF | 0 | 1

**ON | 1**

Default setting: a series of frequencies is defined (one for each sweep point), based on the current frequency at the RF input of the FSW. The RF frequency range covers the currently defined span of the FSW (unless limited by the range of the signal generator).

**OFF | 0**

The generator uses a single fixed frequency, defined by [SOURce<si>:EXTernal<gen>:FREQuency](#).

\*RST: 1

**Example:**

SOUR:EXT:FREQ:COUP ON

**Manual operation:** See "Source Frequency Coupling" on page 387

**SOURce<si>:EXTernal<gen>:FREQuency[:FACTor]:DENominator <Value>**

Defines the denominator of the factor with which the analyzer frequency is multiplied to obtain the transmit frequency of the selected generator.

Select the multiplication factor such that the frequency range of the generator is not exceeded if the following formula is applied to the start and stop frequency of the analyzer:

$$F_{Generator} = \left| F_{Analyzer} * \frac{Numerator}{Denominator} + F_{Offset} \right|$$

**Suffix:**

&lt;si&gt; irrelevant

&lt;gen&gt;

**Parameters:**

&lt;Value&gt; &lt;numeric value&gt;

\*RST: 1

**Example:**

//Define multiplication factor of 4/3; the transmit frequency of the generator is 4/3 times the analyzer frequency

SOUR:EXT:FREQ:NUM 4

SOUR:EXT:FREQ:DEN 3

**Manual operation:** See "[\(Automatic\) Source Frequency \(Numerator/Denominator/Offset\)](#)" on page 387**SOURce<si>:EXTernal<gen>:FREQuency[:FACTor]:NUMerator <Value>**

Defines the numerator of the factor with which the analyzer frequency is multiplied to obtain the transmit frequency of the selected generator.

Select the multiplication factor such that the frequency range of the generator is not exceeded if the following formula is applied to the start and stop frequency of the analyzer:

$$F_{Generator} = \left| F_{Analyzer} * \frac{Numerator}{Denominator} + F_{Offset} \right|$$

**Suffix:**

&lt;si&gt; irrelevant

&lt;gen&gt;

**Parameters:**

&lt;Value&gt; &lt;numeric value&gt;

\*RST: 1

**Example:**

//Define multiplication factor of 4/3; the transmit frequency of the generator is 4/3 times the analyzer frequency

SOUR:EXT:FREQ:NUM 4

SOUR:EXT:FREQ:DEN 3

**Manual operation:** See "[\(Automatic\) Source Frequency \(Numerator/Denominator/Offset\)](#)" on page 387**SOURce<si>:EXTernal<gen>:FREQuency:OFFSet <Offset>**

Defines the frequency offset of the generator with reference to the analyzer frequency.

Select the offset such that the frequency range of the generator is not exceeded if the following formula is applied to the start and stop frequency of the analyzer:

$$F_{Generator} = \left| F_{Analyzer} * \frac{Numerator}{Denominator} + F_{Offset} \right|$$

**Suffix:**

&lt;si&gt; irrelevant

&lt;gen&gt;

**Parameters:**

&lt;Offset&gt; &lt;numeric value&gt;, specified in Hz, kHz, MHz or GHz, rounded to the nearest Hz

\*RST: 0 Hz

Default unit: HZ

**Example:**

//Define an offset between generator output frequency and analyzer frequency

SOUR:EXT:FREQ:OFFS 10HZ

**Manual operation:**

See "(Automatic) Source Frequency (Numerator/Denominator/Offset)" on page 387

**SOURce<si>:EXTernal<gen>:POWer[:LEVel] <Level>**

Sets the output power of the selected generator.

**Suffix:**

&lt;si&gt; irrelevant

&lt;gen&gt;

**Parameters:**

&lt;Level&gt; &lt;numeric value&gt;

\*RST: -20 dBm

Default unit: DBM

**Example:**

//Define generator output level

SOUR:EXT:POW -30dBm

**Manual operation:**

See "Source Power" on page 387

**SOURce<si>:EXTernal<gen>[:STATe] <State>**

Activates or deactivates the connected external generator.

**Suffix:**

&lt;si&gt; irrelevant

&lt;gen&gt;

**Parameters:**

&lt;State&gt; ON | OFF | 0 | 1

**OFF | 0**

Switches the function off



**ON | 1**

Switches the function on

**Manual operation:** See "[Source State](#)" on page 386**SOURce<si>:POWer[:LEVel][:IMMediate]:OFFSet <Offset>****Suffix:**

&lt;si&gt; irrelevant

**Parameters:**

<Offset> Range: -200 dB to +200 dB  
 \*RST: 0dB  
 Default unit: DB

**Example:** SOUR:POW:OFFS -10dB**Manual operation:** See "[Source Offset](#)" on page 387**Interface configuration**

The following commands are required to configure the interface for the connection to the external generator.

<a href="#">SOURce&lt;si&gt;:EXTernal&lt;gen&gt;:ROSCillator[:SOURce]</a> .....	1169
<a href="#">SYSTem:COMMunicate:GPIB:RDEvice:GENerator&lt;gen&gt;:ADDResS</a> .....	1170
<a href="#">SYSTem:COMMunicate:RDEvice:GENerator&lt;gen&gt;:INTerface</a> .....	1170
<a href="#">SYSTem:COMMunicate:RDEvice:GENerator&lt;gen&gt;:LINK</a> .....	1170
<a href="#">SYSTem:COMMunicate:RDEvice:GENerator&lt;gen&gt;:TYPE</a> .....	1171
<a href="#">SYSTem:COMMunicate:TCPip:RDEvice:GENerator&lt;gen&gt;:ADDResS</a> .....	1171

**SOURce<si>:EXTernal<gen>:ROSCillator[:SOURce] <Source>**

Controls selection of the reference oscillator for the external generator.

If the external reference oscillator is selected, the reference signal must be connected to the rear panel of the instrument.

**Suffix:**

&lt;si&gt; irrelevant

&lt;gen&gt; irrelevant

**Parameters:**

&lt;Source&gt;

**INTernal**

Uses the internal reference.

**EXTernal**

Uses the external reference; if none is available, an error flag is displayed in the status bar.

\*RST: INT

**Example:** //Select an external reference oscillator  
 SOUR:EXT:ROSC EXT

**Manual operation:** See ["Reference"](#) on page 389

### **SYSTem:COMMunicate:GPIB:RDEvice:GENerator<gen>:ADDRess <Number>**

Changes the IEC/IEEE-bus address of the external generator.

**Suffix:**

<gen> 1..n

**Parameters:**

<Number> Range: 0 to 30  
\*RST: 28

**Example:**

SYST:COMM:GPIB:RDEV:GEN:ADDR 15

**Manual operation:** See ["GPIB Address/TCPIP Address / Computer Name"](#) on page 389

### **SYSTem:COMMunicate:RDEvice:GENerator<gen>:INTerface <Type>**

Defines the interface used for the connection to the external generator.

Is only available if external generator control is active (see [SOURCE<si>:EXTernal<gen>\[:STATe\]](#) on page 1168).

**Suffix:**

<gen>

**Parameters:**

<Type> GPIB  
TCPip

**Example:**

SYST:COMM:RDEV:GEN:INT TCP

**Manual operation:** See ["Interface"](#) on page 389

### **SYSTem:COMMunicate:RDEvice:GENerator<gen>:LINK <Type>**

Selects the link type of the external generator if the GPIB interface is used.

The difference between the two GPIB operating modes is the execution speed. During GPIB operation, each frequency to be set is transmitted to the generator separately. If the TTL interface is also used, a whole frequency list can be programmed in one go. Frequencies can then be switched per TTL handshake, which speeds up the process considerably.

Is only available if external generator control is active (see [SOURCE<si>:EXTernal<gen>\[:STATe\]](#) on page 1168).

**Suffix:**

<gen>

**Parameters:**

<Type> GPIB | TTL

**GPIB**

GPIB connection without TTL synchronization (for all generators of other manufacturers and some Rohde & Schwarz devices)

**TTL**

GPIB connection with TTL synchronization (if available; for most Rohde&Schwarz devices)

\*RST: GPIB

**Example:**

```
SYST:COMM:RDEV:GEN:LINK TTL
```

Selects GPIB + TTL interface for generator operation.

**Manual operation:** See "[TTL Handshake](#)" on page 389

**SYSTem:COMMunicate:RDEvice:GENerator<gen>:TYPE <Type>**

Selects the type of external generator.

For a list of the available generator types, see the specifications document.

**Suffix:**

<gen>

**Parameters:**

<Name> <Generator name as string value>

\*RST: SMU02

**Example:**

```
//Select an external generator
```

```
SYST:COMM:RDEV:GEN:TYPE 'SMW06'
```

**Manual operation:** See "[Generator Type](#)" on page 389

**SYSTem:COMMunicate:TCPIp:RDEvice:GENerator<gen>:ADDRess <Address>**

Configures the TCP/IP address for the external generator.

**Suffix:**

<gen>

**Parameters:**

<Address> TCP/IP address between 0.0.0.0 and 0.255.255.255

\*RST: 0.0.0.0

**Example:**

```
SYST:COMM:TCP:RDEV:GEN:ADDR 130.094.122.195
```

**Manual operation:** See "[GPIB Address/TCPIP Address / Computer Name](#)" on page 389

**Source calibration**

The following commands are required to activate the calibration functions of the external tracking generator. However, they are only available if external generator control is active (see [SOURce<si>:EXTernal<gen>\[:STATe\]](#) on page 1168).

Useful commands for source calibration described elsewhere:

- [Chapter 13.10.3, "Working with transducers"](#), on page 1402
- `DISPlay[:WINDow<n>][:SUBWindow<w>]:TRACe<t>:Y[:SCALE]:RPosition` on page 1216

**Remote commands exclusive to source calibration:**

<code>DISPlay[:WINDow&lt;n&gt;][:SUBWindow&lt;w&gt;]:TRACe&lt;t&gt;:Y[:SCALE]:RVALue</code> .....	1172
<code>[SENSe:]CORRection:COLLect[:ACQuire]</code> .....	1172
<code>[SENSe:]CORRection:METhod</code> .....	1173
<code>[SENSe:]CORRection:RECall</code> .....	1173
<code>[SENSe:]CORRection[:STATe]</code> .....	1174
<code>[SENSe:]CORRection:TRANsducer:GENerate</code> .....	1174

---

**`DISPlay[:WINDow<n>][:SUBWindow<w>]:TRACe<t>:Y[:SCALE]:RVALue <Value>`**

Defines the reference value assigned to the reference position in the specified window. Separate reference values are maintained for the various displays.

**Suffix:**

<n>	Window
<w>	subwindow
<t>	irrelevant

**Parameters:**

<Value>	Default unit: DB
---------	------------------

**Example:**

`DISP:TRAC:Y:RVAL 0`

Sets the value assigned to the reference position to 0 Hz

**Manual operation:** See "[Reference Value](#)" on page 392

---

**`[SENSe:]CORRection:COLLect[:ACQuire] <MeasType>`**

Initiates a reference measurement (calibration). The reference measurement is the basis for the measurement normalization. The result depends on whether a reflection measurement or transmission measurement is performed (see [\[SENSe:\]CORRection:METhod](#) on page 1173).

To obtain a correct reference measurement, a complete sweep with synchronization to the end of the sweep must have been carried out. This is only possible in the single sweep mode.

Is only available if external generator control is active (see [SOURce<si>:EXTernal<gen>\[:STATe\]](#) on page 1168).

**Setting parameters:**

<MeasType>	THRough   OPEN
------------	----------------

**THRough**

"TRANsmission" mode: calibration with direct connection between generator and device input

"REFLection" mode: calibration with short circuit at the input

**OPEN**

only allowed in "REFLection" mode: calibration with open input

**Example:**

```
INIT:CONT OFF
```

Selects single sweep operation

```
CORR:METH TRAN
```

Selects a transmission measurement.

```
CORR:COLL THR; *WAI
```

Starts the measurement of reference data using direct connection between generator and device input and waits for the sweep end.

**Usage:**

Setting only

**Manual operation:**

See ["Calibrate Reflection Short"](#) on page 391

See ["Calibrate Reflection Open"](#) on page 391

**[SENSe:]CORRection:METHod <Type>**

Selects the type of measurement to be performed with the generator.

Is only available if external generator control is active (see [SOURCE<si>:EXTernal<gen>\[:STATe\]](#) on page 1168).

**Parameters:**

<Type>

**REFLection**

Selects reflection measurements.

**TRANsmission**

Selects transmission measurements.

```
*RST: TRANsmission
```

**Example:**

```
CORR:METH TRAN
```

Sets the type of measurement to "transmission".

**Manual operation:**

See ["Calibrate Transmission"](#) on page 391

See ["Calibrate Reflection Short"](#) on page 391

See ["Calibrate Reflection Open"](#) on page 391

**[SENSe:]CORRection:RECall**

Restores the measurement configuration used for calibration.

Is only available if external generator control is active (see [SOURCE<si>:EXTernal<gen>\[:STATe\]](#) on page 1168).

**Example:**

```
CORR:REC
```

**Manual operation:**

See ["Recall Cal. Settings"](#) on page 391

**[SENSe:]CORRection[:STATe] <State>**

Turns correction of measurement results (normalization) on and off.

The command is available after you have created a reference trace for the selected measurement type with `[SENSe:]CORRection:COLLect[:ACQuire]` on page 1172.

Is only available if external generator control is active (see `SOURce<si>:EXTernal<gen>[:STATe]` on page 1168).

**Parameters:**

<State>                    ON | OFF | 0 | 1  
**OFF | 0**  
 Switches the function off  
**ON | 1**  
 Switches the function on  
 \*RST:                    1

**Example:**                CORR ON  
 Activates normalization.

**Manual operation:**    See "[Normalization state](#)" on page 391

**[SENSe:]CORRection:TRANsducer:GENerate <Name>**

Uses the normalized measurement data to generate a transducer factor with up to 1001 points. The trace data is converted to a transducer with unit dB and stored in a file with the specified name and the suffix `.trd` under

`C:\Program Files (x86)\Rohde-Schwarz\FSW\<version>\trd`. The frequency points are allocated in equidistant steps between start and stop frequency.

The generated transducer factor can be further adapted using the commands described in [Chapter 13.10.3, "Working with transducers"](#), on page 1402.

**Parameters:**

<Name>                    '<name>'

**Example:**                CORR:TRAN:GEN 'MyGenerator'  
 Creates the transducer file  
`C:\r_s\instr\trd\MyGenerator.trd`.

**Manual operation:**    See "[Save as Trd Factor](#)" on page 392

**Programming example for external generator control**

The following example demonstrates how to work with an external generator in a remote environment.

It assumes that a signal generator of the type SMW06 is connected to the FSW, including TTL synchronization, as described in the FSW User Manual.

```
//-----Preparing the instrument -----
```

## Setting basic measurement parameters

```

//Reset the instrument
*RST

//Set the frequency span.
SENS:FREQ:STAR 10HZ
SENS:FREQ:STOP 1MHZ

//-----Configuring the interface -----

//Set the generator type to SMW06 with a frequency range of 100 kHz to 4GHz
SYST:COMM:RDEV:GEN:TYPE 'SMW06'

//Set the interface used to the GPIB address 28
SYST:COMM:RDEV:GEN:INT GPIB
SYST:COMM:GPIB:RDEV:GEN:ADDR 28

//Activate the use of TTL synchronization to optimize measurement speed
SYST:COMM:RDEV:GEN:LINK TTL

//Activate the use of the external reference frequency at 10 MHz on the generator
SOUR:EXT:ROSC EXT

//-----Configuring the calibration measurement -----

//Activate external generator control.
SOUR:EXT:STAT ON
//Set the generator output level to -10 dBm.
SOUR:EXT:POW -10DBM
//Set the frequency coupling to automatic
SOUR:EXT:FREQ:COUP:STAT ON

//-----Configuring the generator frequency range -----

//Define a series of frequencies (one for each sweep point) based on the current
//frequency at the RF input of the analyzer; the generator frequency is half the
//frequency of the analyzer, with an offset of 100 kHz;
// analyzer start:          10 Hz
// analyzer stop:           1 MHz
// analyzer span:           999.99 KHz
// generator frequency start: 100.005 KHz
// generator frequency stop: 600 KHz
// generator span:          499.995 KHz

SOUR:EXT:FREQ:FACT:NUM 1
SOUR:EXT:FREQ:FACT:DEN 2
SOUR:EXT:FREQ:OFFS 100KHZ

//-----Performing the calibration measurement -----

//Perform a transmission measurement with direct connection between the generator

```

## Setting basic measurement parameters

```

//and the analyzer and wait till the end
SENS:CORR:METH TRAN
SENS:CORR:COLL:ACQ THR; *WAI

//-----Retrieving the calibration trace results -----

//Retrieve the measured frequencies (10 Hz - 600 kHz)
TRAC:DATA:X? TRACE1

//Retrieve the measured power levels; = 0 between 10 Hz and 100 kHz (below
//generator minimum frequency); nominal -5dBm as of 100 kHz;
TRAC:DATA? TRACE1

//-----Normalizing the calibration trace results -----

//Retrieve the normalized power levels (= power offsets from calibration results)
//Should be 0 for all sweep points directly after calibration
SENS:CORR:STAT ON
TRAC:DATA? TRACE1

//-----Changing the display of the calibration results -----
//Shift the reference line so the -5 dB level is displayed in the center
DISP:TRAC:Y:SCAL:RVAL -5DB
DISP:TRAC:Y:SCAL:RPOS 50PCT

```

### 13.7.1.8 Working with power sensors

The following commands describe how to work with power sensors.

These commands require the use of a Rohde & Schwarz power sensor. For a list of supported sensors, see the specifications document.

- [Configuring power sensors](#).....1176
- [Configuring power sensor measurements](#).....1178
- [Triggering with power sensors](#).....1185

#### Configuring power sensors

[SYSTem:COMMunicate:RDEvice:PMETer<p>:CONFigure:AUTO\[:STATe\]](#)..... 1176  
[SYSTem:COMMunicate:RDEvice:PMETer<p>:COUNT?](#)..... 1177  
[SYSTem:COMMunicate:RDEvice:PMETer<p>:DEFine](#).....1177

---

**SYSTem:COMMunicate:RDEvice:PMETer<p>:CONFigure:AUTO[:STATe] <State>**

Turns automatic assignment of a power sensor to the power sensor index on and off.

**Suffix:**

<p>                      Power sensor index



**Parameters:**

<State> ON | OFF | 0 | 1  
 \*RST: 1

**Example:**

SYST:COMM:RDEV:PMET:CONF:AUTO OFF

**Manual operation:** See "Select" on page 370

**SYSTem:COMMunicate:RDEvice:PMETer<p>:COUNT?**

Queries the number of power sensors currently connected to the FSW.

**Suffix:**

<p> Power sensor index

**Return values:**

<NumberSensors> Number of connected power sensors.

**Example:**

SYST:COMM:RDEV:PMET:COUN?

**Usage:**

Query only

**Manual operation:** See "Select" on page 370

**SYSTem:COMMunicate:RDEvice:PMETer<p>:DEFine <Placeholder>, <Type>, <Interface>, <SerialNo>**

Assigns the power sensor with the specified serial number to the selected power sensor index (configuration).

The query returns the power sensor type and serial number of the sensor assigned to the specified index.

**Suffix:**

<p> Power sensor index

**Parameters:**

<Placeholder> Currently not used

<Type> Detected power sensor type, e.g. "NRP-Z81".

<Interface> Interface the power sensor is connected to; always "USB"

<SerialNo> Serial number of the power sensor assigned to the specified index

**Example:**

```
SYST:COMM:RDEV:PMET2:DEF ' ', 'NRP-Z81', ' ', '123456'
```

Assigns the power sensor with the serial number '123456' to the configuration "Power Sensor 2".

```
SYST:COMM:RDEV:PMET2:DEF?
```

Queries the sensor assigned to "Power Sensor 2".

Result:

```
' ', 'NRP-Z81', 'USB', '123456'
```

The NRP-Z81 power sensor with the serial number '123456' is assigned to the "Power Sensor 2".

**Manual operation:** See "Select" on page 370

### Configuring power sensor measurements

CALibration:PMETer<p>:ZERO:AUTO ONCE.....	1178
CALCulate<n>:PMETer<p>:RELative[:MAGNitude].....	1178
CALCulate<n>:PMETer<p>:RELative[:MAGNitude]:AUTO ONCE.....	1179
CALCulate<n>:PMETer<p>:RELative:STATe.....	1179
FEtCh:PMETer<p>?.....	1179
REAde:PMETer<p>?.....	1180
[SENSe:]PMETer<p>:DCYClE[:STATe].....	1180
[SENSe:]PMETer<p>:DCYClE:VALue.....	1180
[SENSe:]PMETer<p>:FREQuency.....	1181
[SENSe:]PMETer<p>:FREQuency:LiNK.....	1181
[SENSe:]PMETer<p>:MTIME.....	1181
[SENSe:]PMETer<p>:MTIME:AVERAge:COUNt.....	1182
[SENSe:]PMETer<p>:MTIME:AVERAge[:STATe].....	1182
[SENSe:]PMETer<p>:ROFFset[:STATe].....	1182
[SENSe:]PMETer<p>:SOFFset.....	1183
[SENSe:]PMETer<p>[:STATe].....	1183
[SENSe:]PMETer<p>:UPDate[:STATe].....	1183
UNIt<n>:PMETer<p>:POWEr.....	1184
UNIt<n>:PMETer<p>:POWEr:RATIo.....	1184

---

### CALibration:PMETer<p>:ZERO:AUTO ONCE

Zeroes the power sensor.

Note that you have to disconnect the signals from the power sensor input before you start to zero the power sensor. Otherwise, results are invalid.

**Suffix:**

<p> Power sensor index

**Example:**

```
CAL:PMET2:ZERO:AUTO ONCE;*WAI
```

Starts zeroing the power sensor 2 and delays the execution of further commands until zeroing is concluded.

**Usage:**

Event

**Manual operation:** See "Zeroing Power Sensor" on page 370

---

### CALCulate<n>:PMETer<p>:RELative[:MAGNitude] <RefValue>

Defines the reference value for relative measurements.

**Suffix:**

<n> Window

<p> Power sensor index

## Setting basic measurement parameters

**Parameters:**

<RefValue>            Range:        -200 dBm to 200 dBm  
 \*RST:                0  
 Default unit: DBM

**Example:**

CALC:PMET2:REL -30  
 Sets the reference value for relative measurements to -30 dBm for power sensor 2.

**Manual operation:** See ["Reference Value"](#) on page 371

**CALCulate<n>:PMETer<p>:RELative[:MAGNitude]:AUTO ONCE**

Sets the current measurement result as the reference level for relative measurements.

**Suffix:**

<n>                    [Window](#)

<p>                    Power sensor index

**Example:**

CALC:PMET2:REL:AUTO ONCE  
 Takes the current measurement value as reference value for relative measurements for power sensor 2.

**Usage:**             Event

**Manual operation:** See ["Setting the Reference Level from the Measurement Measurements -> Ref"](#) on page 371

**CALCulate<n>:PMETer<p>:RELative:STATe <State>**

Turns relative power sensor measurements on and off.

**Suffix:**

<n>                    [Window](#)

<p>                    Power sensor index

**Parameters:**

<State>              ON | OFF | 0 | 1  
**OFF | 0**  
 Switches the function off  
**ON | 1**  
 Switches the function on

**Example:**

CALC:PMET2:REL:STAT ON  
 Activates the relative display of the measured value for power sensor 2.

**FETCH:PMETer<p>?**

Queries the results of power sensor measurements.

**Suffix:**  
<p> Power sensor index

**Usage:** Query only

**READ:PMETer<p>?**

Initiates a power sensor measurement and queries the results.

**Suffix:**  
<p> Power sensor index

**Usage:** Query only

**[SENSe:]PMETer<p>:DCYClE[:STATe] <State>**

Turns the duty cycle correction on and off.

**Suffix:**  
<p> Power sensor index

**Parameters:**  
<State> ON | OFF | 0 | 1  
**OFF | 0**  
Switches the function off  
**ON | 1**  
Switches the function on

**Example:** PMET2:DCYC:STAT ON

**Manual operation:** See "[Duty Cycle](#)" on page 372

**[SENSe:]PMETer<p>:DCYClE:VALue <Percentage>**

Defines the duty cycle for the correction of pulse signals.

The power sensor uses the duty cycle in combination with the mean power to calculate the power of the pulse.

**Suffix:**  
<p> Power sensor

**Parameters:**  
<Percentage> Range: 0.001 to 99.999  
\*RST: 99.999  
Default unit: %

**Example:** PMET2:DCYC:STAT ON  
Activates the duty cycle correction.  
PMET2:DCYC:VAL 0.5  
Sets the correction value to 0.5%.

**Manual operation:** See "[Duty Cycle](#)" on page 372

---

**[SENSe:]PMETer<p>:FREQUency <Frequency>**

Defines the frequency of the power sensor.

**Suffix:**

<p> Power sensor index

**Parameters:**

<Frequency> The available value range is specified in the specifications document of the power sensor in use.

\*RST: 50 MHz

Default unit: HZ

**Example:**

PMET2:FREQ 1GHZ

Sets the frequency of the power sensor to 1 GHz.

**Manual operation:** See "[Frequency Manual](#)" on page 370

---

**[SENSe:]PMETer<p>:FREQUency:LINK <Coupling>**

Selects the frequency coupling for power sensor measurements.

**Suffix:**

<p> Power sensor index

**Parameters:**

<Coupling>

**CENTER**

Couples the frequency to the center frequency of the analyzer

**MARKer1**

Couples the frequency to the position of marker 1

**OFF**

Switches the frequency coupling off

\*RST: CENTER

**Example:**

PMET2:FREQ:LINK CENT

Couples the frequency to the center frequency of the analyzer

**Manual operation:** See "[Frequency Coupling](#)" on page 370

---

**[SENSe:]PMETer<p>:MTIME <Duration>**

Selects the duration of power sensor measurements.

**Suffix:**

<p> Power sensor index

**Parameters:**

<Duration>

SHORT | NORMAl | LONG

\*RST: NORMAl

**Example:**

PMET2:MTIM SHOR

Sets a short measurement duration for measurements of stationary high power signals for the selected power sensor.

**Manual operation:** See "[Meas Time/Average](#)" on page 371

---

**[SENSe:]PMETer<p>:MTIMe:AVERage:COUNT** <NumberReadings>

Sets the number of power readings included in the averaging process of power sensor measurements.

Extended averaging yields more stable results for power sensor measurements, especially for measurements on signals with a low power, because it minimizes the effects of noise.

**Suffix:**

<p> Power sensor index

**Parameters:**

<NumberReadings> An average count of 0 or 1 performs one power reading.

Range: 0 to 256

Increment: binary steps (1, 2, 4, 8, ...)

**Example:**

PMET2:MTIM:AVER ON

Activates manual averaging.

PMET2:MTIM:AVER:COUN 8

Sets the number of readings to 8.

**Manual operation:** See "[Average Count \(Number of Readings\)](#)" on page 372

---

**[SENSe:]PMETer<p>:MTIMe:AVERage[:STATe]** <State>

Turns averaging for power sensor measurements on and off.

**Suffix:**

<p> Power sensor index

**Parameters:**

<State> ON | OFF | 0 | 1

**OFF | 0**

Switches the function off

**ON | 1**

Switches the function on

**Example:**

PMET2:MTIM:AVER ON

Activates manual averaging.

**Manual operation:** See "[Meas Time/Average](#)" on page 371

---

**[SENSe:]PMETer<p>:ROFFset[:STATe]** <State>

Includes or excludes the reference level offset of the analyzer for power sensor measurements.

**Suffix:**  
 <p> Power sensor index

**Parameters:**  
 <State> ON | OFF | 0 | 1  
**OFF | 0**  
 Switches the function off  
**ON | 1**  
 Switches the function on

**Example:** PMET2:ROFF OFF  
 Takes no offset into account for the measured power.

**Manual operation:** See ["Use Ref Level Offset"](#) on page 371

#### [SENSe:]PMETer<p>:SOFFset <SensorOffset>

Takes the specified offset into account for the measured power. Only available if [\[SENSe:\]PMETer<p>:ROFFset \[ :STATe\]](#) is disabled.

**Suffix:**  
 <p> Power sensor index

**Parameters:**  
 <SensorOffset> Default unit: DB

**Example:** PMET2:SOFF 0.001

**Manual operation:** See ["Sensor Level Offset"](#) on page 372

#### [SENSe:]PMETer<p>[:STATe] <State>

Turns a power sensor on and off.

**Suffix:**  
 <p> Power sensor index

**Parameters:**  
 <State> ON | OFF | 0 | 1  
**OFF | 0**  
 Switches the function off  
**ON | 1**  
 Switches the function on

**Example:** PMET1 ON  
 Switches the power sensor measurements on.

**Manual operation:** See ["Select"](#) on page 370

#### [SENSe:]PMETer<p>:UPDate[:STATe] <State>

Turns continuous update of power sensor measurements on and off.

If on, the results are updated even if a single sweep is complete.

**Suffix:**

<p> Power sensor index

**Parameters:**

<State> ON | OFF | 0 | 1

**OFF | 0**

Switches the function off

**ON | 1**

Switches the function on

**Example:**

PMET1:UPD ON

The data from power sensor 1 is updated continuously.

**Manual operation:** See ["Continuous Value Update"](#) on page 370

**UNIT<n>:PMETer<p>:POWer <Unit>**

Selects the unit for absolute power sensor measurements.

**Suffix:**

<n> irrelevant

<p> Power sensor index

**Parameters:**

<Unit> DBM | WATT | W | DB | PCT

\*RST: DBM

**Example:**

UNIT:PMET:POW DBM

**Manual operation:** See ["Unit/Scale"](#) on page 371

**UNIT<n>:PMETer<p>:POWER:RATio <Unit>**

Selects the unit for relative power sensor measurements.

**Suffix:**

<n> irrelevant

<p> Power sensor index

**Parameters:**

<Unit> DB | PCT

\*RST: DB

**Example:**

UNIT:PMET:POW:RAT DB

**Manual operation:** See ["Unit/Scale"](#) on page 371



**Triggering with power sensors**

[SENSe:]PMETer<p>:TRIGger:DTIME.....	1185
[SENSe:]PMETer<p>:TRIGger:HOLDoff.....	1185
[SENSe:]PMETer<p>:TRIGger:HYSTeresis.....	1185
[SENSe:]PMETer<p>:TRIGger:LEVel.....	1186
[SENSe:]PMETer<p>:TRIGger:SLOPe.....	1186
[SENSe:]PMETer<p>:TRIGger[:STATe].....	1186

**[SENSe:]PMETer<p>:TRIGger:DTIME <Time>**

Defines the time period that the input signal has to stay below the IF power trigger level before the measurement starts.

**Suffix:**

<p> Power sensor index

**Parameters:**

<Time> Range: 0 s to 1 s  
 Increment: 100 ns  
 \*RST: 100 µs  
 Default unit: S

**Example:** PMET2:TRIG:DTIME 0.001

**[SENSe:]PMETer<p>:TRIGger:HOLDoff <Holdoff>**

Defines the trigger holdoff for external power triggers.

**Suffix:**

<p> Power sensor index

**Parameters:**

<Holdoff> Time period that has to pass between the trigger event and the start of the measurement, in case another trigger event occurs.  
 Range: 0 s to 1 s  
 Increment: 100 ns  
 \*RST: 0 s  
 Default unit: S

**Example:** PMET2:TRIG:HOLD 0.1  
 Sets the holdoff time of the trigger to 100 ms

**Manual operation:** See "[Trigger Holdoff](#)" on page 373

**[SENSe:]PMETer<p>:TRIGger:HYSTeresis <Hysteresis>**

Defines the trigger hysteresis for external power triggers.

The hysteresis in dB is the value the input signal must stay below the IF power trigger level to allow a trigger to start the measurement.

**Suffix:**

<p> Power sensor index

**Parameters:**

<Hysteresis>            Range:     3 dB to 50 dB  
                               Increment: 1 dB  
                               \*RST:     0 dB  
                               Default unit: DB

**Example:**

PMET2:TRIG:HYST 10  
 Sets the hysteresis of the trigger to 10 dB.

**Manual operation:** See "[Hysteresis](#)" on page 373

**[SENSe:]PMETer<p>:TRIGger:LEVel <Level>**

Defines the trigger level for external power triggers.

**Suffix:**

<p>                        Power sensor index

**Parameters:**

<Level>                 -20 to +20 dBm  
                               Range:     -20 dBm to 20 dBm  
                               \*RST:     -10 dBm  
                               Default unit: DBM

**Example:**

PMET2:TRIG:LEV -10 dBm  
 Sets the level of the trigger

**Manual operation:** See "[External Trigger Level](#)" on page 372

**[SENSe:]PMETer<p>:TRIGger:SLOPe <Edge>**

Selects the trigger condition for external power triggers.

**Suffix:**

<p>                        Power sensor index

**Parameters:**

<Edge>                 **POSitive**  
                               The measurement starts in case the trigger signal shows a positive edge.  
                               **NEGative**  
                               The measurement starts in case the trigger signal shows a negative edge.  
                               \*RST:     POSitive

**Example:**

PMET2:TRIG:SLOP NEG

**Manual operation:** See "[Slope](#)" on page 373

**[SENSe:]PMETer<p>:TRIGger[:STATe] <State>**

Turns the external power trigger on and off.

<b>Suffix:</b>	
<p>	Power sensor index
<b>Parameters:</b>	
<State>	ON   OFF   0   1 <b>OFF   0</b> Switches the function off <b>ON   1</b> Switches the function on
<b>Example:</b>	PMET2:TRIG ON Switches the external power trigger on
<b>Manual operation:</b>	See <a href="#">"Using the power sensor as an external trigger"</a> on page 372

### 13.7.1.9 Configuring the outputs

The following commands are required to provide output from the FSW.



Configuring trigger input/output is described in [Chapter 13.7.5.3, "Configuring the trigger output"](#), on page 1229.

<a href="#">DIAGnostic:SERVice:NSource</a> .....	1187
<a href="#">OUTPut:IF:SBANd?</a> .....	1188
<a href="#">OUTPut:IF[:SOURce]</a> .....	1188
<a href="#">OUTPut:IF:IFFRequency</a> .....	1189
<a href="#">OUTPut:UPORt:STATe</a> .....	1189
<a href="#">OUTPut:UPORt[:VALue]</a> .....	1189
<a href="#">SYSTem:SPEaker:VOLume</a> .....	1190

---

#### **DIAGnostic:SERVice:NSource** <State>

Turns the 28 V supply of the BNC connector labeled [noise source control] on the FSW on and off.

#### **Parameters:**

<State>	ON   OFF   0   1 <b>OFF   0</b> Switches the function off <b>ON   1</b> Switches the function on
---------	--------------------------------------------------------------------------------------------------------------

**Example:** DIAG:SERV:NSO ON

**Manual operation:** See ["Noise Source Control"](#) on page 468

**OUTPut:IF:SBAND?**

Queries the sideband provided at the "IF OUT 2 GHz" connector compared to the sideband of the RF signal. The sideband depends on the current center frequency.

Is available only if the output is configured for IF2 (see [OUTPut:IF\[:SOURce\]](#) on page 1188).

For more information and prerequisites see [Chapter 7.2.1.2, "IF and video signal output"](#), on page 360.

**Return values:**

&lt;SideBand&gt;

**NORMAL**

The sideband at the output is identical to the RF signal.

**INVERTed**

The sideband at the output is the inverted RF signal sideband.

**Example:**

```
OUTP:IF IF2
```

Activates output at the IF OUTPUT (2 GHz) connector.

```
OUTP:IF:SBAN?
```

Queries the sideband provided at the connector.

**Usage:**

Query only

**OUTPut:IF[:SOURce] <Source>**

Defines the type of signal available at one of the output connectors of the FSW.

For restrictions and more information see [Chapter 7.2.1.2, "IF and video signal output"](#), on page 360.

**Parameters:**

&lt;Source&gt;

**IF**

The measured IF value is available at the IF/VIDEO/DEMODO output connector.

The frequency at which the IF value is provided is defined using the [OUTPut:IF:IFFRequency](#) command.

**VIDeo**

The displayed video signal (i.e. the filtered and detected IF signal, 200mV) is available at the IF/VIDEO/DEMODO output connector.

This setting is required to provide demodulated audio frequencies at the output.

```
*RST: IF
```

**Example:**

```
OUTP:IF VID
```

Selects the video signal for the IF/VIDEO/DEMODO output connector.

**Manual operation:** See ["Data Output"](#) on page 467

**OUTPut:IF:IFFrequency** <Frequency>

Defines the frequency for the IF output of the FSW. The IF frequency of the signal is converted accordingly.

Is available in the time domain and if the IF/VIDEO/DEMODO output is configured for IF.

For more information see [Chapter 7.2.1.2, "IF and video signal output"](#), on page 360.

**Parameters:**

<Frequency>                \*RST:        50.0 MHz  
                                   Default unit: HZ

**Manual operation:**    See "[Data Output](#)" on page 467

**OUTPut:UPORT:STATe** <State>

Toggles the control lines of the user ports for the **AUX PORT** connector. This 9-pole SUB-D male connector is located on the rear panel of the FSW.

**Parameters:**

<State>                     ON | OFF | 0 | 1  
                                   **OFF | 0**  
                                   User port is switched to INPut  
                                   **ON | 1**  
                                   User port is switched to OUTPut

**Example:**                 OUTP:UPOR:STAT ON

**OUTPut:UPORt[:VALue]** <Value>

Sets the control lines of the user ports.

The assignment of the pin numbers to the bits is as follows:

Bit	7	6	5	4	3	2	1	0
Pin	N/A	N/A	5	3	4	7	6	2

Bits 7 and 6 are not assigned to pins and must always be 0.

The user port is written to with the given binary pattern.

If the user port is programmed to input instead of output (see [INPut:UPORt:STATe](#) on page 1114), the output value is temporarily stored.

**Parameters:**

<Value>                     bit values in hexadecimal format  
                                   TTL type voltage levels (max. 5V)  
                                   Range:        #B00000000 to #B00111111

**Example:**                 OUTP:UPOR #B00100100  
                                   Sets pins 5 and 7 to 5 V.

**SYSTem:SPEaker:VOLume <Volume>**

Defines the volume of the built-in loudspeaker for demodulated signals. This setting is maintained for all applications.

The command is available in the time domain in Spectrum mode and in Analog Modulation Analysis mode.

**Parameters:**

<Volume> Percentage of the maximum possible volume.  
 Range: 0 to 1  
 \*RST: 0.5

**Example:**

SYST:SPE:VOL 0  
 Switches the loudspeaker to mute.

**Manual operation:** See "Data Output" on page 467

**13.7.2 Defining the frequency and span**

The commands required to configure the frequency and span settings in a remote environment are described here. The tasks for manual operation are described in [Chapter 7.3, "Frequency and span configuration"](#), on page 471.

- [Defining the frequency range](#)..... 1190
- [Configuring signal tracking](#)..... 1196

**13.7.2.1 Defining the frequency range**

The following commands are required to define the frequency range.

<a href="#">CALCulate&lt;n&gt;:MARKer&lt;m&gt;:FUNCTION:CENTer</a> .....	1190
<a href="#">CALCulate&lt;n&gt;:MARKer&lt;m&gt;:FUNCTION:CSep</a> .....	1191
<a href="#">DISPlay[:WINDow&lt;n&gt;][:SUBWindow&lt;w&gt;]:TRACe&lt;t&gt;:X:SPACing</a> .....	1191
<a href="#">[SENSe:]FREQuency:ANNotation</a> .....	1191
<a href="#">[SENSe:]FREQuency:CENTer</a> .....	1192
<a href="#">[SENSe:]FREQuency:CENTer:STEP</a> .....	1193
<a href="#">[SENSe:]FREQuency:CENTer:STEP:AUTO</a> .....	1193
<a href="#">[SENSe:]FREQuency:CENTer:STEP:LINK</a> .....	1193
<a href="#">[SENSe:]FREQuency:CENTer:STEP:LINK:FACTor</a> .....	1194
<a href="#">[SENSe:]FREQuency:OFFSet</a> .....	1194
<a href="#">[SENSe:]FREQuency:SPAN</a> .....	1194
<a href="#">[SENSe:]FREQuency:SPAN:FULL</a> .....	1195
<a href="#">[SENSe:]FREQuency:STARt</a> .....	1195
<a href="#">[SENSe:]FREQuency:STOP</a> .....	1195

**CALCulate<n>:MARKer<m>:FUNCTION:CENTer**

Matches the center frequency to the frequency of a marker.

If you use the command in combination with a delta marker, that delta marker is turned into a normal marker.

**Suffix:**<n> [Window](#)<m> [Marker](#)**Example:**

CALC:MARK2:FUNC:CENT

Sets the center frequency to the frequency of marker 2.

**Manual operation:** See "[Center Frequency = Marker Frequency](#)" on page 565**CALCulate<n>:MARKer<m>:FUNCTion:CSTep**

Matches the center frequency step size to the current marker frequency.

The command turns delta markers into normal markers.

**Suffix:**<n> [Window](#)<m> [Marker](#)**DISPlay[:WINDow<n>][:SUBWindow<w>]:TRACe<t>:X:SPACing <Scale>**

Selects the scaling of the x-axis.

**Suffix:**<n> [Window](#)

&lt;w&gt; subwindow

&lt;t&gt;

**Parameters:**<Scale> **LOGarithmic**  
Logarithmic scaling.**LINear**  
Linear scaling.

\*RST: LINear

**Example:**

DISP:TRAC:X:SPAC LOG

**Manual operation:** See "[Frequency Axis Scaling](#)" on page 349**[SENSe:]FREQuency:ANNOtation <Mode>**

Switches the labelling of the y-axis for frequency-based result diagrams. The frequency range itself is not changed.

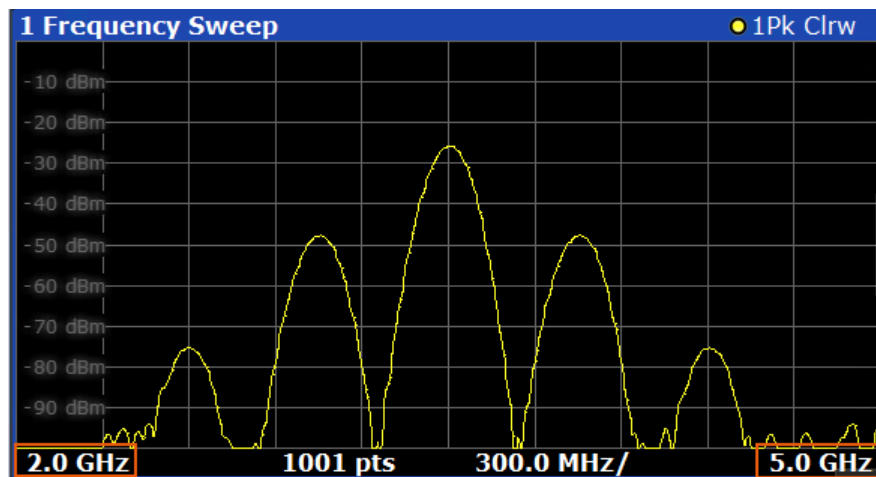

Is not available in all applications and measurements.

**Parameters:**

<Mode> CSPan | SSTop  
**CSPan**  
span / center  
**SSTop**  
start / stop frequency

**Example:** `FREQ:ANN SST`

**[SENSe:]FREQuency:CENTer <Frequency>**

Defines the center frequency.

**Parameters:**

<Frequency> For the allowed range and  $f_{\max}$ , refer to the specifications document.

**UP**

Increases the center frequency by the step defined using the `[SENSe:]FREQuency:CENTer:STEP` command.

**DOWN**

Decreases the center frequency by the step defined using the `[SENSe:]FREQuency:CENTer:STEP` command.

\*RST:  $f_{\max}/2$

Default unit: Hz

**Example:**

```
FREQ:CENT 100 MHz
FREQ:CENT:STEP 10 MHz
FREQ:CENT UP
Sets the center frequency to 110 MHz.
```

**Manual operation:**

See "[f<sub>Analyzer</sub>](#)" on page 231  
See "[Center Frequency](#)" on page 474  
See "[Frequency](#)" on page 513



**[SENSe:]FREQuency:CENTer:STEP <StepSize>**

Defines the center frequency step size.

You can increase or decrease the center frequency quickly in fixed steps using the `SENS:FREQ UP` AND `SENS:FREQ DOWN` commands, see [\[SENSe:\]FREQuency:CENTer](#) on page 1192.

**Parameters:**

<StepSize> For  $f_{max}$ , refer to the specifications document.  
 Range: 1 to fMAX  
 \*RST: 0.1 x span  
 Default unit: Hz

**Example:**

```
//Set the center frequency to 110 MHz.
FREQ:CENT 100 MHz
FREQ:CENT:STEP 10 MHz
FREQ:CENT UP
```

**Manual operation:** See ["Center Frequency Stepsize"](#) on page 476

**[SENSe:]FREQuency:CENTer:STEP:AUTO <State>**

Couples or decouples the center frequency step size to the span.

In time domain (zero span) measurements, the center frequency is coupled to the RBW.

**Parameters:**

<State> ON | OFF | 0 | 1  
 \*RST: 1

**Example:**

```
FREQ:CENT:STEP:AUTO ON
Activates the coupling of the step size to the span.
```

**[SENSe:]FREQuency:CENTer:STEP:LINK <CouplingType>**

Couples and decouples the center frequency step size to the span or the resolution bandwidth.

**Parameters:**

<CouplingType> SPAN | RBW | OFF

**SPAN**

Couples the step size to the span. Available for measurements in the frequency domain.

**RBW**

Couples the step size to the resolution bandwidth. Available for measurements in the time domain.

**OFF**

Decouples the step size.

\*RST: SPAN

**Example:** //Couple step size to span  
 FREQ:CENT:STEP:LINK SPAN

**Manual operation:** See "[Center Frequency Stepsize](#)" on page 476

**[SENSe:]FREQuency:CENTer:STEP:LINK:FACTOR <Factor>**

Defines a step size factor if the center frequency step size is coupled to the span or the resolution bandwidth.

**Parameters:**

<Factor> 1 to 100 PCT  
 \*RST: 10  
 Default unit: PCT

**Example:** //Couple frequency step size to span and define a step size factor  
 FREQ:CENT:STEP:LINK SPAN  
 FREQ:CENT:STEP:LINK:FACT 20PCT

**Manual operation:** See "[Center Frequency Stepsize](#)" on page 476

**[SENSe:]FREQuency:OFFSet <Offset>**

Defines a frequency offset.

If this value is not 0 Hz, the application assumes that the input signal was frequency shifted outside the application. All results of type "frequency" will be corrected for this shift numerically by the application.

See also "[Frequency Offset](#)" on page 476.

**Note:** In MSRA/MSRT mode, the setting command is only available for the MSRA/MSRT primary application. For MSRA/MSRT secondary applications, only the query command is available.

**Parameters:**

<Offset> Range: -1 THz to 1 THz  
 \*RST: 0 Hz  
 Default unit: HZ

**Example:** FREQ:OFFS 1GHZ

**Manual operation:** See "[Frequency Offset](#)" on page 476

**[SENSe:]FREQuency:SPAN <Span>**

Defines the frequency span.

If you set a span of 0 Hz in the Spectrum application, the FSW starts a measurement in the time domain.

## Setting basic measurement parameters

**Parameters:**

<Span> The minimum span for measurements in the frequency domain is 10 Hz.  
 For SEM and spurious emission measurements, the minimum span is 20 Hz.  
 Range: 0 Hz to fmax  
 \*RST: Full span  
 Default unit: Hz

**Manual operation:** See ["Zero Span"](#) on page 129  
 See ["Span"](#) on page 474  
 See ["Zero Span"](#) on page 475  
 See ["Last Span"](#) on page 475

**[SENSe:]FREQuency:SPAN:FULL**

Restores the full span.

**Manual operation:** See ["Full Span"](#) on page 475

**[SENSe:]FREQuency:STARt <Frequency>**

Defines a start frequency for measurements in the frequency domain.

**Parameters:**

<Frequency> 0 to (fmax - min span)  
 \*RST: 0  
 Default unit: HZ

**Example:** `FREQ:STAR 20MHz`

**Manual operation:** See ["Frequency Sweep"](#) on page 129  
 See ["Start / Stop"](#) on page 475

**[SENSe:]FREQuency:STOP <Frequency>**

Defines a stop frequency for measurements in the frequency domain.

**Parameters:**

<Frequency> min span to fmax  
 \*RST: fmax  
 Default unit: HZ

**Example:** `FREQ:STOP 2000 MHz`

**Manual operation:** See ["Frequency Sweep"](#) on page 129  
 See ["Start / Stop"](#) on page 475

### 13.7.2.2 Configuring signal tracking

When signal tracking is activated, the maximum signal is determined after each frequency sweep and the center frequency is set to the frequency of this signal. Thus with drifting signals the center frequency follows the signal.

For more details see [Chapter 7.3.1, "Impact of the frequency and span settings"](#), on page 471..

<a href="#">CALCulate&lt;n&gt;:MARKer&lt;m&gt;:FUNCTION:STRack[:STATe]</a> .....	1196
<a href="#">CALCulate&lt;n&gt;:MARKer&lt;m&gt;:FUNCTION:STRack:BWIDth</a> .....	1196
<a href="#">CALCulate&lt;n&gt;:MARKer&lt;m&gt;:FUNCTION:STRack:BANDwidth</a> .....	1196
<a href="#">CALCulate&lt;n&gt;:MARKer&lt;m&gt;:FUNCTION:STRack:THReshold</a> .....	1197
<a href="#">CALCulate&lt;n&gt;:MARKer&lt;m&gt;:FUNCTION:STRack:TRACe</a> .....	1197

---

#### **CALCulate<n>:MARKer<m>:FUNCTION:STRack[:STATe] <State>**

Turns signal tracking on and off.

##### **Suffix:**

<n>                    irrelevant  
 <m>                    irrelevant

##### **Parameters:**

<State>                ON | OFF | 0 | 1  
                           **OFF | 0**  
                           Switches the function off  
                           **ON | 1**  
                           Switches the function on

##### **Example:**

```
//Activate signal tracking to keep the center frequency on the signal peak
//After each sweep the maximum on trace 1 is searched within a range of 20MHz
//around the center frequency. It must have a minimum power of -90dBm.
CALC:MARK:FUNC:STR ON
CALC:MARK:FUNC:STR:BAND 20MHz
CALC:MARK:FUNC:STR:THR -90dBm
CALC:MARK:FUNC:STR:TRAC 1
```

**Manual operation:** See "[Signal Tracking](#)" on page 477

---

#### **CALCulate<n>:MARKer<m>:FUNCTION:STRack:BWIDth <Bandwidth>**

#### **CALCulate<n>:MARKer<m>:FUNCTION:STRack:BANDwidth <Bandwidth>**

Defines the bandwidth around the center frequency that is included in the signal tracking process.

Note that you have to turn on signal tracking before you can use the command.

##### **Suffix:**

<n>                    irrelevant  
 <m>                    irrelevant

**Parameters:**

<Bandwidth>            Range:        10 Hz to Max span  
                              \*RST:        (= span/10 on activating the function)  
                              Default unit: Hz

**Manual operation:** See "[Signal Tracking](#)" on page 477

**CALCulate<n>:MARKer<m>:FUNCTION:STRack:THReshold <Level>**

Defines the threshold level for the signal tracking process.

Note that you have to turn on signal tracking before you can use the command.

**Suffix:**

<n>                        irrelevant

<m>                        irrelevant

**Parameters:**

<Level>                    The unit depends on [CALCulate<n>:UNIT:POWER](#).  
                              Range:        -130 dBm to 30 dBm  
                              \*RST:        -120 dBm  
                              Default unit: DBM

**Manual operation:** See "[Signal Tracking](#)" on page 477

**CALCulate<n>:MARKer<m>:FUNCTION:STRack:TRACe <TraceNumber>**

Selects the trace on which the largest signal is searched for.

**Suffix:**

<n>                        irrelevant

<m>                        irrelevant

**Parameters:**

<TraceNumber>            1 to 6  
                              Range:        1 to 6  
                              \*RST:        1

**Manual operation:** See "[Signal Tracking](#)" on page 477

### 13.7.3 Configuring bandwidth and sweep settings

The commands required to configure the bandwidth, sweep and filter settings in a remote environment are described here. The tasks for manual operation are described in [Chapter 7.5, "Bandwidth, filter and sweep configuration"](#), on page 492.

- [Configuring the bandwidth and filter](#)..... 1198
- [Configuring the sweep](#)..... 1201

### 13.7.3.1 Configuring the bandwidth and filter

[SENSe:]BWIDth[:RESolution].....	1198
[SENSe:]BANDwidth[:RESolution].....	1198
[SENSe:]BWIDth[:RESolution]:AUTO.....	1198
[SENSe:]BANDwidth[:RESolution]:AUTO.....	1198
[SENSe:]BWIDth[:RESolution]:RATio.....	1199
[SENSe:]BANDwidth[:RESolution]:RATio.....	1199
[SENSe:]BWIDth[:RESolution]:TYPE.....	1199
[SENSe:]BANDwidth[:RESolution]:TYPE.....	1199
[SENSe:]BWIDth:VIDeo.....	1200
[SENSe:]BANDwidth:VIDeo.....	1200
[SENSe:]BWIDth:VIDeo:AUTO.....	1200
[SENSe:]BANDwidth:VIDeo:AUTO.....	1200
[SENSe:]BWIDth:VIDeo:RATio.....	1200
[SENSe:]BANDwidth:VIDeo:RATio.....	1200
[SENSe:]BWIDth:VIDeo:TYPE.....	1201
[SENSe:]BANDwidth:VIDeo:TYPE.....	1201

---

**[SENSe:]BWIDth[:RESolution]** <Bandwidth>

**[SENSe:]BANDwidth[:RESolution]** <Bandwidth>

Defines the resolution bandwidth and decouples the resolution bandwidth from the span.

In the Real-Time application, the resolution bandwidth is always coupled to the span.

For statistics measurements, this command defines the **demodulation** bandwidth.

The 6 MHz Gaussian filter is provided for special measurements, such as 5G NR spurious emissions measurements. It is only available if you enter the value manually, not using the `BAND:RES MAX` command. It is not supported by all applications.

**Parameters:**

<Bandwidth> refer to specifications document  
 \*RST: RBW: AUTO is set to ON; DBW: 3MHz  
 Default unit: Hz

**Example:**

BAND 1 MHz  
 Sets the resolution bandwidth to 1 MHz

**Manual operation:**

See "[Analysis Bandwidth](#)" on page 298  
 See "[RBW](#)" on page 347  
 See "[Res BW CISPR](#)" on page 349  
 See "[Res BW MIL](#)" on page 349  
 See "[RBW](#)" on page 513

---

**[SENSe:]BWIDth[:RESolution]:AUTO** <State>

**[SENSe:]BANDwidth[:RESolution]:AUTO** <State>

Couples and decouples the resolution bandwidth to the span.

**Parameters:**

<State> ON | OFF | 0 | 1  
 \*RST: 1

**Example:**

BAND:AUTO OFF  
 Switches off the coupling of the resolution bandwidth to the span.

**Manual operation:**

See "[RBW](#)" on page 347  
 See "[Default Coupling](#)" on page 503

**[SENSe:]BWIDth[:RESolution]:RATio** <Ratio>

**[SENSe:]BANDwidth[:RESolution]:RATio** <Ratio>

Defines the ratio between the resolution bandwidth (Hz) and the span (Hz).

Note that the ratio defined with this remote command (RBW/span) is reciprocal to that of the coupling ratio (span/RBW).

**Parameters:**

<Ratio> Range: 0.0001 to 1  
 \*RST: 0.01

**Example:**

BAND:RAT 0.1

**Manual operation:**

See "[Span/RBW](#)" on page 502

**[SENSe:]BWIDth[:RESolution]:TYPE** <FilterType>

**[SENSe:]BANDwidth[:RESolution]:TYPE** <FilterType>

This command selects the resolution filter type.

When you change the filter type, the command selects the next larger filter bandwidth if the same bandwidth is unavailable for that filter.

The EMI-specific filter types are available if the EMI (R&S FSW-K54) measurement option is installed, even if EMI measurement is not active. For details see [Chapter 6.13.3.1, "Resolution bandwidth and filter types"](#), on page 335.

**Parameters:**

<FilterType>

**CFILter**

Channel filters

**NORMal**

Gaussian filters

**P5**

5-pole filters

The 5-pole filter is not available for FFT sweeps.

**RRC**

RRC filters

The RRC filter is not available for FFT sweeps.

**CISPr | PULSe**

CISPR (6 dB) - requires EMI (R&S FSW-K54) option

Return value for query is always `PULS`.

**MIL**

MIL Std (6 dB) - requires EMI (R&S FSW-K54) option

\*RST:        `NORMal`

**Example:**        `BAND:TYPE NORM`

**Example:**        See [Chapter 13.16.1, "Programming example: performing a basic frequency sweep"](#), on page 1531.

**Manual operation:** See ["Filter Type"](#) on page 346  
See ["Res BW CISPR"](#) on page 349  
See ["Res BW MIL"](#) on page 349

**[SENSe:]BWIDth:VIDeo <Bandwidth>**

**[SENSe:]BANDwidth:VIDeo <Bandwidth>**

Defines the video bandwidth.

The command decouples the video bandwidth from the resolution bandwidths.

**Parameters:**

<Bandwidth>        refer to specifications document

\*RST:        `AUTO` is set to `ON`

Default unit: `HZ`

**Example:**        `BAND:VID 10 kHz`

**Manual operation:** See ["VBW"](#) on page 501

**[SENSe:]BWIDth:VIDeo:AUTO <State>**

**[SENSe:]BANDwidth:VIDeo:AUTO <State>**

Couples and decouples the video bandwidth to the resolution bandwidth.

**Parameters:**

<State>            `ON | OFF | 0 | 1`

\*RST:        `1`

**Example:**        `BAND:VID:AUTO OFF`

**Manual operation:** See ["VBW"](#) on page 501  
See ["RBW/VBW"](#) on page 502  
See ["Default Coupling"](#) on page 503

**[SENSe:]BWIDth:VIDeo:RATio <Ratio>**

**[SENSe:]BANDwidth:VIDeo:RATio <Ratio>**

Defines the coupling ratio of the video bandwidth to the resolution bandwidth (VBW/RBW).



**Parameters:**

<Ratio>                    Range:        0,001 to 1000  
                               \*RST:        1

**Example:**

BAND:VID:RAT 3  
 Sets the video bandwidth to 3\*resolution bandwidth.

**Manual operation:** See "RBW/VBW" on page 502

[SENSe:]BWIDth:VIDeo:TYPE <Mode>

[SENSe:]BANDwidth:VIDeo:TYPE <Mode>

Enables or disables the logarithmic amplifier in front of the video filter in the signal path.

**Parameters:**

<Mode>

**LINEar**

The logarithmic amplifier in front of the video filter is bypassed to process linear detector samples.

**LOGarithmic**

The logarithmic amplifier in front of the video filter is enabled to process logarithmic detector samples.

\*RST:        LOGarithmic

**Example:**

BAND:VID:TYPE LIN  
 Logarithmic amplifier in front of the video filter is disabled.

**Manual operation:** See "VBW" on page 501

### 13.7.3.2 Configuring the sweep

Useful commands for configuring sweeps described elsewhere:

- [SENSe:]AVERAge<n>:COUNT on page 1245
- [SENSe:]AVERAge<n>[:STATe<t>] on page 1245
- [SENSe:]AVERAge<n>:TYPE on page 1245

**Remote commands exclusive to configuring sweeps:**

[SENSe:]SWEep:COUNT.....	1202
[SENSe:]SWEep:DURation?.....	1202
[SENSe:]SWEep:FFTSubspan?.....	1202
[SENSe:]SWEep:OPTimize.....	1203
[SENSe:]SWEep[:WINDow<n>]:POINTs.....	1204
[SENSe:]SWEep:TIME.....	1204
[SENSe:]SWEep:TIME:AUTO.....	1205
[SENSe:]SWEep:TYPE.....	1205
[SENSe:]SWEep:TYPE:USED.....	1205
[SENSe:]BWIDth[:RESolution]:FFT.....	1206
[SENSe:]BANDwidth[:RESolution]:FFT.....	1206

**[SENSe:]SWEep:COUNT** <SweepCount>

Defines the number of sweeps that the application uses to average traces.

In continuous sweep mode, the application calculates the moving average over the average count.

In single sweep mode, the application stops the measurement and calculates the average after the average count has been reached.

**Parameters:**

<SweepCount> When you set a sweep count of 0 or 1, the FSW performs one single sweep in single sweep mode.  
In continuous sweep mode, if the sweep count is set to 0, a moving average over 10 sweeps is performed.

Range: 0 to 200000  
\*RST: 0

**Example:**

```
SWE:COUN 64
Sets the number of sweeps to 64.
INIT:CONT OFF
Switches to single sweep mode.
INIT;*WAI
Starts a sweep and waits for its end.
```

**Manual operation:** See "[Sweep/Average Count](#)" on page 504

**[SENSe:]SWEep:DURation?** <Time>

Provides an estimation of the total time required to capture the data and process it. This time span may be considerably longer than the actual sweep time (see [\[SENSe:\]SWEep:TIME](#) on page 1204).

**Tip:** To determine the necessary timeout for data capturing in a remote control program, double the estimated time and add 1 second.

**Return values:**

<Time>

**Example:**

```
SWE:TIME 1s
SWE:DUR?
Reply:
27.9734842578
```

**Usage:** Query only

**Manual operation:** See "[Sweep Time](#)" on page 502  
See "[Data capturing takes too long](#)" on page 1549

**[SENSe:]SWEep:FFTSubspan?**

Returns the number of FFT subspans required to cover the entire measurement range (read-only).

See also "[Number of subspans](#)" on page 496.

Only available in FFT sweep mode in the Spectrum application, and not for SEM, ACLR, or Spurious emissions measurements.

**Return values:**

<NoOfPartialSpans> integer

**Usage:** Query only

**Manual operation:** See "[FFT Subspans](#)" on page 506

---

**[SENSe:]SWEep:OPTimize <Mode>**

In FFT mode, several FFT analysis steps are required to cover the entire measurement span. The span which is covered by one FFT analysis step is called *subspan*. The subspan cannot be defined directly, but it can be optimized according to measurement requirements.

**Table 13-5: Optimization parameters in FFT mode**

Optimization mode	Description
DYNamic	Optimizes the dynamic range by using the narrowest possible subspan (depending on the RBW). The autorange function for the internal IF gain calculation is activated to obtain the best control range for the A/D converter.
SPEed	Optimizes the sweep rate by using the widest possible subspan (depending on the RBW). The autorange function for the internal IF gain calculation is deactivated. (Note: set the reference level accordingly to optimize the control range for the A/D converter). It is recommended that you set the <a href="#">Sweep Time</a> to "Auto" to optimize the sweep rate.
TRANsient	Recommended mode for measurements on highly transient signals in spectrum analysis. It increases the measurement speed with a trade off in dynamic range. Only available for FSW67/85 models.
AUTO	Uses a medium-sized subspan to obtain a compromise between a large dynamic range and a fast sweep rate. The autorange function for the internal IF gain calculation is activated to obtain the best control range for the A/D converter.

**Note: FFT mode and external mixers (R&S FSW-B21)**

The subspan optimization modes "Dynamic" and "Auto" include automatic suppression of unwanted mixing products. Thus, when using external mixers (R&S FSW-B21), use the "Speed" mode to obtain similar results in FFT mode as in frequency sweep mode.

**Zero span mode**

For zero span measurements, the optimization mode defines the selection of the A/D converter prefilter.

**Table 13-6: Optimization parameters in zero span mode**

Optimization mode	Description
DYNamic	The narrowest filter possible (depending on the RBW) is used.
SPEed	The widest filter possible (depending on the RBW) is used.
AUTO	A medium-sized prefilter is used.

**Note: EMI measurements**

For EMI measurements (using R&S FSW-K54), "Dynamic" mode is not supported. "Auto" mode always uses "Speed" optimization.

**Parameters:**

<Mode>                    \*RST:        AUTO

**Example:**

```
SWE:OPT DYN
Selects optimization for dynamic range.
```

**Manual operation:** See "[Optimization](#)" on page 504

**[SENSe:]SWEep:WINDow<n>:POINTs <SweepPoints>**

This command defines the number of sweep points to analyze after a sweep.

For EMI measurements, 200001 sweep points are available.

**Suffix:**

<n>

**Parameters:**

<SweepPoints>        Range:        101 to 100001  
                         \*RST:        1001

**Example:**

```
SWE:POIN 251
```

**Manual operation:** See "[Sweep Points](#)" on page 504

**[SENSe:]SWEep:TIME <Time>**

Defines the sweep time. It automatically decouples the time from any other settings.

In the Spectrum application, the command decouples the sweep time from the span and resolution and video bandwidths. Note that this command queries only the time required to capture the data, not to process it. To obtain an estimation of the total capture and processing time, use the [\[SENSe:\]SWEep:DURation?](#) command.

**Parameters:**

<Time>                    refer to specifications document  
                         \*RST:        depends on current settings (determined automatically)  
                         Default unit: S

**Manual operation:** See ["Sweep Time"](#) on page 170  
 See ["Sweep Time"](#) on page 502  
 See ["Sweep Time"](#) on page 513

#### [SENSe:]SWEep:TIME:AUTO <State>

Couples and decouples the sweep time to the span and the resolution and video bandwidths.

**Parameters:**

<State> ON | OFF | 0 | 1  
 \*RST: 1

**Example:** SWE:TIME:AUTO ON  
 Activates automatic sweep time.

**Manual operation:** See ["Harmonic Sweep Time"](#) on page 318  
 See ["Sweep Time"](#) on page 502  
 See ["Default Coupling"](#) on page 503

#### [SENSe:]SWEep:TYPE <Type>

Selects the sweep type.

**Parameters:**

<Type> **AUTO**  
 Automatic selection of the sweep type between sweep mode and FFT.  
**FFT**  
 FFT mode  
**SWE**  
 Sweep list  
 \*RST: AUTO

**Example:** SWE:TYPE FFT

**Manual operation:** See ["Sweep Type"](#) on page 505

#### [SENSe:]SWEep:TYPE:USED

Queries the sweep type if you have turned on automatic selection of the sweep type.

**Return values:**

<Type> **SWE**  
 Normal sweep  
**FFT**  
 FFT mode

**[SENSe:]BWIDth[:RESolution]:FFT <FilterMode>**

**[SENSe:]BANDwidth[:RESolution]:FFT <FilterMode>**

Defines the filter mode to be used for FFT filters by defining the subspan size. The subspan is the span which is covered by one FFT analysis.

Is only available when using the sweep type "FFT".

**Note:** this command is maintained for compatibility reasons only. For new remote control programs, use the [\[SENSe:\]SWEep:OPTimize](#) command.

**Parameters:**

<FilterMode>

WIDE | AUTO | NARRow

**AUTO**

Automatically applies the sweep optimization mode that is best for the current measurement.

**NARRow**

Optimizes the sweep mode for a large dynamic range.

**WIDE**

Optimizes the sweep mode for high performance.

\*RST: AUTO

**Example:**

```
BAND:TYPE FFT
Select FFT filter.
```

**Example:**

```
BAND:FFT NARR
Select narrow subspan for FFT filter.
```

## 13.7.4 Configuring the vertical axis (amplitude, scaling)

The following commands are required to configure the amplitude and vertical axis settings in a remote environment.

- [Amplitude settings](#)..... 1206
- [Configuring the attenuation](#)..... 1209
- [Configuring a preamplifier](#)..... 1212
- [Scaling the Y-axis](#)..... 1214

### 13.7.4.1 Amplitude settings

The tasks for manual configuration are described in [Chapter 7.4.2, "Amplitude settings"](#), on page 481.

**Useful commands for amplitude configuration described elsewhere:**

- [\[SENSe:\]ADJust:LEVel](#) on page 1236

**Remote commands exclusive to amplitude configuration:**

CALCulate<n>:MARKer<m>:FUNction:REFerence.....	1207
UNIT<n>:POWer.....	1207
CALCulate<n>:UNIT:POWer.....	1207
DISPlay[:WINDow<n>][:SUBWindow<w>]:TRACe<t>:Y[:SCALe]:RLEVel.....	1207
DISPlay[:WINDow<n>][:SUBWindow<w>]:TRACe<t>:Y[:SCALe]:RLEVel:OFFSet.....	1208
[SENSe:]POWer:NCORrection.....	1208

**CALCulate<n>:MARKer<m>:FUNction:REFerence**

Matches the reference level to the power level of a marker.

If you use the command in combination with a delta marker, that delta marker is turned into a normal marker.

**Suffix:**

<n>                      Window

<m>                      Marker

**Example:**

CALC:MARK2:FUNC:REF

Sets the reference level to the level of marker 2.

**Manual operation:** See "Reference Level = Marker Level" on page 565

**UNIT<n>:POWer <Unit>****CALCulate<n>:UNIT:POWer <Unit>**

Selects the power unit.

The unit applies to all power-based measurement windows with absolute values.

In addition, the unit of the reference level is adapted to the same unit.

**Suffix:**

<n>                      irrelevant

**Parameters:**

<Unit>                      DBM | V | A | W | DBPW | WATT | DBUV | DBMV | VOLT |  
 DBUA | AMPere | DBM\_mhz | DBM\_hz | DBUa\_mhz |  
 DBUV\_mhz | DBmV\_mhz | DBpW\_mhz

(Units based on 1 MHz require installed R&S FSW-K54 (EMI measurements) option.)

\*RST:                      dBm

**Example:**

CALC:UNIT:POW DBM

Sets the power unit to dBm.

**Manual operation:** See "Unit" on page 485

**DISPlay[:WINDow<n>][:SUBWindow<w>]:TRACe<t>:Y[:SCALe]:RLEVel  
<ReferenceLevel>**

Defines the reference level (for all traces in all windows).

With a reference level offset  $\neq 0$ , the value range of the reference level is modified by the offset.

**Suffix:**

<n>	irrelevant
<w>	subwindow Not supported by all applications
<t>	irrelevant

**Parameters:**

<ReferenceLevel>	The unit is variable. Range: see specifications document *RST: 0 dBm Default unit: DBM
------------------	-------------------------------------------------------------------------------------------------

**Example:** `DISP:TRAC:Y:RLEV -60dBm`

**Manual operation:** See "[Reference Level](#)" on page 484

**DISPlay[:WINDow<n>][:SUBWindow<w>]:TRACe<t>:Y[:SCALe]:RLEVel:OFFSet**  
<Offset>

Defines a reference level offset (for all traces in all windows).

**Suffix:**

<n>	irrelevant
<w>	subwindow Not supported by all applications
<t>	irrelevant

**Parameters:**

<Offset>	Range: -200 dB to 200 dB *RST: 0dB Default unit: DB
----------	-----------------------------------------------------------

**Example:** `DISP:TRAC:Y:RLEV:OFFS -10dB`

**Manual operation:** See "[Shifting the Display \(Offset\)](#)" on page 303  
See "[Shifting the Display \(Offset\)](#)" on page 485

**[SENSe:]POWer:NCORrection <State>**

Turns noise cancellation on and off.

If noise cancellation is on, the FSW performs a reference measurement to determine its inherent noise and subtracts the result from the channel power measurement result (first active trace only).

For more information see "[Noise Cancellation](#)" on page 168.



**Parameters:**

<State> ON | OFF | 1 | 0  
 \*RST: 0

**Example:**

POW:NCOR ON

**Manual operation:** See "Noise Cancellation" on page 168

**13.7.4.2 Configuring the attenuation**

INPut:ATTenuation.....	1209
INPut:ATTenuation:AUTO.....	1210
INPut:ATTenuation:AUTO:MODE.....	1210
INPut:EATT.....	1210
INPut:EATT:AUTO.....	1211
INPut:EATT:STATe.....	1211
INPut:SANalyzer:ATTenuation.....	1211
INPut:SANalyzer:ATTenuation:AUTO.....	1212

**INPut:ATTenuation** <Attenuation>

Defines the total attenuation for RF input.

If an electronic attenuator is available and active, the command defines a mechanical attenuation (see [INPut:EATT:STATe](#) on page 1211).

If you set the attenuation manually, it is no longer coupled to the reference level, but the reference level is coupled to the attenuation. Thus, if the current reference level is not compatible with an attenuation that has been set manually, the command also adjusts the reference level.

If an external frontend is active (see [\[SENSe:\]EFRontend\[:STATe\]](#) on page 1124), you can configure the attenuation of the external frontend and the analyzer separately. See also [INPut:SANalyzer:ATTenuation:AUTO](#) on page 1212 and [INPut:SANalyzer:ATTenuation](#) on page 1211.

**Parameters:**

<Attenuation> Range: see specifications document  
 Increment: 5 dB (with optional electr. attenuator: 1 dB)  
 \*RST: 10 dB (AUTO is set to ON)  
 Default unit: DB

**Example:**

INP:ATT 30dB

Defines a 30 dB attenuation and decouples the attenuation from the reference level.

**Manual operation:** See "External Frontend Attenuation" on page 486  
 See "Attenuation Mode / Value" on page 486

**INPut:ATTenuation:AUTO** <State>

Couples or decouples the attenuation to the reference level. Thus, when the reference level is changed, the FSW determines the signal level for optimal internal data processing and sets the required attenuation accordingly.

If an external frontend is active (see [\[SENSe:\]EFRontend\[:STATe\]](#) on page 1124), you can configure the attenuation of the external frontend and the analyzer separately. See also [INPut:SANalyzer:ATTenuation:AUTO](#) on page 1212 and [INPut:SANalyzer:ATTenuation](#) on page 1211.

**Parameters:**

<State> ON | OFF | 0 | 1  
\*RST: 1

**Example:**

INP:ATT:AUTO ON  
Couples the attenuation to the reference level.

**Manual operation:**

See "[External Frontend Attenuation](#)" on page 486  
See "[Attenuation Mode / Value](#)" on page 486

**INPut:ATTenuation:AUTO:MODE** <OptMode>

Selects the priority for signal processing *after* the RF attenuation has been applied.

**Parameters:**

<OptMode> LNOise | LDISTortion  
**LNOise**  
Optimized for high sensitivity and low noise levels  
**LDISTortion**  
Optimized for low distortion by avoiding intermodulation  
\*RST: LDISTortion (WLAN application: LNOise)

**Example:**

INP:ATT:AUTO:MODE LNO

**INPut:EATT** <Attenuation>

Defines an electronic attenuation manually. Automatic mode must be switched off ([INP:EATT:AUTO OFF](#), see [INPut:EATT:AUTO](#) on page 1211).

If the current reference level is not compatible with an attenuation that has been set manually, the command also adjusts the reference level.

**Parameters:**

<Attenuation> attenuation in dB  
Range: see specifications document  
Increment: 1 dB  
\*RST: 0 dB (OFF)  
Default unit: DB

**Example:**

INP:EATT:AUTO OFF  
INP:EATT 10 dB

**Manual operation:** See ["Using Electronic Attenuation"](#) on page 487

#### **INPut:EATT:AUTO** <State>

Turns automatic selection of the electronic attenuation on and off.

If on, electronic attenuation reduces the mechanical attenuation whenever possible.

#### **Parameters:**

<State>                    ON | OFF | 0 | 1  
**OFF | 0**  
 Switches the function off  
**ON | 1**  
 Switches the function on  
 \*RST:                    1

**Example:**                INP:EATT:AUTO OFF

**Manual operation:** See ["Using Electronic Attenuation"](#) on page 487

#### **INPut:EATT:STATe** <State>

Turns the electronic attenuator on and off.

#### **Parameters:**

<State>                    ON | OFF | 0 | 1  
**OFF | 0**  
 Switches the function off  
**ON | 1**  
 Switches the function on  
 \*RST:                    0

**Example:**                INP:EATT:STAT ON  
 Switches the electronic attenuator into the signal path.

**Manual operation:** See ["Using Electronic Attenuation"](#) on page 487

#### **INPut:SANalyzer:ATTenuation** <Attenuation>

Configures attenuation at the analyzer input for an active external frontend manually.

#### **Parameters:**

<Attenuation>            Range:            see specifications document  
 Increment:    1 dB  
 Default unit: DB

**Manual operation:** See ["Attenuation Mode / Value"](#) on page 486

**INPut:SANalyzer:ATTenuation:AUTO** <State>

Enables or disables automatic configuration of attenuation at the analyzer input for an active external frontend.

By default, the attenuation settings are applied at the input of the external frontend.

See [INPut:ATTenuation:AUTO](#) on page 1210 and [INPut:ATTenuation](#) on page 1209.

**Parameters:**

&lt;State&gt;

ON | OFF | 0 | 1

**OFF | 0**

Auto mode for analyzer attenuation is disabled. Allows you to configure attenuation at the analyzer using [INPut:SANalyzer:ATTenuation](#) on page 1211.

**ON | 1**

Auto mode for analyzer attenuation is enabled. No attenuation is configured at the analyzer.

\*RST: 0

**Example:**

```
//Enable external frontend
EFR ON
//Query the currently configured RF attenuation
INP:ATT?
//Result: 10 dB
//Disable auto mode for analyzer attenuation
INP:SAN:ATT:AUTO OFF
//Configure 10 dB attenuation at the analyzer
INP:SAN:ATT 10
//Query the currently configured RF attenuation at the ext. FE
INP:ATT?
//Result: 0 dB
```

**Manual operation:** See "[Attenuation Mode / Value](#)" on page 486

**13.7.4.3 Configuring a preamplifier**

<a href="#">INPut:EGAIN[:STATe]</a> .....	1212
<a href="#">INPut:GAIN:STATe</a> .....	1213
<a href="#">INPut:GAIN[:VALue]</a> .....	1214

**INPut:EGAIN[:STATe]** <State>

Before this command can be used, the external preamplifier must be connected to the FSW. See the preamplifier's documentation for details.

When activated, the FSW automatically compensates the magnitude and phase characteristics of the external preamplifier in the measurement results.

Note that when an optional external preamplifier is activated, the internal preamplifier is automatically disabled, and vice versa.

For FSW85 models with two RF inputs, you must enable correction from the external preamplifier for each input individually. Correction cannot be enabled for both inputs at the same time.

When deactivated, no compensation is performed even if an external preamplifier remains connected.

**Parameters:**

<State>                    ON | OFF | 0 | 1  
**OFF | 0**  
 No data correction is performed based on the external preamplifier

**ON | 1**  
 Performs data corrections based on the external preamplifier

\*RST:                    0

**Example:**                INP:EGA ON

**Manual operation:**    See "[Ext. PA Correction](#)" on page 488

**INPut:GAIN:STATe** <State>

Turns the internal preamplifier on and off. It requires the optional preamplifier hardware.

Note that if an optional external preamplifier is activated, the internal preamplifier is automatically disabled, and vice versa.

Is not available for input from the optional "Digital Baseband" interface.

For all FSW models except for FSW85, the preamplification is defined by [INPut:GAIN\[:VALue\]](#).

For older FSW43/FSW50/FSW67 models, the input signal is always amplified by about 30 dB when the preamplifier is active.

For FSW85 models, no preamplifier is available.

If option R&S FSW-B22 is installed, the preamplifier is only active below 7 GHz.

If option R&S FSW-B24 is installed, the preamplifier is active for all frequencies.

**Parameters:**

<State>                    ON | OFF | 0 | 1  
**OFF | 0**  
 Switches the function off

**ON | 1**  
 Switches the function on

\*RST:                    0

**Example:**                INP:GAIN:STAT ON  
 INP:GAIN:VAL 15  
 Switches on 15 dB preamplification.

**Manual operation:**    See "[Preamplifier](#)" on page 488

**INPut:GAIN[:VALue] <Gain>**

Selects the "gain" if the preamplifier is activated (INP:GAIN:STAT ON, see INPut:GAIN:STATe on page 1213).

The command requires the additional preamplifier hardware option.

**Parameters:**

<Gain> For all FSW models except for FSW85, the following settings are available:  
 15 dB and 30 dB  
 All other values are rounded to the nearest of these two.  
 30 dB  
 For older FSW43/FSW50/FSW67 models, the input signal is always amplified by about 30 dB when the preamplifier is active.  
 For FSW85 models, no preamplifier is available.  
 Default unit: DB

**Example:** INP:GAIN:STAT ON  
 INP:GAIN:VAL 30  
 Switches on 30 dB preamplification.

**Manual operation:** See "Preamplifier" on page 488

**13.7.4.4 Scaling the Y-axis**

DISPlay[:WINDow<n>][:SUBWindow<w>]:TRACe<t>:Y[:SCALe].....	1214
DISPlay[:WINDow<n>][:SUBWindow<w>]:TRACe<t>:Y[:SCALe]:AUTO ONCE.....	1215
DISPlay[:WINDow<n>][:SUBWindow<w>]:TRACe<t>:Y[:SCALe]:MODE.....	1215
DISPlay[:WINDow<n>][:SUBWindow<w>]:TRACe<t>:Y[:SCALe]:PDIVision.....	1215
DISPlay[:WINDow<n>][:SUBWindow<w>]:TRACe<t>:Y[:SCALe]:RPOSition.....	1216
DISPlay[:WINDow<n>][:SUBWindow<w>]:TRACe<t>:Y:SPACing.....	1216

**DISPlay[:WINDow<n>][:SUBWindow<w>]:TRACe<t>:Y[:SCALe] <Range>**

Defines the display range of the y-axis (for all traces).

Note that the command works only for a logarithmic scaling. You can select the scaling with DISPlay[:WINDow<n>][:SUBWindow<w>]:TRACe<t>:Y:SPACing.

**Suffix:**

<n> Window  
 <w> subwindow  
 Not supported by all applications  
 <t> irrelevant

**Parameters:**

<Range> Range: 1 dB to 200 dB  
 \*RST: 100 dB  
 Default unit: HZ

**Example:** DISP:TRAC:Y 110dB

**Manual operation:** See ["Range"](#) on page 490

---

**DISPlay[:WINDow<n>][:SUBWindow<w>]:TRACe<t>:Y[:SCALe]:AUTO ONCE**

Automatic scaling of the y-axis is performed once, then switched off again (for all traces).

**Suffix:**

<n> [Window](#)

<t> irrelevant

**Manual operation:** See ["Auto Scale Once"](#) on page 490

---

**DISPlay[:WINDow<n>][:SUBWindow<w>]:TRACe<t>:Y[:SCALe]:MODE <Mode>**

Selects the type of scaling of the y-axis (for all traces).

When the display update during remote control is off, this command has no immediate effect.

**Suffix:**

<n> [Window](#)

<w> subwindow

<t> irrelevant

**Parameters:**

<Mode> **ABSolute**  
absolute scaling of the y-axis

**RELative**  
relative scaling of the y-axis

\*RST: ABSolute

**Example:** DISP:TRAC:Y:MODE REL

**Manual operation:** See ["Scaling"](#) on page 491

---

**DISPlay[:WINDow<n>][:SUBWindow<w>]:TRACe<t>:Y[:SCALe]:PDIVision  
<Value>**

This remote command determines the grid spacing on the Y-axis for all diagrams, where possible.

In spectrum displays, for example, this command is not available.

**Suffix:**

<n> [Window](#)

<w> subwindow  
Not supported by all applications

<t> irrelevant

## Setting basic measurement parameters

**Parameters:**

<Value> numeric value WITHOUT UNIT (unit according to the result display)  
 Defines the range per division (total range = 10\* $\langle$ Value $\rangle$ )  
 \*RST: depends on the result display  
 Default unit: DBM

**Example:**

DISP:TRAC:Y:PDIV 10  
 Sets the grid spacing to 10 units (e.g. dB) per division

**DISPlay[:WINDow<n>][:SUBWindow<w>]:TRACe<t>:Y[:SCALe]:RPOSition**  
 <Position>

Defines the vertical position of the reference level on the display grid (for all traces).

The FSW adjusts the scaling of the y-axis accordingly.

For measurements with the optional external generator control, the command defines the position of the reference value.

**Suffix:**

<n> [Window](#)  
 <w> subwindow  
 Not supported by all applications  
 <t> irrelevant

**Parameters:**

<Position> 0 PCT corresponds to the lower display border, 100% corresponds to the upper display border.  
 \*RST: 100 PCT = frequency display; 50 PCT = time display  
 Default unit: PCT

**Example:**

DISP:TRAC:Y:RPOS 50PCT

**Manual operation:** See ["Reference Position"](#) on page 392  
 See ["Ref Level Position"](#) on page 490

**DISPlay[:WINDow<n>][:SUBWindow<w>]:TRACe<t>:Y:SPACing** <ScalingType>

Selects the scaling of the y-axis (for all traces, <t> is irrelevant).

**Suffix:**

<n> [Window](#)  
 <w> subwindow  
 <t> [Trace](#)

**Parameters:**

<ScalingType> **LOGarithmic**  
 Logarithmic scaling.



**LINear**

Linear scaling in %.

**LDB**

Linear scaling in the specified unit.

**PERCent**

Linear scaling in %.

\*RST: LOGarithmic

**Example:** `DISP:TRAC:Y:SPAC LIN`  
Selects linear scaling in %.

**Manual operation:** See "Scaling" on page 491

### 13.7.5 Configuring triggered and gated measurements

The commands required to configure a triggered or gated measurement in a remote environment are described here.

The tasks for manual operation are described in [Chapter 7.6, "Trigger and gate configuration"](#), on page 508

The commands required for trigger input or output are described in [Chapter 13.7.5.3, "Configuring the trigger output"](#), on page 1229.



\*OPC should be used after requesting data. This will hold off any subsequent changes to the selected trigger source, until after the sweep is completed and the data is returned.

- [Configuring the triggering conditions](#)..... 1217
- [Configuring gated measurements](#)..... 1224
- [Configuring the trigger output](#)..... 1229
- [Programming example: continuous gating](#)..... 1232

#### 13.7.5.1 Configuring the triggering conditions

The following commands are required to configure a triggered measurement.

<code>TRIGger[:SEquence]:DTIME</code> .....	1218
<code>TRIGger[:SEquence]:HOLDoff[:TIME]</code> .....	1218
<code>TRIGger[:SEquence]:IFPower:HOLDoff</code> .....	1218
<code>TRIGger[:SEquence]:IFPower:HYSteresis</code> .....	1219
<code>TRIGger[:SEquence]:LEVel:BBPower</code> .....	1219
<code>TRIGger[:SEquence]:LEVel[:EXternal&lt;port&gt;]</code> .....	1219
<code>TRIGger[:SEquence]:LEVel:IFPower</code> .....	1220
<code>TRIGger[:SEquence]:LEVel:IQPower</code> .....	1220
<code>TRIGger[:SEquence]:LEVel:RFPower</code> .....	1221
<code>TRIGger[:SEquence]:LEVel:VIDeo</code> .....	1221

TRIGger[:SEQuence]:SLOPe.....	1221
TRIGger[:SEQuence]:SOURce.....	1221
TRIGger[:SEQuence]:TIME:RINTerval.....	1223

---

### TRIGger[:SEQuence]:DTIME <DropoutTime>

Defines the time the input signal must stay below the trigger level before a trigger is detected again.

For input from the "Analog Baseband" interface using the baseband power trigger (BBP), the default drop out time is set to 100 ns to avoid unintentional trigger events (as no hysteresis can be configured in this case).

#### Parameters:

<DropoutTime> Dropout time of the trigger.  
 Range: 0 s to 10.0 s  
 \*RST: 0 s  
 Default unit: S

**Manual operation:** See "[Drop-Out Time](#)" on page 518

---

### TRIGger[:SEQuence]:HOLDoff[:TIME] <Offset>

Defines the time offset between the trigger event and the start of the sweep.

A negative offset is possible for time domain measurements.

For the trigger sources "External" or "IF Power", a common input signal is used for both trigger and gate. Therefore, changes to the gate delay will affect the trigger offset as well.

#### Parameters:

<Offset> For measurements in the frequency domain, the range is 0 s to 30 s.  
 For measurements in the time domain, the range is the negative sweep time to 30 s.  
 \*RST: 0 s  
 Default unit: S

**Example:** TRIG:HOLD 500us

**Manual operation:** See "[Trigger Offset](#)" on page 518

---

### TRIGger[:SEQuence]:IFPower:HOLDoff <Period>

Defines the holding time before the next trigger event.

Note that this command can be used for **any trigger source**, not just IF Power (despite the legacy keyword).

**Note:** If you perform gated measurements in combination with the IF Power trigger, the FSW ignores the holding time for frequency sweep, FFT sweep, zero span and I/Q data measurements.

**Parameters:**

<Period>                   Range:     0 s to 10 s  
                               \*RST:     0 s  
                               Default unit: S

**Example:**

TRIG:SOUR EXT  
 Sets an external trigger source.  
 TRIG:IFP:HOLD 200 ns  
 Sets the holding time to 200 ns.

**Manual operation:** See ["Trigger Holdoff"](#) on page 519

**TRIGger[:SEQuence]:IFPower:HYSTeresis <Hysteresis>**

Defines the trigger hysteresis, which is only available for "IF Power" trigger sources.

**Parameters:**

<Hysteresis>               Range:     3 dB to 50 dB  
                               \*RST:     3 dB  
                               Default unit: DB

**Example:**

TRIG:SOUR IFP  
 Sets the IF power trigger source.  
 TRIG:IFP:HYST 10DB  
 Sets the hysteresis limit value.

**Manual operation:** See ["Hysteresis"](#) on page 518

**TRIGger[:SEQuence]:LEVel:BBPower <Level>**

Sets the level of the baseband power trigger.

Is available for the optional "Digital Baseband" interface.

Is available for the optional "Analog Baseband" interface.

**Parameters:**

<Level>                    Range:     -50 dBm to +20 dBm  
                               \*RST:     -20 dBm  
                               Default unit: DBM

**Example:**

TRIG:LEV:BBP -30DBM

**Manual operation:** See ["Trigger Level"](#) on page 517

**TRIGger[:SEQuence]:LEVel[:EXTernal<port>] <TriggerLevel>**

Defines the level the external signal must exceed to cause a trigger event.

Note that the variable "Input/Output" connectors (ports 2+3) must be set for use as input using the [OUTPut:TRIGger<tp>:DIRection](#) command.

**Suffix:**

&lt;port&gt;

Selects the trigger port.

1 = trigger port 1 (TRIGGER INPUT connector on front panel)

2 = trigger port 2 (TRIGGER INPUT/OUTPUT connector on front panel)

(Not available for FSW85 models with two RF input connectors.)

3 = trigger port 3 (TRIGGER3 INPUT/OUTPUT connector on rear panel)

**Parameters:**

&lt;TriggerLevel&gt;

Range: 0.5 V to 3.5 V

\*RST: 1.4 V

Default unit: V

**Example:**

TRIG:LEV 2V

**Manual operation:** See ["Trigger Level"](#) on page 517**TRIGger[:SEQuence]:LEVel:IFPower <TriggerLevel>**

Defines the power level at the third intermediate frequency that must be exceeded to cause a trigger event.

Note that any RF attenuation or preamplification is considered when the trigger level is analyzed. If defined, a reference level offset is also considered.

For compatibility reasons, this command is also available for the "Baseband Power" trigger source when using the "Analog Baseband" interface.

**Parameters:**

&lt;TriggerLevel&gt;

For details on available trigger levels and trigger bandwidths, see the specifications document.

\*RST: -20 dBm

Default unit: DBM

**Example:**

TRIG:LEV:IFP -30DBM

**Manual operation:** See ["Trigger Level"](#) on page 517**TRIGger[:SEQuence]:LEVel:IQPower <TriggerLevel>**

Defines the magnitude the I/Q data must exceed to cause a trigger event.

Note that any RF attenuation or preamplification is considered when the trigger level is analyzed. If defined, a reference level offset is also considered.

**Parameters:**

&lt;TriggerLevel&gt;

Range: -130 dBm to 30 dBm

\*RST: -20 dBm

Default unit: DBM

**Example:**

TRIG:LEV:IQP -30DBM

**Manual operation:** See ["Trigger Level"](#) on page 517

---

**TRIGger[:SEquence]:LEVel:RFPower** <TriggerLevel>

Defines the power level the RF input must exceed to cause a trigger event. Note that any RF attenuation or preamplification is considered when the trigger level is analyzed. If defined, a reference level offset is also considered.

The input signal must be between 500 MHz and 8 GHz.

**Parameters:**

<TriggerLevel> For details on available trigger levels and trigger bandwidths, see the specifications document.

\*RST: -20 dBm

Default unit: DBM

**Example:** TRIG:LEV:RFP -30dBm

**Manual operation:** See "[Trigger Level](#)" on page 517

---

**TRIGger[:SEquence]:LEVel:VIDeo** <Level>

Defines the level the video signal must exceed to cause a trigger event. Note that any RF attenuation or preamplification is considered when the trigger level is analyzed.

**Parameters:**

<Level> Range: 0 PCT to 100 PCT

\*RST: 50 PCT

Default unit: PCT

**Example:** TRIG:LEV:VID 50PCT

**Manual operation:** See "[Trigger Level](#)" on page 517

---

**TRIGger[:SEquence]:SLOPe** <Type>

For all trigger sources except time, you can define whether triggering occurs when the signal rises to the trigger level or falls down to it.

**Parameters:**

<Type> POSitive | NEGative

**POSitive**

Triggers when the signal rises to the trigger level (rising edge).

**NEGative**

Triggers when the signal drops to the trigger level (falling edge).

\*RST: POSitive

**Example:** TRIG:SLOP NEG

**Manual operation:** See "[Slope](#)" on page 519

---

**TRIGger[:SEquence]:SOURce** <Source>

Selects the trigger source.

For details on trigger sources, see ["Trigger Source"](#) on page 514.

Using a trigger or gated measurements turns the squelch off (see [\[SENSe:\] DEMod: SQUelch\[:STATe\]](#) on page 1319).

**Note on external triggers:**

If a measurement is configured to wait for an external trigger signal in a remote control program, remote control is blocked until the trigger is received and the program can continue. Make sure that this situation is avoided in your remote control programs.

If the 1.2 GHz bandwidth extension option (B1200) or the internal 2 GHz option (B2001) is active, only an external trigger, IF power trigger, or no trigger is available.

If a B4001/B6001/B8001 bandwidth extension option is active, only an external trigger, power trigger, or no trigger is available.

For troubleshooting tips, see ["Incompleted sequential commands - blocked remote channels"](#) on page 1546.

**Parameters:**

<Source>

**IMMediate**

Free Run

**EXTernal**

Trigger signal from the "Trigger Input" connector.

If the optional 2 GHz bandwidth extension (B2000/B5000) is installed and active, this parameter activates the "Ch3" input connector on the oscilloscope. Then the FSW triggers when the signal fed into the "Ch3" input connector on the oscilloscope meets or exceeds the specified trigger level.

**Note:** In previous firmware versions, the external trigger was connected to the "Ch2" input on the oscilloscope. As of firmware version FSW 2.30, the **"Ch3"** input on the oscilloscope must be used!

**EXT2**

Trigger signal from the "Trigger Input/Output" connector.

For FSW85 models, Trigger 2 is not available due to the second RF input connector on the front panel. The trigger signal is taken from the "Trigger Input/Output" connector on the rear panel.

Note: Connector must be configured for "Input".

**EXT3**

Trigger signal from the "TRIGGER 3 INPUT/ OUTPUT" connector.

Note: Connector must be configured for "Input".

**RFPower**

First intermediate frequency

(Frequency and time domain measurements only.)

Not available for input from the optional "Analog Baseband" interface.

Not available for input from the optional "Digital Baseband" interface.

**IFPower**

Second intermediate frequency

Not available for input from the optional "Digital Baseband" interface.

For input from the optional "Analog Baseband" interface, this parameter is interpreted as `BBPower` for compatibility reasons.

**TIME**

Time interval

**VIDeo**

Video mode is available in the time domain and only in the Spectrum application.

**BBPower**

Baseband power

For input from the optional "Analog Baseband" interface.

For input from the optional "Digital Baseband" interface.

**PSEN**

External power sensor

\*RST: IMMEDIATE

**Example:**

```
TRIG:SOUR EXT
```

Selects the external trigger input as source of the trigger signal

**Manual operation:**

See ["Using the power sensor as an external trigger"](#) on page 372

See ["Trigger Source"](#) on page 514

See ["Free Run"](#) on page 514

See ["External Trigger 1/2/3"](#) on page 514

See ["Video"](#) on page 515

See ["IF Power"](#) on page 515

See ["Baseband Power"](#) on page 516

See ["I/Q Power"](#) on page 516

See ["RF Power"](#) on page 516

See ["Power Sensor"](#) on page 517

See ["Time"](#) on page 517

**TRIGger[:SEQUence]:TIME:RINTerval** <Interval>

Defines the repetition interval for the time trigger.

**Parameters:**

<Interval>                    numeric value  
 Range:                    2 ms to 5000 s  
 \*RST:                    1.0 s  
 Default unit: S

**Example:**

```
TRIG:SOUR TIME
```

Selects the time trigger input for triggering.

```
TRIG:TIME:RINT 5
```

The sweep starts every 5 s.

**Manual operation:** See ["Repetition Interval"](#) on page 518

### 13.7.5.2 Configuring gated measurements

[SENSe:]SWEep:EGATe.....	1224
[SENSe:]SWEep:EGATe:AUTO.....	1225
[SENSe:]SWEep:EGATe:CONTInuous:PCOunt.....	1225
[SENSe:]SWEep:EGATe:CONTInuous:PLENgtH.....	1225
[SENSe:]SWEep:EGATe:CONTInuous[:STATe].....	1226
[SENSe:]SWEep:EGATe:HOLDoff.....	1226
[SENSe:]SWEep:EGATe:LENGth.....	1226
[SENSe:]SWEep:EGATe:LEVel[:EXTernal<tp>].....	1227
[SENSe:]SWEep:EGATe:LEVel:IFPower.....	1227
[SENSe:]SWEep:EGATe:LEVel:RFPower.....	1228
[SENSe:]SWEep:EGATe:POLarity.....	1228
[SENSe:]SWEep:EGATe:SOURce.....	1228
[SENSe:]SWEep:EGATe:TYPE.....	1229

---

#### [SENSe:]SWEep:EGATe <State>

Turns gated measurements on and off.

For measurements with an external trigger gate, the measured values are recorded as long as the gate is opened. During a sweep the gate can be opened and closed several times. The synchronization mechanisms with \*OPC, \*OPC? and \*WAI remain completely unaffected.

The measurement ends when a particular number of measurement points has been recorded.

(See [\[SENSe:\]SWEep\[:WINDow<n>\]:POINts](#) on page 1204).

Performing gated measurements turns the squelch off.

#### Parameters:

<State>                    ON | OFF | 0 | 1  
**OFF | 0**  
 Switches the function off  
**ON | 1**  
 Switches the function on

#### Example:

```
SWE:EGAT ON
Switches on the gate mode.
SWE:EGAT:TYPE EDGE
Switches on the edge-triggered mode.
SWE:EGAT:HOLD 100US
Sets the gate delay to 100 µs.
SWE:EGAT:LEN 500US
Sets the gate opening time to 500 µs.
INIT;*WAI
Starts a sweep and waits for its end.
```



**Manual operation:** See "Gated Trigger" on page 299  
See "Gated Trigger" on page 525

---

#### [SENSe:]SWEep:EGATe:AUTO <State>

Determines whether the same or different triggers are used for general measurement and gating.

**Parameters:**

<State> ON | OFF | 0 | 1

**OFF | 0**

The gate is opened by the trigger source defined by [SENSe:]SWEep:EGATe:SOURce, but only after a trigger from the general TRIGger[:SEquence]:SOURce occurs.

**ON | 1**

(Default:) The trigger defined by TRIGger[:SEquence]:SOURce is used both for the general measurement trigger and the gating trigger.

\*RST: 1

**Example:**

SENS:SWE:EGAT:AUTO 0

SENS:SWE:EGAT:SOUR EXT2

SENS:SWE:EGAT:LEV:EXT2 1V

Sets the gating trigger to a level of 1 V at trigger port 2.

**Manual operation:** See "Gate Source Mode" on page 528

---

#### [SENSe:]SWEep:EGATe:CONTinuous:PCOunt <Amount>

Defines the number of gate periods to be measured after a single trigger event.

**Parameters:**

<Amount> integer

Range: 1 to 65535

Increment: 1

\*RST: 100

**Example:**

SWE:EGAT:CONT:PCO 50

**Manual operation:** See "Gate Period Count" on page 527

---

#### [SENSe:]SWEep:EGATe:CONTinuous:PLENgtH <Time>

Defines the length in seconds of a single gate period in continuous gating. The length is determined from the beginning of one gate measurement to the beginning of the next one.

**Parameters:**

<Time> Range: 125 ns to 30 s

\*RST: 5 ms

Default unit: S

**Example:** `SWE:EGAT:CONT:PLEN 10`

**Manual operation:** See ["Gate Period Length"](#) on page 527

**[SENSe:]SWEep:EGATe:CONTinuous[:STATe] <State>**

Activates or deactivates continuous gating.

This setting is only available if `[SENSe:]SWEep:EGATe` is "On".

**Parameters:**

<State>            ON | OFF | 0 | 1  
                       **OFF | 0**  
                       Switches the function off  
                       **ON | 1**  
                       Switches the function on  
                       \*RST:        0

**Example:** `SWE:EGAT ON`  
 Activate gating  
`SWE:EGAT:CONT:STAT ON`  
 Activate continuous gating

**Manual operation:** See ["Continuous Gate"](#) on page 526

**[SENSe:]SWEep:EGATe:HOLDoff <DelayTime>**

Defines the delay time between the gate signal and the continuation of the measurement.

**Note:** If you perform gated measurements in combination with the IF Power trigger, the FSW ignores the holding time for frequency sweep, FFT sweep, zero span and I/Q mode measurements.

**Parameters:**

<DelayTime>        Range:        0 s to 30 s  
                       \*RST:        0 s  
                       Default unit: S

**Example:** `SWE:EGAT:HOLD 100us`

**Manual operation:** See ["Gate Delay"](#) on page 526

**[SENSe:]SWEep:EGATe:LENGth <GateLength>**

Defines the gate length.

**Parameters:**

<GateLength>       Range:        125 ns to 30 s  
                       \*RST:        400µs  
                       Default unit: S

**Example:** `SWE:EGAT:LENG 10ms`

**Manual operation:** See "[Gate Length](#)" on page 526

---

**[SENSe:]SWEep:EGATe:LEVel[:EXTeRnal<tp>] <GateLevel>**

Defines the gate level for which the gate is open.

Is only available for triggered gated measurements ( [SENSe:]SWEep:EGATe:AUTO MAN).

**Suffix:**

<tp>

Selects the trigger port.

1 = trigger port 1 (TRIGGER INPUT connector on front panel)

2 = trigger port 2 (TRIGGER INPUT/OUTPUT connector on front panel)

(Not available for FSW85 models with two RF input connectors.)

3 = trigger port 3 (TRIGGER3 INPUT/OUTPUT connector on rear panel)

**Parameters:**

<GateLevel>

numeric value

Range: 0.5 V to 3.5 V

\*RST: 1.4 V

Default unit: V

**Example:**

```
SENS:SWE:EGAT:AUTO MAN
```

```
SENS:SWE:EGAT:SOUR EXT2
```

```
SENS:SWE:EGAT:LEV:EXT2 1V
```

Sets the gating trigger to a level of 1 V at trigger port 2.

**Manual operation:** See "[Level](#)" on page 528

---

**[SENSe:]SWEep:EGATe:LEVel:IFPower <GateLevel>**

Defines the the power level at the third intermediate frequency that must be exceeded for the gate to be open.

Note that any RF attenuation or preamplification is considered when the trigger level is analyzed. If defined, a reference level offset is also considered.

Is only available for triggered gated measurements ( [SENSe:]SWEep:EGATe:AUTO MAN).

**Parameters:**

<GateLevel>

For details on available trigger levels and trigger bandwidths see the specifications document.

\*RST: -10 dBm

Default unit: DBM

**Example:**

```
SENS:SWE:EGAT:AUTO MAN
```

```
SENS:SWE:EGAT:SOUR IFP
```

```
SENS:SWE:EGAT:LEV:IFP 0
```

Sets the gating trigger to a level of 0 dBm at the third IF.

**[SENSe:]SWEep:EGATe:LEVel:RFPower <GateLevel>**

Defines the gate level for which the gate is open. Note that any RF attenuation or pre-amplification is considered when the trigger level is analyzed. If defined, a reference level offset is also considered.

The input signal must be between 500 MHz and 8 GHz.

Is only available for triggered gated measurements (`[SENSe:]SWEep:EGATe:AUTO MAN`).

**Parameters:**

<GateLevel> For details on available trigger levels and trigger bandwidths, refer to the specifications document.

\*RST: -20 dBm

Default unit: DBM

**Example:**

```
SENS:SWE:EGAT:AUTO MAN
```

```
SENS:SWE:EGAT:SOUR RFP
```

```
SENS:SWE:EGAT:LEV:RFP -10
```

Sets the gating trigger to a level of -10 dBm at the RF input.

**Manual operation:** See "[Level](#)" on page 528

**[SENSe:]SWEep:EGATe:POLarity <Polarity>**

Selects the polarity of an external gate signal.

The setting applies both to the edge of an edge-triggered signal and the level of a level-triggered signal.

**Parameters:**

<Polarity> POSitive | NEGative

\*RST: POSitive

**Example:**

```
SWE:EGAT:POL POS
```

**Manual operation:** See "[Slope](#)" on page 519  
See "[Polarity](#)" on page 528

**[SENSe:]SWEep:EGATe:SOURce <Source>**

Selects the signal source for gated measurements.

If an IF power signal is used, the gate is opened as soon as a signal at > -20 dBm is detected within the IF path bandwidth (10 MHz).

For more information see "[Trigger Source](#)" on page 514.

For triggered gated measurements, only the following gate trigger sources are supported:

- [External Trigger 1/2/3](#)
- [Power Sensor](#)

For details see ["Triggered gated measurements"](#) on page 524

**Parameters:**

<Source>            EXTernal | EXT2 | EXT3 | IFPower | IQPower | VIDEo |  
                          RFPower | PSEN  
 \*RST:            IFPower

**Example:**

SWE:EGAT:SOUR IFP  
 Switches the gate source to IF power.

**Manual operation:**

See ["Trigger Source"](#) on page 514  
 See ["External Trigger 1/2/3"](#) on page 514  
 See ["Video"](#) on page 515  
 See ["IF Power"](#) on page 515  
 See ["RF Power"](#) on page 516  
 See ["Power Sensor"](#) on page 517  
 See ["Source"](#) on page 528

**[SENSe:]SWEep:EGATe:TYPE** <Type>

Selects the way gated measurements are triggered.

**Parameters:**

<Type>            **LEVEL**  
 The trigger event for the gate to open is a particular power level. After the gate signal has been detected, the gate remains open until the signal disappears.  
**Note:** If you perform gated measurements in combination with the IF Power trigger, the FSW ignores the holding time for frequency sweep, FFT sweep, zero span and I/Q mode measurements.  
**EDGE**  
 The trigger event for the gate to open is the detection of the signal edge. After the gate signal has been detected, the gate remains open until the gate length is over.  
 \*RST:            EDGE

**Example:**

SWE:EGAT:TYPE EDGE

**Manual operation:**

See ["Gate Mode"](#) on page 525

### 13.7.5.3 Configuring the trigger output

The following commands are required to send the trigger signal to one of the variable "TRIGGER INPUT/OUTPUT" connectors on the FSW.

OUTPut:TRIGger<tp>:DIRection.....	1230
OUTPut:TRIGger<tp>:LEVel.....	1230
OUTPut:TRIGger<tp>:OTYPe.....	1230
OUTPut:TRIGger<tp>:PULSe:IMMediate.....	1231
OUTPut:TRIGger<tp>:PULSe:LENGth.....	1231

---

**OUTPut:TRIGger<tp>:DIRection** <Direction>

Selects the trigger direction for trigger ports that serve as an input as well as an output.

**Suffix:**

<tp>                      Selects the used trigger port.  
2 = trigger port 2 (front)  
(Not available for FSW85 models with two RF input connectors.)  
3 = trigger port 3 (rear panel)

**Parameters:**

<Direction>              INPut | OUTPut  
**INPut**  
Port works as an input.  
**OUTPut**  
Port works as an output.  
\*RST:                      INPut

**Manual operation:**    See "[Trigger 2/3](#)" on page 468

---

**OUTPut:TRIGger<tp>:LEVel** <Level>

Defines the level of the (TTL compatible) signal generated at the trigger output.

Works only if you have selected a user-defined output with [OUTPut:TRIGger<tp>:OTYPe](#).

**Suffix:**

<tp>                      1..n  
Selects the trigger port to which the output is sent.  
2 = trigger port 2 (front)  
(Not available for FSW85 models with two RF input connectors.)  
3 = trigger port 3 (rear)

**Parameters:**

<Level>                    **HIGH**  
5 V  
**LOW**  
0 V  
\*RST:                      LOW

**Example:**                      OUTP:TRIG2:LEV HIGH

**Manual operation:**    See "[Level](#)" on page 469

---

**OUTPut:TRIGger<tp>:OTYPe** <OutputType>

Selects the type of signal generated at the trigger output.

## Setting basic measurement parameters

**Suffix:**  
 <tp> 1..n  
 Selects the trigger port to which the output is sent.  
 2 = trigger port 2 (front)  
 (Not available for FSW85 models with two RF input connectors.)  
 3 = trigger port 3 (rear)

**Parameters:**  
 <OutputType>

**DEvice**  
 Sends a trigger signal when the FSW has triggered internally.

**TARMed**  
 Sends a trigger signal when the trigger is armed and ready for an external trigger event.

**UDEfined**  
 Sends a user-defined trigger signal. For more information, see [OUTPut:TRIGger<tp>:LEVel](#).

\*RST: DEvice

**Manual operation:** See "[Output Type](#)" on page 469

**OUTPut:TRIGger<tp>:PULSe:IMMediate**

Generates a pulse at the trigger output.

**Suffix:**  
 <tp> 1..n  
 Selects the trigger port to which the output is sent.  
 2 = trigger port 2 (front)  
 (Not available for FSW85 models with two RF input connectors.)  
 3 = trigger port 3 (rear)

**Manual operation:** See "[Send Trigger](#)" on page 470

**OUTPut:TRIGger<tp>:PULSe:LENGth <Length>**

Defines the length of the pulse generated at the trigger output.

**Suffix:**  
 <tp> Selects the trigger port to which the output is sent.  
 2 = trigger port 2 (front)  
 (Not available for FSW85 models with two RF input connectors.)  
 3 = trigger port 3 (rear)

**Parameters:**  
 <Length> Pulse length in seconds.  
 Default unit: S

**Example:** `OUTP:TRIG2:PULS:LENG 0.02`

**Manual operation:** See "[Pulse Length](#)" on page 470

#### 13.7.5.4 Programming example: continuous gating

This example demonstrates how to perform a measurement with continuous gating in a remote environment.

```
//-----Configuring the measurement -----
*RST

//ACLR LTE TDD with 51 MHz Span
CALC:MARK:FUNC:POW:PRES EUTra
FREQ:CENT 1GHZ
SWE:EGAT ON
SWE:EGAT:SOUR EXT
SWE:EGAT:TYPE EDGE
SWE:EGAT:HOLD 9.25MS
SWE:EGAT:LENG 1.25MS
SWE:EGAT:CONTinuous:STAT?
//0
SWE:EGAT:CONTinuous:STAT ON
SWE:EGAT:CONTinuous:STAT?
//1
SWE:EGAT:CONTinuous:PLENght?
//0.005
SWE:EGAT:CONTinuous:PLENght 4MS
SWE:EGAT:CONTinuous:PLENght?
//0.004
SWE:EGAT:CONTinuous:PCount?
//100
SWE:EGAT:CONTinuous:PCount 80
SWE:EGAT:CONTinuous:PCount?
//80

//-----Performing the Measurement-----
INIT:CONT OFF
INIT
// Sweep duration is less than 1 second
```

#### 13.7.6 Adjusting settings automatically

The commands required to adjust settings automatically in a remote environment are described here.

The tasks for manual operation are described in [Chapter 7.7, "Adjusting settings automatically"](#), on page 530.





### MSRA operating mode

In MSRA operating mode, settings related to data acquisition (measurement time, hysteresis) can only be adjusted automatically in the MSRA primary application, not in the MSRA secondary applications.

[SENSe:]ADJust:ALL.....	1233
[SENSe:]ADJust:CONFigure:LEVel:DURation.....	1233
[SENSe:]ADJust:CONFigure:LEVel:DURation:MODE.....	1234
[SENSe:]ADJust:CONFigure:HYSteresis:LOWer.....	1234
[SENSe:]ADJust:CONFigure:HYSteresis:UPPer.....	1234
[SENSe:]ADJust:CONFigure:TRIGger.....	1235
[SENSe:]ADJust:FREQuency.....	1235
[SENSe:]ADJust:LEVel.....	1236

---

### [SENSe:]ADJust:ALL

Initiates a measurement to determine and set the ideal settings for the current task automatically (only once for the current measurement).

This includes:

- Center frequency
- Reference level

**Example:** ADJ:ALL

**Manual operation:** See ["Adjusting all Determinable Settings Automatically \(Auto All\)"](#) on page 531

---

### [SENSe:]ADJust:CONFigure:LEVel:DURation <Duration>

To determine the ideal reference level, the FSW performs a measurement on the current input data. This command defines the length of the measurement if [SENSe:]ADJust:CONFigure:LEVel:DURation:MODE is set to MANual.

#### Parameters:

<Duration>            Numeric value in seconds  
 Range:            0.001 to 16000.0  
 \*RST:            0.001  
 Default unit: s

**Example:** ADJ:CONF:DUR:MODE MAN  
 Selects manual definition of the measurement length.  
 ADJ:CONF:LEV:DUR 5ms  
 Length of the measurement is 5 ms.

**Manual operation:** See ["Changing the Automatic Measurement Time \(Meas Time Manual\)"](#) on page 532

**[SENSe:]ADJust:CONFigure:LEVel:DURation:MODE <Mode>**

To determine the ideal reference level, the FSW performs a measurement on the current input data. This command selects the way the FSW determines the length of the measurement .

**Parameters:**

&lt;Mode&gt;

**AUTO**

The FSW determines the measurement length automatically according to the current input data.

**MANual**

The FSW uses the measurement length defined by [\[SENSe:\]ADJust:CONFigure:LEVel:DURation](#) on page 1233.

\*RST: AUTO

**Manual operation:** See ["Resetting the Automatic Measurement Time \(Meas Time Auto\)"](#) on page 532  
See ["Changing the Automatic Measurement Time \(Meas Time Manual\)"](#) on page 532

**[SENSe:]ADJust:CONFigure:HYSTeresis:LOWer <Threshold>**

When the reference level is adjusted automatically using the [\[SENSe:\]ADJust:LEVel](#) on page 1236 command, the internal attenuators and the preamplifier are also adjusted. To avoid frequent adaptation due to small changes in the input signal, you can define a hysteresis. This setting defines a lower threshold the signal must fall below (compared to the last measurement) before the reference level is adapted automatically.

**Parameters:**

&lt;Threshold&gt;

Range: 0 dB to 200 dB

\*RST: +1 dB

Default unit: dB

**Example:**

```
SENS:ADJ:CONF:HYST:LOW 2
```

For an input signal level of currently 20 dBm, the reference level is only adjusted when the signal level falls below 18 dBm.

**Manual operation:** See ["Lower Level Hysteresis"](#) on page 533

**[SENSe:]ADJust:CONFigure:HYSTeresis:UPPer <Threshold>**

When the reference level is adjusted automatically using the [\[SENSe:\]ADJust:LEVel](#) on page 1236 command, the internal attenuators and the preamplifier are also adjusted. To avoid frequent adaptation due to small changes in the input signal, you can define a hysteresis. This setting defines an upper threshold the signal must exceed (compared to the last measurement) before the reference level is adapted automatically.

## Setting basic measurement parameters

**Parameters:**

<Threshold>            Range:        0 dB to 200 dB  
                           \*RST:        +1 dB  
                           Default unit: dB

**Example:**            SENS:ADJ:CONF:HYST:UPP 2

**Example:**            For an input signal level of currently 20 dBm, the reference level is only adjusted when the signal level rises above 22 dBm.

**Manual operation:**   See ["Upper Level Hysteresis"](#) on page 532

**[SENSe:]ADJust:CONFigure:TRIGger <State>**

Defines the behavior of a triggered measurement when adjusting a setting automatically (using SENS:ADJ:LEV ON, for example).

See ["Adjusting settings automatically during triggered measurements"](#) on page 531.

**Parameters:**

<State>                ON | OFF | 0 | 1  
**ON | 1**  
 (default:) The measurement for adjustment waits for the next trigger.  
 To abort the measurement, use [ABORT](#) on page 908.  
**OFF | 0**  
 The measurement for adjustment is performed without waiting for a trigger (corresponds to "Continue" in manual operation).  
 \*RST:                0

**Example:**

```
//Use default ref level at 0.00 dBm.
//Define an RF power trigger at -20 dBm
:TRIG:SEQ:SOUR RFP
:TRIG:SEQ:LEV:RFP -20
//Perform adjustment measurement without waiting for trigger
SENS:ADJ:CONF:TRIG OFF
//Perform auto level adjustment
:SENS:ADJ:LEV;*WAI
```

**[SENSe:]ADJust:FREQuency**

Sets the center frequency to the frequency with the highest signal level in the current frequency range.

**Example:**            ADJ:FREQ

**Manual operation:**   See ["Adjusting the Center Frequency Automatically \(Auto Frequency\)"](#) on page 531

**[SENSe:]ADJ:LEVel**

Initiates a single (internal) measurement that evaluates and sets the ideal reference level for the current input data and measurement settings. Thus, the settings of the RF attenuation and the reference level are optimized for the signal level. The FSW is not overloaded and the dynamic range is not limited by an S/N ratio that is too small.

**Example:** ADJ:LEV

**Manual operation:** See "Setting the Reference Level Automatically (Auto Level)" on page 486

## 13.8 Analyzing measurements (basics)

The commands for general analysis tasks are described here.

- [Zooming into the display](#)..... 1236
- [Configuring the trace display and retrieving trace data](#)..... 1239
- [Working with markers](#)..... 1268
- [Configuring display lines](#)..... 1328
- [Defining limit checks](#)..... 1330

### 13.8.1 Zooming into the display

#### 13.8.1.1 Using the single zoom

- [DISPlay\[:WINDow<n>\]\[:SUBWindow<w>\]:ZOOM:AREA](#)..... 1236
- [DISPlay\[:WINDow<n>\]\[:SUBWindow<w>\]:ZOOM\[:STATE\]](#)..... 1237

**DISPlay[:WINDow<n>][:SUBWindow<w>]:ZOOM:AREA <x1>,<y1>,<x2>,<y2>**

Defines the zoom area.

To define a zoom area, you first have to turn the zoom on.

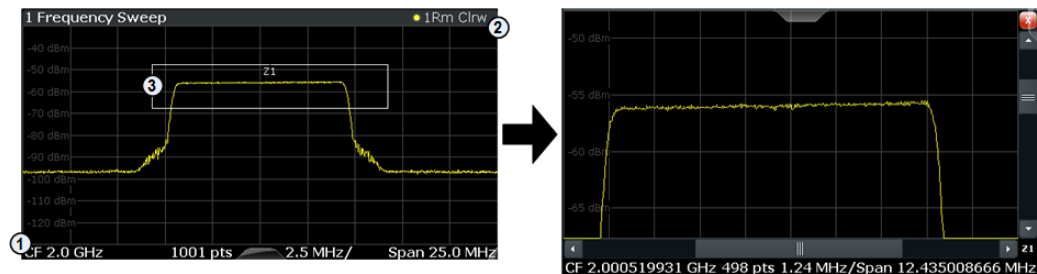

- 1 = origin of coordinate system (x1 = 0, y1 = 0)
- 2 = end point of system (x2 = 100, y2= 100)
- 3 = zoom area (e.g. x1 = 60, y1 = 30, x2 = 80, y2 = 75)

**Suffix:**

<n>	<a href="#">Window</a>
<w>	subwindow Not supported by all applications

**Parameters:**

<x1>	Diagram coordinates in % of the complete diagram that define the zoom area. The lower left corner is the origin of coordinate system. The upper right corner is the end point of the system. Range: 0 to 100 Default unit: PCT
<y1>	Diagram coordinates in % of the complete diagram that define the zoom area. The lower left corner is the origin of coordinate system. The upper right corner is the end point of the system. Range: 0 to 100 Default unit: PCT
<x2>	Diagram coordinates in % of the complete diagram that define the zoom area. The lower left corner is the origin of coordinate system. The upper right corner is the end point of the system. Range: 0 to 100 Default unit: PCT
<y2>	Diagram coordinates in % of the complete diagram that define the zoom area. The lower left corner is the origin of coordinate system. The upper right corner is the end point of the system. Range: 0 to 100 Default unit: PCT

**Manual operation:** See "[Single Zoom](#)" on page 543

**DISPlay[:WINDow<n>][:SUBWindow<w>]:ZOOM[:STATe] <State>**

Turns the zoom on and off.

**Suffix:**

<n>	<a href="#">Window</a>
<w>	subwindow Not supported by all applications

**Parameters:**

<State>	ON   OFF   0   1 <b>OFF   0</b> Switches the function off
---------	-----------------------------------------------------------------

**ON | 1**

Switches the function on

**Example:**

DISP:ZOOM ON  
Activates the zoom mode.

**Manual operation:**

See "Single Zoom" on page 543  
See "Restore Original Display" on page 544

**13.8.1.2 Using the multiple zoom**

DISPlay[:WINDow<n>][:SUBWindow<w>]:ZOOM:MULTiple<zn>:AREA.....1238  
DISPlay[:WINDow<n>][:SUBWindow<w>]:ZOOM:MULTiple<zn>[:STATe]..... 1239

**DISPlay[:WINDow<n>][:SUBWindow<w>]:ZOOM:MULTiple<zn>:AREA**  
**<x1>,<y1>,<x2>,<y2>**

Defines the zoom area for a multiple zoom.

To define a zoom area, you first have to turn the zoom on.

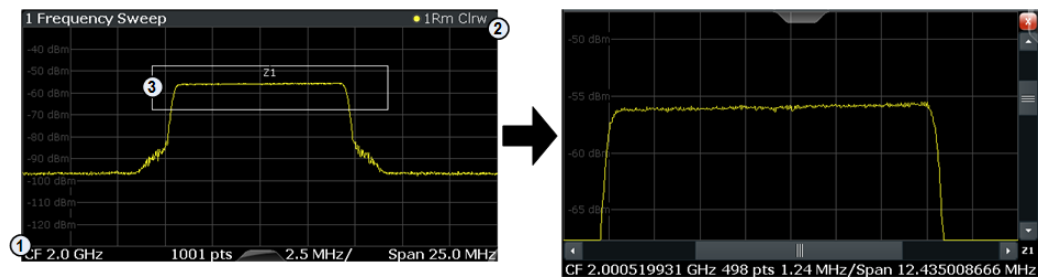

- 1 = origin of coordinate system (x1 = 0, y1 = 0)
- 2 = end point of system (x2 = 100, y2= 100)
- 3 = zoom area (e.g. x1 = 60, y1 = 30, x2 = 80, y2 = 75)

**Suffix:**

- <n> [Window](#)
- <w> subwindow  
Not supported by all applications
- <zn> Selects the zoom window.

**Parameters:**

- <x1> Diagram coordinates in % of the complete diagram that define the zoom area.  
The lower left corner is the origin of coordinate system. The upper right corner is the end point of the system.  
Range: 0 to 100  
Default unit: PCT

<code>&lt;y1&gt;</code>	Diagram coordinates in % of the complete diagram that define the zoom area. The lower left corner is the origin of coordinate system. The upper right corner is the end point of the system. Range: 0 to 100 Default unit: PCT
<code>&lt;x2&gt;</code>	Diagram coordinates in % of the complete diagram that define the zoom area. The lower left corner is the origin of coordinate system. The upper right corner is the end point of the system. Range: 0 to 100 Default unit: PCT
<code>&lt;y2&gt;</code>	Diagram coordinates in % of the complete diagram that define the zoom area. The lower left corner is the origin of coordinate system. The upper right corner is the end point of the system. Range: 0 to 100 Default unit: PCT

**Manual operation:** See "[Multi-Zoom](#)" on page 543

**DISPlay[:WINDow<n>][:SUBWindow<w>]:ZOOM:MULTiple<zn>[:STATe] <State>**

Turns the multiple zoom on and off.

**Suffix:**

<code>&lt;n&gt;</code>	<a href="#">Window</a>
<code>&lt;w&gt;</code>	subwindow Not supported by all applications
<code>&lt;zn&gt;</code>	Selects the zoom window. If you turn off one of the zoom windows, all subsequent zoom windows move up one position.

**Parameters:**

<code>&lt;State&gt;</code>	ON   OFF   0   1 <b>OFF   0</b> Switches the function off <b>ON   1</b> Switches the function on
----------------------------	--------------------------------------------------------------------------------------------------------------

**Manual operation:** See "[Multi-Zoom](#)" on page 543  
See "[Restore Original Display](#)" on page 544

## 13.8.2 Configuring the trace display and retrieving trace data

The commands required to work with traces are described here.

- [Configuring standard traces](#)..... 1240
- [Configuring spectrograms](#)..... 1248
- [Using trace mathematics](#)..... 1255
- [Retrieving trace results](#)..... 1257
- [Formats for returned values: ASCII format and binary format](#)..... 1261
- [Importing and exporting traces](#)..... 1262
- [Programming example: configuring a spectrogram](#)..... 1265

### 13.8.2.1 Configuring standard traces

#### Useful commands for trace configuration described elsewhere

- [DISPlay\[:WINDow<n>\]\[:SUBWindow<w>\]:TRACe<t>:Y:SPACing](#)  
on page 1216
- [DISPlay\[:WINDow<n>\]\[:SUBWindow<w>\]:TRACe<t>:Y\[:SCALe\]](#)  
on page 1214

#### Remote commands exclusive to trace configuration

- [DISPlay\[:WINDow<n>\]:TRACe<t>:LABel\[:STATe\]](#)..... 1240
- [DISPlay\[:WINDow<n>\]:TRACe<t>:LABel:TEXT](#)..... 1241
- [DISPlay\[:WINDow<n>\]\[:SUBWindow<w>\]:TRACe<t>:MODE](#)..... 1241
- [DISPlay\[:WINDow<n>\]\[:SUBWindow<w>\]:TRACe<t>:MODE:HCONtinuous](#)..... 1242
- [DISPlay\[:WINDow<n>\]\[:SUBWindow<w>\]:TRACe<t>:PRESet](#)..... 1243
- [DISPlay\[:WINDow<n>\]\[:SUBWindow<w>\]:TRACe<t>\[:STATe\]](#)..... 1243
- [DISPlay\[:WINDow<n>\]\[:SUBWindow<w>\]:TRACe<t>:SMOothing:APERture](#)..... 1244
- [DISPlay\[:WINDow<n>\]\[:SUBWindow<w>\]:TRACe<t>:SMOothing\[:STATe\]](#)..... 1244
- [\[SENSe:\]AVERAge<n>:COUNT](#)..... 1245
- [\[SENSe:\]AVERAge<n>\[:STATe<t>\]](#)..... 1245
- [\[SENSe:\]AVERAge<n>:TYPE](#)..... 1245
- [\[SENSe:\]WINDow<n>:\]DETEctor<t>\[:FUNCTion\]](#)..... 1246
- [\[SENSe:\]WINDow<n>:\]DETEctor<t>\[:FUNCTion\]:AUTO](#)..... 1247
- [TRACe<n>:COPY](#)..... 1247

---

#### DISPlay[:WINDow<n>]:TRACe<t>:LABel[:STATe] <State>

Turns on the display of a descriptive label for the specified trace instead of the default "Trace <x>" label.

Define the label using the [DISPlay\[:WINDow<n>\]:TRACe<t>:LABel:TEXT](#) command.

You can only configure labels for active traces and for traces whose "State" is enabled.

#### Suffix:

<n>                     1..n  
                          Window



<t> 1..n  
Trace

**Parameters:**

<State> **OFF**  
Switch the function off

**ON**  
Switch the function on

\*RST: OFF

**Example:**

```
DISP:WIND2:TRAC1:LAB ON
DISP:WIND2:TRAC1:LAB:TEXT 'MaxTrace'
```

**Manual operation:** See "Trace Labels" on page 627

**DISPlay[:WINDow<n>]:TRACe<t>:LABel:TEXT <Text>**

Defines a descriptive label for the specified trace instead of the default "Trace <x>" label.

Enable the label using the `DISPlay[:WINDow<n>]:TRACe<t>:LABel[:STATE]` command.

You can only configure labels for active traces and for traces whose "State" is enabled.

**Suffix:**

<n> 1..n  
Window

<t> 1..n  
Trace

**Parameters:**

<Text> String containing the trace label.

**Example:**

```
DISP:WIND2:TRAC1:LAB ON
DISP:WIND2:TRAC1:LAB:TEXT 'MaxTrace'
```

**Manual operation:** See "Trace Labels" on page 627

**DISPlay[:WINDow<n>][:SUBWindow<w>]:TRACe<t>:MODE <Mode>**

Selects the trace mode. If necessary, the selected trace is also activated.

For max hold, min hold or average trace mode, you can set the number of single measurements with `[SENSe:]SWEep:COUNT`. Note that synchronization to the end of the measurement is possible only in single sweep mode.

**Suffix:**

<n> Window

<w> subwindow  
Not supported by all applications

&lt;t&gt;

**Trace****Parameters:**

&lt;Mode&gt;

**WRITe**

(default:) Overwrite mode: the trace is overwritten by each sweep.

**AVERAge**

The average is formed over several sweeps. The "Sweep/Average Count" determines the number of averaging procedures.

**MAXHold**

The maximum value is determined over several sweeps and displayed. The FSW saves the sweep result in the trace memory only if the new value is greater than the previous one.

**MINHold**

The minimum value is determined from several measurements and displayed. The FSW saves the sweep result in the trace memory only if the new value is lower than the previous one.

**VIEW**

The current contents of the trace memory are frozen and displayed.

**BLANK**

Hides the selected trace.

\*RST: Trace 1: WRITe, Trace 2-6: BLANK

**Example:**

```
INIT:CONT OFF
```

Switching to single sweep mode.

```
SWE:COUN 16
```

Sets the number of measurements to 16.

```
DISP:TRAC3:MODE WRIT
```

Selects clear/write mode for trace 3.

```
INIT;*WAI
```

Starts the measurement and waits for the end of the measurement.

**Manual operation:** See "[Trace Mode](#)" on page 623

---

**DISPlay[:WINDow<n>][:SUBWindow<w>]:TRACe<t>:MODE:HCONTinuous**  
<State>

Turns an automatic reset of a trace on and off after a parameter has changed.

The reset works for trace modes min hold, max hold and average.

Note that the command has no effect if critical parameters like the span have been changed to avoid invalid measurement results

**Suffix:**

&lt;n&gt;

[Window](#)

&lt;w&gt;

subwindow

<t> [Trace](#)

**Parameters:**

<State> ON | OFF | 0 | 1  
**OFF | 0**  
 Switches the function off  
**ON | 1**  
 Switches the function on

**Example:** DISP:WIND:TRAC3:MODE:HCON ON  
 Switches off the reset function.

**Manual operation:** See "[Hold](#)" on page 624

**DISPlay[:WINDow<n>][:SUBWindow<w>]:TRACe<t>:PRESet <ResultType>**

Applies predefined, commonly required trace settings to the selected window.

**Suffix:**

<n> 1..n  
[Window](#)

<w> 1..n  
 subwindow

<t> 1..n  
[Trace](#)

**Parameters:**

<ResultType> **ALL**  
 Preset All Traces  
**MAM**  
 Max | Avg | Min  
**MCM**  
 Max | ClrWrite | Min

**Example:** DISP:WIND3:TRAC:PRES MCM  
 In window 3, the traces are set to the following modes:  
 Trace 1: Max Hold  
 Trace 2: Clear Write  
 Trace 3: Min Hold

**Manual operation:** See "[Predefined Trace Settings - Quick Config](#)" on page 626

**DISPlay[:WINDow<n>][:SUBWindow<w>]:TRACe<t>[:STATE] <State>**

Turns a trace on and off.

The measurement continues in the background.

**Suffix:**

<n> [Window](#)

<w> subwindow  
Not supported by all applications

<t> [Trace](#)

**Parameters:**

<State> ON | OFF | 0 | 1  
**OFF | 0**  
Switches the function off  
**ON | 1**  
Switches the function on

**Example:** DISP:TRAC3 ON

**Manual operation:** See "[Trace 1/Trace 2/Trace 3/Trace 4/Trace 5/Trace 6](#)" on page 623  
See "[Trace 1/ Trace 2/ Trace 3/ Trace 4 \(Softkeys\)](#)" on page 626

**DISPlay[:WINDow<n>][:SUBWindow<w>]:TRACe<t>:SMOothing:APERture**  
 <Aperture>

Defines the degree (aperture) of the trace smoothing, if `DISPlay[:WINDow<n>][:SUBWindow<w>]:TRACe<t>:SMOothing[:STATe]TRUE`.

**Suffix:**

<n> [Window](#)

<w> subwindow

<t> [Trace](#)

**Parameters:**

<Aperture> Range: 1 to 50  
\*RST: 2  
Default unit: PCT

**Example:** DISP3:TRAC2:SMO:APER 5  
Defines an aperture of 5% for trace 2 in window 3

**Manual operation:** See "[Smoothing](#)" on page 625

**DISPlay[:WINDow<n>][:SUBWindow<w>]:TRACe<t>:SMOothing[:STATe] <State>**

Turns trace smoothing for a particular trace on and off.

If enabled, the trace is smoothed by the value specified using `DISPlay[:WINDow<n>][:SUBWindow<w>]:TRACe<t>:SMOothing:APERture` on page 1244.

For more information see "[Trace smoothing](#)" on page 621.

**Suffix:**

<n> [Window](#)

<w> subwindow

<t> [Trace](#)

**Parameters:**

<State> ON | OFF | 0 | 1  
**OFF | 0**  
 Switches the function off  
**ON | 1**  
 Switches the function on

**Example:** DISP3:TRAC2:SMO ON  
 Turns on trace smoothing for trace 2 in window 3

**Manual operation:** See "[Smoothing](#)" on page 625

**[SENSe:]AVERAge<n>:COUNT** <AverageCount>

Defines the number of sweeps that the application uses to average traces.

In case of continuous sweep mode, the application calculates the moving average over the average count.

In case of single sweep mode, the application stops the measurement and calculates the average after the average count has been reached.

**Suffix:**

<n> irrelevant

**Parameters:**

<AverageCount> If you set an average count of 0 or 1, the application performs one single sweep in single sweep mode.  
 In continuous sweep mode, if the average count is set to 0, a moving average over 10 sweeps is performed.  
 Range: 0 to 200000  
 \*RST: 0

**Manual operation:** See "[Sweep/Average Count](#)" on page 504  
 See "[Average Count](#)" on page 625

**[SENSe:]AVERAge<n>[:STATe<t>]** <State>

Turns averaging for a particular trace in a particular window on and off.

**Suffix:**

<n> [Window](#)

<t> [Trace](#)

**Parameters:**

<State> ON | OFF | 1 | 0

**[SENSe:]AVERAge<n>:TYPE** <Mode>

Selects the trace averaging mode.

**Suffix:**

<n> 1..n  
[Window](#)

**Parameters:**

<Mode> **LOGarithmic**  
 The logarithmic power values are averaged.

**LINear**  
 The power values are averaged before they are converted to logarithmic values.

**POWER**  
 The power level values are converted into unit Watt prior to averaging. After the averaging, the data is converted back into its original unit.

**Example:**

AVER:TYPE LIN  
 Switches to linear average calculation.

**Manual operation:** See "[Average Mode](#)" on page 625

**[SENSe:][WINDow<n>:]DETector<t>[:FUNction] <Detector>**

Defines the trace detector to be used for trace analysis.

For details see "[Mapping samples to sweep points with the trace detector](#)" on page 609.

For EMI measurements, the trace detector is used for the initial peak search only, not for the final test. The detector for the final test is configured using [CALCulate<n>:MARKer<m>:FUNction:FMEasurement:DETector](#) on page 1081.

If the EMI (R&S FSW-K54) measurement option is installed and the filter type "CISPR" is selected, additional detectors are available, even if EMI measurement is not active. For details see [Chapter 6.13.3.2, "Detectors and dwell time"](#), on page 336.

**Suffix:**

<n> [Window](#)

<t> [Trace](#)

**Parameters:**

<Detector> **APEak**  
 Autopeak

**NEGative**  
 Negative peak

**POSitive**  
 Positive peak

**QPEak**  
 Quasipeak (CISPR filter only)

**SAMPlE**  
 First value detected per trace point

**RMS**

RMS value

**AVERage**

Average

**CAVerage**

CISPR Average (CISPR filter only)

**CRMS**

CISPR RMS (CISPR filter only)

\*RST: APEak

**Example:** DET POS  
Sets the detector to "positive peak".

**Manual operation:** See "[Detector](#)" on page 624

**[SENSe:][WINDow<n>:]DETEctor<t>[:FUNctioN]:AUTO <State>**

Couples and decouples the detector to the trace mode.

**Suffix:**

<n> [Window](#)

<t> [Trace](#)

**Parameters:**

<State> ON | OFF | 0 | 1

\*RST: 1

**Example:** DET:AUTO OFF  
The selection of the detector is not coupled to the trace mode.

**Manual operation:** See "[Detector](#)" on page 624

**TRACe<n>:COPY <TraceNumber>, <TraceNumber>**

Copies data from one trace to another.

**Suffix:**

<n> [Window](#)

**Parameters:**

<TraceNumber> **TRACE1 | TRACE2 | TRACE3 | TRACE4 | TRACE5 | TRACE6**

The first parameter is the destination trace, the second parameter is the source.

(Note the 'e' in the parameter is required!)

**Example:** TRAC:COPY TRACE1,TRACE2  
Copies the data from trace 2 to trace 1.

**Manual operation:** See "[Copy Trace](#)" on page 627

### 13.8.2.2 Configuring spectrograms

In addition to the standard "level versus frequency" or "level versus time" spectrum traces, the FSW also provides a spectrogram display of the measured data. A spectrogram shows how the spectral density of a signal varies over time. The x-axis shows the frequency, the y-axis shows the time. The commands required to configure spectrograms in a remote environment are described here. For details and manual operation see [Chapter 8.5.2.2, "Spectrogram settings"](#), on page 637.



When configuring spectrograms, the window suffix is irrelevant. The settings are always applied to the spectrogram window, or to all spectrogram windows, if several are active for the same channel.

For commands to set markers in spectrograms, see [Chapter 13.8.3.6, "Marker search \(spectrograms\)"](#), on page 1289.

Configuring a spectrogram measurement.....	1248
Configuring the color map.....	1253

#### Configuring a spectrogram measurement

CALCulate<n>:SGRam:CLEAr[:IMMEDIATE].....	1248
CALCulate<n>:SPECtrogram:CLEAr[:IMMEDIATE].....	1248
CALCulate<n>:SGRam:CONTinuous.....	1249
CALCulate<n>:SPECtrogram:CONTinuous.....	1249
CALCulate<n>:SGRam:FRAMe:COUNT.....	1249
CALCulate<n>:SPECtrogram:FRAMe:COUNT.....	1249
CALCulate<n>:SGRam:FRAMe:SElect.....	1250
CALCulate<n>:SPECtrogram:FRAMe:SElect.....	1250
CALCulate<n>:SGRam:HDEPth.....	1250
CALCulate<n>:SPECtrogram:HDEPth.....	1250
CALCulate<n>:SGRam:LAYout.....	1251
CALCulate<n>:SPECtrogram:LAYout.....	1251
CALCulate<n>:SGRam[:STATe].....	1251
CALCulate<n>:SPECtrogram[:STATe].....	1251
CALCulate<n>:SGRam:THReedim[:STATe].....	1251
CALCulate<n>:SPECtrogram:THReedim[:STATe].....	1251
CALCulate<n>:SGRam:TRACe.....	1252
CALCulate<n>:SPECtrogram:TRACe.....	1252
CALCulate<n>:SGRam:TSTamp:DATA?.....	1252
CALCulate<n>:SPECtrogram:TSTamp:DATA?.....	1252
CALCulate<n>:SGRam:TSTamp[:STATe].....	1253
CALCulate<n>:SPECtrogram:TSTamp[:STATe].....	1253

---

**CALCulate<n>:SGRam:CLEAr[:IMMEDIATE]**

**CALCulate<n>:SPECtrogram:CLEAr[:IMMEDIATE]**

Resets the spectrogram and clears the history buffer.



**Suffix:**<n> [Window](#)**Example:**

```
//Reset the result display and clear the memory
CALC:SGR:CLE
```

**Manual operation:** See ["Clear Spectrogram"](#) on page 508**CALCulate<n>:SGRam:CONTInuous <State>****CALCulate<n>:SPECtrogram:CONTInuous <State>**

Determines whether the results of the last measurement are deleted before starting a new measurement in single sweep mode.

This setting applies to all spectrograms in the channel.

**Suffix:**<n> [Window](#)**Parameters:**

&lt;State&gt; ON | OFF | 0 | 1

**OFF | 0**

Switches the function off

**ON | 1**

Switches the function on

**Example:**

```
INIT:CONT OFF
```

Selects single sweep mode.

```
INIT;*WAI
```

Starts the sweep and waits for the end of the sweep.

```
CALC:SGR:CONT ON
```

Repeats the single sweep measurement without deleting the results of the last measurement.

**Manual operation:** See ["Single Sweep / Run Single"](#) on page 506See ["Continue Frame"](#) on page 507**CALCulate<n>:SGRam:FRAMe:COUNT <Frames>****CALCulate<n>:SPECtrogram:FRAMe:COUNT <Frames>**

Defines the number of frames to be recorded in a single sweep.

This value applies to all spectrograms in the channel.

**Suffix:**<n> [Window](#)**Parameters:**

&lt;Frames&gt; The maximum number of frames depends on the history depth.

Range: 1 to history depth

Increment: 1

\*RST: 1

**Example:**

```
//Select single sweep mode
INIT:CONT OFF
//Set the number of frames to 200
CALC:SGR:FRAM:COUN 200
```

**Manual operation:** See ["Frame Count"](#) on page 508

**CALCulate<n>:SGRam:FRAMe:SElect <Frame> | <Time>**  
**CALCulate<n>:SPECtrogram:FRAMe:SElect <Frame> | <Time>**

Selects a specific frame for further analysis.

The command is available if no measurement is running or after a single sweep has ended.

**Suffix:**  
 <n> [Window](#)

**Parameters:**

<Frame> Selects a frame directly by the frame number. Valid if the time stamp is off.  
 The range depends on the history depth.  
 Default unit: S

<Time> Selects a frame via its time stamp. Valid if the time stamp is on.  
 The number is the distance to frame 0 in seconds. The range depends on the history depth.

**Example:**

```
INIT:CONT OFF
Stop the continuous sweep.
CALC:SGR:FRAM:SEL -25
Selects frame number -25.
```

**Manual operation:** See ["Select Frame"](#) on page 507

**CALCulate<n>:SGRam:HDEPth <History>**  
**CALCulate<n>:SPECtrogram:HDEPth <History>**

Defines the number of frames to be stored in the FSW memory.

**Suffix:**  
 <n> [Window](#)

**Parameters:**

<History> The maximum number of frames depends on the number of sweep points.  
 Range: 781 to 20000  
 Increment: 1  
 \*RST: 3000

**Example:**

```
//Set the history depth to 1500
CALC:SGR:SPEC 1500
```

**Manual operation:** See ["History Depth"](#) on page 639

---

**CALCulate**<n>:SGRam:LAYout <State>

**CALCulate**<n>:SPECtrogram:LAYout <State>

This command selects the state and size of spectrograms.

The command is available for result displays that support spectrograms.

**Suffix:**

<n> [Window](#)

**Parameters:**

<State>

**FULL**

Only the spectrogram is displayed, the trace diagram is not.

**SPLIT**

Spectrogram and trace diagram share a window.

**OFF**

Only the trace diagram is displayed, the spectrogram is not.

\*RST: OFF

**Example:**

CALC4:SPEC:LAY FULL

Shows the spectrogram in window 4. The corresponding trace diagram is hidden.

**Manual operation:** See ["State"](#) on page 638

---

**CALCulate**<n>:SGRam[:STATe] <State>

**CALCulate**<n>:SPECtrogram[:STATe] <State>

Turns the spectrogram on and off.

**Suffix:**

<n> irrelevant

**Parameters:**

<State>

ON | OFF | 0 | 1

**OFF | 0**

Switches the function off

**ON | 1**

Switches the function on

**Example:**

CALC:SGR ON

Activates the Spectrogram result display.

---

**CALCulate**<n>:SGRam:THReedim[:STATe] <State>

**CALCulate**<n>:SPECtrogram:THReedim[:STATe] <State>

Activates or deactivates a 3-dimensional spectrogram for the selected result display.

**Suffix:**

<n> [Window](#)

**Parameters:**

<State>

ON | OFF | 0 | 1

**OFF | 0**

Switches the function off

**ON | 1**

Switches the function on

\*RST: 0

**Example:** CALC:SPEC:THR:STAT ON**Manual operation:** See "[3D Spectrogram State](#)" on page 639**CALCulate<n>:SGRam:TRACe <Trace>****CALCulate<n>:SPECtrogram:TRACe <Trace>**

This command determines the trace in the result display the Spectrogram is based on.

**Suffix:**<n> [Window](#)**Parameters:**<Trace> TRACE1 | TRACE2 | TRACE3 | TRACE4 | TRACE5 | TRACE6  
How many traces are available depends on the selected result display.**Example:** CALC2:SPEC:TRAC TRACE3**CALCulate<n>:SGRam:TSTamp:DATA? <Frames>****CALCulate<n>:SPECtrogram:TSTamp:DATA? <Frames>**

Queries the starting time of the frames.

The return values consist of four values for each frame. If the "Spectrogram" is empty, the command returns '0,0,0,0'. The times are given as delta values, which simplifies evaluating relative results; however, you can also calculate the absolute date and time as displayed on the screen.

The frame results themselves are returned with TRAC:DATA? SGR

See [TRACe<n> \[ :DATA\]](#) on page 1258.**Suffix:**<n> [Window](#)**Query parameters:**<Frames> **CURRENT**  
Returns the starting time of the current frame.**ALL**

Returns the starting time for all frames. The results are sorted in descending order, beginning with the current frame.

**Return values:**

&lt;Seconds&gt; Number of seconds that have passed since 01.01.1970 until the frame start

<Nanoseconds>	Number of nanoseconds that have passed <i>in addition to the</i> <Seconds> since 01.01.1970 until the frame start.
<Reserved>	The third value is reserved for future uses.
<Reserved>	The fourth value is reserved for future uses.
<b>Example:</b>	<code>CALC:SGR:TST:DATA? ALL</code> Returns the starting times of all frames sorted in a descending order.
<b>Usage:</b>	Query only
<b>Manual operation:</b>	See " <a href="#">Time Stamp</a> " on page 639

---

**CALCulate<n>:SGRam:TSTamp[:STATe] <State>**  
**CALCulate<n>:SPECtrogram:TSTamp[:STATe] <State>**

Activates and deactivates the time stamp.

If the time stamp is active, some commands do not address frames as numbers, but as (relative) time values:

- [CALCulate<n>:DELTamarker<m>:SPECtrogram:FRAMe](#) on page 1294
- [CALCulate<n>:MARKer<m>:SPECtrogram:FRAMe](#) on page 1290
- [CALCulate<n>:SPECtrogram:FRAMe:SElect](#) on page 1250

**Suffix:**

<n> 1..n  
[Window](#)

**Parameters:**

<State> ON | OFF | 0 | 1  
**OFF | 0**  
 Switches the function off  
**ON | 1**  
 Switches the function on

**Example:** //Activates the time stamp  
`CALC:SGR:TST ON`

**Manual operation:** See "[Time Stamp](#)" on page 639

**Configuring the color map**

<a href="#">DISPlay[:WINDow&lt;n&gt;]:SGRam:COLor:DEFault</a> .....	1254
<a href="#">DISPlay[:WINDow&lt;n&gt;]:SPECtrogram:COLor:DEFault</a> .....	1254
<a href="#">DISPlay[:WINDow&lt;n&gt;]:SGRam:COLor:LOWer</a> .....	1254
<a href="#">DISPlay[:WINDow&lt;n&gt;]:SPECtrogram:COLor:LOWer</a> .....	1254
<a href="#">DISPlay[:WINDow&lt;n&gt;]:SGRam:COLor:SHAPE</a> .....	1254
<a href="#">DISPlay[:WINDow&lt;n&gt;]:SPECtrogram:COLor:SHAPE</a> .....	1254
<a href="#">DISPlay[:WINDow&lt;n&gt;]:SGRam:COLor:UPPer</a> .....	1254
<a href="#">DISPlay[:WINDow&lt;n&gt;]:SPECtrogram:COLor:UPPer</a> .....	1254

DISPlay[:WINDow<n>]:SGRam:COLor:STYLe]..... 1255  
 DISPlay[:WINDow<n>]:SPECtrogram:COLor:STYLe]..... 1255

---

**DISPlay[:WINDow<n>]:SGRam:COLor:DEFault**  
**DISPlay[:WINDow<n>]:SPECtrogram:COLor:DEFault**

Restores the original color map.

**Suffix:**

<n> [Window](#)

**Manual operation:** See ["Set to Default"](#) on page 642

---

**DISPlay[:WINDow<n>]:SGRam:COLor:LOWer <Percentage>**  
**DISPlay[:WINDow<n>]:SPECtrogram:COLor:LOWer <Percentage>**

Defines the starting point of the color map.

**Suffix:**

<n> [Window](#)

**Parameters:**

<Percentage> Statistical frequency percentage.  
 Range: 0 to 66  
 \*RST: 0  
 Default unit: %

**Example:** DISP:WIND:SGR:COL:LOW 10  
 Sets the start of the color map to 10%.

**Manual operation:** See ["Start / Stop"](#) on page 641

---

**DISPlay[:WINDow<n>]:SGRam:COLor:SHAPE <Shape>**  
**DISPlay[:WINDow<n>]:SPECtrogram:COLor:SHAPE <Shape>**

Defines the shape and focus of the color curve for the spectrogram result display.

**Suffix:**

<n> [Window](#)

**Parameters:**

<Shape> Shape of the color curve.  
 Range: -1 to 1  
 \*RST: 0

**Manual operation:** See ["Shape"](#) on page 642

---

**DISPlay[:WINDow<n>]:SGRam:COLor:UPPer <Percentage>**  
**DISPlay[:WINDow<n>]:SPECtrogram:COLor:UPPer <Percentage>**

Defines the end point of the color map.

**Suffix:**

<n> [Window](#)

**Parameters:**

<Percentage> Statistical frequency percentage.  
 Range: 0 to 66  
 \*RST: 0  
 Default unit: %

**Example:**

DISP:WIND:SGR:COL:UPP 95  
 Sets the start of the color map to 95%.

**Manual operation:** See "[Start / Stop](#)" on page 641

**DISPlay[:WINDow<n>]:SGRam:COLor[:STYLe] <ColorScheme>**  
**DISPlay[:WINDow<n>]:SPECTrogram:COLor[:STYLe] <ColorScheme>**

Selects the color scheme.

**Parameters:**

<ColorScheme> **HOT**  
 Uses a color range from blue to red. Blue colors indicate low levels, red colors indicate high ones.

**COLD**  
 Uses a color range from red to blue. Red colors indicate low levels, blue colors indicate high ones.

**RADar**  
 Uses a color range from black over green to light turquoise with shades of green in between.

**GRAYscale**  
 Shows the results in shades of gray.  
 \*RST: HOT

**Example:**

DISP:WIND:SPEC:COL GRAY  
 Changes the color scheme of the spectrogram to black and white.

**Manual operation:** See "[Hot/Cold/Radar/Grayscale](#)" on page 642

**13.8.2.3 Using trace mathematics**

The following commands control trace mathematics.

<a href="#">CALCulate&lt;n&gt;:MATH&lt;t&gt;[:EXPRession][:DEFine]</a> .....	1255
<a href="#">CALCulate&lt;n&gt;:MATH&lt;t&gt;:MODE</a> .....	1256
<a href="#">CALCulate&lt;n&gt;:MATH&lt;t&gt;:POSition</a> .....	1257
<a href="#">CALCulate&lt;n&gt;:MATH&lt;t&gt;:STATe</a> .....	1257

**CALCulate<n>:MATH<t>[:EXPRession][:DEFine] <Expression>**

Selects the mathematical expression for trace mathematics.

Before you can use the command, you have to turn trace mathematics on.

**Suffix:**

<n> [Window](#)

<t> irrelevant

**Parameters:**

<Expression> **(TRACE1-TRACE2)**  
Subtracts trace 2 from trace 1.

**(TRACE1-TRACE3)**  
Subtracts trace 3 from trace 1.

**(TRACE1-TRACE4)**  
Subtracts trace 4 from trace 1.

**(TRACE1-TRACE5)**  
Subtracts trace 5 from trace 1.

**(TRACE1-TRACE6)**  
Subtracts trace 6 from trace 1.

**Example:**

```
CALC:MATH:STAT ON
Turns trace mathematics on.
CALC:MATH:EXPR:DEF (TRACE1-TRACE3)
Subtracts trace 3 from trace 1.
```

**Manual operation:** See "[Trace Math Function](#)" on page 647

**CALCulate<n>:MATH<t>:MODE <Mode>**

Selects the way the FSW calculates trace mathematics.

**Suffix:**

<n> [Window](#)

<t> irrelevant

**Parameters:**

<Mode> For more information on the way each mode works see [Trace Math Mode](#).

**LINear**  
Linear calculation.

**LOGarithmic**  
Logarithmic calculation.

**POWER**  
Linear power calculation.

\*RST: LOGarithmic

**Example:**

```
CALC:MATH:MODE LIN
Selects linear calculation.
```

**Manual operation:** See "[Trace Math Mode](#)" on page 648



**CALCulate<n>:MATH<t>:POSition <Position>**

Defines the position of the trace resulting from the mathematical operation.

**Suffix:**

<n> [Window](#)

<t> irrelevant

**Parameters:**

<Position> Vertical position of the trace in % of the height of the diagram area.

100 PCT corresponds to the upper diagram border.

Range: -100 to 200

\*RST: 50

Default unit: PCT

**Example:**

CALC:MATH:POS 100

Moves the trace to the top of the diagram area.

**Manual operation:** See ["Trace Math Position"](#) on page 647

**CALCulate<n>:MATH<t>:STATe <State>**

Turns the trace mathematics on and off.

**Suffix:**

<n> [Window](#)

<t> irrelevant

**Parameters:**

<State> ON | OFF | 0 | 1

**OFF | 0**

Switches the function off

**ON | 1**

Switches the function on

**Example:**

CALC:MATH:STAT ON

Turns on trace mathematics.

**Manual operation:** See ["Trace Math Function"](#) on page 647

See ["Trace Math Off"](#) on page 647

**13.8.2.4 Retrieving trace results**

This chapter describes how to retrieve data from standard traces.

For spectrograms see also [Chapter 13.8.3.6, "Marker search \(spectrograms\)"](#), on page 1289.

For details on the format of the retrieved trace data see also [Chapter 13.8.2.5, "Formats for returned values: ASCII format and binary format"](#), on page 1261.

FORMat[:DATA].....	1258
TRACe<n>[:DATA].....	1258
TRACe<n>[:DATA]:MEMory?.....	1260
TRACe<n>[:DATA]:X?.....	1261

---

### FORMat[:DATA] <Format>[, <BitLength>]

Selects the data format that is used for transmission of trace data from the FSW to the controlling computer.

Note that the command has no effect for data that you send to the FSW. The FSW automatically recognizes the data it receives, regardless of the format.

For details on data formats, see [Chapter 13.8.2.5, "Formats for returned values: ASCII format and binary format"](#), on page 1261.

#### Parameters:

<Format>

#### AScii

AScii format, separated by commas.

This format is almost always suitable, regardless of the actual data format. However, the data is not as compact as other formats can be.

#### REAL

Floating-point numbers (according to IEEE 754) in the "definite length block format".

In the Spectrum application, the format setting `REAL` is used for the binary transmission of trace data.

<BitLength>

Length in bits for floating-point results

#### 16

16-bit floating-point numbers.

Compared to `REAL, 32` format, half as many numbers are returned.

#### 32

32-bit floating-point numbers

For I/Q data, 8 bytes per sample are returned for this format setting.

#### 64

64-bit floating-point numbers

Compared to `REAL, 32` format, twice as many numbers are returned.

#### Example:

```
FORM REAL, 32
```

---

### TRACe<n>[:DATA] <Trace>,<Data>

### TRACe<n>[:DATA]? <ResultType>

This command queries current trace data and measurement results.

In the Spectrum application only, you can use it as a setting command to transfer trace data from an external source to the FSW.

The data format depends on `FORMat [:DATA]` on page 1258.

**Suffix:**

<n> [Window](#)

**Parameters:**

<Trace> **TRACE1 | TRACE2 | TRACE3 | TRACE4 | TRACE5 | TRACE6**  
Selects the trace to write the data to (Spectrum application only).

<Data> Contains the data to transfer (Spectrum application only).

**Query parameters:**

<ResultType> Selects the type of result to be returned. See [Table 13-7](#).  
Note that not all result types are available for all applications.  
See the application-specific documentation for details.

**Example:**

(Spectrum application only):  
`TRAC TRACE1,-30,-20,-10`  
Transfers trace data (-30,-20,-10) to trace 1.

**Example:**

`TRAC? TRACE3`  
Queries the data of trace 3.

**Example:**

See [Chapter 13.16.1, "Programming example: performing a basic frequency sweep"](#), on page 1531.

**Example:**

See [Chapter 13.5.7.11, "Example: SEM measurement"](#), on page 1032.

**Manual operation:** See ["List Evaluation State \(result summary\)"](#) on page 265  
See ["Diagram"](#) on page 535

**Table 13-7: Return values for result type parameters**

Parameter	Result display / measurement	Results
TRACE1   ...   TRACE6		Returns the trace data for the corresponding trace.  The trace data consists of a list of measured power levels. The number of power levels in the list depends on the currently selected number of sweep points. The unit depends on the measurement and on the configured unit.  For the auto peak detector, the command returns positive peak values only. (To retrieve negative peak values, define a second trace with a negative peak detector.)  For SEM or Spurious Emission measurement results, query the x-values as well, as they are not equidistant (see <code>TRACe&lt;n&gt; [:DATA] :X?</code> on page 1261).
LIST	SEM measurements	Peak list evaluation, one peak per range is returned.

## Analyzing measurements (basics)

Parameter	Result display / measurement	Results
	Spurious emission measurements	<p>Peak list evaluation;</p> <p>The number of peaks returned for each measurement range is defined by the "Peaks per Range" parameter (see <a href="#">CALCulate&lt;n&gt;:PEAKsearch:SUBRanges</a> on page 1047), regardless of the "Details" setting.</p> <p>For each peak, the command returns 11 values in the following order:</p> <ul style="list-style-type: none"> <li>• &lt;No&gt;: range number</li> <li>• &lt;StartFreq&gt;,&lt;StopFreq&gt;: start and stop frequency of the range</li> <li>• &lt;RBW&gt;: resolution bandwidth</li> <li>• &lt;PeakFreq&gt;: frequency of the peak in a range</li> <li>• &lt;PowerAbs&gt;: absolute power of the peak in dBm</li> <li>• &lt;PowerRel&gt;: power of the peak in relation to the channel power in dBc</li> <li>• &lt;PowerDelta&gt;: distance from the peak to the limit line in dB, positive values indicate a failed limit check</li> <li>• &lt;LimitCheck&gt;: state of the limit check (0 = PASS, 1 = FAIL)</li> <li>• &lt;Unused1&gt;,&lt;Unused2&gt;: reserved (0.0)</li> </ul>
SPURious	Peak list evaluation of Spurious Emission measurements.	
SPECTrogram   SGRam	For every frame in the spectrogram, the command returns the power levels that have been measured, one for each sweep point. The number of frames depends on the size of the history depth. The power level depends on the configured unit. Only REAL, 32 format is supported.	
PSPpectrum	Real-Time "Persistence Spectrum"	<p>Returns the result of the Clear/Write trace (trace 2).</p> <p>For every sweep point in the "Persistence Spectrum", the command returns the determined probability values.</p>
HMAXhold	Real-Time "Persistence Spectrum"	<p>Returns the result of the Max Hold trace (trace 3).</p> <p>For every sweep point in the "Persistence Spectrum", the command returns the determined probability values.</p>

**TRACe<n>[:DATA]:MEMory? <Trace>,<OffsSwPoint>,<NoOfSwPoints>**

Queries the previously captured trace data for the specified trace from the memory. As an offset and number of sweep points to be retrieved can be specified, the trace data can be retrieved in smaller portions, making the command faster than the `TRAC:DATA?` command. This is useful if only specific parts of the trace data are of interest.

If no parameters are specified with the command, the entire trace data is retrieved; in this case, the command returns the same results as `TRAC:DATA? TRACE1`.

For details on the returned values see the [TRAC:DATA? <TRACE...>](#) command.

**Suffix:**

<n> [Window](#)

**Query parameters:**

<Trace> TRACE1 | TRACE2 | TRACE3 | TRACE4 | TRACE5 | TRACE6

<OffsSwPoint> The offset in sweep points related to the start of the measurement at which data retrieval is to start.

<NoOfSwPoints> Number of sweep points to be retrieved from the trace.

**Return values:**

<SweepPointValues>

**Example:**

```
TRAC:DATA:MEM? TRACE1,25,100
```

Retrieves 100 sweep points from trace 1, starting at sweep point 25.

**Usage:**

Query only

**TRACe<n>[:DATA]:X? <TraceNumber>**

Queries the horizontal trace data for each sweep point in the specified window, for example the frequency in frequency domain or the time in time domain measurements.

For more information, see "[X-value of the sweep point](#)" on page 617.

This is especially useful for traces with non-equidistant x-values, e.g. for SEM or Spurious Emissions measurements.

**Suffix:**

<n> [Window](#)

**Query parameters:**

<TraceNumber> Trace number.

**TRACE1 | TRACE2 | TRACE3 | TRACE4 | TRACE5 | TRACE6**

**Return values:**

<X-Values>

**Example:**

```
TRAC3:X? TRACE1
```

Returns the x-values for trace 1 in window 3.

**Usage:**

Query only

### 13.8.2.5 Formats for returned values: ASCII format and binary format

When trace data is retrieved using the `TRAC:DATA` or `TRAC:IQ:DATA` command, the data is returned in the format defined using the `FORMat[:DATA]` on page 1258. The possible formats are described here.

- ASCII Format (FORMat ASCII):  
The data is stored as a list of comma-separated values (CSV) of the measured values in floating point format.
- Binary Format (FORMat REAL,16/32/64):  
The data is stored as binary data (definite length block data according to IEEE 488.2), each measurement value being formatted in 16-bit/32-bit/64-bit IEEE 754 floating-point-format.  
The schema of the result string is as follows:

#<Length of length><Length of data><value1><value2>...<value n>  
with:

<Length of length>	Number of digits of the following number of data bytes
<Length of data>	Number of following data bytes
<Value>	2-byte/4-byte/8-byte floating point value

**Example:** #41024<Data>... contains 1024 data bytes

**Data blocks larger than 999,999,999 bytes**

According to SCPI, the header of the block data format allows for a maximum of 9 characters to describe the data length. Thus, the maximum REAL 32 data that can be represented is 999,999,999 bytes. However, the FSW is able to send larger data blocks. In this case, the length of the data block is placed in brackets, e.g.  
# (1234567890) <value1><value2>...



Reading out data in binary format is quicker than in ASCII format. Thus, binary format is recommended for large amounts of data.

**13.8.2.6 Importing and exporting traces**

FORMat:DEXPort:CSEPARATOR..... 1262  
 FORMat:DEXPort:FORMat..... 1263  
 FORMat:DEXPort:TRACes..... 1263  
 FORMat:DEXPort:XDISTrib..... 1263  
 FORMat:DIMPort:TRACes..... 1264  
 MMEMory:LOAD<n>:TRACe..... 1264  
 MMEMory:STORE<n>:TRACe..... 1265

**FORMat:DEXPort:CSEPARATOR <Separator>**

Selects the column separator for exported trace data.

The selected value is not affected by a preset. The command therefore has no reset value.

**Parameters:**

<Separator>

**COMMA**

Selects a comma as a separator.

**SEMICOLON**

Selects a semicolon as a separator.

**TAB**

Selects a tabulator as a separator.

\*RST: n/a

**Example:**

```
//Select column separator
FORM:DEXP:CSEP TAB
```

**Manual operation:** See ["Column Separator"](#) on page 654

---

#### **FORMat:DEXPort:FORMat** <FileFormat>

Determines the format of the ASCII file to be imported or exported. Depending on the external program that creates the data file or evaluates it, a comma-separated list (CSV) or a plain data format (DAT) file is required.

**Parameters:**

<FileFormat>            CSV | DAT  
                              \*RST:        DAT

**Example:**                FORM:DEXP:FORM CSV

**Manual operation:** See ["File Type"](#) on page 654

---

#### **FORMat:DEXPort:TRACes** <Selection>

Selects the data to be included in a data export file (see [MMEMory:STORe<n>:TRACe](#) on page 1265).

For details on exporting data see [Chapter 8.6.2, "Trace/data ex/import"](#), on page 650.

**Parameters:**

<Selection>                SINGle | ALL

**SINGle**

Only a single trace is selected for export, namely the one specified by the [MMEMory:STORe<n>:TRACe](#) command.

**ALL**

Selects all active traces and result tables (e.g. "Result Summary", marker peak list etc.) in the current application for export to an ASCII file.

The <trace> parameter for the [MMEMory:STORe<n>:TRACe](#) command is ignored.

\*RST:                    SINGle

**Manual operation:** See ["Export all Traces and all Table Results"](#) on page 651

---

#### **FORMat:DEXPort:XDIStrib** <XDistribution>

Defines how the x-values of the trace are determined in the frequency domain.

See ["X-value of the sweep point"](#) on page 617.

**Parameters:**

<XDistribution>            STARTstop | BINCentered

**BINCentered**

The full measurement span is divided by the number of sweep points to obtain *bins*. The x-value of the sweep point is defined as the x-value at the center of the bin (bin/2).

**STARTstop**

(Default): The x-value of the first sweep point corresponds to the starting point of the full measurement span. The x-value of the last sweep point corresponds to the end point of the full measurement span. All other sweep points are divided evenly between the first and last points.

**Example:** FORM:DEXP:XDIS BIN

**Manual operation:** See "[X-Value Distribution](#)" on page 652

**FORMat:DIMPort:TRACes** <Selection>

Selects the data to be included in a data import file (see [MMEMory:LOAD<n>:TRACe](#) on page 1264).

For details on importing data see [Chapter 8.6.3, "How to import traces"](#), on page 655.

**Parameters:**

<Selection> SINGle | ALL

**SINGle**

Only a single trace is selected for import, namely the one specified by the [MMEMory:LOAD<n>:TRACe](#) on page 1264 command.

**ALL**

Imports several traces at once, overwriting the existing trace data for any active trace in the result display with the same trace number. Data from the import file for currently not active traces is not imported.

The <trace> parameter for the [MMEMory:LOAD<n>:TRACe](#) on page 1264 command is ignored.

\*RST: SINGle

**Manual operation:** See "[Import All Traces/Import to Trace](#)" on page 654

See "[Import ASCII File to Trace](#)" on page 655

**MMEMory:LOAD<n>:TRACe** <Trace>, <FileName>

Imports trace data from the specified window to an ASCII file.

**Suffix:**

<n> [Window](#)

**Parameters:**

<Trace> Number of the trace to be stored  
(This parameter is ignored for [FORMat:DIMPort:TRACesALL](#)).

<FileName> String containing the path and name of the import file.



**MMEMory:STORe<n>:TRACe** <Trace>, <FileName>

Exports trace data from the specified window to an ASCII file.

For details on the file format, see [Chapter 8.6.6, "Reference: ASCII file export format"](#), on page 657.

**Secure User Mode**

In secure user mode, settings that are stored on the instrument are stored to volatile memory, which is restricted to 256 MB. Thus, a "memory limit reached" error can occur although the hard disk indicates that storage space is still available.

To store data permanently, select an external storage location such as a USB memory device.

For details, see [Chapter 4.2.15, "Protecting data using the secure user mode"](#), on page 39.

**Suffix:**

<n> [Window](#)

**Parameters:**

<Trace> Number of the trace to be stored  
(This parameter is ignored if the option "Export all Traces and all Table Results" is activated in the Export configuration settings, see [FORMat:DEXPort:TRACes](#) on page 1263).

<FileName> String containing the path and name of the target file.

**Example:** `MMEM:STOR1:TRAC 1, 'C:\TEST.ASC'`  
Stores trace 1 from window 1 in the file `TEST.ASC`.

**Manual operation:** See ["Export Trace to ASCII File"](#) on page 652

**13.8.2.7 Programming example: configuring a spectrogram**

This example demonstrates how to configure a spectrogram for a basic frequency sweep in a remote environment. The spectrogram is displayed in addition to the spectrum display, in a new window. In addition, the usage of special spectrogram markers is demonstrated (see [Chapter 13.8.3.6, "Marker search \(spectrograms\)"](#), on page 1289).



Basic trace settings are demonstrated in the [Chapter 13.16.1, "Programming example: performing a basic frequency sweep"](#), on page 1531.

```
//-----Preparing the Measurement -----
*RST
//Resets the instrument
LAY:ADD? '1',BEL,SGR
//Displays a new window below window 1 and activates spectrogram display.
//The new window name is returned as a result: '2'.
//The spectrogram is updated with each new sweep.
INIT:CONT OFF
//Selects single sweep mode.
```

## Analyzing measurements (basics)

```

//-----Configuring the Spectrogram-----
CALC:SGR:CLE
//Clears the displayed spectrogram to start a new one.
CALC:SGR:CONT ON
//Configures a continuous spectrogram for a series of measurements.
//The display is not cleared when a new measurement is started.
CALC:SGR:FRAM:COUN 100
//Sets the number of frames to be recorded per sweep to 100.
CALC:SGR:HDEP 1000
//Sets the number of frames to be stored to 1000 (=10 sweeps)
CALC:SGR:TST ON
//Activates a time stamp for each frame.

//-----Configuring the Color Map-----
DISP:WIND:SGR:COL GRAY
//Defines a gray-scaled coloring: low values light gray, high values dark gray.
DISP:WIND:SGR:COL:LOW 30
DISP:WIND:SGR:COL:UPP 70
DISP:WIND:SGR:COL:SHAP 0.8
//Defines a color map for a range that comprises 40% of the measurement range,
//excluding 30% at each end. The colors are not scaled linearly; the light gray
//colors are stretched to distinguish low values better.

//-----Performing the Measurement-----
SWE:COUN 10
//Defines 10 sweeps to be performed per measurement.
INIT;*WAI
//Initiates a new measurement and waits until the sweeps have finished.
//The spectrogram is updated with each new sweep.

//-----Positioning Markers-----
CALC:MARK:SGR:SAR MEM
//Includes all frames in the memory in the search area

CALC:MARK1:SGR:FRAM -1s
//Sets marker 1 to the frame 1 second after measurement begin. (Note the
//negative value!
CALC:MARK1:MIN
//Sets marker 1 to the minimum level in this frame.
CALC:MARK1:SGR:Y:MIN
//Sets marker 1 to the minimum level for the same frequency the marker is
//currently positioned at in all frames.

CALC:MARK2:SGR:XY:MAX
//Sets marker 2 to the maximum level in the entire spectrogram.

CALC:DELT1:SGR:FRAM 3s
//Sets the deltamarker 1 to the frame captured 3 seconds after marker 1. By default

```

## Analyzing measurements (basics)

```

//it is set to the peak of that frame and displays the level difference to marker 1.
//Note the positive value!
CALC:DELT1:MIN
//Sets deltamarker 1 to the minimum level in this frame.

CALC:DELT3:SGR:XY:MAX
//Sets deltamarker 3 to the maximum level in the entire spectrogram. By default
//its value is the difference to marker 1. We will change it to refer to marker 2.
CALC:DELT3:MREF 2
//Deltamarker 3 now refers to marker 2, both are positioned on the maximum of the
//spectrogram. Thus, D3=0. We will move deltamarker 3 to the next peak level
//for the same frequency.
CALC:DELT3:SGR:Y:MAX:NEXT

//-----Retrieving Results-----
CALC:MARK1:X?
CALC:MARK1:Y?
CALC:MARK1:SGR:FRAM?
//Queries the frequency (x), level (y) and frame values of marker 1.

CALC:MARK2:X?
CALC:MARK2:Y?
CALC:MARK2:SGR:FRAM?
//Queries the frequency (x), level (y) and frame values of marker 2.

CALC:DELT1:X?
CALC:DELT1:Y?
CALC:DELT1:SGR:FRAM?
//Queries the frequency (x), level (y) and frame values of deltamarker 1.

CALC:DELT3:X?
CALC:DELT3:Y?
CALC:DELT3:SGR:FRAM?
//Queries the frequency (x), level (y) and frame values of deltamarker 3.

CALC:SGR:TST:DATA? ALL
//Queries the time stamps of all stored frames.
CALC:SGR:FRAM:SEL -1
//Selects the frame that was captured 1 second after measurement start (Note the
//negative value!). This frame is displayed in the Spectrum window.
TRAC:DATA? SGR
//Retrieves the trace data for the spectrogram. For each frame, the power level
//and frequency at each sweep point are returned.
TRAC:DATA? TRACE1
//Retrieves the trace data for the selected frame only.

```

### 13.8.3 Working with markers

The commands required to work with markers and marker functions in a remote environment are described here. The tasks for manual operation are described in [Chapter 8.3, "Marker usage"](#), on page 548.



In the Spectrum application, markers are identical in all windows. Thus, the suffix <n> for the window is generally irrelevant.

• <a href="#">Setting up individual markers</a> .....	1268
• <a href="#">General marker settings</a> .....	1275
• <a href="#">Configuring and performing a marker search</a> .....	1277
• <a href="#">Positioning the marker</a> .....	1281
• <a href="#">Retrieving marker results</a> .....	1287
• <a href="#">Marker search (spectrograms)</a> .....	1289
• <a href="#">Fixed reference marker settings</a> .....	1298
• <a href="#">Marker peak lists</a> .....	1300
• <a href="#">Noise measurement marker</a> .....	1303
• <a href="#">Phase noise measurement marker</a> .....	1305
• <a href="#">Band power marker</a> .....	1307
• <a href="#">N db down marker</a> .....	1311
• <a href="#">Signal count marker</a> .....	1315
• <a href="#">Marker demodulation</a> .....	1316
• <a href="#">Programming examples for using markers and marker functions</a> .....	1319

#### 13.8.3.1 Setting up individual markers

The following commands define the position of markers in the diagram.

<a href="#">CALCulate&lt;n&gt;:DELTamarker&lt;m&gt;:AOFF</a> .....	1268
<a href="#">CALCulate&lt;n&gt;:DELTamarker&lt;m&gt;:LINK</a> .....	1269
<a href="#">CALCulate&lt;n&gt;:DELTamarker&lt;ms&gt;:LINK:TO:DELTa&lt;md&gt;</a> .....	1269
<a href="#">CALCulate&lt;n&gt;:DELTamarker&lt;ms&gt;:LINK:TO:MARKer&lt;md&gt;</a> .....	1270
<a href="#">CALCulate&lt;n&gt;:DELTamarker&lt;m&gt;:MODE</a> .....	1271
<a href="#">CALCulate&lt;n&gt;:DELTamarker&lt;m&gt;:MREFerence</a> .....	1271
<a href="#">CALCulate&lt;n&gt;:DELTamarker&lt;m&gt;[:STATe]</a> .....	1271
<a href="#">CALCulate&lt;n&gt;:DELTamarker&lt;m&gt;:TRACe</a> .....	1272
<a href="#">CALCulate&lt;n&gt;:DELTamarker&lt;m&gt;:X</a> .....	1272
<a href="#">CALCulate&lt;n&gt;:MARKer&lt;m&gt;:AOFF</a> .....	1273
<a href="#">CALCulate&lt;n&gt;:MARKer&lt;ms&gt;:LINK:TO:DELTa&lt;md&gt;</a> .....	1273
<a href="#">CALCulate&lt;n&gt;:MARKer&lt;ms&gt;:LINK:TO:MARKer&lt;md&gt;</a> .....	1273
<a href="#">CALCulate&lt;n&gt;:MARKer&lt;m&gt;[:STATe]</a> .....	1274
<a href="#">CALCulate&lt;n&gt;:MARKer&lt;m&gt;:TRACe</a> .....	1274
<a href="#">CALCulate&lt;n&gt;:MARKer&lt;m&gt;:X</a> .....	1275

---

#### **CALCulate<n>:DELTamarker<m>:AOFF**

Turns off *all* delta markers.

**Suffix:**

<n> [Window](#)

<m> irrelevant

**Example:**

```
CALC:DELT:AOFF
```

Turns off all delta markers.

**CALCulate<n>:DELTamarker<m>:LINK <State>**

Links delta marker <m> to marker 1.

If you change the horizontal position (x-value) of marker 1, delta marker <m> changes its horizontal position to the same value.

**Tip:** to link any marker to a different marker than marker 1, use the [CALCulate<n>:DELTamarker<ms>:LINK:TO:MARKer<md>](#) or [CALCulate<n>:MARKer<ms>:LINK:TO:MARKer<md>](#) commands.

**Suffix:**

<n> [Window](#)

<m> [Marker](#)

**Parameters:**

<State> ON | OFF | 0 | 1

**OFF | 0**

Switches the function off

**ON | 1**

Switches the function on

**Example:**

```
CALC:DELT2:LINK ON
```

**Manual operation:**

See "[Linking to Another Marker](#)" on page 343

See "[Linking to Another Marker](#)" on page 554

**CALCulate<n>:DELTamarker<ms>:LINK:TO:DELTa<md> <State>**

Links the delta source marker <ms> to any active destination delta marker <md>.

If you change the horizontal position of marker <md>, marker <ms> changes its horizontal position to the same value.

**Suffix:**

<n> [Window](#)

<ms> source marker, see [Marker](#)

<md> destination marker, see [Marker](#)

**Parameters:**

<State> ON | OFF | 0 | 1

**OFF | 0**

Switches the function off

**ON | 1**

Switches the function on

**Example:**

```
CALC:DELT2:LINK:TO:DELT3 ON
```

Links D2 and D3.

**CALCulate<n>:DELTamarker<ms>:LINK:TO:MARKer<md> <State>**

Links the delta source marker <ms> to any active destination marker <md> (normal or delta marker).

In Spectrum mode only:

- If <md> is a delta marker, it is turned into a normal marker. To maintain the delta marker, use [CALCulate<n>:DELTamarker<ms>:LINK:TO:DELTA<md>](#) on page 1269.
- If <md> is the reference marker for the delta marker <ms>, the delta marker is initially set to the same horizontal position as the normal marker. To change the relative distance (delta) value again, use [CALCulate<n>:DELTamarker<m>:X](#) on page 1272. Then the delta between the two markers is maintained when you move the normal marker.

In I/Q Analyzer mode, if <md> is the reference marker for the delta marker <ms>, the relative distance (delta) between the two markers is maintained when you move the normal marker.

In other applications, the delta marker is set to the same horizontal position as the marker <md>, and if <md> is moved along the x-axis, <ms> follows to the same horizontal position.

**Suffix:**

<n> [Window](#)

<ms> source marker, see [Marker](#)

<md> destination marker, see [Marker](#)

**Parameters:**

<State> ON | OFF | 0 | 1

**OFF | 0**  
Switches the function off

**ON | 1**  
Switches the function on

**Example:**

```
CALC:DELT4:LINK:TO:MARK2 ON
```

Links the delta marker 4 to the marker 2.

**Example:**

D2 and D3 are active.

```
CALC:DELT2:LINK:TO:MARK3 ON
```

Converts D3 into M3 and links D2 and M3

**Manual operation:**

See ["Linking to Another Marker"](#) on page 343

See ["Linking to Another Marker"](#) on page 554

**CALCulate<n>:DELTamarker<m>:MODE <Mode>**

Defines whether the position of a delta marker is provided as an absolute value or relative to a reference marker. Note that this setting applies to *all* windows.

Note that when the position of a delta marker is *queried*, the result is always an absolute value (see [CALCulate<n>:DELTamarker<m>:X](#) on page 1272)!

**Suffix:**

<n> irrelevant

<m> irrelevant

**Parameters:**

<Mode>

**ABSolute**

Delta marker position in absolute terms.

**RELative**

Delta marker position in relation to a reference marker.

\*RST: RELative

**Example:**

CALC:DELT:MODE ABS

Absolute delta marker position.

**CALCulate<n>:DELTamarker<m>:MREFerence <Reference>**

Selects a reference marker for a delta marker other than marker 1.

The reference may be another marker or the fixed reference.

**Suffix:**

<n> [Window](#)

<m> [Marker](#)

**Parameters:**

<Reference>

**FIXed**

Selects the fixed reference as the reference.

**Example:**

CALC:DELT3:MREF 2

Specifies that the values of delta marker 3 are relative to marker 2.

**Manual operation:** See "[Reference Marker](#)" on page 343

**CALCulate<n>:DELTamarker<m>[:STATe] <State>**

Turns delta markers on and off.

If necessary, the command activates the delta marker first.

No suffix at DELTmarker turns on delta marker 1.

**Suffix:**

<n> [Window](#)

<m>	Marker
<b>Parameters:</b>	
<State>	ON   OFF   0   1 <b>OFF   0</b> Switches the function off <b>ON   1</b> Switches the function on
<b>Example:</b>	CALC:DELT2 ON Turns on delta marker 2.
<b>Manual operation:</b>	See "Marker State" on page 342 See "Marker Type" on page 343 See "Select Marker" on page 345

### CALCulate<n>:DELTaMarker<m>:TRACe <Trace>

Selects the trace a delta marker is positioned on.

Note that the corresponding trace must have a trace mode other than "Blank".

If necessary, the command activates the marker first.

#### Suffix:

<n> Window

<m> Marker

#### Parameters:

<Trace> Trace number the marker is assigned to.

#### Example:

CALC:DELT2:TRAC 2  
Positions delta marker 2 on trace 2.

### CALCulate<n>:DELTaMarker<m>:X <Position>

Moves a delta marker to a particular coordinate on the x-axis.

If necessary, the command activates the delta marker and positions a reference marker to the peak power.

#### Suffix:

<n> Window

<m> Marker

#### Parameters:

<Position> Numeric value that defines the marker position on the x-axis. The position is relative to the reference marker. To select an absolute position you have to change the delta marker mode with `CALCulate<n>:DELTaMarker<m>:MODE` on page 1271. A query returns the absolute position of the delta marker.



Range: The value range and unit depend on the measurement and scale of the x-axis.

Default unit: HZ

**Example:** `CALC:DELT:X?`  
Outputs the absolute x-value of delta marker 1.

**Manual operation:** See "[Marker 1/Marker 2/Marker 3/Marker 4](#)" on page 326  
See "[Marker 1/Marker 2/Marker 3](#)" on page 331  
See "[Marker Position X-value](#)" on page 342

#### **CALCulate<n>:MARKer<m>:AOFF**

Turns off all markers.

**Suffix:**  
<n> [Window](#)

<m> [Marker](#)

**Example:** `CALC:MARK:AOFF`  
Switches off all markers.

**Manual operation:** See "[All Markers Off](#)" on page 555

#### **CALCulate<n>:MARKer<ms>:LINK:TO:DELTA<md> <State>**

Links the normal source marker <ms> to any active delta destination marker <md>.

If you change the horizontal position of marker <md>, marker <ms> changes its horizontal position to the same value.

**Suffix:**  
<n> [Window](#)  
<ms> source marker, see [Marker](#)  
<md> destination marker, see [Marker](#)

**Parameters:**  
<State> `ON | OFF | 0 | 1`  
**OFF | 0**  
Switches the function off  
**ON | 1**  
Switches the function on

**Example:** `CALC:MARK4:LINK:TO:DELTA2 ON`  
Links marker 4 to delta marker 2.

#### **CALCulate<n>:MARKer<ms>:LINK:TO:MARKer<md> <State>**

Links the normal source marker <ms> to any active destination marker <md> (normal or delta marker).

If you change the horizontal position of marker <md>, marker <ms> changes its horizontal position to the same value.

**Suffix:**

<n>	<a href="#">Window</a>
<ms>	source marker, see <a href="#">Marker</a>
<md>	destination marker, see <a href="#">Marker</a>

**Parameters:**

<State>	ON   OFF   0   1
	<b>OFF   0</b>
	Switches the function off
	<b>ON   1</b>
	Switches the function on

**Example:**

`CALC:MARK4:LINK:TO:MARK2 ON`  
Links marker 4 to marker 2.

**Manual operation:** See "[Linking to Another Marker](#)" on page 343  
See "[Linking to Another Marker](#)" on page 554

**CALCulate<n>:MARKer<m>[:STATE] <State>**

Turns markers on and off. If the corresponding marker number is currently active as a delta marker, it is turned into a normal marker.

**Suffix:**

<n>	<a href="#">Window</a>
<m>	<a href="#">Marker</a>

**Parameters:**

<State>	ON   OFF   0   1
	<b>OFF   0</b>
	Switches the function off
	<b>ON   1</b>
	Switches the function on

**Example:**

`CALC:MARK3 ON`  
Switches on marker 3.

**Manual operation:** See "[Marker State](#)" on page 342  
See "[Marker Type](#)" on page 343  
See "[Select Marker](#)" on page 345

**CALCulate<n>:MARKer<m>:TRACe <Trace>**

Selects the trace the marker is positioned on.

Note that the corresponding trace must have a trace mode other than "Blank".

If necessary, the command activates the marker first.

**Suffix:**<n> [Window](#)<m> [Marker](#)**Parameters:**<Trace> **1 to 6**  
Trace number the marker is assigned to.**Example:** //Assign marker to trace 1  
CALC:MARK3:TRAC 2**Manual operation:** See ["Assigning the Marker to a Trace"](#) on page 344**CALCulate<n>:MARKer<m>:X <Position>**

Moves a marker to a specific coordinate on the x-axis.

If necessary, the command activates the marker.

If the marker has been used as a delta marker, the command turns it into a normal marker.

**Suffix:**<n> [Window](#)<m> [Marker](#)**Parameters:**<Position> Numeric value that defines the marker position on the x-axis.  
The unit depends on the result display.  
Range: The range depends on the current x-axis range.  
Default unit: Hz**Example:** CALC:MARK2:X 1.7MHz  
Positions marker 2 to frequency 1.7 MHz.**Manual operation:** See ["Marker 1/Marker 2/Marker 3/Marker 4"](#) on page 326  
See ["Marker 1/Marker 2/Marker 3"](#) on page 331  
See ["Marker Position X-value"](#) on page 342  
See ["Marker Table"](#) on page 535  
See ["Marker Peak List"](#) on page 536**13.8.3.2 General marker settings**

The following commands control general marker functionality.

**Remote commands exclusive to general marker functionality**

<a href="#">DISPlay[:WINDow&lt;n&gt;]:MTABLE</a> .....	1276
<a href="#">DISPlay[:WINDow&lt;n&gt;]:MINFo[:STATE]</a> .....	1276
<a href="#">CALCulate&lt;n&gt;:MARKer&lt;m&gt;:X:SSIZE</a> .....	1276

---

**DISPlay[:WINDow<n>]:MTABle** <DisplayMode>

Turns the marker table on and off.

**Suffix:**

<n> irrelevant

**Parameters:**

<DisplayMode>

**ON | 1**

Turns on the marker table.

**OFF | 0**

Turns off the marker table.

**AUTO**

Turns on the marker table if 3 or more markers are active.

\*RST: AUTO

**Example:**

```
DISP:MTAB ON
```

Activates the marker table.

**Manual operation:** See "[Marker Table Display](#)" on page 555

---

**DISPlay[:WINDow<n>]:MINFo[:STATe]** <State>

Turns the marker information in all diagrams on and off.

**Suffix:**

<n> irrelevant

**Parameters:**

<State>

**ON | 1**

Displays the marker information in the diagrams.

**OFF | 0**

Hides the marker information in the diagrams.

\*RST: 1

**Example:**

```
DISP:MINF OFF
```

Hides the marker information.

**Manual operation:** See "[Marker Info](#)" on page 556

---

**CALCulate<n>:MARKer<m>:X:SSIZe** <StepSize>

Selects the marker step size mode for *all* markers in *all* windows.

The step size defines the distance the marker moves when you move it with the rotary knob.

It therefore takes effect in manual operation only.

**Suffix:**

<n> irrelevant

<m> irrelevant

**Parameters:**

<StepSize>

**STANdard**

the marker moves from one pixel to the next

**POINts**

the marker moves from one sweep point to the next

\*RST: POINts

**Example:**

CALC:MARK:X:SSIZ STAN

Sets the marker step size to one pixel.

**Manual operation:** See "[Marker Stepsize](#)" on page 556

### 13.8.3.3 Configuring and performing a marker search

The following commands control the marker search.

CALCulate<n>:MARKer<m>:LOEXclude.....	1277
CALCulate<n>:MARKer<m>:PEXCursion.....	1277
CALCulate<n>:MARKer<m>:X:SLIMits[:STATe].....	1278
CALCulate<n>:MARKer<m>:X:SLIMits:LEFT.....	1278
CALCulate<n>:MARKer<m>:X:SLIMits:RIGHT.....	1279
CALCulate<n>:MARKer<m>:X:SLIMits:ZOOM[:STATe].....	1280
CALCulate<n>:THReshold.....	1280
CALCulate<n>:THReshold:STATe.....	1280

---

#### CALCulate<n>:MARKer<m>:LOEXclude <State>

Turns the suppression of the local oscillator during automatic marker positioning on and off (for *all* markers in *all* windows).

**Suffix:**

<n> irrelevant

<m> irrelevant

**Parameters:**

<State> ON | OFF | 0 | 1

\*RST: 1

**Example:**

CALC:MARK:LOEX ON

**Manual operation:** See "[Exclude LO](#)" on page 558

---

#### CALCulate<n>:MARKer<m>:PEXCursion <Excursion>

Defines the peak excursion (for *all* markers in *all* windows).

The peak excursion sets the requirements for a peak to be detected during a peak search.

The unit depends on the measurement.

Application/Result display	Unit
Spectrum	dB

**Suffix:**

<n> irrelevant

<m> irrelevant

**Parameters:**

<Excursion> The excursion is the distance to a trace maximum that must be attained before a new maximum is recognized, or the distance to a trace minimum that must be attained before a new minimum is recognized

\*RST: 6 dB in the Spectrum application and RF displays  
Default unit: DB

**Example:**

CALC:MARK:PEXC 10dB  
Defines peak excursion as 10 dB.

**Manual operation:** See "[Peak Excursion](#)" on page 559

**CALCulate<n>:MARKer<m>:X:SLIMits[:STATE] <State>**

Turns marker search limits on and off for *all* markers in *all* windows.

If you perform a measurement in the time domain, this command limits the range of the trace to be analyzed.

**Suffix:**

<n> irrelevant

<m> irrelevant

**Parameters:**

<State> ON | OFF | 0 | 1

**OFF | 0**

Switches the function off

**ON | 1**

Switches the function on

**Example:**

CALC:MARK:X:SLIM ON  
Switches on search limitation.

**Manual operation:** See "[Search Limits \(Left / Right\)](#)" on page 214  
See "[Search Limits Off](#)" on page 214  
See "[Limit State](#)" on page 311  
See "[Search Limits \(Left / Right\)](#)" on page 559  
See "[Search Limits Off](#)" on page 560

**CALCulate<n>:MARKer<m>:X:SLIMits:LEFT <SearchLimit>**

Defines the left limit of the marker search range for *all* markers in *all* windows.

If you perform a measurement in the time domain, this command limits the range of the trace to be analyzed.

**Suffix:**

<n> irrelevant

<m> irrelevant

**Parameters:**

<SearchLimit> The value range depends on the frequency range or sweep time.

The unit is Hz for frequency domain measurements and s for time domain measurements.

\*RST: left diagram border

Default unit: HZ

**Example:**

```
CALC:MARK:X:SLIM ON
```

Switches the search limit function on.

```
CALC:MARK:X:SLIM:LEFT 10MHz
```

Sets the left limit of the search range to 10 MHz.

**Manual operation:** See ["Search Limits \(Left / Right\)"](#) on page 214  
 See ["Left Limit / Right Limit"](#) on page 311  
 See ["Search Limits \(Left / Right\)"](#) on page 559

**CALCulate<n>:MARKer<m>:X:SLIMits:RIGHT <SearchLimit>**

Defines the right limit of the marker search range for *all* markers in *all* windows.

If you perform a measurement in the time domain, this command limits the range of the trace to be analyzed.

**Suffix:**

<n> irrelevant

<m> irrelevant

**Parameters:**

<Limit> The value range depends on the frequency range or sweep time.

The unit is Hz for frequency domain measurements and s for time domain measurements.

\*RST: right diagram border

Default unit: HZ

**Example:**

```
CALC:MARK:X:SLIM ON
```

Switches the search limit function on.

```
CALC:MARK:X:SLIM:RIGH 20MHz
```

Sets the right limit of the search range to 20 MHz.

**Manual operation:** See ["Search Limits \(Left / Right\)"](#) on page 214  
 See ["Left Limit / Right Limit"](#) on page 311  
 See ["Search Limits \(Left / Right\)"](#) on page 559

**CALCulate<n>:MARKer<m>:X:SLIMits:ZOOM[:STATe] <State>**

Adjusts the marker search range to the zoom area for *all* markers in *all* windows.

**Suffix:**

<n> irrelevant  
<m> irrelevant

**Parameters:**

<State> ON | OFF | 0 | 1  
**OFF | 0**  
Switches the function off  
**ON | 1**  
Switches the function on

**Example:**

CALC:MARK:X:SLIM:ZOOM ON  
Switches the search limit function on.  
CALC:MARK:X:SLIM:RIGH 20MHz  
Sets the right limit of the search range to 20 MHz.

**Manual operation:** See "[Use Zoom Limits](#)" on page 560

**CALCulate<n>:THReshold <Level>**

Defines a threshold level for the marker peak search (for *all* markers in *all* windows).

Note that you must enable the use of the threshold using [CALCulate<n>:THReshold:STATe](#) on page 1280.

**Suffix:**

<n> irrelevant

**Parameters:**

<Level> Numeric value. The value range and unit are variable.  
\*RST: -120 dBm  
Default unit: DBM

**Example:**

CALC:THR:STAT ON

**Example:**

CALC:THR -82DBM  
Enables the search threshold and sets the threshold value to -82 dBm.

**Manual operation:** See "[Search Threshold](#)" on page 559

**CALCulate<n>:THReshold:STATe <State>**

Turns a threshold for the marker peak search on and off (for *all* markers in *all* windows).



<b>Suffix:</b>	
<n>	irrelevant
<b>Parameters:</b>	
<State>	ON   OFF   0   1
	<b>OFF   0</b>
	Switches the function off
	<b>ON   1</b>
	Switches the function on
<b>Example:</b>	CALC:THR:STAT ON
	Switches on the threshold line.
<b>Manual operation:</b>	See "Search Limits Off" on page 214
	See "Search Threshold" on page 559
	See "Search Limits Off" on page 560

### 13.8.3.4 Positioning the marker

This chapter contains remote commands necessary to position the marker on a trace.

- [Positioning normal markers](#).....1281
- [Positioning delta markers](#).....1284

#### Positioning normal markers

The following commands position markers on the trace.

CALCulate<n>:MARKer<m>:MAXimum:AUTO.....	1281
CALCulate<n>:MARKer<m>:MAXimum:LEFT.....	1282
CALCulate<n>:MARKer<m>:MAXimum:NEXT.....	1282
CALCulate<n>:MARKer<m>:MAXimum[:PEAK].....	1282
CALCulate<n>:MARKer<m>:MAXimum:RIGHT.....	1283
CALCulate<n>:MARKer<m>:MINimum:AUTO.....	1283
CALCulate<n>:MARKer<m>:MINimum:LEFT.....	1283
CALCulate<n>:MARKer<m>:MINimum:NEXT.....	1284
CALCulate<n>:MARKer<m>:MINimum[:PEAK].....	1284
CALCulate<n>:MARKer<m>:MINimum:RIGHT.....	1284

---

#### CALCulate<n>:MARKer<m>:MAXimum:AUTO <State>

Turns an automatic marker peak search for a trace maximum on and off (using marker 1). The FSW performs the peak search after each sweep.

<b>Suffix:</b>	
<n>	<a href="#">Window</a>
<m>	irrelevant
<b>Parameters:</b>	
<State>	ON   OFF   0   1
	<b>OFF   0</b>
	Switches the function off

**ON | 1**

Switches the function on

**Example:**

`CALC:MARK:MAX:AUTO ON`

Activates the automatic peak search function for marker 1 at the end of each particular sweep.

**Manual operation:** See ["Auto Max Peak Search / Auto Min Peak Search"](#) on page 559

**CALCulate<n>:MARKer<m>:MAXimum:LEFT**

Moves a marker to the next positive peak.

The search includes only measurement values to the left of the current marker position.

In the spectrogram, the command moves a marker horizontally to the maximum level in the currently selected frame. The vertical marker position remains the same.

**Suffix:**

<n> [Window](#)

<m> [Marker](#)

**Manual operation:** See ["Search Next Peak"](#) on page 564

**CALCulate<n>:MARKer<m>:MAXimum:NEXT**

Moves a marker to the next positive peak.

In the spectrogram, the command moves a marker horizontally to the maximum level in the currently selected frame. The vertical marker position remains the same.

**Suffix:**

<n> [Window](#)

<m> [Marker](#)

**Manual operation:** See ["Search Next Peak"](#) on page 564

**CALCulate<n>:MARKer<m>:MAXimum[:PEAK]**

Moves a marker to the highest level.

In the spectrogram, the command moves a marker horizontally to the maximum level in the currently selected frame. The vertical marker position remains the same.

If the marker is not yet active, the command first activates the marker.

**Suffix:**

<n> [Window](#)

<m> [Marker](#)

**Manual operation:** See ["Peak Search"](#) on page 564

**CALCulate<n>:MARKer<m>:MAXimum:RIGHT**

Moves a marker to the next positive peak.

The search includes only measurement values to the right of the current marker position.

In the spectrogram, the command moves a marker horizontally to the maximum level in the currently selected frame. The vertical marker position remains the same.

**Suffix:**

<n> [Window](#)

<m> [Marker](#)

**Manual operation:** See ["Search Next Peak"](#) on page 564

**CALCulate<n>:MARKer<m>:MINimum:AUTO <State>**

Turns an automatic marker peak search for a trace minimum on and off (using marker 1). The FSW performs the peak search after each sweep.

**Suffix:**

<n> [Window](#)

<m> irrelevant

**Parameters:**

<State> ON | OFF | 0 | 1

**OFF | 0**

Switches the function off

**ON | 1**

Switches the function on

**Example:**

`CALC:MARK:MIN:AUTO ON`

Activates the automatic minimum value search function for marker 1 at the end of each particular sweep.

**Manual operation:** See ["Auto Max Peak Search / Auto Min Peak Search"](#) on page 559

**CALCulate<n>:MARKer<m>:MINimum:LEFT**

Moves a marker to the next minimum peak value.

The search includes only measurement values to the right of the current marker position.

In the spectrogram, the command moves a marker horizontally to the minimum level in the currently selected frame. The vertical marker position remains the same.

**Suffix:**

<n> [Window](#)

<m> [Marker](#)

**Manual operation:** See ["Search Next Minimum"](#) on page 564

#### **CALCulate<n>:MARKer<m>:MINimum:NEXT**

Moves a marker to the next minimum peak value.

In the spectrogram, the command moves a marker horizontally to the minimum level in the currently selected frame. The vertical marker position remains the same.

**Suffix:**

<n> [Window](#)

<m> [Marker](#)

**Manual operation:** See ["Search Next Minimum"](#) on page 564

#### **CALCulate<n>:MARKer<m>:MINimum[:PEAK]**

Moves a marker to the minimum level.

In the spectrogram, the command moves a marker horizontally to the minimum level in the currently selected frame. The vertical marker position remains the same.

If the marker is not yet active, the command first activates the marker.

**Suffix:**

<n> [Window](#)

<m> [Marker](#)

**Manual operation:** See ["Search Minimum"](#) on page 564

#### **CALCulate<n>:MARKer<m>:MINimum:RIGHT**

Moves a marker to the next minimum peak value.

The search includes only measurement values to the right of the current marker position.

In the spectrogram, the command moves a marker horizontally to the minimum level in the currently selected frame. The vertical marker position remains the same.

**Suffix:**

<n> [Window](#)

<m> [Marker](#)

**Manual operation:** See ["Search Next Minimum"](#) on page 564

#### **Positioning delta markers**

The following commands position delta markers on the trace.

<a href="#">CALCulate&lt;n&gt;:DELTamarker&lt;m&gt;:MAXimum:LEFT</a> .....	1285
<a href="#">CALCulate&lt;n&gt;:DELTamarker&lt;m&gt;:MAXimum:NEXT</a> .....	1285
<a href="#">CALCulate&lt;n&gt;:DELTamarker&lt;m&gt;:MAXimum[:PEAK]</a> .....	1285

CALCulate<n>:DELTamarker<m>:MAXimum:RIGHT.....	1286
CALCulate<n>:DELTamarker<m>:MINimum:LEFT.....	1286
CALCulate<n>:DELTamarker<m>:MINimum:NEXT.....	1286
CALCulate<n>:DELTamarker<m>:MINimum[:PEAK].....	1286
CALCulate<n>:DELTamarker<m>:MINimum:RIGHT.....	1287

---

### CALCulate<n>:DELTamarker<m>:MAXimum:LEFT

Moves a delta marker to the next positive peak value.

The search includes only measurement values to the left of the current marker position.

In the spectrogram, the command moves a marker horizontally to the maximum level in the currently selected frame. The vertical marker position remains the same.

#### Suffix:

<n>                      Window

<m>                      Marker

**Manual operation:** See "[Search Next Peak](#)" on page 564

---

### CALCulate<n>:DELTamarker<m>:MAXimum:NEXT

Moves a marker to the next positive peak value.

In the spectrogram, the command moves a marker horizontally to the maximum level in the currently selected frame. The vertical marker position remains the same.

#### Suffix:

<n>                      1..n  
                            Window

<m>                      1..n  
                            Marker

**Manual operation:** See "[Search Next Peak](#)" on page 564

---

### CALCulate<n>:DELTamarker<m>:MAXimum[:PEAK]

Moves a delta marker to the highest level.

In the spectrogram, the command moves a marker horizontally to the maximum level in the currently selected frame. The vertical marker position remains the same.

If the marker is not yet active, the command first activates the marker.

#### Suffix:

<n>                      Window

<m>                      Marker

**Manual operation:** See "[Peak Search](#)" on page 564

---

**CALCulate<n>:DELTaMarker<m>:MAXimum:RIGHT**

Moves a delta marker to the next positive peak value on the trace.

The search includes only measurement values to the right of the current marker position.

In the spectrogram, the command moves a marker horizontally to the maximum level in the currently selected frame. The vertical marker position remains the same.

**Suffix:**

<n>                      [Window](#)

<m>                      [Marker](#)

**Manual operation:**    See "[Search Next Peak](#)" on page 564

---

**CALCulate<n>:DELTaMarker<m>:MINimum:LEFT**

Moves a delta marker to the next minimum peak value.

The search includes only measurement values to the right of the current marker position.

In the spectrogram, the command moves a marker horizontally to the minimum level in the currently selected frame. The vertical marker position remains the same.

**Suffix:**

<n>                      [Window](#)

<m>                      [Marker](#)

**Manual operation:**    See "[Search Next Minimum](#)" on page 564

---

**CALCulate<n>:DELTaMarker<m>:MINimum:NEXT**

Moves a marker to the next minimum peak value.

In the spectrogram, the command moves a marker horizontally to the minimum level in the currently selected frame. The vertical marker position remains the same.

**Suffix:**

<n>                      [Window](#)

<m>                      [Marker](#)

**Manual operation:**    See "[Search Next Minimum](#)" on page 564

---

**CALCulate<n>:DELTaMarker<m>:MINimum[:PEAK]**

Moves a delta marker to the minimum level.

In the spectrogram, the command moves a marker horizontally to the minimum level in the currently selected frame. The vertical marker position remains the same.

If the marker is not yet active, the command first activates the marker.

**Suffix:**<n> [Window](#)<m> [Marker](#)**Manual operation:** See "[Search Minimum](#)" on page 564**CALCulate<n>:DELTaMarker<m>:MINimum:RIGHT**

Moves a delta marker to the next minimum peak value.

The search includes only measurement values to the right of the current marker position.

In the spectrogram, the command moves a marker horizontally to the minimum level in the currently selected frame. The vertical marker position remains the same.

**Suffix:**<n> [Window](#)<m> [Marker](#)**Manual operation:** See "[Search Next Minimum](#)" on page 564**13.8.3.5 Retrieving marker results**

The following commands are used to retrieve the results of markers.



You can use the marker values to position the center frequency or reference level directly using the following commands:

- [CALCulate<n>:MARKer<m>:FUNCTION:CENTer](#) on page 1190
- [CALCulate<n>:MARKer<m>:FUNCTION:REFerence](#) on page 1207

Useful commands for retrieving results described elsewhere:

- [CALCulate<n>:DELTaMarker<m>:X](#) on page 1272
- [CALCulate<n>:MARKer<m>:X](#) on page 1275
- [CALCulate<n>:MARKer<m>:FUNCTION:FPEaks:COUNT?](#) on page 1301
- [CALCulate<n>:MARKer<m>:FUNCTION:FPEaks:X?](#) on page 1303
- [CALCulate<n>:MARKer<m>:FUNCTION:FPEaks:Y?](#) on page 1303
- [CALCulate<n>:MARKer<m>:FUNCTION:NOISe:RESult?](#) on page 1304
- [CALCulate<n>:DELTaMarker<m>:FUNCTION:PNOIse:RESult?](#) on page 1305
- [CALCulate<n>:DELTaMarker<m>:FUNCTION:BPOWer:RESult?](#) on page 1310
- [CALCulate<n>:MARKer<m>:FUNCTION:BPOWer:RESult?](#) on page 1308
- [CALCulate<n>:MARKer<m>:FUNCTION:NDBDown:RESult?](#) on page 1313
- [CALCulate<n>:MARKer<m>:FUNCTION:NDBDown:FREQuency?](#) on page 1312

- [CALCulate<n>:MARKer<m>:FUNCTION:NDBDown:QFACTOR?](#) on page 1313
- [CALCulate<n>:MARKer<m>:COUNT:FREQUENCY?](#) on page 1315

### Remote commands exclusive to retrieving marker results

<a href="#">CALCulate&lt;n&gt;:DELTamarker&lt;m&gt;:X:RELative?</a> .....	1288
<a href="#">CALCulate&lt;n&gt;:DELTamarker&lt;m&gt;:Y?</a> .....	1288
<a href="#">CALCulate&lt;n&gt;:MARKer&lt;m&gt;:Y?</a> .....	1288

---

#### CALCulate<n>:DELTamarker<m>:X:RELative?

Queries the relative position of a delta marker on the x-axis.

If necessary, the command activates the delta marker first.

##### Suffix:

<n> [Window](#)

<m> [Marker](#)

##### Return values:

<Position> Position of the delta marker in relation to the reference marker.

##### Example:

`CALC:DELT3:X:REL?`

Outputs the frequency of delta marker 3 relative to marker 1 or relative to the reference position.

##### Usage:

Query only

##### Manual operation:

See "[Marker 1/Marker 2/Marker 3/Marker 4](#)" on page 326

See "[Marker 1/Marker 2/Marker 3](#)" on page 331

---

#### CALCulate<n>:DELTamarker<m>:Y?

Queries the result at the position of the specified delta marker.

##### Suffix:

<n> 1..n

<m> 1..n

##### Return values:

<Result> Result at the position of the delta marker.  
The unit is variable and depends on the one you have currently set.

Default unit: DBM

##### Usage:

Query only

---

#### CALCulate<n>:MARKer<m>:Y?

Queries the result at the position of the specified marker.

##### Suffix:

<n> 1..n



<m> 1..n

**Return values:**

<Result> Default unit: DBM

**Usage:** Query only

**Manual operation:** See "[Marker Table](#)" on page 535  
See "[Marker Peak List](#)" on page 536

### 13.8.3.6 Marker search (spectrograms)

The following commands automatically define the marker and delta marker position in the spectrogram.



The usage of these markers is demonstrated in [Chapter 13.8.2.7, "Programming example: configuring a spectrogram"](#), on page 1265.

#### Using markers

The following commands control spectrogram markers.

#### Useful commands for spectrogram markers described elsewhere

The following commands define the horizontal position of the markers.

- [CALCulate<n>:MARKer<m>:MAXimum:LEFT](#) on page 1282
- [CALCulate<n>:MARKer<m>:MAXimum:NEXT](#) on page 1282
- [CALCulate<n>:MARKer<m>:MAXimum\[:PEAK\]](#) on page 1282
- [CALCulate<n>:MARKer<m>:MAXimum:RIGHT](#) on page 1283
- [CALCulate<n>:MARKer<m>:MINimum:LEFT](#) on page 1283
- [CALCulate<n>:MARKer<m>:MINimum:NEXT](#) on page 1284
- [CALCulate<n>:MARKer<m>:MINimum\[:PEAK\]](#) on page 1284
- [CALCulate<n>:MARKer<m>:MINimum:RIGHT](#) on page 1284

#### Remote commands exclusive to spectrogram markers

<a href="#">CALCulate&lt;n&gt;:MARKer&lt;m&gt;:SGRam:FRAME</a> .....	1290
<a href="#">CALCulate&lt;n&gt;:MARKer&lt;m&gt;:SPEctrogram:FRAME</a> .....	1290
<a href="#">CALCulate&lt;n&gt;:MARKer&lt;m&gt;:SGRam:SARea</a> .....	1290
<a href="#">CALCulate&lt;n&gt;:MARKer&lt;m&gt;:SPEctrogram:SARea</a> .....	1290
<a href="#">CALCulate&lt;n&gt;:MARKer&lt;m&gt;:SGRam:XY:MAXimum[:PEAK]</a> .....	1291
<a href="#">CALCulate&lt;n&gt;:MARKer&lt;m&gt;:SPEctrogram:XY:MAXimum[:PEAK]</a> .....	1291
<a href="#">CALCulate&lt;n&gt;:MARKer&lt;m&gt;:SGRam:XY:MINimum[:PEAK]</a> .....	1291
<a href="#">CALCulate&lt;n&gt;:MARKer&lt;m&gt;:SPEctrogram:XY:MINimum[:PEAK]</a> .....	1291
<a href="#">CALCulate&lt;n&gt;:MARKer&lt;m&gt;:SGRam:Y:MAXimum:ABOVE</a> .....	1291
<a href="#">CALCulate&lt;n&gt;:MARKer&lt;m&gt;:SPEctrogram:Y:MAXimum:ABOVE</a> .....	1291
<a href="#">CALCulate&lt;n&gt;:MARKer&lt;m&gt;:SGRam:Y:MAXimum:BELOW</a> .....	1291
<a href="#">CALCulate&lt;n&gt;:MARKer&lt;m&gt;:SPEctrogram:Y:MAXimum:BELOW</a> .....	1291
<a href="#">CALCulate&lt;n&gt;:MARKer&lt;m&gt;:SGRam:Y:MAXimum:NEXT</a> .....	1292

CALCulate<n>:MARKer<m>:SPECtrogram:Y:MAXimum:NEXT .....	1292
CALCulate<n>:MARKer<m>:SGRam:Y:MAXimum[:PEAK].....	1292
CALCulate<n>:MARKer<m>:SPECtrogram:Y:MAXimum[:PEAK].....	1292
CALCulate<n>:MARKer<m>:SGRam:Y:MINimum:ABOVE.....	1292
CALCulate<n>:MARKer<m>:SPECtrogram:Y:MINimum:ABOVE.....	1292
CALCulate<n>:MARKer<m>:SGRam:Y:MINimum:BELOW.....	1292
CALCulate<n>:MARKer<m>:SPECtrogram:Y:MINimum:BELOW.....	1292
CALCulate<n>:MARKer<m>:SGRam:Y:MINimum:NEXT.....	1293
CALCulate<n>:MARKer<m>:SPECtrogram:Y:MINimum:NEXT.....	1293
CALCulate<n>:MARKer<m>:SGRam:Y:MINimum[:PEAK].....	1293
CALCulate<n>:MARKer<m>:SPECtrogram:Y:MINimum[:PEAK].....	1293

---

**CALCulate<n>:MARKer<m>:SGRam:FRAME <Frame>**

**CALCulate<n>:MARKer<m>:SPECtrogram:FRAME <Frame> | <Time>**

Positions a marker on a particular frame.

**Suffix:**

<n>                      [Window](#)

<m>                      [Marker](#)

**Parameters:**

<Frame>                Selects a frame directly by the frame number. Valid if the time stamp is off.

The range depends on the history depth.

Default unit: S

<Time>                Selects a frame via its time stamp. Valid if the time stamp is on.

The number is the (negative) distance to frame 0 in seconds.

The range depends on the history depth.

**Example:**

`CALC:MARK:SGR:FRAM -20`

Sets the marker on the 20th frame before the present.

`CALC:MARK2:SGR:FRAM -2s`

Sets second marker on the frame 2 seconds ago.

**Manual operation:** See "[Frame \(Spectrogram only\)](#)" on page 553

---

**CALCulate<n>:MARKer<m>:SGRam:SARea <SearchArea>**

**CALCulate<n>:MARKer<m>:SPECtrogram:SARea <SearchArea>**

Defines the marker search area for all spectrogram markers in the channel.

**Suffix:**

<n>                      irrelevant

<m>                      irrelevant

**Parameters:**

<SearchArea>        **VISible**

Performs a search within the visible frames.

Note that the command does not work if the spectrogram is not visible for any reason (e.g. if the display update is off).

**MEMory**

Performs a search within all frames in the memory.

\*RST:       VISible

**Manual operation:** See "[Marker Search Area](#)" on page 562

**CALCulate<n>:MARKer<m>:SGRam:XY:MAXimum[:PEAK]**

**CALCulate<n>:MARKer<m>:SPECTrogram:XY:MAXimum[:PEAK]**

Moves a marker to the highest level of the spectrogram.

**Suffix:**

<n>                   Window

<m>                   Marker

**CALCulate<n>:MARKer<m>:SGRam:XY:MINimum[:PEAK]**

**CALCulate<n>:MARKer<m>:SPECTrogram:XY:MINimum[:PEAK]**

Moves a marker to the minimum level of the spectrogram.

**Suffix:**

<n>                   Window

<m>                   Marker

**CALCulate<n>:MARKer<m>:SGRam:Y:MAXimum:ABOVE**

**CALCulate<n>:MARKer<m>:SPECTrogram:Y:MAXimum:ABOVE**

Moves a marker vertically to the next lower peak level for the current frequency.

The search includes only frames above the current marker position. It does not change the horizontal position of the marker.

**Suffix:**

<n>                   Window

<m>                   Marker

**Manual operation:** See "[Search Mode for Next Peak in Y-Direction](#)" on page 561

**CALCulate<n>:MARKer<m>:SGRam:Y:MAXimum:BELOW**

**CALCulate<n>:MARKer<m>:SPECTrogram:Y:MAXimum:BELOW**

Moves a marker vertically to the next lower peak level for the current frequency.

The search includes only frames below the current marker position. It does not change the horizontal position of the marker.

**Suffix:**

<n>                   Window

<m>                   Marker

**Manual operation:** See "[Search Mode for Next Peak in Y-Direction](#)" on page 561

---

**CALCulate<n>:MARKer<m>:SGRam:Y:MAXimum:NEXT**

**CALCulate<n>:MARKer<m>:SPECTrogram:Y:MAXimum:NEXT**

Moves a marker vertically to the next lower peak level for the current frequency.

The search includes all frames. It does not change the horizontal position of the marker.

**Suffix:**

<n> [Window](#)

<m> [Marker](#)

**Manual operation:** See "[Search Mode for Next Peak in Y-Direction](#)" on page 561

---

**CALCulate<n>:MARKer<m>:SGRam:Y:MAXimum[:PEAK]**

**CALCulate<n>:MARKer<m>:SPECTrogram:Y:MAXimum[:PEAK]**

Moves a marker vertically to the highest level for the current frequency.

The search includes all frames. It does not change the horizontal position of the marker.

If the marker hasn't been active yet, the command looks for the peak level in the whole spectrogram.

**Suffix:**

<n> [Window](#)

<m> [Marker](#)

---

**CALCulate<n>:MARKer<m>:SGRam:Y:MINimum:ABOVE**

**CALCulate<n>:MARKer<m>:SPECTrogram:Y:MINimum:ABOVE**

Moves a marker vertically to the next higher minimum level for the current frequency.

The search includes only frames above the current marker position. It does not change the horizontal position of the marker.

**Suffix:**

<n> [Window](#)

<m> [Marker](#)

**Manual operation:** See "[Search Mode for Next Peak in Y-Direction](#)" on page 561

---

**CALCulate<n>:MARKer<m>:SGRam:Y:MINimum:BELOW**

**CALCulate<n>:MARKer<m>:SPECTrogram:Y:MINimum:BELOW**

Moves a marker vertically to the next higher minimum level for the current frequency.

The search includes only frames below the current marker position. It does not change the horizontal position of the marker.

**Suffix:**

<n> [Window](#)

<m> [Marker](#)

**Manual operation:** See ["Search Mode for Next Peak in Y-Direction"](#) on page 561

**CALCulate<n>:MARKer<m>:SGRam:Y:MINimum:NEXT**

**CALCulate<n>:MARKer<m>:SPECTrogram:Y:MINimum:NEXT**

Moves a marker vertically to the next higher minimum level for the current frequency.

The search includes all frames. It does not change the horizontal position of the marker.

**Suffix:**

<n> [Window](#)

<m> [Marker](#)

**Manual operation:** See ["Search Mode for Next Peak in Y-Direction"](#) on page 561

**CALCulate<n>:MARKer<m>:SGRam:Y:MINimum[:PEAK]**

**CALCulate<n>:MARKer<m>:SPECTrogram:Y:MINimum[:PEAK]**

Moves a marker vertically to the minimum level for the current frequency.

The search includes all frames. It does not change the horizontal position of the marker.

If the marker hasn't been active yet, the command first looks for the peak level for all frequencies and moves the marker vertically to the minimum level.

**Suffix:**

<n> [Window](#)

<m> [Marker](#)

### Using delta markers

The following commands control spectrogram delta markers.

#### Useful commands for spectrogram markers described elsewhere

The following commands define the horizontal position of the delta markers.

- [CALCulate<n>:DELTaMarker<m>:MAXimum:LEFT](#) on page 1285
- [CALCulate<n>:DELTaMarker<m>:MAXimum:NEXT](#) on page 1285
- [CALCulate<n>:DELTaMarker<m>:MAXimum\[:PEAK\]](#) on page 1285
- [CALCulate<n>:DELTaMarker<m>:MAXimum:RIGHT](#) on page 1286
- [CALCulate<n>:DELTaMarker<m>:MINimum:LEFT](#) on page 1286
- [CALCulate<n>:DELTaMarker<m>:MINimum:NEXT](#) on page 1286
- [CALCulate<n>:DELTaMarker<m>:MINimum\[:PEAK\]](#) on page 1286
- [CALCulate<n>:DELTaMarker<m>:MINimum:RIGHT](#) on page 1287

**Remote commands exclusive to spectrogram markers**

CALCulate<n>:DELTamarker<m>:SGRam:FRAMe.....	1294
CALCulate<n>:DELTamarker<m>:SPECTrogram:FRAMe.....	1294
CALCulate<n>:DELTamarker<m>:SGRam:SARea.....	1295
CALCulate<n>:DELTamarker<m>:SPECTrogram:SARea.....	1295
CALCulate<n>:DELTamarker<m>:SGRam:XY:MAXimum[:PEAK].....	1295
CALCulate<n>:DELTamarker<m>:SPECTrogram:XY:MAXimum[:PEAK].....	1295
CALCulate<n>:DELTamarker<m>:SGRam:XY:MINimum[:PEAK].....	1295
CALCulate<n>:DELTamarker<m>:SPECTrogram:XY:MINimum[:PEAK].....	1295
CALCulate<n>:DELTamarker<m>:SGRam:Y:MAXimum:ABOVe.....	1295
CALCulate<n>:DELTamarker<m>:SPECTrogram:Y:MAXimum:ABOVe.....	1295
CALCulate<n>:DELTamarker<m>:SGRam:Y:MAXimum:BELow.....	1296
CALCulate<n>:DELTamarker<m>:SPECTrogram:Y:MAXimum:BELow.....	1296
CALCulate<n>:DELTamarker<m>:SGRam:Y:MAXimum:NEXT.....	1296
CALCulate<n>:DELTamarker<m>:SPECTrogram:Y:MAXimum:NEXT.....	1296
CALCulate<n>:DELTamarker<m>:SGRam:Y:MAXimum[:PEAK].....	1296
CALCulate<n>:DELTamarker<m>:SPECTrogram:Y:MAXimum[:PEAK].....	1296
CALCulate<n>:DELTamarker<m>:SGRam:Y:MINimum:ABOVe.....	1297
CALCulate<n>:DELTamarker<m>:SPECTrogram:Y:MINimum:ABOVe.....	1297
CALCulate<n>:DELTamarker<m>:SGRam:Y:MINimum:BELow.....	1297
CALCulate<n>:DELTamarker<m>:SPECTrogram:Y:MINimum:BELow.....	1297
CALCulate<n>:DELTamarker<m>:SGRam:Y:MINimum:NEXT.....	1297
CALCulate<n>:DELTamarker<m>:SPECTrogram:Y:MINimum:NEXT.....	1297
CALCulate<n>:DELTamarker<m>:SGRam:Y:MINimum[:PEAK].....	1297
CALCulate<n>:DELTamarker<m>:SPECTrogram:Y:MINimum[:PEAK].....	1297

---

**CALCulate<n>:DELTamarker<m>:SGRam:FRAMe <Frame>**

**CALCulate<n>:DELTamarker<m>:SPECTrogram:FRAMe <Frame>**

Positions a delta marker on a particular frame. The frame is relative to the position of marker 1.

The command is available for the spectrogram.

**Suffix:**

<n>                      [Window](#)

<m>                      [Marker](#)

**Parameters:**

<Frame>                      Selects a frame either by its frame number or time stamp.  
The frame number is available if the time stamp is off. The range depends on the history depth.

The time stamp is available if the time stamp is on. The number is the distance to frame 0 in seconds. The range depends on the history depth.

Default unit: S

**Example:**            `CALC:DELTA4:SGR:FRAM -20`  
 Sets fourth deltamarker 20 frames below marker 1.  
`CALC:DELTA4:SGR:FRAM 2 s`  
 Sets fourth deltamarker 2 seconds above the position of marker 1.

**Manual operation:** See "[Frame \(Spectrogram only\)](#)" on page 553

**CALCulate<n>:DELTamarker<m>:SGRam:SARea <SearchArea>**  
**CALCulate<n>:DELTamarker<m>:SPECTrogram:SARea <SearchArea>**  
 Defines the marker search area for *all* spectrogram markers in the channel.

**Suffix:**  
 <n>                    irrelevant  
 <m>                    irrelevant

**Parameters:**  
 <SearchArea>        **VISible**  
 Performs a search within the visible frames.  
 Note that the command does not work if the spectrogram is not visible for any reason (e.g. if the display update is off).

**MEMory**  
 Performs a search within all frames in the memory.  
 \*RST:                VISible

**Manual operation:** See "[Marker Search Area](#)" on page 562

**CALCulate<n>:DELTamarker<m>:SGRam:XY:MAXimum[:PEAK]**  
**CALCulate<n>:DELTamarker<m>:SPECTrogram:XY:MAXimum[:PEAK]**  
 Moves a marker to the highest level of the spectrogram over all frequencies.

**Suffix:**  
 <n>                    [Window](#)  
 <m>                    [Marker](#)

**CALCulate<n>:DELTamarker<m>:SGRam:XY:MINimum[:PEAK]**  
**CALCulate<n>:DELTamarker<m>:SPECTrogram:XY:MINimum[:PEAK]**  
 Moves a delta marker to the minimum level of the spectrogram over all frequencies.

**Suffix:**  
 <n>                    [Window](#)  
 <m>                    [Marker](#)

**CALCulate<n>:DELTamarker<m>:SGRam:Y:MAXimum:ABOVE**  
**CALCulate<n>:DELTamarker<m>:SPECTrogram:Y:MAXimum:ABOVE**  
 Moves a marker vertically to the next higher level for the current frequency.

The search includes only frames above the current marker position. It does not change the horizontal position of the marker.

**Suffix:**

<n> [Window](#)

<m> [Marker](#)

**Manual operation:** See ["Search Mode for Next Peak in Y-Direction"](#) on page 561

**CALCulate<n>:DELTamarker<m>:SGRam:Y:MAXimum:BELOW**

**CALCulate<n>:DELTamarker<m>:SPECTrogram:Y:MAXimum:BELOW**

Moves a marker vertically to the next higher level for the current frequency.

The search includes only frames below the current marker position. It does not change the horizontal position of the marker.

**Suffix:**

<n> [Window](#)

<m> [Marker](#)

**Manual operation:** See ["Search Mode for Next Peak in Y-Direction"](#) on page 561

**CALCulate<n>:DELTamarker<m>:SGRam:Y:MAXimum:NEXT**

**CALCulate<n>:DELTamarker<m>:SPECTrogram:Y:MAXimum:NEXT**

Moves a delta marker vertically to the next higher level for the current frequency.

The search includes all frames. It does not change the horizontal position of the marker.

**Suffix:**

<n> [Window](#)

<m> [Marker](#)

**Manual operation:** See ["Search Mode for Next Peak in Y-Direction"](#) on page 561

**CALCulate<n>:DELTamarker<m>:SGRam:Y:MAXimum[:PEAK]**

**CALCulate<n>:DELTamarker<m>:SPECTrogram:Y:MAXimum[:PEAK]**

Moves a delta marker vertically to the highest level for the current frequency.

The search includes all frames. It does not change the horizontal position of the marker.

If the marker hasn't been active yet, the command looks for the peak level in the whole spectrogram.

**Suffix:**

<n> [Window](#)

<m> [Marker](#)



---

**CALCulate<n>:DELTamarker<m>:SGRam:Y:MINimum:ABOVE**

**CALCulate<n>:DELTamarker<m>:SPECTrogram:Y:MINimum:ABOVE**

Moves a delta marker vertically to the next minimum level for the current frequency.

The search includes only frames above the current marker position. It does not change the horizontal position of the marker.

**Suffix:**

<n> [Window](#)

<m> [Marker](#)

**Manual operation:** See "[Search Mode for Next Peak in Y-Direction](#)" on page 561

---

**CALCulate<n>:DELTamarker<m>:SGRam:Y:MINimum:BELOW**

**CALCulate<n>:DELTamarker<m>:SPECTrogram:Y:MINimum:BELOW**

Moves a delta marker vertically to the next minimum level for the current frequency.

The search includes only frames below the current marker position. It does not change the horizontal position of the marker.

**Suffix:**

<n> [Window](#)

<m> [Marker](#)

**Manual operation:** See "[Search Mode for Next Peak in Y-Direction](#)" on page 561

---

**CALCulate<n>:DELTamarker<m>:SGRam:Y:MINimum:NEXT**

**CALCulate<n>:DELTamarker<m>:SPECTrogram:Y:MINimum:NEXT**

Moves a delta marker vertically to the next minimum level for the current frequency.

The search includes all frames. It does not change the horizontal position of the marker.

**Suffix:**

<n> [Window](#)

<m> [Marker](#)

**Manual operation:** See "[Search Mode for Next Peak in Y-Direction](#)" on page 561

---

**CALCulate<n>:DELTamarker<m>:SGRam:Y:MINimum[:PEAK]**

**CALCulate<n>:DELTamarker<m>:SPECTrogram:Y:MINimum[:PEAK]**

Moves a delta marker vertically to the minimum level for the current frequency.

The search includes all frames. It does not change the horizontal position of the marker.

If the marker hasn't been active yet, the command first looks for the peak level in the whole spectrogram and moves the marker vertically to the minimum level.

<b>Suffix:</b>	
<n>	Window
<m>	Marker

### 13.8.3.7 Fixed reference marker settings

The following commands configure a fixed reference marker.

CALCulate<n>:DELTamarker<m>:FUNction:FIXed:RPOint:MAXimum[:PEAK].....	1298
CALCulate<n>:DELTamarker<m>:FUNction:FIXed:RPOint:X.....	1298
CALCulate<n>:DELTamarker<m>:FUNction:FIXed:RPOint:Y.....	1299
CALCulate<n>:DELTamarker<m>:FUNction:FIXed:RPOint:Y:OFFSet.....	1299
CALCulate<n>:DELTamarker<m>:FUNction:FIXed[:STATe].....	1299

---

#### CALCulate<n>:DELTamarker<m>:FUNction:FIXed:RPOint:MAXimum[:PEAK]

Moves the fixed reference marker to the peak power.

<b>Suffix:</b>	
<n>	Window
<m>	Marker

**Example:**           CALC:DELT:FUNC:FIX:RPO:MAX  
Sets the reference point level for delta markers to the peak of the selected trace.

**Manual operation:** See "[Defining a Fixed Reference](#)" on page 556  
See "[Defining Reference Point](#)" on page 573

---

#### CALCulate<n>:DELTamarker<m>:FUNction:FIXed:RPOint:X <RefPoint>

Defines the horizontal position of the fixed delta marker reference point. The coordinates of the reference may be anywhere in the diagram.

<b>Suffix:</b>	
<n>	Window
<m>	Marker

**Parameters:**  
<RefPoint>           Numeric value that defines the horizontal position of the reference.  
For frequency domain measurements, it is a frequency in Hz.  
For time domain measurements, it is a point in time in s.  
**\*RST:**           Fixed Reference: OFF  
Default unit: HZ

**Example:**           CALC:DELT:FUNC:FIX:RPO:X 128 MHz  
Sets the frequency reference to 128 MHz.

**Manual operation:** See "[Defining a Fixed Reference](#)" on page 556  
See "[Defining Reference Point](#)" on page 573

**CALCulate<n>:DELTaMarker<m>:FUNction:FIXed:RPOint:Y <RefPointLevel>**

Defines the vertical position of the fixed delta marker reference point. The coordinates of the reference may be anywhere in the diagram.

**Suffix:**

<n> [Window](#)

<m> [Marker](#)

**Parameters:**

<RefPoint> Numeric value that defines the vertical position of the reference. The unit and value range is variable.

\*RST: Fixed Reference: OFF

Default unit: DBM

**Example:**

CALC:DELT:FUNC:FIX:RPO:Y -10dBm

Sets the reference point level for delta markers to -10 dBm.

**Manual operation:**

See ["Defining a Fixed Reference"](#) on page 556

See ["Defining Reference Point"](#) on page 573

**CALCulate<n>:DELTaMarker<m>:FUNction:FIXed:RPOint:Y:OFFSet <Offset>**

Defines a level offset for the fixed delta marker reference point.

**Suffix:**

<n> [Window](#)

<m> [Marker](#)

**Parameters:**

<Offset> Numeric value

\*RST: 0

Default unit: dB

**CALCulate<n>:DELTaMarker<m>:FUNction:FIXed[:STATe] <State>**

Activates or deactivates a marker that defines a fixed reference point for relative marker analysis.

If necessary, the command activates a marker and positions it on the peak power.

Subsequently, you can change the coordinates of the fixed reference independent of the marker. The fixed reference is independent of the trace and is applied to all active delta markers.

**Suffix:**

<n> [Window](#)

<m> [Marker](#)

**Parameters:**

<State> ON | OFF | 0 | 1

**OFF | 0**

Switches the function off

**ON | 1**

Switches the function on

**Example:**`CALC:DELT:FUNC:FIX ON`

Switches on the measurement with fixed reference value for all delta markers.

`CALC:DELT:FUNC:FIX:RPO:X 128 MHZ`

Sets the frequency reference to 128 MHz.

`CALC:DELT:FUNC:FIX:RPO:Y 30 DBM`

Sets the reference level to +30 dBm.

**Manual operation:** See ["Defining a Fixed Reference"](#) on page 556**13.8.3.8 Marker peak lists****Useful commands for peak lists described elsewhere**

- [CALCulate<n>:MARKer<m>:PEXCursion](#) on page 1277
- [MMEMoRY:STORe<n>:PEAK](#) on page 1374
- [Chapter 13.8.3.3, "Configuring and performing a marker search"](#), on page 1277

**Remote commands exclusive to peak lists**

<a href="#">CALCulate&lt;n&gt;:MARKer&lt;m&gt;:FUNctioN:FPEaks:ANNotation:LABel[:STATe]</a> .....	1300
<a href="#">CALCulate&lt;n&gt;:MARKer&lt;m&gt;:FUNctioN:FPEaks:COUNt?</a> .....	1301
<a href="#">CALCulate&lt;n&gt;:MARKer&lt;m&gt;:FUNctioN:FPEaks[:IMMEDIATE]</a> .....	1301
<a href="#">CALCulate&lt;n&gt;:MARKer&lt;m&gt;:FUNctioN:FPEaks:LIST:SIZE</a> .....	1301
<a href="#">CALCulate&lt;n&gt;:MARKer&lt;m&gt;:FUNctioN:FPEaks:SORT</a> .....	1302
<a href="#">CALCulate&lt;n&gt;:MARKer&lt;m&gt;:FUNctioN:FPEaks:STATe</a> .....	1302
<a href="#">CALCulate&lt;n&gt;:MARKer&lt;m&gt;:FUNctioN:FPEaks:X?</a> .....	1303
<a href="#">CALCulate&lt;n&gt;:MARKer&lt;m&gt;:FUNctioN:FPEaks:Y?</a> .....	1303

---

**CALCulate<n>:MARKer<m>:FUNctioN:FPEaks:ANNotation:LABel[:STATe]**  
 <State>

Turns labels for peaks found during a peak search on and off.

The labels correspond to the marker number in the marker peak list.

**Suffix:**<n> [Window](#)<m> [Marker](#)**Parameters:**

&lt;State&gt; ON | OFF | 0 | 1

\*RST: 1

**Example:**`CALC:MARK:FUNC:FPE:ANN:LAB:STAT OFF`

Removes the peak labels from the diagram

**Manual operation:** See "[Display Marker Numbers](#)" on page 585

---

### CALCulate<n>:MARKer<m>:FUNction:FPEaks:COUNT?

Queries the number of peaks that have been found during a peak search.

The actual number of peaks that have been found may differ from the number of peaks you have set to be found because of the peak excursion.

**Suffix:**

<n> irrelevant

<m> irrelevant

**Return values:**

<NumberOfPeaks>

**Example:**            CALC:MARK:FUNC:FPE:COUN?  
Queries the number of peaks.

**Usage:**             Query only

---

### CALCulate<n>:MARKer<m>:FUNction:FPEaks[:IMMEDIATE] <Peaks>

Initiates a peak search.

**Suffix:**

<n>                    [Window](#)

<m>                    [Marker](#)

**Parameters:**

<Peaks>             This parameter defines the number of peaks to find during the search.

Note that the actual number of peaks found during the search also depends on the peak excursion you have set with [CALCulate<n>:MARKer<m>:PEXCursion](#).

Range:            1 to 200

**Example:**            CALC:MARK:PEXC 5  
Defines a peak excursion of 5 dB, i.e. peaks must be at least 5 dB apart to be detected as a peak.  
CALC:MARK:FUNC:FPE 10  
Initiates a search for 10 peaks on the current trace.

---

### CALCulate<n>:MARKer<m>:FUNction:FPEaks:LIST:SIZE <MaxNoPeaks>

Defines the maximum number of peaks that the FSW looks for during a peak search.

**Suffix:**

<n>                    [Window](#)

<m>                    [Marker](#)

**Parameters:**

<MaxNoPeaks> Maximum number of peaks to be determined.

Range: 1 to 500

\*RST: 50

**Example:**

CALC:MARK:FUNC:FPE:LIST:SIZE 10

The marker peak list will contain a maximum of 10 peaks.

**Manual operation:** See "[Maximum Number of Peaks](#)" on page 585

**CALCulate<n>:MARKer<m>:FUNctio:n:FPEaks:SORT <SortMode>**

Selects the order in which the results of a peak search are returned.

**Suffix:**

<n> [Window](#)

<m> [Marker](#)

**Parameters:**

<SortMode> **X**

Sorts the peaks according to increasing position on the x-axis.

**Y**

Sorts the peaks according to decreasing position on the y-axis.

\*RST: X

**Example:**

CALC:MARK:FUNC:FPE:SORT Y

Sets the sort mode to decreasing y values

**Manual operation:** See "[Sort Mode](#)" on page 585

**CALCulate<n>:MARKer<m>:FUNctio:n:FPEaks:STATe <State>**

Turns a peak search on and off.

**Suffix:**

<n> [Window](#)

<m> [Marker](#)

**Parameters:**

<State> ON | OFF | 0 | 1

**OFF | 0**

Switches the function off

**ON | 1**

Switches the function on

**Example:**

CALC:MARK:FUNC:FPE:STAT ON

Activates marker peak search

**Manual operation:** See "[Peak List State](#)" on page 585

**CALCulate<n>:MARKer<m>:FUNction:FPEaks:X?**

Queries the position of the peaks on the x-axis.

The order depends on the sort order that has been set with [CALCulate<n>:MARKer<m>:FUNction:FPEaks:SORT](#).

**Suffix:**

<n> irrelevant

<m> irrelevant

**Return values:**

<PeakPosition> Position of the peaks on the x-axis. The unit depends on the measurement.

**Usage:** Query only

**CALCulate<n>:MARKer<m>:FUNction:FPEaks:Y?**

Queries the position of the peaks on the y-axis.

The order depends on the sort order that has been set with [CALCulate<n>:MARKer<m>:FUNction:FPEaks:SORT](#).

**Suffix:**

<n> irrelevant

<m> irrelevant

**Return values:**

<PeakPosition> Position of the peaks on the y-axis. The unit depends on the measurement.

**Usage:** Query only

**13.8.3.9 Noise measurement marker**

The following commands control the noise measurement marker function.

[CALCulate<n>:MARKer<m>:FUNction:NOISe:AOff](#)..... 1303

[CALCulate<n>:MARKer<m>:FUNction:NOISe:RESult?](#)..... 1304

[CALCulate<n>:MARKer<m>:FUNction:NOISe\[:STATe\]](#)..... 1304

**CALCulate<n>:MARKer<m>:FUNction:NOISe:AOff**

Removes all noise markers in the specified window.

**Suffix:**

<n> [Window](#)

<m> irrelevant

**Example:** `CALC:MARK:FUNC:NOIS:AOff`

**CALCulate<n>:MARKer<m>:FUNction:NOISe:RESult?**

Queries the result of the noise measurement.

To get a valid result, you have to perform a complete measurement with synchronization to the end of the measurement before reading out the result. This is only possible for single sweep mode.

See also [INITiate<n>:CONTinuous](#) on page 909.

**Suffix:**

<n> [Window](#)

<m> [Marker](#)

**Return values:**

<NoiseLevel> Current noise level. The unit is the one currently active.

**Example:**

```
INIT:CONT OFF
Switches to single sweep mode.
CALC:MARK2 ON
Switches on marker 2.
CALC:MARK2:FUNC:NOIS ON
Switches on noise measurement for marker 2.
INIT;*WAI
Starts a sweep and waits for the end.
CALC:MARK2:FUNC:NOIS:RES?
Outputs the noise result of marker 2.
```

**Usage:** Query only

**Manual operation:** See ["Noise Measurement State"](#) on page 570

**CALCulate<n>:MARKer<m>:FUNction:NOISe[:STATe] <State>**

Turns the noise measurement at the marker position on and off.

**Suffix:**

<n> [Window](#)

<m> [Marker](#)

**Parameters:**

<State> ON | OFF | 0 | 1

**OFF | 0**

Switches the function off

**ON | 1**

Switches the function on

**Example:**

```
CALC:MARK:FUNC:NOIS ON
Switches on the noise measurement.
```

**Manual operation:** See ["Noise Measurement State"](#) on page 570  
See ["Switching All Noise Measurement Off"](#) on page 570



### 13.8.3.10 Phase noise measurement marker

The following commands control the phase noise measurement marker function.

#### Useful commands for phase noise markers described elsewhere

- `CALCulate<n>:DELTaMarker<m>:FUNCTION:FIXed:RPOint:MAXimum[:PEAK]`
- `CALCulate<n>:DELTaMarker<m>:FUNCTION:FIXed:RPOint:X`
- `CALCulate<n>:DELTaMarker<m>:FUNCTION:FIXed:RPOint:Y`

#### Remote commands exclusive to phase noise markers

<code>CALCulate&lt;n&gt;:DELTaMarker&lt;m&gt;:FUNCTION:PNOise:AUTO</code> .....	1305
<code>CALCulate&lt;n&gt;:DELTaMarker&lt;m&gt;:FUNCTION:PNOise:RESult?</code> .....	1305
<code>CALCulate&lt;n&gt;:DELTaMarker&lt;m&gt;:FUNCTION:PNOise[:STATE]</code> .....	1306
<code>CALCulate&lt;n&gt;:MARKer&lt;m&gt;:FUNCTION:PNOise:AOff</code> .....	1306
<code>CALCulate&lt;n&gt;:MARKer&lt;m&gt;:FUNCTION:PNOise:RESult?</code> .....	1307
<code>CALCulate&lt;n&gt;:MARKer&lt;m&gt;:FUNCTION:PNOise[:STATE]</code> .....	1307

---

#### `CALCulate<n>:DELTaMarker<m>:FUNCTION:PNOise:AUTO <State>`

Turns an automatic peak search for the fixed reference marker at the end of a sweep on and off.

##### Suffix:

<n> [Window](#)

<m> [Marker](#)

##### Parameters:

<State> ON | OFF | 0 | 1

##### OFF | 0

Switches the function off

##### ON | 1

Switches the function on

##### Example:

`CALC:DELT:FUNC:PNO:AUTO ON`

Activates an automatic peak search for the reference marker in a phase-noise measurement.

**Manual operation:** See ["Defining Reference Point"](#) on page 573

---

#### `CALCulate<n>:DELTaMarker<m>:FUNCTION:PNOise:RESult?`

Queries the result of a phase noise measurement.

If necessary, the command activates the measurement first.

Is only available in the Spectrum application.

##### Suffix:

<n> [Window](#)

<m>	<a href="#">Marker</a>
<b>Return values:</b>	
<PhaseNoise>	numeric value The difference in level between the reference point and the noise power density at the position of the specified delta marker.
<b>Example:</b>	<code>CALC:DELT2:FUNC:PNO:RES?</code> Outputs the result of phase-noise measurement of the delta-marker 2.
<b>Usage:</b>	Query only
<b>Manual operation:</b>	See " <a href="#">Phase Noise Measurement State</a> " on page 572

### **CALCulate<n>:DELTaMarker<m>:FUNCTioN:PNOise[:STATe] <State>**

Turns the phase noise measurement at the delta marker position on and off.

The reference marker for phase noise measurements is either a normal marker or a fixed reference. If necessary, the command turns on the reference marker.

The correction values for the bandwidth and the log amplifier are taken into account in the measurement.

#### **Suffix:**

<n> [Window](#)

<m> [Marker](#)

#### **Parameters:**

<State> ON | OFF | 0 | 1  
**OFF | 0**  
 Switches the function off  
**ON | 1**  
 Switches the function on

**Example:** `CALC:DELT:FUNC:PNO ON`  
 Switches on the phase-noise measurement with all delta markers.  
`CALC:DELT:FUNC:FIX:RPO:X 128 MHZ`  
 Sets the frequency reference to 128 MHz.  
`CALC:DELT:FUNC:FIX:RPO:Y 30 DBM`  
 Sets the reference level to +30 dBm

**Manual operation:** See "[Phase Noise Measurement State](#)" on page 572  
 See "[Switching All Phase Noise Measurements Off](#)" on page 573

### **CALCulate<n>:MARKer<m>:FUNCTioN:PNOise:AOff**

Removes all phase noise markers in the specified window.

**Suffix:**<n> [Window](#)

&lt;m&gt; irrelevant

**Example:**

CALC:MARK:FUNC:PNO:AOFF

**CALCulate<n>:MARKer<m>:FUNCTion:PNOise:RESult?**

Queries the result of a phase noise measurement.

If necessary, the command activates the measurement first.

**Suffix:**<n> [Window](#)<m> [Marker](#)**Return values:**

&lt;PhaseNoise&gt; numeric value

The difference between the measured carrier power and the noise power at the position of the specified (normal) marker.

**Example:**

CALC:MARK2:FUNC:PNO:RES?

Outputs the result of phase-noise measurement of the marker 2.

**Usage:**

Query only

**CALCulate<n>:MARKer<m>:FUNCTion:PNOise[:STATe] <State>**

Turns the phase noise measurement at the marker position on and off.

**Suffix:**<n> [Window](#)<m> [Marker](#)**Parameters:**

&lt;State&gt; ON | OFF | 0 | 1

**OFF | 0**

Switches the function off

**ON | 1**

Switches the function on

**Example:**

CALC:MARK2:FUNC:PNO ON

Switches on the phase-noise measurement for the marker 2.

**13.8.3.11 Band power marker**

The following commands control the marker for band power measurements.

**Using markers**

<a href="#">CALCulate&lt;n&gt;:MARKer&lt;m&gt;:FUNction:BPOWer:AOff</a> .....	1308
<a href="#">CALCulate&lt;n&gt;:MARKer&lt;m&gt;:FUNction:BPOWer:MODE</a> .....	1308
<a href="#">CALCulate&lt;n&gt;:MARKer&lt;m&gt;:FUNction:BPOWer:RESult?</a> .....	1308
<a href="#">CALCulate&lt;n&gt;:MARKer&lt;m&gt;:FUNction:BPOWer:SPAN</a> .....	1309
<a href="#">CALCulate&lt;n&gt;:MARKer&lt;m&gt;:FUNction:BPOWer[:STATe]</a> .....	1309

**CALCulate<n>:MARKer<m>:FUNction:BPOWer:AOff**

Removes all band power markers in the specified window.

**Suffix:**

<n> [Window](#)

<m> irrelevant

**Example:** `CALC:MARK:FUNC:BPOW:AOff`

**CALCulate<n>:MARKer<m>:FUNction:BPOWer:MODE <Mode>**

Selects the way the results for a band power marker are displayed.

(Note: relative power results are only available for delta markers, see [.CALCulate<n>:DELTAmarker<m>:FUNction:BPOWer:MODE](#) on page 1310)

**Suffix:**

<n> [Window](#)

<m> [Marker](#)

**Parameters:**

<Mode> **POWer**  
Result is displayed as an absolute power. The power unit depends on the [CALCulate<n>:UNIT:POWer](#) setting.

**DENSity**

Result is displayed as a density in dBm/Hz.

\*RST: `POWer`

**Example:** `CALC:MARK4:FUNC:BPOW:MODE DENS`  
Configures marker 4 to show the measurement results in dBm/Hz.

**Manual operation:** See ["Power Mode"](#) on page 579

**CALCulate<n>:MARKer<m>:FUNction:BPOWer:RESult?**

Queries the results of the band power measurement.

**Suffix:**

<n> [Window](#)

<m> [Marker](#)

**Return values:**

<Power> Signal power over the marker bandwidth.

**Example:**

Activate the band power marker:

```
CALC:MARK:FUNC:BPOW:STAT ON
```

Select the density mode for the result:

```
CALC:MARK:FUNC:BPOW:MODE DENS
```

Query the result:

```
CALC:MARK:FUNC:BPOW:RES?
```

Response:

```
20dBm/Hz
```

**Usage:**

Query only

**CALCulate<n>:MARKer<m>:FUNCTion:BPOWER:SPAN <Span>**

Defines the bandwidth around the marker position.

**Suffix:**

<n> [Window](#)

<m> [Marker](#)

**Parameters:**

<Span> Frequency. The maximum span depends on the marker position and FSW model.

\*RST: 5% of current span

Default unit: Hz

**Example:**

```
CALC:MARK:FUNC:BPOW:SPAN 2MHz
```

Measures the band power over 2 MHz around the marker.

**Manual operation:** See "[Span](#)" on page 579

**CALCulate<n>:MARKer<m>:FUNCTion:BPOWER[:STATe] <State>**

Turns markers for band power measurements on and off.

**Suffix:**

<n> [Window](#)

<m> [Marker](#)

**Parameters:**

<State> ON | OFF | 0 | 1

**OFF | 0**

Switches the function off

**ON | 1**

Switches the function on

**Example:**

```
CALC:MARK4:FUNC:BPOW:STAT ON
```

Activates or turns marker 4 into a band power marker.

**Manual operation:** See ["Band Power Measurement State"](#) on page 578  
See ["Switching All Band Power Measurements Off"](#) on page 579

### Using delta markers

<a href="#">CALCulate&lt;n&gt;:DELTamarker&lt;m&gt;:FUNction:BPOWer:MODE</a> .....	1310
<a href="#">CALCulate&lt;n&gt;:DELTamarker&lt;m&gt;:FUNction:BPOWer:RESult?</a> .....	1310
<a href="#">CALCulate&lt;n&gt;:DELTamarker&lt;m&gt;:FUNction:BPOWer:SPAN</a> .....	1311
<a href="#">CALCulate&lt;n&gt;:DELTamarker&lt;m&gt;:FUNction:BPOWer[:STATe]</a> .....	1311

---

### **CALCulate<n>:DELTamarker<m>:FUNction:BPOWer:MODE** <Mode>

Selects the way the results for a band power delta marker are displayed.

#### **Suffix:**

<n>	<a href="#">Window</a>
<m>	<a href="#">Marker</a>

#### **Parameters:**

<Mode>

#### **POWer**

Result is displayed as an absolute power. The power unit depends on the [CALCulate<n>:UNIT:POWer](#) setting.

#### **DENSity**

Result is displayed as a density in dBm/Hz.

#### **RPOWer**

This setting is only available for a delta band power marker. The result is the difference between the absolute power in the band around the delta marker and the absolute power for the reference marker. The powers are subtracted logarithmically, so the result is a dB value.

*[Relative band power (Delta2) in dB] = [absolute band power (Delta2) in dBm] - [absolute (band) power of reference marker in dBm]*

For details see ["Relative band power markers"](#) on page 577.

\*RST:       POWer

**Manual operation:** See ["Power Mode"](#) on page 579

---

### **CALCulate<n>:DELTamarker<m>:FUNction:BPOWer:RESult?**

Queries the results of the band power measurement.

#### **Suffix:**

<n>	<a href="#">Window</a>
<m>	<a href="#">Marker</a>

#### **Return values:**

<Power>       Signal power over the delta marker bandwidth.

**Usage:**       Query only

**CALCulate<n>:DELTaMarker<m>:FUNCTION:BPOWER:SPAN <Span>**

Defines the bandwidth around the delta marker position.

**Suffix:**

<n> [Window](#)

<m> [Marker](#)

**Parameters:**

<Span> Frequency. The maximum span depends on the marker position and FSW model.

\*RST: 5% of current span

Default unit: Hz

**Manual operation:** See ["Span"](#) on page 579

**CALCulate<n>:DELTaMarker<m>:FUNCTION:BPOWER[:STATe] <State>**

Turns delta markers for band power measurements on and off.

If necessary, the command also turns on a reference marker.

**Suffix:**

<n> [Window](#)

<m> [Marker](#)

**Parameters:**

<State> ON | OFF | 0 | 1

**OFF | 0**

Switches the function off

**ON | 1**

Switches the function on

**Manual operation:** See ["Band Power Measurement State"](#) on page 578  
See ["Switching All Band Power Measurements Off"](#) on page 579

**13.8.3.12 N db down marker**

The following commands control the n dB down markers.

<a href="#">CALCulate&lt;n&gt;:MARKer&lt;m&gt;:FUNCTION:NDBDown</a> .....	1311
<a href="#">CALCulate&lt;n&gt;:MARKer&lt;m&gt;:FUNCTION:NDBDown:FREQuency?</a> .....	1312
<a href="#">CALCulate&lt;n&gt;:MARKer&lt;m&gt;:FUNCTION:NDBDown:QFACTOR?</a> .....	1313
<a href="#">CALCulate&lt;n&gt;:MARKer&lt;m&gt;:FUNCTION:NDBDown:RESult?</a> .....	1313
<a href="#">CALCulate&lt;n&gt;:MARKer&lt;m&gt;:FUNCTION:NDBDown:STATe</a> .....	1314
<a href="#">CALCulate&lt;n&gt;:MARKer&lt;m&gt;:FUNCTION:NDBDown:TIME?</a> .....	1314

**CALCulate<n>:MARKer<m>:FUNCTION:NDBDown <Distance>**

Defines the distance of the n dB down markers to the reference marker.

**Suffix:**<n> [Window](#)<m> [Marker](#)**Parameters:**

<Distance> Distance of the temporary markers to the reference marker in dB.  
 For a positive offset, the markers T1 and T2 are placed *below* the active reference point.  
 For a negative offset (for example for notch filter measurements), the markers T1 and T2 are placed *above* the active reference point.

\*RST: 6dB  
 Default unit: DB

**Example:**

```
CALC:MARK:FUNC:NDBD 3dB
```

Sets the distance to the reference marker to 3 dB.

**CALCulate<n>:MARKer<m>:FUNCTION:NDBDown:FREQUENCY?**

Queries the position of the n dB down markers on the x-axis when measuring in the frequency domain.

To get a valid result, you have to perform a complete measurement with synchronization to the end of the measurement before reading out the result. This is only possible for single sweep mode.

See also [INITiate<n>:CONTinuous](#) on page 909.

**Suffix:**

&lt;n&gt; irrelevant

&lt;m&gt; irrelevant

**Return values:**

<Frequency> **<frequency 1>**  
 absolute frequency of the n dB marker to the left of the reference marker in Hz

**<frequency 2>**  
 absolute frequency of the n dB marker to the right of the reference marker in Hz.

**Example:**

```
INIT:CONT OFF
```

Switches to single sweep mode.

```
CALC:MARK:FUNC:NDBD ON
```

Switches on the n dB down function.

```
INIT;*WAI
```

Starts a sweep and waits for the end.

```
CALC:MARK:FUNC:NDBD:FREQ?
```

This command would return, for example, 100000000, 200000000, meaning that the first marker position is at 100 MHz, the second marker position is at 200 MHz



**Usage:** Query only

**Manual operation:** See "[n dB down Value](#)" on page 575

#### **CALCulate<n>:MARKer<m>:FUNCTion:NDBDown:QFACTOR?**

Queries the Q factor of n dB down measurements.

**Suffix:**

<n> irrelevant

<m> irrelevant

**Return values:**

<QFactor>

**Usage:** Query only

#### **CALCulate<n>:MARKer<m>:FUNCTion:NDBDown:RESult?**

Queries the distance of the n dB down markers from each other.

To get a valid result, you have to perform a complete measurement with synchronization to the end of the measurement before reading out the result. This is only possible for single sweep mode.

See also [INITiate<n>:CONTinuous](#) on page 909.

**Suffix:**

<n> irrelevant

<m> irrelevant

**Return values:**

<Distance>

The result depends on the span.

In case of frequency domain measurements, the command returns the bandwidth between the two n dB down markers in Hz.

In case of time domain measurements, the command returns the pulse width between the two n dB down markers in seconds.

**Example:**

```
INIT:CONT OFF
```

Switches to single sweep mode.

```
CALC:MARK:FUNC:NDBD ON
```

Switches on the n dB down function.

```
INIT;*WAI
```

Starts a sweep and waits for the end.

```
CALC:MARK:FUNC:NDBD:RES?
```

Outputs the measured value.

**Usage:** Query only

**Manual operation:** See "[n dB down Marker State](#)" on page 575

**CALCulate<n>:MARKer<m>:FUNCtion:NDBDown:STATe <State>**

Turns the n dB Down marker function on and off.

**Suffix:**

<n> irrelevant  
<m> irrelevant

**Parameters:**

<State> ON | OFF | 0 | 1  
**OFF | 0**  
Switches the function off  
**ON | 1**  
Switches the function on

**Example:** CALC:MARK:FUNC:NDBD:STAT ON  
Turns the n dB Down marker on.

**Manual operation:** See "[n dB down Marker State](#)" on page 575

**CALCulate<n>:MARKer<m>:FUNCtion:NDBDown:TIME?**

Queries the position of the n dB down markers on the x-axis when measuring in the time domain.

To get a valid result, you have to perform a complete measurement with synchronization to the end of the measurement before reading out the result. This is only possible for single sweep mode.

See also [INITiate<n>:CONTinuous](#) on page 909.

**Suffix:**

<n> irrelevant  
<m> irrelevant

**Return values:**

<TimeX1> absolute position in time of the n dB marker to the left of the reference marker in seconds  
<TimeX2> absolute position in time of the n dB marker to the right of the reference marker in seconds

**Example:** INIT:CONT OFF  
Switches to single sweep mode  
CALC:MARK:FUNC:NDBD ON  
Switches on the n dB down function.  
INIT;\*WAI  
Starts a sweep and waits for the end.  
CALC:MARK:FUNC:NDBD:TIME?  
Outputs the time values of the temporary markers.

**Usage:** Query only

**Manual operation:** See "[n dB down Value](#)" on page 575

### 13.8.3.13 Signal count marker

The following commands control the frequency counter.

<a href="#">CALCulate&lt;n&gt;:MARKer&lt;m&gt;:COUNT</a> .....	1315
<a href="#">CALCulate&lt;n&gt;:MARKer&lt;m&gt;:COUNT:FREQUency?</a> .....	1315
<a href="#">CALCulate&lt;n&gt;:MARKer&lt;m&gt;:COUNT:RESolution</a> .....	1316

---

#### **CALCulate<n>:MARKer<m>:COUNT <State>**

Turns the frequency counter at the marker position on and off.

The frequency counter works for one marker only. If you perform a frequency count with another marker, the FSW deactivates the frequency count of the first marker.

To get a valid result, you have to perform a complete measurement with synchronization to the end of the measurement before reading out the result. This is only possible for single sweep mode.

See also [INITiate<n>:CONTinuous](#) on page 909.

#### **Suffix:**

<n>                      [Window](#)

<m>                      [Marker](#)

#### **Parameters:**

<State>                      ON | OFF | 0 | 1  
**OFF | 0**  
 Switches the function off  
**ON | 1**  
 Switches the function on

#### **Example:**

```
INIT:CONT OFF
Switches to single sweep mode.
CALC:MARK ON
Switches on marker 1.
CALC:MARK:COUN ON
Switches on the frequency counter for marker 1.
INIT;*WAI
Starts a sweep and waits for the end.
CALC:MARK:COUN:FREQ?
Outputs the measured value.
```

**Manual operation:** See "[Signal Count Marker State](#)" on page 567

---

#### **CALCulate<n>:MARKer<m>:COUNT:FREQUency?**

Queries the frequency at the marker position.

To get a valid result, you have to perform a complete measurement with synchronization to the end of the measurement before reading out the result. This is only possible for single sweep mode.

See also [INITiate<n>:CONTinuous](#) on page 909.

Before you can use the command, you have to turn on the frequency counter.

**Suffix:**

<n> [Window](#)

<m> [Marker](#)

**Return values:**

<Frequency> Frequency at the marker position.

**Example:**

```
INIT:CONT OFF
Switches to single sweep mode.
CALC:MARK ON
Switches on marker 2.
CALC:MARK:COUN ON
Activates the frequency counter for marker 1.
INIT;*WAI
Starts a sweep and waits for the end.
CALC:MARK:COUN:FREQ?
Outputs the measured value of marker 1.
```

**Usage:** Query only

**Manual operation:** See ["Signal Count Marker State"](#) on page 567

**CALCulate<n>:MARKer<m>:COUNt:RESolution <Resolution>**

Defines the resolution of the frequency counter.

**Suffix:**

<n> [Window](#)

<m> [Marker](#)

**Parameters:**

<Resolution> 0.001 | 0.01 | 0.1 | 1 | 10 | 100 | 1000 | 10000 Hz  
 \*RST: 0.1 Hz  
 Default unit: HZ

**Example:**

```
CALC:MARK:COUN:RES 1kHz
Sets the resolution of the frequency counter to 1 kHz.
```

**Manual operation:** See ["Resolution"](#) on page 567

### 13.8.3.14 Marker demodulation

The following commands control the demodulation of AM and FM signals at the marker position.

Useful commands for marker demodulation described elsewhere:

- [SYSTEM:SPEaker:VOLume](#) on page 1190

**Remote commands exclusive to marker demodulation:**

CALCulate<n>:MARKer<m>:FUNCTion:DEModulation:CONTinuous.....	1317
CALCulate<n>:MARKer<m>:FUNCTion:DEModulation:HOLDoff.....	1317
CALCulate<n>:MARKer<m>:FUNCTion:DEModulation:SElect.....	1318
CALCulate<n>:MARKer<m>:FUNCTion:DEModulation[:STATE].....	1318
[SENSe:]DEMod:SQUelch:LEVel.....	1318
[SENSe:]DEMod:SQUelch[:STATE].....	1319

**CALCulate<n>:MARKer<m>:FUNCTion:DEModulation:CONTinuous <State>**

Turns continuous demodulation of the signal at the marker position in the frequency domain on and off.

In the time domain continuous demodulation is always on.

**Suffix:**

<n> [Window](#)

<m> [Marker](#)

**Parameters:**

<State> ON | OFF | 0 | 1

**OFF | 0**

Switches the function off

**ON | 1**

Switches the function on

**Example:**

CALC2:MARK3:FUNC:DEM:CONT ON

Switches on the continuous demodulation.

**Manual operation:** See "[Continuous Demodulation](#)" on page 581

**CALCulate<n>:MARKer<m>:FUNCTion:DEModulation:HOLDoff <Duration>**

Defines for how long the the signal at the marker position is demodulated.

In the time domain continuous demodulation is always on.

**Suffix:**

<n> [Window](#)

<m> [Marker](#)

**Parameters:**

<Duration> Range: 10 ms to 1000 s  
\*RST: Marker demodulation = OFF  
Default unit: S

**Example:**

CALC:MARK:FUNC:DEM:HOLD 3s

**Manual operation:** See "[Marker Stop Time](#)" on page 581

**CALCulate<n>:MARKer<m>:FUNction:DEModulation:SElect <DemodMode>**

Selects the demodulation mode at the marker position.

**Suffix:**

<n> [Window](#)

<m> [Marker](#)

**Parameters:**

<DemodMode> **AM**  
AM demodulation

**FM**  
FM demodulation

**PM**  
FM demodulation

**AC**  
AC video demodulation

**AUDio**  
Audio demodulation

\*RST: AM

**Example:** CALC:MARK:FUNC:DEM:SEL FM

**Manual operation:** See "[Modulation](#)" on page 581

**CALCulate<n>:MARKer<m>:FUNction:DEModulation[:STATe] <State>**

Turns the audio demodulator on and off when the measurement reaches a marker position.

**Suffix:**

<n> [Window](#)

<m> [Marker](#)

**Parameters:**

<State> ON | OFF | 0 | 1

**OFF | 0**  
Switches the function off

**ON | 1**  
Switches the function on

**Example:** CALC:MARK3:FUNC:DEM ON  
Switches on the demodulation for marker 3.

**Manual operation:** See "[Marker Demodulation State](#)" on page 581

**[SENSe:]DEMod:SQUelch:LEVel <Threshold>**

Defines the threshold for selective demodulation.

All signals below the threshold are not demodulated.

**Parameters:**

<Threshold> Percentage of the display height.  
 Range: 0 to 100  
 \*RST: 50

**Example:**

DEM:SQU:LEV 80  
 Sets the squelch level to 80% of the displayed signal.

**Manual operation:** See "[Squelch Level](#)" on page 582

**[SENSe:]DEMod:SQUelch[:STATe] <State>**

Turns selective demodulation at the marker position on and off.

For selective demodulation, the FSW turns on a video trigger whose level corresponds to the squelch level. Therefore it turns other triggers or gates off.

**Parameters:**

<State> ON | OFF | 0 | 1  
**OFF | 0**  
 Switches the function off  
**ON | 1**  
 Switches the function on

**Example:**

DEM:SQU ON  
 Signals below the level threshold are not sent to the audio output.

**Manual operation:** See "[Squelch](#)" on page 581

**13.8.3.15 Programming examples for using markers and marker functions**

Various programming examples on how to use markers and the special marker functions are provided here.



The use of spectrogram markers is demonstrated in [Chapter 13.8.2.7, "Programming example: configuring a spectrogram"](#), on page 1265.

- [Example: basic markers](#)..... 1320
- [Example: marker search in spectrograms](#)..... 1321
- [Basic frequency sweep measurement for marker function examples](#)..... 1322
- [Example: using a fixed reference marker](#)..... 1322
- [Example: obtaining a marker peak list](#)..... 1323
- [Example: measuring noise density](#)..... 1323
- [Example: measuring phase noise](#)..... 1324
- [Example: measuring the power in a channel using band power markers](#)..... 1325
- [Example: measuring characteristic bandwidths \(using the n db down marker\)](#).. 1325
- [Examples: demodulating marker values and providing audio output](#)..... 1326
- [Example: performing a highly accurate frequency measurement using the signal count marker](#)..... 1327

**Example: basic markers**

This example demonstrates how to configure and define markers for a basic spectrum measurement in a remote environment. It assumes that the basic frequency sweep described in [Chapter 13.16.1, "Programming example: performing a basic frequency sweep"](#), on page 1531 has been performed and thus does not begin by presetting the instrument.

```
//-----Configuring marker behavior -----
DISP:MTAB ON
//Marker information is always displayed in a separate table.
CALC:MARK:X:SSIZ STAN
//The marker moves from one pixel to the next instead of sweep points in manual op.
CALC:MARK:PEXC 6dB
//Defines a peak excursion of 6 dB.
CALC:MARK:X:SLIM ON
CALC:MARK:X:SLIM:LEFT 50MHz
CALC:MARK:X:SLIM:RIGH 150MHz
//Restricts the search area for peaks to the frequencies between 50 and 150 MHz.
CALC:THR -100dBm
CALC:THR:STAT ON
//Configures a threshold level for peak searches at -100 dBm.

//-----Defining and positioning markers -----
CALC:MARK1 ON
//Activates marker 1 and sets it to the peak of trace 1.
CALC:MARK2:TRAC 2
//Activates marker 2 and sets it to the peak of trace 2.
CALC:MARK3:X 150MHz
//Activates marker 3 and sets it to the freq. 150 MHz on trace 1.
CALC:MARK4:TRAC 4
//Activates marker 4 and sets it to the peak of trace 4.

CALC:MARK1:MAX:AUTO ON
//Moves M1 to the current peak of trace 1 after each sweep.
CALC:MARK2:MAX:NEXT
//Moves M2 to the next lower peak of trace 2.

CALC:DELT5 ON
CALC:DELT5:LINK ON
//Activates delta marker 5 and links it to marker 1. If M1 moves, so does D5.
CALC:DELT5:MREF 4
//Changes the reference for D5 to marker 4. D5 now shows the difference between
//the peak of trace 1 after each sweep and the value at the same position in
//trace 4, which is a copy of trace 1, averaged over 10 sweeps.
CALC:DELT5:MODE REL
//Shows the difference as relative values.

CALC:DELT6 ON
CALC:DELT6:MAX:NEXT
```



```

//Activates delta marker 6 and sets it to the next lower maximum of trace 1.
//Thus it shows the difference between the two highest peaks in trace 1.

//-----Retrieving marker values -----
CALC:MARK1:Y?
CALC:MARK2:Y?
CALC:MARK3:Y?
CALC:MARK4:Y?
CALC:DELT5:Y?
CALC:DELT6:Y?
//Retrieves the marker levels of each active normal and delta marker.
CALC:DELT5:X:REL?
CALC:DELT6:X:REL?
//Retrieves the frequency difference between the delta marker and marker 1.

//-----Deactivating all markers -----
//CALC:MARK:AOFF
//CALC:DELT:AOFF

```

### Example: marker search in spectrograms

This example demonstrates how to search for peak values in spectrograms in a remote environment. It assumes a spectrogram is already available (see [Chapter 13.8.2.7, "Programming example: configuring a spectrogram"](#), on page 1265) and thus does not begin by presetting the instrument.

```

//----- Analyzing the results using markers -----
//Set marker1 on the peak power in the most recent spectrum and query
//its position
CALC2:SPEC:FRAM:SEL 0
CALC2:MARK1 ON
CALC2:MARK1:X?
CALC2:MARK1:Y?

//Set marker2 on the peak power in frame at -324ms and query its position
CALC2:MARK2 ON
CALC2:MARK2:SGR:FRAM -324ms
CALC2:MARK2:X?
CALC2:MARK2:Y?

//Set marker3 on peak power level in the entire spectrogram in memory and
//query its position
CALC2:MARK3 ON
CALC2:MARK:SPEC:SAR MEM
CALC2:MARK3:SPEC:XY:MAX
CALC2:MARK3:X?
CALC2:MARK3:Y?

//Move marker 3 to the next lower peak level for the same frequency
CALC2:MARK3:SPEC:Y:MAX:NEXT
CALC2:MARK3:X?

```

```

CALC2:MARK3:Y?

//Set marker 4 to the highest level in the (visible) spectrogram.
CALC2:MARK:SPEC:SAR VIS
CALC2:MARK4:SPEC:XY:MAX
//Move marker 4 to the next higher level in the frames above its current position.
CALC2:MARK4:SPEC:Y:MAX:ABOV

```

### Basic frequency sweep measurement for marker function examples

Since markers can only be placed on an existing trace, the following example provides a simple frequency sweep measurement to be used as a basis for the subsequent marker function scripts.

```

//----- Configuring the basic frequency sweep -----
*RST
//Resets the instrument
INIT:CONT OFF
//Selects single sweep mode.
FREQ:CENT 100MHz
//Defines the center frequency
FREQ:SPAN 200MHz
//Sets the span to 100 MHz on either side of the center frequency.
DISP:TRAC1:Y:RLEV 0dBm
//Sets the reference level to 0 dBm.

//----- Performing the measurement -----
INIT;*WAI
//Performs a measurement and waits for it to end

```

### Example: using a fixed reference marker

This example demonstrates how to configure and use reference markers in a basic spectrum measurement in a remote environment. It assumes that the basic frequency sweep described in "[Basic frequency sweep measurement for marker function examples](#)" on page 1322 has been performed and thus does not begin by presetting the instrument.

```

//-----Configuring the reference marker -----
//Activate a fixed reference marker. It is set to the current maximum of trace 1.
CALC:DELT:FUNC:FIX ON
//Set the reference frequency to 128 MHz.
CALC:DELT:FUNC:FIX:RPO:X 128 MHZ
//Set the reference level to +30 dBm.
CALC:DELT:FUNC:FIX:RPO:Y 30 DBM

//Use the fixed reference marker as a reference for deltamarker 2
CALC:DELT2:MREF FIX

//Reset the reference marker to the current maximum of trace 1
CALC:DELT:FUNC:FIX:RPO:MAX
//Query the new position of the reference marker

```

```
CALC:DELT:FUNC:FIX:RPO:X?
CALC:DELT:FUNC:FIX:RPO:Y?
```

### Example: obtaining a marker peak list

This example demonstrates how to obtain a marker peak list in a basic spectrum measurement in a remote environment. It assumes that the basic frequency sweep described in ["Basic frequency sweep measurement for marker function examples"](#) on page 1322 has been performed and thus does not begin by presetting the instrument.

In this example, the peak search is restricted to the frequency range of 50 MHz to 150 MHz. The top 5 power levels with a peak excursion of 10dB and a minimum of -100 dBm are to be determined and displayed with their marker numbers. The results are sorted by frequency values. The resulting peak list is then exported to a file.

```
//----- Configuring the peak search -----
CALC:MARK:X:SLIM ON
CALC:MARK:X:SLIM:LEFT 50MHz
CALC:MARK:X:SLIM:RIGH 150MHz
CALC:MARK:PEXC 10DB
CALC:THR -100DBM
CALC:THR:STAT ON

CALC:MARK:FUNC:FPE:STAT ON
CALC:MARK:FUNC:FPE:LIST:SIZE 5
CALC:MARK:FUNC:FPE:SORT X
CALC:MARK:FUNC:FPE:ANN:LAB ON

//----- Retrieving results -----
CALC:MARK:FUNC:FPE:COUN?
CALC:MARK:FUNC:FPE:X?
CALC:MARK:FUNC:FPE:Y?

//----- Exporting the peak list -----
MMEM:STOR:PEAK 'PeakList'
```

### Example: measuring noise density

This example demonstrates how to measure noise density using noise markers in a basic spectrum measurement in a remote environment. It assumes that the basic frequency sweep described in ["Basic frequency sweep measurement for marker function examples"](#) on page 1322 has been performed and thus does not begin by presetting the instrument.

```
CALC:MARK1:FUNC:NOIS ON
//Switches on noise measurement at marker 1.

INIT;*WAI
//Performs a measurement and waits for it to end
```

```
CALC:MARK1:FUNC:NOIS:RES?
//Queries the measured noise level (per Hz bandwidth)
```

### Example: measuring phase noise

This example demonstrates how to measure phase noise using markers in a basic spectrum measurement in a remote environment. It assumes that the basic frequency sweep described in "[Basic frequency sweep measurement for marker function examples](#)" on page 1322 has been performed and thus does not begin by presetting the instrument.

```
//----- Configuring the phase noise marker -----
DET SAMP
//Switches to Sample detector

CALC:MARK1 ON
//Activates marker1 and sets it to the maximum power level

CALC:DELT:FUNC:PNO ON
//Activates phase noise marker function

CALC:DELT1 ON
CALC:DELT1:X 100kHz

CALC:DELT2 ON
CALC:DELT2:X 500kHz

CALC:DELT3 ON
CALC:DELT3:X 1MHz

CALC:DELT4 ON
CALC:DELT4:X 1.5MHz

//Activates the phase noise measurement function for offsets 100kHz/500kHz/1MHz/1.5MHz.

BAND:VID?
//Queries the used VBW (= 0.1*RBW)

//----- Querying the phase noise results -----

CALC:DELT1:FUNC:PNO:RES?
CALC:DELT2:FUNC:PNO:RES?
CALC:DELT3:FUNC:PNO:RES?
CALC:DELT4:FUNC:PNO:RES?
//Queries the difference in level between the peak and the noise power density
//measured at the deltamarkers, referred to the carrier power level (dBc)
```

**Example: measuring the power in a channel using band power markers**

This example demonstrates how to measure the power in a specific channel or band using markers in a basic spectrum measurement in a remote environment. It assumes that the basic frequency sweep described in ["Basic frequency sweep measurement for marker function examples"](#) on page 1322 has been performed and thus does not begin by presetting the instrument.

```
//----- Configuring the band power marker -----
CALC:MARK1 ON
//Activates marker1 and sets it to the maximum power level
CALC:MARK1:FUNC:BPOW:STAT ON
//Activates the band power measurement for the band around marker 1
CALC:MARK1:FUNC:BPOW:SPAN 30MHz
//Sets the bandwidth to be measured to 30 MHz
CALC:MARK1:FUNC:BPOW:MODE DENS
//Sets the result to be a density (power per Hz bandwidth)

CALC:DELT2 ON
//Activates deltamarker2
CALC:DELT2:FUNC:BPOW:STAT ON
//Activates the band power measurement for the band around deltamarker 2
CALC:DELT2:FUNC:BPOW:SPAN 30MHz
//Sets the bandwidth to be measured to 30 MHz
CALC:DELT2:FUNC:BPOW:MODE DENS
//Sets the result to be a density (power per Hz bandwidth)

CALC:DELT3 ON
//Activates deltamarker3
CALC:DELT3:FUNC:BPOW:STAT ON
//Activates the band power measurement for the band around deltamarker 3
CALC:DELT3:FUNC:BPOW:SPAN 30MHz
//Sets the bandwidth to be measured to 30 MHz
CALC:DELT3:FUNC:BPOW:MODE DENS
//Sets the result to be a density (power per Hz bandwidth)

//-----Retrieving Results-----
CALC:MARK1:FUNC:BPOW:RES?
//Returns the power sum for the specified bandwidth around marker 1.
CALC:DELT2:FUNC:BPOW:RES?
//Returns the power sum for the specified bandwidth around deltamarker 2.
CALC:DELT3:FUNC:BPOW:RES?
//Returns the power sum for the specified bandwidth around deltamarker 3.
```

**Example: measuring characteristic bandwidths (using the n db down marker)**

This example demonstrates how to measure a characteristic bandwidth using markers in a basic spectrum measurement in a remote environment. It assumes that the basic frequency sweep described in [Chapter 13.16.1, "Programming example: performing a basic frequency sweep"](#), on page 1531 has been performed and thus does not begin by presetting the instrument.

```
//----- Configuring the n dB down marker -----
CALC:MARK1 ON
//Activates marker1 and sets it to the maximum power level
CALC:MARK1:FUNC:NDBD 3DB
//Sets the level offset to 3 dB
CALC:MARK1:FUNC:NDBD:STAT ON
//Activates the n dB down measurement

//-----Retrieving Results-----
CALC:MARK:FUNC:NDBD:RES?
//Returns the bandwidth at the specified power offset.
CALC:MARK:FUNC:NDBD:FREQ?
//Returns the frequencies of the temporary markers at the power offsets
CALC:MARK:FUNC:NDBD:QFAC?
//Returns the quality factor of the resulting bandwidth
```

### Examples: demodulating marker values and providing audio output

The following examples demonstrate how to demodulate markers and provide audio output in a remote environment.

- [Example: providing audio output for individual marker values](#)..... 1326
- [Example: demodulating and providing audio output continuously](#)..... 1327

#### Example: providing audio output for individual marker values

This example demonstrates how to demodulate markers and provide audio output in a basic spectrum measurement in a remote environment. It assumes that the basic frequency sweep described in [Chapter 13.16.1, "Programming example: performing a basic frequency sweep"](#), on page 1531 has been performed and thus does not begin by presetting the instrument.

Audio output is provided for 5s each time the signal reaches its initial maximum, however only if it is higher than -90 dBm (10% of the total y-axis range) in order to ignore noise.

```
//----- Configuring the marker demodulation -----
CALC:MARK1 ON
//Activates marker1 and sets it to the maximum power level
CALC:MARK1:FUNC:DEM:SEL FM
//Selects FM demodulation
CALC:MARK1:FUNC:DEM:HOLD 5s
//Defines an output duration of 5s
DEM:SQU:LEV 10
//Sets a squelch level for noise
DEM:SQU ON
//Activates squelching
CALC:MARK1:FUNC:DEM ON
//Activates demodulation

//----- Performing the measurement -----
INIT;*WAI
```

```
//Performs a measurement and waits for it to end

//-----Retrieving Results-----
//Results are only provided as audio output!
```

### Example: demodulating and providing audio output continuously

This example demonstrates how to demodulate markers and provide audio output in a basic spectrum measurement in a remote environment. It assumes that the basic frequency sweep described in [Chapter 13.16.1, "Programming example: performing a basic frequency sweep"](#), on page 1531 has been performed and thus does not begin by presetting the instrument.

```
//----- Configuring the marker demodulation -----
CALC:MARK1 ON
//Activates marker1
CALC:MARK1:FUNC:DEM:SEL FM
//Selects FM demodulation
DEM:SQU:LEV 10
//Sets a squelch level for noise
DEM:SQU ON
//Activates squelching
CALC:MARK1:FUNC:DEM:CONT ON
//Activates continuous demodulation

//----- Performing the measurement -----
INIT:CONT ON
//Performs a measurement and provides continuous audio output

//-----Retrieving Results-----
//Results are only provided as audio output!
```

### Example: performing a highly accurate frequency measurement using the signal count marker

This example demonstrates how to determine highly accurate frequency values using signal count markers in a basic spectrum measurement in a remote environment. It assumes that the basic frequency sweep described in [Chapter 13.16.1, "Programming example: performing a basic frequency sweep"](#), on page 1531 has been performed and thus does not begin by presetting the instrument.

```
//----- Configuring the signal count marker -----
CALC:MARK1 ON
//Activates marker1
CALC:MARK1:COUN ON
//Switches on the frequency counter for marker 1.
CALC:MARK1:COUN:RES 1kHz
//Sets the resolution of the frequency counter to 1kHz

//----- Performing the measurement -----
INIT;*WAI
//Performs a measurement and waits for it to end
```

```
//-----Retrieving Results-----
CALC:MARK1:COUN:FREQ?
//Returns the signal counter value as the precise marker frequency.
```

### 13.8.4 Configuring display lines

The commands required to configure display lines in a remote environment are described here.

CALCulate<n>:DLINe<dl>	1328
CALCulate<n>:DLINe<dl>:STATe	1328
CALCulate<n>:FLINe<dl>	1329
CALCulate<n>:FLINe<dl>:STATe	1329
CALCulate<n>:TLINe<dl>	1329
CALCulate<n>:TLINe<dl>:STATe	1330

---

#### CALCulate<n>:DLINe<dl> <Position>

Defines the (horizontal) position of a display line.

##### Suffix:

<n> [Window](#)

<dl> 1 | 2

##### Parameters:

<Position> The value range is variable.  
You can use any unit you want, the FSW then converts the unit to the currently selected unit. If you omit a unit, the FSW uses the currently selected unit.

\*RST: (state is OFF)

Default unit: DBM

##### Example:

CALC:DLIN2 -20dBm

Positions the second display line at -20 dBm.

**Manual operation:** See "[Horizontal Line 1/ Horizontal Line 2](#)" on page 592

---

#### CALCulate<n>:DLINe<dl>:STATe <State>

Turns a display line on and off

##### Suffix:

<n> [Window](#)

<dl> 1 | 2

##### Parameters:

<State> ON | OFF | 0 | 1

**OFF | 0**

Switches the function off



**ON | 1**

Switches the function on

**Example:** `CALC:DLIN2:STAT ON`  
Turns on display line 2.

**CALCulate<n>:FLINe<dl> <Frequency>**

Defines the position of a frequency line.

**Suffix:**

<n> [Window](#)  
<dl> 1 to 4  
frequency line

**Parameters:**

<Frequency> Note that you can not set a frequency line to a position that is outside the current span.

Range: 0 Hz to Fmax  
\*RST: (STATe to OFF)  
Default unit: HZ

**Example:** `CALC:FLIN2 120MHz`  
Sets frequency line 2 to a frequency of 120 MHz.

**Manual operation:** See "[Vertical Line <x>](#)" on page 592

**CALCulate<n>:FLINe<dl>:STATe <State>**

Turns a frequency line on and off

**Suffix:**

<n> [Window](#)  
<dl> 1 to 4  
frequency line

**Parameters:**

<State> ON | OFF | 0 | 1  
**OFF | 0**  
Switches the function off  
**ON | 1**  
Switches the function on

**Example:** `CALC:FLIN2:STAT ON`  
Turns frequency line 2 on.

**CALCulate<n>:TLINe<dl> <Time>**

Defines the position of a time line.

**Suffix:**

<n> [Window](#)

<dl> 1 to 4  
time line

**Parameters:**

<Time> Note that you can not set a time line to a position that is higher than the current sweep time.

Range: 0 s to 1600 s

\*RST: (STATe to OFF)

Default unit: S

**Example:**

CALC:TLIN 10ms

Sets the first time line to 10 ms.

**Manual operation:** See "[Vertical Line <x>](#)" on page 592

**CALCulate<n>:TLINe<dl>:STATe <State>**

Turns a time line on and off

**Suffix:**

<n> [Window](#)

<dl> 1 to 4  
time line

**Parameters:**

<State> ON | OFF | 0 | 1

**OFF | 0**

Switches the function off

**ON | 1**

Switches the function on

**Example:**

CALC:TLIN:STAT ON

Turns the first time line on.

### 13.8.5 Defining limit checks

Note that in remote control, upper and lower limit lines are configured using separate commands. Thus, you must decide in advance which you want to configure. The x-values for both upper and lower limit lines are defined as a common control line. This control line is the reference for the y-values for both upper and lower limit lines.

- [Configuring limit lines](#)..... 1331
- [Managing limit lines](#)..... 1340
- [Checking the results of a limit check](#)..... 1343
- [Programming example: using limit lines](#)..... 1344

### 13.8.5.1 Configuring limit lines

CALCulate<n>:LIMit<li>:COMMeNt.....	1331
CALCulate<n>:LIMit<li>:CONTRol[:DATA].....	1331
CALCulate<n>:LIMit<li>:CONTRol:DOMain.....	1332
CALCulate<n>:LIMit<li>:CONTRol:MODE.....	1332
CALCulate<n>:LIMit<li>:CONTRol:OFFSet.....	1333
CALCulate<n>:LIMit<li>:CONTRol:SHIFt.....	1333
CALCulate<n>:LIMit<li>:CONTRol:SPACing.....	1333
CALCulate<n>:LIMit<li>:LOWer[:DATA].....	1334
CALCulate<n>:LIMit<li>:LOWer:MARGIn.....	1334
CALCulate<n>:LIMit<li>:LOWer:MODE.....	1334
CALCulate<n>:LIMit<li>:LOWer:OFFSet.....	1335
CALCulate<n>:LIMit<li>:LOWer:SHIFt.....	1335
CALCulate<n>:LIMit<li>:LOWer:SPACing.....	1336
CALCulate<n>:LIMit<li>:LOWer:STATe.....	1336
CALCulate<n>:LIMit<li>:LOWer:THReshold.....	1336
CALCulate<n>:LIMit<li>:NAME.....	1337
CALCulate<n>:LIMit<li>:UNIT.....	1337
CALCulate<n>:LIMit<li>:UPPer[:DATA].....	1337
CALCulate<n>:LIMit<li>:UPPer:MARGIn.....	1338
CALCulate<n>:LIMit<li>:UPPer:MODE.....	1338
CALCulate<n>:LIMit<li>:UPPer:OFFSet.....	1339
CALCulate<n>:LIMit<li>:UPPer:SHIFt.....	1339
CALCulate<n>:LIMit<li>:UPPer:SPACing.....	1339
CALCulate<n>:LIMit<li>:UPPer:STATe.....	1340
CALCulate<n>:LIMit<li>:UPPer:THReshold.....	1340

---

#### CALCulate<n>:LIMit<li>:COMMeNt <Comment>

Defines a comment for a limit line.

##### Suffix:

<n>	irrelevant
<li>	Limit line

##### Parameters:

<Comment>	String containing the description of the limit line.
-----------	------------------------------------------------------

**Manual operation:** See "[Comment](#)" on page 601

---

#### CALCulate<n>:LIMit<li>:CONTRol[:DATA] <LimitLinePoints>...

Defines the horizontal definition points of a limit line.

##### Suffix:

<n>	irrelevant
<li>	Limit line

**Parameters:**

<LimitLinePoints> Variable number of x-axis values.  
 Note that the number of horizontal values has to be the same as the number of vertical values set with `CALCulate<n>:LIMit<li>:LOWer[:DATA]` or `CALCulate<n>:LIMit<li>:UPPer[:DATA]`. If not, the FSW either adds missing values or ignores surplus values.  
 The unit is Hz or s.  
 \*RST: -  
 Default unit: HZ

**Manual operation:** See "Data Points" on page 602

**CALCulate<n>:LIMit<li>:CONTrol:DOMain <SpanSetting>**

Selects the domain of the limit line.

**Suffix:**

<n> irrelevant

<li> [Limit line](#)

**Parameters:**

<SpanSetting> FREQUENCY | TIME

**FREQUENCY**

For limit lines that apply to a range of frequencies.

**TIME**

For limit lines that apply to a period of time.

\*RST: FREQUENCY

**Example:**

`CALC:LIM:CONT:DOM FREQ`

Select a limit line in the frequency domain.

**Manual operation:** See "X-Axis" on page 602

**CALCulate<n>:LIMit<li>:CONTrol:MODE <Mode>**

Selects the horizontal limit line scaling.

**Suffix:**

<n> irrelevant

<li> [Limit line](#)

**Parameters:**

<Mode>

**ABSolute**

Limit line is defined by absolute physical values (Hz or s).

**RELative**

Limit line is defined by relative values related to the center frequency (frequency domain) or the left diagram border (time domain).

\*RST: ABSolute

**Manual operation:** See ["X-Axis"](#) on page 602

#### **CALCulate<n>:LIMit<li>:CONTRol:OFFSet <Offset>**

Defines an offset for a complete limit line.

Compared to shifting the limit line, an offset does not actually change the limit line definition points.

**Suffix:**

<n> irrelevant

<li> [Limit line](#)

**Parameters:**

<Offset> Numeric value.  
The unit depends on the scale of the x-axis.  
\*RST: 0  
Default unit: HZ

**Manual operation:** See ["X-Offset"](#) on page 599

#### **CALCulate<n>:LIMit<li>:CONTRol:SHIFt <Distance>**

Moves a complete limit line horizontally.

Compared to defining an offset, this command actually changes the limit line definition points by the value you define.

**Suffix:**

<n> irrelevant

<li> [Limit line](#)

**Parameters:**

<Distance> Numeric value.  
The unit depends on the scale of the x-axis.  
Default unit: HZ

**Manual operation:** See ["Shift x"](#) on page 603

#### **CALCulate<n>:LIMit<li>:CONTRol:SPACing <InterpolMode>**

Selects linear or logarithmic interpolation for the calculation of limit lines from one horizontal point to the next.

**Suffix:**

<n> [Window](#)

<li> [Limit line](#)

**Parameters:**

<InterpolMode> LINear | LOGarithmic  
\*RST: LIN

**Example:** `CALC:LIM:CONT:SPAC LIN`

**Manual operation:** See "[X-Axis](#)" on page 602

**CALCulate<n>:LIMit<li>:LOWer[:DATA] <LimitLinePoints>...**

Defines the vertical definition points of a lower limit line.

**Suffix:**

<n> irrelevant

<li> [Limit line](#)

**Parameters:**

<LimitLinePoints> Variable number of level values.  
 Note that the number of vertical values has to be the same as the number of horizontal values set with [CALCulate<n>:LIMit<li>:CONTRol\[:DATA\]](#). If not, the FSW either adds missing values or ignores surplus values.  
 The unit depends on [CALCulate<n>:LIMit<li>:UNIT](#) on page 1337.

\*RST: Limit line state is OFF

Default unit: DBM

**Manual operation:** See "[Data Points](#)" on page 602

**CALCulate<n>:LIMit<li>:LOWer:MARGin <Margin>**

Defines an area around a lower limit line where limit check violations are still tolerated.

**Suffix:**

<n> irrelevant

<li> [Limit line](#)

**Parameters:**

<Margin> **numeric value**

\*RST: 0

Default unit: dB

**Manual operation:** See "[Margin](#)" on page 602

**CALCulate<n>:LIMit<li>:LOWer:MODE <Mode>**

Selects the vertical limit line scaling.

**Suffix:**

<n> [Window](#)

<li> [Limit line](#)

**Parameters:**

<Mode>

**ABSolute**

Limit line is defined by absolute physical values.

The unit is variable.

**RELative**

Limit line is defined by relative values related to the reference level (dB).

\*RST: ABSolute

**Manual operation:** See "[Y-Axis](#)" on page 602

**CALCulate<n>:LIMit<li>:LOWer:OFFSet <Offset>**

Defines an offset for a complete lower limit line.

Compared to shifting the limit line, an offset does not actually change the limit line definition points.

**Suffix:**

<n>

[Window](#)

<li>

[Limit line](#)

**Parameters:**

<Offset>

Numeric value.

\*RST: 0

Default unit: dB

**Manual operation:** See "[Y-Offset](#)" on page 600

**CALCulate<n>:LIMit<li>:LOWer:SHIFt <Distance>**

Moves a complete lower limit line vertically.

Compared to defining an offset, this command actually changes the limit line definition points by the value you define.

**Suffix:**

<n>

[Window](#)

<li>

[Limit line](#)

**Parameters:**

<Distance>

Defines the distance that the limit line moves.

The unit depends on [CALCulate<n>:LIMit<li>:UNIT](#) on page 1337.

Default unit: DB

**Manual operation:** See "[Shift y](#)" on page 603

**CALCulate<n>:LIMit<li>:LOWer:SPACing** <InterpolType>

Selects linear or logarithmic interpolation for the calculation of a lower limit line from one horizontal point to the next.

**Suffix:**

<n> [Window](#)

<li> [Limit line](#)

**Parameters:**

<InterpolType> LINear | LOGarithmic

\*RST: LIN

**Manual operation:** See "[Y-Axis](#)" on page 602

**CALCulate<n>:LIMit<li>:LOWer:STATe** <State>

Turns a lower limit line on and off.

Before you can use the command, you have to select a limit line with [CALCulate<n>:LIMit<li>:NAME](#) on page 1337.

**Suffix:**

<n> irrelevant

<li> [Limit line](#)

**Parameters:**

<State> ON | OFF | 0 | 1

**OFF | 0**

Switches the function off

**ON | 1**

Switches the function on

**Manual operation:** See "[Visibility](#)" on page 599

**CALCulate<n>:LIMit<li>:LOWer:THReshold** <Threshold>

Defines a threshold for relative limit lines.

The FSW uses the threshold for the limit check, if the limit line violates the threshold.

**Suffix:**

<n> irrelevant

<li> [Limit line](#)

**Parameters:**

<Threshold> Numeric value.

The unit depends on [CALCulate<n>:LIMit<li>:UNIT](#) on page 1337.

\*RST: -200 dBm

Default unit: DBM



**Manual operation:** See ["Threshold"](#) on page 601

---

### CALCulate<n>:LIMit<li>:NAME <Name>

Selects a limit line that already exists or defines a name for a new limit line.

**Suffix:**

<n> [Window](#)

<li> [Limit line](#)

**Parameters:**

<Name> String containing the limit line name.

\*RST: REM1 to REM8 for lines 1 to 8

**Manual operation:** See ["Name"](#) on page 601

---

### CALCulate<n>:LIMit<li>:UNIT <Unit>

Defines the unit of a limit line.

**Suffix:**

<n> irrelevant

<li> [Limit line](#)

**Parameters:**

<Unit> DBM | DBPW | WATT | DBUV | DBMV | VOLT | DBUA | AMPere | DB | DBUV\_M | DBUA\_M | DBM\_hz | DBM\_mhz | DBUV\_mhz | DBMV\_mhz | DBUa\_mhz | DBUV\_m | DBUa\_m | DBUV\_mmhz | DBUa\_mmhz | DBPW\_mhz | DBPT\_mhz | DBPT | (unitless)

If you select a dB-based unit for the limit line, the command automatically turns the limit line into a relative limit line.

\*RST: DBM

**Manual operation:** See ["Y-Axis"](#) on page 602

---

### CALCulate<n>:LIMit<li>:UPPer[:DATA] <LimitLinePoints>...

Defines the vertical definition points of an upper limit line.

**Suffix:**

<n> irrelevant

<li> [Limit line](#)

**Parameters:**

<LimitLinePoints> Variable number of level values.  
 Note that the number of vertical values has to be the same as the number of horizontal values set with `CALCulate<n>:LIMit<li>:CONTRol[:DATA]`. If not, the FSW either adds missing values or ignores surplus values.  
 The unit depends on `CALCulate<n>:LIMit<li>:UNIT` on page 1337.  
 \*RST: Limit line state is OFF  
 Default unit: DBM

**Manual operation:** See "[Data Points](#)" on page 602

**CALCulate<n>:LIMit<li>:UPPer:MARGIn <Margin>**

Defines an area around an upper limit line where limit check violations are still tolerated.

**Suffix:**

<n> irrelevant  
 <li> [Limit line](#)

**Parameters:**

<Margin> **numeric value**  
 \*RST: 0  
 Default unit: dB

**Manual operation:** See "[Margin](#)" on page 602

**CALCulate<n>:LIMit<li>:UPPer:MODE <Mode>**

Selects the vertical limit line scaling.

**Suffix:**

<n> [Window](#)  
 <li> [Limit line](#)

**Parameters:**

<Mode> **ABSolute**  
 Limit line is defined by absolute physical values.  
 The unit is variable.  
**RELative**  
 Limit line is defined by relative values related to the reference level (dB).  
 \*RST: ABSolute

**Manual operation:** See "[Y-Axis](#)" on page 602

**CALCulate<n>:LIMit<li>:UPPer:OFFSet <Offset>**

Defines an offset for a complete upper limit line.

Compared to shifting the limit line, an offset does not actually change the limit line definition points.

**Suffix:**

<n> irrelevant

<li> [Limit line](#)

**Parameters:**

<Offset> Numeric value.

\*RST: 0

Default unit: dB

**Manual operation:** See "[Y-Offset](#)" on page 600

**CALCulate<n>:LIMit<li>:UPPer:SHIFt <Distance>**

Moves a complete upper limit line vertically.

Compared to defining an offset, this command actually changes the limit line definition points by the value you define.

**Suffix:**

<n> irrelevant

<li> [Limit line](#)

**Parameters:**

<Distance> Defines the distance that the limit line moves.

The unit depends on [CALCulate<n>:LIMit<li>:UNIT](#) on page 1337.

**Manual operation:** See "[Shift y](#)" on page 603

**CALCulate<n>:LIMit<li>:UPPer:SPACing <InterpolType>**

Selects linear or logarithmic interpolation for the calculation of an upper limit line from one horizontal point to the next.

**Suffix:**

<n> [Window](#)

<li> [Limit line](#)

**Parameters:**

<InterpolType> LINear | LOGarithmic

\*RST: LIN

**Manual operation:** See "[Y-Axis](#)" on page 602

**CALCulate<n>:LIMit<li>:UPPer:STATe <State>**

Turns an upper limit line on and off.

Before you can use the command, you have to select a limit line with [CALCulate<n>:LIMit<li>:NAME](#) on page 1337.

**Suffix:**

<n> irrelevant  
<li> [Limit line](#)

**Parameters:**

<State> ON | OFF | 0 | 1  
**OFF | 0**  
Switches the function off  
**ON | 1**  
Switches the function on

**Manual operation:** See "[Visibility](#)" on page 599

**CALCulate<n>:LIMit<li>:UPPer:THReshold <Limit>**

Defines an absolute limit for limit lines with a relative scale.

The FSW uses the threshold for the limit check, if the limit line violates the threshold.

**Suffix:**

<n> irrelevant  
<li> [Limit line](#)

**Parameters:**

<Limit> Numeric value.  
The unit depends on [CALCulate<n>:LIMit<li>:UNIT](#) on page 1337.  
\*RST: -200  
Default unit: dBm

**Manual operation:** See "[Threshold](#)" on page 601

**13.8.5.2 Managing limit lines**

Useful commands for managing limit lines described in the FSW User Manual:

- `M MEM:SEL[:ITEM]:LIN:ALL`
- `M MEM:STOR:TYPE`
- `M MEM:LOAD:TYPE`

**Remote commands exclusive to managing limit lines:**

<a href="#">CALCulate&lt;n&gt;:LIMit&lt;li&gt;:ACTive?</a> .....	1341
<a href="#">CALCulate&lt;n&gt;:LIMit&lt;li&gt;:COPY</a> .....	1341
<a href="#">CALCulate&lt;n&gt;:LIMit&lt;li&gt;:DELeTe</a> .....	1341

CALCulate<n>:LIMit<li>:STATe.....	1342
CALCulate<n>:LIMit<li>:TRACe<t>:CHECK.....	1342
MMEMy:LOAD<n>:LIMit.....	1343
MMEMy:STORe<n>:LIMit.....	1343

---

### CALCulate<n>:LIMit<li>:ACTive?

Queries the names of *all* active limit lines.

#### Suffix:

<n>                    irrelevant

<li>                    irrelevant

#### Return values:

<LimitLines>        String containing the names of all active limit lines in alphabetical order.

#### Example:

CALC:LIM:ACT?

Queries the names of all active limit lines.

#### Usage:

Query only

**Manual operation:** See "[Visibility](#)" on page 599

---

### CALCulate<n>:LIMit<li>:COPY <Line>

Copies a limit line.

#### Suffix:

<n>                    [Window](#)

<li>                    [Limit line](#)

#### Parameters:

<Line>                **1 to 8**  
number of the new limit line

#### <name>

String containing the name of the limit line.

#### Example:

CALC:LIM1:COPY 2

Copies limit line 1 to line 2.

CALC:LIM1:COPY 'FM2'

Copies limit line 1 to a new line named FM2.

**Manual operation:** See "[Copy Line](#)" on page 600

---

### CALCulate<n>:LIMit<li>:DELete

Deletes a limit line.

#### Suffix:

<n>                    [Window](#)

<li>                    [Limit line](#)

**Manual operation:** See ["Delete Line"](#) on page 600

---

### CALCulate<n>:LIMit<li>:STATe <State>

Turns the limit check for a specific limit line on and off.

To query the limit check result, use `CALCulate<n>:LIMit<li>:FAIL?`.

Note that a new command exists to activate the limit check and define the trace to be checked in one step (see `CALCulate<n>:LIMit<li>:TRACe<t>:CHECK` on page 1342).

**Suffix:**

<n>                    irrelevant

<li>                   [Limit line](#)

**Parameters:**

<State>                ON | OFF | 0 | 1  
**OFF | 0**  
 Switches the function off  
**ON | 1**  
 Switches the function on

**Example:**

`CALC:LIM:STAT ON`  
 Switches on the limit check for limit line 1.

**Manual operation:** See ["Disable All Lines"](#) on page 600

---

### CALCulate<n>:LIMit<li>:TRACe<t>:CHECK <State>

Turns the limit check for a specific trace on and off.

To query the limit check result, use `CALCulate<n>:LIMit<li>:FAIL?`.

Note that this command replaces the two commands from previous signal and spectrum analyzers (which are still supported, however):

- `CALCulate<n>:LIMit<li>:TRACe<t>` on page 1528
- `CALCulate<n>:LIMit<li>:STATe` on page 1342

**Suffix:**

<n>                    [Window](#)

<li>                   [Limit line](#)

<t>                    [Trace](#)

**Parameters:**

<State>                ON | OFF | 0 | 1  
**OFF | 0**  
 Switches the function off  
**ON | 1**  
 Switches the function on

**Example:** `CALC:LIM3:TRAC2:CHEC ON`  
Switches on the limit check for limit line 3 on trace 2.

**Manual operation:** See ["Traces to be Checked"](#) on page 599

#### **MMEMory:LOAD<n>:LIMit <FileName>**

Loads the limit line from the selected file in .CSV format.

**Suffix:**  
<n> irrelevant

**Parameters:**  
<FileName> String containing the path and name of the CSV import file.

**Example:** `MMEM:LOAD:LIM 'C:\TEST.CSV'`

**Manual operation:** See ["Import"](#) on page 603

#### **MMEMory:STORe<n>:LIMit <FileName>, <LimitLineName>**

Exports limit line data to an ASCII (CSV) file.

For details on the file format see [Chapter 8.4.2.4, "Reference: limit line file format"](#), on page 608.

**Suffix:**  
<n> irrelevant

**Parameters:**  
<FileName> String containing the path and name of the target file.  
<LimitLineName> Name of the limit line to be exported.

**Example:** `MMEM:STOR:LIM 'C:\TEST', 'UpperLimitLine'`  
Stores the limit line named "UpperLimitLine" in the file TEST.CSV.

**Manual operation:** See ["Export"](#) on page 603

### 13.8.5.3 Checking the results of a limit check

[CALCulate<n>:LIMit<li>:CLEar\[:IMMEDIATE\]](#)..... 1343  
[CALCulate<n>:LIMit<li>:FAIL?](#)..... 1344

#### **CALCulate<n>:LIMit<li>:CLEar[:IMMEDIATE]**

Deletes the result of the current limit check.

The command works on *all* limit lines in *all* measurement windows at the same time.

**Suffix:**  
<n> [Window](#)  
<li> irrelevant

**Example:**            `CALC:LIM:CLE`  
                          Deletes the result of the limit check.

---

### **CALCulate<n>:LIMit<li>:FAIL?**

Queries the result of a limit check in the specified window.

Note that for SEM measurements, the limit line suffix <li> is irrelevant, as only one specific SEM limit line is checked for the currently relevant power class.

To get a valid result, you have to perform a complete measurement with synchronization to the end of the measurement before reading out the result. This is only possible for single sweep mode.

See also `INITiate<n>:CONTinuous` on page 909.

#### **Suffix:**

<n>                    [Window](#)

<li>                   [Limit line](#)

#### **Return values:**

<Result>            **0**  
                          PASS  
                          **1**  
                          FAIL

**Example:**            `INIT;*WAI`  
                          Starts a new sweep and waits for its end.  
                          `CALC2:LIM3:FAIL?`  
                          Queries the result of the check for limit line 3 in window 2.

**Usage:**              Query only

**Manual operation:** See "[Limit Check <n>](#)" on page 252  
                          See "[Limit Check](#)" on page 287

#### **13.8.5.4 Programming example: using limit lines**

The following examples demonstrate how to work with limit lines in a remote environment.

- [Example: configuring limit lines](#)..... 1344
- [Example: performing a limit check](#)..... 1346

#### **Example: configuring limit lines**

This example demonstrates how to configure 2 limit lines - an upper and a lower limit - for a measurement in a remote environment.

```
//----- Configuing the limit lines -----
CALC:LIM1:NAME 'FM1'
//Names limit line 1 'FM1'.

CALC:LIM1:CONT:MODE ABS
```



## Analyzing measurements (basics)

```

//Selects absolute scaling for the horizontal axis.
CALC:LIM1:CONT 1 MHz,50MHz,100 MHz,150MHz,200MHz
//Defines 5 horizontal definition points for limit line 1.
CALC:LIM1:UPP:MODE ABS
//Selects an absolute vertical scale for limit line 1.
CALC:LIM1:UNIT DBM
//Selects the unit dBm for limit line 1.
CALC:LIM1:UPP -10,-5,0,-5,-10
//Defines 5 definition points for limit line 1.

CALC:LIM1:UPP:MARG 5dB
//Defines an area of 5 dB around limit line 1 where limit check violations
//are still tolerated.

CALC:LIM1:UPP:SHIF -10DB
//Shifts the limit line 1 by -10 dB.
CALC:LIM1:UPP:OFFS -3dB
//Defines an additional -3 dB offset for limit line 1.

CALC:LIM3:NAME 'FM3'
//Names limit line 3 'FM3'.

CALC:LIM3:LOW:MODE REL
//Selects a relative vertical scale for limit line 3.
CALC:LIM3:UNIT DB

CALC:LIM3:CONT 1 MHz,50MHz,100 MHz,150MHz,200MHz
//Defines 5 horizontal definition points for limit line 3.
CALC:LIM3:LOW -90,-60,-40,-60,-90
//Defines 5 definition points relative to the reference level for limit line 3.

CALC:LIM3:LOW:SHIF 2
//Shifts the limit line 3 by 2dB.
CALC:LIM3:LOW:OFFS 3
//Defines an additional 3 dB offset for limit line 3.

CALC:LIM3:LOW:THR -200DBM
//Defines a power threshold of -200dBm that must be exceeded for limit to be checked

CALC:LIM3:LOW:MARG 5dB
//Defines an area of 5dB around limit line 3 where limit check violations
//are still tolerated.

//----- Storing the limit lines -----
MMEM:SEL:CHAN:LIN:ALL ON
MMEM:STOR:TYPE CHAN
MMEM:STOR:STAT 1,'LimitLines_FM1_FM3'

```

**Example: performing a limit check**

This example demonstrates how to perform a limit check during a basic frequency sweep measurement in a remote environment. The limit lines configured in ["Example: configuring limit lines"](#) on page 1344 are assumed to exist and be active.

```
//-----Preparing the instrument -----
*RST
//Resets the instrument
INIT:CONT OFF
//Selects single sweep mode.

//-----Configuring the measurement -----
FREQ:CENT 100MHz
//Defines the center frequency
FREQ:SPAN 200MHz
//Sets the span to 100 MHz on either side of the center frequency.
SENS:SWE:COUN 10
//Defines 10 sweeps to be performed in each measurement.
DISP:TRAC1:Y:RLEV 0dBm
//Sets the reference level to 0 dBm.
TRIG:SOUR IFP
TRIG:LEV:IFP -10dBm
//Defines triggering when the second intermediate frequency rises to a level
//of -10 dBm.

//-----Configuring the Trace-----
DISP:TRAC2 ON
DISP:TRAC2:MODE AVER
DISP:TRAC3 ON
DISP:TRAC3:MODE MAXH
//Configures 3 traces: 1 (default): clear/write; 2: average; 3: max hold

//----- Configuring the limit check -----
MMEM:LOAD:TYPE REPL
MMEM:LOAD:STAT 1,'LimitLines_FM1_FM3'
//Loads the limit lines stored in 'LimitLines_FM1_FM3'
CALC:LIM1:NAME 'FM1'
CALC:LIM1:UPP:STAT ON
//Activates upper limit FM1 as line 1.
CALC:LIM3:NAME 'FM3'
CALC:LIM3:LOW:STAT ON
//Activates lower limit line FM3 as line 3.
CALC:LIM:ACT?
//Queries the names of all active limit lines
//Result: 'FM1,FM3'
CALC:LIM1:TRAC3:CHEC ON
//Activates the upper limit to be checked against trace3 (maxhold trace)
CALC:LIM3:TRAC2:CHEC ON
//Activates the upper limit to be checked against trace2 (average trace)
CALC:LIM:CLE
```

```
//Clears the previous limit check results

//----- Performing the measurement-----
INIT;*WAI
//Initiates a new measurement and waits until the last sweep has finished.

//----- Retrieving limit check results-----

CALC:LIM1:FAIL?
//Queries the result of the upper limit line check
CALC:LIM3:FAIL?
//Queries the result of the lower limit line check
```

## 13.9 Managing settings and results

The commands required to store and load instrument settings and import and export measurement results in a remote environment are described here.

The tasks for manual operation are described in [Chapter 10, "Data management"](#), on page 674.

### Addressing drives

The various drives can be addressed via the "mass storage instrument specifier" <msis> using the conventional Windows syntax. The internal hard disk is addressed by "C:".

For details on storage locations refer to [Chapter 10.3.2.2, "Storage location and file-name"](#), on page 682.

The file names (<FileName> parameter) are given as string parameters enclosed in quotation marks. They also comply with Windows conventions. Windows file names do not distinguish between uppercase and lowercase notation.

### Wildcards

The two characters "\*" and "?" can be used as "wildcards", i.e., they are variables for a selection of several files. The question mark "?" replaces exactly one character, the asterisk replaces any of the remaining characters in the file name. "\*.\*" thus means all files in a directory.

### Path names

Storage locations can be specified either as absolute (including the entire path) or relative paths (including only subfolders of the current folder). Use the `MMEM:CDIR?` query to determine the current folder.



### Secure user mode

In secure user mode, settings that are to be stored on the instrument are stored to volatile memory, which is restricted to 256 MHz. Thus, a "Memory full" error may occur although the hard disk indicates that storage space is still available.

- [General data storage and loading commands](#)..... 1348
- [Selecting the items to store](#)..... 1354
- [Storing and loading instrument settings](#)..... 1357
- [Storing or printing screenshots](#)..... 1362
- [Storing measurement results](#)..... 1372
- [Test reports](#)..... 1375
- [Examples: managing data](#)..... 1385

## 13.9.1 General data storage and loading commands

The following commands are available for all applications.

See also:

- [FORMat \[ : DATA \]](#) on page 1258

<a href="#">FORMat:DEXPort:DSEPARATOR</a> .....	1348
<a href="#">MMEMory:CATalog</a> .....	1349
<a href="#">MMEMory:CATalog:LONG</a> .....	1349
<a href="#">MMEMory:CDIRectory</a> .....	1350
<a href="#">MMEMory:COMMent</a> .....	1350
<a href="#">MMEMory:COPIE</a> .....	1350
<a href="#">MMEMory:DATA</a> .....	1351
<a href="#">MMEMory:DELeTe:IMMEDIATE</a> .....	1351
<a href="#">MMEMory:MDIRectory</a> .....	1351
<a href="#">MMEMory:MOVE</a> .....	1352
<a href="#">MMEMory:MSIS</a> .....	1352
<a href="#">MMEMory:NAME</a> .....	1352
<a href="#">MMEMory:NETWork:DISConnect</a> .....	1352
<a href="#">MMEMory:NETWork:MAP</a> .....	1353
<a href="#">MMEMory:NETWork:UNUSeddrives</a> .....	1353
<a href="#">MMEMory:NETWork:USEDdrives</a> .....	1353
<a href="#">MMEMory:RDIRectory</a> .....	1354

---

### FORMat:DEXPort:DSEPARATOR <Separator>

Selects the decimal separator for data exported in ASCII format.

#### Parameters:

<Separator>

POINT | COMMa

#### COMMa

Uses a comma as decimal separator, e.g. 4,05.

#### POINT

Uses a point as decimal separator, e.g. 4.05.

**\*RST:** \*RST has no effect on the decimal separator.  
Default is POINT.

**Example:** FORM:DEXP:DSEP POIN  
Sets the decimal point as separator.

**Manual operation:** See ["Saving the Result Summary \(Evaluation List\) to a File"](#) on page 266  
See ["Save Evaluation List"](#) on page 290  
See ["Export Peak List"](#) on page 585  
See ["Decimal Separator"](#) on page 652

### **MMEMory:CATalog** <FileName>

This command returns the contents of a particular directory.

**Parameters:**

<FileName> String containing the path and directory  
If you leave out the path, the command returns the contents of the directory selected with [MMEMory:CDIRectory](#) on page 1350.  
The path may be relative or absolute. Using wildcards (\*) is possible to query a certain type of files only.  
If you use a specific file as a parameter, the command returns the name of the file if the file is found in the specified directory, or an error if the file is not found ("-256, "File name not found").

**Example:** MMEM:CAT? 'C:\Data\SPOOL?.PNG'  
Returns all files in C:\Data\ whose names start with SPOOL, have 6 characters and the extension .PNG, e.g.:  
SPOOL1.PNG, SPOOL2.PNG, SPOOL3.PNG

**Example:** MMEM:CAT? 'C:\Data\SPOOL6.PNG'  
Query whether the file 'SPOOL6.PNG' also exists in the directory;  
**Result:**  
-256, "File name not found;:MMEMory:CATalog?  
'C:\Data\SPOOL6.PNG'

**Manual operation:** See ["Selecting Storage Location - Drive/ Path/ Files"](#) on page 263

### **MMEMory:CATalog:LONG** <Directory>

This command returns the contents of a particular directory with additional information about the files.

**Parameters:**

<Directory> String containing the path and directory.  
 If you leave out the path, the command returns the contents of the directory selected with [MMEMory:CDIRectory](#) on page 1350.  
 The path may be relative or absolute. Using wildcards ("\*") is possible to query a certain type of files only.

**MMEMory:CDIRectory** <Directory>

This command changes the current directory.

**Parameters:**

<Directory> String containing the path to another directory.  
 The path may be relative or absolute.

**MMEMory:COMMeNt** <Comment>

Defines a comment for the stored settings.

**Parameters:**

<Comment> String containing the comment.

**Example:**

```
MMEMory:COMMeNt "ACP measurement with Standard Tetra from 23.05."
```

```
MMEMory::MMEMory:STORel:STATe 1, "ACP_T"
```

As a result, in the selection list for recall settings, the comment "ACP measurement with Standard Tetra from 23.05." is added to the ACP entry.

**Manual operation:** See ["Comment"](#) on page 684

**MMEMory:COpy** <FileName>, <FileName>

This command copies one or more files to another directory.

**Parameters:**

<FileName> String containing the path and file name of the source file.  
 Special behavior if optional external mixer is active and the destination is C:\R\_S\INSTR\USER\cv1\: the contents of the entire folder are copied. For details, see ["Conversion loss tables"](#) on page 414.

<FileName> String containing the path and name of the target file.  
 The path may be relative or absolute.

**Manual operation:** See ["Import Table"](#) on page 431

---

**MMEMory:DATA** <FileName>[, <Data>]

**MMEMory:DATA?** <FileName>

This command writes block data into a file. The delimiter must be set to EOI to obtain error-free data transfer.

When you query the contents of a file, you can save them in a file on the remote control computer.

The command is useful for reading stored settings files or trace data from the instrument or for transferring them to the instrument

**Parameters:**

<Data>	<block_data> Data block with the following structure. <b>#</b> Hash sign. <b>&lt;number&gt;</b> Length of the length information. <b>&lt;number&gt;</b> Length information of the binary data (number of bytes). <b>&lt;data&gt;</b> Binary data with the indicated <number> of bytes.
--------	-------------------------------------------------------------------------------------------------------------------------------------------------------------------------------------------------------------------------------------------------------------------------------------------------------------------

**Parameters for setting and query:**

<FileName>

**Example:**

```
MMEM:NAME '\Public\User\Testfile.txt'
```

Creates a new file called 'testfile.txt'.

```
MMEM:DATA 'Testfile.txt',#220Contents of the file
```

The parameter means:

- #2: hash sign and length of the length information (20 bytes = 2 digits)
- 20: indicates the number of subsequent binary data bytes.

Contents of the file: store 20 binary bytes (characters) to the file.

```
MMEM:DATA? 'Testfile.txt'
```

Returns the contents of the file.

---

**MMEMory:DELeTe:IMMEDIATE** <FileName>

This command deletes a file.

**Parameters:**

<FileName>	String containing the path and file name of the file to delete. The path may be relative or absolute.
------------	----------------------------------------------------------------------------------------------------------

---

**MMEMory:MDIRectory** <Directory>

This command creates a new directory.

**Parameters:**

<Directory> String containing the path and new directory name  
The path may be relative or absolute.

**MMEMory:MOVE** <FileName>, <FileName>

This command moves a file to another directory.

The command also renames the file if you define a new name in the target directory.

If you do not include a path for <NewFileName>, the command just renames the file.

**Parameters:**

<FileName> String containing the path and file name of the source file.

<FileName> String containing the path and name of the target file.

**Example:**

```
MMEM:MOVE 'C:\TEST01.CFG', 'SETUP.CFG'
```

Renames TEST01.CFG in SETUP.CFG in directory C:\.

**MMEMory:MSIS** <Drive>

This command selects the default storage device used by all MMEMory commands.

**Parameters:**

<Drive> 'A:' | 'C:' | ... | 'Z:'

String containing the device drive name

\*RST: n.a.

**MMEMory:NAME** <FileName>

This command has several purposes, depending on the context it is used in.

- It creates a new and empty file.
- It defines the file name for screenshots taken with `HCOPY[:IMMEDIATE]`. Note that you have to route the printer output to a file.

**Parameters:**

<FileName> String containing the path and name of the target file.

**Example:**

```
MMEM:NAME 'C:\Data\PRINT1.BMP'
```

Selects the file name.

**Manual operation:** See "[Report Path](#)" on page 714

See "[Save](#)" on page 723

**MMEMory:NETWork:DISConnect** <Drive>[, <State>]

This command disconnects a network drive.



**Parameters:**

<Drive>	String containing the drive name.
<State>	1   0   ON   OFF Optional: determines whether disconnection is forced or not <b>1   ON</b> Disconnection is forced. <b>0   OFF</b> Disconnect only if not in use. *RST: 0

---

**MMEMory:NETWork:MAP** <FilePath>, <IP>[, <UserName>, <Password>, <State>]

This command maps a drive to a server or server directory of the network.

Note that you have to allow sharing for a server or folder in Microsoft networks first.

**Parameters:**

<FilePath>	String containing the drive name or path of the directory you want to map.
<IP>	String containing the host name of the computer or the IP address and the share name of the drive. '<host name or IP address\share name>'
<UserName>	String containing a user name in the network. The user name is optional.
<Password>	String containing the password corresponding to the <User-Name>. The password is optional.
<State>	ON   OFF   1   0 <b>ON   1</b> Reconnects at logon with the same user name. <b>OFF   0</b> Does not reconnect at logon.

---

**MMEMory:NETWork:UNUSeddrives**

This command returns a list of unused network drives.

---

**MMEMory:NETWork:USEDdrives** [<State>]

This command returns a list of all network drives in use.

**Parameters:**

<State>	You do not have to use the parameter. If you do not include the parameter, the command returns a list of all drives in use. This is the same behavior as if you were using the parameter OFF.
---------	-----------------------------------------------------------------------------------------------------------------------------------------------------------------------------------------------

**ON | 1**

Returns a list of all drives in use including the folder information.

**OFF | 0**

Returns a list of all drives in use.

**MMEemory:RDIRECTory** <Directory>

This command deletes the indicated directory.

**Parameters:**

<Directory>

String containing the path of the directory to delete.

Note that the directory you want to remove must be empty.

### 13.9.2 Selecting the items to store

The following commands select the items to be included in the configuration file.

Depending on the used command, either the items from the entire instrument (MMEemory:SElect[:ITEM] . . .), or only those from the currently selected channel (MMEemory:SElect:CHANnel[:ITEM] . . .) are stored.

MMEemory:SElect:CHANnel[:ITEM]:ALL.....	1354
MMEemory:SElect[:ITEM]:ALL.....	1354
MMEemory:SElect:CHANnel[:ITEM]:DEFault.....	1355
MMEemory:SElect[:ITEM]:DEFault.....	1355
MMEemory:SElect:CHANnel[:ITEM]:HWSettings.....	1355
MMEemory:SElect[:ITEM]:HWSettings.....	1355
MMEemory:SElect:CHANnel[:ITEM]:LINes:ALL.....	1355
MMEemory:SElect[:ITEM]:LINes:ALL.....	1355
MMEemory:SElect:CHANnel[:ITEM]:NONE.....	1356
MMEemory:SElect[:ITEM]:NONE.....	1356
MMEemory:SElect:CHANnel[:ITEM]:SCData.....	1356
MMEemory:SElect[:ITEM]:SCData.....	1356
MMEemory:SElect:CHANnel[:ITEM]:SPECtrogram.....	1356
MMEemory:SElect:CHANnel[:ITEM]:SGRam.....	1356
MMEemory:SElect[:ITEM]:SPECtrogram.....	1356
MMEemory:SElect[:ITEM]:SGRam.....	1356
MMEemory:SElect:CHANnel[:ITEM]:TRACe[:ACTive].....	1357
MMEemory:SElect[:ITEM]:TRACe<1...3>[:ACTive].....	1357
MMEemory:SElect:CHANnel[:ITEM]:TRANsducer:ALL.....	1357
MMEemory:SElect[:ITEM]:TRANsducer:ALL.....	1357

**MMEemory:SElect:CHANnel[:ITEM]:ALL****MMEemory:SElect[:ITEM]:ALL**

This command includes all items when storing or loading a configuration file.

The items are:

- Hardware configuration: `MMEemory:SElect[:ITEM]:HWSettings` on page 1355

- Limit lines: `MMEMory:SElect[:ITEM]:LINes:ALL` on page 1355
- Spectrogram data: `MMEMory:SElect[:ITEM]:SGRam` on page 1356
- Trace data: `MMEMory:SElect[:ITEM]:TRACe<1...3>[:ACTive]` on page 1357
- Transducers: `MMEMory:SElect[:ITEM]:TRANsducer:ALL` on page 1357

**Example:** `MMEM:SEL:ALL`

**Manual operation:** See "[Items:](#)" on page 684

**MMEMory:SElect:CHANnel[:ITEM]:DEFault**  
**MMEMory:SElect[:ITEM]:DEFault**

This command selects the current settings as the only item to store to and load from a configuration file.

**Manual operation:** See "[Items:](#)" on page 684

**MMEMory:SElect:CHANnel[:ITEM]:HWSettings <State>**  
**MMEMory:SElect[:ITEM]:HWSettings <State>**

This command includes or excludes measurement (hardware) settings when storing or loading a configuration file.

Measurement settings include:

- general channel configuration
- measurement hardware configuration including markers
- limit lines  
 Note that a configuration may include no more than 8 limit lines. This number includes active limit lines as well as inactive limit lines that were used last. Therefore the combination of inactivate limit lines depends on the sequence of use with `MMEMory:LOAD:STATe` on page 1358.
- color settings
- configuration for the hardcopy output

**Parameters:**

<State>            ON | OFF | 0 | 1  
                   \*RST:        1

**Example:** `MMEM:SEL:HWS ON`

**Manual operation:** See "[Items:](#)" on page 684

**MMEMory:SElect:CHANnel[:ITEM]:LINes:ALL <State>**  
**MMEMory:SElect[:ITEM]:LINes:ALL <State>**

This command includes or excludes all limit lines (active and inactive) when storing or loading a configuration file.

**Parameters:**

<State> ON | OFF | 1 | 0  
 \*RST: 0

**Example:**

MMEM:SEL:LIN:ALL ON

**Manual operation:** See ["Items:"](#) on page 684

**MMEMory:SElect:CHANnel[:ITEM]:NONE****MMEMory:SElect[:ITEM]:NONE**

This command does not include any of the following items when storing or loading a configuration file.

- Hardware configuration: [MMEMory:SElect\[:ITEM\]:HWSettings](#) on page 1355
- Limit lines: [MMEMory:SElect\[:ITEM\]:LINES:ALL](#) on page 1355
- Spectrogram data: [MMEMory:SElect\[:ITEM\]:SGRam](#) on page 1356
- Trace data: [MMEMory:SElect\[:ITEM\]:TRACe<1...3>\[:ACTIVE\]](#) on page 1357
- Transducers: [MMEMory:SElect\[:ITEM\]:TRANsducer:ALL](#) on page 1357

**Example:**

MMEM:SEL:NONE

**Manual operation:** See ["Items:"](#) on page 684

**MMEMory:SElect:CHANnel[:ITEM]:SCData <State>****MMEMory:SElect[:ITEM]:SCData <State>**

This command includes or excludes source calibration data for an optional external generator when storing or loading a configuration file.

**Parameters:**

<State> ON | OFF | 1 | 0  
 \*RST: 0

**Example:**

MMEM:SEL:SCD ON

Adds the source calibration data to the list of data subsets.

**Manual operation:** See ["Items:"](#) on page 684

**MMEMory:SElect:CHANnel[:ITEM]:SPECTrogram <State>****MMEMory:SElect:CHANnel[:ITEM]:SGRam <State>****MMEMory:SElect[:ITEM]:SPECTrogram <State>****MMEMory:SElect[:ITEM]:SGRam <State>**

This command includes or excludes spectrogram data when storing or loading a configuration file.

**Parameters:**

<State> ON | OFF | 1 | 0  
 \*RST: 0

**Example:** `MMEM:SEL:SGR ON`  
Adds the spectrogram data to the list of data subsets.

**Manual operation:** See ["Items:"](#) on page 684

**MMEMemory:SElect:CHANnel[:ITEM]:TRACe[:ACTive] <State>**  
**MMEMemory:SElect[:ITEM]:TRACe<1...3>[:ACTive] <State>**

This command includes or excludes trace data when storing or loading a configuration file.

**Suffix:**  
<1...3> irrelevant

**Parameters:**  
<State> ON | OFF | 1 | 0  
\*RST: 0, i.e. no traces are stored

**Example:** `MMEM:SEL:TRAC ON`

**Manual operation:** See ["Items:"](#) on page 684

**MMEMemory:SElect:CHANnel[:ITEM]:TRANsducer:ALL <State>**  
**MMEMemory:SElect[:ITEM]:TRANsducer:ALL <State>**

This command includes or excludes transducer factors when storing or loading a configuration file.

**Parameters:**  
<State> ON | OFF | 1 | 0  
\*RST: 0

**Example:** `MMEM:SEL:TRAN:ALL ON`

**Manual operation:** See ["Items:"](#) on page 684  
See ["Save"](#) on page 761

### 13.9.3 Storing and loading instrument settings

See also:

- [INSTrument\[:SElect\]](#) on page 902 to select the channel.

<a href="#">MMEMemory:CLEar:ALL</a> .....	1358
<a href="#">MMEMemory:CLEar:STATe</a> .....	1358
<a href="#">MMEMemory:LOAD:AUTO</a> .....	1358
<a href="#">MMEMemory:LOAD:STATe</a> .....	1358
<a href="#">MMEMemory:LOAD:TYPE</a> .....	1359
<a href="#">MMEMemory:STORe&lt;1 2&gt;:STATe</a> .....	1360
<a href="#">MMEMemory:STORe&lt;1 2&gt;:STATe:NEXT</a> .....	1360
<a href="#">MMEMemory:STORe&lt;1 2&gt;:TYPE</a> .....	1361
<a href="#">SYSTem:PRESet</a> .....	1361
<a href="#">SYSTem:PRESet:CHANnel[:EXEC]</a> .....	1362

**MMEMory:CLEar:ALL**

This command deletes all instrument configuration files in the current directory.

You can select the directory with `MMEMory:CDIRectory` on page 1350.

**Example:** `MMEM:CLE:ALL`

**MMEMory:CLEar:STATe <1>, <FileName>**

This command deletes an instrument configuration file.

**Parameters:**

<1>

<FileName> String containing the path and name of the file to delete. The string may or may not contain the file's extension.

**Example:** `MMEM:CLE:STAT 1, 'TEST'`

**MMEMory:LOAD:AUTO <1>, <FileName>**

This command restores an instrument configuration and defines that configuration as the default state.

The default state is restored after a preset (`*RST`) or after you turn on the FSW.

**Parameters:**

<1>

<FileName> **'Factory'**  
Restores the factory settings as the default state.

**'<file\_name>'**  
String containing the path and name of the configuration file. Note that only *instrument* settings files can be selected for the startup recall function; channel files cause an error.

**Example:** `MMEM:LOAD:AUTO 1, 'C:\R_S\INSTR\USER\TEST'`

**Manual operation:** See "[Startup Recall](#)" on page 686

**MMEMory:LOAD:STATe <1>, <FileName>**

This command restores and activates the instrument configuration stored in a \*.dfl file.

Note that files with other formats cannot be loaded with this command.

The contents that are reloaded from the file are defined by the last selection made either in the "Save/Recall" dialogs (manual operation) or through the `MMEMory:SELEct[:ITEM]` commands (remote operation; the settings are identical in both cases).

By default, the selection is limited to the user settings ("User Settings" selection in the dialogs, `HWSettings` in SCPI). The selection is not reset by `[Preset]` or `*RST`.

As a consequence, the results of a SCPI script using the `MMEMemory:LOAD:STATe` command without a previous `MMEMemory:SElect[:ITEM]` command may vary, depending on previous actions in the GUI or in previous scripts, even if the script starts with the `*RST` command.

It is therefore recommended that you use the appropriate `MMEMemory:SElect[:ITEM]` command before using `MMEMemory:LOAD:STATe`.

**Parameters:**

<1>

<FileName> String containing the path and name of the file to load.  
The string may or may not include the file's extension.

**Example:**

```
MMEM:SEL:ALL
//Save all items (User Settings, All Traces, All Limit Lines) from
the FSW.
MMEM:LOAD:STAT 1, 'C:\R_S\INSTR\USER\TEST01'
//Reloads all items
In the "Recall" dialog, select only "User Settings" and "All Limit
Lines".
MMEM:LOAD:STAT 1, 'C:\R_S\INSTR\USER\TEST01'
//Reloads user settings and all limit lines.
*RST
//Reset instrument.
MMEM:LOAD:STAT 1, 'C:\R_S\INSTR\USER\TEST01'
//Selected items are retained. Reloads user settings and all limit
lines.
Restart the instrument.
(Switch the [ON/OFF] key off and on).
MMEM:LOAD:STAT 1, 'C:\R_S\INSTR\USER\TEST01'
// Selected items are set to default. Reloads only the user set-
tings.
```

**Manual operation:** See ["Recall"](#) on page 681  
See ["Recall in New Channel / Recall in Current Channel"](#)  
on page 685

---

**MMEMemory:LOAD:TYPE** <Type>

This command defines whether the channels that will be loaded with the subsequent `MMEMemory:LOAD:STAT` command will replace the current channel or activate a new channel.

**Parameters:**

<Type> NEW | REPLace

**NEW**  
The loaded settings will be activated in a new channel.

**REPLace**  
The loaded settings will replace the currently active channel.

\*RST: NEW

**Example:**

```

INST:SEL 'SPECTRUM2'
//Selects channel 'SPECTRUM2'.
MMEM:STOR:TYP CHAN
//Specifies that channel data is to be stored.
MMEM:STOR:STAT 1, 'C:\Analyzer\Spectrum'
//Stores the settings from channel
//'SPECTRUM2' to the file 'C:\Analyzer\Spectrum'.
MMEM:LOAD:TYPE NEW
//Specifies that channels are to be loaded
//in a new channel.
MMEM:LOAD:STAT 1, 'C:\Analyzer\Spectrum'
//Loads the channel from the file
//'C:\Analyzer\Spectrum' to the new channel
//'SPECTRUM2*'.

```

---

### MMEMory:STORe<1|2>:STATe <1>, <FileName>

This command saves the current instrument configuration in a \*.df1 file.

#### Secure User Mode

In secure user mode, settings that are stored on the instrument are stored to volatile memory, which is restricted to 256 MB. Thus, a "memory limit reached" error can occur although the hard disk indicates that storage space is still available.

To store data permanently, select an external storage location such as a USB memory device.

For details, see [Chapter 4.2.15, "Protecting data using the secure user mode"](#), on page 39.

#### Suffix:

<1|2>                      irrelevant

#### Parameters:

<1>

<FileName>                String containing the path and name of the target file.  
The file extension is .df1.

**Example:**                MMEM:STOR:STAT 1, 'Save'  
Saves the current instrument settings in the file Save.df1.

**Manual operation:**    See ["Save File"](#) on page 685  
See ["Save"](#) on page 761

---

### MMEMory:STORe<1|2>:STATe:NEXT

This command saves the current instrument configuration in a \*.df1 file.

The file name depends on the one you have set with [MMEMory:STORe<1|2>:STATe](#) on page 1360. This command adds a consecutive number to the file name.

#### Secure User Mode



In secure user mode, settings that are stored on the instrument are stored to volatile memory, which is restricted to 256 MB. Thus, a "memory limit reached" error can occur although the hard disk indicates that storage space is still available.

To store data permanently, select an external storage location such as a USB memory device.

For details, see [Chapter 4.2.15, "Protecting data using the secure user mode"](#), on page 39.

**Suffix:**  
 <1|2> irrelevant

**Example:**  
 MMEM:STOR:STAT 1, 'Save '  
 Saves the current instrument settings in the file Save.dfl.  
 MMEM:STOR:STAT:NEXT  
 Saves the current instrument settings in the file Save\_001.dfl  
 MMEM:STOR:STAT:NEXT  
 Saves the current instrument settings in the file Save\_002.dfl

**Manual operation:** See ["Save File"](#) on page 685

### MMEMory:STORe<1|2>:TYPE <Type>

This command defines whether the data from the entire instrument or only from the current channel is stored with the subsequent MMEM:STOR... command.

**Suffix:**  
 <1|2> irrelevant

**Parameters:**  
 <Type> INSTRument | CHANnel

**INSTRument**  
 Stores data from the entire instrument.

**CHANnel**  
 Stores data from an individual channel.

\*RST: INST

**Example:**  
 INST:SEL 'SPECTRUM2 '  
 Selects channel 'SPECTRUM2 '  
 MMEM:STOR:TYPE CHAN  
 Specifies that channel data is to be stored.

### SYSTem:PRESet

This command presets the FSW. It is identical to [\\*RST](#).

**Example:** SYST:PRES

**Usage:** Event

**SYSTem:PRESet:CHANnel[:EXEC]**

Restores the default instrument settings in the current channel.

Use `INST:SEL` to select the channel.

For details see [Chapter 10.1, "Restoring the default instrument configuration \(preset\)"](#), on page 674.

**Example:**

```
INST:SEL 'Spectrum2'
Selects the channel for "Spectrum2".
SYST:PRESet:CHAN:EXEC
Restores the factory default settings to the "Spectrum2" channel.
```

**Usage:** Event

**Manual operation:** See ["Preset Channel"](#) on page 358

**13.9.4 Storing or printing screenshots****Useful commands to configure screenshots described elsewhere**

- [MMEMoRY:NAME](#) on page 1352

**Remote commands exclusive to configuring screenshots**

<a href="#">DISPlay:LOGO</a> .....	1363
<a href="#">HCOPy:ABORt</a> .....	1363
<a href="#">HCOPy:CONTEnt</a> .....	1363
<a href="#">HCOPy:CMAP&lt;it&gt;:DEFault&lt;ci&gt;</a> .....	1364
<a href="#">HCOPy:CMAP&lt;it&gt;:HSL</a> .....	1365
<a href="#">HCOPy:CMAP&lt;it&gt;:PDEFined</a> .....	1365
<a href="#">HCOPy:DESTInation&lt;di&gt;</a> .....	1365
<a href="#">HCOPy:DEVice:COLor</a> .....	1366
<a href="#">HCOPy:DEVice:LANGUage</a> .....	1367
<a href="#">HCOPy[:IMMEDIATE]</a> .....	1367
<a href="#">HCOPy[:IMMEDIATE]:NEXT</a> .....	1367
<a href="#">HCOPy:ITEM:WINDow:TEXT</a> .....	1368
<a href="#">HCOPy:PAGE:COUNt:STATe</a> .....	1368
<a href="#">HCOPy:PAGE:MARGIn:BOTTom</a> .....	1368
<a href="#">HCOPy:PAGE:MARGIn:LEFT</a> .....	1368
<a href="#">HCOPy:PAGE:MARGIn:RIGHT</a> .....	1369
<a href="#">HCOPy:PAGE:MARGIn:TOP</a> .....	1369
<a href="#">HCOPy:PAGE:MARGIn:UNIT</a> .....	1369
<a href="#">HCOPy:PAGE:ORientation</a> .....	1369
<a href="#">HCOPy:PAGE:WINDow:CHANnel:STATe</a> .....	1370
<a href="#">HCOPy:PAGE:WINDow:COUNt</a> .....	1370
<a href="#">HCOPy:PAGE:WINDow:SCALe</a> .....	1370
<a href="#">HCOPy:PAGE:WINDow:STATe</a> .....	1371
<a href="#">HCOPy:TDSamp:STATe</a> .....	1371

<a href="#">SYSTem:COMMunicate:PRINter:ENUMerate:FIRSt</a> .....	1372
<a href="#">SYSTem:COMMunicate:PRINter:ENUMerate[:NEXT]</a> .....	1372
<a href="#">SYSTem:COMMunicate:PRINter:SELect&lt;di&gt;</a> .....	1372

---

### DISPlay:LOGO <State>

Activates/deactivates the printout of the Rohde & Schwarz company logo at the top of each page.

#### Parameters:

<State>                    1 | 0 | ON | OFF  
                               **1 | ON**  
                               Logo is printed.  
                               **0 | OFF**  
                               Logo is not printed.  
                               \*RST:        1

**Example:**                DISP:LOGO OFF

**Manual operation:**    See "[Print Logo](#)" on page 696

---

### HCOPy:ABORt

This command aborts a running hardcopy output.

**Example:**                HCOP:ABOR

---

### HCOPy:CONTent <Content>

This command determines the type of content included in the printout.

This setting is independent of the printing device.

#### Parameters:

<Content>                WINDows | HCOPy

#### **WINDows**

Includes only the selected windows in the printout. All currently active windows for the current channel (or "MultiView") are available for selection. How many windows are printed on a each page of the printout is defined by [HCOPy:PAGE:WINDow:COUNT](#) on page 1370.

This option is not available when copying to the clipboard ([HCOP:DEST 'SYST:COMM:CLIP'](#) or an image file (see [HCOPy:DEvice:LANGuage](#) on page 1367).

If the destination is currently set to an image file or the clipboard, it is automatically changed to be a PDF file for the currently selected printing device.

**HCOPY**

Selects all measurement results displayed on the screen for the current channel (or "MultiView"): diagrams, traces, markers, marker lists, limit lines, etc., including the channel bar and status bar, for printout on a single page. Displayed items belonging to the software user interface (e.g. softkeys) are not included. The size and position of the elements in the printout is identical to the screen display.

\*RST:        HCOpy

**Example:**

```
HCOP:DEST1 'SYST:COMM:CLIP'
HCOP:CONT WIND
HCOP:DEST1?
//Result: 'MMEM'
HCOP:DEV:LANG1?
//Result: 'PDF'
```

"Print to clipboard" is automatically switched to "print to PDF file" when the contents are switched to "multiple windows".

**Manual operation:** See ["Print Screenshot"](#) on page 695  
See ["Print Multiple Windows"](#) on page 696

**HCOPY:CMAP<it>:DEFault<ci>**

This command defines the color scheme for print jobs.

For details see ["Print Colors"](#) on page 741.

**Suffix:**

<it>                    Irrelevant.

<ci>                    See table below

**Example:**

```
HCOP:CMAP:DEF2
```

Selects the optimized color set for the color settings of a printout.

**Manual operation:** See ["Print Colors"](#) on page 741

Gui setting	Description	Remote command
"Screen Colors (Print)"	Selects the current screen colors for the printout. The background is always printed in white and the grid in black.	HCOP:CMAP:DEF1
"Optimized Colors"	Selects an optimized color setting for the printout to improve the visibility of the colors (default setting). Trace 1 is blue, trace 2 black, trace 3 green, and the markers are turquoise. The background is always printed in white and the grid in black.	HCOP:CMAP:DEF2
"User Defined Colors"	Selects the user-defined color setting.	HCOP:CMAP:DEF3
"Screen Colors (Screenshot)"	Selects the current screen colors without any changes for a screenshot.	HCOP:CMAP:DEF4

---

**HCOPY:CMAP<it>:HSL** <hue>, <sat>, <lum>

This command selects the color for various screen elements in print jobs.

**Suffix:**

<it>                      Selects the item for which the color scheme is to be defined.  
For more information see [Chapter 13.10.5.3, "CMAP suffix assignment"](#), on page 1431.

**Parameters:**

<hue>                    **hue**  
                         tint  
                         Range:     0 to 1

<sat>                    **sat**  
                         saturation  
                         Range:     0 to 1

<lum>                    **lum**  
                         brightness  
                         Range:     0 to 1

**Example:**              HCOPY:CMAP2:HSL 0.3,0.8,1.0  
                         Changes the grid color

**Manual operation:**   See "[Defining User-specific Colors](#)" on page 743

---

**HCOPY:CMAP<it>:PDEFined** <Color>

This command selects a predefined color for various screen elements in print jobs.

**Suffix:**

<it>                      1..n  
                         Selects the item for which the color scheme is to be defined.  
For more information see [Chapter 13.10.5.3, "CMAP suffix assignment"](#), on page 1431.

**Parameters:**

<Color>                 BLACK | BLUE | BROWn | GREen | CYAN | RED | MAGenta |  
                         YELLow | WHITE | DGRay | LGRay | LBLue | LGRen | LCYan |  
                         LRED | LMAGenta

**Example:**              HCOPY:CMAP2:PDEF GRE

**Manual operation:**   See "[Predefined Colors](#)" on page 742

---

**HCOPY:DESTination<di>** <Destination>

This command selects the destination of a print job.

**Note:** To print a screenshot to a file, see [HCOPY:DEVICE:LANGUage](#) on page 1367.

**Suffix:**

<di> Printing device.

**Parameters:**

<Destination>

**'MMEM'**

Activates "Print to file". Thus, if the destination of the print function is set to "printer" (see [HCOP:DEST1 'SYSTEM:COMMUNICATE:PRINTER'](#) or [HCOP:DEV:LANG GDI](#)), the output is redirected to a .PRN file using the selected printer driver.

Select the file name with [MMEMemory:NAME](#).

**Note:** To save a screenshot to a file, see [HCOPY:DEVICE:LANGUAGE](#) on page 1367.

**'SYSTEM:COMMUNICATE:PRINTER'**

Sends the hardcopy to a printer and deactivates "print to file".

Select the printer with [SYSTEM:COMMUNICATE:PRINTER:SELECT](#)<di> .

**'SYSTEM:COMMUNICATE:CLIPBOARD'**

Sends the hardcopy to the clipboard.

\*RST: 'SYST:COMM:CLIP'

**Example:**

To print on a printer:

```
//Destination: printer, deactivate "print to file"
HCOP:DEST1 'SYSTEM:COMMUNICATE:PRINTER'
//Define the printer name
SYST:COMM:PRIN:SEL 'myFavoritePrinter'
//Print
HCOP:IMM
```

**Example:**

To print to a \*PRN file:

```
//Destination: printer
HCOP:DEV:LANG GDI
//Define the printer name
SYST:COMM:PRIN:SEL 'myFavoritePrinter'
//Redirect the printer output to a file
HCOP:DEST1 'MMEM'
//Define file name
MME:NAME 'C:\R_S\instr\user\MeasurementTestReport.png'
//Print
HCOP:IMM
```

**Manual operation:**

See ["Destination: File"](#) on page 701

See ["Destination: Clipboard"](#) on page 701

See ["Destination: Printer"](#) on page 701

See ["Print to file"](#) on page 702

**HCOPY:DEVICE:COLOR <State>**

This command turns color printing on and off.

**Parameters:**

<State> ON | OFF | 0 | 1

**ON | 1**  
Color printing

**OFF | 0**  
Black and white printing

\*RST: 1

**Example:** HCOP:DEV:COL ON

### HCOPy:DEvIce:LANGUage <Language>

This command selects the file format for a print job or to store a screenshot to a file.

**Parameters:**

<Language> **BMP | JPG | PNG | PDF | SVG**  
Data format for output to files

**DOC | PDF**  
File type for test reports  
Available for [HCOP:MODE REPORT](#)

**Example:** To print a screenshot to a PNG file:

```
//Destination: PNG file
HCOP:DEV:LANG PNG
//Define file name
MME:NAME 'C:\R_S\instr\user\MeasurementTestReport.png'
//Print
HCOP:IMM
```

**Manual operation:** See "[Destination: File](#)" on page 701  
See "[File type](#)" on page 713  
See "[File type](#)" on page 722

### HCOPy[:IMMEDIATE]

This command initiates a print job.

If you are printing to a file, the file name depends on [MME:NAME](#).

**Manual operation:** See "[Print](#)" on page 699  
See "[Save](#)" on page 723

### HCOPy[:IMMEDIATE]:NEXT

This command initiates a print job.

If you are printing to a file, the file name depends on [MME:NAME](#). This command adds a consecutive number to the file name.

**Manual operation:** See "[Print](#)" on page 699

---

**HCOPY:ITEM:WINDow:TEXT** <Comment>

This command defines a comment to be added to the printout.

**Parameters:**

<Comment>           String containing the comment.

**Manual operation:**   See "[Comment](#)" on page 696

---

**HCOPY:PAGE:COUNT:STATe** <State>

This command includes or excludes the page number for printouts consisting of multiple pages ([HCOPY:CONTent](#) on page 1363).

**Parameters:**

<State>               1 | 0 | ON | OFF  
                      **1 | ON**  
                      The page number is printed.  
                      **0 | OFF**  
                      The page number is not printed.  
                      \*RST:       1

**Example:**             HCOP:PAGE:COUN:STAT ON

**Manual operation:**   See "[Print Page Count](#)" on page 696

---

**HCOPY:PAGE:MARGIn:BOTTom** <Bottom>

This command defines the margin at the bottom of the printout page on which no elements are printed. The margins are defined according to [HCOPY:PAGE:MARGIn:UNIT](#) on page 1369.

**Parameters:**

<Bottom>             \*RST:       4.23 mm

**Example:**             HCOP:PAGE:MARG2:BOT 2

**Manual operation:**   See "[Margins](#)" on page 704

---

**HCOPY:PAGE:MARGIn:LEFT** <Left>

This command defines the margin at the left side of the printout page on which no elements are printed. The margins are defined according to [HCOPY:PAGE:MARGIn:UNIT](#) on page 1369.

**Parameters:**

<Left>               \*RST:       4.23 mm

**Example:**             HCOP:PAGE:MARG2:LEFT 2

**Manual operation:**   See "[Margins](#)" on page 704



---

**HCOPY:PAGE:MARGIn:RIGHT <Right>**

This command defines the margin at the right side of the printout page on which no elements are printed. The margins are defined according to [HCOPY:PAGE:MARGIn:UNIT](#) on page 1369.

**Parameters:**

<Right>                    \*RST:        4.23 mm

**Example:**

HCOP:PAGE:MARG2:RIGH 2

**Manual operation:** See "[Margins](#)" on page 704

---

**HCOPY:PAGE:MARGIn:TOP <Top>**

This command defines the margin at the top of the printout page on which no elements are printed. The margins are defined according to [HCOPY:PAGE:MARGIn:UNIT](#) on page 1369.

**Parameters:**

<Top>                      \*RST:        4.23 mm

**Example:**

HCOP:PAGE:MARG2:TOP 2

**Manual operation:** See "[Margins](#)" on page 704

---

**HCOPY:PAGE:MARGIn:UNIT <Unit>**

This command defines the unit in which the margins for the printout page are configured.

**Parameters:**

<Unit>                      MM | IN  
                                  **MM**  
                                  millimeters  
                                  **IN**  
                                  inches  
                                  \*RST:        MM

**Example:**

HCOP:PAGE:MARG2:BOTT 2

**Manual operation:** See "[Margins](#)" on page 704

---

**HCOPY:PAGE:ORientation <Orientation>**

The command selects the page orientation of the printout.

The command is only available if the output device is a printer or a PDF file.

**Parameters:**

<Orientation>              LANDscape | PORTrait  
                                  \*RST:        PORTrait

**Example:**           HCOP:DEV:LANG1 PDF  
                  HCOP:PAGE:ORI2 LAND

**Manual operation:** See "[Orientation](#)" on page 704

### HCOPY:PAGE:WINDow:CHANnel:STATe <Channel>, <State>

This command selects all windows of the specified channel to be included in the print-out for [HCOPY:CONTent](#) on page 1363.

**Parameters:**

<Channel>           String containing the name of the channel.  
                  For a list of available channel types use [INSTrument:LIST?](#)  
                  on page 899.

<State>             1 | 0 | ON | OFF  
                  **1 | ON**  
                  The channel windows are included in the printout.  
                  **0 | OFF**  
                  The channel windows are not included in the printout.  
                  \*RST:       1

**Example:**           HCOP:CONT WIND  
                  HCOP:PAGE:WIND2:CHAN 'IQ Analyzer',0  
                  HCOP:PAGE:WIND2:STAT 'IQ Analyzer','1',1  
                  Prints only window 1 in the IQ Analyzer channel.

**Manual operation:** See "[Print Multiple Windows](#)" on page 696

### HCOPY:PAGE:WINDow:COUNT <Count>

This command defines how many windows are displayed on a single page of the print-out for [HCOPY:CONTent](#) on page 1363.

**Parameters:**

<Count>             integer  
                  \*RST:       1

**Example:**           HCOP:PAGE:WIND2:COUN 2

**Manual operation:** See "[Windows Per Page](#)" on page 704

### HCOPY:PAGE:WINDow:SCALE <Scale>

This command determines the scaling of the windows in the printout for [HCOPY:CONTent](#) on page 1363.

**Parameters:**

<Scale>             1 | 0 | ON | OFF

**1 | ON**

Each window is scaled to fit the page size optimally, not regarding the aspect ratio of the original display. If more than one window is printed on one page (see [HCOPY:PAGE:WINDow:COUNT](#) on page 1370), each window is printed in equal size.

("Size to fit")

**0 | OFF**

Each window is printed as large as possible while maintaining the aspect ratio of the original display.

("Maintain aspect ratio")

\*RST: 1

**Example:** `HCOPY:PAGE:WIND2:SCAL 0`

**Manual operation:** See "[Scaling](#)" on page 704

**HCOPY:PAGE:WINDow:STATe** <Channel>, <Window>, <State>

This command selects the windows to be included in the printout for [HCOPY:CONTent](#) on page 1363.

**Parameters:**

<Channel>	String containing the name of the channel. For a list of available channel types use <a href="#">INSTrument:LIST?</a> on page 899.
<Window>	String containing the name of the existing window. By default, the name of a window is the same as its index. To determine the name and index of all active windows in the active channel, use the <a href="#">LAYout:CATalog[:WINDow]?</a> query.
<State>	1   0   ON   OFF <b>1   ON</b> The window is included in the printout. <b>0   OFF</b> The window is not included in the printout. *RST: 1

**Example:** `HCOPY:PAGE:WIND2:STAT 'IQ Analyzer','1',1`

**Manual operation:** See "[Print Multiple Windows](#)" on page 696

**HCOPY:TDSTamp:STATe** <State>

This command includes or excludes the time and date in the printout.

**Parameters:**

<State>	1   0   ON   OFF <b>1   ON</b> The time and date are printed.
---------	---------------------------------------------------------------------

**0 | OFF**

The time and date are not printed.

\*RST: 1

**Manual operation:** See ["Print Date and Time"](#) on page 697

**SYSTem:COMMunicate:PRINter:ENUMerate:FIRSt**

This command queries the name of the first available printer.

To query the name of other installed printers, use [SYSTem:COMMunicate:PRINter:ENUMerate\[:NEXT\]](#) on page 1372.

**Manual operation:** See ["Printer Name"](#) on page 701

**SYSTem:COMMunicate:PRINter:ENUMerate[:NEXT]**

This command queries the name of available printers.

You have to use [SYSTem:COMMunicate:PRINter:ENUMerate:FIRSt](#) on page 1372 for this command to work properly.

**Manual operation:** See ["Printer Name"](#) on page 701

**SYSTem:COMMunicate:PRINter:SELEct<di> <Printer>**

This command selects the printer that processes jobs sent by the FSW.

Use [HCOPY:DESTination<di>](#) to select another output destination.

**Suffix:**

<di> 1..n  
Printing device.

**Parameters:**

<Printer> String containing the printer name.  
Use

- [SYSTem:COMMunicate:PRINter:ENUMerate:FIRSt](#) on page 1372 and
- [SYSTem:COMMunicate:PRINter:ENUMerate\[:NEXT\]](#) on page 1372 to query all available printers.

\*RST: NONE

**Manual operation:** See ["Printer Name"](#) on page 701

### 13.9.5 Storing measurement results

The following commands can be used to store the results of a measurement.

Useful commands for storing results described elsewhere:

- [FORMat \[ : DATA \]](#) on page 1258
- [MMEMory:STORe<n>:TRACe](#) on page 1265
- [FORMat:DEXPort:TRACes](#) on page 1263

#### Remote commands exclusive to storing results:

<a href="#">FORMat:DEXPort:HEADer</a> .....	1373
<a href="#">MMEMory:STORe&lt;n&gt;:LIST</a> .....	1373
<a href="#">MMEMory:STORe&lt;n&gt;:PEAK</a> .....	1374
<a href="#">MMEMory:STORe&lt;n&gt;:SGRam</a> .....	1374
<a href="#">MMEMory:STORe&lt;n&gt;:SPECtrogram</a> .....	1374
<a href="#">MMEMory:STORe&lt;n&gt;:SPURious</a> .....	1375

---

#### FORMat:DEXPort:HEADer <State>

If enabled, additional instrument and measurement settings are included in the header of the export file for result data. If disabled, only the pure result data from the selected traces and tables is exported.

See [Chapter 8.6.6, "Reference: ASCII file export format"](#), on page 657 for details.

#### Parameters:

<State>                    ON | OFF | 0 | 1  
                              \*RST:            1

**Manual operation:**    See ["Include Instrument & Measurement Settings"](#) on page 651

---

#### MMEMory:STORe<n>:LIST <FileName>

Exports the SEM and spurious emission list evaluation to a file.

The file format is \*.dat.

#### Secure User Mode

In secure user mode, settings that are stored on the instrument are stored to volatile memory, which is restricted to 256 MB. Thus, a "memory limit reached" error can occur although the hard disk indicates that storage space is still available.

To store data permanently, select an external storage location such as a USB memory device.

For details, see [Chapter 4.2.15, "Protecting data using the secure user mode"](#), on page 39.

#### Suffix:

<n>                            [Window](#)

#### Parameters:

<FileName>                    String containing the path and name of the target file.

#### Example:

```
MMEM:STOR:LIST 'test'
```

Stores the current list evaluation results in the test.dat file.

**Manual operation:** See ["Saving the Result Summary \(Evaluation List\) to a File"](#) on page 266  
See ["Save Evaluation List"](#) on page 290

### **MMEMory:STORe<n>:PEAK <FileName>**

Exports the marker peak list to a file.

#### **Secure User Mode**

In secure user mode, settings that are stored on the instrument are stored to volatile memory, which is restricted to 256 MB. Thus, a "memory limit reached" error can occur although the hard disk indicates that storage space is still available.

To store data permanently, select an external storage location such as a USB memory device.

For details, see [Chapter 4.2.15, "Protecting data using the secure user mode"](#), on page 39.

#### **Suffix:**

<n> [Window](#)

#### **Parameters:**

<FileName> String containing the path, name and extension of the target file.

#### **Example:**

```
MMEM:STOR:PEAK 'test.dat'
```

Saves the current marker peak list in the file `test.dat`.

**Manual operation:** See ["Export Peak List"](#) on page 585

### **MMEMory:STORe<n>:SGRam <FileName>**

### **MMEMory:STORe<n>:SPECTrogram <FileName>**

Exports spectrogram data to an ASCII file.

The file contains the data for every frame in the history buffer. The data corresponding to a particular frame begins with information about the frame number and the time that frame was recorded.

Note that, depending on the size of the history buffer, the process of exporting the data can take a while.

#### **Secure User Mode**

In secure user mode, settings that are stored on the instrument are stored to volatile memory, which is restricted to 256 MB. Thus, a "memory limit reached" error can occur although the hard disk indicates that storage space is still available.

To store data permanently, select an external storage location such as a USB memory device.

For details, see [Chapter 4.2.15, "Protecting data using the secure user mode"](#), on page 39.

#### **Suffix:**

<n> [Window](#)

**Parameters:**

<FileName> String containing the path and name of the target file.

**Example:**

MMEM:STOR:SGR 'Spectrogram'  
Copies the spectrogram data to a file.

**Manual operation:** See ["Export Trace to ASCII File"](#) on page 652

**MMEMory:STORe<n>:SPURious <FileName>**

Exports the marker peak list available for spurious emission measurements to a file.

**Secure User Mode**

In secure user mode, settings that are stored on the instrument are stored to volatile memory, which is restricted to 256 MB. Thus, a "memory limit reached" error can occur although the hard disk indicates that storage space is still available.

To store data permanently, select an external storage location such as a USB memory device.

For details, see [Chapter 4.2.15, "Protecting data using the secure user mode"](#), on page 39.

**Suffix:**

<n> irrelevant

**Parameters:**

<FileName> String containing the path and name of the target file.

**Example:**

MMEM:STOR:SPUR 'test'  
Saves the current marker peak list in the file test.dat.

## 13.9.6 Test reports

Commands to create test reports described elsewhere.

- [HCOPY:DEVIce:LANGUage](#) on page 1367
- [HCOPY\[:IMMediate\]](#) on page 1367
- [MMEMory:NAME](#) on page 1352

<a href="#">HCOPY:MODE</a> .....	1376
<a href="#">HCOPY:TREPort:APPend</a> .....	1376
<a href="#">HCOPY:TREPort:DESCription</a> .....	1376
<a href="#">HCOPY:TREPort:ITEM:DEFault</a> .....	1377
<a href="#">HCOPY:TREPort:ITEM:HEADer:LINE&lt;li&gt;:CONTrol</a> .....	1377
<a href="#">HCOPY:TREPort:ITEM:HEADer:LINE&lt;li&gt;:TEXT</a> .....	1377
<a href="#">HCOPY:TREPort:ITEM:HEADer:LINE&lt;li&gt;:TITLe</a> .....	1378
<a href="#">HCOPY:TREPort:ITEM:HEADer:STATe</a> .....	1379
<a href="#">HCOPY:TREPort:ITEM:LIST</a> .....	1379
<a href="#">HCOPY:TREPort:ITEM:LOGO</a> .....	1379
<a href="#">HCOPY:TREPort:ITEM:LOGO:CONTrol</a> .....	1380
<a href="#">HCOPY:TREPort:ITEM:SElect</a> .....	1380

HCOPy:TREPort:ITEM:TEMPlate:CATalog?	1381
HCOPy:TREPort:ITEM:TEMPlate:DELeTe	1382
HCOPy:TREPort:ITEM:TEMPlate:LOAD	1382
HCOPy:TREPort:ITEM:TEMPlate:SAVE	1382
HCOPy:TREPort:NEW	1382
HCOPy:TREPort:PAGeCount:STATe	1383
HCOPy:TREPort:PAGeSize	1383
HCOPy:TREPort:PCOLors:STATe	1383
HCOPy:TREPort:TDSamp:STATe	1384
HCOPy:TREPort:TEST:REMove	1384
HCOPy:TREPort:TEST:REMove:ALL	1384
HCOPy:TREPort:TITLe	1384
HCOPy:TREPort:TITLe:STATe	1385
MMEMy:RAW	1385

---

### HCOPy:MODE <Mode>

**Parameters:**

<Mode>                    SCReen | REPort

**Manual operation:**    See "Save" on page 723

---

### HCOPy:TREPort:APPend

This command adds the current measurement results to the test report.

The saved data depends on the items you have selected with [HCOPy:TREPort:ITEM:SELeCt](#) on page 1380.

**Example:**

Perform a measurement, then:

```
HCOP:TREP:NEW
```

Creates a new test report with the results of the first measurement.

Perform another measurement, then:

```
HCOP:TREP:APP
```

Adds the results of the second measurement to the test report.

**Usage:**

Event

**Manual operation:**    See " Report Append" on page 722

---

### HCOPy:TREPort:DESCRiption <Description>

This command defines the description of the test report as shown on its title page.

**Parameters:**

<Description>            String containing the description of the test report.

**Example:**

```
HCOP:TREP:DESC 'A short summary of the test report.'
```

Adds a description to the test report.



**HCOPy:TREPort:ITEM:DEFault**

This command restores the default configuration of the test report regarding the information that is part of the report.

It also restores the default names of the measurement information titles.

**Usage:** Event

**Manual operation:** See ["Default"](#) on page 721

**HCOPy:TREPort:ITEM:HEADer:LINE<i>:CONTRol <Repetition>**

This command selects how often the items in the report header are displayed in the document.

**Suffix:**

<i> 1..n  
Selects the header line.

**Parameters:**

<Repetition>

**GLOBAL**

The selected header line is displayed at the top of every page of the report.

**NEVer**

The selected header line is displayed on no page of the report. Note that a line that does not contain anything is still displayed in the report as a blank line. If you select NEVer, the line is not displayed at all.

**SECTion**

The selected header line is displayed after the title of every sub-report.

\*RST: NEVer

**Example:**

```
HCOP:TREP:ITEM:HEAD:LINE4:TITL ''
HCOP:TREP:ITEM:HEAD:LINE4:TEXT ''
Defines an empty string for line 4 of the report header.
HCOP:TREP:ITEM:HEAD:LINE4:CONT NEV
Removes line 4 from the header of the test report.
```

**Manual operation:** See ["Visibility"](#) on page 718

**HCOPy:TREPort:ITEM:HEADer:LINE<i>:TEXT <Description>**

This command defines a descriptive text for one of the items part of the report header.

You can define up to 6 items in the header.

Use [HCOPy:TREPort:ITEM:HEADer:LINE<i>:TITLe](#) on page 1378 to define custom titles for each item.

Use [HCOPy:TREPort:ITEM:HEADer:LINE<i>:CONTRol](#) to select the condition under which each item is shown.

<b>Suffix:</b>	
<li>	1..n Selects the header line.
<b>Parameters:</b>	
<Description>	String containing the description of one of the value fields. By default, the value fields of the items are empty.
<b>Example:</b>	<pre>HCOP:TREP:ITEM:HEAD:LINE3:TITL 'Device under Test'</pre> <p>Renames the third title into "Device under Test".</p> <pre>HCOP:TREP:ITEM:HEAD:LINE3:TEXT 'Some Device'</pre> <p>Labels the third title as "Some Device".</p>
<b>Manual operation:</b>	See " <a href="#">Value</a> " on page 718

### HCOPy:TREPort:ITEM:HEADer:LINE<li>:TITLe <Title>

This command defines a custom name for one of the items part of the report header.

You can define up to 6 items in the header.

Use [HCOPy:TREPort:ITEM:HEADer:LINE<li>:TEXT](#) on page 1377 to add a value to each item.

Use [HCOPy:TREPort:ITEM:HEADer:LINE<li>:CONTrol](#) to select the condition under which each item is shown.

<b>Suffix:</b>	
<li>	1..n Selects the header line.
<b>Parameters:</b>	
<Title>	String containing the title of the item. The default titles are as follows: <ul style="list-style-type: none"> <li>• Line 1: "Heading"</li> <li>• Line 2: "Meas Type"</li> <li>• Line 3: "Equipment under Test"</li> <li>• Line 4: "Manufacturer"</li> <li>• Line 5: "OP Condition"</li> <li>• Line 6: "Test Spec"</li> </ul> Make sure that the title string is not too long, because strings that are too long could mess up the layout of the report.
<b>Example:</b>	<pre>HCOP:TREP:ITEM:HEAD:LINE3:TITL 'Device under Test'</pre> <p>Renames the third title into "Device under Test".</p>
<b>Manual operation:</b>	See " <a href="#">Title</a> " on page 718

**HCOPy:TREPort:ITEM:HEADer:STATe** <State>

This command includes or excludes the complete set of measurement information from the test report.

**Parameters:**

<State>                    ON | OFF | 0 | 1  
                               **OFF | 0**  
                               Switches the function off  
                               **ON | 1**  
                               Switches the function on  
                               \*RST:        1

**Example:**                HCOP:TREP:ITEM:HEAD:STAT ON  
 Includes the measurement information in the test report.

**Manual operation:**    See "[State](#)" on page 718

**HCOPy:TREPort:ITEM:LIST** [<ChannelType>]

This command queries the selected information to be included in the test report for a specific channel type.

**Parameters:**

<ChannelType>            <char\_data>  
                               Selects the channel type that you want to query the test report configuration for.  
                               When you omit the parameter, the command returns the configuration of the currently selected channel.

**Example:**                HCOP:TREP:ITEM:LIST? SAN  
 Queries the items that are included in the test reports of the Spectrum application.

*Table 13-8: Available <ChannelTypes>*

<ChannelType>	Description
SAN	Spectrum
OFDMVSA	OFDM VSA

**HCOPy:TREPort:ITEM:LOGO** <FileName>**Parameters:**

<FileName>                String containing the location and name of the picture.  
 You can use the following file types: bmp, jpg, png, gif, emf or wmf format.

**Example:**                HCOP:TREP:ITEM:LOGO 'C:\aPicture.jpg'  
 Includes a picture at the top of each page of the report.

**Manual operation:**    See "[Logo](#)" on page 719

**HCOPy:TREPort:ITEM:LOGO:CONTRol** <Repetition>

This command selects how often the logo is displayed in the document.

**Parameters:**

&lt;Repetition&gt;

**ALWays**

The logo is displayed at the top of every page of the report.

**NEVer**

The logo is displayed on no page of the report.

**ONCE**

The logo is displayed on the first page of each dataset.

\*RST: NEVer

**Example:**

```
HCOP:TREP:ITEM:LOGO 'c:\logo.png'
```

Selects a picture to be displayed in the report document.

```
HCOP:TREP:ITEM:LOGO:CONT GLOB
```

Displays the logo on each page.

**Manual operation:** See "[Visibility](#)" on page 718

**HCOPy:TREPort:ITEM:SELEct** [<ChannelType>], '<Item>,<Item>,<Item>,...'

This command defines the type of information that a test report consists of.

**Setting parameters:**

&lt;ChannelType&gt;

Optional parameter to define the channel type that the selection applies to.

When you omit the <ChannelType> parameter, the selection applies to the currently active channel.

&lt;Item&gt;

String containing the information you want to include in the test report.

Note that the items, separated by commas, have to be written into one string (see example below).

The available items depend on the application you are using.

See the tables below for a short description of each item.

By default, some items are selected (see tables below).

**Example:**

```
HCOP:TREP:ITEM:SEL 'SETT, MARK, SRES, DIAG'
```

The selection is applied to the currently selected channel.

**Example:**

```
HCOP:TREP:ITEM:SEL SAN, 'SETT, LISN'
```

A dataset in the Spectrum application consists of the general instrument and measurement settings and the LISN settings.

**Usage:**

Setting only

**Manual operation:** See "[Select All / Select None](#)" on page 720

**Table 13-9: Available <ChannelTypes>**

<ChannelType>	Description
SAN	Spectrum
OFDMVSA	OFDM VSA

**Table 13-10: Available <items> in spectrum application**

<Item>	Description	Default
DIAGram	Screenshot of the scan results.	x
MARKers	Contents of the marker table.	x
PEAKlist	Contents of the peak list.	x
RSUMmary	Contents of the result summary.	x
SETTings	Settings that have been used during a measurement.	x
SPECTrogram	Screenshot of the spectrogram.	x
RESultlist	List of trace point values.	
TRANsducer	Characteristics of the transducer.	
LISN	Information about LISNs.	

**Table 13-11: Available <items> in OFDM VSA application**

<Item>	Description	Default
DIAGram	Screenshot of all displayed diagrams.	x
MARKers	Contents of the marker table.	x
RSUMmary	Contents of the result summary.	x
SETTings	Settings that have been used during a measurement.	x
TRANsducer	Characteristics of the transducer.	
TRIGger	Trigger to sync value	x

**HCOPy:TREPort:ITEM:TEMPlate:CATalog?**

This command queries the test report templates available in the default report directory (and its subdirectories).

**Return values:**

<Templates> String containing the name of the templates as a comma-separated list.

**Example:**

```
HCOP:TREP:ITEM:TEMP:CAT?
```

Returns, e.g.:

```
'TemplateX, TemplateY, TemplateZ'
```

**Usage:**

Query only

**Manual operation:** See "[Template name](#)" on page 720

---

**HCOPy:TREPort:ITEM:TEMPlate:DELeTe** <Template>

This command deletes a test report template.

**Setting parameters:**

<Template> String containing the name of the template.

**Example:** HCOP:TREP:ITEM:TEMP:DEL 'myTemplate'  
Deletes a test report template.

**Usage:** Setting only

---

**HCOPy:TREPort:ITEM:TEMPlate:LOAD** <Template>

This command loads a test report template.

**Setting parameters:**

<Template> String containing the name of the template.

**Example:** HCOP:TREP:ITEM:TEMP:LOAD 'myTemplate'  
Loads a test report template.

**Usage:** Setting only

**Manual operation:** See "[Load](#)" on page 721

---

**HCOPy:TREPort:ITEM:TEMPlate:SAVE** <Template>

This command saves a test report template in XML format.

**Setting parameters:**

<Template> String containing the name of the template. The .xml file extension is added automatically.

**Example:** HCOP:TREP:ITEM:TEMP:SAVE 'myTemplate'  
Saves a test report template.

**Usage:** Setting only

**Manual operation:** See "[Save](#)" on page 721

---

**HCOPy:TREPort:NEW**

This command creates a new dataset for a new test report.

Creating a new test report deletes all previously saved datasets. The current measurement results are added as the first dataset to the new report.

The FSW saves the data selected with [HCOPy:TREPort:ITEM:SELeCt](#) on page 1380.

To save the report, use [HCOPy\[:IMMediate\]](#) on page 1367.

**Example:** HCOP:TREP:NEW  
Creates a dataset for a new test report.

**Usage:** Event

**Manual operation:** See "[Report New](#)" on page 721

#### HCOPY:TREPort:PAGecount:STATe <State>

This command includes or excludes page number from the test report.

**Parameters:**

<State> ON | OFF | 0 | 1  
**OFF | 0**  
 Switches the function off  
**ON | 1**  
 Switches the function on  
 \*RST: 0

**Example:** HCOPY:TREP:PAG:STAT OFF  
 Removes page numbers from the test report.

**Manual operation:** See "[Page Count](#)" on page 714

#### HCOPY:TREPort:PAGesize <Size>

This command selects the size of the test report document.

**Parameters:**

<Size> A4 | US  
**A4**  
 Document pages have an A4 size.  
**US**  
 Document pages have a US letter size.  
 \*RST: A4

**Example:** HCOPY:TREP:PAG A4  
 Selects the A4 size for the document.

**Manual operation:** See "[Page format](#)" on page 713

#### HCOPY:TREPort:PCOLors:STATe <State>

This command turns the use of printer friendly colors on and off.

**Parameters:**

<State> ON | OFF | 0 | 1  
**OFF | 0**  
 Switches the function off  
**ON | 1**  
 Switches the function on  
 \*RST: 0

**Manual operation:** See "[Use Screen Colors](#)" on page 713

---

**HCOPy:TREPort:TDSTamp:STATe** <State>

This command includes or excludes date and time from the test report.

**Parameters:**

<State>                    ON | OFF | 0 | 1  
                               **OFF | 0**  
                               Switches the function off  
                               **ON | 1**  
                               Switches the function on  
                               \*RST:        0

**Example:**                HCOP:TREP:TDST OFF  
 Does not show any time or date information in the test report.

**Manual operation:**    See "[Date](#)" on page 714

---

**HCOPy:TREPort:TEST:REMOve** <Dataset>

This command deletes one of the datasets that are currently part of a test report.

**Setting parameters:**

<Dataset>                Index number of the dataset as shown in the "Test Report Content Selection" dialog box.  
 If the index number is greater than the number of available datasets, the command returns an error.

**Example:**                HCOP:TREP:TEST:REM 2  
 Deletes the second dataset from the current test report.

**Usage:**                 Setting only

**Manual operation:**    See "[Selecting items to include in the report](#)" on page 723

---

**HCOPy:TREPort:TEST:REMOve:ALL**

This command removes all existing datasets from the test report.

**Example:**                HCOP:TREP:TEST:REM:ALL  
 Deletes all datasets that are currently in the test report.

**Usage:**                 Event

**Manual operation:**    See "[Remove All](#)" on page 723

---

**HCOPy:TREPort:TITLe** <Title>

This command defines the title for the test report as shown on its title page.

**Parameters:**

<Title>                    String containing the title.

**Example:**                HCOP:TREP:TITL 'My first test report'  
 Defines a title for a test report.



**HCOPy:TREPort:TITLe:STATe <State>**

This command includes or excludes the title page from the test report.

**Parameters:**

<State>                    ON | OFF | 0 | 1  
                               **OFF | 0**  
                               Switches the function off  
                               **ON | 1**  
                               Switches the function on  
                               \*RST:        0

**Example:**

HCOP:TREP:TITL:STAT OFF  
 Removes the title page from the test report.

**MMEMy:RAW <Path>**

Defines the location where the measurement data sets for the report are stored until the report is created.

**Parameters:**

<Path>                    String containing the path of the preliminary data

**Manual operation:** See "[Raw Data Storage](#)" on page 714

**13.9.7 Examples: managing data**

• <a href="#">Storing data</a> .....	1385
• <a href="#">Loading data</a> .....	1386
• <a href="#">Storing instrument settings</a> .....	1386
• <a href="#">Loading instrument settings</a> .....	1387
• <a href="#">Printing to a file</a> .....	1387
• <a href="#">Printing on a printer</a> .....	1387
• <a href="#">Storing multiple graphical measurement results to a PDF file</a> .....	1388

**13.9.7.1 Storing data**

```
MMEM:MSIS 'C:'
//Selects drive C: as the default storage device.

//-----Connecting a network drive-----
MMEM:NETW:USED?
//Returns a list of all drives in use in the network.
MMEM:NETW:UNUS?
//Returns a list of free drive names in the network.
MMEM:NETW:MAP 'Q:', 'Server\ACLRTTest'
//Maps drive Q: to the directory 'Server\ACLRTTest'

//-----Saving data on the instrument-----
```

```

MMEM:MDIR 'C:\R_S\INSTR\USER\Results'
//Creates a directory called 'Results' on drive C:
MMEM:NAME 'C:\R_S\INSTR\USER\Results\Test001.txt'
//Defines a file called 'Test001.txt'
MMEM:COMM 'ACLR test results'
//Creates a comment for the settings to be displayed in gui.
MMEM:DATA 'Test001.txt',#212FileContents
//Creates the file 'Test001.txt'and writes 12 characters to it

//-----Copying the data to another location---
MMEM:COPY 'C:\R_S\INSTR\USER\Results\Test001.txt','Q:'
//Copies the specified file to network drive Q:..
MMEM:DEL 'C:\R_S\INSTR\USER\Results\Test001.txt'
//Deletes the specified file from the instrument hard disk.
//or
//MMEM:MOVE 'C:\R_S\INSTR\USER\Results\Test001.xml','Q:\TestResults.txt'//
//Moves the file 'Test001.txt' to drive Q:, renames it to 'Testresults.txt'
//and removes it from the instrument hard disk.
MMEM:RDIR 'C:\R_S\INSTR\USER\Results'
//Deletes the directory called 'Results' from drive C:, unless it still
//contains any content.

//-----Disconnecting the network drive---
MMEM:NETW:DISC 'Q:'
//Disconnect drive Q:..

```

### 13.9.7.2 Loading data

```

MMEM:CDir?
//Returns the path of the current directory.
//e.g.
C:\R_S\Instr\user\
MMEM:CDir 'C:\R_S\INSTR\USER\Results'
//Changes the current directory.
MMEM:CAT? 'C:\R_S\INSTR\USER\Results\*.xml'
//or
MMEM:CAT? '*.xml'
//Returns a list of all xml files in the directory 'C:\R_S\INSTR\USER\Results'.
MMEM:CAT:LONG? '*.xml'
//Returns additional information about the xml files in the directory
// 'C:\R_S\INSTR\USER\Results'.

```

### 13.9.7.3 Storing instrument settings

In this example we will store the instrument settings for the "Spectrum" channel.

```

INST:SEL 'SPECTRUM'
//Selects measurement channel 'SPECTRUM'.
MEMM:STOR:TYPE CHAN

```

```
//Specifies that channel-specific data is to be stored.
MMEM:STOR:STAT 1, 'C:\R_S\Instr\user\Spectrum'
//Stores the channel settings from the 'Spectrum' channel
// to the file 'Spectrum.dfl'.
```

#### 13.9.7.4 Loading instrument settings

In this example we will load the hardware settings from the configuration file Spectrum.dfl to a new "Spectrum2" channel.

```
MEMM:LOAD:TYPE NEW
//Specifies that settings will be loaded to a new channel besides the existing
//'Spectrum' channel.
MMEM:SEL:CHAN:HWS ON
//Selects only hardware settings to be loaded.
MMEM:LOAD:STAT 1, 'C:\R_S\Instr\user\Spectrum'
//Loads the channel-specific settings from the file 'C:\R_S\Instr\user\Spectrum.dfl'
//to a new channel. The new channel is named 'Spectrum2' to avoid a naming conflict
//with the existing 'Spectrum' channel.
INST:REN 'Spectrum2','Spectrum3'
//Renames the loaded channel to 'Spectrum3'.
```

#### 13.9.7.5 Printing to a file

```
//Select bmp as the file format.
HCOP:DEV:LANG BMP
//Select the file name for the printout.
MMEM:NAME 'C:\R_S\INSTR\USER\Screenshot.bmp'
//Select all screen elements for printing
HCOP:ITEM:ALL
//Add a comment to the printout.
HCOP:ITEM:WIND:TEXT 'ACLRResults'
//Store the printout in a file called 'Screenshot.bmp'.
HCOP
//Store another printout in a file called 'Screenshot_001.bmp'.
HCOP:NEXT
```

#### 13.9.7.6 Printing on a printer

```
HCOP:DEST2 'SYST:COMM:PRIN'
//Prints the data on a printer.
SYST:COMM:PRIN:ENUM:FIRS?
SYST:COMM:PRIN:ENUM?
//Returns the available printers, e.g.
//'LASER on LPT1'
//''
//Means that one printer is available.
SYST:COMM:PRIN:SEL2 'LASER on LPT1'
//Selects the printer for the print job on device 2.
```

```

HCOP:PAGE:ORI2 LAND
//Selects the landscape format for the printout.
HCOP:TDST:STAT2 ON
//Includes date and time on the printout.
HCOP:ITEM:ALL
//Prints all screen elements
HCOP
//Initiates the printout.

```

### 13.9.7.7 Storing multiple graphical measurement results to a PDF file

This example demonstrates how to store graphical results from measurements in the Spectrum application and the I/Q Analyzer to a single PDF file. It assumes the Spectrum and I/Q Analyzer measurements have already been configured and performed, with the following screen layout:

'Spectrum': 1 Frequency Sweep

'Spectrum': 2 Spectrogram

'IQ Analyzer': 1 Magnitude

'IQ Analyzer': 2 Spectrum

```

//Switch to MultiView tab
DISP:ATAB ON

//Select windows to be stored to file
HCOP:CONT WIND
HCOP:PAGE:WIND:STAT 'Spectrum','1',ON
HCOP:PAGE:WIND:STAT 'Spectrum','2',ON
HCOP:PAGE:WIND:STAT 'IQ Analyzer','1',ON
HCOP:PAGE:WIND:STAT 'IQ Analyzer','2',ON

//Define contents to be printed on each page (logo, timestamp, page count)
DISP:LOGO ON
HCOP:TDST:STAT ON
HCOP:PAGE:COUN:STAT ON
//Define comment to be printed on each page
HCOP:ITEM:WIND:TEXT 'Measurement Test Report'

//Configure page layout (landscape, 1 display per page, margins 2cm on each side)
HCOP:PAGE:ORI1 LAND
HCOP:PAGE:WIND1:COUN 1
HCOP:PAGE:WIND1:SCAL 1
HCOP:PAGE:MARG1:BOTT 20
HCOP:PAGE:MARG1:LEFT 20
HCOP:PAGE:MARG1:RIGH 20
HCOP:PAGE:MARG1:TOP 20

//Configure the use of optimized colors for printout
HCOP:CMAP:DEF2

```

```
//Set format of printout to PDF.
HCOP:DEV:LANG1 PDF
//Define file name of printout
MME:NAME 'C:\R_S\instr\user\MeasurementTestReport.pdf'

//Store pdf of printout to file
HCOP:IMM
```

## 13.10 Configuring the FSW

The remote commands required to set up the FSW are described here.

• <a href="#">Configuring the reference frequency</a> .....	1389
• <a href="#">Calibration and checks</a> .....	1393
• <a href="#">Working with transducers</a> .....	1402
• <a href="#">Compensating for frequency response using touchstone files (R&amp;S FSW-K544)</a> .....	1406
• <a href="#">Customizing the screen layout</a> .....	1425
• <a href="#">Remote commands for language settings</a> .....	1432
• <a href="#">Configuring the network and remote control</a> .....	1433
• <a href="#">Configuring HUMS</a> .....	1438
• <a href="#">Checking the system configuration</a> .....	1444
• <a href="#">Signal generator control commands</a> .....	1454
• <a href="#">Using service functions</a> .....	1455
• <a href="#">Remote commands for synchronizing parameters</a> .....	1458
• <a href="#">Configuring the application starter</a> .....	1474
• <a href="#">Programming examples for instrument setup</a> .....	1477

### 13.10.1 Configuring the reference frequency

<a href="#">[SENSe:]ROSCillator:LBWidth</a> .....	1389
<a href="#">[SENSe:]ROSCillator:O100</a> .....	1390
<a href="#">[SENSe:]ROSCillator:O640</a> .....	1390
<a href="#">[SENSe:]ROSCillator:EXternal:FALLback</a> .....	1390
<a href="#">SOURce&lt;si&gt;:EXternal&lt;ext&gt;:ROSCillator:EXternal:FREQUENCY</a> .....	1391
<a href="#">[SENSe:]ROSCillator:OSYNc</a> .....	1391
<a href="#">[SENSe:]ROSCillator:SOURce</a> .....	1391
<a href="#">[SENSe:]ROSCillator:SOURce:EAUTO?</a> .....	1392
<a href="#">[SENSe:]ROSCillator:TRANge</a> .....	1393

---

#### **[SENSe:]ROSCillator:LBWidth <Bandwidth>**

Defines the loop bandwidth, that is, the speed of internal synchronization with the reference frequency. The setting requires a compromise between performance and increasing phase noise.

For a variable external reference frequency with a narrow tuning range ( $\pm 0.5$  ppm), the loop bandwidth is fixed to 0.1 Hz and cannot be changed.

**Parameters:**

<Bandwidth> 0.1 Hz | 1 Hz | 3 Hz | 10 Hz | 30 Hz | 100 Hz | 300 Hz  
 The possible values depend on the reference source and tuning range (see [Table 11-2](#)).  
 Default unit: Hz

**Example:** ROSC:LBW 3

**Manual operation:** See "[Loop Bandwidth](#)" on page 782

**[SENSe:]ROSCillator:O100 <State>**

**[SENSe:]ROSCillator:O640 <State>**

This command turns the output of a reference signal on the corresponding connector ("Ref Output") on and off.

[SENSe:]ROSCillator:O100: Provides a 100 MHz reference signal on corresponding connector.

[SENSe:]ROSCillator:O640: Provides a 640 MHz reference signal on corresponding connector.

**Parameters:**

<State> ON | OFF | 1 | 0  
**OFF | 0**  
 Switches the reference off.  
**ON | 1**  
 Switches the reference on

**Example:** //Output reference signal of 100 MHz.

ROSC:O100 ON

**Manual operation:** See "[Reference Frequency Output](#)" on page 782

**[SENSe:]ROSCillator:EXTernal:FALLback <State>**

Defines how the instrument reacts if an external reference is selected but none is available.

**Parameters:**

<State> ON | OFF | 0 | 1  
**OFF | 0**  
 If no valid external reference signal is available, the error message "External reference missing" is displayed. Additionally, the flag "NO REF" is displayed to indicate that no synchronization was performed *for the last measurement*.

**ON | 1**

If no external reference is available, the instrument automatically switches back to the internal reference. Note that you must re-activate the external reference if it becomes available again at a later time.

\*RST: 0

**Manual operation:** See "[Behavior in case of missing external reference](#)" on page 781

**SOURce<si>:EXTernal<ext>:ROSCillator:EXTernal:FREQUency <Frequency>**

This command defines the frequency of the external reference oscillator.

If the external reference oscillator is selected, the reference signal must be connected to the rear panel of the instrument.

**Suffix:**

<si> 1..n

<ext> 1..n

**Parameters:**

<Frequency> Range: 1 MHz to 50 MHz  
Default unit: HZ

**Example:**

```
ROSC:EXT:FREQ 13MHZ
Sets the frequency to 13 MHz.
SOUR:EXT:ROSC:EXT:FREQ 13MHZ
```

**Manual operation:** See "[Reference Frequency Input](#)" on page 780

**[SENSe:]ROSCillator:OSYNc <State>**

If enabled, a 100 MHz reference signal is provided to the "SYNC TRIGGER OUTPUT" connector.

**Parameters:**

<State> ON | OFF | 1 | 0

\*RST: 0

**Example:**

```
ROSC:OSYN ON
```

**Manual operation:** See "[Reference Frequency Output](#)" on page 782

**[SENSe:]ROSCillator:SOURce <Source>**

This command selects the reference oscillator.

If you want to select the external reference, it must be connected to the FSW.

**Parameters:**

<Source> **INTernal**  
The internal reference is used (10 MHz).

**EXTErnal | EXTErnal1 | EXT1**

The external reference from the "REF INPUT 10 MHZ" connector is used; if none is available, an error flag is displayed in the status bar.

**E10**

The external reference from "REF INPUT 1..50 MHZ" connector is used with a fixed 10 MHZ frequency; if none is available, an error flag is displayed in the status bar.

**E100**

The external reference from the "REF INPUT 100 MHZ / 1 GHZ" connector is used with a fixed 100 MHZ frequency; if none is available, an error flag is displayed in the status bar.

**E1000**

The external reference from "REF INPUT 100 MHZ / 1 GHZ" connector is used with a fixed 1 GHZ frequency; if none is available, an error flag is displayed in the status bar.

**EAUTO**

The external reference is used as long as it is available, then the instrument switches to the internal reference.

**SYNC**

The external reference is used; if none is available, an error flag is displayed in the status bar.

**Example:** `ROSC:SOUR EXT`

**Manual operation:** See "[Reference Frequency Input](#)" on page 780

**[SENSe:]ROSCillator:SOURce:EAUTO?**

This command queries the current reference type in case you have activated an automatic switch to the internal reference if the external reference is missing.

**Return values:**

<Reference>      INT | EXT  
**INT**  
 internal reference  
**EXT**  
 external reference

**Example:** `SENS:ROSC:SOUR:EAUT?`  
 Queries the currently available reference type.

**Usage:** Query only



**[SENSe:]ROSCillator:TRANge <Range>**

Defines the tuning range. The tuning range is only available for the variable external reference frequency. It determines how far the frequency may deviate from the defined level in parts per million ( $10^{-6}$ ).

**Parameters:**

&lt;Range&gt;

WIDE | SMALI

The possible values depend on the reference source (see [Table 11-2](#)).

**SMALI**

With this smaller deviation (+/- 0.5 ppm) a very narrow fixed loop bandwidth of 0.1 Hz is realized. With this setting the instrument can synchronize to an external reference signal with a very precise frequency. Due to the very narrow loop bandwidth, unwanted noise or spurious components on the external reference input signal are strongly attenuated. Furthermore, the loop requires about 30 seconds to reach a locked state. During this locking process, "NO REF" is displayed in the status bar.

**WIDE**

The larger deviation (+/- 6 ppm) allows the instrument to synchronize to less precise external reference input signals.

**Example:**

ROSC:TRAN WIDE

**Manual operation:** See "[Tuning Range](#)" on page 782

## 13.10.2 Calibration and checks

The following commands control calibration and checks on the FSW.

<a href="#">CALibration[:ALL]?</a> .....	1394
<a href="#">CALibration[:ALL]</a> .....	1394
<a href="#">CALibration:DUE:DAYs</a> .....	1395
<a href="#">CALibration:DUE:SCHEdule</a> .....	1395
<a href="#">CALibration:DUE:SHUTdown</a> .....	1396
<a href="#">CALibration:DUE:TIME</a> .....	1396
<a href="#">CALibration:DUE:WARMup</a> .....	1397
<a href="#">CALibration:INFO:OLD?</a> .....	1397
<a href="#">CALibration:PRESelection</a> .....	1397
<a href="#">CALibration:RESult?</a> .....	1398
<a href="#">DIAGnostic:SERVice:INPut:MC:CFRequency</a> .....	1398
<a href="#">DIAGnostic:SERVice:INPut:MC[:DISTance]</a> .....	1398
<a href="#">DIAGnostic:SERVice:INPut:MC:RANGe</a> .....	1399
<a href="#">DIAGnostic:SERVice:INPut:PULSed:CFRequency</a> .....	1399
<a href="#">DIAGnostic:SERVice:INPut:PULSed:MCFRequency</a> .....	1399
<a href="#">DIAGnostic:SERVice:INPut:PULSed:WBFRequency</a> .....	1400
<a href="#">DIAGnostic:SERVice:INPut:RF[:SPECtrum]</a> .....	1400
<a href="#">DIAGnostic:SERVice:INPut:AIQ[:TYPE]</a> .....	1400

DIAGnostic:SERvice:INPut[:SElect].....	1401
DIAGnostic:SERvice:STESt:RESult?.....	1401
SOURce<si>:TEMPerature:FRONtend.....	1401

**CALibration[:ALL]?****CALibration[:ALL] [<Mode>]**

This command initiates a calibration (self-alignment) routine and queries if calibration was successful.

During the acquisition of correction data the instrument does not accept any remote control commands.

**Note:** If you start a self-alignment remotely, then select the "Local" softkey while the alignment is still running, the instrument only returns to the manual operation state after the alignment is completed.

In order to recognize when the acquisition of correction data is completed, the MAV bit in the status byte can be used. If the associated bit is set in the Service Request Enable (SRE) register, the instrument generates a service request after the acquisition of correction data has been completed.

**Setting parameters:**

<Mode>                   AClear  
 optional: Performs an extended self-alignment as performed in the factory. Any previous self-alignment results are deleted. Note that this process takes longer than the common self-alignment.

**Return values:**

<CalibrationFailed>   ON | OFF | 0 | 1  
**OFF | 0**  
 Calibration was successful.  
**ON | 1**  
 Calibration was not successful.

**Example:**

```
*CLS
Resets the status management.
*SRE 16
Enables MAV bit in the Service Request Enable register.
*CAL?
Starts the correction data recording, and then a service request is generated.
```

**Example:**

```
CAL:ALL ACLEAR
Deletes any existing self-alignment results and performs an extended self-alignment as performed in the factory.
```

**Manual operation:** See "[Align all](#)" on page 732

---

**CALibration:DUE:DAYs** <Day1>[, <Day2>, <Day3>, <Day4>, <Day5>, <Day6>, <Day7>]

Defines the days on which a self-alignment is scheduled for `CALibration:DUE:SCHEdule ON`. Up to 7 different days can be scheduled.

**Parameters:**

<Day1>	ALL   MONDay   TUESday   WEDNesday   THURsday   FRIDay   SATurday   SUNDay
<Day2>	ALL   MONDay   TUESday   WEDNesday   THURsday   FRIDay   SATurday   SUNDay
<Day3>	ALL   MONDay   TUESday   WEDNesday   THURsday   FRIDay   SATurday   SUNDay
<Day4>	ALL   MONDay   TUESday   WEDNesday   THURsday   FRIDay   SATurday   SUNDay
<Day5>	ALL   MONDay   TUESday   WEDNesday   THURsday   FRIDay   SATurday   SUNDay
<Day6>	ALL   MONDay   TUESday   WEDNesday   THURsday   FRIDay   SATurday   SUNDay
<Day7>	ALL   MONDay   TUESday   WEDNesday   THURsday   FRIDay   SATurday   SUNDay

**Example:** //Schedule a self-alignment every Monday and Friday  
`CAL:DUE:DAYs MOND,FRID`

**Example:** //Schedule a self-alignment every Sunday at 2 AM after a warmup period, then shut down instrument.  
`CAL:DUE:WARM`  
`CAL:DUE:SCH ON`  
`CAL:DUE:DAYs SUND`  
`CAL:DUE:TIME '2:00'`  
`CAL:DUE:SHUT`

**Manual operation:** See "[Schedule](#)" on page 731

---

**CALibration:DUE:SCHEdule** <State>

If enabled, a self-alignment is performed regularly at specific days and time. Specify the date and time using the `CALibration:DUE:DAYs` and `CALibration:DUE:TIME` commands.

**Parameters:**

<State>	ON   OFF   0   1
	<b>OFF   0</b> Switches the function off
	<b>ON   1</b> Switches the function on
*RST:	0

**Example:** //Schedule a self-alignment every Sunday at 2 AM after a warmup period, then shut down instrument.

```
CAL:DUE:WARM
CAL:DUE:SCH ON
CAL:DUE:DAYS SUND
CAL:DUE:TIME '2:00'
CAL:DUE:SHUT
```

**Manual operation:** See "[Schedule](#)" on page 731

### CALibration:DUE:SHUTdown <State>

If activated, the FSW is automatically shut down after self-alignment is completed. Note that the instrument cannot be restarted via remote control.

**Parameters:**

<State> ON | OFF | 0 | 1

**OFF | 0**  
Switches the function off

**ON | 1**  
Switches the function on

\*RST: 0

**Example:** //Schedule a self-alignment every Sunday at 2 AM after a warmup period, then shut down instrument.

```
CAL:DUE:WARM
CAL:DUE:SCH ON
CAL:DUE:DAYS SUND
CAL:DUE:TIME '2:00'
CAL:DUE:SHUT
```

**Manual operation:** See "[Shut down Device after Self Alignment](#)" on page 731

### CALibration:DUE:TIME <Time>

Defines the time at which a self-alignment is scheduled for the days specified by [CALibration:DUE:DAYS](#), if [CALibration:DUE:SCchedule](#) ON.

**Parameters:**

<Time> string with format 'hh:mm' (24 hours)

**Example:** //Schedule a self-alignment every Sunday at 2 AM after a warmup period, then shut down instrument.

```
CAL:DUE:WARM
CAL:DUE:SCH ON
CAL:DUE:DAYS SUND
CAL:DUE:TIME '2:00'
CAL:DUE:SHUT
```

**Manual operation:** See "[Schedule](#)" on page 731

**CALibration:DUE:WARMup** <State>

If enabled, self-alignment is started automatically after the warmup operation has completed.

**Parameters:**

<State>                    ON | OFF | 0 | 1  
**OFF | 0**  
 Switches the function off  
**ON | 1**  
 Switches the function on  
 \*RST:                    0

**Example:**                //Schedule a self-alignment every Sunday at 2 AM after a warmup period, then shut down instrument.

```
CAL:DUE:WARM
CAL:DUE:SCH ON
CAL:DUE:DAYS SUND
CAL:DUE:TIME '2:00'
CAL:DUE:SHUT
```

**Manual operation:**    See ["Await Warm-Up Operation before Self Alignment"](#) on page 731

**CALibration:INFO:OLD?**

Indicates whether self-alignment is overdue. By default, a reminder is shown in the status bar of the instrument 30 days after the last self-alignment took place.

**Parameters:**

<State>                    ON | OFF | 0 | 1  
**OFF | 0**  
 No reminder is displayed, self-alignment not due yet.  
**ON | 1**  
 Reminder is displayed, self-alignment is overdue.  
 \*RST:                    0

**Return values:**

<State>

**Usage:**                    Query only

**Manual operation:**    See ["Regular Reminder"](#) on page 732

**CALibration:PRESelection**

Due to changes in temperature, the YIG-preselector frequency may become slightly offset. This command re-aligns the preselector quickly, without requiring a full self-alignment of the FSW. For FSW85 models, the YIG2 filter is also re-aligned.

This command is only available for FSW models 1331.5003Kxx, and only if a YIG-pre-selector is available.

**Example:**           CAL: PRES?  
                  Result:  
                  0

**Manual operation:** See "[Start Preselector Centering](#)" on page 732

### CALibration:RESult?

This command returns the results collected during calibration.

**Return values:**

<CalibrationData>   String containing the calibration data.

**Example:**           CAL: RES?  
                  would return, e.g.  
                  [...]  
                  Total Calibration Status:  
                  PASSED, Date (dd/mm/yyyy): 12/07/2004,  
                  Time: 16:24:54, Runtime: 00.06

**Usage:**             Query only

**Manual operation:** See "[Alignment Results:](#)" on page 733

### DIAGnostic:SERVice:INPut:MC:CFRequency <Frequency>

This command defines the frequency of the calibration signal for FSW models 43 GHz and higher.

This command only takes effect if a microwave calibration signal is selected for input ([DIAGnostic:SERVice:INPut\[:SELect\]](#) on page 1401)

**Parameters:**

<Frequency>           \*RST:       8.004 GHz  
                          Default unit: Hz

**Manual operation:** See "[Calibration Frequency MW](#)" on page 800

### DIAGnostic:SERVice:INPut:MC[:DISTance] <Bandwidth>

This command selects the distance of the peaks of the microwave calibration signal for calibration of the YIG filter.

This command is only available for instrument models FSW13/26.

**Parameters:**

<Bandwidth>           WIDE | SMALI  
                          **SMALI**  
                          Small offset of combine frequencies.

**WIDE**

Wide offset of combine frequencies.

**Manual operation:** See "[Calibration Frequency MW](#)" on page 800

**DIAGnostic:SERVice:INPut:MC:RANGe** <Range>

For FSW85 models using a microwave calibration signal ([DIAG:SERV:INP:MCAL](#)). Defines the spectrum of the calibration as 43.5 GHz, or a wideband signal that covers the complete 85 GHz bandwidth. You can define the frequency of the microwave calibration signal using [DIAGnostic:SERVice:INPut:MC:CFrequency](#).

**Parameters:**

<Range> 43.5 GHz | 85 GHz  
Default unit: HZ

**Example:**

```
DIAG:SERV:INP:MCAL
DIAG:SERV:INP:MC:RANG 85000000
DIAG:SERV:INP:MC:CFR 7399700
```

**Manual operation:** See "[Calibration Frequency MW](#)" on page 800

**DIAGnostic:SERVice:INPut:PULSed:CFrequency** <Frequency>

This command defines the frequency of the calibration signal.

Before you can use the command, you have to feed in a calibration signal with [DIAGnostic:SERVice:INPut\[:SElect\]](#) on page 1401.

**Parameters:**

<Frequency> Possible frequencies of the calibration signal are fix.  
If you define a frequency that is not available, the FSW uses the next available frequency. Example: a frequency of 20 MHz is rounded up to the next available frequency (25 MHz).  
\*RST: 50 MHz  
Default unit: Hz

**Manual operation:** See "[Calibration Frequency RF](#)" on page 799

**DIAGnostic:SERVice:INPut:PULSed:MCFrequency** <Frequency>

This command sets the calibration frequency for frequencies greater than 7 GHz. This command only takes effect if a microwave calibration signal is selected for input ([DIAGnostic:SERVice:INPut\[:SElect\]](#) on page 1401).

**Parameters:**

<Frequency> \*RST: 7 GHz  
Default unit: Hz

**Example:**

```
DIAG:SERV:INP:PULS:MCFR 7.1 GHz
```

**DIAGnostic:SERVice:INPut:PULSed:WBFRequency** <Frequency>

Defines the frequency of the internal broadband calibration signal to be used for IF filter calibration.

This command is only available if the bandwidth extension option R&S FSW-B160 is installed.

Before you can use the command, you have to feed in a calibration signal with [DIAGnostic:SERVice:INPut\[:SElect\]](#) on page 1401.

**Parameters:**

<Frequency> 2 MHz | 4 MHz | 8 MHz | 16 MHz

If you define a frequency that is not available, the FSW uses the next available frequency.

\*RST: 16 MHz

Default unit: Hz

**Example:**

```
DIAG:SERV:INP:PULS:WBFR 8 MHz
```

Defines a calibration signal frequency of 8 MHz.

**Example:**

```
DIAG:SERV:INP:SEL WBC
```

```
DIAG:SERV:INP:PULS:WBFR 4MHz
```

**DIAGnostic:SERVice:INPut:RF[:SPECTrum]** <Bandwidth>

This command selects the bandwidth of the calibration signal.

**Parameters:**

<Bandwidth> NARRowband | BROadband

**NARRowband**

Narrowband signal for power calibration of the frontend.

**BROadband**

Broadband signal for calibration of the IF filter.

**Manual operation:** See "[Spectrum](#)" on page 799

**DIAGnostic:SERVice:INPut:AIQ[:TYPE]** <SignalType>

This command defines the type of calibration signal to be used for the optional "Analog Baseband" interface. This command is only available if the option is installed.

**Parameters:**

<SignalType> AC | DC | DCZero

**AC**

1.5625 MHz square wave AC signal

**DC**

DC signal

**DCZero**

no signal

\*RST: AC



**Example:** `DIAG:SERV:INP:AIQ:TYPE DCZ`

**Manual operation:** See ["Calibration Signal Type"](#) on page 800

#### **DIAGnostic:SERVice:INPut[:SElect] <Signal>**

This command activates or deactivates the use of an internal calibration signal as input for the FSW.

#### **Parameters:**

<Signal>

#### **CALibration**

Uses the calibration signal as RF input.

#### **MCALibration**

Uses the calibration signal for the microwave range as RF input.

#### **RF**

Uses the signal from the RF input.

#### **AIQ**

Uses the analog baseband calibration signal as input to the optional "Analog Baseband" interface. This signal is only available if the option is installed.

\*RST: RF

**Example:** `//Select calibration signal source`

`DIAG:SERV:INP RF`

**Manual operation:** See ["NONE"](#) on page 799  
 See ["Calibration Frequency RF"](#) on page 799  
 See ["Calibration Frequency MW"](#) on page 800  
 See ["Calibration Analog Baseband"](#) on page 800

#### **DIAGnostic:SERVice:STES:RESult?**

This command queries the self-test results.

#### **Return values:**

<Results>

String of data containing the results.

The rows of the self-test result table are separated by commas.

#### **Example:**

`DIAG:SERV:STES:RES?`

would return, e.g.

`"Total Selftest Status:`

`PASSED", "Date (dd/mm/yyyy): 09/07/2004 TIME:`

`16:24:54", "Runtime: 00:06", "...`

#### **Usage:**

Query only

#### **SOURce<si>:TEMPerature:FRONTend**

This command queries the current frontend temperature of the FSW.

During self-alignment, the instrument's (frontend) temperature is also measured (as soon as the instrument has warmed up completely). This temperature is used as a reference for a continuous temperature check during operation. If the current temperature deviates from the stored self-alignment temperature by a certain degree, a warning is displayed in the status bar indicating the resulting deviation in the measured power levels. A status bit in the `STATUS:QUESTIONABLE:TEMPERATURE` register indicates a possible deviation.

**Suffix:**

<si> irrelevant

**Return values:**

<Temperature> Temperature in degrees Celsius.

**Example:**

`SOUR:TEMP:FRON?`

Queries the temperature of the frontend sensor.

### 13.10.3 Working with transducers

The following commands configure and control transducer factors.

#### Useful commands for transducer management described elsewhere

- `MMEMory:SElect[:ITEM]:TRANsducer:ALL` on page 1357

#### Remote commands exclusive to transducer management

<code>[SENSe:]CORRection:TRANsducer:ADJust:RLEVel[:STATe]</code> .....	1402
<code>[SENSe:]CORRection:TRANsducer:CATalog?</code> .....	1403
<code>[SENSe:]CORRection:TRANsducer:COMMeNt</code> .....	1403
<code>[SENSe:]CORRection:TRANsducer:DATA</code> .....	1403
<code>[SENSe:]CORRection:TRANsducer:DELeTe</code> .....	1404
<code>[SENSe:]CORRection:TRANsducer:SCALing</code> .....	1404
<code>[SENSe:]CORRection:TRANsducer:SELeCt</code> .....	1404
<code>[SENSe:]CORRection:TRANsducer[:STATe]</code> .....	1405
<code>[SENSe:]CORRection:TRANsducer:UNIT</code> .....	1405
<code>MMEMory:LOAD&lt;n&gt;:TFACtor</code> .....	1405
<code>MMEMory:STORe&lt;n&gt;:TFACtor</code> .....	1406

---

#### `[SENSe:]CORRection:TRANsducer:ADJust:RLEVel[:STATe]` <State>

This command turns an automatic adjustment of the reference level to the transducer on and off.

Before you can use the command, you have to select and turn on a transducer.

**Parameters:**

<State> ON | OFF | 1 | 0  
\*RST: 0

**Manual operation:** See "[Adjust Ref Level](#)" on page 759

**[SENSe:]CORRection:TRANsducer:CATalog?**

This command queries all transducer factors stored on the FSW.

After general data for the transducer storage directory, data for the individual files is listed.

The result is a comma-separated list of values with the following syntax:

<UsedMem>,<FreeMem>,<FileSize>,<FileName>[,<FileSize>,<FileName>]

For details see [Chapter 11.4.1, "Basics on transducer factors"](#), on page 754.

**Return values:**

<UsedDiskSpace>	numeric value in bytes Amount of storage space required by all transducers files in the C:\Program Files (x86)\Rohde-Schwarz\FSW\<version>\trd directory (= sum of all individual <FileSize> values)
<FreeDiskSpace>	numeric value in bytes Amount of free storage space on the FSW
<FileSize>	numeric value in bytes Size of a single transducer file
<FileName>	string Name of a single transducer file

**Example:**

```
SENSE:CORR:TRAN:CAT?
//Result: 2743,2312620544,720,'FactorGSM.TDF',2023,'FactorBTS.TDF'
```

**Usage:** Query only

**[SENSe:]CORRection:TRANsducer:COMMeNt <Comment>**

This command defines the comment for the selected transducer factor.

Before you can use the command, you have to select and turn on a transducer.

**Parameters:**

<Comment> \*RST: (empty comment)

**Manual operation:** See "[Comment](#)" on page 760

**[SENSe:]CORRection:TRANsducer:DATA {<Frequency>, <Level>}...**

This command configures transducer factors for specific trace points. A set of transducer factors defines an interpolated transducer line and can be stored on the instrument. You can define up to 1001 points.

For details see [Chapter 11.4.1, "Basics on transducer factors"](#), on page 754.

**Parameters:**

<Frequency> The unit for <Frequency> is Hz, which may or may not be omitted. Frequencies have to be sorted in ascending order.

Default unit: Hz

<Level>

The unit for <Level> depends on `[SENSe:]CORRection:TRANsdUcer:UNIT`.

**Example:**

```
SENSe1:CORRection:TRANsdUcer:UNIT 'DB'
// Frequency Span 0 Hz to 4 Ghz
SENSe1:CORRection:TRANsdUcer:DATA 0,8,2GHz,5,4GHz,3
```

**Manual operation:** See ["Data Points"](#) on page 761

*Table 13-12: Created transducer points in example*

Frequency	Level
0 Hz	8 dB
2 GHz	5 dB
4 GHz	3 dB

**[SENSe:]CORRection:TRANsdUcer:DELeTe**

This command deletes the currently selected transducer factor.

Before you can use the command, you have to select a transducer.

**Example:**

```
CORR:TRAN:DEL
```

**Manual operation:** See ["Delete Line"](#) on page 759

**[SENSe:]CORRection:TRANsdUcer:SCALing <ScalingType>**

This command selects the frequency scaling of the transducer factor.

**Parameters:**

<ScalingType> LINear | LOGarithmic  
\*RST: LINear

**Manual operation:** See ["X-Axis Scaling"](#) on page 761

**[SENSe:]CORRection:TRANsdUcer:SELeCt <Name>**

This command selects a transducer factor.

**Parameters:**

<Name> String containing the name of the transducer factor.  
If the name does not exist yet, the FSW creates a transducer factor by that name.

**Example:**

```
CORR:TRAN:SEL 'FACTOR1'
```

**Manual operation:** See ["Activating / Deactivating"](#) on page 758  
 See ["Create New Line"](#) on page 759  
 See ["Name"](#) on page 760

---

**[SENSe:]CORRection:TRANsducer[:STATe] <State>**

This command turns the selected transducer factor on or off.

Before you can use the command, you have to select a transducer.

**Parameters:**

<State> ON | OFF | 1 | 0  
 \*RST: 0

**Manual operation:** See ["Activating / Deactivating"](#) on page 758

---

**[SENSe:]CORRection:TRANsducer:UNIT <Unit>**

This command selects the unit of the transducer factor.

Before you can use the command, you have to select and turn on a transducer.

**Parameters:**

<Unit> string as defined in table below  
 \*RST: DB

**Example:** CORR:TRAN:UNIT 'DBUV'

**Manual operation:** See ["Unit"](#) on page 761

String	Unit
'DB'	dB
'DBM'	dBm
'DBMV'	dBmV
'DBUV'	dB $\mu$ V
'DBUV/M'	dB $\mu$ V/m (Requires R&S FSW-K54 (EMI measurements) option.)
'DBUA'	dB $\mu$ A
'DBUA/M'	dB $\mu$ A/m (Requires R&S FSW-K54 (EMI measurements) option.)
'DBPW'	dBpW
'DBPT'	dBpT

---

**MMEMory:LOAD<n>:TFACTOR <FileName>**

Loads the transducer factor from the selected file in .CSV format.

**Suffix:**

<n> irrelevant

**Parameters:**

<FileName> String containing the path and name of the CSV import file.

**Example:**

```
MMEM:LOAD:TFAC 'C:\TEST.CSV'
```

**Manual operation:** See "Import" on page 762

**MMEMory:STORe<n>:TFACtor <FileName>, <TransdName>**

Exports transducer factor data to an ASCII (CSV) file.

For details on the file format see [Chapter 11.4.3, "Reference: transducer factor file format"](#), on page 762.

**Suffix:**

<n> irrelevant

**Parameters:**

<FileName> Name of the transducer factor to be exported.

<TransdName> Name of the transducer factor to be exported.

**Example:**

```
MMEM:STOR:TFAC 'C:\TEST', 'Transducer1'
```

Stores the transducer factor named "Transducer1" in the file TEST.CSV.

**Manual operation:** See "Export" on page 762

### 13.10.4 Compensating for frequency response using touchstone files (R&S FSW-K544)

If the Frequency Response Correction option (R&S FSW-K544) is installed, the FSW supports the use of Touchstone (.SnP) files, as well as additional frequency response correction files in .fres format.

For details, see [Chapter 11.5, "Frequency response correction \(R&S FSW-K544\)"](#), on page 767.

- [Remote commands for frequency response correction](#)..... 1406
- [Programming example: using touchstone files](#)..... 1424

#### 13.10.4.1 Remote commands for frequency response correction

The following commands are only available if the Frequency Response Correction option (R&S FSW-K544) is installed.



### Input-specific frequency correction

Frequency response correction can be configured for all inputs, or for particular input types only. Be sure to use the correct command for the required setting.

- [SENSe:]CORRection:FRESponse:INPut<ip>:USER: commands are applied to RF input only
- [SENSe:]CORRection:FRESponse:BASEband:USER: commands are applied to baseband input only
- [SENSe:]CORRection:FRESponse:USER: commands are applied to all input types; queries refer to the currently active input source

[SENSe:]CORRection:FRESponse<si>:BASEband:USER:ADJust:RLEVel:STATe.....	1409
[SENSe:]CORRection:FRESponse<si>:FILE:USER:ADJust:RLEVel:STATe.....	1409
[SENSe:]CORRection:FRESponse<si>:INPut<ip>:USER:ADJust:RLEVel:STATe.....	1409
[SENSe:]CORRection:FRESponse<si>:USER:ADJust:RLEVel:STATe.....	1409
[SENSe:]CORRection:FRESponse<si>:BASEband:USER:FLISt<fli>:CATalog?.....	1409
[SENSe:]CORRection:FRESponse<si>:INPut<ip>:USER:FLISt<fli>:CATalog?.....	1409
[SENSe:]CORRection:FRESponse<si>:USER:FLISt<fli>:CATalog?.....	1409
[SENSe:]CORRection:FRESponse<si>:BASEband:USER:FLISt<fli>:CLEar.....	1410
[SENSe:]CORRection:FRESponse<si>:INPut<ip>:USER:FLISt<fli>:CLEar.....	1410
[SENSe:]CORRection:FRESponse<si>:USER:FLISt<fli>:CLEar.....	1410
[SENSe:]CORRection:FRESponse<si>:USER:FLISt<fli>:DATA:FREQuency?.....	1410
[SENSe:]CORRection:FRESponse<si>:USER:FLISt<fli>:DATA:MAGNitude?.....	1410
[SENSe:]CORRection:FRESponse<si>:USER:FLISt<fli>:DATA:PHASe?.....	1410
[SENSe:]CORRection:FRESponse<si>:BASEband:USER:FLISt<fli>:INSert.....	1410
[SENSe:]CORRection:FRESponse<si>:INPut<ip>:USER:FLISt<fli>:INSert.....	1410
[SENSe:]CORRection:FRESponse<si>:USER:FLISt<fli>:INSert.....	1410
[SENSe:]CORRection:FRESponse<si>:BASEband:USER:FLISt<fli>:MAGNitude[:STATe]....	1411
[SENSe:]CORRection:FRESponse<si>:INPut<ip>:USER:FLISt<fli>:MAGNitude[:STATe]....	1411
[SENSe:]CORRection:FRESponse<si>:USER:FLISt<fli>:MAGNitude[:STATe].....	1411
[SENSe:]CORRection:FRESponse<si>:BASEband:USER:FLISt<fli>:PHASe[:STATe].....	1412
[SENSe:]CORRection:FRESponse<si>:INPut<ip>:USER:FLISt<fli>:PHASe[:STATe].....	1412
[SENSe:]CORRection:FRESponse<si>:USER:FLISt<fli>:PHASe[:STATe].....	1412
[SENSe:]CORRection:FRESponse<si>:BASEband:USER:FLISt<fli>:REMOve.....	1412
[SENSe:]CORRection:FRESponse<si>:INPut<ip>:USER:FLISt<fli>:REMOve.....	1412
[SENSe:]CORRection:FRESponse<si>:USER:FLISt<fli>:REMOve.....	1412
[SENSe:]CORRection:FRESponse<si>:BASEband:USER:FLISt<fli>:SELeCt.....	1413
[SENSe:]CORRection:FRESponse<si>:INPut<ip>:USER:FLISt<fli>:SELeCt.....	1413
[SENSe:]CORRection:FRESponse<si>:USER:FLISt<fli>:SELeCt.....	1413
[SENSe:]CORRection:FRESponse<si>:BASEband:USER:FLISt<fli>:SIZE?.....	1413
[SENSe:]CORRection:FRESponse<si>:INPut<ip>:USER:FLISt<fli>:SIZE?.....	1413
[SENSe:]CORRection:FRESponse<si>:USER:FLISt<fli>:SIZE?.....	1413
[SENSe:]CORRection:FRESponse<si>:USER:FSTate.....	1413
[SENSe:]CORRection:FRESponse<si>:USER:IQ:DATA:FREQuency?.....	1414
[SENSe:]CORRection:FRESponse<si>:USER:IQ:DATA:MAGNitude?.....	1414
[SENSe:]CORRection:FRESponse<si>:USER:IQ:DATA:PHASe?.....	1414
[SENSe:]CORRection:FRESponse<si>:BASEband:USER:LOAD.....	1414
[SENSe:]CORRection:FRESponse<si>:INPut<ip>:USER:LOAD.....	1414
[SENSe:]CORRection:FRESponse<si>:USER:LOAD.....	1414

[SENSe:]CORRection:FRESponse<si>:BASEband:USER:PRESet.....	1415
[SENSe:]CORRection:FRESponse<si>:INPut<ip>:USER:PRESet.....	1415
[SENSe:]CORRection:FRESponse<si>:USER:PRESet.....	1415
[SENSe:]CORRection:FRESponse<si>:BASEband:USER:REFResh.....	1415
[SENSe:]CORRection:FRESponse<si>:INPut<ip>:USER:REFResh.....	1415
[SENSe:]CORRection:FRESponse<si>:USER:SCOPE.....	1415
[SENSe:]CORRection:FRESponse<si>:USER:SCOVered?.....	1416
[SENSe:]CORRection:FRESponse<si>:BASEband:USER:SLISt<sli>:CATalog?.....	1416
[SENSe:]CORRection:FRESponse<si>:INPut<ip>:USER:SLISt<sli>:CATalog?.....	1416
[SENSe:]CORRection:FRESponse<si>:USER:SLISt<sli>:CATalog?.....	1416
[SENSe:]CORRection:FRESponse<si>:BASEband:USER:SLISt<sli>:CLEar.....	1417
[SENSe:]CORRection:FRESponse<si>:INPut<ip>:USER:SLISt<sli>:CLEar.....	1417
[SENSe:]CORRection:FRESponse<si>:USER:SLISt<sli>:CLEar.....	1417
[SENSe:]CORRection:FRESponse<si>:USER:SLISt<sli>:DATA:FREQuency<spi>?.....	1417
[SENSe:]CORRection:FRESponse<si>:USER:SLISt<sli>:DATA:MAGNitude<spi>?.....	1417
[SENSe:]CORRection:FRESponse<si>:USER:SLISt<sli>:DATA:PHASe<spi>?.....	1417
[SENSe:]CORRection:FRESponse<si>:BASEband:USER:SLISt<sli>:INSert.....	1418
[SENSe:]CORRection:FRESponse<si>:INPut<ip>:USER:SLISt<sli>:INSert.....	1418
[SENSe:]CORRection:FRESponse<si>:USER:SLISt<sli>:INSert.....	1418
[SENSe:]CORRection:FRESponse<si>:BASEband:USER:SLISt<sli>:MOVE.....	1418
[SENSe:]CORRection:FRESponse<si>:INPut<ip>:USER:SLISt<sli>:MOVE.....	1418
[SENSe:]CORRection:FRESponse<si>:USER:SLISt<sli>:MOVE.....	1418
[SENSe:]CORRection:FRESponse<si>:BASEband:USER:SLISt<sli>:PORTs:FROM.....	1419
[SENSe:]CORRection:FRESponse<si>:INPut<ip>:USER:SLISt<sli>:PORTs:FROM.....	1419
[SENSe:]CORRection:FRESponse<si>:USER:SLISt<sli>:PORTs:FROM.....	1419
[SENSe:]CORRection:FRESponse<si>:BASEband:USER:SLISt<sli>:PORTs:TO.....	1419
[SENSe:]CORRection:FRESponse<si>:INPut<ip>:USER:SLISt<sli>:PORTs:TO.....	1419
[SENSe:]CORRection:FRESponse<si>:USER:SLISt<sli>:PORTs:TO.....	1419
[SENSe:]CORRection:FRESponse<si>:BASEband:USER:SLISt<sli>:REMOve.....	1420
[SENSe:]CORRection:FRESponse<si>:INPut<ip>:USER:SLISt<sli>:REMOve.....	1420
[SENSe:]CORRection:FRESponse<si>:USER:SLISt<sli>:REMOve.....	1420
[SENSe:]CORRection:FRESponse<si>:USER:PSTate.....	1420
[SENSe:]CORRection:FRESponse<si>:BASEband:USER:SLISt<sli>:SELEct.....	1421
[SENSe:]CORRection:FRESponse<si>:INPut<ip>:USER:SLISt<sli>:SELEct.....	1421
[SENSe:]CORRection:FRESponse<si>:USER:SLISt<sli>:SELEct.....	1421
[SENSe:]CORRection:FRESponse<si>:BASEband:USER:SLISt<sli>:SIZE?.....	1421
[SENSe:]CORRection:FRESponse<si>:INPut<ip>:USER:SLISt<sli>:SIZE?.....	1421
[SENSe:]CORRection:FRESponse<si>:USER:SLISt<sli>:SIZE?.....	1421
[SENSe:]CORRection:FRESponse<si>:BASEband:USER:SLISt<sli>:STATe.....	1422
[SENSe:]CORRection:FRESponse<si>:INPut<ip>:USER:SLISt<sli>:STATe.....	1422
[SENSe:]CORRection:FRESponse<si>:USER:SLISt<sli>:STATe.....	1422
[SENSe:]CORRection:FRESponse<si>:USER:SPECtrum:DATA:FREQuency?.....	1422
[SENSe:]CORRection:FRESponse<si>:USER:SPECtrum:DATA:MAGNitude?.....	1422
[SENSe:]CORRection:FRESponse<si>:USER:SPECtrum:DATA:PHASe?.....	1422
[SENSe:]CORRection:FRESponse<si>:BASEband:USER:STATe.....	1423
[SENSe:]CORRection:FRESponse<si>:INPut<ip>:USER:STATe.....	1423
[SENSe:]CORRection:FRESponse<si>:USER:STATe.....	1423
[SENSe:]CORRection:FRESponse<si>:BASEband:USER:STORe.....	1423



[SENSe:]CORRection:FRESponse<si>:INPut<ip>:USER:STORe..... 1423  
 [SENSe:]CORRection:FRESponse<si>:USER:STORe..... 1423  
 [SENSe:]CORRection:FRESponse<si>:USER:VALid?..... 1424

---

[SENSe:]CORRection:FRESponse<si>:BASEband:USER:ADJust:RLEVel:STATe  
 <State>

[SENSe:]CORRection:FRESponse<si>:FILE:USER:ADJust:RLEVel:STATe <State>

[SENSe:]CORRection:FRESponse<si>:INPut<ip>:USER:ADJust:RLEVel:STATe  
 <State>

[SENSe:]CORRection:FRESponse<si>:USER:ADJust:RLEVel:STATe <State>

Activates or deactivates the automatic adjustment of the reference level to the active filter calculation configuration. The offset is the mean of the filter calculation.

For details and restrictions see "[Adjust Ref Level](#)" on page 773.

**Suffix:**

<si> 1..n  
 irrelevant

**Parameters:**

<State> ON | OFF | 0 | 1  
**OFF | 0**  
 Switches the function off  
**ON | 1**  
 Switches the function on  
 \*RST: 0

**Manual operation:** See "[Adjust Ref Level](#)" on page 773

---

[SENSe:]CORRection:FRESponse<si>:BASEband:USER:FLISt<fli>:CATalog?

[SENSe:]CORRection:FRESponse<si>:INPut<ip>:USER:FLISt<fli>:CATalog?

[SENSe:]CORRection:FRESponse<si>:USER:FLISt<fli>:CATalog?

Returns a list of currently available .fres files in the directory.

**Suffix:**

<si> 1..n  
 irrelevant

<fli> 1..n  
 irrelevant

**Return values:**

<List>

**Example:** SENS:CORR:FRES:USER:FLIS:CAT?

**Usage:** Query only

---

```
[SENSe:]CORRection:FRESponse<si>:BASEband:USER:FLISt<fli>:CLEar
[SENSe:]CORRection:FRESponse<si>:INPut<ip>:USER:FLISt<fli>:CLEar
[SENSe:]CORRection:FRESponse<si>:USER:FLISt<fli>:CLEar
```

Removes all frequency response (.fres) files in the current configuration for the selected or all input types.

**Suffix:**

<si>	1..n irrelevant
<fli>	1..n irrelevant

**Example:** SENS:CORR:FRES:USER:FLIS:CLE

**Usage:** Event

**Manual operation:** See "[Remove Frequency Response File](#)" on page 776

---

```
[SENSe:]CORRection:FRESponse<si>:USER:FLISt<fli>:DATA:FREQuency?
[SENSe:]CORRection:FRESponse<si>:USER:FLISt<fli>:DATA:MAGNitude?
[SENSe:]CORRection:FRESponse<si>:USER:FLISt<fli>:DATA:PHASe?
```

Queries the trace values for the selected .fres file.

**Suffix:**

<si>	1..n irrelevant
<fli>	1..n Index in frequency response file list Use <a href="#">[SENSe:]CORRection:FRESponse&lt;si&gt;:BASEband:USER:FLISt&lt;fli&gt;:SIZE?</a> to determine the maximum index number.

**Example:** SENS:CORR:FRES:USER:FLIS2:DATA:PHAS?

**Usage:** Query only

**Manual operation:** See "[Selected File](#)" on page 776

---

```
[SENSe:]CORRection:FRESponse<si>:BASEband:USER:FLISt<fli>:INSert
<FilePath>
[SENSe:]CORRection:FRESponse<si>:INPut<ip>:USER:FLISt<fli>:INSert
<FilePath>
[SENSe:]CORRection:FRESponse<si>:USER:FLISt<fli>:INSert <FilePath>
```

Loads a frequency response (.fres) file to the current configuration. The maximum number of files per configuration is 15. The new file is added below the entry specified by the <fli> index. All other entries with a higher suffix are moved down by one position.

**Suffix:**

<si> 1..n  
irrelevant

<fli> 1..n  
Index in frequency response file list  
Use [SENSe:]CORRection:FRESponse<si>:BASEband:USER:FLISt<fli>:SIZE? to determine the maximum index number.

**Parameters:**

<FilePath> string  
Path and file name  
The default directory for .fres files is C:\R\_S\INSTR\USER\Fresponse.

**Example:** SENS:CORR:FRES:USER:FLIS2:INS 'C:\FRes.fres'

**Manual operation:** See "Add Freq Resp File" on page 776

[SENSe:]CORRection:FRESponse<si>:BASEband:USER:FLISt<fli>:MAGNitude[:STATE] <State>

[SENSe:]CORRection:FRESponse<si>:INPut<ip>:USER:FLISt<fli>:MAGNitude[:STATE] <State>

[SENSe:]CORRection:FRESponse<si>:USER:FLISt<fli>:MAGNitude[:STATE] <State>

Activates or deactivates the use of the correction data in the selected file for magnitude results.

**Suffix:**

<si> 1..n  
irrelevant

<fli> 1..n  
Index in frequency response file list  
Use [SENSe:]CORRection:FRESponse<si>:BASEband:USER:FLISt<fli>:SIZE? to determine the maximum index number.

**Parameters:**

<State> ON | OFF | 0 | 1  
**OFF | 0**  
Applies the data for magnitude results.  
**ON | 1**  
Does not apply the data for magnitude results.  
\*RST: 1

**Example:** SENS:CORR:FRES:USER:FLIS2:MAGN:STAT ON

**Manual operation:** See "Magnitude" on page 776

---

```
[SENSe:]CORRection:FRESponse<si>:BASEband:USER:FLISt<fli>:PHASe[:
  STATE] <State>
```

```
[SENSe:]CORRection:FRESponse<si>:INPut<ip>:USER:FLISt<fli>:PHASe[:
  STATE] <State>
```

```
[SENSe:]CORRection:FRESponse<si>:USER:FLISt<fli>:PHASe[:STATE] <State>
```

Activates or deactivates the use of the correction data in the selected file for magnitude results.

**Suffix:**

<si> 1..n  
irrelevant

<fli> 1..n  
Index in frequency response file list  
Use [SENSe:]CORRection:FRESponse<si>:BASEband:USER:FLISt<fli>:SIZE? to determine the maximum index number.

**Parameters:**

<State> ON | OFF | 0 | 1  
**OFF | 0**  
Applies the data for magnitude results.  
**ON | 1**  
Does not apply the data for magnitude results.  
\*RST: 1

**Example:** SENS:CORR:FRES:USER:FLIS2:PHAS:STAT ON

**Manual operation:** See "Phase" on page 776

---

```
[SENSe:]CORRection:FRESponse<si>:BASEband:USER:FLISt<fli>:REMOve
```

```
[SENSe:]CORRection:FRESponse<si>:INPut<ip>:USER:FLISt<fli>:REMOve
```

```
[SENSe:]CORRection:FRESponse<si>:USER:FLISt<fli>:REMOve
```

Removes the selected frequency response (.fres) file from the current configuration.

**Suffix:**

<si> 1..n  
irrelevant

<fli> 1..n  
Index in frequency response file list  
Use [SENSe:]CORRection:FRESponse<si>:BASEband:USER:FLISt<fli>:SIZE? to determine the maximum index number.

**Example:** SENS:CORR:FRES:USER:FLIS2:REM

**Usage:** Event

**Manual operation:** See "Remove Frequency Response File" on page 776

---

```
[SENSe:]CORRection:FRESponse<si>:BASEband:USER:FLISt<fli>:SElect
    <FilePath>
```

```
[SENSe:]CORRection:FRESponse<si>:INPut<ip>:USER:FLISt<fli>:SElect
    <FilePath>
```

```
[SENSe:]CORRection:FRESponse<si>:USER:FLISt<fli>:SElect <FilePath>
```

Loads an additional frequency response ( .fres ) file to the current configuration.

**Suffix:**

<si>                    1..n  
                          irrelevant

<fli>                    1..n  
                          Index in frequency response file list  
                          Use [SENSe:]CORRection:FRESponse<si>:BASEband:USER:FLISt<fli>:SIZE? to determine the maximum index number.

**Parameters:**

<FilePath>            string  
                          Path and file name  
                          The default directory for .fres files is C:\R\_SINSTR\USER\Fresponse.

**Example:**            SENS:CORR:FRES:USER:FLIS2:SEL 'C:\FRes.fres'

---

```
[SENSe:]CORRection:FRESponse<si>:BASEband:USER:FLISt<fli>:SIZE?
```

```
[SENSe:]CORRection:FRESponse<si>:INPut<ip>:USER:FLISt<fli>:SIZE?
```

```
[SENSe:]CORRection:FRESponse<si>:USER:FLISt<fli>:SIZE?
```

Queries the number of entries in the list of .fres files for the current configuration.

**Suffix:**

<si>                    1..n  
                          irrelevant

<fli>                    1..n  
                          irrelevant

**Return values:**

<Size>                   integer  
                          Range:        1 to 15  
                          \*RST:        1

**Example:**            SENS:CORR:FRES:BASE:USER:FLIS:SIZE?

**Usage:**                Query only

---

```
[SENSe:]CORRection:FRESponse<si>:USER:FState <State>
```

Activates or deactivates the use of additional frequency response ( .fres ) files. The correction data in these files is applied after any correction settings in active touchstone files.

For details, see [Chapter 11.5, "Frequency response correction \(R&S FSW-K544\)"](#), on page 767.

**Suffix:**

<si> 1..n  
irrelevant

**Parameters:**

<State> ON | OFF | 0 | 1  
**OFF | 0**  
Activates the files.  
**ON | 1**  
Deactivates the files.  
\*RST: 1

**Example:** SENS:CORR:FRES:USER:FST ON

**Manual operation:** See ["Frequency Response active"](#) on page 775

**[SENSe:]CORRection:FRESponse<si>:USER:IQ:DATA:FREQuency?**  
**[SENSe:]CORRection:FRESponse<si>:USER:IQ:DATA:MAGNitude?**  
**[SENSe:]CORRection:FRESponse<si>:USER:IQ:DATA:PHASe?**

Queries the trace values for the combined user correction files (.snp+.fres) in IQ mode.

**Suffix:**

<si> 1..n  
irrelevant

**Example:** SENS:CORR:FRES:USER:IQ:DATA:PHAS?

**Usage:** Query only

**Manual operation:** See ["IQ Mode"](#) on page 777

**[SENSe:]CORRection:FRESponse<si>:BASEband:USER:LOAD <FilePath>**  
**[SENSe:]CORRection:FRESponse<si>:INPut<ip>:USER:LOAD <FilePath>**  
**[SENSe:]CORRection:FRESponse<si>:USER:LOAD <FilePath>**

Loads a stored user-defined frequency response correction scenario.

**Suffix:**

<si> 1..n  
irrelevant

**Setting parameters:**

<FilePath> string

**Example:** SENS:CORR:FRES:USER:LOAD 'FRes1'

**Usage:** Setting only

**Manual operation:** See ["Load Settings"](#) on page 773

---

**[SENSe:]CORRection:FRESponse<si>:BASEband:USER:PRESet**

**[SENSe:]CORRection:FRESponse<si>:INPut<ip>:USER:PRESet**

**[SENSe:]CORRection:FRESponse<si>:USER:PRESet**

Restores the default frequency response correction settings (containing only files specific to the FSW itself). Frequency response correction using `.fres` files is deactivated.

**Suffix:**

<si>                    1..n  
                          irrelevant

**Example:**                SENS:CORR:FRES:USER:PRESet

**Usage:**                  Event

**Manual operation:**    See "[Clear Settings](#)" on page 774

---

**[SENSe:]CORRection:FRESponse<si>:BASEband:USER:REFResh**

**[SENSe:]CORRection:FRESponse<si>:INPut<ip>:USER:REFResh**

Recalculates the input source correction filter.

**Suffix:**

<si>                    1..n  
                          irrelevant

<ip>                    1..n

**Example:**                SENS:CORRection:FRESponse:Input1:USER:REFResh

**Usage:**                  Event

**Manual operation:**    See "[Refresh](#)" on page 772

---

**[SENSe:]CORRection:FRESponse<si>:USER:SCOPE <Frames>**

Determines whether the frequency response correction settings are applied to all active measurement channels, or only the currently selected channel.

**Suffix:**

<si>                    1..n  
                          irrelevant

**Parameters:**

<Frames>                CHANnel | ALL

**CHANnel**

The frequency response correction settings are applied to the currently selected channel only.

To select a channel, use `INSTrument[:SElect]`.

For a list of available channels, use `INSTrument:LIST?`.

**ALL**

The frequency response correction settings are applied to all active measurement channels.

**Example:** `INST:SEL 'MyIQSpectrum'`  
`SENS:CORR:FRES:USER:SCOP CHAN`  
 The filter is applied only to the channel named 'MyIQSpectrum'.

**Manual operation:** See ["Apply to"](#) on page 773

### [SENSe:]CORRection:FRESponse<si>:USER:SCOVered?

Indicates whether the frequency correction file covers the full measurement span.

**Suffix:**

<si> 1..n  
 irrelevant

**Return values:**

<Covered> 0 | 1  
**0**  
 Span not fully covered  
**1**  
 Full measurement span is covered

**Example:** `SENSe1:CORRection:FRESponse:USER:SCOVered?`

**Usage:** Query only

**Manual operation:** See ["Preview"](#) on page 776

### [SENSe:]CORRection:FRESponse<si>:BASEband:USER:SLISt<sli>:CATalog?

### [SENSe:]CORRection:FRESponse<si>:INPut<ip>:USER:SLISt<sli>:CATalog?

### [SENSe:]CORRection:FRESponse<si>:USER:SLISt<sli>:CATalog?

Returns a list of currently configured touchstone format files.

Tip: to determine the currently *selected* file, use the `[SENSe:]CORRection:FRESponse<si>:xxx:SLISt<sli>:SElect?` query.

**Suffix:**

<si> 1..n  
 irrelevant

<sli> 1..n  
 irrelevant

**Return values:**

<List> path and file name of all currently configured touchstone format files.

**Example:** `SENS:CORR:FRES:USER:SLIS:CAT?`  
`C:\R_S\INSTR\USER\MyS7p.s7p,C:`  
`\R_S\INSTR\USER\MyS2p.s2p`

**Usage:** Query only



---

```
[SENSe:]CORRection:FRESponse<si>:BASEband:USER:SLIS<sli>:CLEar
[SENSe:]CORRection:FRESponse<si>:INPut<ip>:USER:SLIS<sli>:CLEar
[SENSe:]CORRection:FRESponse<si>:USER:SLIS<sli>:CLEar
```

Removes all touchstone files from the current configuration for the selected or all input types.

**Suffix:**

<si> 1..n  
irrelevant

<sli> irrelevant

**Example:** SENS:CORR:FRES:USER:SLIS:CLE

**Usage:** Event

**Manual operation:** See "[Remove File](#)" on page 775

---

```
[SENSe:]CORRection:FRESponse<si>:USER:SLIS<sli>:DATA:
FREQuency<spi>?
[SENSe:]CORRection:FRESponse<si>:USER:SLIS<sli>:DATA:MAGNitude<spi>?
[SENSe:]CORRection:FRESponse<si>:USER:SLIS<sli>:DATA:PHASe<spi>?
```

Queries the trace values for the specified .snp file and ports.

**Suffix:**

<si> 1..n  
irrelevant

<sli> 1..n  
Index in Touchstone file list  
Use [SENSe:]CORRection:FRESponse<si>:USER:SLIS<sli>:SIZE? to determine the maximum index number.

<spi> 1..4  
S-port pair index, where:  
1 = From port - from port  
2 = To port - from port  
3 = From port - to port  
4 = To port - to port

**Example:** SENS:CORR:FRES:USER:SLIS2:SEL 'FRes21.s2p'  
SENS:CORR:FRES:USER:SLIS2:PORT:TO 2  
SENS:CORR:FRES:USER:SLIS2:PORT:FROM 1  
SENS:CORR:FRES:USER:SLIS2:DATA:PHAS3?  
The correction data from port 1 to port 2 is returned.

**Usage:** Query only

**Manual operation:** See "[Selected File](#)" on page 776

---

```
[SENSe:]CORRection:FRESponse<si>:BASEband:USER:SLIST<sli>:INSert
  <FilePath>
```

```
[SENSe:]CORRection:FRESponse<si>:INPut<ip>:USER:SLIST<sli>:INSert
  <FilePath>
```

```
[SENSe:]CORRection:FRESponse<si>:USER:SLIST<sli>:INSert <FilePath>
```

Loads a new Touchstone file for the current configuration. The maximum number of files per configuration is 15. The new file is added below the entry specified by the <sli> index. All other entries with a higher suffix are moved down by one position.

To change the order of the files, use the [\[SENSe:\]CORRection:FRESponse<si>:USER:SLIST<sli>:MOVE](#) command.

To determine which files are available, use [\[SENSe:\]CORRection:FRESponse<si>:USER:SLIST<sli>:CATalog?](#) on page 1416.

**Suffix:**

<si>                    1..n  
                         irrelevant

<sli>                    1..n  
                         Index in Touchstone file list  
                         Use [\[SENSe:\]CORRection:FRESponse<si>:USER:SLIST<sli>:SIZE?](#) to determine the maximum index number.

**Parameters:**

<FilePath>            string  
                         Path and file name  
                         The file extension of the Touchstone file must correspond to the number of ports included in the file. For example, a file containing 4 parameters for S11, S22, S12 and S21 must have the extension .s2p.  
                         The default directory for Touchstone files is  
                         C:\R\_S\INSTR\USER\Fresponse.

**Manual operation:**    See ["Add Touchstone File"](#) on page 775

---

```
[SENSe:]CORRection:FRESponse<si>:BASEband:USER:SLIST<sli>:MOVE
  <Direction>
```

```
[SENSe:]CORRection:FRESponse<si>:INPut<ip>:USER:SLIST<sli>:MOVE
  <Direction>
```

```
[SENSe:]CORRection:FRESponse<si>:USER:SLIST<sli>:MOVE <Direction>
```

Moves the selected Touchstone file one position up or down in the list of files, changing the order in which the correction data is applied.

**Suffix:**

<si>                    1..n  
                         irrelevant

<sl> 1..n  
 Index in Touchstone file list  
 Use [SENSe:]CORRection:FRESponse<si>:USER:SLIS<sl>:SIZE? to determine the maximum index number.  
 If an index outside the available range is specified, an error occurs.

**Setting parameters:**

<Direction> UP | DOWN

**Example:** SENS:CORR:FRES:USER:SLIS:MOVE UP

**Usage:** Setting only

**Manual operation:** See "Move File Up or Down" on page 775

[SENSe:]CORRection:FRESponse<si>:BASEband:USER:SLIS<sl>:PORTs:  
 FROM <PortFrom>

[SENSe:]CORRection:FRESponse<si>:INPut<ip>:USER:SLIS<sl>:PORTs:FROM  
 <PortFrom>

[SENSe:]CORRection:FRESponse<si>:USER:SLIS<sl>:PORTs:FROM  
 <PortFrom>

SnP files can be defined for a varying number of input and output ports.

You must define the ports from the touchstone file whose data is to be applied.

**Suffix:**

<si> 1..n  
 irrelevant

<sl> 1..n  
 Index in Touchstone file list  
 Use [SENSe:]CORRection:FRESponse<si>:USER:SLIS<sl>:SIZE? to determine the maximum index number.

**Parameters:**

<PortFrom> \*RST: 1

**Example:**  
 SENS:CORR:FRES:USER:SLIS:SEL 'FRes21.s2p'  
 SENS:CORR:FRES:USER:SLIS:PORT:TO 2  
 SENS:CORR:FRES:USER:SLIS:PORT:FROM 1  
 The correction data from port 1 to port 2 is included in the filter.

**Manual operation:** See "To - From" on page 774

[SENSe:]CORRection:FRESponse<si>:BASEband:USER:SLIS<sl>:PORTs:TO  
 <PortTo>

[SENSe:]CORRection:FRESponse<si>:INPut<ip>:USER:SLIS<sl>:PORTs:TO  
 <PortTo>

[SENSe:]CORRection:FRESponse<si>:USER:SLIS<sl>:PORTs:TO <PortTo>

SnP files can be defined for a varying number of input and output ports.

You must define the ports from the touchstone file whose data is to be applied.

**Suffix:**

<si> 1..n  
irrelevant

<sli> 1..n  
Index in Touchstone file list  
Use [SENSe:]CORRection:FRESponse<si>:USER:SLISt<sli>:SIZE? to determine the maximum index number.

**Parameters:**

<PortTo> \*RST: 1

**Example:**

```
SENS:CORR:FRES:USER:SLIS:SEL 'FRes21.s2p'
SENS:CORR:FRES:USER:SLIS:PORT:TO 2
SENS:CORR:FRES:USER:SLIS:PORT:FROM 1
```

The correction data from port 1 to port 2 is included in the filter.

**Manual operation:** See "To - From" on page 774

**[SENSe:]CORRection:FRESponse<si>:BASEband:USER:SLISt<sli>:REMOve**  
**[SENSe:]CORRection:FRESponse<si>:INPut<ip>:USER:SLISt<sli>:REMOve**  
**[SENSe:]CORRection:FRESponse<si>:USER:SLISt<sli>:REMOve**

Removes the specified touchstone file from the list.

**Suffix:**

<si> 1..n  
irrelevant

<sli> 1..n  
Index in Touchstone file list  
Use [SENSe:]CORRection:FRESponse<si>:USER:SLISt<sli>:SIZE? to determine the maximum index number.

**Example:**

```
SENS:CORR:FRES:USER:SLIS2:REM
```

**Usage:** Event

**Manual operation:** See "Remove File" on page 775

**[SENSe:]CORRection:FRESponse<si>:USER:PSTate <State>**

Activates or deactivates the preview of the user correction files for all input types.

Note that this function is only available for remote operation. The preview cannot be switched back on in manual operation.

**Suffix:**

<si> 1..n  
irrelevant

**Parameters:**

<State> ON | OFF | 0 | 1  
**OFF | 0**  
Switches the function off

**ON | 1**

Switches the function on

\*RST: 1

**Example:** SENS:CORR:FRES:USER:PST ON**Manual operation:** See "Preview" on page 776

**[SENSe:]CORRection:FRESponse<si>:BASEband:USER:SLISt<sli>:SElect**  
 <FilePath>

**[SENSe:]CORRection:FRESponse<si>:INPut<ip>:USER:SLISt<sli>:SElect**  
 <FilePath>

**[SENSe:]CORRection:FRESponse<si>:USER:SLISt<sli>:SElect** <FilePath>

Selects a Touchstone format file from the specified directory to be loaded to the current configuration for the specified input type. If no input type is specified, the currently active input source is assumed.

The query returns the currently selected file.

To determine which files are available, use [\[SENSe:\]CORRection:FRESponse<si>:USER:SLISt<sli>:CATalog?](#) on page 1416.

**Suffix:**

<si> 1..n  
 irrelevant

<sli> 1..n  
 Index in Touchstone file list  
 Use [\[SENSe:\]CORRection:FRESponse<si>:USER:SLISt<sli>:SIZE?](#) to determine the maximum index number.  
 To replace an existing file in the configuration, specify its index.  
 To add a new file, use the next available index.  
 If an index outside the available range is specified, an error occurs.

**Parameters:**

<FilePath> string  
 Path and file name of the selected file.  
 The default directory for Touchstone files is  
 C:\R\_S\INSTR\USER\Fresponse.

**Example:** SENS:CORR:FRES:USER:SLIS:SEL 'C:\FRes21.s2p'

**[SENSe:]CORRection:FRESponse<si>:BASEband:USER:SLISt<sli>:SIZE?**

**[SENSe:]CORRection:FRESponse<si>:INPut<ip>:USER:SLISt<sli>:SIZE?**

**[SENSe:]CORRection:FRESponse<si>:USER:SLISt<sli>:SIZE?**

Queries the number of entries in the list of touchstone files for the current configuration.

**Suffix:**

<si> 1..n  
irrelevant

<sli> irrelevant

**Return values:**

<Size> integer  
Range: 1 to 15  
\*RST: 1

**Example:** SENS:CORR:FRES:USER:SLIS:SIZE?

**Usage:** Query only

**[SENSe:]CORRection:FRESponse<si>:BASEband:USER:SLIS<sli>:STATe**  
<State>

**[SENSe:]CORRection:FRESponse<si>:INPut<ip>:USER:SLIS<sli>:STATe** <State>

**[SENSe:]CORRection:FRESponse<si>:USER:SLIS<sli>:STATe** <State>

Activates or deactivates the loaded file for the current configuration. Only active files are included in filter calculation.

For queries with no input type specified, the currently active input type is queried.

**Suffix:**

<si> 1..n  
irrelevant

<sli> 1..n  
Index in Touchstone file list  
Use [SENSe:]CORRection:FRESponse<si>:USER:SLIS<sli>:SIZE? to determine the maximum index number.

**Parameters:**

<State> ON | OFF | 0 | 1  
**OFF | 0**  
Activates the file.  
**ON | 1**  
Deactivates the file.  
\*RST: 1

**Example:** SENS:CORR:FRES:USER:SLIS2:STAT ON

**Manual operation:** See "Active" on page 774

**[SENSe:]CORRection:FRESponse<si>:USER:SPECtrum:DATA:FREQUency?**

**[SENSe:]CORRection:FRESponse<si>:USER:SPECtrum:DATA:MAGNitude?**

**[SENSe:]CORRection:FRESponse<si>:USER:SPECtrum:DATA:PHASe?**

Queries the trace values for the combined user correction files (.snp+.fres) in Spectrum mode.

**Suffix:**

<si> 1..n  
irrelevant

**Usage:** Query only

**Manual operation:** See "[Spectrum Mode](#)" on page 778

**[SENSe:]CORRection:FRESponse<si>:BASEband:USER:STATe** <State>

**[SENSe:]CORRection:FRESponse<si>:INPut<ip>:USER:STATe** <State>

**[SENSe:]CORRection:FRESponse<si>:USER:STATe** <State>

Activates or deactivates the general usage of user-defined frequency response correction settings.

Only if activated, the filter is calculated and applied to the results.

For details, see [Chapter 11.5, "Frequency response correction \(R&S FSW-K544\)"](#), on page 767.

TPIS correction is not supported if user frequency response correction is active. If you activate frequency response correction, TPIS correction is automatically deactivated in all channels.

For details see the FSW I/Q Analyzer and I/Q Input User Manual.

**Suffix:**

<si> 1..n  
irrelevant

**Parameters:**

<State> ON | OFF | 0 | 1  
**OFF | 0**  
Switches the function off  
**ON | 1**  
Switches the function on  
\*RST: 0

**Example:** SENS:CORR:FRES:USER:STAT

**Manual operation:** See "[State](#)" on page 772

**[SENSe:]CORRection:FRESponse<si>:BASEband:USER:STORE** <FilePath>

**[SENSe:]CORRection:FRESponse<si>:INPut<ip>:USER:STORE** <FilePath>

**[SENSe:]CORRection:FRESponse<si>:USER:STORE** <FilePath>

Stores a saveset for a user-defined frequency response correction scenario. By default, the saveset is stored in the C:\R\_S\INSTR\USER\FResponse directory.

**Suffix:**

<si> 1..n  
irrelevant

**Setting parameters:****<FilePath>** string**Example:**

SENS:CORR:FRES:USER:STOR 'FRes1'

Stores the current frequency response correction configuration to a file named

C:\R\_S\INSTR\USER\FResponse\FRes1.dfl.

**Usage:**

Setting only

**Manual operation:** See ["Save Settings"](#) on page 774**[SENSe:]CORRection:FRESponse<si>:USER:VALid?**

This command queries the validity of the user-defined correction settings.

**Suffix:****<si>** 1..n  
irrelevant**Return values:****<Validity>** 0 | 1  
**1**  
The setting is valid.  
**0**  
The setting is not valid.**Example:**

SENS:CORR:FRES:USER:VAL?

**Usage:**

Query only

**Manual operation:** See ["State"](#) on page 772**13.10.4.2 Programming example: using touchstone files**

This example demonstrates how to use Touchstone files in a basic I/Q Analyzer measurement setup in a remote environment.

```

-----Configuring the measurement -----
*RST; *WAI
SYST:DISP:UPD ON
TRACe1:IQ ON
TRACe:IQ:EVAL ON
LAY:REPL:WIND "1",FREQ
INIT:CONT OFF

// Use calibration signal as input data
DIAG:SERV:INP:CAL
DIAG:SERV:INP:RF:SPEC BRO
DIAG:SERV:INP:PULS:CFR 1MHz

// Set SR/Bandwidth and CF
TRAC:IQ:SRAT 100 MHz

```



```

FREQ:CENT 500MHz

// Activate S2P file
SENSe:CORRection:FRESponse:Input1:USER:PRESet
SENSe:CORRection:FRESponse:Input1:USER:SLIST1:SElect 'c:\BP_40MHz.s2p'
SENSe:CORRection:FRESponse:Input1:USER:STATE ON

INIT:IMM; *WAI
SYST:COMM:INT:REM OFF

```

### 13.10.5 Customizing the screen layout

The remote commands required to set up the display of the FSW are described here.

- [General display settings and items](#)..... 1425
- [Colors and themes](#)..... 1429
- [CMAP suffix assignment](#)..... 1431

#### 13.10.5.1 General display settings and items

The following commands add, remove or customize general display and screen elements.

##### Useful commands for general display settings described elsewhere

- [DISPlay\[:WINDow<n>\]:MTABLE](#) on page 1276
- [DISPlay:FORMat](#) on page 1099

##### Remote commands exclusive to general display settings

<a href="#">DISPlay:ANNotation:CBAR</a> .....	1425
<a href="#">DISPlay:ANNotation:FREQuency</a> .....	1426
<a href="#">DISPlay:SBAR[:STATE]</a> .....	1426
<a href="#">DISPlay:SKEYs[:STATE]</a> .....	1426
<a href="#">DISPlay:TBAR[:STATE]</a> .....	1426
<a href="#">DISPlay:TOUChscreen[:STATE]</a> .....	1427
<a href="#">DISPlay[:WINDow&lt;n&gt;]:TIME</a> .....	1427
<a href="#">DISPlay[:WINDow&lt;n&gt;]:TIME:FORMat</a> .....	1427
<a href="#">SYSTem:DISPlay:FPANel[:STATE]</a> .....	1428
<a href="#">SYSTem:DATE</a> .....	1428
<a href="#">SYSTem:TIME</a> .....	1428

---

##### **DISPlay:ANNotation:CBAR <State>**

This command hides or displays the channel bar information.

##### Parameters:

```

<State>          ON | OFF | 0 | 1
*RST:           1

```

**Example:** `DISP:ANN:CBAR OFF`

**Manual operation:** See "[Channel Bar](#)" on page 737

#### **DISPlay:ANNOtation:FREQUency** <State>

This command turns the label of the x-axis on and off.

**Parameters:**

<State> `ON | OFF | 0 | 1`  
 \*RST: `1`

**Example:** `DISP:ANN:FREQ OFF`

**Manual operation:** See "[Diagram Footer \(Annotation\)](#)" on page 737

#### **DISPlay:SBAR[:STATe]** <State>

This command turns the status bar on and off.

**Parameters:**

<State> `ON | OFF | 0 | 1`  
 \*RST: `1`

**Example:** `DISP:SBAR:OFF`

**Manual operation:** See "[Status Bar](#)" on page 737

#### **DISPlay:SKEYs[:STATe]** <State>

This command turns the softkey bar on and off.

**Parameters:**

<State> `ON | OFF | 0 | 1`  
 \*RST: `1`

**Example:** `DISP:SKEY:OFF`

**Manual operation:** See "[Softkey Bar](#)" on page 737

#### **DISPlay:TBAR[:STATe]** <State>

This command turns the toolbar on or off.

**Parameters:**

<State> `ON | OFF | 1 | 0`  
 \*RST: `0`

**Example:** `DISP:TBAR ON`

**Manual operation:** See "[Toolbar](#)" on page 737

---

**DISPlay:TOUCHscreen[:STATe] <State>**

This command controls the touch screen functionality.

**Parameters:**

<State>                    ON | FRAME | OFF | TCOFF

**ON | 1**  
Touch screen is active for entire screen

**OFF | 0**  
Touch screen is inactive for entire screen

**FRAME**  
Touch screen is inactivate for the diagram area of the screen, but active for softkeys, toolbars and menus.

\*RST:                    1

**Example:**                    DISP:TOUC:STAT ON

**Manual operation:**    See "[Deactivating and Activating the Touchscreen](#)" on page 735

---

**DISPlay[:WINDow<n>]:TIME <State>**

This command adds or removes the date and time from the display.

**Suffix:**

<n>                            irrelevant

**Parameters:**

<State>                    ON | OFF | 1 | 0

\*RST:                    0

**Example:**                    DISP:TIME ON

**Manual operation:**    See "[Date and Time](#)" on page 737

---

**DISPlay[:WINDow<n>]:TIME:FORMat <Format>**

This command selects the time and date format.

**Suffix:**

<n>                            irrelevant

**Parameters:**

<Format>                    US | DE | ISO

**DE**  
dd.mm.yyyy hh:mm:ss  
24 hour format.

**US**  
mm/dd/yyyy hh:mm:ss  
12 hour format.

**ISO**

yyyy-mm-dd hh:mm:ss

24 hour format.

\*RST: ISO

**Example:**

DISP:TIME ON

Switches the screen display of date and time on.

DISP:TIME:FORM US

Switches the date and time format to US.

**Manual operation:** See ["Date and Time Format"](#) on page 736**SYSTem:DISPlay:FPANel[:STATe]** <State>

This command includes or excludes the front panel keys when working with the remote desktop.

**Parameters:**

&lt;State&gt; ON | OFF | 0 | 1

\*RST: 1

**Manual operation:** See ["Front Panel"](#) on page 738  
See ["Mini Front Panel"](#) on page 738

**SYSTem:DATE** <Year>, <Month>, <Day>

Configures the date on the instrument.

**Parameters:**

&lt;Year&gt;

&lt;Month&gt;

&lt;Day&gt;

**Example:** SYST:DATE 2020,04,23**Manual operation:** See ["Set Date and Time"](#) on page 735**SYSTem:TIME** <Hour>, <Minutes>, <Seconds>

Configures the time on the internal real-time clock on the instrument.

**Parameters:**

&lt;Hour&gt; Range: 0 to 23

&lt;Minutes&gt; Range: 0 to 59

&lt;Seconds&gt; Range: 0 to 59

**Example:** SYST:TIME 10,52,33**Manual operation:** See ["Set Date and Time"](#) on page 735

### 13.10.5.2 Colors and themes

#### Useful commands to customize display colors described elsewhere

The `HCOPY` commands define the print colors and thus only take effect on the display colors, if the display shows the printing colors.

- `HCOPY:CMAP<it>:DEFault<ci>` on page 1364
- `HCOPY:CMAP<it>:HSL` on page 1365
- `HCOPY:CMAP<it>:PDEFined` on page 1365

#### Remote commands exclusive to customize the display colors and themes

<code>DISPlay:CMAP&lt;it&gt;:DEFault&lt;ci&gt;</code> .....	1429
<code>DISPlay:CMAP&lt;it&gt;:HSL</code> .....	1429
<code>DISPlay:CMAP&lt;it&gt;:PDEFined</code> .....	1430
<code>DISPlay:THEMe:CATalog?</code> .....	1430
<code>DISPlay:THEMe:SElect</code> .....	1430

---

#### `DISPlay:CMAP<it>:DEFault<ci>`

This command selects the color scheme for the display. The query returns the default color scheme.

##### Suffix:

<code>&lt;it&gt;</code>	Irrelevant.
<code>&lt;ci&gt;</code>	1 Default color set 1 with a black background and white grid. 2 Default color set 2 with a white background and a black grid. 3 User-defined colors. Suffix irrelevant for query

##### Return values:

<code>&lt;DefScheme&gt;</code>	1   2   3 The default color scheme used for the screen, as specified by the <code>&lt;ci&gt;</code> suffix.
--------------------------------	----------------------------------------------------------------------------------------------------------------

##### Example:

```
DISP:CMAP:DEF2
Selects default setting 2 (white background and a black grid) for
screen colors.
DISP:CMAP:DEF?
//Result: 2
```

**Manual operation:** See "[Screen Colors](#)" on page 740

---

#### `DISPlay:CMAP<it>:HSL <hue>, <sat>, <lum>`

This command selects the color for various screen elements in the display.

**Suffix:**

<it> 1..n  
 Selects the item for which the color scheme is to be defined.  
 For more information see [Chapter 13.10.5.3, "CMAP suffix assignment"](#), on page 1431.

**Parameters:**

<hue> tint  
 Range: 0 to 1

<sat> saturation  
 Range: 0 to 1

<lum> brightness  
 Range: 0 to 1

**Example:**

```
DISP:CMAP2:HSL 0.3,0.8,1.0
```

Changes the grid color.

**DISPlay:CMAP<it>:PDEFined <Color>**

This command selects a predefined color for various screen elements.

**Suffix:**

<it> 1..n  
 Selects the item for which the color scheme is to be defined.  
 For more information see [Chapter 13.10.5.3, "CMAP suffix assignment"](#), on page 1431.

**Parameters:**

<Color> BLACK | BLUE | BROWn | GREen | CYAN | RED | MAGenta |  
 YELLow | WHITe | DGRay | LGRay | LBLue | LGReen | LCYan |  
 LRED | LMAGenta

**Example:**

```
DISP:CMAP2:PDEF GRE
```

**Manual operation:** See ["Restoring the User Settings to Default Colors"](#) on page 743

**DISPlay:THEMe:CATalog?**

This command queries all available display themes.

**Return values:**

<Themes> String containing all available display themes.

**Example:**

```
DISP:THEMe:CAT?
```

**Usage:**

Query only

**DISPlay:THEMe:SElect <Theme>**

This command selects the display theme.

**Parameters:**

<Theme> String containing the name of the theme.  
 \*RST: SPL

**Example:**

DISP:THEM:SEL "BlueOcean"

**Manual operation:** See "[Theme](#)" on page 740

**13.10.5.3 CMAP suffix assignment**

Several commands to change the color settings of individual items of the display or printout are available. Which item is to be configured is defined using a <CMAP> suffix. The following assignment applies:

Suffix	Description
CMAP1	Background
CMAP2	Grid
CMAP3 *)	Common Text
CMAP4 *)	Check Status OK
CMAP5 *)	Check Status Error
CMAP6 *)	Text Special 1
CMAP7 *)	Text Special 2
CMAP8	Trace 1
CMAP9	Trace 2
CMAP10	Trace 3
CMAP11	Marker Info Text
CMAP12	Limit Lines
CMAP13	Limit and Margin Check – "Pass"
CMAP14	Limit and Margin Check – "Fail"
CMAP15 *)	Softkey Text
CMAP16 *)	Softkey Background
CMAP17 *)	Selected Field Text
CMAP18 *)	Selected Field Background
CMAP19 *)	Softkey 3D Bright Part
CMAP20 *)	Softkey 3D Dark Part
CMAP21 *)	Softkey State "On"
CMAP22 *)	Softkey State "Dialog open"
CMAP23 *)	Softkey Text Disabled
CMAP24	Logo

Suffix	Description
CMAP25	Trace 4
CMAP26	Grid – Minorlines
CMAP27	Marker
CMAP28	Display Lines
CMAP29 *)	Sweepcount – Text
CMAP30	Limit and Margin Check – Text
CMAP31	Limit and Margin Check – \"Margin\"
CMAP32 *)	Table Overall – Title Text
CMAP33 *)	Table Overall – Title Background
CMAP34 *)	Table Overall – Text
CMAP35 *)	Table Overall – Background
CMAP36 *)	Table Value – Title Text
CMAP37 *)	Table Value – Title Background
CMAP38 *)	Table Value – Text
CMAP39 *)	Table Value – Background
CMAP40	Trace 5
CMAP41	Trace 6

\*) these settings can only be defined via the theme (`DISPlay:THEMe:SElect`) and are thus ignored in the SCPI command

### 13.10.6 Remote commands for language settings

`SYSTem:DISPlay:LANGUage`..... 1432

#### **SYSTem:DISPlay:LANGUage** <Language>

Defines the language of the software-defined interface elements (such as softkeys, dialog boxes, diagram texts etc.).

#### **Parameters:**

<Language> 'EN' | 'ZH\_CH' | 'ZH\_TW' | 'JA' | 'KO' | 'RU'  
**'ZH\_CH'**  
 Simplified Chinese  
**'ZH\_TW'**  
 Traditional Chinese  
 \*RST: 'EN'

#### **Example:**

```
SYST:DISP:LANG 'JA'
```

Switches the language of the instrument to Japanese.



### 13.10.7 Configuring the network and remote control

The following commands are required to configure a network or remote control for the FSW.

Useful commands for configuring remote control described elsewhere:

- [SYSTem:LANGuage](#) on page 1489

#### Remote commands exclusive to configuring a network and remote control

<a href="#">SYSTem:COMMunicate:GPIB[:SELF]:ADDRess</a> .....	1433
<a href="#">SYSTem:COMMunicate:GPIB[:SELF]:RTERminator</a> .....	1433
<a href="#">SYSTem:COMMunicate:INTernal:REMote</a> .....	1434
<a href="#">SYSTem:DISPlay:LOCK</a> .....	1434
<a href="#">SYSTem:DISPlay:UPDate</a> .....	1435
<a href="#">SYSTem:ERRor:DISPlay</a> .....	1435
<a href="#">SYSTem:IDENtify:FACTory</a> .....	1435
<a href="#">SYSTem:IDENtify[:STRing]</a> .....	1435
<a href="#">SYSTem:KLOCK</a> .....	1436
<a href="#">SYSTem:LXI:LANReset</a> .....	1436
<a href="#">SYSTem:LXI:MDEScription</a> .....	1436
<a href="#">SYSTem:LXI:PASSword</a> .....	1436
<a href="#">SYSTem:REVision:FACTory</a> .....	1436
<a href="#">SYSTem:SHIMmediate ONCE</a> .....	1437
<a href="#">SYSTem:SHIMmediate:STATE</a> .....	1437

---

#### **SYSTem:COMMunicate:GPIB[:SELF]:ADDRess** <Address>

This command sets the GPIB address of the FSW.

##### Parameters:

<Address>                      Range:        0 to 30  
                                      \*RST:        (no influence on this parameter, factory default 20)

**Example:**                      `SYST:COMM:GPIB:ADDR 18`

**Manual operation:**    See "[GPIB Address](#)" on page 855

---

#### **SYSTem:COMMunicate:GPIB[:SELF]:RTERminator** <Terminator>

This command selects the GPIB receive terminator.

Output of binary data from the instrument to the control computer does not require such a terminator change.

##### Parameters:

<Terminator>                    LFEOI | EOI  
                                      **LFEOI**  
                                      According to the standard, the terminator in ASCII is <LF>  
                                      and/or <EOI>.

**EOI**

For binary data transfers (e.g. trace data) from the control computer to the instrument, the binary code used for <LF> might be included in the binary data block, and therefore should not be interpreted as a terminator in this particular case. This can be avoided by using only the receive terminator `EOI`.

\*RST: LFEOI

**Example:** `SYST:COMM:GPIB:RTER EOI`

**Manual operation:** See "[GPIB Terminator](#)" on page 856

**SYSTem:COMMunicate:INTernal:REMote <State>**

The instrument switches between manual and remote operation.

**Note:** If the local lockout function (`LLO` or `SYST:KLOC ON`) has been activated in the remote control mode, manual operation is no longer available until `GTL` (or `SYST:KLOC OFF`) is executed.

For details, see [Chapter 12.6.7, "Returning to manual mode \("local"\)"](#), on page 870.

**Parameters:**

<State> ON | OFF | 0 | 1

**OFF | 0**

The instrument switches from remote to manual operation. You can operate the instrument locally.

**ON | 1**

The instrument switches from manual to remote operation.

\*RST: 0

**Example:** `SYST:COMM:INT:REM OFF`

The instrument switches from remote to manual operation (corresponds to `@LOC` or selecting the "Local" softkey).

**Manual operation:** See "[Local](#)" on page 870

**SYSTem:DISPlay:LOCK <State>**

Defines whether the "Display Update" function remains available in remote operation or not.

**Parameters:**

<State> ON | OFF | 0 | 1

**OFF | 0**

The function remains available.

**ON | 1**

The function is not available and the display is not updated during remote operation.

\*RST: 0

**Manual operation:** See ["Remote Display Update"](#) on page 856

---

#### **SYSTem:DISPlay:UPDate** <State>

This command turns the display during remote operation on and off.

If on, the FSW updates the diagrams, traces and display fields only.

The best performance is obtained if the display is off during remote control operation.

**Parameters:**

<State>            ON | OFF | 1 | 0  
 \*RST:            0

**Example:**            SYST:DISP:UPD ON

**Manual operation:** See ["Remote Display Update"](#) on page 856

---

#### **SYSTem:ERRor:DISPlay** <State>

This command switches the error display during remote operation on and off.

If activated, the FSW displays a message box at the bottom of the screen that contains the most recent type of error and the command that caused the error.

**Parameters:**

<State>            ON | OFF | 1 | 0  
 \*RST:            0

**Example:**            SYST:ERR:DISP ON

**Manual operation:** See ["Display Remote Errors"](#) on page 857

---

#### **SYSTem:IDENtify:FACTory**

This command resets the query to `*IDN?` to its default value.

**Usage:**            Event

**Manual operation:** See ["Reset to Factory String"](#) on page 855

---

#### **SYSTem:IDENtify[:STRing]** <String>

This command defines the response to `*IDN?`.

**Parameters:**

<String>            String containing the description of the instrument.

**Manual operation:** See ["Identification String"](#) on page 855

---

**SYSTem:KLOCK** <State>

This command locks or unlocks manual operation.

**Parameters:**

&lt;State&gt;

**ON**

LLO (local lockout). The instrument can only be operated remotely, not locally.

**OFF**

Unlocks the manual operation mode. To operate the instrument locally again, you must execute `SYST:COMM:INT:REM OFF` or select the "Local" softkey first.

\*RST: state not affected by \*RST

**Example:**

```
SYST:KLOC ON
```

Activates LLO (remote control only)

**Example:**

```
SYST:KLOC OFF
```

```
SYST:COMM:INT:REM OFF
```

You can operate the instrument locally.

---

**SYSTem:LXI:LANReset**

This command resets the LAN configuration, as well as the "LAN" password and instrument description.

**Manual operation:** See ["LAN Reset"](#) on page 862

---

**SYSTem:LXI:MDEscription** <Description>

This command defines the "LAN" instrument description.

**Parameters:**

&lt;Description&gt;

String containing the instrument description.

---

**SYSTem:LXI:PASSword** <Password>

This command defines the "LAN" password.

**Parameters:**

&lt;Password&gt;

String containing the password.

**Return values:**

&lt;Password&gt;

**Manual operation:** See ["LAN Password"](#) on page 862

---

**SYSTem:REVision:FACTory**

Resets the response to the `REV?` query to the factory default value.

For example, after a user string was defined using the `SYSTem:REVision[:STRing]` on page 1491 command. (`REV?` query available for HP emulation only, see `SYSTem:LANGuage` on page 1489.)

**Example:** Define the system language:  
`SYST:LANG '8563E'`  
 Set the response back to factory setting:  
`SYS:REV:FACT`  
 Query the revision:  
`REV?`  
 Response:  
`920528`

**Usage:** Event

**Manual operation:** See "[Resetting the Factory Revision](#)" on page 860

### **SYSTem:SHIMmediate ONCE**

Executes any received remote commands that cause changes to the hardware and have not been executed yet due to a `SYST:SHIM:STAT OFF` command.

**Example:** `SYST:SHIM:STAT ON`  
 ...  
`SYST:SHIM ONCE`

**Usage:** Event

**Manual operation:** See "[Set Hardware Immediately](#)" on page 857

### **SYSTem:SHIMmediate:STATe <State>**

Determines when the remote commands that change hardware settings on the FSW are executed.

Regardless of this setting, the firmware automatically sets the hardware when a sweep is started.

This setting is not changed by the preset function.

**Parameters:**

<State> ON | OFF | 0 | 1

**OFF | 0**

Remote commands that cause changes to the hardware are only executed when the `SYSTem:SHIMmediate ONCE` command is executed.

**ON | 1**

Remote commands are always executed immediately when they are received by the instrument.

\*RST: 1

**Example:**

```

SYST:SHIM:STAT ON
...
SYST:SHIM ONCE

```

**Manual operation:** See ["Set Hardware Immediately"](#) on page 857

### 13.10.8 Configuring HUMS

This section includes all commands needed for R&S HUMS remote operations.

<a href="#">DIAGnostic:HUMS:DELeTe:ALL</a> .....	1438
<a href="#">DIAGnostic:HUMS:FORMat</a> .....	1438
<a href="#">DIAGnostic:HUMS:STATe</a> .....	1439
<a href="#">DIAGnostic:HUMS:TAgS:ALL?</a> .....	1439
<a href="#">DIAGnostic:HUMS:TAgS:DELeTe:ALL</a> .....	1439
<a href="#">DIAGnostic:HUMS:TAgS:DELeTe</a> .....	1440
<a href="#">DIAGnostic:HUMS:TAgS[:VALue]</a> .....	1440
<a href="#">SYSTem:COMMunicate:REST:ENABle</a> .....	1440
<a href="#">SYSTem:COMMunicate:SNMP:COMMunity:RO</a> .....	1441
<a href="#">SYSTem:COMMunicate:SNMP:COMMunity:RW</a> .....	1441
<a href="#">SYSTem:COMMunicate:SNMP:CONtAct</a> .....	1441
<a href="#">SYSTem:COMMunicate:SNMP:LOCation</a> .....	1442
<a href="#">SYSTem:COMMunicate:SNMP:USM:USER</a> .....	1442
<a href="#">SYSTem:COMMunicate:SNMP:USM:USER:ALL?</a> .....	1442
<a href="#">SYSTem:COMMunicate:SNMP:USM:USER:DELeTe</a> .....	1443
<a href="#">SYSTem:COMMunicate:SNMP:USM:USER:DELeTe:ALL</a> .....	1443
<a href="#">SYSTem:COMMunicate:SNMP:VERSion</a> .....	1443

---

#### **DIAGnostic:HUMS:DELeTe:ALL**

Deletes the complete HUMS data. This includes device history, device tags, SCPI connections, utilization history and utilizations.

**Example:**

```

//Delete HUMS data
DIAG:HUMS:DEL:ALL

```

**Usage:** Event

**Manual operation:** See ["Delete HUMS History"](#) on page 864

---

#### **DIAGnostic:HUMS:FORMat <DataFormat>**

Selects the format for the queried HUMS data. You can query the HUMS data either in JSON format or XML format.

The defined format affects all other commands that return block data.

**Parameters:**

<DataFormat> JSON | XML

**JSON**

Returns the HUMS data in JSON format.

**XML**

Returns the HUMS data in XML format.

\*RST: JSON

**Example:** //Return data in JSON format  
DIAG:HUMS:FORM JSON

**DIAGnostic:HUMS:STATe <State>**

Turns the HUMS service and data collection on and off.

**Parameters:**

<State> ON | OFF | 1 | 0

\*RST: ON

**Example:** //Turn on HUMS service  
DIAG:HUMS:STAT ON

**Manual operation:** See ["State"](#) on page 863

**DIAGnostic:HUMS:TAgS:ALL?**

Queries all key-value tags that you have assigned to the instrument. Depending on the set data format, the queried data is either displayed in XML or JSON format. For more information about setting the data format, see [DIAGnostic:HUMS:FORMat](#) on page 1438.

**Return values:**

<ID> ID number of the defined tag.

<Key> String containing key name of the defined tag.

<Value> String containing value of the defined tag.

**Example:** //Return all tags  
DIAG:HUMS:TAgS:ALL?  
1,"location","building\_11",2,"time zone","CET"

**Usage:** Query only

**Manual operation:** See ["Value"](#) on page 868

**DIAGnostic:HUMS:TAgS:DELeTe:ALL**

Deletes all key-value tags you have assigned to the instrument.

**Example:** //Delete all tags  
DIAG:HUMS:TAgS:DEL:ALL

**Usage:** Event

**Manual operation:** See ["Delete All"](#) on page 868

**DIAGnostic:HUMS:TAGS:DELeTe** <ID>

Deletes a certain tag you assigned to your instrument, including its key and value.

**Setting parameters:**

<ID> ID number of the tag you want to delete.  
To identify the ID number, query all device tags from the system first. For more information, see [DIAGnostic:HUMS:TAGS:ALL?](#) on page 1439.

**Example:** //Delete tag  
DIAG:HUMS:TAGS:DEL 0

**Usage:** Setting only

**Manual operation:** See "[Delete All](#)" on page 868

**DIAGnostic:HUMS:TAGS[:VALue]** <ID>, <Key>, <Value>**DIAGnostic:HUMS:TAGS[:VALue]?** <ID>

Adds or modifies a key-value pair (device tag).

The query returns the key-value pair for a given ID or an empty string if the ID is unknown.

**Parameters:**

<Key> String containing key name of the queried tag.

<Value> String containing value of the queried tag.

**Parameters for setting and query:**

<ID> 0 - 31  
ID number of the tag you want to modify or query.  
To identify the ID number, query all device tags from the system first. For more information, read here [DIAGnostic:HUMS:TAGS:ALL?](#) on page 1439.

**Example:** //Add or modify a tag (tag 1)  
DIAG:HUMS:TAGS 1, 'location', 'building\_11'

**Manual operation:** See "[Add](#)" on page 868

**SYSTem:COMMunicate:REST:ENABle** <RestState>

Turns communication via the REST API on and off.

**Parameters:**

<RestState> ON | OFF | 0 | 1

**Example:** //Return REST state  
SYST:COMM:REST:ENAB?

**Manual operation:** See "[REST](#)" on page 865



---

**SYSTem:COMMunicate:SNMP:COMMunity:RO** <CommunityString>

Defines the SNMP community string for read-only access.

Prerequisites for this command:

- Select an SNMP version that supports communities (**SYSTem:COMMunicate:SNMP:VERSion** on page 1443).

**Setting parameters:**

<CommunityString> String containing the community name.

**Example:**

```
//Set community name
SYST:COMM:SNMP:VERS V12
SYST:COMM:SNMP:COMM:RO 'ABC'
```

**Usage:** Setting only

**Manual operation:** See "[Access](#)" on page 865

---

**SYSTem:COMMunicate:SNMP:COMMunity:RW** <CommunityString>

Defines the SNMP community string for read-write access.

Prerequisites for this command:

- Select an SNMP version that supports communities (**SYSTem:COMMunicate:SNMP:VERSion** on page 1443).

**Setting parameters:**

<CommunityString> String containing the community name.

**Example:**

```
//Set read-write access
SYST:COMM:SNMP:VERS V12
SYST:COMM:SNMP:COMM:RW 'ABC'
```

**Usage:** Setting only

**Manual operation:** See "[Access](#)" on page 865

---

**SYSTem:COMMunicate:SNMP:CONTact** <SnmContact>

Defines the SNMP contact information for the administrator.

You can also set the contact information via SNMP if you do not set it via SCPI.

**Parameters for setting and query:**

<SnmContact> String containing SNMP contact.  
\*RST: "" (empty string)

**Example:**

```
//Set SNMP contact
SYST:COMM:SNMP:CONT 'ABC'
```

**Manual operation:** See "[SNMP Contact](#)" on page 867

**SYSTem:COMMunicate:SNMP:LOCation** <SnmplLocation>

Defines the SNMP location information for the administrator.

You can also set the location information via SNMP if you do not set it via SCPI.

**Parameters for setting and query:**

<SnmplLocation> String containing SNMP location.  
\*RST: "" (empty string)

**Example:** //Return SNMP location  
SYST:COMM:SNMP:LOC?

**Manual operation:** See "[SNMP Location](#)" on page 867

**SYSTem:COMMunicate:SNMP:USM:USER** <Name>, <Access>, <Level>[, <Auth\_pwd>[, <Priv\_pwd>]]

Defines an SNMP user profile.

Prerequisites for this command:

- Select SNMPv3 ([SYSTem:COMMunicate:SNMP:VERSion](#) on page 1443).

**Setting parameters:**

<Name> String containing name of the user.  
<Access> RO | RW  
Defines the access right a user can have.  
<Level> NOAuth | AUTH | PRIVacy  
Defines the security level.  
<Auth\_pwd> String containing the authentication password.  
<Priv\_pwd> String containing the privacy password.

**Example:** //Create user profile  
SYST:COMM:SNMP:VERS V123  
SYST:COMM:SNMP:USM:USER 'Peter', 'RO', 'PRIV',  
'1234', 'XYZ'

**Usage:** Setting only

**Manual operation:** See "[SNMPv3 Configuration](#)" on page 866

**SYSTem:COMMunicate:SNMP:USM:USER:ALL?**

Queries the number of users and a list of all SNMP users for SNMPv3.

Prerequisites for this command:

- Select SNMPv3 ([SYSTem:COMMunicate:SNMP:VERSion](#) on page 1443).

**Return values:**

<Count> Total number of registered SNMP users.  
<Name> List of all user names as a comma-separated list.

**Example:** //Return all SNMP users  
 SYST:COMM:SNMP:USM:USER:ALL?

**Usage:** Query only

**Manual operation:** See "[SNMPv3 Configuration](#)" on page 866

**SYSTem:COMMunicate:SNMP:USM:USER:DELeTe <UserName>**

Deletes a specific SNMP user profile.

**Setting parameters:**

<UserName> String containing name of SNMP user profile to be deleted.

**Example:** //Delete SNMP user profile  
 SYST:COMM:SNMP:USM:USER:DEL "Peter"

**Usage:** Setting only

**Manual operation:** See "[SNMPv3 Configuration](#)" on page 866

**SYSTem:COMMunicate:SNMP:USM:USER:DELeTe:ALL**

Deletes all SNMP user profiles.

**Example:** //Delete all SNMP user profiles  
 SYST:COMM:SNMP:USM:USER:DEL:ALL

**Usage:** Event

**Manual operation:** See "[SNMPv3 Configuration](#)" on page 866

**SYSTem:COMMunicate:SNMP:VERSion <SnmVersion>**

Selects the SNMP version.

**Parameters for setting and query:**

<SnmVersion> OFF | V12 | V123 | V3 | DEFault

**OFF**

SNMP communication is off.

**V12**

SNMP communication with SNMPv2 or lower.

**V123**

SNMP communication with SNMPv2 and SNMPv3.

**V3**

SNMP communication with SNMPv3.

\*RST: V123

**Example:** //Select the SNMP version  
 SYST:COMM:SNMP:VERS V12

**Manual operation:** See "[SNMP](#)" on page 865

### 13.10.9 Checking the system configuration

The following commands are required to check the system configuration on the FSW.

Useful commands for obtaining system information described elsewhere:

- [DIAGnostic:SERVice:SINfo?](#) on page 1457

#### Remote commands exclusive to obtaining system information:

<a href="#">DIAGnostic:INFO:CCOunt?</a> .....	1444
<a href="#">DIAGnostic:SERVice:CALibration:DATE</a> .....	1445
<a href="#">DIAGnostic:SERVice:CALibration:DUE:DATE</a> .....	1445
<a href="#">DIAGnostic:SERVice:CALibration:INTerval?</a> .....	1445
<a href="#">DIAGnostic:SERVice:DATE</a> .....	1446
<a href="#">DEVice:INFO:HWBand?</a> .....	1446
<a href="#">DIAGnostic:SERVice:BIOSinfo?</a> .....	1447
<a href="#">DIAGnostic:SERVice:HWINfo?</a> .....	1447
<a href="#">DIAGnostic:SERVice:VERSinfo?</a> .....	1447
<a href="#">SYSTem:ERRor:CLEar:ALL</a> .....	1448
<a href="#">SYSTem:DFPRint</a> .....	1448
<a href="#">SYSTem:ERRor:CLEar:REMOte</a> .....	1448
<a href="#">SYSTem:ERRor:EXTended?</a> .....	1448
<a href="#">SYSTem:ERRor:LIST?</a> .....	1449
<a href="#">SYSTem:ERRor[:NEXT]?</a> .....	1450
<a href="#">SYSTem:FIRMware:UPDate</a> .....	1450
<a href="#">SYSTem:FORMat:IDENT</a> .....	1450
<a href="#">SYSTem:OPTion:LICense[:LIST]</a> .....	1450
<a href="#">SYSTem:OPTion:LICense[:LIST]?</a> .....	1451
<a href="#">SYSTem:OPTion:TRIAL:LIST?</a> .....	1452
<a href="#">SYSTem:OPTion:TRIAL[:STATE]</a> .....	1452
<a href="#">SYSTem:PRESet:COMPAtible</a> .....	1453
<a href="#">SYSTem:SECurity[:STATE]</a> .....	1453

---

#### **DIAGnostic:INFO:CCOunt? <Relay>**

This command queries how many switching cycles the individual relays have performed since they were installed.

#### **Query parameters:**

<Relay> See table below for an overview of supported parameters.

#### **Return values:**

<Cycles> Number of switching cycles.

#### **Example:**

DIAG:INFO:CCO? CAL

#### **Usage:**

Query only

#### **Manual operation:**

See "[Relays Cycle Counter](#)" on page 803

SCPI parameter	Hardware component
ACDC	AC/DC coupling
ATT5	Mechanical attenuation 5 dB
ATT10	Mechanical attenuation 10 dB
ATT20	Mechanical attenuation 20 dB
ATT40	Mechanical attenuation 40 dB
CAL	Calibration source
EATT	Electronic attenuation with option B25

---

**DIAGnostic:SERVice:CALibration:DATE** <CalibrationDate>

Defines last date and time the instrument was calibrated in ISO 8601 format.

**Parameters:**

<CalibrationDate> String containing calibration date of the instrument.

**Example:**

```
//Set calibration date
DIAG:SERV:CAL:DATE "2019-05-05T00:00:00Z"
```

**Manual operation:** See "[Last Calibration Date](#)" on page 797

---

**DIAGnostic:SERVice:CALibration:DUE:DATE** <DueDate>

Defines next date and time the instrument needs calibration to be done in ISO 8601 format. The response may be empty in case of no fixed next calibration due.

**Parameters:**

<DueDate> String containing next calibration due date.  
An empty string resets the date (= no due date).

**Example:**

```
//Set calibration due date
DIAG:SERV:CAL:DUE:DATE "2020-05-12T00:00:00Z"
```

**Manual operation:** See "[Next Calibration Due](#)" on page 797

---

**DIAGnostic:SERVice:CALibration:INTERval?**

This command queries the recommended calibration interval (ISO 8601 duration).

**Return values:**

<Interval> String containing the recommended calibration interval.

**Example:**

```
//Query calibration interval
DIAG:SERV:CAL:INT?
//would return, for example (one year interval)
P1Y
```

**Usage:** Query only

**Manual operation:** See ["Next Calibration Due"](#) on page 797

---

### DIAGnostic:SERVice:DATE <ServiceDate>

Defines the last date and time the instrument was serviced (ISO 8601 format).

**Parameters:**

<ServiceDate> String containing last service date.

**Example:**

```
//Return last service date
DIAG:SERV:DATE?
```

**Manual operation:** See ["Last Service Date"](#) on page 797

---

### DEVice:INFO:HWBand?

Queries the frequency bands used for measurement by the FSW hardware. The start frequency of each band is provided.

The bands are instrument-specific and depend on the currently defined RBW, VBW and YIG preselector state. The precise frequency bands are required to define correction data for the correct bands, in particular for frequency-drifting DUTs.

This query is only available in zero span mode.

**Return values:**

<StartFreq>

**Example:**

```
//Set to zero span mode
FREQ:SPAN 0
//Set RBW
BAND:RES 1000000
//Set VBW
BAND:VID 10000
//Query used hardware bands
DEV:INFO:HWB?
//Result:
//0,50000000,450000000,1000000000,3000000000,4000000000,5200000000,...
```

The used bands for this instrument and measurement setup are:

```
0 Hz to 49999999 Hz
50000000 Hz to 44999999
450000000 Hz to 999999999
1000000000 Hz to 2999999999
3000000000 Hz to 3999999999
4000000000 Hz to 5199999999
5200000000 Hz to ...
```

**Usage:** Query only

---

**DIAGnostic:SERVice:BIOSinfo?**

This command queries the BIOS version of the CPU board.

**Return values:**

<BiosInformation> String containing the BIOS version.

**Example:**

```
DIAG:SERV:BIOS?  
Returns the BIOS version.
```

**Usage:**

Query only

---

**DIAGnostic:SERVice:HWInfo?**

This command queries hardware information.

**Return values:**

<Hardware> String containing the following information for every hardware component.  
<component>: name of the hardware component  
<serial#>: serial number of the component  
<order#>: order number of the component  
<model>: model of the component  
<code>: code of the component  
<revision>: revision of the component  
<subrevision>: subrevision of the component

**Example:**

```
DIAG:SERV:HWIN?  
Queries the hardware information.  
"FRONTEND|100001/003|1300.3009|03|01|00|00",  
"MOTHERBOARD|123456/002|1300.3080|02|00|00|00",  
...
```

**Usage:**

Query only

---

**DIAGnostic:SERVice:VERSinfo?**

This command queries information about the hardware and software components.

**Return values:**

<Information> String containing the version of hardware and software components including the types of licenses for installed options.

**Example:**           DIAG:SERV:VERS?  
 Queries the version information.  
**Response:**  
 Instrument Firmware |1.10  
 BIOS |FSW Analyzer BIOS V1.03-1-32-4-3 IPC10  
 Image Version |1.2.0  
 PCI-FPGA |9.01  
 SA-FPGA |2.43  
 MB-FPGA |2.0.8.0  
 SYNTH-FPGA |3.9.0.0  
 REF-FPGA |3.4.0.0  
 Data Sheet Version |01.00  
 Time Control Management |active  
 Analog Demod K7| |permanent

**Usage:**            Query only

### **SYSTem:ERRor:CLEar:ALL**

This command deletes all contents of the "System Messages" table.

**Example:**           SYST:ERR:CLE:ALL

### **SYSTem:DFPRint**

Creates an \*.xml file with information on installed hardware, software, image and FPGA versions. The \*.xml file is stored under C:\R\_S\INSTR\devicedata\xml\DeviceFootprint\_\* on the instrument. It is also output to the remote interface as binary data.

**Return values:**

<xxx>                Contents of the xml file in binary format.

**Example:**           SYST:DFPR?

**Manual operation:** See ["Save Device Footprint"](#) on page 797

### **SYSTem:ERRor:CLEar:REMote**

This command deletes all contents of the "Remote Errors" table.

Note: The remote error list is automatically cleared when the FSW is shut down.

**Example:**           SYST:ERR:CLE:REM

**Manual operation:** See ["Display Remote Errors"](#) on page 857  
 See ["Clear Error List"](#) on page 869

### **SYSTem:ERRor:EXTended? <MessageType>[, <ChannelName>]**

This command queries all system messages, or all messages of a defined type, displayed in the status bar for a specific channel (application).



**Note:** This command queries the strings displayed for manual operation. For remote programs, do not define processing steps depending on these results. Instead, query the results of the `STATUS:QUESTIONABLE:EXTENDED:INFO` status register, which indicates whether messages of a certain type have occurred (see [Chapter 12.2.2.8, "STATUS:QUESTIONABLE:EXTENDED:INFO register"](#), on page 830).

**Parameters:**

<MessageType> ALL | INFO | WARNING | FATAL | ERROR | MESSAGE  
 <ChannelName> String containing the name of the channel.  
 The parameter is optional. If you omit it, the command works for the currently active channel.

**Return values:**

<Messages> String containing all messages of the selected type for the specified channel. Each message is separated by a comma and inserted in parentheses. If no messages are available, empty parentheses are returned.

**Example:**

`SYST:ERR:EXT? ALL`  
 Returns all messages for the currently active application, e.g. "Message 1", "Message 2".

**Example:**

`SYST:ERR:EXT? FAT, 'Spectrum2'`  
 Queries fatal errors in the 'Spectrum2' application. If none have occurred, the result is: " ".

**Usage:**

Query only

**SYSTEM:ERROR:LIST? [<MessType>]**

This command queries the error messages that occur during FSW operation.

**Query parameters:**

<MessType> SMSG | REMote  
**SMSG**  
 (default) Queries the system messages which occurred during manual operation.  
**REMote**  
 Queries the error messages that occurred during remote operation.  
 Note: The remote error list is automatically cleared when the FSW is shut down.

**Return values:**

<SystemMessages> String containing all messages in the "System Messages" table.  
 <RemoteErrors> <Error\_no> | <Description> | <Command> | <Date> | <Time>  
 Comma-separated list of errors from the "Remote Errors" table, where:  
 <Error\_no>: device-specific error code  
 <Description>: brief description of the error  
 <Command>: remote command causing the error

<Date>|<Time>: date and time the error occurred

**Usage:** Query only

### **SYSTem:ERRor[:NEXT]?**

This command queries the most recent error queue entry and deletes it.

Positive error numbers indicate device-specific errors, negative error numbers are error messages defined by SCPI. If the error queue is empty, the error number 0, "No error", is returned.

For details on error queues see [Chapter 12.2, "Status reporting system"](#), on page 822.

**Usage:** Query only

### **SYSTem:FIRMware:UPDate <Directory>**

This command starts a firmware update using the \*.msi files in the selected directory. The default path is D:\FW\_UPDATE. The path is changed via the [MMEMory:COMMENT](#) command. To store the update files the [MMEMory:DATA](#) command is used.

Only user accounts with administrator rights can perform a firmware update.

#### **Setting parameters:**

<Directory>

**Example:** `SYST:FIRM:UPD 'D:\FW_UPDATE'`  
Starts the firmware update from directory "D:\FW\_UPDATE".

### **SYSTem:FORMat:IDENt <IDNFormat>**

This command selects the response format to the [\\*IDN?](#) query.

#### **Parameters:**

<IDNFormat>

#### **LEGacy**

Format is compatible to R&S FSP/FSU/FSQ/FSG family.

#### **NEW | FSL**

FSW format

Format is also compatible to the R&S FSL and R&S FSV family

\*RST: not reset!

**Example:** `SYST:FORM:IDEN LEG`  
Adapts the return value of [\\*IDN?](#) to the R&S FSP/FSU/FSQ family.

**Manual operation:** See "[\\*IDN Format](#)" on page 856

### **SYSTem:OPTion:LIcense[:LIST] <Option>, <State>, <Days>**

Defines the availability of floating licenses for the FSW.

**Parameters:**

<Option>	string value Name of an option whose license is set.
<State>	ON   OFF   OCCupy State of the license <b>ON</b> Floating license enabled <b>OFF</b> Floating license disabled <b>OCCupy</b> Occupied license
<Days>	The time period that an occupied license is stored locally after it is retrieved from the license server. Range: 1 to 7 Default unit: days
<b>Example:</b>	Disable floating license for K102: <code>SYST:OPT:LIC 'K102',OFF</code>
<b>Example:</b>	Configure occupied license for K100 for 5 days: <code>SYST:OPT:LIC 'K100',OCC,5</code>
<b>Usage:</b>	Setting only
<b>Manual operation:</b>	See " <a href="#">Enabling/disabling floating licenses</a> " on page 787

---

**SYSTem:OPTion:LICense[:LIST]? [<Option>]**

Queries the availability of floating licenses on all license servers configured on the FSW.

**Query parameters:**

<Option>	string value Optional: Name of an option whose license is queried.
----------	-----------------------------------------------------------------------

**Return values:**

<Option>	string values Comma-separated list of strings for available options with a floating license.
<State>	ON   OFF   OCCupy State of the license <b>ON</b> Floating license enabled <b>OFF</b> Floating license disabled <b>OCCupy</b> Occupied license

**<Days>** The remaining time period that an occupied license is available.  
 Range: 1 to 7  
 Default unit: days

**Example:** Query which type of license is available for K100:  
 SYST:OPT:LIC? 'K100'  
 //Result: K100 floating  
 //K100,ON

**Example:** Query which licenses are available for the FSW:  
 SYST:OPT:LIC?  
 //Result:  
 B4,ON,B5,ON,B21,ON,B114,ON,K10,OFF,K91,ON,  
 K91AC,ON,K91N,OFF,K100,OCC,  
 2,K101,ON,K102,ON,K103,ON,K104,ON,K105,ON,K106,  
 ON

**Usage:** Query only

**Manual operation:** See "[License state \( ... \)](#)" on page 787

#### SYSTem:OPTion:TRial:LIST? <ResultFilter>

Queries availability of applications using trial option T0.

##### Query parameters:

<ResultFilter> TRial  
 Returns available trial options.

##### Return values:

<OptionList> string values  
 Comma-separated list of strings for available options with trial license.

**Usage:** Query only

**Manual operation:** See "[License state \( ... \)](#)" on page 787

#### SYSTem:OPTion:TRial[:STATe] <State>

Determines availability of trial option T0. It is pre-installed at the factory on request.

##### Parameters:

<State> ON | OFF | 0 | 1  
**OFF | 0**  
 Switches the function off.  
 The query result indicates the trial license is not available (not installed, expired).

**ON | 1**

If enabled, you can use additional applications for a limited period of time (90 days from factory installation). They are accessible from the common "Mode" dialog box (see [Chapter 5.3, "Selecting the operating mode and applications"](#), on page 120).

If the trial license is not available (not installed, expired) the command returns an error (E\_OPTION\_NA).

\*RST: 0

**Manual operation:** See "[License state \( \)](#)" on page 787

**SYSTem:PRESet:COMPAtible** <OpMode>

Defines the operating mode that is activated when you switch on the FSW or press [PRESET].

For details on operating modes see [Chapter 5, "Applications, measurement channels, and operating modes"](#), on page 109.

**Parameters:**

<OpMode>

**SANalyzer**

(Default:)

Defines Signal and Spectrum Analyzer operating mode as the presetting.

**MSRA**

Defines Multi-Standard Radio Analysis (MSRA) as the preset default operating mode.

**RTMS**

Defines Multi-Standard Real-Time (MSRT) as the preset default operating mode.

**Manual operation:** See "[Preset Mode](#)" on page 791

**SYSTem:SECurity[:STATe]** <State>

Activates or queries secure user mode.

**Note:** Before you activate secure user mode, store any instrument settings that are required beyond the current session, such as predefined instrument settings, transducer files, or self-alignment data.

**Note:** Initially after installation of the R&S FSW-K33 option, secure user mode must be enabled manually once before remote control is possible. This is necessary to prompt for a change of passwords.

For details on the secure user mode see [Chapter 4.2.15, "Protecting data using the secure user mode"](#), on page 39.

**Parameters:**

<State>

ON | OFF | 0 | 1

**ON | 1**

The FSW automatically reboots and starts in secure user mode. In secure user mode, no data is written to the instrument's internal solid-state drive. Data that the FSW normally stores on the solid-state drive is redirected to SDRAM.

**OFF | 0**

The FSW is set to normal instrument mode. Data is stored to the internal solid-state drive.

Note: this parameter is for query only. Secure user mode cannot be deactivated via remote operation.

\*RST: 0

**Manual operation:** See "[SecureUser Mode](#)" on page 792

### 13.10.10 Signal generator control commands

The remote commands required to control connected generators are described here.

<a href="#">CONFigure:GENerator:CONNection:CSTate?</a> .....	1454
<a href="#">CONFigure:GENerator:CONNection[:STATe]</a> .....	1454
<a href="#">CONFigure:GENerator:IPConnecTion:ADDResS</a> .....	1455

---

#### **CONFigure:GENerator:CONNection:CSTate?**

Queries the state of the connected signal generator.

**Return values:**

<ConnectionState>	<b>UNKNown</b> no signal generator connected
	<b>CONNected</b> connection established
	<b>NCONNected</b> connection could not be established, possibly due to an incompatible instrument or invalid IP address

**Example:** `CONFigure:GENerator:CONNecTion:CSTate?`

**Usage:** Query only

**Manual operation:** See "[IP Address](#)" on page 226  
See "[Connect/Disconnect](#)" on page 226  
See "[Test Connection](#)" on page 794

---

#### **CONFigure:GENerator:CONNecTion[:STATe] <State>**

Connects or disconnects the signal generator specified by [CONFigure:GENerator:IPConnecTion:ADDResS](#) on page 1455. The IP address must be specified before you use this command.

**Parameters:**

<State> ON | OFF | 0 | 1

**OFF | 0**

Disconnects the generator.

**ON | 1**

Connects the generator.

\*RST: 0

**Example:** CONF:GEN:IPC:ADDR '192.168.114.90'  
CONF:GEN:CONN:STAT ON

**Usage:** Asynchronous command

**Manual operation:** See ["Connect/Disconnect"](#) on page 226  
See ["Test Connection"](#) on page 794

**CONFigure:GENerator:IPConnection:ADDRess <IPAddress>**

The TCP/IP address or computer name of the signal generator connected to the FSW via LAN.

The IP address / computer name is maintained after a [PRESET], and is transferred between applications.

**Parameters:**

<IPAddress> IP address or computer name

**Example:** CONF:GEN:IPC:ADDR '192.168.114.90'

**Manual operation:** See ["IP Address / Computer Name"](#) on page 226  
See ["IP Address or Computer name of Signal Generator"](#) on page 794

**13.10.11 Using service functions**

<a href="#">DIAGnostic:SERvice:SFUNction</a> .....	1455
<a href="#">DIAGnostic:SERvice:SFUNction:LASTresult?</a> .....	1456
<a href="#">DIAGnostic:SERvice:SFUNction:RESults:DELeTe</a> .....	1456
<a href="#">DIAGnostic:SERvice:SFUNction:RESults:SAVE</a> .....	1456
<a href="#">DIAGnostic:SERvice:SINFo?</a> .....	1457
<a href="#">SYSTem:PASSword[:CENable]</a> .....	1457
<a href="#">SYSTem:PASSword:RESet</a> .....	1458

**DIAGnostic:SERvice:SFUNction <ServiceFunction>****DIAGnostic:SERvice:SFUNction? <ServiceFunction>**

This command starts a service function.

The service functions are available after you have entered the level 1 or level 2 system password.

**Parameters for setting and query:**

<ServiceFunction> String containing the ID of the service function.

The ID of the service function is made up out of five numbers, separated by a point.

- function group number
- board number
- function number
- parameter 1 (see the Service Manual)
- parameter 2 (see the Service Manual)

**Return values:**

<Result>

**Example:**

```
DIAG:SERV:SFUN 'Function1'
DIAG:SERV:SFUN? 'Function2'
```

**Manual operation:** See "[Service Function](#)" on page 801  
See "[Send](#)" on page 801

**DIAGnostic:SERvice:SFUNction:LASTresult?**

This command queries the results of the most recent service function you have used.

**Return values:**

<Result>

**Usage:** Query only

**DIAGnostic:SERvice:SFUNction:RESults:DELeTe**

This command deletes the results in the output buffer for service functions you have used.

**Usage:** Event

**Manual operation:** See "[Clear Results](#)" on page 802

**DIAGnostic:SERvice:SFUNction:RESults:SAVE [<FileName>]**

This command saves the results in the output buffer for service functions you have used to a file.

If no <FileName> parameter is provided, the results are stored to  
C:\R\_S\INSTR\results\ServiceLog.txt.

Note that if the buffer is empty, the function returns an error.

**Parameters:**

<FileName> String containing the path and file name.

**Manual operation:** See "[Save Results](#)" on page 802



**DIAGnostic:SERVice:SINFo?**

This command creates a \*.zip file with important support information. The \*.zip file contains the system configuration information ("device footprint"), the current eeprom data and a screenshot of the screen display (if available).

This data is stored to the `C:\R_S\INSTR\USER` directory on the instrument.

As a result of this command, the created file name (including the drive and path) is returned.

You can use the resulting file name information as a parameter for the `MMEM:COPY` command to store the file on the controller PC.

(See `MMEMory:COPY` on page 1350)

If you contact the Rohde & Schwarz support to get help for a certain problem, send this file to the support in order to identify and solve the problem faster.

**Return values:**

<FileName> C:\R\_S\INSTR\USER  
 \<R&S Device ID>\_<CurrentDate>\_<CurrentTime>  
 String containing the drive, path and file name of the created support file, where the file name consists of the following elements:  
**<R&S Device ID>**: The unique R&S device ID indicated in the "Versions + Options" information  
 (See [Chapter 11.7.2, "Licensing, versions and options"](#), on page 784)  
**<CurrentDate>**: The date on which the file is created (<YYYYMMDD>)  
**<CurrentTime>**: The time at which the file is created (<HHMMSS>)

**Usage:** Query only

**Manual operation:** See ["Create R&S Support Information"](#) on page 796

**Example:**

```
DIAG:SERV:SINF?
```

Result:

```
"C:  

\R_S\INSTR\USER\FSW-26_1312.8000K26-100005-xx_20150420_113652.zip"
```

**SYSTem:PASSword[:CENable] <arg0>**

Provides a password for subsequent service functions.

**Parameters:**

<arg0> string

**Example:** SYST:PASS:CEN '894129'

**Manual operation:** See ["Password"](#) on page 802

**SYSTem:PASSword:RESet**

Clears any previously provided password and returns to the most restrictive service level.

**Manual operation:** See "Password" on page 802

**13.10.12 Remote commands for synchronizing parameters**

The commands for manual operation are described in [Chapter 11.9, "Synchronizing measurement channel configuration"](#), on page 803

- [Predefined parameter coupling](#)..... 1458
- [User-defined parameter coupling](#)..... 1464
- [Generator coupling](#)..... 1473

**13.10.12.1 Predefined parameter coupling**

<a href="#">INSTrument:COUPle:ABIMpedance</a> .....	1458
<a href="#">INSTrument:COUPle:ACDC</a> .....	1459
<a href="#">INSTrument:COUPle:ATTen</a> .....	1459
<a href="#">INSTrument:COUPle:AUNit</a> .....	1459
<a href="#">INSTrument:COUPle:BANDwidth</a> .....	1460
<a href="#">INSTrument:COUPle:BWIDth</a> .....	1460
<a href="#">INSTrument:COUPle:CENTer</a> .....	1460
<a href="#">INSTrument:COUPle:DEMod</a> .....	1461
<a href="#">INSTrument:COUPle:GAIN</a> .....	1461
<a href="#">INSTrument:COUPle:IMPedance</a> .....	1461
<a href="#">INSTrument:COUPle:LIMit</a> .....	1462
<a href="#">INSTrument:COUPle:LLINes</a> .....	1462
<a href="#">INSTrument:COUPle:MARKer</a> .....	1462
<a href="#">INSTrument:COUPle:PRESel</a> .....	1463
<a href="#">INSTrument:COUPle:RLEVel</a> .....	1463
<a href="#">INSTrument:COUPle:SPAN</a> .....	1463
<a href="#">INSTrument:COUPle:VBW</a> .....	1464

**INSTrument:COUPle:ABIMpedance <State>**

This command turns synchronization of the amplitude baseband impedance configuration between measurement channels on and off.

**Parameters:**

<State>                    ALL | NONE

**ALL**  
Turns on synchronization.

**NONE**  
Turns off synchronization.

\*RST:                    NONE

**Example:**                    INST:COUP:ABIM ALL

**Manual operation:** See ["Synchronizing parameters across all measurement channels"](#) on page 804

---

#### INSTrument:COUPle:ACDC <State>

This command turns synchronization of the AC / DC Coupling state between measurement channels on and off.

**Parameters:**

<State> ALL | NONE  
**ALL**  
 Turns on synchronization.  
**NONE**  
 Turns off synchronization.  
 \*RST: ALL

**Example:** INST:COUP:ACDC ALL  
 Synchronizes the "AC/DC Coupling" parameter.

**Manual operation:** See ["Synchronizing parameters across all measurement channels"](#) on page 804

---

#### INSTrument:COUPle:ATTen <State>

This command turns synchronization of the attenuation and unit between measurement channels on and off.

**Parameters:**

<State> ALL | NONE  
**ALL**  
 Turns on synchronization.  
**NONE**  
 Turns off synchronization.  
 \*RST: ALL

**Example:** INST:COUP:ATT ALL  
 Synchronizes the attenuation.

**Manual operation:** See ["Synchronizing parameters across all measurement channels"](#) on page 804

---

#### INSTrument:COUPle:AUNit <State>

This command turns synchronization of the amplitude unit configuration between measurement channels on and off.

**Parameters:**

<State> ALL | NONE  
**ALL**  
 Turns on synchronization.

**NONE**

Turns off synchronization.

**\*RST:** NONE**Example:** INST:COUP:AUN ALL**Manual operation:** See ["Synchronizing parameters across all measurement channels"](#) on page 804**INSTrument:COUPle:BANDwidth <State>****INSTrument:COUPle:BWIDth <State>**

This command turns synchronization of the resolution bandwidth (and filter type) between measurement channels on and off.

**Parameters:**

&lt;State&gt; ALL | NONE

**ALL**

Turns on synchronization.

**NONE**

Turns on synchronization.

**\*RST:** NONE**Example:** INST:COUP:BWID ALL  
Synchronizes the resolution bandwidth.**INSTrument:COUPle:CENTer <State>**

This command turns synchronization of the frequency between measurement channels on and off.

**Parameters:**

&lt;State&gt; ALL | NONE

**ALL**

Turns on synchronization.

**NONE**

Turns off synchronization.

**\*RST:** ALL**Example:** INST:COUP:CENT ALL  
Synchronizes the center frequency.**Manual operation:** See ["Synchronizing parameters across all measurement channels"](#) on page 804

---

**INSTrument:COUPle:DEMod** <State>

This command turns synchronization of the audio demodulator configuration between measurement channels on and off.

**Parameters:**

<State>                    ALL | NONE  
**ALL**  
 Turns on synchronization.  
**NONE**  
 Turns off synchronization.  
 \*RST:                    NONE

**Example:**

INST:COUP:DEM ALL  
 Synchronizes the audio demodulator configuration.

---

**INSTrument:COUPle:GAIN** <State>

This command turns synchronization of the preamplifier configuration between measurement channels on and off.

**Parameters:**

<State>                    ALL | NONE  
**ALL**  
 Turns on synchronization.  
**NONE**  
 Turns off synchronization.  
 \*RST:                    NONE

**Example:**

INST:COUP:GAIN ALL  
 Synchronizes the preamplifier configuration.

**Manual operation:** See ["Synchronizing parameters across all measurement channels"](#) on page 804

---

**INSTrument:COUPle:IMPedance** <State>

This command turns synchronization of the impedance configuration between measurement channels on and off.

**Parameters:**

<State>                    ALL | NONE  
**ALL**  
 Turns on synchronization.  
**NONE**  
 Turns off synchronization.  
 \*RST:                    NONE

**Example:**

INST:COUP:IMP ALL

**Manual operation:** See ["Synchronizing parameters across all measurement channels"](#) on page 804

---

#### **INSTrument:COUPle:LIMit** <State>

This command turns synchronization of limit results between measurement channels on and off.

##### **Parameters:**

<State> ALL | NONE

**ALL**  
Turns on synchronization.  
Limit lines have to be compatible to the x-axis and y-axis configuration for successful synchronization.

**NONE**  
Turns off synchronization.

\*RST: ALL

**Example:** INST:COUP:LIM ALL  
Synchronizes the limit values.

**Manual operation:** See ["Synchronizing parameters across all measurement channels"](#) on page 804

---

#### **INSTrument:COUPle:LLINes** <State>

This command turns synchronization of the limit lines between measurement channels on and off.

##### **Parameters:**

<State> ALL | NONE

**ALL**  
Turns on synchronization.

**NONE**  
Turns off synchronization.

\*RST: NONE

---

#### **INSTrument:COUPle:MARKer** <State>

This command turns synchronization of the marker frequency in the spectrum application and the receiver frequency on and off.

##### **Parameters:**

<State> ALL | NONE

**ALL**  
Turns on synchronization.

**NONE**  
Turns off synchronization.

\*RST: NONE

**Example:** `INST:COUP:MARK ALL`  
Synchronizes the receiver frequency and the marker frequency.

#### **INSTrument:COUPle:PRESeI <State>**

This command turns synchronization of the preselector state between measurement channels on and off.

**Parameters:**

<State> ALL | NONE  
**ALL**  
Turns on synchronization.  
**NONE**  
Turns off synchronization.  
 \*RST: ALL

**Example:** `INST:COUP:PREs ALL`  
Synchronizes the preselector configuration.

#### **INSTrument:COUPle:RLEVeI <State>**

This command turns synchronization of the reference level between measurement channels on and off.

**Parameters:**

<State> ALL | NONE  
**ALL**  
Turns on synchronization.  
**NONE**  
Turns off synchronization.  
 \*RST: NONE

**Example:** `INST:COUP:RLEV ALL`

**Manual operation:** See ["Synchronizing parameters across all measurement channels"](#) on page 804

#### **INSTrument:COUPle:SPAN <State>**

This command turns synchronization of the start and stop frequency between measurement channels on and off.

**Parameters:**

<State> ALL | NONE  
**ALL**  
Turns on synchronization.  
**NONE**  
Turns off synchronization.  
 \*RST: NONE

**Example:** `INST:COUP:SPAN ALL`  
Synchronizes the start and stop frequency.

**Manual operation:** See ["Synchronizing parameters across all measurement channels"](#) on page 804

#### **INSTrument:COUPle:VBW <State>**

This command turns synchronization of the video bandwidth between measurement channels on and off.

**Parameters:**

<State> ALL | NONE  
**ALL**  
Turns on synchronization.  
**NONE**  
Turns off synchronization.  
 \*RST: NONE

**Example:** `INST:COUP:VBW ALL`  
Synchronizes the video bandwidth.

**Manual operation:** See ["Synchronizing parameters across all measurement channels"](#) on page 804

### 13.10.12.2 User-defined parameter coupling

<code>INSTrument:COUPle:USER&lt;uc&gt;</code> .....	1464
<code>INSTrument:COUPle:USER&lt;uc&gt;:CHANnel:LIST?</code> .....	1466
<code>INSTrument:COUPle:USER&lt;uc&gt;:ELEMEnt:LIST?</code> .....	1466
<code>INSTrument:COUPle:USER&lt;uc&gt;:INFO</code> .....	1467
<code>INSTrument:COUPle:USER&lt;uc&gt;:NEW?</code> .....	1468
<code>INSTrument:COUPle:USER&lt;uc&gt;:NUMBers:LIST?</code> .....	1470
<code>INSTrument:COUPle:USER&lt;uc&gt;:RELation</code> .....	1470
<code>INSTrument:COUPle:USER&lt;uc&gt;:REMOve</code> .....	1471
<code>INSTrument:COUPle:USER&lt;uc&gt;:STATe</code> .....	1471
<code>INSTrument:COUPle:USER&lt;uc&gt;:WINDow:LIST?</code> .....	1472

**INSTrument:COUPle:USER<uc>** <ChannelName>, <Window>, <Parameter>, <ChannelName>, <Window>, <Parameter>, <Direction>, <State>

This command edits an existing user-defined coupling definition.

The parameters for this command are identical to `INSTrument:COUPle:USER<uc>:NEW?`. Note, however, that for `INSTrument:COUPle:USER<uc>`, the last two parameters (<Direction> and <State>) are **not optional**.

**Note:** Make sure to specify the right index number via the `USER` suffix.



<b>Suffix:</b>	
<uc>	Index of a user-defined parameter coupling. To obtain the list of indexes for currently defined coupling, see <code>INSTRUMENT:COUPLE:USER&lt;uc&gt;:NUMBERS:LIST?</code> .
<b>Parameters:</b>	
<ChannelName>	String containing the name of a measurement channel or channel type. <b>&lt;Name&gt;</b> To synchronize two specific measurement channels. <b>'All Spectrum'</b> To synchronize all spectrum channels. <b>'All IQ Analyzer'</b> To synchronize all I/Q analyzer channels. <b>'All Analog Demod'</b> To synchronize all analog demodulation channels. <b>'All Channels'</b> To synchronize all channels, regardless of their type.
<Window>	String containing the name of a measurement window. <b>&lt;Name&gt;</b> To synchronize a specific window (only possible in the Analog Demodulation application). <b>'All Windows'</b> To synchronize all measurement windows.
<Parameter>	String containing the name of a synchronizable parameter.
<ChannelName>	String containing the name of a measurement channel or channel type. The second channel name is only necessary for synchronization between two specific channels. If you synchronize all channels of the same type or all channels, the string has to be empty.
<Window>	String containing the name of a measurement window. The second window name is only necessary for synchronization between two specific channels. If you synchronize all channels of the same type or all channels, the string has to be empty.
<Parameter>	String containing the name of a synchronizable parameter. The second parameter name is only necessary for synchronization between two specific channels. If you synchronize all channels of the same type or all channels, the string has to be empty.
<Direction>	LTOR   RTOL   BDir Selects the direction in which synchronization works. <b>BDir</b> Changes of a parameter are applied both ways (from channel 1 to channel 2 and vice versa).

**LTOR**

Changes of a parameter are applied from channel 1 to channel 2, but not the other way around.

**RTOL**

Changes of a parameter are applied from channel 2 to channel 1, but not the other way around.

&lt;State&gt;

ON | OFF | 0 | 1

Enables or disables the coupling

**OFF | 0**

Switches the coupling off

**ON | 1**

Switches the coupling on

\*RST: 1

**Example:**

```
INST:COUP:USER3 'Spectrum1','All
Windows','Attenuation','Spectrum 2','All
Windows','Attenuation',BID,ON
Synchronizes the attenuation between the channels named
'Spectrum1' and 'Spectrum 2' in both directions and turns on the
coupling.
```

**Manual operation:** See ["Edit coupling definition"](#) on page 807

**INSTrument:COUPle:USER<uc>:CHANnel:LIST?**

This command queries the names of the measurement channels that can be synchronized.

**Suffix:**

&lt;uc&gt; irrelevant

**Return values:**

&lt;SynchronizableChannelName&gt; Comma-separated list of strings

All channels that can be synchronized.

**Example:**

INST:COUP:USER:CHAN:LIST?

Result:

```
'SPEC1','AD1','All Spectrum','All
Channels','All Analog Demod'
```

**Usage:**

Query only

**Manual operation:** See ["Channel 1 / Channel 2"](#) on page 809

**INSTrument:COUPle:USER<uc>:ELEMent:LIST? [<ChannelName>, <Parameter>]**

This command queries parameters that can be synchronized.

**Suffix:**

&lt;uc&gt; irrelevant

**Query parameters:**

- <ChannelName> Optional SCPI parameter.  
String containing the name of a measurement channel.
- <Parameter> Optional SCPI parameter.  
String containing the name of a parameter that you can synchronize.

**Return values:**

- <SynchronizableParameters> Comma-separated list of parameters.

**No parameters provided**

Parameters that can be synchronized for all channels

**Channel name provided**

Parameters that can be synchronized for the selected channel

**Parameter and channel name provided**

Parameters that can be synchronized with the specified parameter for the selected channel.

**Example:**

```
INST:COUP:USER:ELEM:LIST?
```

Result: all parameters that can be coupled:

```
'AC DC Coupling', 'Attenuation', 'Center  
Frequency', 'Display Lines', 'Frequency Marker  
1', ...
```

**Example:**

```
INST:COUP:USER:ELEM:LIST? 'Spectrum'
```

Result: all parameters that can be coupled in the 'Spectrum' channel:

```
'AC DC Coupling', 'Attenuation', 'Center  
Frequency', 'Display Lines', ...
```

**Example:**

```
INST:COUP:USER:ELEM:LIST? 'Spectrum',  
'Attenuation'
```

Result: all parameters that can be coupled to 'Attenuation' in the 'Spectrum' channel:

```
'Attenuation'
```

(Attenuation is the only parameter that can be coupled to attenuation.)

**Usage:**

Query only

**Manual operation:** See "[Coupling Element 1 / Coupling Element 2](#)" on page 809

**INSTrument:COUPle:USER<uc>:INFO**

This command queries additional information about the specified user-defined parameter coupling.

**Suffix:**

- <uc> Index of a user-defined parameter coupling. To obtain the list of indexes for currently defined coupling, see [INSTrument:COUPle:USER<uc>:NUMBers:LIST?](#).

**Return values:**

<Information> String containing the message as displayed in the coupling manager.  
If the coupling message contains no message, an empty string is returned.

**Example:**

```
INST:COUP:USER2:INFO?
```

Queries possible information about the user coupling with index 2.

Result:

```
'Only one limit line allowed'
```

**Manual operation:** See ["Info"](#) on page 808

**INSTrument:COUPle:USER<uc>:NEW?** <ChannelName>, <Window>, <Parameter>, <ChannelName>, <Window>, <Parameter>, <Direction>, <State>

This command creates a new user-defined parameter coupling.

After the new coupling has been created, the command returns the index number of the new coupling. Therefore, the command is implemented as a query.

**Suffix:**

<uc> irrelevant

**Query parameters:**

<ChannelName> String containing the name of a measurement channel or channel type.

**<Name>**

To synchronize two specific measurement channels.

**'All Spectrum'**

To synchronize all spectrum channels.

**'All IQ Analyzer'**

To synchronize all I/Q analyzer channels.

**'All Analog Demod'**

To synchronize all analog demodulation channels.

**'All Channels'**

To synchronize all channels, regardless of their type.

<Window> String containing the name of a measurement window.

**<Name>**

To synchronize a specific window (only possible in the Analog Demodulation application).

**'All Windows'**

To synchronize all measurement windows.

<Parameter> String containing the name of a synchronizable parameter.

<ChannelName>	<p>String containing the name of a measurement channel or channel type.</p> <p>The second channel name is only necessary for synchronization between two specific channels. If you synchronize all channels of the same type or all channels, the string has to be empty.</p>
<Window>	<p>String containing the name of a measurement window.</p> <p>The second window name is only necessary for synchronization between two specific channels. If you synchronize all channels of the same type or all channels, the string has to be empty.</p>
<Parameter>	<p>String containing the name of a synchronizable parameter.</p> <p>The second parameter name is only necessary for synchronization between two specific channels. If you synchronize all channels of the same type or all channels, the string has to be empty.</p>
<Direction>	<p>LTOR   RTOL   BDir</p> <p>Optional: Selects the direction in which synchronization works.</p> <p><b>BDir</b> Changes of a parameter are applied both ways (from channel 1 to channel 2 and vice versa).</p> <p><b>LTOR</b> Changes of a parameter are applied from channel 1 to channel 2, but not the other way around.</p> <p><b>RTOL</b> Changes of a parameter are applied from channel 2 to channel 1, but not the other way around.</p>
<State>	<p>ON   OFF   0   1</p> <p>Optional. Enables or disables coupling.</p> <p><b>OFF   0</b> Switches the coupling off</p> <p><b>ON   1</b> Switches the coupling on</p> <p>*RST:        1</p>
<b>Return values:</b>	
<Index>	<p>Index number of the new user-defined coupling.</p> <p>Note that the returned index numbers do not necessarily have to be the same as those shown in the user interface.</p>
<b>Example:</b>	<pre>INST:COUP:USER:NEW? 'Spectrum1','All Windows','Attenuation','Spectrum2','All Windows','Attenuation',BID,ON</pre> <p>Result: 3</p> <p>Synchronizes the attenuation between the channels named 'Spectrum1' and 'Spectrum2' in both directions and turns on the coupling. Also returns the index number of the user-defined coupling.</p>

- Example:** `INST:COUP:USER:NEW? 'All Spectrum','All Windows','Attenuation','','',' ',BID,ON`  
**Result:**  
 3  
 Synchronizes the attenuation between all Spectrum channels in both directions and turns on the coupling. Also returns the index number of the user-defined coupling.
- Usage:** Query only
- Manual operation:** See ["Parameter 1 / Parameter 2"](#) on page 808  
 See ["Add New User Coupling"](#) on page 808

### INSTrument:COUPle:USER<uc>:NUMBers:LIST?

This command queries the index numbers of user-defined parameter couplings. The index numbers are used to refer to the specific coupling in remote commands with a `USER<uc>` suffix.

- Suffix:**  
`<uc>` irrelevant
- Return values:**  
`<Index>` Comma-separated list of strings  
 Index numbers of all available user-defined couplings  
 Note that the returned index numbers are not necessarily the same as those shown in the user interface.
- Example:** `INST:COUP:USER:NUMB:LIST?`  
**Result:**  
 '1','2','4'  
 Number '3' is not returned, because a coupling with that index does not exist anymore.
- Usage:** Query only
- Manual operation:** See ["Index"](#) on page 807

### INSTrument:COUPle:USER<uc>:RELation <Direction>

This command selects the direction in which synchronization works.

Note that the command is not available if you synchronize over all channels or all channels of the same application.

- Suffix:**  
`<uc>` Index of a user-defined parameter coupling. To obtain the list of indexes for currently defined coupling, see [INSTrument:COUPle:USER<uc>:NUMBers:LIST?](#).
- Parameters:**  
`<Direction>` LTOR | RTOL | BIDir

**BIDir**

Changes of a parameter are applied both ways (from channel 1 to channel 2 and vice versa).

**LTOR**

Changes of a parameter are applied from channel 1 to channel 2, but not the other way around.

**RTOL**

Changes of a parameter are applied from channel 2 to channel 1, but not the other way around.

**Example:**

```
INST:COUP:USER:REL BID
```

Selects bidirectional changes for the user-defined coupling with the index number 1.

**Manual operation:** See "[Direction](#)" on page 808

**INSTrument:COUPle:USER<uc>:REMOve [<Scope>]**

This command deletes a user-defined coupling mechanism.

**Suffix:**

<uc> Index of a user-defined parameter coupling. To obtain the list of indexes for currently defined coupling, see [INSTrument:COUPle:USER<uc>:NUMBers:LIST?](#).

**Parameters:**

<Scope>

**ALL**

Optional SCPI parameter, used instead of the <uc> suffix. Deletes all user-defined couplings.

**Example:**

```
INST:COUP:USER3:REM
```

Removes the user-defined coupling with the index number 3.

**Manual operation:** See "[Delete coupling definition](#)" on page 808  
See "[Delete All](#)" on page 808

**INSTrument:COUPle:USER<uc>:STATe <State>**

Enables or disables the specified user-defined parameter coupling.

**Suffix:**

<uc> Index of a user-defined parameter coupling. To obtain the list of indexes for currently defined coupling, see [INSTrument:COUPle:USER<uc>:NUMBers:LIST?](#).

**Parameters:**

<State>

ON | OFF | 1 | 0

**OFF | 0**

Switches the function off

**ON | 1**

Switches the function on

\*RST: 0

**Example:** INST:COUP:USER2:STAT ON  
Turns on the coupling with the index number 2.

**Manual operation:** See "State" on page 808

### INSTrument:COUPle:USER<uc>:WINDow:LIST? [<ChannelName>, <Parameter>]

This command queries the measurement windows that can be synchronized with another channel (or measurement window).

Note that synchronizing with a specific measurement window is only possible in the Analog Demodulation application.

#### Suffix:

<uc> irrelevant

#### Query parameters:

<ChannelName> Optional SCPI parameter.  
String containing the name of a measurement channel.

<Parameter> Optional SCPI parameter.  
String containing the name of a parameter that you can synchronize.

#### Return values:

<SynchronizableWindows> Comma-separated list of strings

##### 'All Windows'

All windows can be synchronized. This value is always returned if no parameters are provided with the command.

##### Comma-separated list of strings

String containing the names of the measurement windows that can be synchronized.

This value is only available for marker coupling, which can be set independently of the measurement window.

**Example:** INST:COUP:USER:WIND:LIST?

**Result:**  
'All Windows'

**Example:** INST:COUP:USER:WIND:LIST? 'Analog Demod','Frequency Marker 1'

**Result:**  
'All Windows','1','2','3','4','5','6'

The "Specifics for Window" list contains the entries "All Windows" and each of the windows 1 to 6. The frequency marker 1 can be synchronized in any or all of the windows in the 'Analog Demod' channel.

**Usage:** Query only

**Manual operation:** See "Specifics for Window" on page 809



### 13.10.12.3 Generator coupling

INSTRument:COUPle:GENerator:CENTer:OFFSet.....	1473
INSTRument:COUPle:GENerator:CENTer[:STATe].....	1473
INSTRument:COUPle:GENerator:RLEVel:OFFSet.....	1473
INSTRument:COUPle:GENerator:RLEVel[:STATe].....	1474
INSTRument:COUPle:GENerator:STATe.....	1474

---

#### INSTRument:COUPle:GENerator:CENTer:OFFSet <Frequency>

Defines a fixed offset to the center frequency of the FSW for the coupled signal generator.

This command requires the `INSTRument:COUPle:GENerator:STATe` and the `INSTRument:COUPle:GENerator:CENTer[:STATe]` to be ON.

#### Parameters:

<Frequency>            Default unit: HZ

#### Example:

```
INST:COUP:GEN:STAT ON
INST:COUP:GEN:CENT:STAT ON
INST:COUP:GEN:CENT:OFFS 5
```

**Manual operation:** See "[Generator Frequency Offset](#)" on page 812

---

#### INSTRument:COUPle:GENerator:CENTer[:STATe] <State>

Couples the center frequency of the connected signal generator to the FSW.

This command requires the `INSTRument:COUPle:GENerator:STATe` to be ON.

#### Parameters:

<State>            ON | OFF | 0 | 1  
**OFF | 0**  
 Switches the function off  
**ON | 1**  
 Switches the function on  
 \*RST:            0

#### Example:

```
INST:COUP:GEN:STAT ON
INST:COUP:GEN:CENT:STAT ON
```

**Manual operation:** See "[Center Frequency](#)" on page 811

---

#### INSTRument:COUPle:GENerator:RLEVel:OFFSet <Level>

Defines a fixed offset to the reference level of the FSW for the coupled signal generator.

This command requires the `INSTRument:COUPle:GENerator:STATe` and the `INSTRument:COUPle:GENerator:RLEVel[:STATe]` to be ON.

**Parameters:**

<Level> Default unit: DB

**Example:**

```

INST:COUP:GEN:STAT ON
INST:COUP:GEN:RLEV:STAT ON
INST:COUP:GEN:RLEV:OFFS 5

```

**Manual operation:** See "[Generator Reference Level Offset](#)" on page 812

**INSTrument:COUPle:GENerator:RLEVel[:STATe] <State>**

Couples the reference level of the connected signal generator to the FSW.

This command requires the `INSTrument:COUPle:GENerator:STATe` to be ON.

**Parameters:**

<State> ON | OFF | 0 | 1

**OFF | 0**  
Switches the function off

**ON | 1**  
Switches the function on

\*RST: 0

**Example:**

```

INST:COUP:GEN:STAT ON
INST:COUP:GEN:RLEV:STAT ON

```

**Manual operation:** See "[Reference level](#)" on page 812

**INSTrument:COUPle:GENerator:STATe <State>**

Enables or disables coupling between the FSW and a connected signal generator.

**Parameters:**

<State> ON | OFF | 0 | 1

**OFF | 0**  
Switches the function off

**ON | 1**  
Switches the function on

\*RST: 0

**Example:**

```

INST:COUP:GEN:STAT ON

```

**Manual operation:** See "[Coupling State](#)" on page 811

### 13.10.13 Configuring the application starter

The Application Starter allows you to start any external application directly from the FSW firmware, if it was added to the firmware manually in advance.

The commands for manual operation are described in [Chapter 11.3, "Application starter"](#), on page 749

<code>SYSTem:PLUGin:APPStarter:DELeTe</code> .....	1475
<code>SYSTem:PLUGin:APPStarter:DIRectory</code> .....	1475
<code>SYSTem:PLUGin:APPStarter:EXECute</code> .....	1475
<code>SYSTem:PLUGin:APPStarter:ICON</code> .....	1476
<code>SYSTem:PLUGin:APPStarter:NAME</code> .....	1476
<code>SYSTem:PLUGin:APPStarter:PARAmS</code> .....	1476
<code>SYSTem:PLUGin:APPStarter:SELect</code> .....	1477

---

### **SYSTem:PLUGin:APPStarter:DELeTe** <ApplicationGroup>, <DisplayName>

Removes the specified application from the Application Starter dialog box.

#### **Setting parameters:**

<ApplicationGroup> 'External' | 'User'

The group (tab) of applications in the Application Starter that the application belongs to.

#### **'External'**

External Applications

#### **'User'**

User Applications

<DisplayName> Name of the application in the Application Starter

**Example:** `SYSTem:PLUGin:APPStarter:DELeTe 'External', 'Notepad++'`

**Usage:** Setting only

**Manual operation:** See "[Delete Link](#)" on page 753

---

### **SYSTem:PLUGin:APPStarter:DIRectory** <WorkingDir>

Defines the working directory used by the selected application.

#### **Parameters:**

<WorkingDir>

**Example:** `SYSTem:PLUGin:APPStarter:DIRectory 'C:\TEMP'`

**Manual operation:** See "[Working Directory](#)" on page 752

---

### **SYSTem:PLUGin:APPStarter:EXECute** <ApplicationGroup>, <DisplayName>

Starts the specified application directly on the FSW.

Note that for data security reasons, executable applications cannot be added to the Application Starter remotely. Only applications added to the firmware manually in advance can be executed remotely.

#### **Setting parameters:**

<ApplicationGroup> 'External' | 'User'

The group (tab) of applications in the Application Starter that the application belongs to.

**'External'**

External Applications

**'User'**

User Applications

**<DisplayName>** Name of the application in the Application Starter**Example:** `SYSTEM:PLUGIn:APPStarter:EXECute 'External', 'Notepad++'`**Usage:** Setting only**Manual operation:** See "[Application buttons](#)" on page 750**SYSTEM:PLUGIn:APPStarter:ICON** <IconPath>, <IconIndex>

Defines an icon for the selected application to be displayed in the "Application Starter" dialog box.

**Parameters:****<IconPath>** Path and file name for icon**<IconIndex>** Position of the icon as an ordered number within the dialog box.**Example:** `SYSTEM:PLUGIn:APPStarter:ICON 'C:\Program Files (x86)\Inkscape\inkscape.exe', '0'`**Manual operation:** See "[Choose Icon](#)" on page 753**SYSTEM:PLUGIn:APPStarter:NAME** <DisplayName>

Defines the name of the application as displayed in the "Application Starter" dialog box.

**Parameters:****<DisplayName>****Example:** `SYSTEM:PLUGIn:APPStarter:NAME 'MyEditor'`**Manual operation:** See "[Display Name](#)" on page 752**SYSTEM:PLUGIn:APPStarter:PARams** <Params>

Defines parameters that are provided with the application for execution, for example arguments for a custom script.

**Parameters:****<Params>****Example:** `SYSTEM:PLUGIn:APPStarter:PARams 'D:\Scripts\freqsweep.inp'`**Manual operation:** See "[Parameters](#)" on page 752

---

**SYSTem:PLUGin:APPStarter:SElect** <ApplicationGroup>, <DisplayName>

Selects the application to be executed in subsequent commands.

The query returns the currently selected application.

**Parameters:**

<ApplicationGroup> 'External' | 'User'

The group (tab) of applications in the Application Starter that the application belongs to.

**'External'**

External Applications

**'User'**

User Applications

<DisplayName> Name of the application in the Application Starter

**Example:** SYSTem:PLUGin:APPStarter:SElect 'External',  
'Notepad++'

**Manual operation:** See ["Select"](#) on page 751  
See ["Edit Properties"](#) on page 751  
See ["Application"](#) on page 752

## 13.10.14 Programming examples for instrument setup

### 13.10.14.1 Programming example: Working with the application starter

The following programming example demonstrates how to use the remote commands for the application starter.

```
//Add the notepad application to the "External" tab of the application starter manually
//via the graphical user interface of the instrument

//Select the notepad application for further configuration
SYSTem:PLUGin:APPStarter:SElect 'External','Notepad++'
//Change the displayed name of the notepad application
SYSTem:PLUGin:APPStarter:NAME 'MyEditor'
//Add an icon to display in the dialog box
SYSTem:PLUGin:APPStarter:ICON 'C:\temp\script_icon.png','0'
//Define the working directory for the application
SYSTem:PLUGin:APPStarter:DIRectory 'C:\Scripts\'
//Define the file to open in the editor
SYSTem:PLUGin:APPStarter:PARams 'freqsweep.inp'
//Execute the application
SYSTem:PLUGin:APPStarter:EXECute 'External','MyEditor'

//*****
//Configure the default IECWIN application to execute a predefined script.
//Add the IECWIN application to the "External" tab of the application starter manually
```

```
//via the graphical user interface of the instrument
SYSTem:PLUGIn:APPStarter:SElect 'External','IECWIN'
//Define the working directory for the application
SYSTem:PLUGIn:APPStarter:DIRectory 'C:\Scripts\'
//Define the script to perform in the IECWIN application
SYSTem:PLUGIn:APPStarter:PARams 'freqsweep.inp'
//Execute the script
SYSTem:PLUGIn:APPStarter:EXECute 'External','IECWIN'
```

## 13.11 Using the status register

For more information on the contents of the status registers see:

- [Remote control via SCPI](#)
- [Chapter 12.2.2.4, "STATUS:OPERation register", on page 826](#)
- [Chapter 12.2.2.6, "STATUS:QUESTionable:ACPLimit register", on page 829](#)
- [Chapter 12.2.2.7, "STATUS:QUESTionable:EXTended register", on page 829](#)
- [Chapter 12.2.2.9, "STATUS:QUESTionable:FREQuency register", on page 830](#)
- [Chapter 12.2.2.10, "STATUS:QUESTionable:LIMit register", on page 831](#)
- [Chapter 12.2.2.11, "STATUS:QUESTionable:LMARgin register", on page 832](#)
- [Chapter 12.2.2.12, "STATUS:QUESTionable:POWEr register", on page 832](#)
- [Chapter 12.2.2.13, "STATUS:QUESTionable:TEMPerature register", on page 833](#)
- [Chapter 12.2.2.14, "STATUS:QUESTionable:TIME register", on page 834](#)
- [General status register commands..... 1478](#)
- [Reading out the CONDition part..... 1479](#)
- [Reading out the EVENt part..... 1479](#)
- [Controlling the ENABle part..... 1480](#)
- [Controlling the negative transition part..... 1480](#)
- [Controlling the positive transition part..... 1481](#)

### 13.11.1 General status register commands

<a href="#">STATus:PRESet.....</a>	1478
<a href="#">STATus:QUEue[:NEXT]?.....</a>	1479

---

#### STATus:PRESet

Resets the edge detectors and **ENABle** parts of all registers to a defined value. All **PTRansition** parts are set to **FFFFh**, i.e. all transitions from 0 to 1 are detected. All **NTRansition** parts are set to 0, i.e. a transition from 1 to 0 in a **CONDition** bit is not detected. The **ENABle** part of the **STATus:OPERation** and **STATus:QUESTionable** registers are set to 0, i.e. all events in these registers are not passed on.

**Usage:**                      Event

---

**STATus:QUEue[:NEXT]?**

Queries the most recent error queue entry and deletes it.

Positive error numbers indicate device-specific errors, negative error numbers are error messages defined by SCPI. If the error queue is empty, the error number 0, "No error", is returned.

Is identical to the `SYSTem:ERRor[:NEXT]?` command.

**Usage:** Query only

### 13.11.2 Reading out the CONDition part

---

**STATus:OPERation:CONDition?**

**STATus:QUESTionable:CONDition?**

**STATus:QUESTionable:ACPLimit:CONDition?** <ChannelName>

**STATus:QUESTionable:EXTended:CONDition?** <ChannelName>

**STATus:QUESTionable:EXTended:INFO:CONDition?** <ChannelName>

**STATus:QUESTionable:FREQuency:CONDition?** <ChannelName>

**STATus:QUESTionable:LIMit<n>:CONDition?** <ChannelName>

**STATus:QUESTionable:LMARgin<n>:CONDition?** <ChannelName>

**STATus:QUESTionable:POWer:CONDition?** <ChannelName>

**STATus:QUESTionable:TEMPerature:CONDition?** <ChannelName>

**STATus:QUESTionable:TIME:CONDition?** <ChannelName>

These commands read out the CONDition section of the status register.

The commands do not delete the contents of the CONDition section.

**Suffix:**

<n> [Window](#)

**Query parameters:**

<ChannelName> String containing the name of the channel.  
The parameter is optional. If you omit it, the command works for the currently active channel.

**Usage:** Query only

### 13.11.3 Reading out the EVENT part

---

**STATus:OPERation[:EVENT]?**

**STATus:QUESTionable[:EVENT]?**

**STATus:QUESTionable:ACPLimit[:EVENT]?** <ChannelName>

**STATus:QUESTionable:EXTended[:EVENT]?** <ChannelName>

**STATus:QUESTionable:EXTended:INFO[:EVENT]?** <ChannelName>

**STATus:QUESTionable:FREQuency[:EVENT]?** <ChannelName>

**STATus:QUESTionable:LIMit<n>[:EVENT]?** <ChannelName>

**STATus:QUESTionable:LMARgin<n>[:EVENT]?** <ChannelName>

**STATus:QUESTionable:POWer[:EVENT]?** <ChannelName>

**STATus:QUESTIONable:TEMPerature[:EVENT]? <ChannelName>**

**STATus:QUESTIONable:TIME[:EVENT]? <ChannelName>**

These commands read out the EVENT section of the status register.

At the same time, the commands delete the contents of the EVENT section.

**Suffix:**

<n> [Window](#)

**Query parameters:**

<ChannelName> String containing the name of the channel.  
The parameter is optional. If you omit it, the command works for the currently active channel.

**Usage:** Query only

### 13.11.4 Controlling the ENABLE part

**STATus:OPERation:ENABLE <SumBit>**

**STATus:QUESTIONable:ENABLE <SumBit>**

**STATus:QUESTIONable:ACPLimit:ENABLE <SumBit>,<ChannelName>**

**STATus:QUESTIONable:EXTended:ENABLE <SumBit>,<ChannelName>**

**STATus:QUESTIONable:EXTended:INFO:ENABLE <SumBit>,<ChannelName>**

**STATus:QUESTIONable:FREQUENCY:ENABLE <SumBit>,<ChannelName>**

**STATus:QUESTIONable:LIMit<n>:ENABLE <SumBit>,<ChannelName>**

**STATus:QUESTIONable:LMARgin<n>:ENABLE <SumBit>,<ChannelName>**

**STATus:QUESTIONable:POWER:ENABLE <SumBit>,<ChannelName>**

**STATus:QUESTIONable:TEMPerature:ENABLE <SumBit>,<ChannelName>**

**STATus:QUESTIONable:TIME:ENABLE <SumBit>,<ChannelName>**

These commands control the ENABLE part of a register.

The ENABLE part allows true conditions in the EVENT part of the status register to be reported in the summary bit. If a bit is 1 in the enable register and its associated event bit transitions to true, a positive transition will occur in the summary bit reported to the next higher level.

**Suffix:**

<n> [Window](#)

**Parameters:**

<SumBit> Range: 0 to 65535

<ChannelName> String containing the name of the channel.  
The parameter is optional. If you omit it, the command works for the currently active channel.

### 13.11.5 Controlling the negative transition part

**STATus:OPERation:NTRansition <SumBit>**

**STATus:QUESTIONable:NTRansition <SumBit>**



**STATus:QUESTionable:ACPLimit:NTRansition** <SumBit>,<ChannelName>  
**STATus:QUESTionable:EXTended:NTRansition** <SumBit>,<ChannelName>  
**STATus:QUESTionable:EXTended:INFO:NTRansition** <SumBit>,<ChannelName>  
**STATus:QUESTionable:FREQuency:NTRansition** <SumBit>,<ChannelName>  
**STATus:QUESTionable:LIMit<n>:NTRansition** <SumBit>,<ChannelName>  
**STATus:QUESTionable:LMARgin<n>:NTRansition** <SumBit>,<ChannelName>  
**STATus:QUESTionable:POWer:NTRansition** <SumBit>,<ChannelName>  
**STATus:QUESTionable:TEMPerature:NTRansition** <SumBit>,<ChannelName>  
**STATus:QUESTionable:TIME:NTRansition** <SumBit>,<ChannelName>

These commands control the Negative TRansition part of a register.

Setting a bit causes a 1 to 0 transition in the corresponding bit of the associated register. The transition also writes a 1 into the associated bit of the corresponding EVENT register.

**Suffix:**

<n> [Window](#)

**Parameters:**

<SumBit> Range: 0 to 65535

<ChannelName> String containing the name of the channel.  
The parameter is optional. If you omit it, the command works for the currently active channel.

### 13.11.6 Controlling the positive transition part

---

**STATus:OPERation:PTRansition** <SumBit>  
**STATus:QUESTionable:PTRansition** <SumBit>  
**STATus:QUESTionable:ACPLimit:PTRansition** <SumBit>,<ChannelName>  
**STATus:QUESTionable:EXTended:PTRansition** <SumBit>,<ChannelName>  
**STATus:QUESTionable:EXTended:INFO:PTRansition** <SumBit>,<ChannelName>  
**STATus:QUESTionable:FREQuency:PTRansition** <SumBit>,<ChannelName>  
**STATus:QUESTionable:LIMit<n>:PTRansition** <SumBit>,<ChannelName>  
**STATus:QUESTionable:LMARgin<n>:PTRansition** <SumBit>,<ChannelName>  
**STATus:QUESTionable:POWer:PTRansition** <SumBit>,<ChannelName>  
**STATus:QUESTionable:TEMPerature:PTRansition** <SumBit>,<ChannelName>  
**STATus:QUESTionable:TIME:PTRansition** <SumBit>,<ChannelName>

These commands control the Positive TRansition part of a register.

Setting a bit causes a 0 to 1 transition in the corresponding bit of the associated register. The transition also writes a 1 into the associated bit of the corresponding EVENT register.

**Suffix:**

<n> [Window](#)

**Parameters:**

<SumBit> Range: 0 to 65535

<ChannelName> String containing the name of the channel.  
The parameter is optional. If you omit it, the command works for the currently active channel.

## 13.12 Commands for remote instrument operation

The following commands are required to shutdown or reboot the FSW from a remote PC.

<a href="#">SYSTem:CLOGging</a> .....	1482
<a href="#">SYSTem:REBoot</a> .....	1482
<a href="#">SYSTem:SHUTdown</a> .....	1482

---

### SYSTem:CLOGging <State>

This command turns logging of remote commands on and off.

#### Parameters:

<State> ON | OFF | 1 | 0

#### ON | 1

Writes all remote commands that have been sent to a file.

The destination is C:\R\_S\INSTR\ScpiLogging\  
ScpiLog.<no.>.

where <no.> is a sequential number

A new log file is started each time logging was stopped and is restarted.

#### OFF | 0

\*RST: 0

**Manual operation:** See "[I/O Logging](#)" on page 856

---

### SYSTem:REBoot

This command reboots the instrument, including the operating system.

---

### SYSTem:SHUTdown

This command shuts down the instrument.

## 13.13 Recording SCPI Commands Automatically

Using the SCPI Recorder functions, you can create a SCPI script directly on the instrument and then export the script for use on the controller.

See also [Chapter 12.5, "Automating tasks with remote command scripts"](#), on page 838.

SYSTem:SREcorder[:AUTO].....	1483
SYSTem:SREcorder:CLEar.....	1483
SYSTem:SREcorder:DATA[:ALL]?.....	1483
SYSTem:SREcorder:EXPort.....	1485
SYSTem:SREcorder:FORMat.....	1486
SYSTem:SREcorder:SYNC.....	1487
CONFigure:GENerator:REcording:COMBine.....	1487

---

### SYSTem:SREcorder[:AUTO] <State>

If enabled, the SCPI Recorder automatically records the required SCPI commands and parameter values for the settings and functions you use while operating the FSW.

See [Chapter 12.5, "Automating tasks with remote command scripts"](#), on page 838.

#### Parameters:

<State>                    ON | OFF | 0 | 1

**OFF | 0**  
                            Switches the function off

**ON | 1**  
                            Switches the function on

\*RST:                    0

#### Example:

```
//Enable automatic recording
SYST:SREC:AUTO ON
//Include synchronization commands
SYST:SREC:SYNC ON
//Perform measurement task to record required commands
//...
//Display recorded commands
SYST:REC:DATA?
//Store commands to a file in python format
SYST:SREC:EXP PYTH, 'C:\TEMP\SCPI_EXAMPLE.py'
//Clear currently recorded commands
SYST:SREC:CLEAR
```

**Manual operation:** See ["Auto Recording"](#) on page 841

---

### SYSTem:SREcorder:CLEar

Removes all recorded commands from the current SCPI command list.

**Usage:**                    Event

**Manual operation:** See ["Clear All"](#) on page 843

---

### SYSTem:SREcorder:DATA[:ALL]?

Returns the currently recorded commands.

**Return values:**

<Result> string  
String containing the complete SCPI recording. Each individual command is introduced by a "#" character.

**Example:** SYST:REC:DATA?

**Usage:** Query only

**Manual operation:** See "[List of recorded commands / script editor](#)" on page 842

**Example:**

Assume the following recorded commands:

```
*RST
*CLS
:SYST:DISP:UPD ON
:INIT:CONT OFF
:INST:CRE:NEW SANALYZER, 'Spectrum 2'
:INIT:CONT OFF
:CALC:MARK:FUNC:POW:SEL ACP
```

**Result for SCPI format:**

```
#*RST
#*CLS
#:SYST:DISP:UPD ON
#:INIT:CONT OFF
#:INST:CRE:NEW SANALYZER, 'Spectrum 2'
#:INIT:CONT OFF
#:CALC:MARK:FUNC:POW:SEL ACP
```

**Result for PYTHon format:**

```
# python script created by FSW: 24:08:2022 14:05:23
#import pyvisa as visa #def write_command(instrument, command) :
# instrument.write(command)
# return process_system_error(instrument)
#def write_query(instrument, command) :
# buffer = instrument.query(command)
# bSuccess = process_system_error(instrument)
# return bSuccess, buffer #def process_system_error(instrument) :
# bSuccess = True
```

```

# EsrErrorMask = 0x3C
# if ((get_esr(instrument) & EsrErrorMask) != 0) :
# print(instrument.query(":SYST:ERR?"))
# instrument.write("*CLS")
# bSuccess = False
# return bSuccess
#def get_esr(instrument) :
# esr = instrument.query("*ESR?")
# return int(esr)
#VisaResourceManager = visa.ResourceManager()
# connect to analyzer
#Analyzer = VisaResourceManager.open_resource("TCPIP::
10.111.0.161::inst0::INSTR")
#success = write_command( Analyzer, "*RST" )
#success = write_command( Analyzer, "*CLS" )
#success = write_command( Analyzer, ":SYST:DISP:UPD ON" )
#success = write_command( Analyzer, ":INIT:CONT OFF" )
#success = write_command( Analyzer, ":INST:CRE:NEW SANALYZER,
'Spectrum 2' " )
#success = write_command( Analyzer, ":INIT:CONT OFF" )
#success = write_command( Analyzer, ":CALC:MARK:FUNC:POW:SEL
ACP" )
# back to local mode
#success = write_command(Analyzer, "@LOC")
# cleanup #Analyzer.close()
#VisaResourceManager.close()

```

---

#### **SYSTem:SREOrder:EXPort** <Format>, <FileName>

Exports the current SCPI command list to the specified file and directory in the selected format. By default, the file is stored in the C:\R\_S\INSTR\ScpiRecordings directory. Besides the recorded commands themselves, the exported script includes all format-specific header data required to execute the script using an external program on the controller.

**Parameters:**

<FileName> String containing the path and name of the file.

**Setting parameters:**

<Format> SCPI | PYTHon | MATLab | CPLusplus | CVI

**CPLusplus**

A commonly used general programming language for various applications (\*.cpp)

**MATLab (Instrument Control Toolbox)**

A programming environment, frequently used in signal processing and test and measurement applications (\*.m)

You can use this format directly with the MATLAB© Toolkit.

**CVI**

An ANSI C programming environment designed for measurements and tests (\*.cvi)

You can use this format directly with National Instruments LabWindows CVI.

**SCPI**

Represents SCPI base format, that is ASCII format, saved as a text file (\*.inp); contains no additional header data

Use this format to load a recorded script back to the editor later.

**PYTHon**

A commonly used general programming language for various applications (.py)

**Example:** SYST:SREC:EXP PYTH, 'C:\TEMP\SCPI\_EXAMPLE.py'

**Usage:** Setting only

**Manual operation:** See "[Export](#)" on page 842

**SYSTem:SRECOder:FORMat** <Format>

Defines whether the commands are recorded using the short or long SCPI notation.

**Parameters:**

<Format> SHORT | LONG

**SHORT**

The shortform of the keyword is used.

Example: FREQ:CENT

**LONG**

The entire keyword is used.

Example: FREQuency:CENTer

**Manual operation:** See "[Recording Format](#)" on page 846

**SYSTem:SRECOder:SYNC** <State>

If enabled, additional commands are included in the script to synchronize the recorded commands when necessary. For instance, when a measurement is started, a `*WAI` command is inserted to ensure that the next command is only executed after the measurement has finished.

**Parameters:**

<State>                    ON | OFF | 0 | 1  
**OFF | 0**  
 Switches the function off  
**ON | 1**  
 Switches the function on  
 \*RST:                    0

**Example:**                    SYST:SREC:SYNC ON

**Manual operation:**    See ["Add Synchronization Commands"](#) on page 846

**CONFigure:GENerator:RECOding:COMBine** <State>

Records commands both from the FSW and from a connected Rohde & Schwarz signal generator.

**Parameters:**

<State>                    ON | OFF | 0 | 1  
**OFF | 0**  
 Switches the function off  
**ON | 1**  
 Switches the function on  
 \*RST:                    0

**Example:**                    CONF:GEN:REC:COMB ON

**Manual operation:**    See ["Combined Recording of Spectrum Analyzer and R&S Signal Generator"](#) on page 847

## 13.14 Emulating other instruments' commands

The FSW analyzer family supports a subset of the GPIB commands of several HP and PSA instruments.

For details see [Chapter 12.3, "GPIB languages"](#), on page 835.

- [Setting up instrument emulation](#)..... 1488
- [Reference: GPIB commands of emulated HP models](#)..... 1491
- [Reference: command set of emulated PSA models](#)..... 1519

- [Reference: command set of emulated PXA models](#)..... 1523
- [Command set for analog demodulation for emulated PXA models](#)..... 1526
- [Command set for vector signal analysis \(VSA\) for emulated R&S FSE instruments](#)..... 1526

### 13.14.1 Setting up instrument emulation

The following commands are required to set up the use of commands to emulate other instruments.

Useful commands for emulating other instruments described elsewhere:

- [SYSTem:REVision:FACTory](#) on page 1436

#### Remote commands exclusive to emulating other instruments:

<a href="#">SYSTem:HPCoupling</a> .....	1488
<a href="#">SYSTem:IFGain:MODE</a> .....	1489
<a href="#">SYSTem:HPADditional</a> .....	1489
<a href="#">SYSTem:LANGuage</a> .....	1489
<a href="#">SYSTem:PREamp</a> .....	1490
<a href="#">SYSTem:PSA:WIDeband</a> .....	1490
<a href="#">SYSTem:REVision[:STRing]</a> .....	1491
<a href="#">SYSTem:RSWeep</a> .....	1491

---

#### **SYSTem:HPCoupling** <CouplingType>

Controls the default coupling ratios in the HP emulation mode for:

- span and resolution bandwidth (Span/RBW) and
- resolution bandwidth and video bandwidth (RBW/VBW)

For FSP (=FSW), the standard parameter coupling of the instrument is used. As a result, in most cases a shorter sweep time is used than in case of HP.

This command is only available if a HP language is selected using [SYSTem:LANGuage](#) on page 1489.

#### Parameters:

<CouplingType>      HP | FSP  
                           \*RST:      FSP

**Example:**            SYSTem:HPC HP

**Manual operation:** See "[Coupling](#)" on page 859



**SYSTem:IFGain:MODE** <Mode>

Configures the internal IF gain settings in HP emulation mode due to the application needs. This setting is only taken into account for resolution bandwidth < 300 kHz and is only available if a HP language is selected using [SYSTem:LANGuage](#) on page 1489.

**Parameters:**

<Mode>                    NORMal | PULSe

**NORMal**

Optimized for high dynamic range, overload limit is close to reference level.

**PULSe**

Optimized for pulsed signals, overload limit up to 10 dB above reference level.

\*RST:            NORM

**Example:**                SYST:IFG:MODE PULS

**Manual operation:**    See "[IF Gain](#)" on page 859

**SYSTem:HPADditional** <State>

Allows the use of HP commands *in addition to* SCPI commands for R&S FSP/FSQ/FSU emulation (see [SYSTem:LANGuage](#) on page 1489).

**Parameters:**

<State>                    ON | OFF | 1 | 0

**OFF | 0**

Switches the function off

**ON | 1**

Switches the function on

\*RST:            0

**Manual operation:**    See "[HP Additional](#)" on page 860

**SYSTem:LANGuage** <Language>

This command selects the system language.

For details see [Chapter 12.3, "GPIB languages"](#), on page 835.

**Note:** This command is also used to emulate previous R&S signal and spectrum analyzers, making the `SYST:COMP` command obsolete.

**Note:** For PSA89600 emulation, the option is indicated as "B7J" for the `*OPT?` query ("B7J, 140" if [Wideband](#) is activated).

**Note:** For R&S FSP/FSQ/FSU emulation, HP commands are not automatically also allowed. In this case, set `SYSTem:HPADditional` to ON.

**Parameters:**

<Language> "SCPI" | "8560E" | "8561E" | "8562E" | "8563E" | "8564E" |  
 "8565E" | "8566A" | "8566B" | "8568A" | "8568A\_DC" | "8568B" |  
 "8568B\_DC" | "8591E" | "8594E" | "71100C" | "71200C" |  
 "71209A" | "PSA89600" | "PSA" | "PXA" | "FSP" | "FSU" |  
 "FSQ" | "FSV" | "FSEA" | "FSEB" | "FSEM" | "FSEK"  
 \*RST: SCPI

**Example:**

```
SYST:LANG 'PSA'
```

Emulates the PSA.

**Manual operation:** See ["Language"](#) on page 858

**Note:** If you use **"PSA89600"**, you must switch to an HP language first before returning to SCPI (in remote operation only). For the identical language "PSA", this intermediate step is not necessary.

**SYSTem:PREamp** <Option>

This setting defines which option is returned when the \*OPT? query is executed, depending on the used preamplifier.

It is only available for FSU/FSQ emulation, and only if an optional preamplifier is used by the FSW.

**Parameters:**

<Option> B23 | B24  
 \*RST: B23

**Manual operation:** See ["FSU/FSQ Preamplifier"](#) on page 860

**SYSTem:PSA:WIDeband** <State>

This command defines which option is returned when the \*OPT? query is executed, depending on the state of the wideband option.

It is only available for PSA89600 emulation.

**Parameters:**

<State> ON | OFF | HIGH  
**OFF**  
 The option is indicated as "B7J"  
**ON**  
 The 40 MHz wideband is used.  
 The option is indicated as "B7J, 140".  
**HIGH**  
 The 80 MHz wideband is used.  
 The option is indicated as "B7J, 122".  
 \*RST: OFF

**Manual operation:** See ["Wideband"](#) on page 860

**SYSTem:REVision[:STRing] <Name>**

Sets the response to the `REV?` query to the defined string (HP emulation only, see [SYSTem:LANGuage](#) on page 1489).

**Parameters:**

<Name>

**Example:**

```
Define the system language:
SYST:LANG '8563E'
Query the revision:
REV?
Response:
920528
Set the response to 'NewRevision':
SYST:REV:STR 'NewRevision'
Query the response:
SYST:REV:STR?
Response:
NewRevision
```

**Manual operation:** See "[Revision String](#)" on page 860

**SYSTem:RSWEEP <State>**

Controls a repeated sweep of the E1 and MKPK HI HP model commands (for details on the commands refer to [Chapter 13.14.2, "Reference: GPIB commands of emulated HP models"](#), on page 1491). If the repeated sweep is OFF, the marker is set without sweeping before.

This command is only available if a HP language is selected using [SYSTem:LANGuage](#) on page 1489

**Parameters:**

<State>            ON | OFF | 1 | 0  
\*RST:            0

**Example:**

```
SYSTem:RSW ON
```

**Manual operation:** See "[Sweep Repeat](#)" on page 859

### 13.14.2 Reference: GPIB commands of emulated HP models

The FSW analyzer family supports a subset of the GPIB commands of HP models 8560E, 8561E, 8562E, 8563E, 8564E, 8565E, 8566A, 8566B, 8568A, 8568B and 8594E.

Despite the differences in system architecture and device features, the supported commands have been implemented in a way to ensure a sufficiently high degree of correspondence with the original.

This includes the support of syntax rules for not only newer device families (B and E models) but for the previous A family as well.

In many cases the selection of commands supported by the FSW is sufficient to run an existing GPIB program without adaptation.

After the introduction, this section includes the following topics:

- [Command set of models 8560E, 8561E, 8562E, 8563E, 8564E, 8565E, 8566A/B, 8568A/B, 8591E, 8594E, 71100C, 71200C, and 71209A](#)..... 1492
- [Special features of the syntax parsing algorithms for 8566A and 8568A models](#)..... 1515
- [Special behavior of commands](#)..... 1516
- [Model-dependent default settings](#)..... 1517
- [Data output formats](#)..... 1518
- [Trace data output formats](#)..... 1518
- [Trace data input formats](#)..... 1519
- [GPIB status reporting](#)..... 1519

### 13.14.2.1 Command set of models 8560E, 8561E, 8562E, 8563E, 8564E, 8565E, 8566A/B, 8568A/B, 8591E, 8594E, 71100C, 71200C, and 71209A

As with the original units, the FSW includes the command set of the A models in the command set of the B models.



The HP model 8591E is compatible to HP model 8594E, the HP models 71100C, 71200C, and 71209A are compatible to HP models 8566A/B.

Command	Supported subset	Function	Corresp. HP-Models	Status
A1	A1	Clear/Write A	HP 8566A/ HP 8568A	available
A2	A2	Max Hold A	HP 8566A/ HP 8568A	available
A3	A3	View A	HP 8566A/ HP 8568A	available
A4	A4	Blank A	HP 8566A/ HP 8568A	available
ABORT <sup>1)</sup>	ABORT	Stop previous function	HP 856xE/ HP 8566B/HP 8568B/HP 8594E	available
ADD		Add	HP 8566B/ HP 8568B/ HP 8594E	available
ADJALL	ADJALL	Adjust all	HP 856xE/ HP 8566B/ HP 8568B/ HP 8594E	available

## Emulating other instruments' commands

Command	Supported subset	Function	Corresp. HP-Models	Status
ADJCRT <sup>2)</sup>	ADJCRT	Adjust CRT	HP 856xE/ HP 8566B/ HP 8568B/ HP 8594E	available
ADJIF <sup>2)</sup>	ADJIF	Auto adjust IF	HP 856xE/ HP 8566B/ HP 8568B/ HP 8594E	available
AMB	AMB ON OFF AMB 1 0 AMB?	Trace A – B -> Trace A	HP 856xE/ HP 8594E	available
AMBPL	AMBPL ON OFF AMBPL 1 0 AMBPL?		HP 856xE/ HP 8566B/ HP 8568B/ HP 8594E	available
AMPCORDATA	AMPCORDATA <freq>,<amp>... AMPCORDATA?	Amplitude Correction Data	HP 856xE	available
AMPCOR	AMPCOR ON OFF AMPCOR 1 0 AMPCOR?	Amplitude Correction	HP 856xE	available
AMPCORSIZE	AMPCORSIZE?	Amplitude Correction Data Array Size	HP 856xE	available
AMPCORRCL	AMPCORRCL <numeric value>	Amplitude Correction Recall	HP 856xE	available
AMPCORSAVE	AMPCORSAVE <numeric value>	Amplitude Correction Save	HP 856xE	available
ANNOT	ANNOT ON OFF ANNOT 1 0 ANNOT?	Annotation	HP 856xE/ HP 8566B/ HP 8568B/ HP 8594E	available
APB	APB	Trace A + B -> Trace A	HP 856xE/ HP 8566B/ HP 8568B/ HP 8594E	available
AT	AT <numeric_value> DB   DM AT DN AT UP AT AUTO AT?	Attenuation	HP 8566A/ HP 8568A/ HP 856xE/ HP 8566B/ HP 8568B/ HP 8594E	available

## Emulating other instruments' commands

Command	Supported subset	Function	Corresp. HP-Models	Status
AUNITS	AUNITS DBM   DBMV   DBUV   AUNITS?	Amplitude Units	HP 856xE/ HP 8566B/ HP 8568B/ HP 8594E	available
AUTOCP	AUTOCP	Coupling default	HP 856xE/ HP 8566B/ HP 8568B/ HP 8594E	available
AXB	AXB	Exchange trace A and B	HP 856xE/ HP 8566B/ HP 8568B/ HP 8594E	available
B1	B1	Clear/Write B	HP 8566A/ HP 8568A	available
B2	B2	Max Hold B	HP 8566A/ HP 8568A	available
B3	B3	View B	HP 8566A/ HP 8568A	available
B4	B4	Blank B	HP 8566A/ HP 8568A	available
BL	BL	Trace B – Display Line -> Trace B	HP 8566A/ HP 8568A	available
BML	BML	Trace B – Display Line -> Trace B	HP 856xE/ HP8594E	available
BTC	BTC	Transfer Trace B -> C	HP 856xE/ HP 8566B/ HP 8568B/ HP 8594E	available
BXC	BXC	Exchange Trace B and C	HP 856xE/ HP 8566B/ HP 8568B/ HP 8594E	available
BLANK	BLANK TRA TRB TRC	Blank Trace	HP 856xE/ HP 8566B/ HP 8568B/ HP 8594E	available
C1	C1	A-B off	HP 8566A/ HP 8568A	available

## Emulating other instruments' commands

Command	Supported subset	Function	Corresp. HP-Models	Status
C2	C2	A-B -> A	HP 8566A/ HP 8568A	available
CA	CA	Couple Attenuation	HP 8566A/ HP 8568A	available
CAL <sup>1)</sup>	CAL ALL CAL ON CAL OFF	Start analyzer self alignment	HP 856xE/ HP 8566B/ HP 8568B/ HP 8594E	available
CF	CF <numeric_value> HZ KHZ MHZ GHZ CF UP CF DN CF?	Center Frequency	HP 8566A/ HP 8568A/ HP 856xE/ HP 8566B/ HP 8568B/ HP 8594E	available
CHANPWR	CHANPWR TRA TRB, <numeric_value>,<?>	Channel Power Measurement	HP 856xE/ HP 8594E	available
CHPWRBW	CHPWRBW <numeric_value> HZ  KHZ MHZ GHZ	Channel Power Bandwidth	HP 856xE/ HP 8594E	available
CLRW	CLRW TRA TRB TRC	Clear/Write Trace	HP 856xE/ HP 8566B/ HP 8568B/ HP 8594E	available
CLS <sup>1)</sup>	CLS	Clear all status bits	HP 856xE/ HP 8566B/ HP 8568B/ HP 8594E	available
CONTS	CONTS		HP 856xE/ HP 8566B/ HP 8568B/ HP 8594E	available
COUPLE	COUPLE AC DC	Input coupling	HP 856xE/ HP 8566B/ HP 8568B/ HP 8594E	available
CR	CR	Couple RBW	HP 8566A/ HP 8568A	available
CS	CS	Couple Step Size	HP 8566A/ HP 8568A	available

## Emulating other instruments' commands

Command	Supported subset	Function	Corresp. HP-Models	Status
CT	CT	Couple SWT	HP 8566A/ HP 8568A	available
CTA		Convert to absolute units	HP 8566B/ HP 8568B/ HP 8594E	available
CV	CV	Couple VBW	HP 8566A/ HP 8568A	available
D1 <sup>2)</sup>	D1	Display Size normal	HP 8566A/ HP 8568A	available
DA <sup>2)</sup>	DA	Display address		available
DEMODO <sup>1)</sup>	DEMODO ON OFF AM  FM	AF Demodulator	HP 856xE/ HP 8566B/ HP 8568B/ HP 8594E	available
DEMODOAGC <sup>2)</sup>	DEMODOAGC ON OFF 1  0 DEMODOAGC?	Demodulation AGC	HP 856xE/ HP 8566B/ HP 8568B/ HP 8594E	available
DEMODT	DEMODT <numeric_value> S MS  US SC DEMODT UP DN DEMODT?	Demodulation time	HP 856xE/ HP 8566B/ HP 8568B/ HP 8594E	available
DET	DET POS SMP NEG DET?	Detector	HP 856xE/ HP 8566B/ HP 8568B/ HP 8594E	available
DISPOSE <sup>2)</sup>	ONEOS   TRMATH   ONSWP   ALL   <numeric_value>			available
DIV		Divide	HP 8566B/ HP 8568B/ HP 8594E	available
DL	DL <numeric_value> DB DM DL DN DL UP DL ON DL OFF DL?	Display Line	HP 856xE/ HP 8566B/ HP 8568B/ HP 8594E	available



## Emulating other instruments' commands

Command	Supported subset	Function	Corresp. HP-Models	Status
DLE	DLE ON OFF	Display Line enable	HP 856xE/ HP 8566B/ HP 8568B/ HP 8594E	available
DONE	DONE DONE?	Done query	HP 856xE/ HP 8566B/ HP 8568B/ HP 8594E	available
DW <sup>2)</sup>	DW	Write to display and increment address		available
E1	E1	Peak Search	HP 8566A/ HP 8568A	available
E2	E2	Marker to Center Freq.	HP 8566A/ HP 8568A	available
E3	E3	Deltamarker Step Size	HP 8566A/ HP 8568A	available
E4	E4	Marker to Ref. Level	available	available
EDITDONE		limit line edit done	HP 856xE	available
EDITLIML		edit limit line	HP 856xE	available
ERR	ERR 250 cal level error ERR 300 LO unlock ERR 472 cal error digital filter ERR 473 cal error analog filter ERR 552 cal error log amp ERR 902 unscale tracking generator ERR 906 oven cold ERR 117 numeric unit error ERR 112 Unrecognized Command	Now some FSx errors are mapped to HP errors.	HP8568A HP856xE	not yet available
ERR?	ERR?	Error queue query	HP 856xE/ HP 8566B/ HP 8568B/ HP 8594E	not yet available
EX	EX	Exchange trace A and B	HP 8566A/ HP 8568A	available

## Emulating other instruments' commands

Command	Supported subset	Function	Corresp. HP-Models	Status
FA	FA <numeric_value> HZ  KHZ MHZ GHZ FA UP FA DN FA?	Start Frequency	HP 8566A/ HP 8568A/ HP 856xE/ HP 8566B/ HP 8568B/ HP 8594E	available
FB	FB <numeric_value> HZ  KHZ MHZ GHZ FB UP FB DN FB?	Stop Frequency	HP 8566A/ HP 8568A/ HP 856xE/ HP 8566B/ HP 8568B/ HP 8594E	available
FDSP		Frequency display off	8560E 8561E 8562E 8563E 8564E 8565E	available
FOFFSET <sup>1)</sup>	FOFFSET <numeric_value> HZ  KHZ MHZ GHZ FOFFSET?	Frequency Offset	HP 856xE/ HP 8566B/ HP 8568B/ HP 8594E	available
FREF	FREF INT EXT	Reference Frequency	HP 856xE/ HP 8566B/ HP 8568B/ HP 8594E	available
FS	FS	Full Span	HP 8566A/ HP 8568A	available
FUNCDEF		Define Function Function must be in one line between delimiters @	HP 8594E/ HP 856xE/ HP 8566B	available
GATE <sup>1)</sup>	GATE ON OFF GATE 1 0		HP 856xE/ HP 8566B/ HP 8568B/ HP 8594E	available
GATECTL <sup>1)</sup>	GATECTL EDGE LEVEL GATECTL?		HP 856xE/ HP 8566B/ HP 8568B/ HP 8594E	available

## Emulating other instruments' commands

Command	Supported subset	Function	Corresp. HP-Models	Status
GD <sup>1)</sup>	GD <numeric_value> US MS SC GD DN GD UP GD?		HP 856xE/ HP 8566B/ HP 8568B/ HP 8594E	available
GL <sup>1)</sup>	GL <numeric_value> US MS SC GL DN GL UP GL?		HP 856xE/ HP 8566B/ HP 8568B/ HP 8594E	available
GP <sup>1)</sup>	GP POS NEG GP?		HP 856xE/ HP 8566B/ HP 8568B/ HP 8594E	available
GRAT <sup>2)</sup>	GRAT ON OFF	Graticule	HP 856xE/ HP 8566B/ HP 8568B/ HP 8594E	available
I1	I1		HP 8566A/ HP 8568A	available
I2	I2		HP 8566A/ HP 8568A	available
ID	ID ID?	Identify	HP 8566A/ HP 8568A/ HP 856xE/ HP 8566B/ HP 8568B/ HP 8594E	available
INZ <sup>1)</sup>	INZ 75 INZ 50 INZ?	Input Impedance	HP 856xE/ HP 8566B/ HP 8568B/ HP 8594E	available
IP	IP	Instrument preset	HP 8566A/ HP 8568A	available
KEYDEF	KEYDEF	Key definition	HP 8566B/ HP 856xE/ HP 859xE	available
KEYEXEC	KEYEXEC	Key execute	HP 8566B	available

## Emulating other instruments' commands

Command	Supported subset	Function	Corresp. HP-Models	Status
KS=	KS= <numeric_value> HZ KHZ MHZ GHZ KS= DN KS= UP KS=?	Marker Frequency Counter Resolution	HP 8566A/ HP 8568A	available
KS/	KS/	Manual Peaking	HP 8566A/ HP 8568A	available
KS(	KS(	Lock register	HP 8566A/ HP 8568A	available
KS)	KS)	Unlock register	HP 8566A/ HP 8568A	available
KS91	KS91	Read Amplitude Error	HP 8566A/ HP 8568A	available
KSA	KSA	Amplitude Units in dBm	HP 8566A/ HP 8568A	available
KSB	KSB	Amplitude Units in dBmV	HP 8566A/ HP 8568A	available
KSC	KSC	Amplitude Units in dBuV	HP 8566A/ HP 8568A	available
KSD	KSD	Amplitude Units in V	HP 8566A/ HP 8568A	available
KSE	KSE <numeric_value>  <char data>@	Title mode	HP 8566A/ HP 8568A	available
KSG	KSG KSG ON KSG <numeric_value>	Video Averaging on	HP 8566A/ HP 8568A	available
KSH	KSH	Video Averaging Off	HP 8566A/ HP 8568A	available
KSK		Marker to Next Peak	HP 8566A/ HP 8568A	available
KSL		Marker Noise off	HP 8566A/ HP 8568A	available
KSM		Marker Noise on	HP 8566A/ HP 8568A	available
KSO	KSO	Deltamarker to span	HP 8566A/ HP 8568A	available
KSP	KSP <numeric_value>	HPIB address	HP 8566A/ HP 8568A	available

## Emulating other instruments' commands

Command	Supported subset	Function	Corresp. HP-Models	Status
KSQ <sup>2)</sup>	KSQ	Band lock off	HP 8566A/ HP 8568A	available
KST	KST	Fast Preset	HP 8566A/ HP 8568A	available
KSV	KSV <numeric_value> HZ KHZ MHZ GHZ KSV?	Frequency Offset	HP 8566A/ HP 8568A	available
KSW	KSW	Error Correction Routine	HP 8566A/ HP 8568A	available
KSX	KSX	Correction Values On	HP 8566A/ HP 8568A	available
KSY	KSY	Correction Values Off	HP 8566A/ HP 8568A	available
KSZ	KSZ <numeric_value> DB KSZ?	Reference Value Offset	HP 8566A/ HP 8568A	available
KSa	KSa	Normal Detection	HP 8566A/ HP 8568A	available
KSb	KSb	Pos Peak Detection	HP 8566A/ HP 8568A	available
KSd	KSd	Neg Peak Detection	HP 8566A/ HP 8568A	available
KSe	KSe	Sample Detection	HP 8566A/ HP 8568A	available
KSg		CRT beam off		available
KSh		CRT beam on		available
KSj	KSj	View Trace C	HP 8566A/ HP 8568A	available
KSk	KSk	Blank Trace C	HP 8566A/ HP 8568A	available
KSl	KSl	Transfer B to C	HP 8566A/ HP 8568A	available
KSm	KSm	Graticule off	HP 8566A/ HP 8568A	available
KSn <sup>2)</sup>	KSn	Grid on	HP 8566A/ HP 8568A	available
KSo	KSn	Character display off	HP 8566A/ HP 8568A	available

## Emulating other instruments' commands

Command	Supported subset	Function	Corresp. HP-Models	Status
KSp	KSp	Character display on	HP 8566A/ HP 8568A	available
KSr	KSr	Create service request	HP 8566A/ HP 8568A	available
KSt <sup>2)</sup>	KSt	Band lock on	HP 8566A/ HP 8568A	available
KSv <sup>2)</sup>	KSv	Signal ident on	HP 8566A/ HP 8568A	available
L0	L0	Display line off	HP 8566A/ HP 8568A	available
LB	LB <numeric_value>  <char data>@	Label	HP 8566A/ HP 8568A	available
LF	LF	Low frequency band pre- set	HP 8566A/ HP 8568A	available
LIMD		limit line delta	HP 856xE	available
LIMF		limit line frequency	HP 856xE	available
LIMIFAIL		limit fail query	HP 856xE	available
LIMIPURGE		purge limit line	HP 856xE	available
LIMIRCL		recall limit line	HP 856xE	available
LIMIREL		relative limit line	HP 856xE	available
LIMISAV		save limit line	HP 856xE	available
LIMITEST		limit line test	HP 856xE	available
LIML		lower limit line value	HP 856xE	available
LIMM		middle limit line value	HP 856xE	available
LIMTFL		flat limit line segment	HP 856xE	available
LIMTSL		slope limit line segment	HP 856xE	available
LIMU		upper limit line value	HP 856xE	available
LG	LG <numeric_value> DB   DM LG?	Amplitude Scale Log	HP 856xE/ HP 8566B/ HP 8568B/ HP 8594E	available
LL <sup>2)</sup>	LL	Plot command	HP 8566A/ HP 8568A	available

## Emulating other instruments' commands

Command	Supported subset	Function	Corresp. HP-Models	Status
LN	LN	Amplitude Scale Lin	HP 856xE/ HP 8566B/ HP 8568B/ HP 8594E	available
M1	M1	Marker Off	HP 8566A/ HP 8568A	available
M2	M2 M2 <numeric_value> HZ KHZ MHZ GHZ M2 DN M2 UP M2?	Marker Normal	HP 8566A/ HP 8568A	available
M3	M3 M3 <numeric_value> HZ KHZ MHZ GHZ M3 DN M3 UP M3?	Delta Marker	HP 8566A/ HP 8568A	available
M4	M4 <numeric_value> HZ KHZ MHZ GHZ	Marker Zoom	HP 8566A/ HP 8568A	available
MA	MA	Marker Amplitude	HP 8566A/ HP 8568A	available
MC0	MC0	Marker Count off	HP 8566A/ HP 8568A	available
MC1	MC1	Marker Count on	HP 8566A/ HP 8568A	available
MDS	MDS	Measurement data size	HP 8566B	available
MEAS		Measurement status	HP 856xE	available
MF	MF MF?	Marker Frequency	HP 8566A/ HP 8568A/ HP 856xE/ HP 8566B/ HP 8568B/ HP 8594E	available
MINH <sup>1)</sup>	MINH TRC	Minimum Hold	HP 856xE/ HP 8566B/ HP 8568B/ HP 8594E	available

## Emulating other instruments' commands

Command	Supported subset	Function	Corresp. HP-Models	Status
MKA	MKA <numeric_value> MKA?	Marker Amplitude	HP 856xE/ HP 8566B/ HP 8568B/ HP 8594E	available
MKACT	MKACT 1 MKACT?	Select the active marker	HP 856xE/ HP 8566B/ HP 8568B/ HP 8594E	not available
MKBW <sup>1)</sup>	MKBW <numeric_value> MKBW ON MKBW OFF	N dB Down	HP 856xE/ HP 8566B/ HP 8568B/ HP 8594E	available
MKD	MKD MKD <numeric_value> HZ KHZ  MHZ GHZ MKD DN MKD UP MKD ON MKD OFF MKD?	Delta Marker	HP 856xE/ HP 8566B/ HP 8568B/ HP 8594E	available
MKDR	MKDR <numeric_value> HZ KHZ  MHZ GHZ  S SC MS MSEC  USMKDR?	Delta Marker reverse	HP 856xE/ HP 8566B/ HP 8568B/ HP 8594E	available
MKDR?		Delta Marker reverse query		available
MKF	MKF <numeric_value> HZ KHZ MHZ GHZ MKF?	Set Marker Frequency	HP 856xE/ HP 8566B/ HP 8568B/ HP 8594E	available
MKFC	MKFC ON OFF	Frequency Counter on/off	HP 856xE/ HP 8566B/ HP 8568B/ HP 8594E	available



## Emulating other instruments' commands

Command	Supported subset	Function	Corresp. HP-Models	Status
MKFCR <sup>1)</sup>	MKFCR <numeric_value> HZ KHZ MHZ GHZ MKFCR DN MKFCR UP MKFCR?	Frequency Counter Resolution	HP 856xE/ HP 8566B/ HP 8568B/ HP 8594E	available
MKMIN	MKMIN	Marker -> Min	HP 856xE/ HP 8566B/ HP 8568B/ HP 8594E	available
MKN	MKN MKN <numeric_value> HZ KHZ MHZ GHZ MKN DN MKN UP MKN ON MKN OFF MKN?	Normal Marker	HP 856xE/ HP 8566B/ HP 8568B/ HP 8594E	available
MKNOISE	MKNOISE ON OFF MKNOISE 1 0 MKNOISE?	Noise Measurement	HP 856xE/ HP 8566B/ HP 8568B/ HP 8594E	available
MKOFF	MKOFF MKOFF ALL	Marker off	HP 856xE/ HP 8566B/ HP 8568B/ HP 8594E	available
MKP	MKP <numeric_value> MKP?	Marker position	HP 856xE/ HP 8566B/ HP 8568B/ HP 8594E	available
MKPK	MKPK MKPK HI MKPK NH MKPK NR MKPK NL	Marker Search	HP 856xE/ HP 8566B/ HP 8568B/ HP 8594E	available
MKPT	MKPT MKPT HI MKPT NH MKPT NR MKPT NL	Marker Peak Threshold	HP 856xE/ HP 8566B/ HP 8568B/ HP 8594E	available

## Emulating other instruments' commands

Command	Supported subset	Function	Corresp. HP-Models	Status
MKPX	MKPX <numeric_value> DB MKPX DN MKPX UP MKPX?	Peak Excursion	HP 856xE/ HP 8566B/ HP 8568B/ HP 8594E	available
MKRL	MKRL	Ref Level = Marker Level	HP 856xE/ HP 8566B/ HP 8568B/ HP 8594E	available
MKSP	MKSP	Deltamarker to span	HP 856xE/ HP 8566B/ HP 8568B/ HP 8594E	available
MKSS	MKSS	CF Stepsize = Marker Freq	HP 856xE/ HP 8566B/ HP 8568B/ HP 8594E	available
MKT	MKT <numeric_value> S MS US SC MKT?	MKF = fstart + MKT/ SWT*Span	HP 856xE/ HP 8594E	available
MKTRACE	MKTRACE TRA TRB  TRC	Marker to Trace	HP 856xE/ HP 8566B/ HP 8568B/ HP 8594E	available
MKTRACK	MKTRACK ON OFF MKTRACK 1 0 MKTRACK?	Signal Track	HP 856xE/ HP 8566B/ HP 8568B/ HP 8594E	available
MKTYPE	MKTYPE AMP MK TYPE?	Marker type	HP 856xE/ HP 8566B/ HP 8568B/ HP 8594E	available
ML		Mixer level	HP 856xE	available
MOV	MOV TRA TRB TRC, TRA TRB TRC	Move Trace Contents	HP 856xE/ HP 8566B/ HP 8568B/ HP 8594E	available
MPY		Multiply	HP 8566B/ HP 8568B/ HP 8594E	available

## Emulating other instruments' commands

Command	Supported subset	Function	Corresp. HP-Models	Status
MT0	MT0	Marker Track Off	HP 8566A/ HP 8568A	available
MT1	MT1	Marker Track On	HP 8566A/ HP 8568A	available
MXMH	MXMH TRA TRB	Maximum Hold	HP 856xE/ HP 8566B/ HP 8568B/ HP 8594E	available
NORMALIZE	NORMALIZE	Normalize trace	HP 856xE/ HP 8566B/ HP 8568B/ HP 8594E	not available available
NRL <sup>1)</sup>	NRL <numeric_value> DB   DM NRL?	Normalized Reference Level	HP 856xE/ HP 8566B/ HP 8568B/ HP 8594E	available
NRPOS	NRPOS <numeric_value> NRL?	Normalize position	HP 856xE/ HP 8566B/ HP 8568B/ HP 8594E	available
O1	O1	Format ASCII, Values 0 to 4095	HP 8566A/ HP 8568A	available
O2	O2	Format Binary, Values 0 to 4095	HP 8566A/ HP 8568A	available
O3	O3	Format ASCII	HP 8566A/ HP 8568A	available
OA	OA	Output All	HP 8566A/ HP 8568A	available
OL	OL <80 characters> OL?	Output Learn String	HP 8566A/ HP 8568A	available
OT	OT	Output Trace Annotations	HP 8566A/ HP 8568A	available
PA	PA <numeric_value>, <numeric_value	Plot command	HP 8566A/ HP 8568A	available
PD	PD <numeric_value>, <numeric_value	Plot command	HP 8566A/ HP 8568A	available
PH_MKF		Spot frequency in Hz	HP 856xE	available
PH_FMIN		Min offset frequency to be measured	HP 856xE	available

## Emulating other instruments' commands

Command	Supported subset	Function	Corresp. HP-Models	Status
PH_FMAX		Max offset frequency to be measured	HP 856xE	available
PH_MKA		Queries amplitude at the spot frequency	HP 856xE	available
PH_DRIFT		0: for stable signals, 1: for drifty	HP 856xE	available
PH_RLVL		Reference level for the log plot	HP 856xE	available
PH_SMTHV		Trace smoothing	HP 856xE	available
PH_VBR		Filtering	HP 856xE	available
PH_RMSPT		Amount of data points to skip when doing the integration	HP 856xE	available
PH_RMSFL		Lower integration frequency in Hz	HP 856xE	available
PH_RMSFU		Upper integration frequency in Hz	HP 856xE	available
PH_EXIT		Quits phase noise	HP 856xE	available
PH_F_UDT		Updates internal frequency variables	HP 856xE	available
PH_LMT_L		Apply limits to PH_FMIN and PH_FMAX	HP 856xE	available
PH_MEAS		Generates log frequency plot	HP 856xE	available
PH_MKF_D		Updates the spot frequency	HP 856xE	available
PH_RMS		Requests the rms phase noise	HP 856xE	available
PH_RMSFT		Updates internal frequency variables	HP 856xE	available
PH_RMSX		Calculates the rms phase noise	HP 856xE	available
PH_SPOTF		Executes the spot frequency measurement	HP 856xE	available
PLOTORG <sup>2)</sup>	PLOTORG DSP GRT	Plot command	HP 856xE/ HP 8566B/ HP 8568B/ HP 8594E	available
PLOTSRC <sup>2)</sup>	PLOTSRC ANNT GRT  TRB  TRA ALLDSP GRT	Plot command	HP 856xE/ HP 8566B/ HP 8568B/ HP 8594E	available

## Emulating other instruments' commands

Command	Supported subset	Function	Corresp. HP-Models	Status
PP	PP	Preselector Peaking	HP 8566A/ HP 8568A	available
PRINT <sup>1)</sup>	PRINT PRINT 1 0	Hardcopy	HP 856xE/ HP 8566B/ HP 8568B/ HP 8594E	available
PSDAC <sup>2)</sup>	PSDAC <numeric_value> PSDAC UP DN	Preselector DAC value	HP 856xE/ HP 8566B/ HP 8568B/ HP 8594E	available
PSTATE <sup>2)</sup>	PSTATE ON OFF 1 0	Protect State	HP 856xE/ HP 8566B/ HP 8568B/ HP 8594E	available
PU	PU	Pen Up	HP 8566A/ HP 8568A	available
PWRBW	PWRBW	Power Bandwidth	HP 8566B/ HP 859x/ HP 856xE	available
R1	R1	Set Status Bit Enable	HP 8566A/ HP 8568A	available
R2	R2	Set Status Bit Enable	HP 8566A/ HP 8568A	available
R3	R3	Set Status Bit Enable	HP 8566A/ HP 8568A	available
R4	R4	Set Status Bit Enable	HP 8566A/ HP 8568A	available
RB	RB <numeric_value> HZ KHZ MHZ GHZ RB DN RB UP RB AUTO RB?	Resolution Bandwidth	HP 856xE/ HP 8566B/ HP 8568B/ HP 8594E	available
RBR	RBR <numeric_value> RBR DN RBR UP RBR?	Resolution Bandwidth Ratio	HP 856xE/ HP 8566B/ HP 8568B/ HP 8594E	available
RC1...6	RC1...6	Recall Last State	HP 8566A/ HP 8568A	available

## Emulating other instruments' commands

Command	Supported subset	Function	Corresp. HP-Models	Status
RCLS	RCLS <numeric_value>	Recall State Register	HP 856xE/ HP 8566B/ HP 8568B/ HP 8594E	available
RCLT	RCLT TRA TRB, <number>	Recall Trace	HP856xE/ HP8594E	available
RESET	RESET	Instrument preset	HP 856xE/ HP 8566B/ HP 8568B/ HP 8594E	available
REV	REV REV?	Firmware revision	HP 856xE/ HP 8566B/ HP 8568B/ HP 8594E	available
RL	RL <numeric_value> DB DM RL DN RL UP RL?	Reference Level	HP 856xE/ HP 8566B/ HP 8568B/ HP 8594E	available
RLCAL	RLCAL <numeric_value> RL?	Reference Level Calibration	HP 856xE/ HP 8566B/ HP 8568B/ HP 8594E	available
RCLOSCAL	RCLOSCAL	Recall Open/Short Average	HP 856xE/ HP 8594E	not available
RCLTHRU	RCLTHRU	Recall Thru	HP 856xE/ HP 8594E	not available
RLPOS <sup>1)</sup>	RLPOS <numeric_value> RLPOS DN RLPOS UP RLPOS?	Reference Level Position	HP 856xE/ HP 8566B/ HP 8568B/ HP 8594E	available
ROFFSET	ROFFSET <numeric_value> DB   DM ROFFSET?	Reference Level Offset	HP 856xE/ HP 8566B/ HP 8568B/ HP 8594E	available
RQS	RQS	Service Request Bit mask	HP 856xE/ HP 8566B/ HP 8568B/ HP 8594E	available

## Emulating other instruments' commands

Command	Supported subset	Function	Corresp. HP-Models	Status
S1	S1	Continuous Sweep	HP 8566A/ HP 8568A	available
S2	S2	Single Sweep	HP 8566A/ HP 8568A	available
SADD		add a limit line segment	HP 856xE	available
SAVES	SAVES <numeric_value>	Save State Register	HP 856xE/ HP 8566B/ HP 8568B/ HP 8594E	available
SAVET	SAVET TRA TRB,<num- ber>	Save Trace	HP856xE/ HP8594E	available
SDEL		delete limit line segment	HP 856xE	available
SDON		limit line segment done	HP 856xE	available
SEDI		edit limit line segment	HP 856xE	available
SMOOTH	SMOOTH TRA TRB  TRC, <number of points>	Smooth Trace	HP 856xE/ HP 8566B/ HP 8568B/ HP 8594E	available
SNGLS	SNGLS	Single Sweep	HP 856xE/ HP 8566B/ HP 8568B/ HP 8594E	available
SQUELCH <sup>2)</sup>	SQUELCH <numeric_value> DM   DB SQUELCH UP DN SQUELCH ON OFF	Squelch	HP 856xE/ HP 8566B/ HP 8568B/ HP 8594E	available
SP	SP <numeric_value> HZ KHZ MHZ GHZ SP DN SP UP SP?	Span	HP 8566A/ HP 8568A/ HP 856xE/ HP 8566B/ HP 8568B/ HP 8594E	available
SRCNORM <sup>1)</sup>	SRCNORM ON OFF SRCNORM 1 0	Source Normalization	HP 856xE/ HP 8566B/ HP 8568B/ HP 8594E	not available

## Emulating other instruments' commands

Command	Supported subset	Function	Corresp. HP-Models	Status
SRCPOFS <sup>1)</sup>	SRCPOFS <numeric_value> DB   DM SRCPOFS DN SRCPOFS UP SRCPOFS?	Source Power Offset	HP 856xE/ HP 8566B/ HP 8568B/ HP 8594E	not available
SRCPWR <sup>1)</sup>	SRCPWR <numeric_value> DB   DM SRCPWR DN SRCPWR UP SRCPWR ON SRCPWR OFF SRCPWR?	Source Power	HP 856xE/ HP 8566B/ HP 8568B/ HP 8594E	not available
SS	SS <numeric_value> HZ KHZ MHZ GHZ SS DN SS UP SS AUTO SS?	CF Step Size	HP 8566A/ HP 8568A/ HP 856xE/ HP 8566B/ HP 8568B/ HP 8594E	available
ST	ST <numeric_value> US MS SC ST DN ST UP ST AUTO ST?	Sweep Time	HP 8566A/ HP 8568A/ HP 856xE/ HP 8566B/ HP 8568B/ HP 8594E	available
STB	STB	Status byte query	HP 856xE/ HP 8566B/ HP 8568B/ HP 8594E	available
STOREOPEN	STOREOPEN	Store Open	HP 856xE/ HP 8594E	not available
STORESHORT	STORESHORT	Store Short	HP 856xE/ HP 8594E	not available
STORETHRU	STORETHRU	Store Thru	HP 856xE/ HP 8594E	not available
SUB		Subtract	HP 8566B/ HP 8568B/ HP 8594E	available



## Emulating other instruments' commands

Command	Supported subset	Function	Corresp. HP-Models	Status
SUM		sum of trace amplitudes	HP 8566B/ HP 8568B/ HP 8594E	available
SV1...6	SV1...6	Save State	HP 8566A/ HP 8568A	available
SWPCPL <sup>2)</sup>	SWPCPL SA   SR SWPCPL?	Sweep Couple	HP 856xE/ HP 8566B/ HP 8568B/ HP 8594E	available
SWPOUT <sup>2)</sup>	SWPOUT FAV FAVA  RAMP SWPOUT?	Sweep Output	HP 856xE/ HP 8566B/ HP 8568B/ HP 8594E	available
T0	T0	Threshold off	HP 8566A/ HP 8568A	available
T1	T1	Free Run Trigger	HP 8566A/ HP 8568A	available
T2 <sup>2)</sup>	T2	Line Trigger	HP 8566A/ HP 8568A	available
T3	T3	External Trigger	HP 8566A/ HP 8568A	available
T4	T4	Video Trigger	HP 8566A/ HP 8568A	available
TA	TA	Transfer A	HP 8566A/ HP 8568A	available
TACL	TACL?	Returns instantaneous measurement results. See TRACE<trace #>:IMMEDIATE:LEVEL? for full description.		not available
TBCL	TBCL?			
TCCL	TCCL?			
TACR	TACR?	Returns instantaneous measurement results. See TRACE<trace #>:IMMEDIATE:LEVEL? for full description.		not available
TBCR	TBCR?			
TCCR	TCCR?			

## Emulating other instruments' commands

Command	Supported subset	Function	Corresp. HP-Models	Status
TB	TB	Transfer B	HP 8566A/ HP 8568A	available
TDF	TDF P TDF M TDF B TDF A TDF I	Trace Data Format	HP 856xE/ HP 8566B/ HP 8568B/ HP 8594E	available
TH	TH <numeric_value> DB DM TH DN TH UP TH ON TH OFF TH AUTO TH?	Threshold	HP 856xE/ HP 8566B/ HP 8568B/ HP 8594E	available
THE	THE ON  OFF	Threshold Line enable	HP 856xE/ HP 8566B/ HP 8568B/ HP 8594E	available
TIMEDSP <sup>1)</sup>	TIMEDSP ON OFF TIMEDSP 1 0 TIMEDSP?	Time Display	HP 856xE/ HP 8566B/ HP 8568B/ HP 8594E	available
TM	TM FREE VID EXT  LINE <sup>2)</sup> TM?	Trigger Mode	HP 856xE/ HP 8566B/ HP 8568B/ HP 8594E	available
TM LINE <sup>2)</sup>	TM LINE	Trigger Line	HP 8566B	available
TRA	TRA B TRA A TRA I	Transfer A	HP 856xE/ HP 8566B/ HP 8568B/ HP 8594E	available
TRB	TRB B TRB A TRB I	Transfer B	HP 856xE/ HP 8566B/ HP 8568B/ HP 8594E	available
TRSTAT	TRSTAT?	Trace State Query	HP 856xE/ HP 8566B/ HP 8568B/ HP 8594E	available

## Emulating other instruments' commands

Command	Supported subset	Function	Corresp. HP-Models	Status
TS	TS	Take Sweep	HP 856xE/ HP 8566B/ HP 8568B/ HP 8594E	available
UR <sup>2)</sup>	UR	Plot Command	HP 8566A/ HP 8568A	available
VARDEF	VARDEF	Variable definition, arrays are not supported	HP 8566B/ HP 8568B/ HP 8594E	available
VAVG	VAVG VAVG TRA TRB TRC	Video Averaging	HP 856xE/ HP 8566B/ HP 8568B/ HP 8594E	available
VB	VB <numeric_value> HZ KHZ MHZ GHZ VB DN VB UP VB AUTO VB?	Video Bandwidth	HP 856xE/ HP 8566B/ HP 8568B/ HP 8594E	available
VBR <sup>1)</sup>	VBR <numeric_value> VBR DN VBR UP VBR?	Video Bandwidth Ratio	HP 856xE/ HP 8566B/ HP 8568B/ HP 8594E	available
VIEW	VIEW TRA TRB TRC		HP 856xE/ HP 8566B/ HP 8568B/ HP 8594E	available
VTL	VTL <numeric_value> DB DM VTL DN VTL UP VTL?	Video Trigger Level	HP 856xE/ HP 8594E	not available
1) HP 8594E only				
2) Command is accepted without error message, but is ignored				

### 13.14.2.2 Special features of the syntax parsing algorithms for 8566A and 8568A models

The command syntax is very different for models A and B. Different names are assigned to identical instrument functions, and the command structure likewise differs considerably between models A and models B.

The command structure for models A is as follows:

```
<command> ::= <command
code> [<SPC>] [<data> | <step>] [<SPC>] [<delimiter>] [<command
code>] ... <delimiter>
```

```
<data> ::= <Value> [<SPC>] [<units
code>] [<SPC>] [<delimiter>] [<SPC>] [<data>] ...
```

```
<step> ::= UP | DN
```

where

<command code> = see Table "Supported Commands"

<Value> = integer or floating-point numerical value

<units code> = DM | -DM | DB | HZ | KZ | MZ | GZ | MV | UV | SC | MS | US

<delimiter> = <CR> | <LF> | <, > | <; > | <ETX>

<SPC> = 32<sub>10</sub>

<ETX> = 3<sub>10</sub>

Command sections given in [ ] are optional.

The FSW GPIB hardware differs from that used in the HP analyzers. Therefore, the following constraint exists:

<LF> | <EOI> are still used as delimiters since the GPIB hardware is able to identify them. The other delimiters are identified and evaluated during syntax analysis.

### 13.14.2.3 Special behavior of commands

Command	Known Differences
ABORT	Does not automatically set the command complete bit (bit 4) in the status byte. An additional DONE is required for that purpose.
ANNOT	Only frequency axis annotation is affected.
AT	AT DN/UP: Step size
CAL	The CAL commands do not automatically set the command complete bit (bit 4) in the status byte. An additional DONE command is required for that purpose.
CF	Default value, range, step size
CR	Default ratio Span/RBW
CT	Formula for coupled sweep time
CV	Default ratio RBW/VBW
DET	DET? returns SAMP instead of SMP on the FSW. DET not automatically set the command complete bit (bit 4) in the status byte. An additional DONE is required for that purpose.
ERR?	Deletes the error bit in the status register but always returns a '0' in response.

Command	Known Differences
FA	Default value, range, step size
FB	Default value, range, step size
ID	Query of instrument ID. The instrument ID defined in "SETUP > Network + Remote > GPIB > Identification String" is returned.
M2	Default value, range, step size
M3	Default value, range, step size
MKACT	Only marker 1 is supported as the active marker.
MKBW	Default value
MKPT	Step size
MKPX	Step size
OL?	Storage of instrument settings: 80 characters are returned as information on the instrument settings. The contents of the 80 characters returned does not correspond to the original data contents of the 8566A/8568A family.
OL	Readout of instrument settings: The 80 characters read by means of OL? are accepted as information on the corresponding instrument settings. The contents of the 80 characters read does not correspond to the original data contents of the 8566A/8568A family.
RB	Default value, range, step size
RL	Default value, step size
RLPOS	Adapts the position of the reference level even if the tracking generator normalization is not active.
RQS	Supported bits: 1 (Units key pressed) 2 (End of Sweep) 3 (Device error) 4 (Command complete) 5 (Illegal command)

#### 13.14.2.4 Model-dependent default settings

If the GPIB language is switched over to an 85xx model, the GPIB address is automatically switched over to 18 provided that the default address of the FSW (20) is still set. If a different value is set, this value is maintained. Upon return to SCPI, this address remains unchanged.

The following table shows the default settings obtained after a change of the GPIB language and for the commands IP, KST and RESET:

Model	# of Trace Points	Start Freq.	Stop Freq.	Ref Level	Input Coupling
8566A/B	1001	2 GHz	22 GHz	0 dBm	AC
8568A/B	1001	0 Hz	1.5 GHz	0 dBm	AC
8560E	601	0 Hz	2.9 GHz	0 dBm	AC
8561E	601	0 Hz	6.5 GHz	0 dBm	AC
8562E	601	0 Hz	13.2 GHz	0 dBm	AC
8563E	601	0 Hz	26.5 GHz	0 dBm	AC
8564E	601	0 Hz	40 GHz	0 dBm	AC
8565E	601	0 Hz	50 GHz	0 dBm	AC
8594E	401	0 Hz	3 GHz	0 dBm	AC



### Stop frequency

The stop frequency given in the table may be limited to the corresponding frequency range of the FSW.

Command LF sets the stop frequency for 8566A/B to a maximum value of 2 GHz.

### Test points (trace points)

The number of trace points is switched over only upon transition to the REMOTE state.

#### 13.14.2.5 Data output formats

In the case of the SCPI and IEEE488.2 standards, the output formats for numerical data are flexible to a large extent. The output format for the HP units, by contrast, is accurately defined with respect to the number of digits. The memory areas for reading instrument data have therefore been adapted accordingly in the remote-control programs for instruments of this series.

Therefore, in response to a query, the FSW returns data of the same structure as that used by the original instruments; this applies in particular to the number of characters returned.

Two formats are currently supported when trace data is output: Display Units (command O1) and physical values (command O2, O3 or TDF P). As to the "Display Units" format, the level data of the FSW is converted to match the value range and the resolution of the 8566/8568 series. Upon transition to the **REMOTE** state, the FSW is reconfigured such that the number of test points (trace points) corresponds to that of the 85xx families (1001 for 8566A/B and 8568A/B, 601 for 8560E to 8565E, 401 for 8594E).

#### 13.14.2.6 Trace data output formats

All formats are supported for trace data output: display units (command O1), display units in two byte binary data (command O2 or TDF B and MDS W), display units in one byte binary data (command O4 or TDF B and MDS B) and physical values (commands

O3 or TDF P). With format "display units" the level data is converted into value range and resolution of the 8566/8568 models. On transition to REMOTE state the number of trace points are reconfigured in order to be conform to the selected instrument model (1001 for 8566A/B and 8568 A/B, 601 for 8560E to 8565E, 401 for 8594E).

#### 13.14.2.7 Trace data input formats

Trace data input is only supported for binary date (TDF B, TDF A, TDF I, MDS W, MDS B).

#### 13.14.2.8 GPIB status reporting

The assignment of status bits by commands R1, R2, R3, R4, RQS is supported.

The STB command and the serial poll respond with an 8-bit value with the following assignment:

Bit enabled by RQS	Description
0	not used (value 0)
1	Units key pressed
2	End of Sweep
3	Device Error
4	Command Complete
5	Illegal Command
6	Service Request
7	not used (value 0)

Bits 0 and 7 are not used and always have the value 0.

Please note that the FSW reports any key pressed on the front panel rather than only the unit keys if bit 1 was enabled.

Another difference is the behavior of bit 6 when using the STB? query. On the HP analyzers this bit monitors the state of the SRQ line on the bus. On the FSW this is not possible. Therefore this bit is set, as soon as one of the bits 1 to 5 is set. It won't be reset by performing a serial poll.

### 13.14.3 Reference: command set of emulated PSA models

The FSW analyzer family supports a subset of the GPIB commands of PSA89600 and ESA instruments.

Despite the differences in system architecture and device features, the supported commands have been implemented in a way to ensure a sufficiently high degree of correspondence with the original.

## Emulating other instruments' commands

In many cases the selection of commands supported by the FSW is sufficient to run an existing GPIB program without adaptation.

Supported 89600 commands
*CAL?
*CLS
*ESE
*ESR?
*IDN?
*IST?
*OPC
*OPT?
*PCB
*PRE
*PSC
*RST
*SRE
*STB?
*TRG
*TST?
*WAI
:CALibration:AUTO OFF ON ALERT
:CALibration:TCORrections AUTO ON OFF
:CONFigure:WAVeform
:DIAGnostic:EABY ON OFF
:DIAGnostic:LATCh:VALue <numeric>
:DIAGnostic:LATCh:SElect <string>
:DISPlay:ANNotation:TITLe:DATA <string>
:DISPlay:ENABle OFF ON
:DISPlay:WINDow:TRACe:Y:[SCALe]:PDIVision <numeric>
:DISPlay:WINDow:TRACe:Y:[SCALe]:RLEVel <numeric>
:DISPlay:WINDow:TRACe:Y:[SCALe]:RLEVel:OFFSet <numeric>
:DISPlay:WINDow:TRACe:Y:[SCALe]:SPACing LINear LOGarithmic LDB
:FORMat:BORDER NORMal SWAPped
:FORMat[:DATA] ASCii REAL UINT MATLAB,<numeric>



## Emulating other instruments' commands

Supported 89600 commands
:INITiate:CONTinuous OFF ON
:INITiate[:IMMEDIATE]
:INSTrument:CATalog?
:INSTrument:NSElect <numeric>
:MMEMory:CATalog? <dir_name>
:MMEMory:COpy <'file_name1'>,<'file_name2'>
:MMEMory:DATA <'file_name'>,<definite_length_block>
:MMEMory:DElete <'file_name'>
:MMEMory:LOAD:STATe 1,<'file_name'>
:MMEMory:LOAD:TRACe 1,<'file_name'>
:MMEMory:MDIRectory <'dir_name'>
:MMEMory:MOVE <'file_name1'>,<'file_name2'>
:MMEMory:STORE:STATe 1,<'file_name'>
:MMEMory:STORE:TRACe <numeric>,<'file_name'>
:READ:WAVform?
[:SENSe]:CORRection:CSET:All[STATe] <boolean>
[:SENSe]:FREQuency:CENTer <numeric>
[:SENSe]:FREQuency:STARt <numeric>
[:SENSe]:FREQuency:STOP <numeric>
[:SENSe]:FREQuency:SPAN <numeric>
[:SENSe]:POWer:ATTenuation <numeric>
[:SENSe]:ROSCillator:EXTernal:FREQuency <numeric>
[:SENSe]:ROSCillator:OUTPut OFF ON
[:SENSe]:ROSCillator:SOURce INTernal EXTernal EAUTO
[:SENSe]:SPECTrum:TRIGger:SOURce EXTernal<1 2> IF IMMEDIATE
[:SENSe]:WAVeform:ADC:RANGe P6
[:SENSe]:WAVeform:APER?
[:SENSe]:WAVeform:AVERage:TACount <numeric>
[:SENSe]:WAVeform:BWIDth:ACTive?
[:SENSe]:WAVeform:BWIDth:TYPE FLAT GAUSSian
[:SENSe]:WAVeform:IFGain <numeric>
[:SENSe]:WAVeform:IFPath NARRow WIDE
[:SENSe]:WAVeform:NCPTTrace ON OFF

## Emulating other instruments' commands

Supported 89600 commands
[.SENSe]:WAVeform:PDIT ON OFF
[.SENSe]:WAVeform:SRATe <numeric>
[.SENSe]:WAVeform:SWEep:TIME <numeric>
[.SENSe]:WAVeform:TRIGger:EOFFset?
[.SENSe]:WAVeform:TRIGger:INTerpolation ON OFF
[.SENSe]:WAVeform:TRIGger:SOURce EXTernal<1 2> IF IMMediate
:STATus:QUEStionable:CONDition?
:STATus:QUEStionable:ENABle <number>
:STATus:QUEStionable:NTRansition <number>
:STATus:QUEStionable:PTRansition <number>
:STATus:QUEStionable[:EVENT]?
:STATus:QUEStionable:CALibration:CONDition?
:STATus:QUEStionable:CALibration:ENABle <number>
:STATus:QUEStionable:CALibration:NTRansition <number>
:STATus:QUEStionable:CALibration:PTRansition <number>
:STATus:QUEStionable:CALibration[:EVENT]?
:STATus:QUEStionable:FREQuency:CONDition?
:STATus:QUEStionable:FREQuency:ENABle <number>
:STATus:QUEStionable:FREQuency:NTRansition <number>
:STATus:QUEStionable:FREQuency:PTRansition <number>
:STATus:QUEStionable:FREQuency[:EVENT]?
:STATus:QUEStionable:INTegrity:CONDition?
:STATus:QUEStionable:INTegrity:ENABle <number>
:STATus:QUEStionable:INTegrity:NTRansition <number>
:STATus:QUEStionable:INTegrity:PTRansition <number>
:STATus:QUEStionable:INTegrity[:EVENT]?
:STATus:OPERation:CONDition?
:STATus:OPERation:ENABle <integer>
:STATus:OPERation:NTRansition <integer>
:STATus:OPERation:PTRansition <integer>
:STATus:OPERation[:EVENT]?
:SYSTem:COMMunicate:GPIB[:SELF]:ADDRess <integer>
:SYSTem:DATE <year>,<month>,<day>

Supported 89600 commands
:SYSTem:ERRor[:NEXT]?
:SYSTem:KLOCK?
:SYSTem:MESSage <string>
:SYSTem:PRESet
:SYSTem:TIME <hour>,<minute>,<second>
:SYSTem:VERSion?
:TRACe:COPY <src_trace>,<dest_trace>
:TRACe[:DATA] TRACE1   TRACE2   TRACE3   TRACE4   TRACE5   TRACE6, <definite_length_block>   <comma_separated_ASCII_data>
:TRACe:MODE WRITe MAXHold MINHold VIEW BLANK
:TRIGger[:SEQuence]:DELay <numeric>
:TRIGger[:SEQuence]:DELay:STATe OFF ON 0 1
:TRIGger[:SEQuence]:EXTerMal:DELay <numeric>
:TRIGger[:SEQuence]:EXTerMal:LEVel <numeric>
:TRIGger[:SEQuence]:EXTerMal:SLOPe POSitive NEGative
:TRIGger[:SEQuence]:HOLDoff <numeric>
:TRIGger[:SEQuence]:IF:DELay <numeric>
:TRIGger[:SEQuence]:IF:LEVel <numeric>
:TRIGger[:SEQuence]:IF:SLOPe POSitive NEGative
:TRIGger[:SEQuence]:SLOPe POSitive NEGative
:TRIGger[:SEQuence]:SOURce IMMEDIATE VIDeo EXTerMal<1 2>
:TRIGger[:SEQuence]:VIDeo:LEVel <numeric>
:TRIGger[:SEQuence]:VIDeo:LEVel:FREQuency <freq>

#### 13.14.4 Reference: command set of emulated PXA models

The FSW analyzer family supports a subset of the GPIB commands of PXA instruments.

Despite the differences in system architecture and device features, the supported commands have been implemented in a way to ensure a sufficiently high degree of correspondence with the original.

In many cases the selection of commands supported by the FSW is sufficient to run an existing GPIB program without adaptation.

## Emulating other instruments' commands

**Table 13-13: Supported PXA commands**

ABORt
CALCulate:MARKer:AOFF
CALCulate:MARKer[1][2]...12:MAXimum
CALCulate:MARKer[1][2]...12:MAXimum:LEFT
CALCulate:MARKer[1][2]...12:MAXimum:NEXT
CALCulate:MARKer[1][2]...12:MAXimum:RIGHT
CALCulate:MARKer[1][2]...12:MINimum
CALCulate:MARKer[1][2]...12:MODE POSition   DELTa   FIXed   OFF
CALCulate:MARKer[1][2]...12:MODE[?] SPAN   BAND
CALCulate:MARKer[1][2]...12[:SET]:CENTER
CALCulate:MARKer[1][2]...12[:SET]:RLEVEL
CALCulate:MARKer[1][2]...12[:SET]:START
CALCulate:MARKer[1][2]...12[:SET]:STOP
CALCulate:MARKer[1][2]...12:STATe[?] OFF   ON   0   1
CALCulate:MARKer[1][2]...12:X[?] <freq   time>
CALCulate:MARKer[1][2]...12:X:POSition[?] <real>
CALCulate:MARKer[1][2]...4:X:SPAN
CALCulate:MARKer[1][2]...4:X:START
CALCulate:MARKer[1][2]...4:X:STOP
CALCulate:MARKer[1][2]...12:Y[?] <real>
CALibration[:ALL][?]
CALibration:AUTO[?] ON   PARTial   OFF   ALERt
CALibration:AUTO:ALERt[?] TTEMPerature   DAY   WEEK   NONE
CALibration:AUTO:MODE[?] ALL   NRF
CALibration:AUTO:TIME:OFF?
CONFigure? SAN
DISPlay:WINDow[1]:TRACe:Y[:SCALe]:RLEVEL[?] <real>
DISPlay:WINDow[1]:TRACe:Y[:SCALe]:RLEVEL:OFFSet[?] <rel_ampl>
DISPlay:WINDow[1]:TRACe:Y[:SCALe]:SPACing LINear LOGarithmic LDB
INITiate:CONTinuous[?] OFF   ON   0   1
INITiate[:IMMediate]
INPut:COUPling[?] AC   DC
MMEMory:CATalog? [<directory_name>]
MMEMory:CDIRectory[?] [<directory_name>]

## Emulating other instruments' commands

MMEMory:COpy <string>, <string>[, <string>, <string>]
MMEMory:DATA[?] <file_name>, <data>
MMEMory:DELeTe <file_name>[, <directory_name>]
MMEMory:LOAD:STATe 1, <filename>
MMEMory:MDIRectory <directory_name>
MMEMory:MOVE <string>, <string>[, <string>, <string>]
MMEMory:RDIRectory <directory_name>
MMEMory:STORe:STATe 1, <filename>
[.SENSe]:AVERAge:COUNT[?] <integer>
[.SENSe]:AVERAge[:STATe][?] ON   OFF   1   0
[.SENSe]:AVERAge:TYPE[?] RMS   LOG   SCALar[:SENSe]:AVERAge:TYPE?
[.SENSe]:BANDwidth BWIDth[:RESolution][?] <freq>
[.SENSe]:BANDwidth BWIDth[:RESolution]:AUTO[?] OFF   ON   0   1
[.SENSe]:BANDwidth BWIDth:VIDeo[?] <freq>
[.SENSe]:BANDwidth BWIDth:VIDeo:AUTO[?] OFF   ON   0   1
[.SENSe]:BANDwidth BWIDth:VIDeo:RATio[?] <real>
[.SENSe]:BANDwidth BWIDth:VIDeo:RATio:AUTO[?] OFF   ON   0   1
[.SENSe]:CORRection:CSET:All[STATe] <boolean>
[.SENSe]:DETEctor:AUTO[?] ON   OFF   1   0
[.SENSe]:FREQuency:CENTer[?] <freq>
[.SENSe]:FREQuency:CENTer:STEP:AUTO[?] OFF   ON   0   1
[.SENSe]:FREQuency:OFFSet[?] <freq>
[.SENSe]:FREQuency:SPAN[?] <freq>
[.SENSe]:FREQuency:SPAN:FULL
[.SENSe]:FREQuency:STARt[?] <freq>
[.SENSe]:FREQuency:STOP[?] <freq>
[.SENSe]:POWer[:RF]:ATTenuation[?] <rel_ampl>
[.SENSe]:POWer[:RF]:ATTenuation:AUTO[?] OFF   ON   0   1
[.SENSe]:SWEep:POINts? <integer>
[.SENSe]:SWEep:TIME? <time>
[.SENSe]:SWEep:TIME:AUTO? OFF   ON   0   1
TRIGger[:SEQuence]:EXTErnal2:DELay[?] <time>
TRIGger[:SEQuence]:EXTErnal1:DELay[?] <time>
TRIGger[:SEQuence]:EXTErnal2:DELay:STATe[?] OFF   ON   0   1

TRIGger[:SEQUence]:EXTernal1:DELay:STATe[?] OFF   ON   0   1
TRIGger[:SEQUence]:EXTernal2:LEVel[?] <level>
TRIGger[:SEQUence]:EXTernal1:LEVel[?] <level>
TRIGger[:SEQUence]:EXTernal2:SLOPe[?] POSitive   NEGative
TRIGger[:SEQUence]:EXTernal1:SLOPe[?] POSitive   NEGative
TRIGger[:SEQUence]:IF:LEVel[?]
TRIGger[:SEQUence]:IF:SLOPe[?] NEGative   POSitive
TRIGger[:SEQUence]:SOURCe EXTernal   IMMEDIATE   VIDEO   LINE   EXTernal1   EXT1   EXTernal2   EXT2   RFBurst   FRAME
TRIGger[:SEQUence]:VIDeo:DELay[?] <time>
TRIGger[:SEQUence]:VIDeo:DELay:STATe[?] OFF   ON   0   1
TRIGger[:SEQUence]:VIDeo:LEVel[?] <ampl>
TRIGger[:SEQUence]:VIDeo:SLOPe[?] POSitive   NEGative

### 13.14.5 Command set for analog demodulation for emulated PXA models

The FSW supports a subset of the GPIB commands of PXA instruments for Analog Demodulation measurements.

Despite the differences in system architecture and device features, the supported commands have been implemented in a way to ensure a sufficiently high degree of correspondence with the original.

In many cases the selection of commands supported by the FSW is sufficient to run an existing GPIB program without adaptation.

**Table 13-14: Supported PXA commands for Analog Demodulation**

CONFigure:AM
CONFigure:AM:NDEFault
DISPlay:AM:WINDow:TRACe:Y[:SCALe]:RLEVel <real>
READ:AM?
FETCh:AM?
[SENSe]:AM:DWSWeep:TIME <real>

### 13.14.6 Command set for vector signal analysis (VSA) for emulated R&S FSE instruments

The FSW supports a subset of the GPIB commands of the R&S FSE for vector signal analysis (VSA).

Despite the differences in system architecture and device features, the supported commands have been implemented in a way to ensure a sufficiently high degree of correspondence with the original.

In many cases the selection of commands supported by the FSW is sufficient to run an existing GPIB program without adaptation.

**Table 13-15: Supported R&S FSE commands for vector signal analysis (VSA)**

CALCulate{1 2}:MARKer{m}:FUNction:DDEMod:RESult?
CALCulate{1 2}:TLINe{1 2} <real>
CALCulate{1 2}:TLINe{1 2}:STATe <bool>
[SENSe]:DDEMod:SEARch:SYNC:OFFSet <real>
[SENSe]:DDEMod:SEARch:SYNC:PATtern <pattern>
[SENSe]:DDEMod:SEARch:PULSe:STATe <bool>
[SENSe]:DDEMod:SEARch:TIME <real>
[SENSe]:DDEMod:FILTer:REFerence
[SENSe]:DDEMod:PRESet[:STANdard]
[SENSe]:TCAPture:LENGth <real>
TRIGger[:SEQuence]:LEVel:VIDeo <real>

## 13.15 Deprecated commands

The following commands are provided for compatibility to other signal analyzers only. For new remote control programs use the specified alternative commands.

[SENSe:]ESpectrum<sb>:SBCenter.....	1527
[SENSe:]ESpectrum<sb>:SBCount.....	1528
CALCulate<n>:LIMit<li>:TRACe<t>.....	1528
DISPlay[:WINDow<n>]:STATe.....	1529
DISPlay[:WINDow<n>]:TYPE.....	1529
HCOPY:ITEM:ALL.....	1529
SOURce<si>:EXTernal<gen>:FREQuency:SWEep[:STATe].....	1529
SYSTem:COMPAtible.....	1530
TRIGger[:SEQuence]:BBPower:HOLDoff.....	1530
TRIGger[:SEQuence]:RFPower:HOLDoff.....	1530

---

### [SENSe:]ESpectrum<sb>:SBCenter <Frequency>

Defines the center frequency of the selected sub block in a Multi-SEM measurement.

Note that this command is maintained for compatibility reasons only. For newer remote control programs use the [SENSe:]ESpectrum<sb>:SCENter command.

**Suffix:**

<sb> 1 to 8  
Subblock in a multi-SEM measurement

**Parameters:**

<Frequency> Frequency within the currently defined global span (see [\[SENSe:\]FREQuency:SPAN](#) on page 1194 and [\[SENSe:\]FREQuency:CENTer](#) on page 1192).  
Range: 1 to 3  
\*RST: 1  
Default unit: HZ

**Example:** ESP2:SCENter 1GHZ

**[SENSe:]ESpectrum<sb>:SBCount <Subblocks>**

Defines the number of sub blocks in the SEM measurement.

Note that this command is maintained for compatibility reasons only. For newer remote control programs use the [\[SENSe:\]ESpectrum<sb>:SCount](#) command.

**Suffix:**

<sb> 1 to 8  
Subblock in a multi-SEM measurement

**Parameters:**

<Subblocks> Number of sub blocks in the SEM measurement.  
Range: 1 to 3  
\*RST: 1

**Example:** ESP:SBCount 2

**CALCulate<n>:LIMit<li>:TRACe<t> <TraceNumber>**

Links a limit line to one or more traces.

Note that this command is maintained for compatibility reasons only. Limit lines no longer need to be assigned to a trace explicitly. The trace to be checked can be defined directly (as a suffix) in the new command to activate the limit check (see [CALCulate<n>:LIMit<li>:TRACe<t>:CHECK](#) on page 1342).

**Suffix:**

<n> [Window](#)  
<li> [Limit line](#)  
<t> irrelevant

**Parameters:**

<TraceNumber> 1 to 6  
\*RST: 1

**Example:** CALC:LIM2:TRAC 3  
Assigns limit line 2 to trace 3.



---

**DISPlay[:WINDow<n>]:STATe** <State>

Changes the display state of the selected measurement window.

Note that this command is maintained for compatibility reasons only. Use the `LAYout` commands for new remote control programs

(See [Chapter 13.6.2, "Working with windows in the display"](#), on page 1099).

**Suffix:**

<n> [Window](#)

**Parameters:**

<State> `ON | OFF | 0 | 1`  
**OFF | 0**  
Switches the function off  
**ON | 1**  
Switches the function on

---

**DISPlay[:WINDow<n>]:TYPE** <WindowType>

Selects the results displayed in a measurement window.

Note that this command is maintained for compatibility reasons only. Use the `LAYout` commands for new remote control programs (see [Chapter 13.6.2, "Working with windows in the display"](#), on page 1099).

**Suffix:**

<n> [Window](#)

**Parameters:**

<WindowType> The parameter values are the same as for `LAYout:ADD[:WINDow]?` on page 1100.

---

**HCOPY:ITEM:ALL**

This command is maintained for compatibility reasons only. It has no effect.

---

**SOURce<si>:EXTErnal<gen>:FREQUency:SWEep[:STATe]** <State>

Note that this command is maintained for compatibility reasons only. It is not required in new remote control programs.

Activates or deactivates the frequency sweep for the selected generator.

**Suffix:**

<si> irrelevant

<gen>

**Parameters:**

<State> `ON | OFF | 0 | 1`

**OFF | 0**

Switches the function off

**ON | 1**

Switches the function on

**Example:**`SOUR:EXT:FREQ:SWE ON`

Activates the frequency sweep for the external generator.

**SYSTem:COMPAtible <Mode>**

This command enables compatibility to other spectrum and signal analyzers by R&amp;S.

Compatibility is necessary, for example, regarding the number of sweep points.

Note that this command is maintained for compatibility reasons only. Use the `SYST:LANG` command for new remote control programs (see [SYSTem:LANGuage](#) on page 1489).**Parameters:**

&lt;Mode&gt;                   DEFault | FSU | FSP | FSQ | FSV

**Example:**`SYST:COMP FSP`**TRIGger[:SEQuence]:BBPower:HOLDoff <Period>**

Defines the holding time before the baseband power trigger event.

The command requires the optional "Digital Baseband" interface or the optional "Analog Baseband" interface.

Note that this command is maintained for compatibility reasons only. Use the [TRIGger\[:SEQuence\]:IFPower:HOLDoff](#) on page 1218 command for new remote control programs.**Parameters:**

<Period>                   Range:       150 ns to 1000 s  
                               \*RST:        150 ns  
                               Default unit: S

**Example:**`TRIG:SOUR BBP`

Sets the baseband power trigger source.

`TRIG:BBP:HOLD 200 ns`

Sets the holding time to 200 ns.

**TRIGger[:SEQuence]:RFPower:HOLDoff <Time>****Parameters:**

&lt;Time&gt;                   Default unit: S

## 13.16 Programming examples

Some advanced programming examples for complex measurement tasks are provided here.



Further programming examples for common measurement tasks are described in the individual measurement chapters, for example:

- [Chapter 13.4.3, "Programming example: performing a sequence of measurements"](#), on page 905
  - [Chapter 13.8.5.4, "Programming example: using limit lines"](#), on page 1344
  - [Chapter 13.5.3.11, "Programming examples for channel power measurements"](#), on page 971
  - ["Programming example: Measuring the carrier-to-noise ratio"](#) on page 979
  - [Chapter 13.5.5.2, "Programming example: OBW measurement"](#), on page 981
  - [Chapter 13.5.7.11, "Example: SEM measurement"](#), on page 1032
  - [Chapter 13.5.8.7, "Programming example: spurious emissions measurement"](#), on page 1048
  - [Chapter 13.5.9.7, "Programming example: measuring statistics"](#), on page 1060
  - [Chapter 13.5.10.4, "Programming example: time domain power"](#), on page 1070
  - [Chapter 13.5.11.5, "Example: measuring the harmonic distortion"](#), on page 1074
  - [Chapter 13.5.12.2, "Programming example: measuring the TOI"](#), on page 1078
  - [Chapter 13.5.13.2, "Example: measuring the AM modulation depth"](#), on page 1079
  - [Chapter 13.5.14.8, "Programming example: EMI measurement"](#), on page 1087
  - [Chapter 13.5.16.2, "Example: performing a pulse power measurement"](#), on page 1098
  - [Chapter 13.8.2.7, "Programming example: configuring a spectrogram"](#), on page 1265
  - ["Programming example: working with an external mixer"](#) on page 1157
  - [Chapter 13.10.4.2, "Programming example: using touchstone files"](#), on page 1424
  - ["Programming example for external generator control"](#) on page 1174
- 
- [Programming example: performing a basic frequency sweep](#)..... 1531
  - [Service request](#)..... 1534

### 13.16.1 Programming example: performing a basic frequency sweep

This example demonstrates how to configure and perform a basic frequency sweep measurement in a remote environment.

This example assumes a signal is measured at 100 MHz, with a maximum power level of -3 dBm.



Some commands in the following examples may not be necessary as they reflect the default settings; however, they are included to demonstrate the command usage.

```
//-----Preparing the measurement -----
*RST
//Resets the instrument
INIT:CONT OFF
//Selects single sweep mode.

//-----Configuring the Frequency and Span-----
FREQ:CENT 100MHz
//Defines the center frequency
FREQ:SPAN 100MHz
//Sets the span to 50 MHz on either side of the center frequency.

//-----Configuring the Bandwidth-----
BAND:AUTO OFF
BAND 1MHz
BAND:TYPE RRC
//Defines the RBW as 1 MHz using an RRC filter

BAND:VID 500kHz
//Decouples the VBW from the RBW and decreases it to smooth the trace.

//-----Configuring the Sweep-----
SENS:SWE:COUN 10
//Defines 10 sweeps to be performed in each measurement.
SENS:SWE:POIN 500
//During each sweep, 500 trace points will be measured.
SENS:SWE:TIME 50ms
//Decouples the sweep time from the RBW,VBW and span and increases it to
//make the measurement more precise.

//-----Configuring Attenuation-----
//Only if electronic attenuator is available:
//INP:EATT:STAT ON
//Switches on the electronic attenuator.
//INP:EATT 5dB
//Sets the electronic attenuation to 5 dB.
//INP:ATT 0dB
//Sets the mechanical attenuation to 0 dB - makes a total of 5 dB attenuation
//otherwise:
INP:ATT 5 dB
//Sets the mechanical attenuation to 5 dB and couples the reference level
//to the attenuation instead of vice versa.

//-----Configuring the Amplitude and Scaling-----
DISP:TRAC1:Y:RLEV:OFFS 10dB
```

```

//Shifts the trace display in the diagram up by 10dB.
CALC:UNIT:POW V
//Sets the unit of the y-axis to Volt. The reference level is now 70.711 mV.
DISP:TRAC1:Y:SPAC LOG
//Uses logarithmic scaling with absolute values (V).
DISP:TRAC1:Y 110dB
//Increases the displayed range of the y-axis to 110 dB.
DISP:TRAC1:Y:RPOS 80PCT
//Shifts the display of the reference level down, it is no longer the top line
//in the diagram. The reference level is displayed as a red line.

//-----Triggering-----
TRIG:SOUR IFP
TRIG:LEV:IFP -10dBm
TRIG:SLOP POS
TRIG:DTIM 50ms
TRIG:IFP:HYST 5dB
TRIG:HOLD 10ms
//Defines triggering when the second intermediate frequency rises to a level
//of -10 dBm, with a dropout time of 50 ms, a hysteresis of 5 dB and a delay
//of 10 ms.

SWE:EGAT ON
SWE:EGAT:TYPE EDGE
SWE:EGAT:LENG 5ms
//Defines gating. Values are measured for 5 ms after triggering.

OUTP:TRIG2:DIR OUTP
OUTP:TRIG2:OTYP UDEF
OUTP:TRIG2:LEV HIGH
OUTP:TRIG2:PULS:LENG 100us
OUTP:TRIG2:PULS:IMM
//Configures a high trigger signal with a pulse length of 100 us to be output at
//the front TRIGGER INPUT/OUTPUT connector once.

//-----Configuring the Trace-----
DISP:TRAC2:MODE AVER
DISP:TRAC3:MODE MAXH
//Configures 3 traces: 1 (default): clear/write; 2: average; 3: max hold

SENS:DET1 POS
SENS:DET2 RMS
SENS:DET3 POS
//Configures traces 1 and 3 to use the positive peak detector; trace 2 uses
//the RMS detector.

TRAC:COPY TRACE4,TRACE1
//Copies trace 1 to a new trace 4 which will then be averaged.

```

```

SENS:AVER:STAT4 ON
SENS:AVER:COUN 10
SENS:AVER:TYPE LIN
//Configures trace 4 to be averaged linearly over 10 sweeps.

CALC:MATH:STAT ON
CALC:MATH:MODE LIN
CALC:MATH (TRACE1-TRACE2)
CALC:MATH:POS 100
//Calculates the linear difference between the measured and average values.
//The resulting trace is displayed at the top of the diagram.

//-----Performing the Measurement-----
INIT;*WAI
//Initiates a new measurement and waits until the last sweep has finished.

//-----Retrieving Results-----
TRAC:DATA? TRACE1
TRAC:DATA? TRACE2
TRAC:DATA? TRACE3
TRAC:DATA? TRACE4
//Returns one power value per sweep point for each trace.
TRAC:DATA:X?
//Returns one frequency value per sweep point for each trace.

```

## 13.16.2 Service request

The service request routine requires an extended initialization of the instrument in which the relevant bits of the transition and enable registers are set. In addition the service request event must be enabled in the VISA session.

### 13.16.2.1 Initiate service request

```

REM ---- Example of initialization of the SRQ in the case
' of errors -----
PUBLIC SUB SetupSRQ()
CALL InstrWrite (analyzer, "*CLS") 'Reset status reporting system
CALL InstrWrite (analyzer, "*SRE 168") 'Enable service request for
'STAT:OPER, STAT:QUES and ESR
'register
CALL InstrWrite (analyzer, "*ESE 60") 'Set event enable bit for
'command, execution, device-
'dependent and query error
CALL InstrWrite (analyzer, "STAT:OPER:ENAB 32767")
'Set OPERATION enable bit for
'all events
CALL InstrWrite (analyzer, "STAT:OPER:PTR 32767")
'Set appropriate OPERATION

```

```

'Ptransition bits
CALL InstrWrite (analyzer, "STAT:QUES:ENAB 32767")
'Set questionable enable bits
'for all events
CALL InstrWrite (analyzer, "STAT:QUES:PTR 32767")
'Set appropriate questionable
'Ptransition bits
CALL viEnableEvent(analyzer, VI_EVENT_SERVICE_REQ, VI_QUEUE, 0)
'Enable the event for service
'request
Status = viWaitOnEvent(analyzer, VI_EVENT_SERVICE_REQ, SRQWaitTimeout, VI_NULL,
    VI_NULL)
IF (status = VI_SUCCESS) THEN CALL Srq
'If SRQ is recognized =>
'subroutine for evaluation
END SUB
REM *****

Private mbSession As MessageBasedSession

Sub Main()
    Console.WriteLine("Example of initialization _
        of the SRQ in the case of errors.")
    Dim SRQWaitTimeout = 4000 ' Timeout As Integer for WaitOnEvent
    'Opening session
    Try
        'Analyzer is alias, instead of using resource string.
        'For example on TCP use TCP/IP0::192.168.1.2::inst0::INSTR
        mbSession = CType(ResourceManager.GetLocalManager().Open("Analyzer"), _
            MessageBasedSession)
        mbSession.TerminationCharacterEnabled = True
    Try
        mbSession.Write("*CLS") 'Reset status reporting system
        mbSession.Write("*SRE 168") 'Enable service request for
        'STAT:OPER, STAT:QUES and ESR register
        mbSession.Write("*ESE 60") 'Set event enable bit for
        'command, execution, device-dependent and query error
        mbSession.Write("STAT:OPER:ENAB 32767")
        'Set OPERATION enable bit for all events
        mbSession.Write("STAT:OPER:PTR 32767")
        'Set appropriate OPERATION Ptransition bits
        mbSession.Write("STAT:QUES:ENAB 32767")
        'Set questionable enable bits for all events
        mbSession.Write("STAT:QUES:PTR 32767")
        'Set appropriate questionable Ptransition bits
        Console.WriteLine("Wait on event - Blocking")
        mbSession.EnableEvent(MessageBasedSessionEventType.ServiceRequest, _
            EventMechanism.Queue)
        'Enable the event for service request

```

```

'-----
' Your command please use here
' mbSession.Write("Your command")
'-----

Dim Status = mbSession.WaitOnEvent( _
    MessageBasedSessionEventType.ServiceRequest, SRQWaitTimeout)
If (Status.EventType() = _
    MessageBasedSessionEventType.ServiceRequest) Then
    Console.WriteLine("SRQ is recognized")
    'If SRQ is recognized => subroutine for evaluation
    Srq()
End If
Catch exp As Exception
    Console.WriteLine(exp.Message)
End Try
Catch exp As InvalidCastException
    Console.WriteLine("Resource selected must be a message-based session")
Catch exp As Exception
    Console.WriteLine(exp.Message)
End Try

' Close session
mbSession.Dispose()
' Wait for end
Console.WriteLine("Press any key to end")
Console.ReadKey()
End Sub

```

### 13.16.2.2 Waiting for the arrival of a service request

There are basically two methods of waiting for the arrival of a service request:

#### **Blocking (user inputs not possible):**

This method is appropriate if the waiting time until the event to be signaled by an SRQ is short (shorter than the selected timeout), if no response to user inputs is required during the waiting time, and if – as the main criterion – the event is absolutely certain to occur.

Reason:

From the time the `viWaitOnEvent()` function is called until the occurrence of the expected event, it does not allow the program to respond to mouse clicks or key entries during the waiting time. Moreover, it returns an error if the SRQ event does not occur within the predefined timeout period.

The method is, therefore, in many cases not suitable for waiting for measurement results, especially when using triggered measurements.

The following function calls are required:



```

Status = viWaitOnEvent(analyzer, VI_EVENT_SERVICE_REQ, SRQWaitTimeout, VI_NULL,
    VI_NULL)
'Wait for service request user
'inputs are not possible during
'the waiting time!
IF (status = VI_SUCCESS) THEN CALL Srq
'If SRQ is recognized =>
'subroutine for evaluation

'----- Sweep in first Spectrum Tab and query marker -----
Dim Status = mbSession.WaitOnEvent( _
MessageBasedSessionEventType.ServiceRequest, SRQWaitTimeout)
'Wait for service request user inputs are not possible
'during the waiting time!
If (Status.EventType() = MessageBasedSessionEventType.ServiceRequest) Then
'If SRQ is recognized => subroutine for evaluation
    Srq()
End If

```

#### Non-blocking (user inputs possible):

This method is recommended if the waiting time until the event to be signaled by an SRQ is long (longer than the selected timeout), and user inputs should be possible during the waiting time, or if the event is not certain to occur. This method is, therefore, the preferable choice for waiting for the end of measurements, i.e. the output of results, especially in the case of triggered measurements.

The method necessitates a waiting loop that checks the status of the SRQ line at regular intervals and returns control to the operating system during the time the expected event has not yet occurred. In this way, the system can respond to user inputs (mouse clicks, key entries) during the waiting time.

It is advisable to employ the Hold() auxiliary function, which returns control to the operating system for a selectable waiting time (see section [Waiting without blocking the keyboard and mouse](#)), so enabling user inputs during the waiting time.

```

result% = 0
For i = 1 To 10 'Abort after max. 10 loop
'iterations
Status = viWaitOnEvent(analyzer, VI_EVENT_SERVICE_REQ, VI_TMO_IMMEDIATE, VI_NULL,
    VI_NULL)
'Check event queue
If (status = VI_SUCCESS) Then
result% = 1
CALL Srq 'If SRQ is recognized =>
'subroutine for evaluation
Else
CALL Hold(20) 'Call hold function with
'20 ms 'waiting time. User inputs
'are possible.
Endif

```

```

Next i
If result% = 0 Then
Debug.Print "Timeout Error; Program aborted" 'Output error message
STOP 'Stop software
Endif

```

### 13.16.2.3 Waiting without blocking the keyboard and mouse

A frequent problem with remote control programs using Visual Basic is to insert waiting times without blocking the keyboard and the mouse.

If the program is to respond to user inputs also during a waiting time, control over the program events during this time must be returned to the operating system. In Visual Basic, this is done by calling the `DoEvents` function. This function causes keyboard-or mouse-triggered events to be executed by the associated elements. For example, it allows the operation of buttons and input fields while the user waits for an instrument setting to be completed.

The following programming example describes the `Hold()` function, which returns control to the operating system for the period of the waiting time selectable in milliseconds.

```

Rem *****
Rem The waiting function below expects the transfer of the desired
Rem waiting time in milliseconds. The keyboard and the mouse remain
Rem operative during the waiting period, thus allowing desired elements
Rem to be controlled
Rem *****
Public Sub Hold(delayTime As Single)
Start = Timer 'Save timer count on calling the
'function
Do While Timer < Start + delayTime/1000 'Check timer count
DoEvents 'Return control to operating
'system to enable control of
'desired elements as long as
'timer has not elapsed
Loop
End Sub
Rem *****

```

The waiting procedure is activated simply by calling `Hold(<Waiting time in milliseconds>)`.

### 13.16.2.4 Service request routine

A service request is processed in the service request routine.



The variables `userN%` and `userM%` must be pre-assigned usefully!

```

REM ----- Service request routine -----
Public SUB Srq()
ON ERROR GOTO noDevice 'No user existing
CALL viReadSTB(analyzer, STB%) 'Serial poll, read status byte
IF STB% > 0 THEN 'This instrument has bits set in
'the STB
SRQFOUND% = 1
IF (STB% AND 16) > 0 THEN CALL Outputqueue
IF (STB% AND 4) > 0 THEN CALL ErrorQueueHandler
IF (STB% AND 8) > 0 THEN CALL Questionablestatus
IF (STB% AND 128) > 0 THEN CALL Operationstatus
IF (STB% AND 32) > 0 THEN CALL Esrread
END IF
noDevice:
END SUB 'End of SRQ routine
REM *****

REM ----- Subroutine for evaluation Service Request Routine -----

Public Sub Srq()
    Try
        Dim mySTB As Short = mbSession.ReadStatusByte()
            'Serial poll, read status byte
        Console.WriteLine("Reading Service Request Routine:" + mySTB.ToString())
        If mySTB > 0 Then 'This instrument has bits set in the STB
            If (mySTB And 16) > 0 Then Call Outputqueue()
            If (mySTB And 4) > 0 Then Call ErrorQueueHandler()
            If (mySTB And 8) > 0 Then Call Questionablestatus()
            If (mySTB And 128) > 0 Then Call Operationstatus()
            If (mySTB And 32) > 0 Then Call Esrread()
        End If
    Catch exp As Exception
        Console.WriteLine(exp.Message)
    End Try
End Sub 'End of SRQ routine

```

Reading out the status event registers, the output buffer and the error/event queue is effected in subroutines.

### 13.16.2.5 Reading out the output buffer

```

REM ----- Subroutine for the individual STB bits -----
Public SUB Outputqueue() 'Reading the output buffer
result$ = SPACE$(100) 'Make space for response
CALL InstrRead(analyzer, result$)
Debug.Print "Contents of Output Queue:"; result$
END SUB
REM *****

REM ----- Subroutine for the output queue -----
Public Sub Outputqueue() 'Reading the output buffer

```

```

Try
    Dim result As String = mbSession.ReadString()
    Console.WriteLine("Contents of Output Queue:" + result)
Catch exp As Exception
    Console.WriteLine(exp.Message)
End Try
End Sub

```

### 13.16.2.6 Reading error messages

```

REM ----- Subroutine for reading the error queue -----
Public SUB ErrorQueueHandler()
ERROR$ = SPACE$(100) 'Make space for error variable
CALL InstrWrite (analyzer, "SYSTEM:ERROR?")
CALL InstrRead(analyzer, ERROR$)
Debug.Print "Error Description: "; ERROR$
END SUB
REM *****

REM ----- Subroutine for reading the error queue -----
Sub ErrorQueueHandler()
    Dim result As String
    Dim hasErr As Boolean = True
    Do
        mbSession.Write("SYST:ERR?")
        result = mbSession.ReadString()
        Dim parts As String() = result.Split(",")
        If parts(0) = 0 Then
            hasErr = False
            Console.WriteLine(result)
        Else
            Console.WriteLine(result)
        End If
    Loop While hasErr
End Sub

```

### 13.16.2.7 Evaluation of SCPI status registers

```

REM ----- Subroutine for evaluating Questionable Status Register -----
Public SUB Questionablestatus()
Ques$ = SPACE$(20)
'Preallocate blanks to text
'variable
CALL InstrWrite (analyzer, "STATus:QUESTionable:EVENT?")
CALL InstrRead(analyzer, Ques$)
Debug.Print "Questionable Status: "; Ques$
END SUB
REM *****

REM ----- Subroutine for evaluating Operation Status Register -----

```

```

Public SUB Operationstatus()
Oper$ = SPACE$(20) 'Preallocate blanks to text
'variable
CALL InstrWrite (analyzer, "STaTus:OPERation:EVENT?")
CALL InstrRead(analyzer, Oper$)
Debug.Print "Operation Status: "; Oper$
END SUB
REM *****

REM ----- Subroutine for evaluating Questionable Status Register -----
Public Sub Questionablestatus()
    Dim myQSR As String = Nothing
    Try
        myQSR = mbSession.Query("STaTus:QUEStionable:EVENT?") 'Read QSR
        Console.WriteLine("Questionable Status:" + myQSR)
    Catch exp As Exception
        Console.WriteLine(exp.Message)
    End Try
End Sub

REM ----- Subroutine for evaluating Operation Status Register -----
Public Sub Operationstatus()
    Dim myOSR As String = Nothing
    Try
        myOSR = mbSession.Query("STaTus:OPERation:EVENT?") 'Read OSR
        Console.WriteLine("Operation Status:" + myOSR)
    Catch exp As Exception
        Console.WriteLine(exp.Message)
    End Try
End Sub

```

### 13.16.2.8 Evaluation of event status register

```

REM ----- Subroutine for evaluating the Event Status Register -----
Public SUB Esrread()
Esr$ = SPACE$(20) 'Preallocate blanks to text
'variable
CALL InstrWrite (analyzer, "*ESR?") 'Read ESR
CALL InstrRead(analyzer, Esr$)
IF (VAL(Esr$) AND 1) > 0 THEN Debug.Print "Operation complete"
IF (VAL(Esr$) AND 2) > 0 THEN Debug.Print "Request Control"
IF (VAL(Esr$) AND 4) > 0
THEN Debug.Print "Query Error"
IF (VAL(Esr$) AND 8) > 0
THEN Debug.Print "Device dependent error"
IF (VAL(Esr$) AND 16) > 0
THEN Debug.Print "Execution Error; Program aborted" 'Output error message
STOP 'Stop software
END IF
IF (VAL(Esr$) AND 32) > 0

```

```

THEN Debug.Print "Command Error; Program aborted" 'Output error message
STOP 'Stop software
END IF
IF (VAL(Esr$) AND 64) > 0 THEN Debug.Print "User request"
IF (VAL(Esr$) AND 128) > 0 THEN Debug.Print "Power on"END SUB
REM *****
REM ----- Subroutine for evaluating the Event Status Register -----
Public Sub Esrread()
    Try
        Dim myESR As Short = mbSession.Query("*ESR?") 'Read ESR
        If (myESR And 1) > 0 Then Console.WriteLine("Operation complete")
        If (myESR And 2) > 0 Then Console.WriteLine("Request Control")
        If (myESR And 4) > 0 Then Console.WriteLine("Query Error")
        If (myESR And 8) > 0 Then Console.WriteLine("Device dependent error")
        If (myESR And 16) > 0 Then
            Console.WriteLine("Execution Error; Program aborted") 'Output error message
            Stop 'Stop software
        End If
        If (myESR And 32) > 0 Then
            Console.WriteLine("Command Error; Program aborted") 'Output error message
            Stop 'Stop software
        End If
        If (myESR And 64) > 0 Then Console.WriteLine("User request")
        If (myESR And 128) > 0 Then Console.WriteLine("Power on")
    Catch exp As Exception
        Console.WriteLine(exp.Message)
    End Try
End Sub

```

# 14 Troubleshooting

If the results do not meet your expectations, the following sections may contain helpful hints and information.

- [Error information](#)..... 1543
- [Error messages in remote control mode](#)..... 1545
- [Troubleshooting remote operation](#)..... 1546
- [Miscellaneous troubleshooting hints](#)..... 1548
- [System recovery](#)..... 1550
- [Collecting information for support](#)..... 1550
- [Contacting customer support](#)..... 1553

## 14.1 Error information

If errors or irregularities are detected, a keyword and an error message, if available, are displayed in the status bar.



Depending on the type of message, the status message is indicated in varying colors.

**Table 14-1: Status bar information - color coding**

Color	Type	Description
Red	Error	An error occurred at the start or during a measurement, e.g. due to missing data or wrong settings, so that the measurement cannot be started or completed correctly.
Orange	Warning	An irregular situation occurred during measurement, e.g. the settings no longer match the displayed results, or the connection to an external device was interrupted temporarily.
Gray	Information	Information on the status of individual processing steps.
No color	No errors	No message displayed - normal operation.
Green	Measurement successful	Some applications visualize that the measurement was successful by showing a message.



If any error information is available for a channel, an exclamation mark is displayed next to the channel name (■). This is particularly useful when the MultiView tab is displayed, as the status bar in the MultiView tab always displays the information for the currently selected measurement only.

Furthermore, a status bit is set in the `STATUS:QUESTIONABLE:EXTENDED:INFO` register for the application concerned (see [Chapter 12.2.2.8, "STATUS:QUESTIONABLE:EXTENDED:INFO register"](#), on page 830). Messages of a specific type can be queried using the `SYST:ERR:EXT?` command, see [SYSTEM:ERROR:EXTENDED?](#) on page 1448. Some errors also change particular status bits in other registers, as indicated in [Table 14-2](#). For more information, see [Chapter 12.2, "Status reporting system"](#), on page 822.

Table 14-2: List of keywords

Keyword	Description	Bit in status register
"DATA ERR"	For the optional Digital Baseband Interface only: Error in digital I/Q input data  For details on the optional Digital Baseband Interface, see the FSW I/Q Analyzer User Manual.	STATUS:QUESTIONABLE:DIQ, bit 4
"FIFO OVLD"	For Digital Baseband Interface (FSW-B17) only: Input sample rate from connected instrument is too high  For details on the optional Digital Baseband Interface, see the FSW I/Q Analyzer User Manual.	STATUS:QUESTIONABLE:DIQ, bit 6
"INPUT OVLD"	The signal level at the RF input connector exceeds the maximum.  The RF input is disconnected from the input mixer to protect the device. To re-enable measurement, decrease the level at the RF input connector and reconnect the RF input to the mixer input.  (See "RF Input Protection" in the FSW User Manual).	STATUS:QUESTIONABLE:POWER, bit 3
"OVLD"	Overflow of the input signal path after the input mixer; This error can appear for input sources other than the RF input, e.g. for input from the optional Digital Baseband Interface or the optional Analog Baseband Interface. <ul style="list-style-type: none"> <li>Reduce the input level.</li> <li>For instruments with the option FSW-U85, when measuring signals higher than 43 GHz and levels higher than -10 dBm, increase the manual attenuation.</li> </ul>	STATUS:QUESTIONABLE:POWER, bit 2
"RF OVLD"	Overflow of the input mixer or of the analog IF path. <ul style="list-style-type: none"> <li>Increase the RF attenuation (for RF input).</li> <li>Reduce the input level (for digital input)</li> </ul>	STATUS:QUESTIONABLE:POWER, bit 0
"LO UNL"	Error in the instrument's frequency processing hardware was detected.	STAT:QUES:FREQUENCY, bit 1
"NO REF"	Instrument was set to an external reference but no signal was detected on the reference input.	STAT:QUES:FREQUENCY, bit 8
"OVENCOLD"	The optional OCXO reference frequency has not yet reached its operating temperature. The message usually disappears a few minutes after power has been switched on.	STAT:QUES:FREQUENCY, bit 0
"PLL UNLOCK"	For the optional Digital Baseband Interface only: Error in digital I/Q input data  For details on the optional Digital Baseband Interface, see the FSW I/Q Analyzer User Manual.	STATUS:QUESTIONABLE:DIQ, bit 3
"UNCAL"	One of the following conditions applies: <ul style="list-style-type: none"> <li>Correction data has been switched off.</li> <li>No correction values are available, for example after a firmware update.</li> <li>Record the correction data by performing a self alignment (For details refer to <a href="#">Chapter 4.2.13, "Performing a self-alignment"</a>, on page 38).</li> </ul>	STATUS:QUESTIONABLE, bit 8



Keyword	Description	Bit in status register
"OLD CAL"	Calibration data outdated. Perform a new self-alignment.  Also displayed if <a href="#">Reuse Old Alignment Data</a> is enabled.  (For details refer to <a href="#">Chapter 4.2.13, "Performing a self-alignment"</a> , on page 38).	
"WRONG_FW"	The firmware version is out-of-date and does not support the currently installed hardware. Until the firmware version is updated, this error message is displayed and self-alignment fails.  (For details refer to <a href="#">Chapter 11.7.4, "Firmware updates"</a> , on page 790).	

## 14.2 Error messages in remote control mode

In remote control mode error messages are entered in the error/event queue of the status reporting system and can be queried with the command `SYSTEM:ERROR?`. The answer format of FSW to the command is as follows:

```
<error code>, "<error text with queue query>; <remote control command concerned>"
```

The indication of the remote control command with prefixed semicolon is optional.

### Example:

The command `TEST:COMMAND` generates the following answer to the query `SYSTEM:ERROR?`

```
-113, "Undefined header;TEST:COMMAND"
```

There are two types of error messages:

- Error messages defined by SCPI are marked by negative error codes. These messages are defined and described in the SCPI standard and not listed here.
- Device-specific error messages use positive error codes. These messages are described below.

**Table 14-3: Device-specific error messages**

Error code	Error text in the case of queue poll Error explanation
1006	<b>Failed to connect to server (code. 1006)</b> "LAN" web browser access to the instrument has been deactivated.
1052	<b>Frontend LO is Unlocked</b> This message is displayed when the phase regulation of the local oscillator fails in the RF front-end.

Error code	Error text in the case of queue poll Error explanation
1060	<b>Trigger-Block Gate Delay Error- gate length &lt; Gate Delay</b> This message is displayed when the gate signal length is not sufficient for the pull-in delay with a predefined gate delay.
1064	<b>Tracking LO is Unlocked</b> This message is displayed when the phase regulation of the local oscillator fails on the external generator module.
2028	<b>Hardcopy not possible during measurement sequence</b> This message is displayed when a printout is started during scan sequences that cannot be interrupted. Such sequences are for example: <ul style="list-style-type: none"> <li>• Recording the system error correction data (alignment)</li> <li>• Instrument self-test</li> </ul> In such cases synchronization to the end of the scan sequence should be performed prior to starting the printout.
2033	<b>Printer Not Available</b> This message is displayed when the selected printer is not included in the list of available output devices. A possible cause is that the required printer driver is missing or incorrectly installed.
2034	<b>CPU Temperature is too high</b> This message is displayed when the temperature of the processor exceeds 70 °C.

Table 14-4: Power Sensor errors

Status bar message	Description
Zeroing could not be performed	Zeroing could not be performed because the RF power applied is too high.
Power sensor zero failed	

## 14.3 Troubleshooting remote operation

If problems arise during measurement in remote operation, try the following methods to solve them.

### Incompleted sequential commands - blocked remote channels

If a sequential command cannot be completed, for example because a triggered sweep never receives a trigger, the remote control program will never finish and the remote channel to the FSW is blocked for further commands. In this case, you must interrupt processing on the remote channel in order to abort the measurement.

### To regain control over a blocked remote channel

Usually, if you wait a minute for the VISA connection to detect the lost connection and clear the control channel by itself, you can then re-establish the connection again. If this fails, try the following:

1. Press "Local" on the front panel of the FSW to return to manual operation (if not disabled). Then re-establish the connection.
2. Send a "Device Clear" command from the control instrument to the FSW to clear all currently active remote channels. Depending on the used interface and protocol, send the following commands:

- **Visa:** `viClear()`
- **GPIB:** `ibclr()`
- **RSIB:** `RSDLLibclr()`

The remote channel currently processing the incompleting command is then ready to receive further commands again.

3. On the remote channel performing the measurement, send the SCPI command `ABORT` to abort the current measurement and reset the trigger system.
4. If the FSW still does not react to the remote commands, switch it off and back on.

### Ignored commands

When a remote command attempts to define incompatible settings, the command is ignored and the instrument status remains unchanged, i.e. other settings are not automatically adapted. Therefore, control programs should always define an initial instrument status (e.g. using the `*RST` command) and then implement the required settings.

### Detecting false commands - log file

If a remote program does not provide the expected results and you are using a GPIB connection, you can log the commands and any errors that may occur. To activate the SCPI error log function, in the "Network + Remote" dialog box, in the "GPIB" tab, select "I/O Logging".

All remote control commands received by the FSW are recorded in log files with the following syntax:

```
C:\R_S\INSTR\ScpiLogging\ScpiLog.<xx>
```

where <xx> is a consecutive number, starting with 00;

A new file is created each time you stop and restart the logging function. The lowest available number is used for the <xx> extension.

Logging the commands may be extremely useful for debug purposes, e.g. in order to find misspelled keywords in control programs. However, remember to turn off the logging function after debugging to avoid unnecessary access to the hard drive and use of storage space.

**Interrupted VISA connection to FSW**

Sometimes, in combination with a certain LAN-switch (SMC Switch 210), the VISA remote connection to the FSW is interrupted. In this case, disable the power save mode for the network controller on the FSW.

1. On the FSW, open the Windows "Start" menu.
2. Search for the network connection properties.
3. On the "Power Management" tab, disable the power save option.

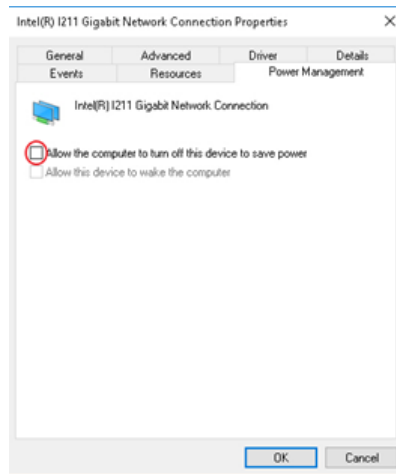

**14.4 Miscellaneous troubleshooting hints**

Power levels for low frequency signals not correct..... 1548

Invalid trace display..... 1548

Data capturing takes too long..... 1549

Multiple user access to one instrument..... 1549

Web browser access to instrument fails..... 1549

The transducer factors/limit lines applied to my measurement are different to those displayed in the Transducer/Lines dialog box..... 1549

**Power levels for low frequency signals not correct**

By default, the FSW uses AC coupling for RF input. For very low frequencies, the input signal may be distorted with this setting. In this case, use DC coupling instead. To change the setting, select "INPUT/OUPUT" > "Input Source Config > Radio Frequency > Input Coupling > DC".

**Invalid trace display**

If output to the "IF 2 GHz OUT" connector is activated, the measured values are no longer sent to the display; thus, the trace data currently displayed on the FSW becomes invalid. A message in the status bar indicates this situation.

**Data capturing takes too long**

Particularly for FFT sweeps, the time required to process the data may be considerably longer than the time required to capture the data. Thus, if you only consider the defined sweep time, you may assume an error has occurred if the measurement takes longer than expected.

However, while the sweep time only defines the time in which data is actually captured, the total sweep *duration* includes the time required for capturing *and processing* the data. Thus, for FFT sweeps in the Spectrum application, the sweep duration is now also indicated in the channel bar, behind the sweep time. In remote operation, the estimated sweep duration can be queried for all sweep modes (also zero span and frequency sweeps).

**Tip:** To determine the necessary timeout for data capturing in a remote control program, double the estimated time and add 1 second.

Remote command:

[SENSe:]SWEep:DURation? on page 1202

**Multiple user access to one instrument**

Using the FSW's web browser interface, several users can access *and operate* the same instrument simultaneously. This is useful for troubleshooting or training purposes.

Type the instrument's host name or IP address in the address field of the browser on your PC, for example "http://10.113.10.203". The instrument home page (welcome page) opens.

For details see [Chapter 12.1.1.1, "LAN web browser interface"](#), on page 819.

**Note:** This function can be deactivated for the instrument. After a firmware update, it is automatically activated again.

**Web browser access to instrument fails**

If an error message ("Failed to connect to server (code. 1006)") is displayed in the web browser instead of the instrument's user interface then the LAN web browser interface was probably deactivated.

For details see [Chapter 12.7.6, "How to deactivate the web browser interface"](#), on page 882).

**The transducer factors/limit lines applied to my measurement are different to those displayed in the Transducer/Lines dialog box**

If a transducer file was in use when the save set was stored (with the save item "Current Settings" only) it is anticipated that these transducer values should remain valid after every recall of that save set. Thus, even if the transducer file is changed and the original save set file is recalled later, the *originally stored* transducer values are recalled and applied to the measurement. In the "Transducer" dialog box, however, the *changed* transducer file values are displayed as no updated transducer file was loaded.

The same applies to limit line settings.

If you want to apply the changed transducer values after recalling the save set you must force the application to reload the transducer file. To do so, simply open the "Edit Transducer" dialog box (see [Chapter 11.4.2, "Transducer settings"](#), on page 756) and toggle the "X-Axis" option from "lin" to "log" and back. Due to that change, the transducer file is automatically reloaded, and the changed transducer values are applied to the current measurement. Now you can create a new save set with the updated transducer values.

Similarly, if you want to apply the changed limit values after recalling the save set you must force the application to reload the limit file. To do so, simply open the "Edit Limit Line" dialog box (see [Chapter 8.4.2.2, "Limit line settings and functions"](#), on page 597) and toggle the "Y-Axis" unit. Due to that change, the limit line file is automatically reloaded, and the changed limit values are applied to the current measurement. Now a new save set with the updated limit values can be created.

## 14.5 System recovery

The system drive of the FSW is delivered with a recovery partition that allows you to restore the original operating system image and firmware.

### To restore the original operating system image and firmware



1. Select the "Windows" icon in the toolbar, or press the "Windows" key or the [CTRL] + [ESC] key combination on the (external) keyboard.



2. Open the Windows "Settings".

3. Select "Update & Security" > "Recovery".

4. In the "Advanced Startup" section, select "Restart Now".

The "R&S Recovery Environment" starts.

5. In the "R&S Recovery Environment", select "Factory Default Restore".

The default image is restored.

6. Reboot the instrument.

After the default image is restored, upgrade to the desired firmware version (see [Chapter 11.7.4, "Firmware updates"](#), on page 790).

## 14.6 Collecting information for support

If problems occur, the instrument generates error messages which in most cases will be sufficient for you to detect the cause of an error and find a remedy.

Error messages are described in [Chapter 14.1, "Error information"](#), on page 1543.

In addition, our customer support centers are there to assist you in solving any problems that you may encounter with your FSW. We will find solutions more quickly and efficiently if you provide us with the information listed below.

- **Windows Event Log Files**

Windows records important actions of applications and the operating system in event logs. You can create event log files to summarize and save the existing event logs (see ["To create windows event log files"](#) on page 1551).

- **System Configuration:** The "System Configuration" dialog box (in the "Setup" menu) provides information on:
  - **Hardware Info:** hardware assemblies
  - **Versions and Options:** the status of all software and hardware options installed on your instrument
  - **System Messages:** messages on any errors that may have occurred

An .xml file with information on the system configuration ("Device Footprint") can be created automatically (using the `DIAGnostic:SERVICE:SINfo` command or as described in ["To collect the support information"](#) on page 1551).

- **Error Log:** The `RSError.log` file (in the `C:\Program Files (x86)\Rohde-Schwarz\FSW\<version>\log` directory) contains a chronological record of errors.
- **Support file:** a \*.zip file with important support information can be created automatically (in the `C:\Program Files (x86)\Rohde-Schwarz\FSW\<version>\user` directory). The \*.zip file contains the system configuration information ("Device Footprint"), the current eeprom data and a screenshot of the screen display. See also [Chapter 11.8.1, "R&S support information"](#), on page 796.
- **SCPI recorder output file** storing a manual operation sequence: helps customer support reproduce the problematic situation. See also [Chapter 12.5, "Automating tasks with remote command scripts"](#), on page 838.
- **SCPI recorder logging file:** contains all remote control commands received by the FSW. Helps solve problems in automated operation. See also ["I/O Logging"](#) on page 856.

### To collect the support information

1. Press [Setup].
2. Select "Service" > "R&S Support" and then "Create R&S Support Information".

The file is stored as

```
C:\R_S\INSTR\USER\  
<inst_model>_<serial-no>_<date_and_time>.zip
```

For example

```
C:\R_S\INSTR\USER\FSW-26_1312.8000K26-100005-xx_20150420_113652.zip
```

### To create windows event log files



1. Select the "Windows Start Button" in the bottom left corner.

2. Enter *Event Viewer* and select "Enter".
3. Select and expand "Windows Logs" in the "Console Tree".
4. Right-click on each subsection and select "Save All Events As...".

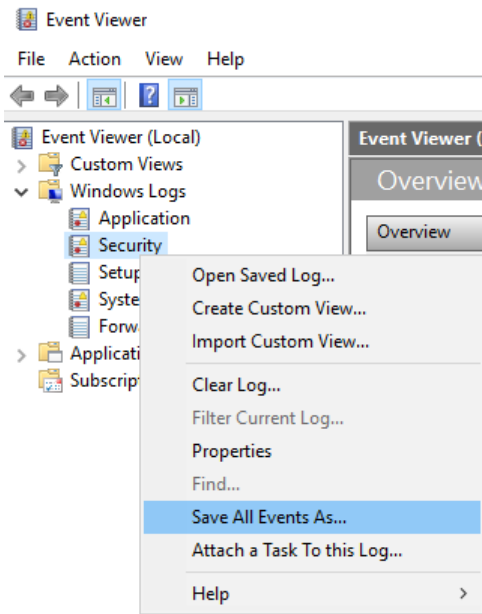

*Figure 14-1: Event Viewer*

5. Enter a file name and select "Save"

#### To capture a manual operation sequence

Using the SCPI recorder, you can record the SCPI command and settings value of each step you perform manually, and then save the commands to the file system.



1. On the toolbar, select the SCPI Recorder icon.  
The SCPI Recorder dialog box is displayed.
2. Select "Auto Recording": "On".  
From now on, the commands required to execute all steps you perform on the instrument are recorded.
3. To stop SCPI recording, select the SCPI Recorder icon again.  
The SCPI Recorder dialog box with the recorded command list is displayed.
4. Select "Auto Recording": "Off".
5. Save the recorded command list to a file.
  - a) Select "Save As".
  - b) Define a file name for the script file.



### To log received remote control commands on the instrument

1. Press [Setup].
2. Select "Network + Remote" > "GPIB" > "I/O Logging" > "On".
3. Run your remote control program.

The file with the received commands is stored as

C:\R\_S\INSTR\ScpiLogging\ScpiLog.<no.> on the instrument.

Where <no.> is a sequential number.

A new log file is started each time logging was stopped and is restarted.

Collect the error information and log files and attach them to an email in which you describe the problem. Send the email to the customer support address for your region as described in [Chapter 14.7, "Contacting customer support"](#), on page 1553.



### Packing and transporting the instrument

If the instrument needs to be transported or shipped, observe the notes described in [Chapter 15.3, "Transporting"](#), on page 1554.

## 14.7 Contacting customer support

### Technical support – where and when you need it

For quick, expert help with any Rohde & Schwarz product, contact our customer support center. A team of highly qualified engineers provides support and works with you to find a solution to your query on any aspect of the operation, programming or applications of Rohde & Schwarz products.

### Contact information

Contact our customer support center at [www.rohde-schwarz.com/support](http://www.rohde-schwarz.com/support), or follow this QR code:



Figure 14-2: QR code to the Rohde & Schwarz support page

# 15 Maintenance, storage, transport and disposal

The product does not require regular maintenance. It only requires occasional cleaning. It is however advisable to check the nominal data from time to time.

## 15.1 Cleaning

How to clean the product is described in "[Cleaning the product](#)" on page 19.

Do not use any liquids for cleaning. Cleaning agents, solvents, acids and bases can damage the front panel labeling, plastic parts and display.

## 15.2 Storage

Protect the product against dust. Ensure that the environmental conditions, e.g. temperature range and climatic load, meet the values specified in the specifications document.

## 15.3 Transporting

### Lifting and carrying

See:

- "[Lifting and carrying the product](#)" on page 18
- [Chapter 4.2.1, "Lifting and carrying"](#), on page 27.

### Packing

Use the original packaging material. It consists of antistatic wrap for electrostatic protection and packing material designed for the product.

If you do not have the original packaging, use similar materials that provide the same level of protection. You can also contact your local Rohde & Schwarz service center for advice.

### Securing

When moving the product in a vehicle or using transporting equipment, make sure that the product is properly secured. Only use items intended for securing objects.

### Transport altitude

The maximum transport altitude without pressure compensation is 4600 m above sea level.

## 15.4 Disposal

Rohde & Schwarz is committed to making careful, ecologically sound use of natural resources and minimizing the environmental footprint of our products. Help us by disposing of waste in a way that causes minimum environmental impact.

### Disposing of electrical and electronic equipment

A product that is labeled as follows cannot be disposed of in normal household waste after it has come to the end of its life. Even disposal via the municipal collection points for waste electrical and electronic equipment is not permitted.



*Figure 15-1: Labeling in line with EU directive WEEE*

Rohde & Schwarz has developed a disposal concept for the eco-friendly disposal or recycling of waste material. As a manufacturer, Rohde & Schwarz completely fulfills its obligation to take back and dispose of electrical and electronic waste. Contact your local service representative to dispose of the product.

## List of Commands (base unit)

[SENSe:]WINDow<n>:DETEctor<t>[:FUNCTION].....	1246
[SENSe:]WINDow<n>:DETEctor<t>[:FUNCTION]:AUTO.....	1247
[SENSe:]ADJust:ALL.....	1233
[SENSe:]ADJust:CONFigure:HYSTeresis:LOWer.....	1234
[SENSe:]ADJust:CONFigure:HYSTeresis:UPPer.....	1234
[SENSe:]ADJust:CONFigure:LEVel:DURation.....	1233
[SENSe:]ADJust:CONFigure:LEVel:DURation:MODE.....	1234
[SENSe:]ADJust:CONFigure:TRIGger.....	1235
[SENSe:]ADJust:FREQuency.....	1235
[SENSe:]ADJust:LEVel.....	1236
[SENSe:]AVERAge<n>:COUNT.....	1245
[SENSe:]AVERAge<n>:TYPE.....	1245
[SENSe:]AVERAge<n>[:STATe<t>].....	1245
[SENSe:]BANDwidth:VIDeo.....	1200
[SENSe:]BANDwidth:VIDeo:AUTO.....	1200
[SENSe:]BANDwidth:VIDeo:RATio.....	1200
[SENSe:]BANDwidth:VIDeo:TYPE.....	1201
[SENSe:]BANDwidth[:RESolution].....	1198
[SENSe:]BANDwidth[:RESolution]:AUTO.....	1198
[SENSe:]BANDwidth[:RESolution]:FFT.....	1206
[SENSe:]BANDwidth[:RESolution]:RATio.....	1199
[SENSe:]BANDwidth[:RESolution]:TYPE.....	1199
[SENSe:]BWIDth:VIDeo.....	1200
[SENSe:]BWIDth:VIDeo:AUTO.....	1200
[SENSe:]BWIDth:VIDeo:RATio.....	1200
[SENSe:]BWIDth:VIDeo:TYPE.....	1201
[SENSe:]BWIDth[:RESolution].....	1198
[SENSe:]BWIDth[:RESolution]:AUTO.....	1198
[SENSe:]BWIDth[:RESolution]:FFT.....	1206
[SENSe:]BWIDth[:RESolution]:RATio.....	1199
[SENSe:]BWIDth[:RESolution]:TYPE.....	1199
[SENSe:]CORRection:COLlect[:ACQuire].....	1172
[SENSe:]CORRection:CVL: BAND.....	1153
[SENSe:]CORRection:CVL:BIAS.....	1153
[SENSe:]CORRection:CVL:CATalog?.....	1154
[SENSe:]CORRection:CVL:CLEar.....	1154
[SENSe:]CORRection:CVL:COMMeNt.....	1154
[SENSe:]CORRection:CVL:DATA.....	1155
[SENSe:]CORRection:CVL:HARMonic.....	1155
[SENSe:]CORRection:CVL:MIXer.....	1155
[SENSe:]CORRection:CVL:PORTs.....	1156
[SENSe:]CORRection:CVL:SELEct.....	1156
[SENSe:]CORRection:CVL:SNUMber.....	1157
[SENSe:]CORRection:FRESponse<si>:BASEband:USER:ADJust:RLEVel:STATe.....	1409
[SENSe:]CORRection:FRESponse<si>:BASEband:USER:FLISt<fi>:REMOve.....	1412
[SENSe:]CORRection:FRESponse<si>:BASEband:USER:FLISt<fli>:CATalog?.....	1409
[SENSe:]CORRection:FRESponse<si>:BASEband:USER:FLISt<fli>:CLEar.....	1410

[SENSe:]CORRection:FRESponse<si>:BASEband:USER:FLISt<fli>:INSert.....	1410
[SENSe:]CORRection:FRESponse<si>:BASEband:USER:FLISt<fli>:MAGNitude[:STATe].....	1411
[SENSe:]CORRection:FRESponse<si>:BASEband:USER:FLISt<fli>:PHASe[:STATe].....	1412
[SENSe:]CORRection:FRESponse<si>:BASEband:USER:FLISt<fli>:SELEct.....	1413
[SENSe:]CORRection:FRESponse<si>:BASEband:USER:FLISt<fli>:SIZE?.....	1413
[SENSe:]CORRection:FRESponse<si>:BASEband:USER:LOAD.....	1414
[SENSe:]CORRection:FRESponse<si>:BASEband:USER:PRESet.....	1415
[SENSe:]CORRection:FRESponse<si>:BASEband:USER:REFResh.....	1415
[SENSe:]CORRection:FRESponse<si>:BASEband:USER:SLISt<sli>:CATalog?.....	1416
[SENSe:]CORRection:FRESponse<si>:BASEband:USER:SLISt<sli>:CLEar.....	1417
[SENSe:]CORRection:FRESponse<si>:BASEband:USER:SLISt<sli>:INSert.....	1418
[SENSe:]CORRection:FRESponse<si>:BASEband:USER:SLISt<sli>:MOVE.....	1418
[SENSe:]CORRection:FRESponse<si>:BASEband:USER:SLISt<sli>:PORTs:FROM.....	1419
[SENSe:]CORRection:FRESponse<si>:BASEband:USER:SLISt<sli>:PORTs:TO.....	1419
[SENSe:]CORRection:FRESponse<si>:BASEband:USER:SLISt<sli>:REMOve.....	1420
[SENSe:]CORRection:FRESponse<si>:BASEband:USER:SLISt<sli>:SELEct.....	1421
[SENSe:]CORRection:FRESponse<si>:BASEband:USER:SLISt<sli>:SIZE?.....	1421
[SENSe:]CORRection:FRESponse<si>:BASEband:USER:SLISt<sli>:STATe.....	1422
[SENSe:]CORRection:FRESponse<si>:BASEband:USER:STATe.....	1423
[SENSe:]CORRection:FRESponse<si>:BASEband:USER:STORE.....	1423
[SENSe:]CORRection:FRESponse<si>:FILE:USER:ADJust:RLEVel:STATe.....	1409
[SENSe:]CORRection:FRESponse<si>:INPut<ip>:USER:ADJust:RLEVel:STATe.....	1409
[SENSe:]CORRection:FRESponse<si>:INPut<ip>:USER:FLISt<fli>:CATalog?.....	1409
[SENSe:]CORRection:FRESponse<si>:INPut<ip>:USER:FLISt<fli>:CLEar.....	1410
[SENSe:]CORRection:FRESponse<si>:INPut<ip>:USER:FLISt<fli>:INSert.....	1410
[SENSe:]CORRection:FRESponse<si>:INPut<ip>:USER:FLISt<fli>:MAGNitude[:STATe].....	1411
[SENSe:]CORRection:FRESponse<si>:INPut<ip>:USER:FLISt<fli>:PHASe[:STATe].....	1412
[SENSe:]CORRection:FRESponse<si>:INPut<ip>:USER:FLISt<fli>:REMOve.....	1412
[SENSe:]CORRection:FRESponse<si>:INPut<ip>:USER:FLISt<fli>:SELEct.....	1413
[SENSe:]CORRection:FRESponse<si>:INPut<ip>:USER:FLISt<fli>:SIZE?.....	1413
[SENSe:]CORRection:FRESponse<si>:INPut<ip>:USER:LOAD.....	1414
[SENSe:]CORRection:FRESponse<si>:INPut<ip>:USER:PRESet.....	1415
[SENSe:]CORRection:FRESponse<si>:INPut<ip>:USER:REFResh.....	1415
[SENSe:]CORRection:FRESponse<si>:INPut<ip>:USER:SLISt<sli>:CATalog?.....	1416
[SENSe:]CORRection:FRESponse<si>:INPut<ip>:USER:SLISt<sli>:CLEar.....	1417
[SENSe:]CORRection:FRESponse<si>:INPut<ip>:USER:SLISt<sli>:INSert.....	1418
[SENSe:]CORRection:FRESponse<si>:INPut<ip>:USER:SLISt<sli>:MOVE.....	1418
[SENSe:]CORRection:FRESponse<si>:INPut<ip>:USER:SLISt<sli>:PORTs:FROM.....	1419
[SENSe:]CORRection:FRESponse<si>:INPut<ip>:USER:SLISt<sli>:PORTs:TO.....	1419
[SENSe:]CORRection:FRESponse<si>:INPut<ip>:USER:SLISt<sli>:REMOve.....	1420
[SENSe:]CORRection:FRESponse<si>:INPut<ip>:USER:SLISt<sli>:SELEct.....	1421
[SENSe:]CORRection:FRESponse<si>:INPut<ip>:USER:SLISt<sli>:SIZE?.....	1421
[SENSe:]CORRection:FRESponse<si>:INPut<ip>:USER:SLISt<sli>:STATe.....	1422
[SENSe:]CORRection:FRESponse<si>:INPut<ip>:USER:STATe.....	1423
[SENSe:]CORRection:FRESponse<si>:INPut<ip>:USER:STORE.....	1423
[SENSe:]CORRection:FRESponse<si>:USER:ADJust:RLEVel:STATe.....	1409
[SENSe:]CORRection:FRESponse<si>:USER:FLISt<fli>:CATalog?.....	1409
[SENSe:]CORRection:FRESponse<si>:USER:FLISt<fli>:CLEar.....	1410
[SENSe:]CORRection:FRESponse<si>:USER:FLISt<fli>:DATA:FREQuency?.....	1410
[SENSe:]CORRection:FRESponse<si>:USER:FLISt<fli>:DATA:MAGNitude?.....	1410

[SENSe:]CORRection:FRESponse<si>:USER:FLISt<fli>:DATA:PHASe?	1410
[SENSe:]CORRection:FRESponse<si>:USER:FLISt<fli>:INSert	1410
[SENSe:]CORRection:FRESponse<si>:USER:FLISt<fli>:MAGNitude[:STATe]	1411
[SENSe:]CORRection:FRESponse<si>:USER:FLISt<fli>:PHASe[:STATe]	1412
[SENSe:]CORRection:FRESponse<si>:USER:FLISt<fli>:REMOve	1412
[SENSe:]CORRection:FRESponse<si>:USER:FLISt<fli>:SELEct	1413
[SENSe:]CORRection:FRESponse<si>:USER:FLISt<fli>:SIZE?	1413
[SENSe:]CORRection:FRESponse<si>:USER:FSate	1413
[SENSe:]CORRection:FRESponse<si>:USER:IQ:DATA:FREQUency?	1414
[SENSe:]CORRection:FRESponse<si>:USER:IQ:DATA:MAGNitude?	1414
[SENSe:]CORRection:FRESponse<si>:USER:IQ:DATA:PHASe?	1414
[SENSe:]CORRection:FRESponse<si>:USER:LOAD	1414
[SENSe:]CORRection:FRESponse<si>:USER:PRESet	1415
[SENSe:]CORRection:FRESponse<si>:USER:PState	1420
[SENSe:]CORRection:FRESponse<si>:USER:SCOPE	1415
[SENSe:]CORRection:FRESponse<si>:USER:SCOVERed?	1416
[SENSe:]CORRection:FRESponse<si>:USER:SLISt<slI>:CATalog?	1416
[SENSe:]CORRection:FRESponse<si>:USER:SLISt<slI>:CLEar	1417
[SENSe:]CORRection:FRESponse<si>:USER:SLISt<slI>:DATA:FREQUency<spi>?	1417
[SENSe:]CORRection:FRESponse<si>:USER:SLISt<slI>:DATA:MAGNitude<spi>?	1417
[SENSe:]CORRection:FRESponse<si>:USER:SLISt<slI>:DATA:PHASe<spi>?	1417
[SENSe:]CORRection:FRESponse<si>:USER:SLISt<slI>:INSert	1418
[SENSe:]CORRection:FRESponse<si>:USER:SLISt<slI>:MOVE	1418
[SENSe:]CORRection:FRESponse<si>:USER:SLISt<slI>:PORTs:FROM	1419
[SENSe:]CORRection:FRESponse<si>:USER:SLISt<slI>:PORTs:TO	1419
[SENSe:]CORRection:FRESponse<si>:USER:SLISt<slI>:REMOve	1420
[SENSe:]CORRection:FRESponse<si>:USER:SLISt<slI>:SELEct	1421
[SENSe:]CORRection:FRESponse<si>:USER:SLISt<slI>:SIZE?	1421
[SENSe:]CORRection:FRESponse<si>:USER:SLISt<slI>:STATE	1422
[SENSe:]CORRection:FRESponse<si>:USER:SPECTrum:DATA:FREQUency?	1422
[SENSe:]CORRection:FRESponse<si>:USER:SPECTrum:DATA:MAGNitude?	1422
[SENSe:]CORRection:FRESponse<si>:USER:SPECTrum:DATA:PHASe?	1422
[SENSe:]CORRection:FRESponse<si>:USER:STATE	1423
[SENSe:]CORRection:FRESponse<si>:USER:STORE	1423
[SENSe:]CORRection:FRESponse<si>:USER:VALId?	1424
[SENSe:]CORRection:METHod	1173
[SENSe:]CORRection:RECall	1173
[SENSe:]CORRection:TRANsdUcer:ADJust:RLEVel[:STATe]	1402
[SENSe:]CORRection:TRANsdUcer:CATalog?	1403
[SENSe:]CORRection:TRANsdUcer:COMMeNt	1403
[SENSe:]CORRection:TRANsdUcer:DATA	1403
[SENSe:]CORRection:TRANsdUcer:DELeTe	1404
[SENSe:]CORRection:TRANsdUcer:GENerate	1174
[SENSe:]CORRection:TRANsdUcer:SCALIng	1404
[SENSe:]CORRection:TRANsdUcer:SELEct	1404
[SENSe:]CORRection:TRANsdUcer:UNIT	1405
[SENSe:]CORRection:TRANsdUcer[:STATe]	1405
[SENSe:]CORRection[:STATe]	1174
[SENSe:]DEMod:SQUelch:LEVel	1318
[SENSe:]DEMod:SQUelch[:STATe]	1319

[SENSe:]EFRontend:ALIGnment<ch>:FILE.....	1125
[SENSe:]EFRontend:ALIGnment<ch>:STATe.....	1125
[SENSe:]EFRontend:CONNection:CONFig.....	1116
[SENSe:]EFRontend:CONNection:CState?.....	1117
[SENSe:]EFRontend:CONNection[:STATe].....	1116
[SENSe:]EFRontend:FREQuency:BAND:COUNT?.....	1117
[SENSe:]EFRontend:FREQuency:BAND<b>:LOWer?.....	1117
[SENSe:]EFRontend:FREQuency:BAND<b>:UPPer?.....	1118
[SENSe:]EFRontend:FREQuency:BCONfig:AUTO.....	1118
[SENSe:]EFRontend:FREQuency:BCONfig:LIST?.....	1119
[SENSe:]EFRontend:FREQuency:BCONfig:SElect.....	1119
[SENSe:]EFRontend:FREQuency:IFREquency:MAXimum?.....	1120
[SENSe:]EFRontend:FREQuency:IFREquency:MINimum?.....	1120
[SENSe:]EFRontend:FREQuency:IFREquency:SIDeband?.....	1120
[SENSe:]EFRontend:FREQuency:IFREquency[:VALue]?.....	1121
[SENSe:]EFRontend:FREQuency:LOSCillator:INPut:FREQuency?.....	1121
[SENSe:]EFRontend:FREQuency:LOSCillator:MODE.....	1121
[SENSe:]EFRontend:FREQuency:LOSCillator:OUTPut:FREQuency?.....	1122
[SENSe:]EFRontend:FREQuency:LOSCillator:OUTPut:STATe.....	1122
[SENSe:]EFRontend:FREQuency:REFerence.....	1123
[SENSe:]EFRontend:FREQuency:REFerence:LIST?.....	1123
[SENSe:]EFRontend:FWUPdate.....	1126
[SENSe:]EFRontend:IDN?.....	1123
[SENSe:]EFRontend:NETWork.....	1123
[SENSe:]EFRontend[:CHANnel<ch>]:EXTDevice<di>:CORRection:FILE.....	1127
[SENSe:]EFRontend[:CHANnel<ch>]:EXTDevice<di>:CORRection:STATe.....	1127
[SENSe:]EFRontend[:CHANnel<ch>]:EXTDevice<di>:CORRection:VALid?.....	1128
[SENSe:]EFRontend[:CHANnel<ch>]:EXTDevice<di>:FREQuency:MAXimum?.....	1129
[SENSe:]EFRontend[:CHANnel<ch>]:EXTDevice<di>:FREQuency:MINimum?.....	1130
[SENSe:]EFRontend[:CHANnel<ch>]:EXTDevice<di>:GAIN?.....	1130
[SENSe:]EFRontend[:CHANnel<ch>]:EXTDevice<di>:LIST?.....	1128
[SENSe:]EFRontend[:CHANnel<ch>]:EXTDevice<di>:NAME?.....	1130
[SENSe:]EFRontend[:CHANnel<ch>]:EXTDevice<di>:REFResh.....	1129
[SENSe:]EFRontend[:CHANnel<ch>]:EXTDevice<di>:TYPE?.....	1131
[SENSe:]EFRontend[:STATe].....	1124
[SENSe:]EFRontend<fe>:SELFtest:RESult?.....	1126
[SENSe:]EFRontend<fe>:SELFtest?.....	1126
[SENSe:]ESPepectrum<sb>:BWID.....	1018
[SENSe:]ESPepectrum<sb>:FILTer[:RRC]:ALPHA.....	1018
[SENSe:]ESPepectrum<sb>:FILTer[:RRC][:STATe].....	1018
[SENSe:]ESPepectrum<sb>:HSPeed.....	1002
[SENSe:]ESPepectrum<sb>:MSR:APPLy.....	1025
[SENSe:]ESPepectrum<sb>:MSR:BAND.....	1025
[SENSe:]ESPepectrum<sb>:MSR:BCATegory.....	1026
[SENSe:]ESPepectrum<sb>:MSR:CLASs.....	1027
[SENSe:]ESPepectrum<sb>:MSR:GSM:CARRier.....	1027
[SENSe:]ESPepectrum<sb>:MSR:GSM:CPResent.....	1028
[SENSe:]ESPepectrum<sb>:MSR:LTE:CPResent.....	1029
[SENSe:]ESPepectrum<sb>:MSR:MPower.....	1029
[SENSe:]ESPepectrum<sb>:MSR:RFBWidth.....	1030

[SENSe:]ESpectrum<sb>:PRESet:RESTore.....	999
[SENSe:]ESpectrum<sb>:PRESet:STORe.....	999
[SENSe:]ESpectrum<sb>:PRESet[:STANdard].....	999
[SENSe:]ESpectrum<sb>:RANGe<ri>:BANDwidth:RESolution.....	1003
[SENSe:]ESpectrum<sb>:RANGe<ri>:BANDwidth:VIDeo.....	1003
[SENSe:]ESpectrum<sb>:RANGe<ri>:COUNt?.....	1004
[SENSe:]ESpectrum<sb>:RANGe<ri>:DELete.....	1004
[SENSe:]ESpectrum<sb>:RANGe<ri>:FILTer:TYPE.....	1004
[SENSe:]ESpectrum<sb>:RANGe<ri>:INPut:ATTenuation.....	1006
[SENSe:]ESpectrum<sb>:RANGe<ri>:INPut:ATTenuation:AUTO.....	1006
[SENSe:]ESpectrum<sb>:RANGe<ri>:INPut:GAIN:STATe.....	1007
[SENSe:]ESpectrum<sb>:RANGe<ri>:INPut:GAIN[:VALue].....	1007
[SENSe:]ESpectrum<sb>:RANGe<ri>:INPut:SANalyzer:ATTenuation.....	1008
[SENSe:]ESpectrum<sb>:RANGe<ri>:INPut:SANalyzer:ATTenuation:AUTO.....	1008
[SENSe:]ESpectrum<sb>:RANGe<ri>:INSert.....	1009
[SENSe:]ESpectrum<sb>:RANGe<ri>:LIMit<li>:ABSolute:START.....	1009
[SENSe:]ESpectrum<sb>:RANGe<ri>:LIMit<li>:ABSolute:STOP.....	1010
[SENSe:]ESpectrum<sb>:RANGe<ri>:LIMit<li>:RELative:START.....	1010
[SENSe:]ESpectrum<sb>:RANGe<ri>:LIMit<li>:RELative:START:ABS.....	1011
[SENSe:]ESpectrum<sb>:RANGe<ri>:LIMit<li>:RELative:START:FUNCTION.....	1011
[SENSe:]ESpectrum<sb>:RANGe<ri>:LIMit<li>:RELative:STOP.....	1012
[SENSe:]ESpectrum<sb>:RANGe<ri>:LIMit<li>:RELative:STOP:ABS.....	1013
[SENSe:]ESpectrum<sb>:RANGe<ri>:LIMit<li>:RELative:STOP:FUNCTION.....	1013
[SENSe:]ESpectrum<sb>:RANGe<ri>:LIMit<li>:STATe.....	1014
[SENSe:]ESpectrum<sb>:RANGe<ri>:MLCalc.....	1015
[SENSe:]ESpectrum<sb>:RANGe<ri>:POINTs:MINimum[:VALue].....	1015
[SENSe:]ESpectrum<sb>:RANGe<ri>:RLEVel.....	1015
[SENSe:]ESpectrum<sb>:RANGe<ri>:SWEep:TIME.....	1016
[SENSe:]ESpectrum<sb>:RANGe<ri>:SWEep:TIME:AUTO.....	1016
[SENSe:]ESpectrum<sb>:RANGe<ri>:TRANsducer.....	1017
[SENSe:]ESpectrum<sb>:RANGe<ri>[:FREQUency]:START.....	1005
[SENSe:]ESpectrum<sb>:RANGe<ri>[:FREQUency]:STOP.....	1006
[SENSe:]ESpectrum<sb>:RRANGe?.....	1019
[SENSe:]ESpectrum<sb>:RTYPE.....	1019
[SENSe:]ESpectrum<sb>:SBCenter.....	1527
[SENSe:]ESpectrum<sb>:SBCount.....	1528
[SENSe:]ESpectrum<sb>:SCENter.....	1001
[SENSe:]ESpectrum<sb>:SCOUNt.....	1001
[SENSe:]ESpectrum<sb>:SSETup.....	1017
[SENSe:]FREQUency:ANNotation.....	1191
[SENSe:]FREQUency:CENTer.....	1192
[SENSe:]FREQUency:CENTer:STEP.....	1193
[SENSe:]FREQUency:CENTer:STEP:AUTO.....	1193
[SENSe:]FREQUency:CENTer:STEP:LINK.....	1193
[SENSe:]FREQUency:CENTer:STEP:LINK:FACTor.....	1194
[SENSe:]FREQUency:OFFSet.....	1194
[SENSe:]FREQUency:SPAN.....	1194
[SENSe:]FREQUency:SPAN:FULL.....	1195
[SENSe:]FREQUency:START.....	1195
[SENSe:]FREQUency:STOP.....	1195



[SENSe:]LIST:POWer:RESult?	1090
[SENSe:]LIST:POWer:SET	1091
[SENSe:]LIST:POWer:STATe	1092
[SENSe:]LIST:POWer[:SEQuence]	1090
[SENSe:]LIST:RANGe<ri>:BANDwidth:RESolution	1037
[SENSe:]LIST:RANGe<ri>:BANDwidth:VIDeo	1037
[SENSe:]LIST:RANGe<ri>:BREak	1037
[SENSe:]LIST:RANGe<ri>:COUNT?	1038
[SENSe:]LIST:RANGe<ri>:DELeTe	1038
[SENSe:]LIST:RANGe<ri>:DETEctor	1038
[SENSe:]LIST:RANGe<ri>:FILTer:TYPE	1040
[SENSe:]LIST:RANGe<ri>:INPut:ATTenuation	1041
[SENSe:]LIST:RANGe<ri>:INPut:ATTenuation:AUTO	1041
[SENSe:]LIST:RANGe<ri>:INPut:GAIN:STATe	1041
[SENSe:]LIST:RANGe<ri>:INPut:GAIN[:VALue]	1042
[SENSe:]LIST:RANGe<ri>:INPut:SANalyzer:ATTenuation	1042
[SENSe:]LIST:RANGe<ri>:INPut:SANalyzer:ATTenuation:AUTO	1042
[SENSe:]LIST:RANGe<ri>:LIMit:START	1043
[SENSe:]LIST:RANGe<ri>:LIMit:STATe	1043
[SENSe:]LIST:RANGe<ri>:LIMit:STOP	1044
[SENSe:]LIST:RANGe<ri>:POINts[:VALue]	1044
[SENSe:]LIST:RANGe<ri>:RLEVel	1044
[SENSe:]LIST:RANGe<ri>:SWEp:TIME	1045
[SENSe:]LIST:RANGe<ri>:SWEp:TIME:AUTO	1045
[SENSe:]LIST:RANGe<ri>:TRANsducer	1045
[SENSe:]LIST:RANGe<ri>[:FREQuency]:START	1039
[SENSe:]LIST:RANGe<ri>[:FREQuency]:STOP	1039
[SENSe:]LIST:XADJust	1048
[SENSe:]MIXer<x>:BIAS:HIGH	1144
[SENSe:]MIXer<x>:BIAS[:LOW]	1145
[SENSe:]MIXer<x>:FREQuency:HANDover	1147
[SENSe:]MIXer<x>:FREQuency:START	1147
[SENSe:]MIXer<x>:FREQuency:STOP	1147
[SENSe:]MIXer<x>:HARMonic:BAND	1148
[SENSe:]MIXer<x>:HARMonic:BAND:PRESet	1148
[SENSe:]MIXer<x>:HARMonic:HIGH:STATe	1149
[SENSe:]MIXer<x>:HARMonic:HIGH[:VALue]	1149
[SENSe:]MIXer<x>:HARMonic:TYPE	1149
[SENSe:]MIXer<x>:HARMonic[:LOW]	1150
[SENSe:]MIXer<x>:IF?	1150
[SENSe:]MIXer<x>:LOPower	1145
[SENSe:]MIXer<x>:LOSS:HIGH	1150
[SENSe:]MIXer<x>:LOSS:TABLE:HIGH	1151
[SENSe:]MIXer<x>:LOSS:TABLE[:LOW]	1151
[SENSe:]MIXer<x>:LOSS[:LOW]	1152
[SENSe:]MIXer<x>:PORTs	1152
[SENSe:]MIXer<x>:RFOVerrange[:STATe]	1152
[SENSe:]MIXer<x>:SIGNal	1145
[SENSe:]MIXer<x>:THReshold	1146
[SENSe:]MIXer<x>[:STATe]	1144

[SENSe:]MPOWer:FTYPE.....	1095
[SENSe:]MPOWer:RESult:MIN?.....	1097
[SENSe:]MPOWer:RESult[:LIST]?.....	1096
[SENSe:]MPOWer[:SEQuence].....	1096
[SENSe:]NPRatio:CHANnel:BWIDth.....	982
[SENSe:]NPRatio:CHANnel:INTegration:AUTO.....	983
[SENSe:]NPRatio:CHANnel:INTegration:BWIDth.....	983
[SENSe:]NPRatio:CHANnel:INTegration:FREQuency:OFFSet.....	984
[SENSe:]NPRatio:MODE.....	984
[SENSe:]NPRatio:NOTCh<notch>:BWIDth:RELative.....	984
[SENSe:]NPRatio:NOTCh<notch>:BWIDth[:ABSolute].....	985
[SENSe:]NPRatio:NOTCh<notch>:COUNT.....	985
[SENSe:]NPRatio:NOTCh<notch>:FREQuency:OFFSet.....	985
[SENSe:]NPRatio:STATe.....	982
[SENSe:]PMETer<p>:DCYCLe:VALue.....	1180
[SENSe:]PMETer<p>:DCYCLe[:STATe].....	1180
[SENSe:]PMETer<p>:FREQuency.....	1181
[SENSe:]PMETer<p>:FREQuency:LINK.....	1181
[SENSe:]PMETer<p>:MTIME.....	1181
[SENSe:]PMETer<p>:MTIME:AVERAge:COUNT.....	1182
[SENSe:]PMETer<p>:MTIME:AVERAge[:STATe].....	1182
[SENSe:]PMETer<p>:ROFFset[:STATe].....	1182
[SENSe:]PMETer<p>:SOFFset.....	1183
[SENSe:]PMETer<p>:TRIGGer:DTIME.....	1185
[SENSe:]PMETer<p>:TRIGGer:HOLDoff.....	1185
[SENSe:]PMETer<p>:TRIGGer:HYSTeresis.....	1185
[SENSe:]PMETer<p>:TRIGGer:LEVel.....	1186
[SENSe:]PMETer<p>:TRIGGer:SLOPe.....	1186
[SENSe:]PMETer<p>:TRIGGer[:STATe].....	1186
[SENSe:]PMETer<p>:UPDate[:STATe].....	1183
[SENSe:]PMETer<p>[:STATe].....	1183
[SENSe:]POWer:ACHannel:ACPairs.....	918
[SENSe:]POWer:ACHannel:AGCHannels.....	946
[SENSe:]POWer:ACHannel:BANdwidth:ACHannel.....	918
[SENSe:]POWer:ACHannel:BANdwidth:ALTErnate<ch>.....	919
[SENSe:]POWer:ACHannel:BANdwidth:GAP<gap>:MANual:LOWer.....	960
[SENSe:]POWer:ACHannel:BANdwidth:GAP<gap>:MANual:UPPer.....	961
[SENSe:]POWer:ACHannel:BANdwidth:GAP<gap>[:AUTO].....	950
[SENSe:]POWer:ACHannel:BANdwidth:UACHannel.....	944
[SENSe:]POWer:ACHannel:BANdwidth:UALTErnate<ch>.....	944
[SENSe:]POWer:ACHannel:BANdwidth[:CHANnel<ch>].....	919
[SENSe:]POWer:ACHannel:BWIDth:ACHannel.....	918
[SENSe:]POWer:ACHannel:BWIDth:ALTErnate<ch>.....	919
[SENSe:]POWer:ACHannel:BWIDth:GAP<gap>:MANual:LOWer.....	960
[SENSe:]POWer:ACHannel:BWIDth:GAP<gap>:MANual:UPPer.....	961
[SENSe:]POWer:ACHannel:BWIDth:GAP<gap>[:AUTO].....	950
[SENSe:]POWer:ACHannel:BWIDth:UACHannel.....	944
[SENSe:]POWer:ACHannel:BWIDth:UALTErnate<ch>.....	944
[SENSe:]POWer:ACHannel:BWIDth[:CHANnel<ch>].....	919
[SENSe:]POWer:ACHannel:FILTer:ALPHa:ACHannel.....	922

[SENSe:]POWer:ACHannel:FILTer:ALPHa:ALTErnate<ch>.....	922
[SENSe:]POWer:ACHannel:FILTer:ALPHa:CHANnel<ch>.....	923
[SENSe:]POWer:ACHannel:FILTer:ALPHa:GAP<gap>:MANual:LOWer.....	963
[SENSe:]POWer:ACHannel:FILTer:ALPHa:GAP<gap>:MANual:UPPer.....	963
[SENSe:]POWer:ACHannel:FILTer:ALPHa:GAP<gap>[:AUTO].....	950
[SENSe:]POWer:ACHannel:FILTer:ALPHa:SBLock<sb>:CHANnel<ch>.....	939
[SENSe:]POWer:ACHannel:FILTer:ALPHa:UACHannel.....	945
[SENSe:]POWer:ACHannel:FILTer:ALPHa:UALTErnate<ch>.....	945
[SENSe:]POWer:ACHannel:FILTer:ALPHa[:ALL].....	922
[SENSe:]POWer:ACHannel:FILTer[:STATe]:ACHannel.....	923
[SENSe:]POWer:ACHannel:FILTer[:STATe]:ALTErnate<ch>.....	924
[SENSe:]POWer:ACHannel:FILTer[:STATe]:CHANnel<ch>.....	924
[SENSe:]POWer:ACHannel:FILTer[:STATe]:GAP<gap>:MANual:LOWer.....	961
[SENSe:]POWer:ACHannel:FILTer[:STATe]:GAP<gap>:MANual:UPPer.....	962
[SENSe:]POWer:ACHannel:FILTer[:STATe]:GAP<gap>[:AUTO].....	951
[SENSe:]POWer:ACHannel:FILTer[:STATe]:SBLock<sb>:CHANnel<ch>.....	939
[SENSe:]POWer:ACHannel:FILTer[:STATe]:UACHannel.....	945
[SENSe:]POWer:ACHannel:FILTer[:STATe]:UALTErnate<ch>.....	945
[SENSe:]POWer:ACHannel:FILTer[:STATe][:ALL].....	923
[SENSe:]POWer:ACHannel:GAP<gap>:MODE.....	946
[SENSe:]POWer:ACHannel:GAP<gap>[:AUTO]:MSIZe.....	951
[SENSe:]POWer:ACHannel:GCHannel[:STATe]:GAP<gap>:MANual:LOWer.....	964
[SENSe:]POWer:ACHannel:GCHannel[:STATe]:GAP<gap>:MANual:UPPer.....	964
[SENSe:]POWer:ACHannel:MODE.....	971
[SENSe:]POWer:ACHannel:NAME:ACHannel.....	919
[SENSe:]POWer:ACHannel:NAME:ALTErnate<ch>.....	920
[SENSe:]POWer:ACHannel:NAME:CHANnel<ch>.....	920
[SENSe:]POWer:ACHannel:NAME:GAP<gap>.....	966
[SENSe:]POWer:ACHannel:NAME:UACHannel.....	966
[SENSe:]POWer:ACHannel:NAME:UALTErnate<ch>.....	967
[SENSe:]POWer:ACHannel:PRESet.....	914
[SENSe:]POWer:ACHannel:PRESet:RLEVel.....	915
[SENSe:]POWer:ACHannel:REFerence:AUTO ONCE.....	924
[SENSe:]POWer:ACHannel:REFerence:TXCHannel:AUTO.....	925
[SENSe:]POWer:ACHannel:REFerence:TXCHannel:MANual.....	925
[SENSe:]POWer:ACHannel:SBCount.....	939
[SENSe:]POWer:ACHannel:SBLock<sb>:BANDwidth[:CHANnel<ch>].....	940
[SENSe:]POWer:ACHannel:SBLock<sb>:BWIDth[:CHANnel<ch>].....	940
[SENSe:]POWer:ACHannel:SBLock<sb>:CENTer[:CHANnel<ch>].....	940
[SENSe:]POWer:ACHannel:SBLock<sb>:FREQuency:CENTer.....	941
[SENSe:]POWer:ACHannel:SBLock<sb>:NAME[:CHANnel<ch>].....	967
[SENSe:]POWer:ACHannel:SBLock<sb>:RFBWidth.....	941
[SENSe:]POWer:ACHannel:SBLock<sb>:TECHnology[:CHANnel<ch>].....	942
[SENSe:]POWer:ACHannel:SBLock<sb>:TXCHannel:COUNT.....	942
[SENSe:]POWer:ACHannel:SPACing:ALTErnate<ch>.....	921
[SENSe:]POWer:ACHannel:SPACing:CHANnel<ch>.....	921
[SENSe:]POWer:ACHannel:SPACing:GAP<gap>:MANual:LOWer.....	965
[SENSe:]POWer:ACHannel:SPACing:GAP<gap>:MANual:UPPer.....	965
[SENSe:]POWer:ACHannel:SPACing:GAP<gap>[:AUTO].....	951
[SENSe:]POWer:ACHannel:SPACing:UACHannel.....	943

[SENSe:]POWer:ACHannel:SPACing:UALTernate<ch>.....	943
[SENSe:]POWer:ACHannel:SPACing[:ACHannel].....	920
[SENSe:]POWer:ACHannel:SSEtup.....	943
[SENSe:]POWer:ACHannel:TXCHannel:COUNT.....	922
[SENSe:]POWer:BANDwidth.....	981
[SENSe:]POWer:BWIDth.....	981
[SENSe:]POWer:HSPeed.....	937
[SENSe:]POWer:NCORrection.....	1208
[SENSe:]POWer:TRACe.....	915
[SENSe:]PROBe<pb>:ID:PARTnumber?.....	1159
[SENSe:]PROBe<pb>:ID:SRNumber?.....	1160
[SENSe:]PROBe<pb>:SEtup:ATTRatio.....	1160
[SENSe:]PROBe<pb>:SEtup:CMOFFset.....	1161
[SENSe:]PROBe<pb>:SEtup:DMOFFset.....	1161
[SENSe:]PROBe<pb>:SEtup:MODE.....	1162
[SENSe:]PROBe<pb>:SEtup:NAME?.....	1162
[SENSe:]PROBe<pb>:SEtup:NMOFFset.....	1162
[SENSe:]PROBe<pb>:SEtup:PMODE.....	1163
[SENSe:]PROBe<pb>:SEtup:PMOFFset.....	1164
[SENSe:]PROBe<pb>:SEtup:STATe?.....	1164
[SENSe:]PROBe<pb>:SEtup:TYPE?.....	1164
[SENSe:]ROSCillator:EXTernal:FALLback.....	1390
[SENSe:]ROSCillator:LBWidth.....	1389
[SENSe:]ROSCillator:O100.....	1390
[SENSe:]ROSCillator:O640.....	1390
[SENSe:]ROSCillator:OSYNc.....	1391
[SENSe:]ROSCillator:SOURce.....	1391
[SENSe:]ROSCillator:SOURce:EAUTO?.....	1392
[SENSe:]ROSCillator:TRANge.....	1393
[SENSe:]SWEep:COUNT.....	1202
[SENSe:]SWEep:COUNT:CURRent?.....	911
[SENSe:]SWEep:DURation?.....	1202
[SENSe:]SWEep:EGATe.....	1224
[SENSe:]SWEep:EGATe:AUTO.....	1225
[SENSe:]SWEep:EGATe:CONTInuous:PCOunt.....	1225
[SENSe:]SWEep:EGATe:CONTInuous:PLENght.....	1225
[SENSe:]SWEep:EGATe:CONTInuous[:STATe].....	1226
[SENSe:]SWEep:EGATe:HOLDoff.....	1226
[SENSe:]SWEep:EGATe:LENGth.....	1226
[SENSe:]SWEep:EGATe:LEVel:IFPower.....	1227
[SENSe:]SWEep:EGATe:LEVel:RFPower.....	1228
[SENSe:]SWEep:EGATe:LEVel[:EXTernal<tp>].....	1227
[SENSe:]SWEep:EGATe:POLarity.....	1228
[SENSe:]SWEep:EGATe:SOURce.....	1228
[SENSe:]SWEep:EGATe:TRACe<t>:COMMeNt.....	1053
[SENSe:]SWEep:EGATe:TRACe<t>:PERiod.....	1054
[SENSe:]SWEep:EGATe:TRACe<t>:STARt<gr>.....	1054
[SENSe:]SWEep:EGATe:TRACe<t>:STOP<gr>.....	1055
[SENSe:]SWEep:EGATe:TRACe<t>[:STATe<gr>].....	1055
[SENSe:]SWEep:EGATe:TYPE.....	1229

[SENSe:]SWEep:FFTSubspan?.....	1202
[SENSe:]SWEep:MODE.....	1000
[SENSe:]SWEep:OPTimize.....	1203
[SENSe:]SWEep:TIME.....	1204
[SENSe:]SWEep:TIME:AUTO.....	1205
[SENSe:]SWEep:TYPE.....	1205
[SENSe:]SWEep:TYPE:USED.....	1205
[SENSe:]SWEep[:WINDow<n>]:POINts.....	1204
*CAL?.....	893
*CLS.....	893
*ESE.....	893
*ESR?.....	893
*IDN?.....	894
*IST?.....	894
*OPC.....	894
*OPT?.....	894
*PCB.....	895
*PRE.....	895
*PSC.....	895
*RST.....	896
*SRE.....	896
*STB?.....	896
*TRG.....	896
*TST?.....	896
*WAI.....	897
ABORT.....	908
CALCulate<n>:DELTamarker<m>:AOFF.....	1268
CALCulate<n>:DELTamarker<m>:FUNctIon:BPOwer:MODE.....	1310
CALCulate<n>:DELTamarker<m>:FUNctIon:BPOwer:RESult?.....	1310
CALCulate<n>:DELTamarker<m>:FUNctIon:BPOwer:SPAN.....	1311
CALCulate<n>:DELTamarker<m>:FUNctIon:BPOwer[:STATe].....	1311
CALCulate<n>:DELTamarker<m>:FUNctIon:FIXed:RPOint:MAXimum[:PEAK].....	1298
CALCulate<n>:DELTamarker<m>:FUNctIon:FIXed:RPOint:X.....	1298
CALCulate<n>:DELTamarker<m>:FUNctIon:FIXed:RPOint:Y.....	1299
CALCulate<n>:DELTamarker<m>:FUNctIon:FIXed:RPOint:Y:OFFSet.....	1299
CALCulate<n>:DELTamarker<m>:FUNctIon:FIXed[:STATe].....	1299
CALCulate<n>:DELTamarker<m>:FUNctIon:FMEasurement:DETEctor.....	1081
CALCulate<n>:DELTamarker<m>:FUNctIon:FMEasurement:DWELI.....	1083
CALCulate<n>:DELTamarker<m>:FUNctIon:FMEasurement:LIMit<i>:LCONDition?.....	1086
CALCulate<n>:DELTamarker<m>:FUNctIon:FMEasurement:LIMit<i>:LDELta?.....	1086
CALCulate<n>:DELTamarker<m>:FUNctIon:FMEasurement:PEAKsearch:AUTO.....	1083
CALCulate<n>:DELTamarker<m>:FUNctIon:FMEasurement:PSEArch:AUTO.....	1082
CALCulate<n>:DELTamarker<m>:FUNctIon:FMEasurement:RESult?.....	1085
CALCulate<n>:DELTamarker<m>:FUNctIon:FMEasurement[:STATe].....	1081
CALCulate<n>:DELTamarker<m>:FUNctIon:PNOise:AUTO.....	1305
CALCulate<n>:DELTamarker<m>:FUNctIon:PNOise:RESult?.....	1305
CALCulate<n>:DELTamarker<m>:FUNctIon:PNOise[:STATe].....	1306
CALCulate<n>:DELTamarker<m>:LINK.....	1269
CALCulate<n>:DELTamarker<m>:MAXimum:LEFT.....	1285
CALCulate<n>:DELTamarker<m>:MAXimum:NEXT.....	1285

CALCulate<n>:DELTamarker<m>:MAXimum:RIGHT.....	1286
CALCulate<n>:DELTamarker<m>:MAXimum[:PEAK].....	1285
CALCulate<n>:DELTamarker<m>:MINimum:LEFT.....	1286
CALCulate<n>:DELTamarker<m>:MINimum:NEXT.....	1286
CALCulate<n>:DELTamarker<m>:MINimum:RIGHT.....	1287
CALCulate<n>:DELTamarker<m>:MINimum[:PEAK].....	1286
CALCulate<n>:DELTamarker<m>:MODE.....	1271
CALCulate<n>:DELTamarker<m>:MREference.....	1271
CALCulate<n>:DELTamarker<m>:SGRam:FRAME.....	1294
CALCulate<n>:DELTamarker<m>:SGRam:SARea.....	1295
CALCulate<n>:DELTamarker<m>:SGRam:XY:MAXimum[:PEAK].....	1295
CALCulate<n>:DELTamarker<m>:SGRam:XY:MINimum[:PEAK].....	1295
CALCulate<n>:DELTamarker<m>:SGRam:Y:MAXimum:ABOVE.....	1295
CALCulate<n>:DELTamarker<m>:SGRam:Y:MAXimum:BELOW.....	1296
CALCulate<n>:DELTamarker<m>:SGRam:Y:MAXimum:NEXT.....	1296
CALCulate<n>:DELTamarker<m>:SGRam:Y:MAXimum[:PEAK].....	1296
CALCulate<n>:DELTamarker<m>:SGRam:Y:MINimum:ABOVE.....	1297
CALCulate<n>:DELTamarker<m>:SGRam:Y:MINimum:BELOW.....	1297
CALCulate<n>:DELTamarker<m>:SGRam:Y:MINimum:NEXT.....	1297
CALCulate<n>:DELTamarker<m>:SGRam:Y:MINimum[:PEAK].....	1297
CALCulate<n>:DELTamarker<m>:SPECTrogram:FRAME.....	1294
CALCulate<n>:DELTamarker<m>:SPECTrogram:SARea.....	1295
CALCulate<n>:DELTamarker<m>:SPECTrogram:XY:MAXimum[:PEAK].....	1295
CALCulate<n>:DELTamarker<m>:SPECTrogram:XY:MINimum[:PEAK].....	1295
CALCulate<n>:DELTamarker<m>:SPECTrogram:Y:MAXimum:ABOVE.....	1295
CALCulate<n>:DELTamarker<m>:SPECTrogram:Y:MAXimum:BELOW.....	1296
CALCulate<n>:DELTamarker<m>:SPECTrogram:Y:MAXimum:NEXT.....	1296
CALCulate<n>:DELTamarker<m>:SPECTrogram:Y:MAXimum[:PEAK].....	1296
CALCulate<n>:DELTamarker<m>:SPECTrogram:Y:MINimum:ABOVE.....	1297
CALCulate<n>:DELTamarker<m>:SPECTrogram:Y:MINimum:BELOW.....	1297
CALCulate<n>:DELTamarker<m>:SPECTrogram:Y:MINimum:NEXT.....	1297
CALCulate<n>:DELTamarker<m>:SPECTrogram:Y:MINimum[:PEAK].....	1297
CALCulate<n>:DELTamarker<m>:TRACe.....	1272
CALCulate<n>:DELTamarker<m>:X.....	1272
CALCulate<n>:DELTamarker<m>:X:RELATIVE?.....	1288
CALCulate<n>:DELTamarker<m>:Y?.....	1288
CALCulate<n>:DELTamarker<m>[:STATE].....	1271
CALCulate<n>:DELTamarker<ms>:LINK:TO:DELTA<md>.....	1269
CALCulate<n>:DELTamarker<ms>:LINK:TO:MARKER<md>.....	1270
CALCulate<n>:DLINe<dl>.....	1328
CALCulate<n>:DLINe<dl>:STATE.....	1328
CALCulate<n>:ESPectrum:PEAKsearch:AUTO.....	1031
CALCulate<n>:ESPectrum:PEAKsearch:DETAils.....	1046
CALCulate<n>:ESPectrum:PEAKsearch:MARGIn.....	1031
CALCulate<n>:ESPectrum:PEAKsearch:PSHow.....	1032
CALCulate<n>:ESPectrum:PEAKsearch[:IMMEDIATE].....	1031
CALCulate<n>:ESPectrum:PSEArch:AUTO.....	1031
CALCulate<n>:ESPectrum:PSEArch:DETAils.....	1046
CALCulate<n>:ESPectrum:PSEArch:MARGIn.....	1031
CALCulate<n>:ESPectrum:PSEArch:PSHow.....	1032

CALCulate<n>:ESpectrum:PSEarch[:IMMediate].....	1031
CALCulate<n>:FLINe<dl>.....	1329
CALCulate<n>:FLINe<dl>:STATe.....	1329
CALCulate<n>:LIMit<li>:ACPoweR:ACHannel:ABSolute.....	926
CALCulate<n>:LIMit<li>:ACPoweR:ACHannel:ABSolute:STATe.....	926
CALCulate<n>:LIMit<li>:ACPoweR:ACHannel:RESult:ABSolute.....	933
CALCulate<n>:LIMit<li>:ACPoweR:ACHannel:RESult:RELative.....	933
CALCulate<n>:LIMit<li>:ACPoweR:ACHannel:RESult?.....	927
CALCulate<n>:LIMit<li>:ACPoweR:ACHannel[:RELative].....	927
CALCulate<n>:LIMit<li>:ACPoweR:ACHannel[:RELative]:STATe.....	928
CALCulate<n>:LIMit<li>:ACPoweR:ALTernate<ch>:ABSolute.....	929
CALCulate<n>:LIMit<li>:ACPoweR:ALTernate<ch>:ABSolute:STATe.....	929
CALCulate<n>:LIMit<li>:ACPoweR:ALTernate<ch>:RESult:ABSolute.....	934
CALCulate<n>:LIMit<li>:ACPoweR:ALTernate<ch>:RESult:RELative.....	934
CALCulate<n>:LIMit<li>:ACPoweR:ALTernate<ch>:RESult?.....	930
CALCulate<n>:LIMit<li>:ACPoweR:ALTernate<ch>[:RELative].....	930
CALCulate<n>:LIMit<li>:ACPoweR:ALTernate<ch>[:RELative]:STATe.....	931
CALCulate<n>:LIMit<li>:ACPoweR:GAP<gap>:ACLR:RESult:ABSolute?.....	935
CALCulate<n>:LIMit<li>:ACPoweR:GAP<gap>:ACLR:RESult:RELative?.....	935
CALCulate<n>:LIMit<li>:ACPoweR:GAP<gap>:ACLR:RESult?.....	968
CALCulate<n>:LIMit<li>:ACPoweR:GAP<gap>:MANual:LOWer:ABSolute.....	953
CALCulate<n>:LIMit<li>:ACPoweR:GAP<gap>:MANual:LOWer:ABSolute:STATe.....	953
CALCulate<n>:LIMit<li>:ACPoweR:GAP<gap>:MANual:LOWer:ACLR[:RELative].....	954
CALCulate<n>:LIMit<li>:ACPoweR:GAP<gap>:MANual:LOWer:ACLR[:RELative]:STATe.....	955
CALCulate<n>:LIMit<li>:ACPoweR:GAP<gap>:MANual:LOWer[:CACLR][:RELative].....	955
CALCulate<n>:LIMit<li>:ACPoweR:GAP<gap>:MANual:LOWer[:CACLR][:RELative]:STATe.....	956
CALCulate<n>:LIMit<li>:ACPoweR:GAP<gap>:MANual:UPPer:ABSolute.....	957
CALCulate<n>:LIMit<li>:ACPoweR:GAP<gap>:MANual:UPPer:ABSolute:STATe.....	957
CALCulate<n>:LIMit<li>:ACPoweR:GAP<gap>:MANual:UPPer:ACLR[:RELative].....	958
CALCulate<n>:LIMit<li>:ACPoweR:GAP<gap>:MANual:UPPer:ACLR[:RELative]:STATe.....	958
CALCulate<n>:LIMit<li>:ACPoweR:GAP<gap>:MANual:UPPer[:CACLR][:RELative].....	959
CALCulate<n>:LIMit<li>:ACPoweR:GAP<gap>:MANual:UPPer[:CACLR][:RELative]:STATe.....	960
CALCulate<n>:LIMit<li>:ACPoweR:GAP<gap>[:AUTO]:ABSolute.....	947
CALCulate<n>:LIMit<li>:ACPoweR:GAP<gap>[:AUTO]:ABSolute:STATe.....	948
CALCulate<n>:LIMit<li>:ACPoweR:GAP<gap>[:AUTO]:ACLR[:RELative].....	948
CALCulate<n>:LIMit<li>:ACPoweR:GAP<gap>[:AUTO]:ACLR[:RELative]:STATe.....	949
CALCulate<n>:LIMit<li>:ACPoweR:GAP<gap>[:AUTO][:CACLR][:RELative].....	949
CALCulate<n>:LIMit<li>:ACPoweR:GAP<gap>[:AUTO][:CACLR][:RELative]:STATe.....	949
CALCulate<n>:LIMit<li>:ACPoweR:GAP<gap>[:CACLR]:RESult:ABSolute?.....	936
CALCulate<n>:LIMit<li>:ACPoweR:GAP<gap>[:CACLR]:RESult:RELative?.....	936
CALCulate<n>:LIMit<li>:ACPoweR:GAP<gap>[:CACLR]:RESult?.....	969
CALCulate<n>:LIMit<li>:ACPoweR:PMODE.....	931
CALCulate<n>:LIMit<li>:ACPoweR[:STATe].....	932
CALCulate<n>:LIMit<li>:ACTive?.....	1341
CALCulate<n>:LIMit<li>:CLEar[:IMMediate].....	1343
CALCulate<n>:LIMit<li>:COMMENT.....	1331
CALCulate<n>:LIMit<li>:CONTRol:DOMain.....	1332
CALCulate<n>:LIMit<li>:CONTRol:MODE.....	1332
CALCulate<n>:LIMit<li>:CONTRol:OFFSet.....	1333
CALCulate<n>:LIMit<li>:CONTRol:SHIFt.....	1333

CALCulate<n>:LIMit<li>:CONTRol:SPACing.....	1333
CALCulate<n>:LIMit<li>:CONTRol[:DATA].....	1331
CALCulate<n>:LIMit<li>:COPY.....	1341
CALCulate<n>:LIMit<li>:DELEte.....	1341
CALCulate<n>:LIMit<li>:ESPECTrum<sb>:LIMits.....	1020
CALCulate<n>:LIMit<li>:ESPECTrum<sb>:MODE.....	1021
CALCulate<n>:LIMit<li>:ESPECTrum<sb>:PCLass<pc>:COUNT.....	1022
CALCulate<n>:LIMit<li>:ESPECTrum<sb>:PCLass<pc>:LIMit[:STATE].....	1023
CALCulate<n>:LIMit<li>:ESPECTrum<sb>:PCLass<pc>:MAXimum.....	1023
CALCulate<n>:LIMit<li>:ESPECTrum<sb>:PCLass<pc>:MINimum.....	1024
CALCulate<n>:LIMit<li>:ESPECTrum<sb>:PCLass<pc>[:EXCLusive].....	1022
CALCulate<n>:LIMit<li>:ESPECTrum<sb>:RESTore.....	998
CALCulate<n>:LIMit<li>:ESPECTrum<sb>:VALue.....	1021
CALCulate<n>:LIMit<li>:FAIL?.....	1344
CALCulate<n>:LIMit<li>:LOWer:MARGin.....	1334
CALCulate<n>:LIMit<li>:LOWer:MODE.....	1334
CALCulate<n>:LIMit<li>:LOWer:OFFSet.....	1335
CALCulate<n>:LIMit<li>:LOWer:SHIFt.....	1335
CALCulate<n>:LIMit<li>:LOWer:SPACing.....	1336
CALCulate<n>:LIMit<li>:LOWer:STATE.....	1336
CALCulate<n>:LIMit<li>:LOWer:THReshold.....	1336
CALCulate<n>:LIMit<li>:LOWer[:DATA].....	1334
CALCulate<n>:LIMit<li>:NAME.....	1337
CALCulate<n>:LIMit<li>:STATE.....	1342
CALCulate<n>:LIMit<li>:TRACe<t>.....	1528
CALCulate<n>:LIMit<li>:TRACe<t>:CHECK.....	1342
CALCulate<n>:LIMit<li>:UNIT.....	1337
CALCulate<n>:LIMit<li>:UPPer:MARGin.....	1338
CALCulate<n>:LIMit<li>:UPPer:MODE.....	1338
CALCulate<n>:LIMit<li>:UPPer:OFFSet.....	1339
CALCulate<n>:LIMit<li>:UPPer:SHIFt.....	1339
CALCulate<n>:LIMit<li>:UPPer:SPACing.....	1339
CALCulate<n>:LIMit<li>:UPPer:STATE.....	1340
CALCulate<n>:LIMit<li>:UPPer:THReshold.....	1340
CALCulate<n>:LIMit<li>:UPPer[:DATA].....	1337
CALCulate<n>:MARKer<m>:AOFF.....	1273
CALCulate<n>:MARKer<m>:COUNT.....	1315
CALCulate<n>:MARKer<m>:COUNT:FREQuency?.....	1315
CALCulate<n>:MARKer<m>:COUNT:RESolution.....	1316
CALCulate<n>:MARKer<m>:FUNCTion:BPOWER:AOFF.....	1308
CALCulate<n>:MARKer<m>:FUNCTion:BPOWER:MODE.....	1308
CALCulate<n>:MARKer<m>:FUNCTion:BPOWER:RESult?.....	1308
CALCulate<n>:MARKer<m>:FUNCTion:BPOWER:SPAN.....	1309
CALCulate<n>:MARKer<m>:FUNCTion:BPOWER[:STATE].....	1309
CALCulate<n>:MARKer<m>:FUNCTion:CENTer.....	1190
CALCulate<n>:MARKer<m>:FUNCTion:CSTep.....	1191
CALCulate<n>:MARKer<m>:FUNCTion:DEModulation:CONTinuous.....	1317
CALCulate<n>:MARKer<m>:FUNCTion:DEModulation:HOLDoff.....	1317
CALCulate<n>:MARKer<m>:FUNCTion:DEModulation:SElect.....	1318
CALCulate<n>:MARKer<m>:FUNCTion:DEModulation[:STATE].....	1318



CALCulate<n>:MARKer<m>:FUNCTION:FMEasurement:DETEctor.....	1081
CALCulate<n>:MARKer<m>:FUNCTION:FMEasurement:DWELl.....	1083
CALCulate<n>:MARKer<m>:FUNCTION:FMEasurement:LIMit<li>:LCONDition?.....	1086
CALCulate<n>:MARKer<m>:FUNCTION:FMEasurement:LIMit<li>:LDELta?.....	1086
CALCulate<n>:MARKer<m>:FUNCTION:FMEasurement:PEAKsearch:AUTO.....	1082
CALCulate<n>:MARKer<m>:FUNCTION:FMEasurement:PSEArch:AUTO.....	1083
CALCulate<n>:MARKer<m>:FUNCTION:FMEasurement:RESult?.....	1085
CALCulate<n>:MARKer<m>:FUNCTION:FMEasurement[:STATe].....	1081
CALCulate<n>:MARKer<m>:FUNCTION:FPEaks:ANNotation:LABel[:STATe].....	1300
CALCulate<n>:MARKer<m>:FUNCTION:FPEaks:COUNt?.....	1301
CALCulate<n>:MARKer<m>:FUNCTION:FPEaks:LIST:SIZE.....	1301
CALCulate<n>:MARKer<m>:FUNCTION:FPEaks:SORT.....	1302
CALCulate<n>:MARKer<m>:FUNCTION:FPEaks:STATe.....	1302
CALCulate<n>:MARKer<m>:FUNCTION:FPEaks:X?.....	1303
CALCulate<n>:MARKer<m>:FUNCTION:FPEaks:Y?.....	1303
CALCulate<n>:MARKer<m>:FUNCTION:FPEaks[:IMMediate].....	1301
CALCulate<n>:MARKer<m>:FUNCTION:HARMonics:BANDwidth:AUTO.....	1072
CALCulate<n>:MARKer<m>:FUNCTION:HARMonics:DIStortion?.....	1073
CALCulate<n>:MARKer<m>:FUNCTION:HARMonics:LIST.....	1074
CALCulate<n>:MARKer<m>:FUNCTION:HARMonics:NHARmonics.....	1072
CALCulate<n>:MARKer<m>:FUNCTION:HARMonics:PRESet.....	1073
CALCulate<n>:MARKer<m>:FUNCTION:HARMonics[:STATe].....	1071
CALCulate<n>:MARKer<m>:FUNCTION:MDEPth:RESult<t>?.....	1079
CALCulate<n>:MARKer<m>:FUNCTION:MDEPth:SEARChsignal ONCE.....	1079
CALCulate<n>:MARKer<m>:FUNCTION:MDEPth[:STATe].....	1078
CALCulate<n>:MARKer<m>:FUNCTION:MSUMmary.....	1094
CALCulate<n>:MARKer<m>:FUNCTION:NDBDown.....	1311
CALCulate<n>:MARKer<m>:FUNCTION:NDBDown:FREQuency?.....	1312
CALCulate<n>:MARKer<m>:FUNCTION:NDBDown:QFACtor?.....	1313
CALCulate<n>:MARKer<m>:FUNCTION:NDBDown:RESult?.....	1313
CALCulate<n>:MARKer<m>:FUNCTION:NDBDown:STATe.....	1314
CALCulate<n>:MARKer<m>:FUNCTION:NDBDown:TIME?.....	1314
CALCulate<n>:MARKer<m>:FUNCTION:NOISe:AOff.....	1303
CALCulate<n>:MARKer<m>:FUNCTION:NOISe:RESult?.....	1304
CALCulate<n>:MARKer<m>:FUNCTION:NOISe[:STATe].....	1304
CALCulate<n>:MARKer<m>:FUNCTION:PNOise:AOff.....	1306
CALCulate<n>:MARKer<m>:FUNCTION:PNOise:RESult?.....	1307
CALCulate<n>:MARKer<m>:FUNCTION:PNOise[:STATe].....	1307
CALCulate<n>:MARKer<m>:FUNCTION:POWer<sb>:MODE.....	911
CALCulate<n>:MARKer<m>:FUNCTION:POWer<sb>:PRESet.....	916
CALCulate<n>:MARKer<m>:FUNCTION:POWer<sb>:RESult:PHZ.....	970
CALCulate<n>:MARKer<m>:FUNCTION:POWer<sb>:RESult:UNIT.....	970
CALCulate<n>:MARKer<m>:FUNCTION:POWer<sb>:RESult?.....	912
CALCulate<n>:MARKer<m>:FUNCTION:POWer<sb>:SELEct.....	913
CALCulate<n>:MARKer<m>:FUNCTION:POWer<sb>:STANdard:CATalog?.....	916
CALCulate<n>:MARKer<m>:FUNCTION:POWer<sb>:STANdard:DELeTe.....	917
CALCulate<n>:MARKer<m>:FUNCTION:POWer<sb>:STANdard:SAVE.....	917
CALCulate<n>:MARKer<m>:FUNCTION:POWer<sb>[:STATe].....	914
CALCulate<n>:MARKer<m>:FUNCTION:REFerence.....	1207
CALCulate<n>:MARKer<m>:FUNCTION:STRack:BANDwidth.....	1196

CALCulate<n>:MARKer<m>:FUNction:STRack:BWIDth.....	1196
CALCulate<n>:MARKer<m>:FUNction:STRack:THReshold.....	1197
CALCulate<n>:MARKer<m>:FUNction:STRack:TRACe.....	1197
CALCulate<n>:MARKer<m>:FUNction:STRack[:STATe].....	1196
CALCulate<n>:MARKer<m>:FUNction:SUMMary:AOff.....	1062
CALCulate<n>:MARKer<m>:FUNction:SUMMary:AVERAge.....	1062
CALCulate<n>:MARKer<m>:FUNction:SUMMary:MEAN:AVERAge:RESult?.....	1065
CALCulate<n>:MARKer<m>:FUNction:SUMMary:MEAN:PHOLd:RESult?.....	1065
CALCulate<n>:MARKer<m>:FUNction:SUMMary:MEAN:RESult?.....	1066
CALCulate<n>:MARKer<m>:FUNction:SUMMary:MEAN[:STATe].....	1063
CALCulate<n>:MARKer<m>:FUNction:SUMMary:PHOLd.....	1063
CALCulate<n>:MARKer<m>:FUNction:SUMMary:PPEAk:AVERAge:RESult?.....	1066
CALCulate<n>:MARKer<m>:FUNction:SUMMary:PPEAk:PHOLd:RESult?.....	1067
CALCulate<n>:MARKer<m>:FUNction:SUMMary:PPEAk:RESult?.....	1067
CALCulate<n>:MARKer<m>:FUNction:SUMMary:PPEAk[:STATe].....	1064
CALCulate<n>:MARKer<m>:FUNction:SUMMary:RMS:AVERAge:RESult?.....	1067
CALCulate<n>:MARKer<m>:FUNction:SUMMary:RMS:PHOLd:RESult?.....	1068
CALCulate<n>:MARKer<m>:FUNction:SUMMary:RMS:RESult?.....	1068
CALCulate<n>:MARKer<m>:FUNction:SUMMary:RMS[:STATe].....	1064
CALCulate<n>:MARKer<m>:FUNction:SUMMary:SDEViation:AVERAge:RESult?.....	1069
CALCulate<n>:MARKer<m>:FUNction:SUMMary:SDEViation:PHOLd:RESult?.....	1069
CALCulate<n>:MARKer<m>:FUNction:SUMMary:SDEViation:RESult?.....	1069
CALCulate<n>:MARKer<m>:FUNction:SUMMary:SDEViation[:STATe].....	1064
CALCulate<n>:MARKer<m>:FUNction:SUMMary[:STATe].....	1063
CALCulate<n>:MARKer<m>:FUNction:TOI:RESult:MAXimum?.....	1076
CALCulate<n>:MARKer<m>:FUNction:TOI:RESult:MINimum?.....	1077
CALCulate<n>:MARKer<m>:FUNction:TOI:RESult?.....	1076
CALCulate<n>:MARKer<m>:FUNction:TOI:SEARChsignal ONCE.....	1076
CALCulate<n>:MARKer<m>:FUNction:TOI[:STATe].....	1075
CALCulate<n>:MARKer<m>:LOEXclude.....	1277
CALCulate<n>:MARKer<m>:MAXimum:AUTO.....	1281
CALCulate<n>:MARKer<m>:MAXimum:LEFT.....	1282
CALCulate<n>:MARKer<m>:MAXimum:NEXT.....	1282
CALCulate<n>:MARKer<m>:MAXimum:RIGHT.....	1283
CALCulate<n>:MARKer<m>:MAXimum[:PEAK].....	1282
CALCulate<n>:MARKer<m>:MINimum:AUTO.....	1283
CALCulate<n>:MARKer<m>:MINimum:LEFT.....	1283
CALCulate<n>:MARKer<m>:MINimum:NEXT.....	1284
CALCulate<n>:MARKer<m>:MINimum:RIGHT.....	1284
CALCulate<n>:MARKer<m>:MINimum[:PEAK].....	1284
CALCulate<n>:MARKer<m>:PEXCursion.....	1277
CALCulate<n>:MARKer<m>:SGRam:FRAMe.....	1290
CALCulate<n>:MARKer<m>:SGRam:SARea.....	1290
CALCulate<n>:MARKer<m>:SGRam:XY:MAXimum[:PEAK].....	1291
CALCulate<n>:MARKer<m>:SGRam:XY:MINimum[:PEAK].....	1291
CALCulate<n>:MARKer<m>:SGRam:Y:MAXimum:ABOVe.....	1291
CALCulate<n>:MARKer<m>:SGRam:Y:MAXimum:BELOW.....	1291
CALCulate<n>:MARKer<m>:SGRam:Y:MAXimum:NEXT.....	1292
CALCulate<n>:MARKer<m>:SGRam:Y:MAXimum[:PEAK].....	1292
CALCulate<n>:MARKer<m>:SGRam:Y:MINimum:ABOVe.....	1292

CALCulate<n>:MARKer<m>:SGRam:Y:MINimum:BELOW.....	1292
CALCulate<n>:MARKer<m>:SGRam:Y:MINimum:NEXT.....	1293
CALCulate<n>:MARKer<m>:SGRam:Y:MINimum[:PEAK].....	1293
CALCulate<n>:MARKer<m>:SPECTrogram:FRAMe.....	1290
CALCulate<n>:MARKer<m>:SPECTrogram:SARea.....	1290
CALCulate<n>:MARKer<m>:SPECTrogram:XY:MAXimum[:PEAK].....	1291
CALCulate<n>:MARKer<m>:SPECTrogram:XY:MINimum[:PEAK].....	1291
CALCulate<n>:MARKer<m>:SPECTrogram:Y:MAXimum:ABOVE.....	1291
CALCulate<n>:MARKer<m>:SPECTrogram:Y:MAXimum:BELOW.....	1291
CALCulate<n>:MARKer<m>:SPECTrogram:Y:MAXimum:NEXT.....	1292
CALCulate<n>:MARKer<m>:SPECTrogram:Y:MAXimum[:PEAK].....	1292
CALCulate<n>:MARKer<m>:SPECTrogram:Y:MINimum:ABOVE.....	1292
CALCulate<n>:MARKer<m>:SPECTrogram:Y:MINimum:BELOW.....	1292
CALCulate<n>:MARKer<m>:SPECTrogram:Y:MINimum:NEXT.....	1293
CALCulate<n>:MARKer<m>:SPECTrogram:Y:MINimum[:PEAK].....	1293
CALCulate<n>:MARKer<m>:TRACe.....	1274
CALCulate<n>:MARKer<m>:X.....	1275
CALCulate<n>:MARKer<m>:X:SLIMits:LEFT.....	1278
CALCulate<n>:MARKer<m>:X:SLIMits:RIGHT.....	1279
CALCulate<n>:MARKer<m>:X:SLIMits:ZOOM[:STATE].....	1280
CALCulate<n>:MARKer<m>:X:SLIMits[:STATE].....	1278
CALCulate<n>:MARKer<m>:X:SSIZe.....	1276
CALCulate<n>:MARKer<m>:Y:PERCent.....	1052
CALCulate<n>:MARKer<m>:Y?.....	1288
CALCulate<n>:MARKer<m>[:STATE].....	1274
CALCulate<n>:MARKer<ms>:LINK:TO:DELTA<md>.....	1273
CALCulate<n>:MARKer<ms>:LINK:TO:MARKer<md>.....	1273
CALCulate<n>:MATH<t>:MODE.....	1256
CALCulate<n>:MATH<t>:POSition.....	1257
CALCulate<n>:MATH<t>:STATe.....	1257
CALCulate<n>:MATH<t>[:EXPReSSion][:DEFine].....	1255
CALCulate<n>:NPRatio:RESult?.....	996
CALCulate<n>:PEAKsearch:AUTO.....	1046
CALCulate<n>:PEAKsearch:MARGIn.....	1047
CALCulate<n>:PEAKsearch:PSHow.....	1047
CALCulate<n>:PEAKsearch:SUBRanges.....	1047
CALCulate<n>:PMETer<p>:RELative:STATe.....	1179
CALCulate<n>:PMETer<p>:RELative[:MAGNitude].....	1178
CALCulate<n>:PMETer<p>:RELative[:MAGNitude]:AUTO ONCE.....	1179
CALCulate<n>:PSEarch:AUTO.....	1046
CALCulate<n>:PSEarch:MARGIn.....	1047
CALCulate<n>:PSEarch:PSHow.....	1047
CALCulate<n>:PSEarch:SUBRanges.....	1047
CALCulate<n>:SGRam:CLear[:IMMEdiate].....	1248
CALCulate<n>:SGRam:CONTInuous.....	1249
CALCulate<n>:SGRam:FRAMe:COUNt.....	1249
CALCulate<n>:SGRam:FRAMe:SELect.....	1250
CALCulate<n>:SGRam:HDEPth.....	1250
CALCulate<n>:SGRam:LAYout.....	1251
CALCulate<n>:SGRam:THReedim[:STATE].....	1251

CALCulate<n>:SGRam:TRACe.....	1252
CALCulate<n>:SGRam:TSTamp:DATA?.....	1252
CALCulate<n>:SGRam:TSTamp[:STATe].....	1253
CALCulate<n>:SGRam[:STATe].....	1251
CALCulate<n>:SPECtrogram:CLEar[:IMMediate].....	1248
CALCulate<n>:SPECtrogram:CONTInuous.....	1249
CALCulate<n>:SPECtrogram:FRAME:COUNt.....	1249
CALCulate<n>:SPECtrogram:FRAME:SElect.....	1250
CALCulate<n>:SPECtrogram:HDEPth.....	1250
CALCulate<n>:SPECtrogram:LAYout.....	1251
CALCulate<n>:SPECtrogram:THReedim[:STATe].....	1251
CALCulate<n>:SPECtrogram:TRACe.....	1252
CALCulate<n>:SPECtrogram:TSTamp:DATA?.....	1252
CALCulate<n>:SPECtrogram:TSTamp[:STATe].....	1253
CALCulate<n>:SPECtrogram[:STATe].....	1251
CALCulate<n>:STATistics:APD[:STATe].....	1051
CALCulate<n>:STATistics:CCDF:X<t>?.....	1059
CALCulate<n>:STATistics:CCDF[:STATe].....	1051
CALCulate<n>:STATistics:NSAMples.....	1053
CALCulate<n>:STATistics:PRESet.....	1056
CALCulate<n>:STATistics:RESult<res>?.....	1059
CALCulate<n>:STATistics:SCALE:AUTO ONCE.....	1056
CALCulate<n>:STATistics:SCALE:X:RANGe.....	1057
CALCulate<n>:STATistics:SCALE:X:RLEVel.....	1057
CALCulate<n>:STATistics:SCALE:Y:LOWer.....	1057
CALCulate<n>:STATistics:SCALE:Y:UNIT.....	1058
CALCulate<n>:STATistics:SCALE:Y:UPPer.....	1058
CALCulate<n>:THReshold.....	1280
CALCulate<n>:THReshold:STATe.....	1280
CALCulate<n>:TLINe<dl>.....	1329
CALCulate<n>:TLINe<dl>:STATe.....	1330
CALCulate<n>:UNIT:POWER.....	1207
CALibration:AIQ:HATiming[:STATe].....	1143
CALibration:DUE:DAYS.....	1395
CALibration:DUE:SCHedule.....	1395
CALibration:DUE:SHUTdown.....	1396
CALibration:DUE:TIME.....	1396
CALibration:DUE:WARMup.....	1397
CALibration:INFO:OLD?.....	1397
CALibration:PADJust[:STATe].....	1110
CALibration:PMETer<p>:ZERO:AUTO ONCE.....	1178
CALibration:PRESelection.....	1397
CALibration:RESult?.....	1398
CALibration[:ALL].....	1394
CALibration[:ALL]?.....	1394
CONFigure:GENerator:CONNection:CState?.....	1454
CONFigure:GENerator:CONNection[:STATe].....	1454
CONFigure:GENerator:EXTernal:ROSCillator.....	986
CONFigure:GENerator:FREQuency:CENTer.....	987
CONFigure:GENerator:IPConnection:ADDResS.....	1455

CONFigure:GENerator:NPRatio:BB:ARbitrary:WAVEform:SElect?	987
CONFigure:GENerator:NPRatio:BB:STANdard?	987
CONFigure:GENerator:NPRatio:CONNectiOn:CSate?	987
CONFigure:GENerator:NPRatio:CONTRol[:STATe]	988
CONFigure:GENerator:NPRatio:EXTernal:ROSCillator:CSate?	988
CONFigure:GENerator:NPRatio:FREQUency:CENTer:CSate?	988
CONFigure:GENerator:NPRatio:FREQUency:COUPling[:STATe]	989
CONFigure:GENerator:NPRatio:FREQUency:OFFSet	989
CONFigure:GENerator:NPRatio:FREQUency[:FACTor]:DENominator	989
CONFigure:GENerator:NPRatio:FREQUency[:FACTor]:NUMerator	990
CONFigure:GENerator:NPRatio:NOTCh<notch>:BWiDth:ABSolute:CSate?	990
CONFigure:GENerator:NPRatio:NOTCh<notch>:CLOCK?	992
CONFigure:GENerator:NPRatio:NOTCh<notch>:COUNt:CSate?	992
CONFigure:GENerator:NPRatio:NOTCh<notch>:FREQUency:OFFSet:CSate?	990
CONFigure:GENerator:NPRatio:NOTCh<notch>:STATe:CSate?	991
CONFigure:GENerator:NPRatio:NOTCh<notch>[:STATe]	991
CONFigure:GENerator:NPRatio:POWer:LEVel:CSate?	992
CONFigure:GENerator:NPRatio:POWer:LEVel:OFFSet:CSate?	993
CONFigure:GENerator:NPRatio:RFOutput:STATe:CSate?	993
CONFigure:GENerator:NPRatio:SETTings:NOTCh:UPDate	994
CONFigure:GENerator:NPRatio:SETTings:UPDate	994
CONFigure:GENerator:NPRatio:STATe:CSate?	994
CONFigure:GENerator:NPRatio[:STATe]	994
CONFigure:GENerator:POWer:LEVel	995
CONFigure:GENerator:POWer:LEVel:OFFSet	995
CONFigure:GENerator:RECOrding:COMBine	1487
CONFigure:GENerator:RFOutput[:STATe]	995
CONFigure:GENerator:TARGet:PATH:BB?	995
CONFigure:GENerator:TARGet:PATH:RF	996
CONFigure:SETTings:NPRatio	996
CONFigure:SETTings:NPRatio:NOTCh	996
DEvice:INFO:HWBand?	1446
DIAGnostic:HUMS:DELeTe:ALL	1438
DIAGnostic:HUMS:FORMat	1438
DIAGnostic:HUMS:STATe	1439
DIAGnostic:HUMS:TAGS:ALL?	1439
DIAGnostic:HUMS:TAGS:DELeTe	1440
DIAGnostic:HUMS:TAGS:DELeTe:ALL	1439
DIAGnostic:HUMS:TAGS[:VALue]	1440
DIAGnostic:INFO:CCOunt?	1444
DIAGnostic:SERVice:BIOSinfo?	1447
DIAGnostic:SERVice:CALibration:DATE	1445
DIAGnostic:SERVice:CALibration:DUE:DATE	1445
DIAGnostic:SERVice:CALibration:INTerval?	1445
DIAGnostic:SERVice:DATE	1446
DIAGnostic:SERVice:HWInfo?	1447
DIAGnostic:SERVice:INPut:AIQ[:TYPE]	1400
DIAGnostic:SERVice:INPut:MC:CFRequency	1398
DIAGnostic:SERVice:INPut:MC:RANGe	1399
DIAGnostic:SERVice:INPut:MC[:DISTance]	1398

DIAGnostic:SERVice:INPut:PULSed:CFRequency.....	1399
DIAGnostic:SERVice:INPut:PULSed:MCFRequency.....	1399
DIAGnostic:SERVice:INPut:PULSed:WBFRequency.....	1400
DIAGnostic:SERVice:INPut:RF[:SPEctrum].....	1400
DIAGnostic:SERVice:INPut[:SElect].....	1401
DIAGnostic:SERVice:NSource.....	1187
DIAGnostic:SERVice:SFUNction.....	1455
DIAGnostic:SERVice:SFUNction:LASTresult?.....	1456
DIAGnostic:SERVice:SFUNction:RESults:DELeTe.....	1456
DIAGnostic:SERVice:SFUNction:RESults:SAVE.....	1456
DIAGnostic:SERVice:SINfo?.....	1457
DIAGnostic:SERVice:STESt:RESult?.....	1401
DIAGnostic:SERVice:VERSinfo?.....	1447
DISPlay:ANNotation:CBAR.....	1425
DISPlay:ANNotation:FREQuency.....	1426
DISPlay:ATAB.....	898
DISPlay:CMAP<it>:DEFault<ci>.....	1429
DISPlay:CMAP<it>:HSL.....	1429
DISPlay:CMAP<it>:PDEFined.....	1430
DISPlay:FORMat.....	1099
DISPlay:LOGO.....	1363
DISPlay:SBAR[:STATe].....	1426
DISPlay:SKEYs[:STATe].....	1426
DISPlay:TBAR[:STATe].....	1426
DISPlay:THEMe:CATalog?.....	1430
DISPlay:THEMe:SElect.....	1430
DISPlay:TOUChscreen[:STATe].....	1427
DISPlay[:WINDow<n>]:MINFo[:STATe].....	1276
DISPlay[:WINDow<n>]:MTABLE.....	1276
DISPlay[:WINDow<n>]:SGRam:COLor:DEFault.....	1254
DISPlay[:WINDow<n>]:SGRam:COLor:LOWer.....	1254
DISPlay[:WINDow<n>]:SGRam:COLor:SHApe.....	1254
DISPlay[:WINDow<n>]:SGRam:COLor:UPPer.....	1254
DISPlay[:WINDow<n>]:SGRam:COLor[:STYLe].....	1255
DISPlay[:WINDow<n>]:SIZE.....	1099
DISPlay[:WINDow<n>]:SPEctrogram:COLor:DEFault.....	1254
DISPlay[:WINDow<n>]:SPEctrogram:COLor:LOWer.....	1254
DISPlay[:WINDow<n>]:SPEctrogram:COLor:SHApe.....	1254
DISPlay[:WINDow<n>]:SPEctrogram:COLor:UPPer.....	1254
DISPlay[:WINDow<n>]:SPEctrogram:COLor[:STYLe].....	1255
DISPlay[:WINDow<n>]:STATe.....	1529
DISPlay[:WINDow<n>]:STATistics:CCDF:GAUSs.....	1053
DISPlay[:WINDow<n>]:TIME.....	1427
DISPlay[:WINDow<n>]:TIME:FORMat.....	1427
DISPlay[:WINDow<n>]:TRACe<t>:LABel:TEXT.....	1241
DISPlay[:WINDow<n>]:TRACe<t>:LABel[:STATe].....	1240
DISPlay[:WINDow<n>]:TYPE.....	1529
DISPlay[:WINDow<n>][:SUBWIndow<w>]:TRACe<t>:MODE.....	1241
DISPlay[:WINDow<n>][:SUBWIndow<w>]:TRACe<t>:MODE:HCONTinuous.....	1242
DISPlay[:WINDow<n>][:SUBWIndow<w>]:TRACe<t>:PRESet.....	1243

DISPlay[:WINDow<n>][:SUBWindow<w>]:TRACe<t>:SMOothing:APERture.....	1244
DISPlay[:WINDow<n>][:SUBWindow<w>]:TRACe<t>:SMOothing[:STATe].....	1244
DISPlay[:WINDow<n>][:SUBWindow<w>]:TRACe<t>:X:SPACing.....	1191
DISPlay[:WINDow<n>][:SUBWindow<w>]:TRACe<t>:Y:SPACing.....	1216
DISPlay[:WINDow<n>][:SUBWindow<w>]:TRACe<t>:Y[:SCALe].....	1214
DISPlay[:WINDow<n>][:SUBWindow<w>]:TRACe<t>:Y[:SCALe]:AUTO ONCE.....	1215
DISPlay[:WINDow<n>][:SUBWindow<w>]:TRACe<t>:Y[:SCALe]:MODE.....	1215
DISPlay[:WINDow<n>][:SUBWindow<w>]:TRACe<t>:Y[:SCALe]:PDIVision.....	1215
DISPlay[:WINDow<n>][:SUBWindow<w>]:TRACe<t>:Y[:SCALe]:RLEVel.....	1207
DISPlay[:WINDow<n>][:SUBWindow<w>]:TRACe<t>:Y[:SCALe]:RLEVel:OFFSet.....	1208
DISPlay[:WINDow<n>][:SUBWindow<w>]:TRACe<t>:Y[:SCALe]:RPOSition.....	1216
DISPlay[:WINDow<n>][:SUBWindow<w>]:TRACe<t>:Y[:SCALe]:RVALue.....	1172
DISPlay[:WINDow<n>][:SUBWindow<w>]:TRACe<t>[:STATe].....	1243
DISPlay[:WINDow<n>][:SUBWindow<w>]:ZOOM:AREA.....	1236
DISPlay[:WINDow<n>][:SUBWindow<w>]:ZOOM:MULTiple<zn>:AREA.....	1238
DISPlay[:WINDow<n>][:SUBWindow<w>]:ZOOM:MULTiple<zn>[:STATe].....	1239
DISPlay[:WINDow<n>][:SUBWindow<w>]:ZOOM[:STATe].....	1237
FETCh:PMETer<p>?.....	1179
FORMat:DEXPort:CSEParator.....	1262
FORMat:DEXPort:DSEParator.....	1348
FORMat:DEXPort:FORMat.....	1263
FORMat:DEXPort:HEADer.....	1373
FORMat:DEXPort:TRACes.....	1263
FORMat:DEXPort:XDIStrib.....	1263
FORMat:DIMPort:TRACes.....	1264
FORMat[:DATA].....	1258
HCOPY:ABORt.....	1363
HCOPY:CMAP<it>:DEFault<ci>.....	1364
HCOPY:CMAP<it>:HSL.....	1365
HCOPY:CMAP<it>:PDEFined.....	1365
HCOPY:CONTent.....	1363
HCOPY:DESTination<di>.....	1365
HCOPY:DEVice:COLor.....	1366
HCOPY:DEVice:LANGuage.....	1367
HCOPY:ITEM:ALL.....	1529
HCOPY:ITEM:WINDow:TEXT.....	1368
HCOPY:MODE.....	1376
HCOPY:PAGE:COUNt:STATe.....	1368
HCOPY:PAGE:MARGin:BOTTom.....	1368
HCOPY:PAGE:MARGin:LEFT.....	1368
HCOPY:PAGE:MARGin:RIGHT.....	1369
HCOPY:PAGE:MARGin:TOP.....	1369
HCOPY:PAGE:MARGin:UNIT.....	1369
HCOPY:PAGE:ORientation.....	1369
HCOPY:PAGE:WINDow:CHANnel:STATe.....	1370
HCOPY:PAGE:WINDow:COUNt.....	1370
HCOPY:PAGE:WINDow:SCALe.....	1370
HCOPY:PAGE:WINDow:STATe.....	1371
HCOPY:TDSamp:STATe.....	1371
HCOPY:TREPort:APPend.....	1376

HCOPY:TREPort:DESCription.....	1376
HCOPY:TREPort:ITEM:DEFault.....	1377
HCOPY:TREPort:ITEM:HEADer:LINE<li>:CONTrol.....	1377
HCOPY:TREPort:ITEM:HEADer:LINE<li>:TEXT.....	1377
HCOPY:TREPort:ITEM:HEADer:LINE<li>:TITLe.....	1378
HCOPY:TREPort:ITEM:HEADer:STATe.....	1379
HCOPY:TREPort:ITEM:LIST.....	1379
HCOPY:TREPort:ITEM:LOGO.....	1379
HCOPY:TREPort:ITEM:LOGO:CONTrol.....	1380
HCOPY:TREPort:ITEM:SElect.....	1380
HCOPY:TREPort:ITEM:TEMPlate:CATalog?.....	1381
HCOPY:TREPort:ITEM:TEMPlate:DELeTe.....	1382
HCOPY:TREPort:ITEM:TEMPlate:LOAD.....	1382
HCOPY:TREPort:ITEM:TEMPlate:SAVE.....	1382
HCOPY:TREPort:NEW.....	1382
HCOPY:TREPort:PAGecount:STATe.....	1383
HCOPY:TREPort:PAGeSize.....	1383
HCOPY:TREPort:PCOLors:STATe.....	1383
HCOPY:TREPort:TDSamp:STATe.....	1384
HCOPY:TREPort:TEST:REMOve.....	1384
HCOPY:TREPort:TEST:REMOve:ALL.....	1384
HCOPY:TREPort:TITLe.....	1384
HCOPY:TREPort:TITLe:STATe.....	1385
HCOPY[:IMMEDIATE].....	1367
HCOPY[:IMMEDIATE]:NEXT.....	1367
INITiate:SEQuencer:ABORT.....	904
INITiate:SEQuencer:IMMEDIATE.....	904
INITiate:SEQuencer:MODE.....	904
INITiate<n>:CONMeas.....	909
INITiate<n>:CONTInuous.....	909
INITiate<n>:ESPectrum.....	1000
INITiate<n>:SPURious.....	1036
INITiate<n>[:IMMEDIATE].....	910
INPut:ATTenuation.....	1209
INPut:ATTenuation:AUTO.....	1210
INPut:ATTenuation:AUTO:MODE.....	1210
INPut:ATTenuation:PROTection:RESet.....	1110
INPut:CONNector.....	1110
INPut:COUPling.....	1110
INPut:DIQ:CDEVice.....	1139
INPut:DIQ:RANGe:COUPling.....	1139
INPut:DIQ:RANGe[:UPPer].....	1139
INPut:DIQ:RANGe[:UPPer]:AUTO.....	1140
INPut:DIQ:RANGe[:UPPer]:UNIT.....	1140
INPut:DIQ:SRATe.....	1140
INPut:DIQ:SRATe:AUTO.....	1140
INPut:DPAth.....	1111
INPut:EATT.....	1210
INPut:EATT:AUTO.....	1211
INPut:EATT:STATe.....	1211



INPut:EGain[:STATe].....	1212
INPut:FiLTer:HPASs[:STATe].....	1111
INPut:FiLTer:YIG[:STATe].....	1112
INPut:GAIN:STATe.....	1213
INPut:GAIN[:VALue].....	1214
INPut:IMPedance.....	1112
INPut:IMPedance:PTYPe.....	1112
INPut:IQ:BALEnced[:STATe].....	1141
INPut:IQ:FULLscale:AUTO.....	1141
INPut:IQ:FULLscale[:LEVel].....	1142
INPut:IQ:IMPedance.....	1142
INPut:IQ:IMPedance:PTYPe.....	1142
INPut:IQ:TYPE.....	1143
INPut:LISN:FiLTer:HPASs[:STATe].....	1083
INPut:LISN:PHASe.....	1084
INPut:LISN[:TYPE].....	1084
INPut:SANalyzer:ATTenuation.....	1211
INPut:SANalyzer:ATTenuation:AUTO.....	1212
INPut:SElect.....	1113
INPut:TYPE.....	1114
INPut:UPORt:STATe.....	1114
INPut:UPORt[:VALue].....	1114
INSTRument:COUPle:ABIMpedance.....	1458
INSTRument:COUPle:ACDC.....	1459
INSTRument:COUPle:ATTen.....	1459
INSTRument:COUPle:AUNit.....	1459
INSTRument:COUPle:BAWdth.....	1460
INSTRument:COUPle:BWIDth.....	1460
INSTRument:COUPle:CENTer.....	1460
INSTRument:COUPle:DEMod.....	1461
INSTRument:COUPle:GAIN.....	1461
INSTRument:COUPle:GENerator:CENTer:OFFSet.....	1473
INSTRument:COUPle:GENerator:CENTer[:STATe].....	1473
INSTRument:COUPle:GENerator:RLEVel:OFFSet.....	1473
INSTRument:COUPle:GENerator:RLEVel[:STATe].....	1474
INSTRument:COUPle:GENerator:STATe.....	1474
INSTRument:COUPle:IMPedance.....	1461
INSTRument:COUPle:LIMit.....	1462
INSTRument:COUPle:LLINes.....	1462
INSTRument:COUPle:MARKer.....	1462
INSTRument:COUPle:PRESel.....	1463
INSTRument:COUPle:RLEVel.....	1463
INSTRument:COUPle:SPAN.....	1463
INSTRument:COUPle:USER<uc>.....	1464
INSTRument:COUPle:USER<uc>:CHANnel:LIST?.....	1466
INSTRument:COUPle:USER<uc>:ELEMeNt:LIST?.....	1466
INSTRument:COUPle:USER<uc>:INFO.....	1467
INSTRument:COUPle:USER<uc>:NEW?.....	1468
INSTRument:COUPle:USER<uc>:NUMBers:LIST?.....	1470
INSTRument:COUPle:USER<uc>:RELation.....	1470

INSTrument:COUPle:USER<uc>:REMove.....	1471
INSTrument:COUPle:USER<uc>:STATe.....	1471
INSTrument:COUPle:USER<uc>:WINDow:LIST?.....	1472
INSTrument:COUPle:VBW.....	1464
INSTrument:CREate:DUPLicate.....	898
INSTrument:CREate:REPLace.....	899
INSTrument:CREate[:NEW].....	898
INSTrument:DELeTe.....	899
INSTrument:LIST?.....	899
INSTrument:MODE.....	901
INSTrument:REName.....	902
INSTrument[:SElect].....	902
LAYout:ADD[:WINDow]?.....	1100
LAYout:CATalog[:WINDow]?.....	1101
LAYout:IDENtify[:WINDow]?.....	1101
LAYout:MOVE[:WINDow].....	1102
LAYout:REMove[:WINDow].....	1102
LAYout:REPLace[:WINDow].....	1102
LAYout:SPLitter.....	1103
LAYout:WINDow<n>:ADD?.....	1104
LAYout:WINDow<n>:IDENtify?.....	1105
LAYout:WINDow<n>:REMove.....	1105
LAYout:WINDow<n>:REPLace.....	1105
LAYout:WINDow<n>:TYPE.....	1106
MMEMory:CATalog.....	1349
MMEMory:CATalog:LONG.....	1349
MMEMory:CDIRectory.....	1350
MMEMory:CLEar:ALL.....	1358
MMEMory:CLEar:STATe.....	1358
MMEMory:COMMeNt.....	1350
MMEMory:COpy.....	1350
MMEMory:DATA.....	1351
MMEMory:DELeTe:IMMeDiate.....	1351
MMEMory:LOAD:AUTO.....	1358
MMEMory:LOAD:STATe.....	1358
MMEMory:LOAD:TYPE.....	1359
MMEMory:LOAD<n>:LIMit.....	1343
MMEMory:LOAD<n>:TFACtor.....	1405
MMEMory:LOAD<n>:TRACe.....	1264
MMEMory:MDIRectory.....	1351
MMEMory:MOVE.....	1352
MMEMory:MSIS.....	1352
MMEMory:NAME.....	1352
MMEMory:NETWork:DISConnect.....	1352
MMEMory:NETWork:MAP.....	1353
MMEMory:NETWork:UNUSeddrives.....	1353
MMEMory:NETWork:USEDdrives.....	1353
MMEMory:RAW.....	1385
MMEMory:RDIRectory.....	1354
MMEMory:SElect:CHANnel[:ITEM]:ALL.....	1354

MMEMory:SElect:CHANnel[:ITEM]:DEFault.....	1355
MMEMory:SElect:CHANnel[:ITEM]:HWSettings.....	1355
MMEMory:SElect:CHANnel[:ITEM]:LINES:ALL.....	1355
MMEMory:SElect:CHANnel[:ITEM]:NONE.....	1356
MMEMory:SElect:CHANnel[:ITEM]:SCData.....	1356
MMEMory:SElect:CHANnel[:ITEM]:SGRam.....	1356
MMEMory:SElect:CHANnel[:ITEM]:SPECTrogram.....	1356
MMEMory:SElect:CHANnel[:ITEM]:TRACe[:ACTive].....	1357
MMEMory:SElect:CHANnel[:ITEM]:TRANsducer:ALL.....	1357
MMEMory:SElect[:ITEM]:ALL.....	1354
MMEMory:SElect[:ITEM]:DEFault.....	1355
MMEMory:SElect[:ITEM]:HWSettings.....	1355
MMEMory:SElect[:ITEM]:LINES:ALL.....	1355
MMEMory:SElect[:ITEM]:NONE.....	1356
MMEMory:SElect[:ITEM]:SCData.....	1356
MMEMory:SElect[:ITEM]:SGRam.....	1356
MMEMory:SElect[:ITEM]:SPECTrogram.....	1356
MMEMory:SElect[:ITEM]:TRACe<1...3>[:ACTive].....	1357
MMEMory:SElect[:ITEM]:TRANsducer:ALL.....	1357
MMEMory:STORe<1 2>:STATe.....	1360
MMEMory:STORe<1 2>:STATe:NEXT.....	1360
MMEMory:STORe<1 2>:TYPE.....	1361
MMEMory:STORe<n>:LIMit.....	1343
MMEMory:STORe<n>:LIST.....	1373
MMEMory:STORe<n>:PEAK.....	1374
MMEMory:STORe<n>:SGRam.....	1374
MMEMory:STORe<n>:SPECTrogram.....	1374
MMEMory:STORe<n>:SPURious.....	1375
MMEMory:STORe<n>:TFACtor.....	1406
MMEMory:STORe<n>:TRACe.....	1265
OUTPut:IF:IFFRequency.....	1189
OUTPut:IF:SBAND?.....	1188
OUTPut:IF[:SOURce].....	1188
OUTPut:TRIGGer<tp>:DIRection.....	1230
OUTPut:TRIGGer<tp>:LEVel.....	1230
OUTPut:TRIGGer<tp>:OTYPe.....	1230
OUTPut:TRIGGer<tp>:PULSe:IMMediate.....	1231
OUTPut:TRIGGer<tp>:PULSe:LENGth.....	1231
OUTPut:UPORt:STATe.....	1189
OUTPut:UPORt[:VALue].....	1189
READ:PMETer<p>?.....	1180
SOURce<si>:EXTernal<ext>:ROSCillator:EXTernal:FREQuency.....	1391
SOURce<si>:EXTernal<gen>:FREQuency.....	1165
SOURce<si>:EXTernal<gen>:FREQuency:COUPLing[:STATe].....	1166
SOURce<si>:EXTernal<gen>:FREQuency:OFFSet.....	1167
SOURce<si>:EXTernal<gen>:FREQuency:SWEEP[:STATe].....	1529
SOURce<si>:EXTernal<gen>:FREQuency[:FACtor]:DENominator.....	1166
SOURce<si>:EXTernal<gen>:FREQuency[:FACtor]:NUMerator.....	1167
SOURce<si>:EXTernal<gen>:POWer[:LEVel].....	1168
SOURce<si>:EXTernal<gen>:ROSCillator[:SOURce].....	1169

SOURce<si>:EXTernal<gen>[:STATE].....	1168
SOURce<si>:POWER[:LEVel][:IMMediate]:OFFSet.....	1169
SOURce<si>:TEMPerature:FRONTend.....	1401
STATus:OPERation:CONDition?.....	1479
STATus:OPERation:ENABle.....	1480
STATus:OPERation:NTRansition.....	1480
STATus:OPERation:PTRansition.....	1481
STATus:OPERation[:EVENT]?.....	1479
STATus:PRESet.....	1478
STATus:QUEStionable:ACPLimit:CONDition?.....	1479
STATus:QUEStionable:ACPLimit:ENABle.....	1480
STATus:QUEStionable:ACPLimit:NTRansition.....	1481
STATus:QUEStionable:ACPLimit:PTRansition.....	1481
STATus:QUEStionable:ACPLimit[:EVENT]?.....	1479
STATus:QUEStionable:CONDition?.....	1479
STATus:QUEStionable:ENABle.....	1480
STATus:QUEStionable:EXTended:CONDition?.....	1479
STATus:QUEStionable:EXTended:ENABle.....	1480
STATus:QUEStionable:EXTended:INFO:CONDition?.....	1479
STATus:QUEStionable:EXTended:INFO:ENABle.....	1480
STATus:QUEStionable:EXTended:INFO:NTRansition.....	1481
STATus:QUEStionable:EXTended:INFO:PTRansition.....	1481
STATus:QUEStionable:EXTended:INFO[:EVENT]?.....	1479
STATus:QUEStionable:EXTended:NTRansition.....	1481
STATus:QUEStionable:EXTended:PTRansition.....	1481
STATus:QUEStionable:EXTended[:EVENT]?.....	1479
STATus:QUEStionable:FREQuency:CONDition?.....	1479
STATus:QUEStionable:FREQuency:ENABle.....	1480
STATus:QUEStionable:FREQuency:NTRansition.....	1481
STATus:QUEStionable:FREQuency:PTRansition.....	1481
STATus:QUEStionable:FREQuency[:EVENT]?.....	1479
STATus:QUEStionable:LIMit<n>:CONDition?.....	1479
STATus:QUEStionable:LIMit<n>:ENABle.....	1480
STATus:QUEStionable:LIMit<n>:NTRansition.....	1481
STATus:QUEStionable:LIMit<n>:PTRansition.....	1481
STATus:QUEStionable:LIMit<n>[:EVENT]?.....	1479
STATus:QUEStionable:LMARgin<n>:CONDition?.....	1479
STATus:QUEStionable:LMARgin<n>:ENABle.....	1480
STATus:QUEStionable:LMARgin<n>:NTRansition.....	1481
STATus:QUEStionable:LMARgin<n>:PTRansition.....	1481
STATus:QUEStionable:LMARgin<n>[:EVENT]?.....	1479
STATus:QUEStionable:NTRansition.....	1480
STATus:QUEStionable:POWER:CONDition?.....	1479
STATus:QUEStionable:POWER:ENABle.....	1480
STATus:QUEStionable:POWER:NTRansition.....	1481
STATus:QUEStionable:POWER:PTRansition.....	1481
STATus:QUEStionable:POWER[:EVENT]?.....	1479
STATus:QUEStionable:PTRansition.....	1481
STATus:QUEStionable:TEMPerature:CONDition?.....	1479
STATus:QUEStionable:TEMPerature:ENABle.....	1480

STATus:QUEStionable:TEMPerature:NTRansition.....	1481
STATus:QUEStionable:TEMPerature:PTRansition.....	1481
STATus:QUEStionable:TEMPerature[:EVENT]?.....	1480
STATus:QUEStionable:TIME:CONDition?.....	1479
STATus:QUEStionable:TIME:ENABle.....	1480
STATus:QUEStionable:TIME:NTRansition.....	1481
STATus:QUEStionable:TIME:PTRansition.....	1481
STATus:QUEStionable:TIME[:EVENT]?.....	1480
STATus:QUEStionable[:EVENT]?.....	1479
STATus:QUEue[:NEXT]?.....	1479
SYSTem:CLOGging.....	1482
SYSTem:COMMunicate:GPIB:RDEvice:GENerator<gen>:ADDResS.....	1170
SYSTem:COMMunicate:GPIB[:SELF]:ADDResS.....	1433
SYSTem:COMMunicate:GPIB[:SELF]:RTERminator.....	1433
SYSTem:COMMunicate:INTErnal:REMOte.....	1434
SYSTem:COMMunicate:PRINter:ENUMerate:FIRSt.....	1372
SYSTem:COMMunicate:PRINter:ENUMerate[:NEXT].....	1372
SYSTem:COMMunicate:PRINter:SElect<di>.....	1372
SYSTem:COMMunicate:RDEvice:GENerator<gen>:INTErface.....	1170
SYSTem:COMMunicate:RDEvice:GENerator<gen>:LINK.....	1170
SYSTem:COMMunicate:RDEvice:GENerator<gen>:TYPE.....	1171
SYSTem:COMMunicate:RDEvice:PMETer<p>:CONFigure:AUTO[:STATe].....	1176
SYSTem:COMMunicate:RDEvice:PMETer<p>:COUNT?.....	1177
SYSTem:COMMunicate:RDEvice:PMETer<p>:DEFine.....	1177
SYSTem:COMMunicate:REST:ENABle.....	1440
SYSTem:COMMunicate:SNMP:COMMunity:RO.....	1441
SYSTem:COMMunicate:SNMP:COMMunity:RW.....	1441
SYSTem:COMMunicate:SNMP:CONtact.....	1441
SYSTem:COMMunicate:SNMP:LOCation.....	1442
SYSTem:COMMunicate:SNMP:USM:USER.....	1442
SYSTem:COMMunicate:SNMP:USM:USER:ALL?.....	1442
SYSTem:COMMunicate:SNMP:USM:USER:DELeTe.....	1443
SYSTem:COMMunicate:SNMP:USM:USER:DELeTe:ALL.....	1443
SYSTem:COMMunicate:SNMP:VERSIon.....	1443
SYSTem:COMMunicate:TCPIp:RDEvice:GENerator<gen>:ADDResS.....	1171
SYSTem:COMPAtible.....	1530
SYSTem:DATE.....	1428
SYSTem:DFPPrint.....	1448
SYSTem:DISPlay:FPAneL[:STATe].....	1428
SYSTem:DISPlay:LANGuage.....	1432
SYSTem:DISPlay:LOCK.....	1434
SYSTem:DISPlay:UPDate.....	1435
SYSTem:ERRor:CLEar:ALL.....	1448
SYSTem:ERRor:CLEar:REMOte.....	1448
SYSTem:ERRor:DISPlay.....	1435
SYSTem:ERRor:EXTended?.....	1448
SYSTem:ERRor:LIST?.....	1449
SYSTem:ERRor[:NEXT]?.....	1450
SYSTem:FIRMWare:UPDate.....	1450
SYSTem:FORMat:IDENT.....	1450

SYSTem:HPADditional.....	1489
SYSTem:HPCoupling.....	1488
SYSTem:IDENtify:FACTory.....	1435
SYSTem:IDENtify[:STRing].....	1435
SYSTem:IFGain:MODE.....	1489
SYSTem:KLOCK.....	1436
SYSTem:LANGuage.....	1489
SYSTem:LXI:LANReset.....	1436
SYSTem:LXI:MDEscription.....	1436
SYSTem:LXI:PASSword.....	1436
SYSTem:OPTion:LICense[:LIST].....	1450
SYSTem:OPTion:LICense[:LIST]?.....	1451
SYSTem:OPTion:TRIAL:LIST?.....	1452
SYSTem:OPTion:TRIAL[:STATE].....	1452
SYSTem:PASSword:RESet.....	1458
SYSTem:PASSword[:CENable].....	1457
SYSTem:PLUGin:APPStarter:DElete.....	1475
SYSTem:PLUGin:APPStarter:DIRectory.....	1475
SYSTem:PLUGin:APPStarter:EXECute.....	1475
SYSTem:PLUGin:APPStarter:ICON.....	1476
SYSTem:PLUGin:APPStarter:NAME.....	1476
SYSTem:PLUGin:APPStarter:PARams.....	1476
SYSTem:PLUGin:APPStarter:SElect.....	1477
SYSTem:PREamp.....	1490
SYSTem:PRESet.....	1361
SYSTem:PRESet:CHANnel[:EXEC].....	1362
SYSTem:PRESet:COMPAtible.....	1453
SYSTem:PSA:WIDeband.....	1490
SYSTem:REBoot.....	1482
SYSTem:REVision:FACTory.....	1436
SYSTem:REVision[:STRing].....	1491
SYSTem:RSweep.....	1491
SYSTem:SECurity[:STATE].....	1453
SYSTem:SEQuencer.....	905
SYSTem:SHIMmediate ONCE.....	1437
SYSTem:SHIMmediate:STATE.....	1437
SYSTem:SHUTdown.....	1482
SYSTem:SPEaker:VOLume.....	1190
SYSTem:SREOrder:CLEAR.....	1483
SYSTem:SREOrder:DATA[:ALL]?.....	1483
SYSTem:SREOrder:EXPort.....	1485
SYSTem:SREOrder:FORMat.....	1486
SYSTem:SREOrder:SYNC.....	1487
SYSTem:SREOrder[:AUTO].....	1483
SYSTem:TIME.....	1428
TRACe<n>:COPY.....	1247
TRACe<n>[:DATA].....	1258
TRACe<n>[:DATA]:MEMory?.....	1260
TRACe<n>[:DATA]:X?.....	1261
TRIGger[:SEQuence]:BBPower:HOLDoff.....	1530

TRIGger[:SEQuence]:DTIME.....	1218
TRIGger[:SEQuence]:HOLDoff[:TIME].....	1218
TRIGger[:SEQuence]:IFPower:HOLDoff.....	1218
TRIGger[:SEQuence]:IFPower:HYSTeresis.....	1219
TRIGger[:SEQuence]:LEVel:BBPower.....	1219
TRIGger[:SEQuence]:LEVel:IFPower.....	1220
TRIGger[:SEQuence]:LEVel:IQPower.....	1220
TRIGger[:SEQuence]:LEVel:RFPower.....	1221
TRIGger[:SEQuence]:LEVel:VIDeo.....	1221
TRIGger[:SEQuence]:LEVel[:EXTErnal<port>].....	1219
TRIGger[:SEQuence]:RFPower:HOLDoff.....	1530
TRIGger[:SEQuence]:SLOPe.....	1221
TRIGger[:SEQuence]:SOURce.....	1221
TRIGger[:SEQuence]:TIME:RINTerval.....	1223
UNIT<n>:PMETer<p>:POWer.....	1184
UNIT<n>:PMETer<p>:POWer:RATio.....	1184
UNIT<n>:POWer.....	1207

# Index

## Symbols

*IDN	
Format	856
# of Samples	
Softkey (APD, CCDF)	299
% Power Bandwidth	
Softkey	213
1xEV-DO BTS	
Application	113
1xEV-DO MS	
Application	113
3G FDD BTS	
Application	114
3G FDD UE	
Application	114
5G NR	
Application	114
75 ohm (channel bar)	84
802.11ad	
Application	114

## A

Aborting	
Sweep	506, 507, 640
AC (channel bar)	84
AC/DC coupling	364
Acoustic	
Monitoring	587
ACLR	
MSR signals	159
Programming example	971
Results (remote)	912
see CP/ACLR	149
ACLR Mode	
Softkey	169, 179
Active	
Transducer lines	758
Active probe	
Microbutton	411
Adjacent channels	
MSR	185
MSR ACLR	184
MSR, bandwidth	185
MSR, configuring	185
MSR, spacing	185
MSR, weighting filters	186
Adjust settings	
Softkey (APD)	299, 304
Softkey (C/N)	209
Adjust Settings	
Softkey (CP/ACLR)	170, 180
Softkey (OBW)	214
Adjust X-Axis	
Softkey	288
Alignment	
Basics	726
Performing	733, 734
Results	727, 728, 733
Settings	728
touchscreen	728, 732
Touchscreen	728

Alignment Signal Source	
Connector	59
Alignment Signal Source (option B2000)	
Connector	52
All Functions Off	586
Alpha	
RRC filter (SEM)	257
Alphanumeric parameters	95
AM modulation	
Measurement example	140, 141
AM modulation depth	329
About	329
Configuring	330
Determining	332
Markers	331
Markers (remote control)	1078
Measurement (remote control)	1078
Programming example	1079
Results	330
Results (remote control)	1078
Search signals	331
Search signals (remote control)	1078
Amplifier Measurement	
Application	115
Amplitude	
Configuration	481
Distribution, white noise	306
Optimizing display	491
Probability, white noise	306
Scaling	491
Settings	481
Analog Baseband	
Input	366
Analog Baseband interface	
Connectors	49, 57
Analog Modulation Analysis	
Application	115
Analysis bandwidth	298
Statistics	298, 306, 308
Analysis BW	
Softkey (APD, CCDF)	298
Analysis region	
Shifting	545
Zooming	545
AnBW (channel setting)	82
Annotations	
Hiding/restoring	737
AP (trace information)	85
APD	293
About	293
Activating (remote control)	1051
Application	294
Configuring	298
Gate (remote control)	1053
Gate ranges	300
Gated trigger	296, 299
Measurement (remote control)	1051
Measurement example	306
Performing	298, 304
Results	294
Results (remote control)	1052
Scaling (remote control)	1056



- see also Statistics ..... 293
    - Using gate ranges ..... 304
  - Application cards ..... 24
  - Application notes ..... 24
  - Applications
    - 1xEV-DO BTS ..... 113
    - 1xEV-DO MS ..... 113
    - 3G FDD BTS ..... 114
    - 3G FDD UE ..... 114
    - 5G NR ..... 114
    - 802.11ad ..... 114
    - Amplifier Measurement ..... 115
    - Analog Modulation Analysis ..... 115
    - Available ..... 111
    - Avionics ..... 115
    - Bluetooth ..... 115
    - cdma2000 BTS ..... 115
    - cdma2000 MS ..... 116
    - DOCSIS 3.1 ..... 119
    - Group Delay ..... 116
    - GSM ..... 116
    - HRP UWB ..... 116
    - I/Q Analyzer ..... 116
    - LTE ..... 117
    - NB-IoT ..... 117
    - Noise Figure ..... 117
    - OFDM Vector Signal Analysis (VSA) ..... 117
    - OneWeb ..... 117
    - Phase Noise ..... 117
    - Pulse ..... 118
    - Real-Time Spectrum ..... 118
    - Setting ..... 120
    - Signal and Spectrum Analyzer mode ..... 109
    - Spectrum ..... 113
    - Spurious Measurements ..... 116
    - TD-SCDMA BTS ..... 118
    - TD-SCDMA UE ..... 118
    - Transient Analysis ..... 118, 119
    - Vector Signal Analysis (VSA) ..... 119
    - WLAN ..... 119
  - APX
    - External generator ..... 380, 384
  - APX (channel bar) ..... 84
  - Arranging
    - Windows ..... 105, 540
  - Arrow keys ..... 46
  - ASCII trace export ..... 657
  - Att (channel setting) ..... 82
  - Attenuation
    - Auto ..... 486
    - Electronic ..... 487
    - Impact ..... 480
    - Manual ..... 486
    - Option ..... 487
    - Protective (remote) ..... 1110
  - Audio demodulation
    - Volume (remote control) ..... 1190
  - Audio output
    - Configuring ..... 587
    - Marker demodulation ..... 579
  - Audio Output
    - Programming example ..... 1326, 1327
  - Audio signals
    - Output (remote) ..... 467, 1188
  - Auto adjustment
    - Triggered measurement ..... 1235
  - Auto all ..... 531
  - Auto frequency ..... 531
  - Auto ID
    - External Mixer ..... 418, 428
    - External Mixer (remote) ..... 1145
    - Threshold (External Mixer, remote control) ..... 1146
    - Threshold (External Mixer) ..... 429
  - Auto level
    - Hysteresis ..... 532, 533
    - Reference level ..... 486, 532
    - Softkey ..... 486, 532
  - Auto Peak detector ..... 609
  - Auto peak search ..... 339
  - Auto scaling ..... 490
  - Auto settings
    - Meastime Auto ..... 532
    - Meastime Manual ..... 532
  - Autologin mechanism
    - Activating/Deactivating ..... 879
  - Automatic coupling
    - Frequencies, external generator ..... 382, 387
  - AUX control
    - TTL synchronization, external generator ..... 376
  - Aux. Port
    - Connector ..... 56
  - AV (trace information) ..... 85
  - Average count ..... 497, 504, 625
    - Power sensor ..... 372
  - Average detector ..... 609
  - Average mode
    - Traces ..... 625
  - Averaging
    - Continuous sweep ..... 619
    - Single sweep ..... 619
    - Sweep count ..... 619
    - Traces ..... 620
    - Traces (algorithm) ..... 619
    - Traces (remote control) ..... 1245
  - Avionics
    - Application ..... 115
- ## B
- B2000/B5000
    - External mixers ..... 416
  - Band
    - Conversion loss table ..... 433
    - External Mixer ..... 425
    - External Mixer (remote) ..... 1148
  - Band power markers
    - Programming example ..... 1325
  - Band power measurement
    - Activating/Deactivating ..... 578
    - Deactivating ..... 579
    - Power mode ..... 579
    - Span ..... 579
  - Band power measurement (remote control) ..... 1307
  - Bandwidth
    - Configuration (Softkey) ..... 498
    - Coupling ..... 494
    - CP/ACLR ..... 172
    - Default settings ..... 492
    - MSR sub blocks ..... 182
    - MSR, adjacent channels ..... 185
    - MSR, gap channels ..... 190
    - MSR, TX channel ..... 183
    - Resolution ..... 347, 492, 501
    - Video ..... 493, 501

- Baseband Input
  - Connectors ..... 49, 57
- BB Power
  - Trigger (softkey) ..... 516
- Bias
  - Conversion loss table ..... 429, 433
  - External Mixer ..... 413, 429
  - External Mixer (remote) ..... 1145
- Bluetooth
  - Application ..... 115
- Brochures ..... 23
- Burst signals
  - Measurement example ..... 143
- C**
- C/N, C/N0
  - see Carrier-to-Noise ..... 206
- Calibration
  - Analog Baseband ..... 800
  - Analog Baseband (remote control) ..... 1400
  - External generator ..... 379
  - External generator, remote ..... 1171
  - Frequency ..... 798
  - Frequency MW ..... 800
  - Frequency RF ..... 799
  - How to, external generator ..... 394
  - Normalization, external generator ..... 391
  - Performing with external generator ..... 393
  - Reference trace, external generator ..... 380
  - Reflection open measurement, external generator ... 391
  - Reflection short measurement, external generator ... 391
  - Remote ..... 893
  - Remote control ..... 1394
  - Removing component effects, external generator .... 395
  - Restoring settings, external generator ..... 381, 391
  - Results (remote control) ..... 1398
  - RF ..... 799
  - Settings ..... 798
  - Signal ..... 798
  - Signal, as RF input ..... 62
  - Storing results, external generator ..... 380
  - Transmission measurement, external generator ..... 391
- Calibration Frequency MW ..... 1399
- Capture time
  - see also Measurement time ..... 1202, 1204
- Carrier Noise Config
  - Softkey ..... 208
- Carrier-to-Noise ..... 206
  - Activating ..... 208, 209
  - Channel bandwidth ..... 209
  - Channel bandwidth (remote control) ..... 979
  - Configuring ..... 208
  - Determining ..... 209
  - Measurement ..... 207
  - Measurement (remote control) ..... 979
  - Results ..... 207
  - Results (remote control) ..... 979
  - Span ..... 207
- CCDF ..... 293
  - About ..... 293
  - Activating (remote control) ..... 1051
  - Application ..... 294
  - Configuring ..... 298
  - Crest factor ..... 295
  - Gate (remote control) ..... 1053
  - Gate ranges ..... 300
  - Gated trigger ..... 296, 299
  - Measurement (remote control) ..... 1051
  - Measurement example ..... 306
  - Percent marker ..... 296, 298
  - Percent marker (remote control) ..... 1052
  - Performing ..... 298, 304
  - Results ..... 295
  - Results (remote control) ..... 1052
  - Scaling (remote control) ..... 1056
  - see also Statistics ..... 293
  - Using gate ranges ..... 304
- cdma2000 BTS
  - Application ..... 115
- cdma2000 MS
  - Application ..... 116
- Center = Mkr Freq ..... 565
- Center frequency ..... 474
  - Automatic configuration ..... 531
  - MSR sub blocks ..... 182
  - MSR TX channel ..... 183
  - Setting to marker ..... 565
  - Softkey ..... 474
  - Step size ..... 471, 476, 478
  - Sub blocks (Multi-SEM) ..... 255
- Centroid frequency
  - OBW measurement ..... 212
- Channel
  - Creating (remote) ..... 899, 901, 902
  - Deleting (remote) ..... 899
  - Duplicating (remote) ..... 898
  - Querying (remote) ..... 899
  - Renaming (remote) ..... 902
  - Replacing (remote) ..... 899
  - Selecting (remote) ..... 901, 902
- Channel bandwidth
  - C/N ..... 209
  - CP/ACLR ..... 172
  - MSR TX channel ..... 183
  - MSR, adjacent channels ..... 185
  - MSR, gap channels ..... 190
- Channel Bandwidth
  - OBW ..... 214
  - Softkey ..... 214
- Channel bar
  - Changing names ..... 84
  - Hiding/restoring ..... 737
  - Information ..... 81
  - Information, external generator ..... 384
- Channel power
  - Comparing (CP/ACLR) ..... 197
  - Density (CP/ACLR) ..... 169, 180
  - SEM results ..... 234
  - Settings (SEM) ..... 257
- channel settings
  - Presetting ..... 675
- Channel settings
  - Display ..... 81, 82
- Channel-defined Sequencer
  - Softkey ..... 125
- Channels
  - CP/ACLR ..... 171, 181, 193
  - CP/ACLR measurements ..... 167
  - Duplicating ..... 122
  - Names (CP/ACLR) ..... 175
  - New ..... 121
  - Operating modes ..... 109
  - Replacing ..... 122

- see also Measurement channels ..... 100
  - Sequential operation ..... 122
  - Spacings (CP/ACLR) ..... 172
  - Spacings, configuring ..... 194
  - Switching ..... 81
  - Trying out ..... 65
  - Weighting filters ..... 175
- CISPR average
  - Detector ..... 336
- CISPR Average detector
  - EMI ..... 337
- CISPR bandwidth ..... 335, 349
- Clear status
  - Remote ..... 893
- Close
  - Show SCPI command ..... 840
- Closing
  - Channels ..... 102
  - Channels (remote) ..... 899
  - Windows ..... 105, 540
  - Windows (remote) ..... 1105
- CLRW (trace information) ..... 85
- CMT
  - Display ..... 316
- CNT (marker functions) ..... 86
- Color curve
  - Shape ..... 635, 642
  - Spectrograms ..... 635, 645
- Color mapping
  - Color curve ..... 642
  - Color range ..... 641, 642
  - Color scheme ..... 642
  - Softkey ..... 639
  - Spectrograms ..... 634, 639, 641, 644
  - Step by step ..... 644
  - Value range ..... 635
- Color scheme
  - Spectrogram ..... 635, 642
- Colors
  - Assigning to object ..... 742
  - Configuring ..... 741, 745
  - Display ..... 739
  - Editing ..... 739
  - Editing (remote) ..... 1429
  - Predefined ..... 742
  - Print ..... 741
  - Printing ..... 739
  - Restoring ..... 743
  - Screen ..... 740
  - User-defined ..... 741
  - User-specific ..... 743
- Command sequence
  - Remote ..... 897
- Commands
  - Tracking ..... 856
- Comment
  - Gate ranges (statistics) ..... 300
  - Limit lines ..... 601
  - Screenshots ..... 696
  - Softkey ..... 696
  - Transducer lines ..... 760
- Common mode offset
  - Probes ..... 405
- Compatibility
  - FSQ, FSP, FSU, FSV ..... 858
  - GPIB ..... 857
  - Limit lines ..... 593, 599
  - Mode ..... 858
  - Transducer lines ..... 758
- Compatible mode (channel setting) ..... 83
- Compensation
  - After calibration, external generator ..... 395
- Computer name ..... 853
- Connector
  - AC power supply ..... 54
  - Aux. Port ..... 56
  - BASEBAND INPUT ..... 49, 57
  - Digital I/Q 40G Streaming Out ..... 55
  - Display Port ..... 55
  - DVI ..... 55
  - External mixer ..... 49
  - External Mixer ..... 434
  - GPIB interface ..... 56
  - IF OUT 2 GHz / 5 GHz ..... 60
  - IF/VIDEO/DEMODO ..... 57
  - LAN ..... 54
  - Noise source control ..... 50
  - OCXO ..... 60
  - PHONES ..... 51
  - Power Sensor ..... 50
  - Probe ..... 50
  - REF INPUT ..... 59
  - RF Input 50 ohm ..... 48
  - SYNC TRIGGER ..... 57
  - TRIGGER 3 ..... 57
  - TRIGGER INPUT / OUTPUT ..... 47
  - USB ..... 51, 54
  - VOLUME ..... 51
- Connectors
  - AUX control, external generator ..... 376
  - EXT REF ..... 780
  - External generator control ..... 376
  - GPIB ..... 376
  - REF OUTPUT ..... 782
  - SYNC TRIGGER ..... 780
- Context menus ..... 92
- Continue single sweep
  - Softkey ..... 130, 507
- Continuous gating
  - Programming example ..... 1232
- Continuous Sequencer
  - Softkey ..... 125
- Continuous sweep
  - Softkey ..... 130, 506, 640
- Conventions
  - SCPI commands ..... 891
- Conversion loss
  - External Mixer (remote) ..... 1150, 1152
- Conversion loss tables ..... 430
  - Available (remote) ..... 1154
  - Band (remote) ..... 1153
  - Bias (remote) ..... 1153
  - Configuring ..... 430
  - Creating ..... 431
  - Deleting (remote) ..... 1154
  - External Mixer ..... 414, 427
  - External Mixer (remote) ..... 1151
  - Harmonic order (remote) ..... 1155
  - Importing (External Mixer) ..... 431
  - Managing ..... 429
  - Mixer type (remote) ..... 1156
  - Saving (External Mixer) ..... 434
  - Selecting (remote) ..... 1156

- Shifting values (External Mixer) ..... 434
- Values (External Mixer) ..... 434
- Copy
  - Show SCPI command ..... 840
- Copying
  - Channel (remote) ..... 898
  - Traces ..... 627
- Coupling
  - Automatic, external generator ..... 382, 387
  - Frequencies, external generator ..... 382
  - GPIB ..... 859
  - GPIB (remote control) ..... 1488
  - Manual, external generator ..... 387
  - Span/RBW ..... 494
  - VBW/RBW ..... 494
- Coupling ratio
  - Span/RBW (remote) ..... 1199
- Coupling ratios
  - Default ..... 503
  - RBW/VBW ..... 502
  - Span/RBW ..... 502
- CP/ACLR ..... 149
  - About ..... 149
  - Absolute/relative values ..... 169, 179
  - Adjust Settings ..... 170, 180
  - Channel bandwidths ..... 172
  - Channel bandwidths (remote control) ..... 918
  - Channel names ..... 175
  - Channel names (remote control) ..... 918
  - Channel power density ..... 169, 180
  - Channel setup ..... 171, 181
  - Channel setup (remote control) ..... 918
  - Channel spacing ..... 194
  - Channel spacing (remote control) ..... 918
  - Channel spacings ..... 172
  - Clear/Write ..... 170, 180
  - Comparing channel powers ..... 197
  - Configuring ..... 165
  - Configuring MSR signals ..... 175
  - Detector ..... 158
  - Fast ACLR ..... 153, 169
  - Fixed reference for CP ..... 170
  - Frequency span ..... 157
  - General Settings ..... 165
  - General Settings for MSR ..... 176
  - IBW method ..... 152
  - Limit check ..... 173
  - Limit check (remote control) ..... 925
  - Max Hold ..... 170, 180
  - Measurement (remote control) ..... 915
  - Measurement examples ..... 197
  - Measurement methods ..... 152
  - Mode ..... 169, 179
  - Multicarrier ..... 152
  - Noise cancellation ..... 168, 179, 489
  - Number of channels ..... 167
  - Number of channels (remote control) ..... 918
  - Optimizing ..... 203
  - Performing ..... 165
  - Performing measurement ..... 193, 194
  - Power mode ..... 170, 180
  - Power Unit ..... 169, 180
  - Predefined Settings ..... 166, 177
  - Predefined standards ..... 204, 205
  - RBW ..... 157
  - Reference channel ..... 168, 178
  - Reference channel (remote control) ..... 924
  - Reference level ..... 159
  - Repeatability ..... 154
  - Results ..... 150, 968
  - Setting up channels ..... 193
  - Setting up channels (remote control) ..... 918
  - Standards ..... 166, 177
  - Standards (remote control) ..... 916
  - Standards (Softkey) ..... 166, 177
  - Sweep Time ..... 156, 170
  - Trace averaging ..... 159
  - Trace Selection ..... 169, 179
  - Troubleshooting ..... 203
  - User-defined standards ..... 166, 177, 196
  - VBW ..... 158
  - W-CDMA signals ..... 200
  - Weighting filters ..... 175
  - Weighting filters (remote control) ..... 922
- Crest factor
  - APD ..... 295
  - CCDF ..... 295
- Cumulated Measurement Time (CMT)
  - Harmonics ..... 316
- Customer support ..... 1553
- D**
  - Data entry
    - Switching modes ..... 95
  - Data format
    - ASCII ..... 1261
    - Binary ..... 1261
    - Remote ..... 1263, 1373
  - Data sheets ..... 23
  - Data shift ..... 545
  - Data zoom ..... 545
  - Date
    - Format ..... 736
    - Hiding/restoring ..... 737
    - Instrument setting ..... 735
  - Date and Time
    - Printing ..... 697
  - DC (channel bar) ..... 84
  - DC offset
    - Analog Baseband (B71, remote control) ..... 1143
  - Debugging
    - Remote control programs ..... 1547
  - Decimal separator
    - Trace export ..... 652, 654, 692
  - Default
    - Restoring settings ..... 674
  - Default coupling ..... 503
  - Default values
    - Remote ..... 896
  - Deleting
    - Limit line values ..... 603
    - Settings files ..... 264
    - Standards ..... 264
    - Transducer factors ..... 761
  - Delta markers ..... 343, 553
    - Defining ..... 343, 553, 569
    - Fixed reference marker ..... 587
    - Remote control ..... 1268
  - Demodulation
    - Activating (marker) ..... 581
    - Continuous (marker) ..... 581
    - Marker ..... 579, 587
    - Marker stop time ..... 581

- Modulation type ..... 581
- Remote control ..... 1316
- Squelch ..... 581
- Squelch level ..... 582
- Demodulation markers
  - Programming example ..... 1326, 1327
- Denominator
  - Frequencies, external generator ..... 382, 387
- Detectors
  - CP/ACLR ..... 158
  - EMI ..... 336
  - Overview ..... 609
  - Remote control ..... 1246
  - Spurious Emissions range ..... 285
  - Trace ..... 344, 348, 624
- Device
  - Softkey ..... 696, 700, 703
- Device ID ..... 796, 797, 1448
- DHCP ..... 854, 872
  - External frontend ..... 457
- Diagnostics
  - Hardware ..... 802
- Diagram area
  - Channel settings ..... 82
  - Status display ..... 87
  - Trace information ..... 85
- Diagram footer ..... 87
  - Hiding/restoring ..... 737
- Diagrams
  - Evaluation method ..... 535
- Dialog boxes
  - Slider ..... 94
  - Transparency ..... 94
- Dialogs
  - Printing ..... 697
  - Suppressing file selection ..... 701
- Digital I/Q
  - 40G Streaming Out Connector ..... 55
- Direct path
  - Input configuration ..... 365
- Dirty flag
  - see Invalid data icon ..... 81
- Display
  - Colors ..... 739, 745
  - Config (Softkey) ..... 534
  - Evaluation bar ..... 104, 539
  - Evaluation methods ..... 534
  - Information ..... 80
  - SCPI list ..... 841
  - Settings ..... 734
  - Settings (remote control) ..... 1425
  - SmartGrid ..... 102, 537
  - Theme ..... 739
  - Theme (remote) ..... 1429
  - Update (remote) ..... 856
  - Update rate ..... 735
- Display lines ..... 591
  - Defining ..... 592
  - Settings ..... 591
- Display Port
  - Connector ..... 55
- Displayed items
  - Touchscreen ..... 736
- Disposal ..... 1554
- DNS server
  - IP Address ..... 873
- DOCSIS 3.1
  - Application ..... 119
- Drop-out time
  - Trigger ..... 510, 518
  - Trigger (Power sensor) ..... 373
- Duplicating
  - Channel (remote) ..... 898
- Duty cycle
  - Power sensor ..... 372
- DVI
  - Connector ..... 55
- Dwell time ..... 340, 348
  - EMI detectors ..... 336
- Dynamic range
  - Intermodulation-free ..... 323
  - Measuring ..... 314
- E**
- Edge gate
  - Slope ..... 519
- Electromagnetic compatibility
  - see EMC ..... 332
- Electronic input attenuation ..... 486, 487
- EMC ..... 332
- EMI ..... 332
  - Detectors ..... 336
  - Measurement ..... 333
  - Refining results ..... 340
- EMI marker evaluation ..... 340
- EMI measurement
  - Programming example ..... 1087
- Enable registers
  - Remote ..... 895
- Entering data ..... 94
- EOI
  - GPIB terminator ..... 856
- Error log ..... 1550
- Error messages
  - Status bar ..... 88, 1543
- Error queue ..... 825
- Errors
  - External generator ..... 384
  - IF OVLD ..... 484, 1544
  - Increase sweep points (EMI) ..... 356
  - INPUT OVLD ..... 833, 1544
  - LO UNL ..... 1544
  - Messages, device-specific ..... 1545
  - NO REF ..... 1544
  - OVEN ..... 1544
  - OVENCOLD ..... 1544
  - OVLD ..... 833
  - RF OVLD ..... 833, 1544
  - UNCAL ..... 1544
  - UNLD ..... 833
  - WRONG\_FW ..... 726, 790, 1544, 1545
- ESE (event status enable register ) ..... 825
- ESR (event status register) ..... 825
- Evaluation
  - Lists (SEM) ..... 264
  - Lists (Spurious) ..... 288
  - Modes ..... 534
  - Modes, adding ..... 104, 539
  - Trying out ..... 63
- Evaluation bar
  - Using ..... 104, 539

- Evaluation list
  - Details (Spurious Emissions) ..... 290
  - Peaks (Spurious Emissions) ..... 290
  - Spurious Emissions ..... 280
- Evaluation methods
  - Remote ..... 1100
- Event status enable register (ESE) ..... 825
  - Remote ..... 893
- Event status register (ESR) ..... 823, 825
  - Remote ..... 893
- EVM optimized (channel bar) ..... 84
- Example
  - Calibration with an external generator ..... 396
  - Remote control of an external generator ..... 1174
- Exclude LO ..... 558, 562
  - Remote ..... 1277
- Export
  - SCPI list ..... 842, 844, 846
- Export format
  - SEM results ..... 278
  - Spurious Emissions results ..... 292
  - Traces ..... 657
- Exporting
  - Data ..... 692
  - Functions ..... 683
  - I/Q data ..... 692
  - Measurement settings ..... 651
  - Peak list ..... 585, 588, 656
  - SEM result files ..... 270
  - Softkey ..... 690
  - Spurious Emissions result files ..... 291
  - Trace data ..... 655
  - Traces ..... 650, 652, 690, 692
- EXREF (status display) ..... 1544
- EXT REF
  - Status message ..... 87
- Ext.Gen (channel bar) ..... 84
- External generator ..... 375
  - Activating/Deactivating ..... 386
  - Basics ..... 376
  - Calibration functions ..... 390
  - Calibration measurement settings ..... 386
  - Channel bar information ..... 384
  - Connections ..... 376
  - Coupling frequencies ..... 382
  - Errors ..... 384
  - Interface ..... 389
  - Interface settings ..... 388
  - Normalizing ..... 391
  - Overloading ..... 385
  - Recalling calibration settings ..... 391
  - Reference level ..... 381
  - Reference line ..... 381
  - Reference line position ..... 392
  - Reference line value ..... 392
  - Reference position ..... 392
  - Reference trace ..... 381
  - Reference value ..... 392
  - Reflection measurement ..... 378
  - Reflection open measurement ..... 391
  - Reflection short measurement ..... 391
  - Remote control ..... 1165
  - Settings ..... 385
  - Transducer factor ..... 381, 392
  - Transmission measurement ..... 378, 391
  - TTL synchronization ..... 376
- External mixer
  - Connector ..... 49
- External Mixer ..... 411, 424
  - 2-port vs 3-port ..... 412
  - Activating (remote) ..... 1144
  - Band ..... 425, 1147
  - Basic settings ..... 427
  - Bias current ..... 413
  - Configuration ..... 423
  - Connector ..... 434
  - Conversion loss ..... 427
  - Conversion loss tables ..... 414, 430, 431
  - Frequency range ..... 411, 424
  - General information ..... 411
  - Handover frequency ..... 425
  - Harmonic Order ..... 426
  - Harmonic Type ..... 426
  - Measurement example ..... 437
  - Name ..... 433
  - Programming example ..... 1157
  - Range ..... 426
  - Restoring bands ..... 425
  - RF overrange ..... 425, 1152
  - RF Start/RF Stop ..... 424
  - Serial number ..... 433
  - Type ..... 426, 434, 1152
- External mixers
  - B2000/B5000 ..... 416
- External monitor
  - Connectors ..... 55
- External reference
  - External generator ..... 379
  - External generator control ..... 389
  - Frequency ..... 782
  - Input ..... 780
  - Loop bandwidth ..... 782
  - Missing ..... 781
  - Output ..... 782
  - Settings ..... 779
  - Settings (remote control) ..... 1389
  - Status message ..... 87
  - Tuning range ..... 782
- External trigger ..... 514
  - Configuring power sensor ..... 375
  - Level (power sensor) ..... 372
  - Level (remote) ..... 1219
  - Power sensor ..... 372
- ExtMix (channel bar) ..... 84
- F**
- Falling
  - Slope (Power sensor) ..... 373
- Fast ACLR
  - Activating/Deactivating ..... 169
  - Measurement method ..... 153
- Fast SEM ..... 242
  - Consequences ..... 243
  - Example ..... 243
  - Multi-SEM ..... 242, 244
  - Prerequisites ..... 242
  - SEM ..... 250
- FFT filters
  - Mode ..... 504
- FFT sweep ..... 495, 505

- File format
    - Export Files ..... 657
    - SEM export files ..... 278
    - SEM settings files ..... 272
    - Spurious Emissions export files ..... 292
    - Trace export ..... 657
  - File type
    - Storage settings ..... 684
  - filename
    - Data files ..... 682
    - Settings ..... 263, 684, 687
  - Filter type (EMI) ..... 335, 349
  - Filter types ..... 346, 496, 503
    - SEM range ..... 250
    - Spurious Emissions range ..... 285
  - Filters
    - 5-pole ..... 497
    - Channel ..... 497
    - Configuration ..... 498
    - FFT ..... 504
    - Gaussian (3dB) ..... 497
    - High-pass (RF input) ..... 365
    - RBW ..... 492
    - RRC ..... 497
    - VBW ..... 493
    - Weighting (remote) ..... 922
    - YIG (remote) ..... 1112
  - Final test ..... 340
  - Firmware
    - Updating ..... 790
  - Firmware Update
    - Remote control ..... 1450
  - Fixed reference
    - Configuring ..... 587
    - Defining ..... 556, 575
    - Delta markers ..... 587
    - Remote control ..... 1298
  - Focus
    - Changing ..... 94
  - Focus area
    - Switching between windows ..... 52
  - Format
    - Data ..... 1261
    - Data (remote) ..... 1263, 1373
    - Date and time ..... 736
    - see also File format ..... 657
  - Frame count
    - Softkey ..... 508
    - Spectrograms ..... 631
  - Frames
    - Spectrogram marker ..... 553
  - Free Run
    - Trigger ..... 514
  - Frequencies
    - Multi-SEM ..... 244
  - Frequency
    - Configuration (Softkey) ..... 473
    - Coupling (power sensor) ..... 370
    - External generator ..... 387
    - External reference ..... 782
    - IF Out ..... 467
    - Offset ..... 476
    - Power sensor ..... 370
    - Range ..... 471
    - Range, defining ..... 478
    - Reference ..... 779
    - Reference (remote control) ..... 1389
    - Span ..... 474
    - Start ..... 475
    - Step size ..... 471
    - Stop ..... 475
    - Sweep ..... 505
  - Frequency axis
    - Scaling ..... 349, 472, 475
  - Frequency coupling
    - Automatic, external generator ..... 382
    - External generator ..... 382, 387
    - Reverse sweep, external generator ..... 384
    - TTL synchronization, external generator ..... 383
  - Frequency denominator
    - External generator ..... 387
  - Frequency numerator
    - External generator ..... 387
  - Frequency offset
    - External generator ..... 382, 387
  - Frequency range
    - Calibration sweep, external generator ..... 383, 388
    - Extending ..... 411
    - External Mixer ..... 411
  - Frequency span
    - CP/ACLR ..... 157
  - Frequency sweep
    - Measurement ..... 129
    - Programming example ..... 1531
  - Frequency-converting measurements
    - External generator ..... 382
  - Front panel
    - Hiding/restoring ..... 738
  - Frontend
    - Temperature ..... 727
    - Temperature (remote) ..... 1401
    - Temperature, status bit ..... 833
  - FRQ
    - External generator ..... 384
  - Frq (channel bar) ..... 84
  - Full span
    - Softkey ..... 475
  - Function keys
    - Details - see User Manual ..... 44
    - Overview ..... 44
  - FXD (marker functions) ..... 86
- ## G
- Gap
    - MSR, spacing ..... 189
  - Gap channels
    - MSR ACLR ..... 187
    - MSR, bandwidth ..... 190
    - MSR, configuring ..... 189
    - MSR, weighting filters ..... 191
  - GAT (channel bar) ..... 83
  - Gate
    - Delay ..... 526
    - Length ..... 526
    - Measurements ..... 521
    - Mode ..... 525
    - Ranges (statistics) ..... 296
    - Settings ..... 524
  - Gate ranges
    - Activating (statistics) ..... 301
    - Comment (statistics) ..... 300
    - Period (statistics) ..... 300

- Start/Stop (statistics) ..... 301
- Statistics ..... 300
- Gated trigger
  - Activating ..... 525
  - Configuring (statistics) ..... 300, 304
  - Delay ..... 526
  - Example ..... 305
  - Length ..... 526
  - Mode ..... 525
  - Softkey ..... 299
  - Statistics ..... 296, 299, 308
- Gating
  - Source ..... 514
- Generator
  - Frequencies, external generator ..... 382, 387
  - Frequency coupling, external generator ..... 387
  - Frequency offset, external generator ..... 387
  - Output power, external generator ..... 387
- Generator type
  - External generator ..... 389
- Generators
  - Frequency range, external generator ..... 390
  - Power range, external generator ..... 390
  - Setup files, external generator ..... 379, 389, 390
- Getting started ..... 22
- GPIB ..... 817
  - Address ..... 855, 877
  - Address, External generator ..... 389
  - Characteristics ..... 821
  - Coupling ..... 859
  - External generator ..... 389
  - IF Gain (remote control) ..... 1489
  - Language ..... 858
  - Language (remote control) ..... 1489
  - Settings ..... 854
  - Terminator ..... 856
  - TTL synchronization, External generator ..... 389
- GPIB bus control
  - Remote ..... 895
- GPIB interface
  - Configuring - see user manual ..... 56
  - Connector ..... 56
- GPIB Language ..... 835
- Graphical zoom ..... 99
- Group delay
  - Smoothing ..... 625
- Group Delay
  - Application ..... 116
- GSM
  - Application ..... 116
- H**
- Handover frequency
  - External Mixer ..... 412, 425
  - External Mixer (remote) ..... 1147
- Hard drive
  - Removable ..... 54
- Hardcopy
  - see Screenshots ..... 78
- Hardware
  - Check ..... 790
  - Diagnostics ..... 802
  - Information ..... 783
  - Supported ..... 790
- Harmonic Distortion ..... 313
  - About ..... 314
  - Activating (remote control) ..... 1071
  - Basics ..... 314
  - Configuring ..... 317
  - Measurement (remote control) ..... 1071
  - Measuring ..... 319
  - RBW ..... 318
  - Results ..... 316
  - Results (remote control) ..... 1072
  - Sweep time ..... 318
- Harmonics
  - Basics ..... 314
  - Conversion loss table ..... 433
  - External Mixer (remote) ..... 1149, 1150
  - High-sensitivity ..... 316
  - LO ..... 411
  - Measurement example ..... 589
  - Measurement rules ..... 315
  - Measurement time ..... 316
  - Number ..... 318
  - Order (External Mixer) ..... 426
  - Origin ..... 316
  - Power ..... 317
  - Second harmonic intercept ..... 314
  - Type (External Mixer) ..... 426
- Headphones
  - Connector ..... 51
- Help ..... 107
- Hiding/restoring
  - Display items ..... 736
- High-pass filter
  - RF input ..... 365
- Highpass filter
  - LISN control (EMI) ..... 350
- HiSLIP
  - Resource string ..... 818
- History
  - Spectrograms ..... 639
- History Depth
  - Softkey ..... 639
- Hold
  - Trace setting ..... 624
- Horizontal Line 1/2
  - Softkeys ..... 592
- HP emulation ..... 1491
- HRP UWB
  - Application ..... 116
- Hysteresis
  - Lower (Auto level) ..... 533
  - Trigger ..... 518
  - Trigger (Power sensor) ..... 373
  - Upper (Auto level) ..... 532
- I**
- I/O Logging ..... 856
- I/Q Analyzer
  - Application ..... 116
  - Trying out ..... 65
- I/Q data
  - Exporting ..... 692
- I/Q Power
  - Trigger ..... 516
  - Trigger level (remote) ..... 1220
- IBW method
  - CP/ACLR measurements ..... 152



- ID String User ..... 835
- Identification
  - Remote ..... 894
  - String, FSW ..... 855
  - String, resetting (FSW) ..... 855
- IEC/IEEE bus
  - see GPIB ..... 817
- IECWIN ..... 837
- IF frequency
  - Output ..... 360, 467
  - Output (remote) ..... 1188
- IF Gain
  - GPIB ..... 859
  - GPIB (remote control) ..... 1489
- IF High (channel bar) ..... 84
- IF Low (channel bar) ..... 84
- IF OUT 2 GHz
  - Connector ..... 52
- IF OUT 2 GHz / 5 GHz
  - Connector ..... 60
- IF Out Frequency ..... 467
- IF output ..... 467
  - Remote ..... 1188
- IF OVLD
  - Error ..... 1544
- IF Power
  - Trigger ..... 515
  - Trigger level (remote) ..... 1220
- IF/VIDEO/DEMODO
  - Connector ..... 57, 360
- IFCorr (channel bar) ..... 84
- Impedance
  - Setting ..... 364
- Importing
  - Functions ..... 683
  - Softkey ..... 690
- Information
  - Hardware ..... 783
  - Options ..... 784
  - Version ..... 784
- Inherent noise
  - Cancellation ..... 168, 179, 489
- Inp:ExtFe (channel bar) ..... 84
- Input
  - Coupling ..... 364
  - Overload (remote) ..... 1110
  - RF ..... 363
  - Settings ..... 362, 488
  - Signal, parameters ..... 359
  - Source Configuration (softkey) ..... 362
  - Source, Radio frequency (RF) ..... 362
- INPUT OVLD
  - Error ..... 1544
- INPUT OVLD (status display) ..... 1544
- Inserting
  - Limit line values ..... 603
  - Transducer factors ..... 761
- Installing
  - Options ..... 786
- Instrument name
  - Changing ..... 874
- Instrument security procedures ..... 23
- Instrument settings
  - Secure user mode ..... 678
- Interfaces
  - GPIB ..... 821
  - LAN ..... 817
  - USB ..... 821
- Intermodulation products ..... 320
- Invalid data
  - Icon ..... 81
- IP address ..... 818
  - Assigning ..... 872
  - External frontend ..... 457
  - Network ..... 854
- IP Address
  - DNS server ..... 873
- IP configuration
  - LAN ..... 876
- IST ..... 823
- IST flag ..... 825
  - Remote ..... 894
- Items
  - Saving ..... 681, 682
  - Settings ..... 684
- K**
- Key
  - DOWN ..... 46
  - LEFT ..... 46
  - POWER ..... 42
  - Redo ..... 46
  - RIGHT ..... 46
  - Undo ..... 46
  - UP ..... 46
- Keyboard
  - On-screen ..... 93
- Keypad ..... 96
  - Key layout ..... 97
  - Overview ..... 47
- Keys
  - MKR ..... 551
  - MKR -> ..... 557, 563
  - MKR FUNCT ..... 565
  - Peak Search ..... 564
  - PRESET ..... 674
  - RUN CONT ..... 130, 506, 640
  - RUN SINGLE ..... 130, 506, 507, 640
- L**
- LAN
  - Configuration ..... 861
  - Configuring ..... 875
  - Connector ..... 54
  - Interface ..... 817
  - IP address ..... 818
  - LAN configuration ..... 876
  - Password ..... 862
  - Ping ..... 876
  - Remote control interface ..... 816
  - Reset ..... 862
  - Settings ..... 861
  - Web browser interface ..... 875
- LAN web browser access
  - Error ..... 1545
- Last span
  - Softkey ..... 475
- Legacy format
  - \*IDN ..... 856

- Lemosa
  - Connector ..... 50
- LFEOI
  - GPIB terminator ..... 856
- Limit check
  - Activating/Deactivating ..... 605
  - CP/ACLR ..... 173
  - MSR channels ..... 186, 191
  - MSR, activating ..... 181
  - Remote control ..... 1330
  - Results ..... 595
  - SEM range ..... 252
  - Spurious Emissions ..... 283
  - Spurious Emissions range ..... 287
- Limit lines ..... 351, 593, 597
  - Activating/Deactivating ..... 599
  - Calculation (Multi-SEM) ..... 245, 253
  - Comment ..... 601
  - Compatibility ..... 593, 599
  - Compatible ..... 604
  - Copying ..... 600, 605
  - Creating ..... 600, 606
  - Data points ..... 602
  - Deactivating ..... 600
  - Defining ..... 604
  - Deleting ..... 600, 605
  - Deleting values ..... 603
  - Details ..... 600
  - Editing ..... 600, 605
  - Inserting values ..... 603
  - Managing ..... 597
  - Margin ..... 602
  - Margins ..... 594
  - Name ..... 601
  - OBW ..... 214, 559, 563
  - Offsets ..... 595
  - Peak search ..... 214, 559, 563
  - Recalling ..... 678
  - Remote control ..... 1331
  - Saving ..... 603, 678, 682
  - Selecting ..... 599
  - SEM ..... 240, 604
  - Shifting ..... 595, 603, 607
  - Spurious ..... 604
  - Spurious Emissions ..... 282
  - Storing ..... 597
  - Threshold ..... 594, 601
  - Time Domain Power measurement ..... 309
  - Traces ..... 599
  - View filter ..... 599
  - Violation ..... 595
  - Visibility ..... 599
  - X-axis ..... 602
  - X-Offset ..... 599
  - Y-axis ..... 602
  - Y-Offset ..... 600
- Limits
  - Absolute (SEM range) ..... 253
  - Absolute (Spurious Emissions range) ..... 288
  - Relative (SEM range) ..... 253
- Line impedance stabilization network
  - see LISN ..... 338
- Linear scaling
  - X-axis ..... 349, 472, 475
- Lines
  - Configuration ..... 597
  - Display ..... 591, 592
  - Horizontal ..... 592
  - Limit, see Limit lines ..... 597
  - Vertical ..... 592
- Linking
  - Markers ..... 343, 554
- LISN ..... 350
  - Configuration (EMI) ..... 349
  - EMI ..... 338
  - Highpass filter (EMI) ..... 350
  - Phase (EMI) ..... 350
- List evaluation ..... 1089
  - Evaluations ..... 264, 288
  - Saving (SEM) ..... 266
  - Saving (Spurious Emissions) ..... 290
  - SEM ..... 264
  - Softkey ..... 264
  - Spurious Emissions ..... 288
  - State (SEM) ..... 265
  - State (Spurious Emissions) ..... 289
- LO
  - Harmonics ..... 411
  - Level (External Mixer) ..... 428
- LO EXT (channel bar) ..... 84
- LO feedthrough ..... 365
- LO UNL
  - Error ..... 1544
- LO UNL (status display) ..... 1544
- Loading
  - Functions ..... 683
  - Instrument settings ..... 687
  - Settings ..... 677, 679
  - Settings files ..... 263
  - Trying out ..... 78
- Logarithmic scaling
  - Sweep points ..... 472
  - X-axis ..... 349, 472, 475
- Logging
  - Remote control programs ..... 1547
- Login
  - Network ..... 877
  - Secure user mode ..... 36
- Logo
  - Printing ..... 696
- Loop bandwidth
  - External reference ..... 782
- Lower Level Hysteresis ..... 533
- LTE
  - Application ..... 117
- LVL
  - External generator ..... 384
- LVL (channel bar) ..... 84
- M**
- Maintenance ..... 1554
- Manual peak search ..... 339
- Margins
  - Limit lines ..... 594, 602
  - Peaks (SEM) ..... 265
  - Peaks (Spurious Emissions) ..... 289
  - Violation ..... 595
- Marker
  - Information ..... 86
  - Search area (softkey) ..... 562
  - Search type (softkey) ..... 562
- Marker demodulation ..... 351

- Marker functions
  - Deactivating ..... 586
  - Measurement example ..... 589
- Marker peak list
  - see Peak list ..... 585
- Marker Peak List
  - Programming example ..... 1323
- Marker search
  - Spectrograms, programming example ..... 1321
- Marker search area
  - Remote control ..... 1277
- Marker table
  - Evaluation method ..... 535
  - Information ..... 86
- Marker to Trace ..... 344, 554
- Markers ..... 549
  - AM Modulation Depth measurement ..... 331
  - Analyzing in detail ..... 586
  - Assigned trace ..... 344, 554
  - Band power (remote control) ..... 1307
  - Basic settings ..... 551
  - Configuration ..... 551, 555
  - Configuration (remote control) ..... 1268
  - Deactivating ..... 555
  - Delta markers ..... 343, 553, 569
  - Demodulation ..... 579, 587
  - Demodulation (remote control) ..... 1316
  - Fixed reference (remote control) ..... 1275, 1298
  - Function configuration ..... 565
  - Linking ..... 343, 554
  - Minimum ..... 564
  - Minimum (remote control) ..... 1277, 1281
  - n dB down ..... 575
  - n dB down (remote control) ..... 1311
  - Next minimum ..... 564
  - Next minimum (remote control) ..... 1277, 1281
  - Next peak ..... 564
  - Next peak (remote control) ..... 1277, 1281
  - Noise measurement ..... 567
  - Noise measurement (remote control) ..... 1303
  - Peak ..... 564
  - Peak (remote control) ..... 1277, 1281
  - Peak list (remote control) ..... 1300
  - Phase noise measurement ..... 570
  - Phase noise measurement (remote control) ..... 1305
  - Position ..... 342, 553
  - Positioning ..... 563
  - Positioning (remote control) ..... 1268
  - Programming example ..... 1320
  - Remote control ..... 1268
  - Search (remote control) ..... 1277
  - Setting center frequency ..... 565
  - Setting reference level ..... 565
  - Signal count ..... 567
  - Signal count (remote control) ..... 1315
  - Softkeys (AM Modulation Depth) ..... 331
  - Softkeys (TOI) ..... 326
  - Spectrograms ..... 632, 643
  - Spectrograms (remote control) ..... 1289
  - State ..... 342, 552, 569
  - Step size ..... 556
  - Step size (remote control) ..... 1275
  - Table ..... 555
  - Table (evaluation method) ..... 535
  - Table (remote control) ..... 1275
  - Tips ..... 548
  - TOI measurement ..... 326
  - Trying out ..... 69
  - Type ..... 343, 553, 569
  - X-value ..... 342, 553
  - Mask monitoring
    - SEM ..... 234
  - MAXH (trace information) ..... 85
  - Maximize
    - Window ..... 106
  - Maximizing
    - Display ..... 52
    - Windows (remote) ..... 1099, 1252
  - Meas Time (channel setting) ..... 82
  - Measurement accuracy
    - External generator ..... 380
  - Measurement channels
    - Activating ..... 100
    - Closing ..... 102
  - Measurement examples
    - AF of AM-modulated signal ..... 141
    - AM modulation ..... 140
    - CP/ACLR ..... 197, 199
    - External Mixer ..... 437
    - Harmonics ..... 589
    - Intermodulation ..... 327
    - Level and frequency ..... 131
    - Marker functions ..... 589
    - OBW ..... 216
    - Power of burst signals ..... 143
    - Separating signals ..... 137
    - Signal frequency using signal counter ..... 133
    - Signal-to-noise ratio ..... 147
    - Statistics ..... 306
    - Time Domain Power ..... 312
    - TOI ..... 327
  - Measurement results
    - SEM ..... 264
    - Spurious Emissions ..... 288
  - Measurement time ..... 348
    - Auto settings ..... 532
    - Power sensor ..... 371
    - Remote ..... 1202, 1204
  - Measurement zoom ..... 99
  - Measurements
    - All Functions off ..... 130
    - APD ..... 293
    - Carrier-to-Noise ..... 206, 207
    - CCDF ..... 293
    - Correlating ..... 110
    - CP/ACLR ..... 149
    - Evaluation methods ..... 534
    - Frequency sweep ..... 129
    - Harmonic Distortion ..... 313
    - OBW ..... 210
    - SEM ..... 233
    - Spurious Emissions ..... 279
    - Statistics ..... 293
    - Time Domain Power ..... 308
    - TOI ..... 319
    - Zero span ..... 129
  - Measurements: time
    - Statistics ..... 299
  - Menus
    - Context-sensitive ..... 92
    - MI (trace information) ..... 85
  - Microbutton
    - Probes ..... 411
  - MIL Std bandwidth ..... 335, 349

- MINH (trace information) ..... 85
- Mini front panel
  - Hiding/restoring ..... 738
  - Key combination ..... 739
  - Using ..... 747
- Minimum ..... 564
  - Marker positioning ..... 564
  - Next ..... 564
- Mixer Type
  - External Mixer ..... 426
- MKR
  - Key ..... 551
- MKR ->
  - Key ..... 557, 563
- MKR FUNCT
  - Key ..... 565
- MOD (marker functions) ..... 86
- Mode (channel setting) ..... 83
- Modes
  - see Operating mode ..... 109
- Modulation
  - Marker Demodulation ..... 581
- Monitor
  - External ..... 744
  - Settings ..... 744
- MSR ACLR
  - Adjacent channel bandwidths ..... 185
  - Adjacent channel definition ..... 185
  - Adjacent channel setup ..... 184
  - Adjacent channel spacing ..... 185
  - Adjacent channel weighting filters ..... 186
  - Adjacent channels ..... 162
  - CACLR ..... 161
  - Channel definition ..... 160
  - Channel display ..... 163
  - Configuration ..... 175
  - Gap channel bandwidths ..... 190
  - Gap channel definition ..... 189
  - Gap channel setup ..... 187
  - Gap channel spacing ..... 189
  - Gap channel weighting filters ..... 191
  - Gap channels ..... 161
  - Limit check ..... 186, 191
  - Limit checks, activating ..... 181
  - Measurement ..... 159
  - Number of adj. channels ..... 185
  - Programming example ..... 973, 975
  - Results ..... 163
  - Results (remote) ..... 912
  - Signal structure ..... 159
  - Sub block definition ..... 160
  - TX channel bandwidth ..... 183
  - Weighting filters ..... 183
- MSR SEM
  - Basics ..... 243
  - Configuration ..... 259
  - Configuration (softkey) ..... 259
  - Settings (Multi-SEM) ..... 255
- Multi-Carrier Group Delay
  - Application ..... 116
- Multi-SEM
  - Basics ..... 244
  - Center frequencies ..... 255
  - Fast SEM ..... 242, 244
  - Frequency definition ..... 244
  - Limit line calculation ..... 245, 253
  - MSR settings ..... 255
  - Number of sub blocks ..... 255
  - Results ..... 236
  - Settings ..... 255
  - Standard files ..... 262
  - Standard settings files ..... 255
- Multi-standard radio
  - see MSR ..... 243
- Multicarrier ACLR measurement ..... 152
- Multiple signals
  - Measurement example ..... 137
- Multiple zoom ..... 541, 543
- MultiView
  - Status display ..... 87
  - Tab ..... 119, 122
  - Trying out ..... 68
- N**
- n dB down
  - Delta value ..... 575
  - Marker ..... 575
  - Remote control ..... 1311
- n dB down markers
  - Programming example ..... 1325
- Name
  - CP/ACLR channels ..... 175
  - Limit lines ..... 601
  - Transducer lines ..... 760
- Navigation
  - Controls ..... 45
  - in tables ..... 45
- Navigation keys ..... 46
- NB-IoT
  - Application ..... 117
- NCor (enhancement label) ..... 85
- Negative Peak detector ..... 609
- Network
  - Auto-login ..... 879
  - Changing user passwords ..... 878
  - Configuration (dialog box) ..... 854
  - Configuring ..... 816, 871
  - Connecting the instrument ..... 871
  - Creating users ..... 878
  - DNS server ..... 873
  - Login ..... 877
  - Operating the instrument ..... 877
  - Setting up ..... 870
  - Settings ..... 852
  - Settings (remote) ..... 1433
  - Sharing directories ..... 880
- Next Minimum ..... 564
  - Marker positioning ..... 564
- Next Mode X
  - Softkey ..... 561
- Next Mode Y
  - Softkey ..... 561
- Next Peak ..... 564
  - Marker positioning ..... 564
- NO REF
  - Error ..... 1544
- NOI (marker functions) ..... 86
- Noise
  - Cancellation (CP/ACLR) ..... 168, 179, 489
  - Cancellation (remote control) ..... 1208
  - Cancellation (softkey) ..... 168, 179, 489
  - Correction, see Cancellation ..... 168, 179, 489
  - Floor (RF attenuation) ..... 480

- Saving settings ..... 682
- Source ..... 468
- Noise Figure
  - Application ..... 117
- Noise markers
  - Programming example ..... 1323
- Noise measurement
  - Activating/Deactivating ..... 570
  - Deactivating ..... 570
  - Marker ..... 567
  - Remote control ..... 1303
- Noise source control
  - Connector ..... 50
- NOR
  - External generator ..... 380, 384
- NOR (channel bar) ..... 84
- Normalization
  - Approximate, external generator ..... 380
  - External generator ..... 380, 391
- Number of Readings
  - Power sensor ..... 372
- Numerator
  - Frequencies, external generator ..... 382, 387
- Numeric parameters ..... 94
- O**
- OBW ..... 210
  - % Power (remote control) ..... 980
  - % Power Bandwidth ..... 213
  - Adjust Settings ..... 214
  - Channel Bandwidth ..... 214
  - Channel bandwidth (remote control) ..... 980
  - Configuring ..... 212
  - Deactivating limits ..... 214, 560, 563
  - Determining ..... 212, 215
  - Limits ..... 214, 559, 563
  - Measurement ..... 210
  - Measurement (remote control) ..... 980
  - Measurement example ..... 216
  - Multicarrier signal ..... 211, 213, 215
  - Prerequisites ..... 211
  - Results ..... 212
  - Search limits ..... 211, 213, 215
- OBW measurement
  - Centroid frequency ..... 212
- Occupied Bandwidth
  - see OBW ..... 210
- OCXO
  - Connector ..... 60
- OFDM VSA (Vector Signal Analysis)
  - Application ..... 117
- Offset
  - Frequency ..... 476
  - Limit lines ..... 595
  - Reference level ..... 485
  - X-axis (statistics) ..... 303
- Offset (channel setting) ..... 82
- On-screen keyboard ..... 93, 95
- OneWeb
  - Application ..... 117
- Online help
  - Working with ..... 107
- Open-circuit reflection measurement
  - Calibration, external generator ..... 391
- Operating mode ..... 109
  - Changing ..... 110
  - Presetting ..... 791
- Operating temperature ..... 731
- Operation complete
  - Remote ..... 894
- Optimizing
  - Calibration signal display ..... 63
- Options
  - Electronic attenuation ..... 487
  - EMI measurement (K54) ..... 332, 349
  - External generator control (B10) ..... 375
  - External mixer ..... 411
  - High-pass filter ..... 365
  - Identification (remote) ..... 894
  - Information ..... 784
  - Installing ..... 784, 786
  - Preamplifier ..... 488
  - Secure user mode (K33) ..... 39, 675
  - SnP input files (K544) ..... 1406
- Orientation
  - Screenshot ..... 704
- Oscilloscope
  - Alignment ..... 59
- Output
  - Audio ..... 1188
  - Buffer ..... 823
  - Configuration ..... 466
  - Configuration (remote) ..... 1187
  - External reference ..... 782
  - IF frequencies ..... 360
  - IF frequency (remote) ..... 1188, 1189
  - IF Out Frequency ..... 467
  - IF source (remote) ..... 1188
  - Noise source ..... 468
  - Parameters ..... 359
  - Settings ..... 466
  - Trigger ..... 468
  - Video ..... 467, 1188
  - Video signal ..... 360
- OVEN
  - Error ..... 1544
- OVENCOLD
  - Error ..... 1544
- OVENCOLD (status display) ..... 1544
- Overheating
  - Shutdown ..... 31
- Overload
  - External generator ..... 380
  - RF input (remote) ..... 1110
- Overloading
  - External generator ..... 385
- Overview (configuration) ..... 357
- OVL D
  - External generator ..... 380, 384
- OVL D (status display) ..... 1544
- P**
- Pa (channel bar) ..... 83
- Parallel poll register enable
  - Remote ..... 895
- Parameters
  - Entering ..... 94, 95
  - Input signal ..... 359
  - Output ..... 359

- Passing between applications ..... 121
  - Passing between secondary applications ..... 111
- Password
  - Secure user mode ..... 792
- Passwords
  - Changing ..... 878
  - Secure user mode ..... 41, 677
  - Service functions ..... 802
- Peak excursion ..... 559, 562, 582, 585
- Peak list ..... 583
  - Configuring ..... 582
  - Displaying ..... 582
  - Evaluation method ..... 536
  - Exporting ..... 585, 588, 656
  - Marker numbers ..... 585
  - Maximum number of peaks ..... 585
  - Peak excursion ..... 559, 562, 585
  - Remote control ..... 1300
  - Sort mode ..... 585
  - State ..... 585
  - Trying out ..... 70
- Peak search ..... 339
  - Area (spectrograms) ..... 562
  - Automatic ..... 347, 559, 562, 583
  - Deactivating limits ..... 214, 560, 563
  - Excursion ..... 582
  - Key ..... 564
  - Limits ..... 214, 559, 563, 582
  - List ..... 583
  - Mode ..... 558, 561
  - Mode (spectrograms) ..... 560, 561
  - Reference marker ..... 556
  - Threshold ..... 559, 563
  - Type (spectrograms) ..... 562
  - Zoom limits ..... 560, 563
- Peaks
  - Displaying (SEM) ..... 265
  - Displaying (Spurious Emissions) ..... 289
  - Margin (SEM) ..... 265
  - Margin (Spurious Emissions) ..... 289
  - Marker positioning ..... 564
  - Next ..... 564
  - per range (Spurious Emissions) ..... 290
  - SEM results ..... 236
  - Softkey ..... 564
  - Spurious Emissions ..... 280
- Percent marker
  - CCDF ..... 296
  - Softkey (CCDF) ..... 298
- Performing
  - EMI measurement ..... 351
- Period
  - Gate ranges (statistics) ..... 300
- Persistence spectrum
  - Spectrogram ..... 635
- Phase ..... 350
  - EMI ..... 338
  - LISN control (EMI) ..... 350
- Phase noise markers
  - Programming example ..... 1324
- Phase noise measurement
  - Activating/Deactivating ..... 572
  - Application ..... 117
  - Deactivating ..... 573
  - Marker ..... 570
  - Reference point ..... 573
  - Remote control ..... 1305
- PHN (marker functions) ..... 86
- PHONES
  - Connector ..... 51
- Ping ..... 876
- PK (trace information) ..... 85
- Ports
  - External Mixer (remote) ..... 1152
  - User ..... 1189
- Position
  - Limit line values ..... 602
  - Transducer factors ..... 761
- Positive Peak detector ..... 609
- Power
  - Channel, see Channel power ..... 149
  - Harmonics ..... 317
  - Mean (time domain) ..... 308
  - Peak (time domain) ..... 308
  - Percent (OBW) ..... 213
  - RMS (time domain) ..... 308
  - Standard deviation (time domain) ..... 308
  - Time domain ..... 308
- POWER
  - Key ..... 42
- Power classes
  - Adding/Removing (SEM) ..... 259
  - Ranges (SEM) ..... 258
  - SEM ..... 239, 257
  - SEM results ..... 234
  - Softkey ..... 257
  - Used (SEM) ..... 258
- Power mode
  - Band power measurement ..... 579
  - CP/ACLR ..... 170, 180
  - Softkey ..... 170, 180
- Power sensors
  - Activating/Deactivating ..... 369
  - Applications ..... 367
  - Average count ..... 372
  - Configuration (softkey) ..... 368
  - Configuring ..... 368
  - Configuring - see User Manual ..... 50
  - Configuring as trigger ..... 375
  - Connecting ..... 368
  - Connector ..... 50
  - Continuous Value Update ..... 370
  - Duty cycle ..... 372
  - External power trigger ..... 372
  - External trigger level ..... 372
  - Frequency ..... 370
  - Frequency Coupling ..... 370
  - Measurement time ..... 371
  - Number of readings ..... 372
  - R&S NRP ..... 368
  - R&S Power Viewer ..... 367
  - Reference level ..... 371
  - Reference level offset ..... 371
  - Results ..... 367
  - Selecting ..... 370
  - Setting up ..... 373
  - Settings ..... 368
  - Trigger mode ..... 517
  - Unit/Scale ..... 371
  - Using ..... 373
  - Using - see User Manual ..... 50
  - Zeroing ..... 370, 374
- Power supply
  - Connector ..... 54

- Power Unit
    - Softkey ..... 169, 180
  - PPE register ..... 823, 825
  - Preamplifier
    - SEM range ..... 252
    - Setting ..... 488
    - Softkey ..... 488
    - Spurious Emissions range ..... 287
  - Predefined standards
    - CP/ACLR ..... 166, 177, 204, 205
  - Preset
    - Bands (External Mixer, remote) ..... 1148
    - channel settings ..... 675
    - External Mixer ..... 425
    - Key ..... 674
    - Recalling settings ..... 689
  - Presetting
    - Channels ..... 358
  - Pretrigger ..... 518
  - Preview
    - Trigger/Gate settings ..... 513
  - Print Screen
    - Softkey ..... 699
  - Printer
    - Selecting ..... 701
  - Printers
    - Installing ..... 702
  - Printing
    - Colors ..... 739, 741, 745
    - Colors (remote) ..... 1429
    - Medium ..... 701
    - Screenshots ..... 699, 705
    - Trying out ..... 78
  - Probability range
    - Statistics ..... 303
  - Probe
    - Connector ..... 50
  - Probes
    - Common Mode Offset ..... 405
    - Connectors ..... 49, 57
    - Microbutton ..... 411
    - Settings ..... 408
  - Product IDs ..... 822
  - Programming examples
    - ACLR ..... 971
    - AM Modulation Depth ..... 1079
    - Band power markers ..... 1325
    - Carrier-to-Noise ratio ..... 979
    - Continuous gating ..... 1232
    - Demodulation markers ..... 1326, 1327
    - EMI measurement ..... 1087
    - External Mixer ..... 1157
    - Frequency sweep ..... 1531
    - Marker Peak List ..... 1323
    - Marker search (spectrograms) ..... 1321
    - Markers ..... 1320
    - MSR ACLR ..... 973, 975
    - n dB down markers ..... 1325
    - Noise markers ..... 1323
    - Phase noise markers ..... 1324
    - Reference Marker ..... 1322
    - SEM ..... 1032
    - Sequencer ..... 905
    - Service request ..... 1534
    - Signal count markers ..... 1327
    - Spectrogram ..... 1265
    - Spurious Emissions measurement ..... 1048
    - Statistics ..... 997, 1060, 1322, 1344, 1346, 1388
    - TOI ..... 1078
    - Touchstone files ..... 1424
  - Protection
    - RF input (remote) ..... 1110
  - PSA emulation ..... 1519
  - PSA89600
    - Wideband ..... 860
  - Pulse
    - Application ..... 118
  - PXA emulation ..... 1523
- ## Q
- QP (trace information) ..... 85
  - Quasipeak detector
    - EMI ..... 336
  - Quick Config
    - Traces ..... 626
  - Quick recall
    - Settings ..... 679
  - Quick save
    - Secure user mode ..... 679, 681
    - Settings ..... 679
- ## R
- R&S FSP
    - Emulating ..... 858
    - Emulating (remote) ..... 1489
  - R&S FSQ
    - Emulating ..... 858
    - Emulating (remote) ..... 1489
  - R&S FSU
    - Emulating ..... 858
    - Emulating (remote) ..... 1489
  - R&S FSV
    - Emulating ..... 858
    - Emulating (remote) ..... 1489
  - R&S NRP
    - Power sensors ..... 368
  - R&S Power Viewer Plus ..... 367
  - R&S Support ..... 796
  - Range
    - Scaling ..... 490
    - X-axis (statistics) ..... 302
  - Ranges
    - Definition (SEM) ..... 238
    - Deleting (SEM) ..... 254
    - Deleting (Spurious Emissions) ..... 288
    - Inserting (SEM) ..... 254
    - Inserting (Spurious Emissions) ..... 288
    - Reference (SEM) ..... 238, 256
    - Remote control (Spurious Emissions) ..... 282
    - Rules (SEM) ..... 238
    - Rules (Spurious Emissions) ..... 281
    - SEM ..... 238
    - Symmetrical (SEM) ..... 239
  - RBW
    - see Resolution Bandwidth ..... 492
  - RBW (channel setting) ..... 82
  - Ready for trigger
    - Status register ..... 826
  - Real-Time spectrum
    - Application ..... 118
  - Rear panel
    - Overview ..... 52

- Rebooting
  - Remote control ..... 1482
- Recalling
  - Calibration settings, external generator ..... 391
  - Settings ..... 677, 679, 683, 686
  - Settings for preset ..... 689
  - Softkey ..... 683
- Redo
  - Key ..... 46
- REF INPUT
  - Connector ..... 59
- Ref Level (channel setting) ..... 82
- Ref Lvl = Mkr Lvl ..... 565
- Reference
  - External ..... 779
  - Fixed ..... 556, 575
  - Fixed (channel power) ..... 170
  - Fixed (Delta marker) ..... 587
  - Frequency ..... 779
  - Frequency (remote control) ..... 1389
  - Internal ..... 779
  - Marker ..... 556, 575
  - Phase noise measurement ..... 573
  - Power (SEM) ..... 256
  - Range (SEM) ..... 238, 256
  - Softkey ..... 779
- Reference channel
  - CP/ACLR ..... 168, 178
- Reference frequency
  - Default ..... 782
  - External generator ..... 379, 389
  - Input ..... 780
  - Output ..... 782
- Reference level ..... 479, 484
  - Adjusting to transducer factors ..... 759
  - Auto level ..... 486, 532
  - CP/ACLR ..... 159
  - External generator ..... 381
  - External Mixer ..... 416
  - Offset ..... 485
  - Offset (Power sensor) ..... 371
  - Position ..... 490
  - Power sensor ..... 371
  - SEM range ..... 251
  - Setting to marker ..... 565
  - Spurious Emissions range ..... 286
  - Statistics ..... 302
  - Unit ..... 484, 485
  - Value ..... 484
- Reference line
  - External generator ..... 381
  - Position, external generator ..... 392
  - Shifting, external generator ..... 382, 392
  - Value, external generator ..... 392
- Reference marker ..... 343, 553
- Reference Marker
  - Programming example ..... 1322
- Reference range
  - Softkey ..... 256
- Reference trace
  - External generator ..... 380, 381
  - Storing as transducer factor, external generator ..... 381, 392
- Reflection measurement
  - External generator ..... 378
  - How to, external generator ..... 394
- Registers ..... 823
- Relay Cycle Counter ..... 803
- Release notes ..... 23
- Remote commands
  - Deprecated ..... 1527
- Remote control
  - Blocked ..... 1546
  - Errors ..... 1546
  - Interfaces ..... 816
  - LAN settings ..... 861
  - Protocols ..... 816
  - Sequential commands ..... 1546
- Remote Desktop ..... 871, 883
  - Client ..... 884
  - Ending session ..... 887
  - Setting up a connection ..... 887
  - Setting up controller ..... 884
  - Setting up instrument ..... 883
- Remote display
  - Update ..... 856
- Remote operation
  - Configuring ..... 816
  - Deactivating the instrument ..... 889
  - GPIB address ..... 877
  - GPIB settings ..... 854
  - see also Remote control ..... 816
  - Setting up ..... 870
  - Settings ..... 851
  - Starting ..... 889
  - Stopping ..... 890
- Removable hard drive ..... 54
- Repeatability
  - CP/ACLR measurements ..... 154
- Repetition interval ..... 518
  - Softkey ..... 518
- Report ..... 710
- Reset values
  - Remote ..... 896
- Resetting
  - RF input protection ..... 1110
- Resolution bandwidth
  - Auto (Softkey) ..... 347, 501
  - CP/ACLR ..... 157
  - Harmonics ..... 318
  - Impact ..... 492
  - Manual (Softkey) ..... 347, 501
  - SEM range ..... 250
  - Spurious Emissions range ..... 285
- Resolution bandwidth (EMI) ..... 335, 349
- Restoring
  - Channel settings ..... 358
  - Standard files ..... 264
- Restricted operation
  - Secure user mode ..... 40, 676
- Restrictions
  - Storage space ..... 40, 676
- Result displays
  - Diagram ..... 535
  - Marker table ..... 535
  - Peak list ..... 536
  - Programming example ..... 1106
  - Result Summary ..... 536
  - Spectrogram ..... 536
- Result frequency
  - External generator ..... 388
- Result range
  - Shifting ..... 545
  - Zooming ..... 545



- Result Summary
  - Configuration (SEM) ..... 264
  - Evaluation method ..... 536
  - Result display ..... 536
  - Saving (SEM) ..... 266
- Results
  - Analyzing ..... 351
  - CP/ACLR measurements ..... 150
  - Data format (remote) ..... 1263, 1373
  - Displaying ..... 100
  - Exporting ..... 651
  - Managing ..... 674
  - OBW ..... 212
  - SEM ..... 234
  - SEM (remote) ..... 237
  - Storing (remote) ..... 1372
- Reverse sweep
  - External generator ..... 384, 387
- Revision string
  - GPIO ..... 860, 1491
  - GPIO (remote control) ..... 1436
  - Resetting ..... 860
- RF attenuation
  - Auto ..... 486
  - Impact ..... 480
  - Manual ..... 486
  - Mode (SEM range) ..... 251
  - Mode (Spurious Emissions range) ..... 286
  - Noise floor ..... 480
  - SEM range ..... 251
  - Spurious Emissions range ..... 286
- RF input ..... 362
  - Overload protection (remote) ..... 1110
  - Remote ..... 1109
- RF Input
  - Connector ..... 48
- RF overrange
  - External Mixer ..... 412, 425, 1152
- RF OVLD
  - Error ..... 1544
  - External generator ..... 384
- RF OVLD (status display) ..... 1544
- RF Power
  - Trigger ..... 516
  - Trigger level (remote) ..... 1221
- Rising
  - Slope (Power sensor) ..... 373
- RM (trace information) ..... 85
- RMS average
  - Detector ..... 336
- RMS Average detector
  - EMI ..... 337
- RMS detector ..... 609
  - EMI ..... 336
  - VBW ..... 494
- Rotary knob ..... 45
- RRC filter
  - SEM ..... 257
- RUN CONT
  - Key ..... 130, 506, 640
- RUN SINGLE
  - Key ..... 130, 506, 507, 640
- S**
- S/N ratio
  - Measurement example ..... 134, 147
- SA (trace information) ..... 85
- Safety instructions ..... 17, 23
- Sample detector ..... 609
  - EMI ..... 336
- Samples
  - Statistics ..... 299, 308
- Save/Recall Mode
  - Settings ..... 684
- Savesets
  - Settings ..... 680
- Saving
  - Classified data ..... 39, 675
  - Data types ..... 681
  - Functions ..... 683
  - Instrument settings ..... 687
  - Limit lines ..... 603
  - Screenshots ..... 705
  - SEM result files ..... 270
  - Settings ..... 263, 683
  - Softkey ..... 683
  - Spurious Emissions result files ..... 291
  - Transducer lines ..... 761
  - Trying out ..... 77, 78
- Scalar reflection measurement
  - External generator ..... 378
- Scaling
  - Amplitude range, automatically ..... 490
  - Configuration ..... 489
  - Default (statistics) ..... 303
  - Statistics ..... 301
  - X-axis (remote control) ..... 1191
  - Y-axis ..... 481, 491
  - Y-axis (remote control) ..... 1216
- SCPI list
  - Display ..... 841
  - Export ..... 842, 844, 846
- SCPI Recorder ..... 838
- Screen
  - See Touchscreen ..... 740
- Screenshots
  - Printing ..... 699, 705
  - Saving ..... 699, 705
  - Trying out ..... 78
- Search limits
  - Deactivating ..... 214, 560, 563
  - OBW ..... 211, 213
- Search Limits
  - Activating ..... 214, 559, 563
- Search Mode
  - Spectrogram markers ..... 560
- Search range
  - Zoom area ..... 542
- Search settings
  - Trying out ..... 70
- Search Signals
  - Softkey ..... 326, 331
- Searching
  - Configuration ..... 557
  - Configuration (softkey) ..... 560
- Second harmonic intercept ..... 314
- Secure user mode
  - Activating ..... 792
  - Activating/deactivating ..... 40, 676
  - Background information ..... 39, 675
  - Instrument settings ..... 678
  - Login ..... 36
  - Passwords ..... 41, 677

- Quick save ..... 679, 681
- Redirecting storage ..... 39, 675
- Remote ..... 1453
- Restricted operation ..... 40, 676
- Self-alignment ..... 730, 785, 790, 851, 852
- Self-alignment data ..... 40, 676
- Storage location ..... 263, 682, 683, 686
- Transducer settings ..... 757
- SecureUser ..... 40, 676
- Security procedures ..... 23
- Select Frame
  - Softkey ..... 507, 639
- Select Marker ..... 345, 554
- Self-alignment ..... 728
  - Aborting ..... 731
  - Secure user mode ..... 40, 676, 730, 785, 790, 851, 852
  - Starting ..... 730
- Self-test
  - Performing ..... 733, 797
  - Remote ..... 896
  - Results ..... 797, 1401
  - Settings ..... 797
  - Temperature ..... 733
- Selftest
  - Remote ..... 1455
- SEM ..... 233
  - About ..... 234
  - Adding power classes ..... 259
  - Alpha value (RRC filter) ..... 257
  - Applications ..... 234
  - Channel power settings ..... 257
  - Configuring ..... 247, 266
  - Deleting ranges ..... 254
  - Displaying peaks ..... 265
  - Exporting results ..... 270
  - Fast mode ..... 242, 250
  - Filter type ..... 250
  - Format description of export files ..... 278
  - Format description of settings files ..... 272
  - Inserting ranges ..... 254
  - Limit absolute ..... 253
  - Limit check ..... 252
  - Limit lines ..... 240
  - Limit relative ..... 253
  - List evaluation ..... 264
  - List evaluation (remote control) ..... 1030
  - List evaluation state ..... 265
  - Measurement (remote control) ..... 998
  - Measurement result list ..... 264
  - MSR (remote control) ..... 1024
  - Multiple sub blocks (Multi-SEM) ..... 244
  - Peak margins ..... 265
  - Performing ..... 266
  - Power class ranges ..... 258
  - Power classes ..... 239, 257
  - Power classes (remote control) ..... 1019
  - Preamplifier ..... 252
  - Programming example ..... 1032
  - Provided settings files ..... 272
  - Range start/stop ..... 249
  - Ranges ..... 238
  - RBW ..... 250
  - Reference level ..... 251
  - Reference power ..... 256
  - Reference range ..... 256
  - Reference range (remote control) ..... 1018
  - Restoring standard files ..... 264
  - Result files ..... 270
  - Results ..... 234
  - Results (Multi-SEM) ..... 236
  - Results (remote control) ..... 1032, 1048
  - Results (remote) ..... 237
  - RF attenuation ..... 251
  - RF attenuation mode ..... 251
  - RRC filter ..... 257
  - Saving result summary ..... 266
  - Settings files ..... 262, 269
  - Standard files ..... 262
  - Standards (remote control) ..... 998
  - Sweep List ..... 248
  - Sweep list (remote control) ..... 1001
  - Sweep Points ..... 254
  - Sweep Time ..... 251
  - Sweep Time Mode ..... 250
  - Transducer ..... 252
  - Tx Bandwidth ..... 257
  - Used power classes ..... 258
  - VBW ..... 250
- Sensitivity
  - RBW ..... 492
- Sequencer ..... 82
  - Aborted ..... 730, 798
  - Activating (remote) ..... 904
  - Channels ..... 122
  - Example ..... 124
  - Mode ..... 123, 125
  - Programming example ..... 905
  - Remote ..... 909
  - Remote control ..... 897
  - Run Single ..... 124
  - Setting up ..... 126
  - Single Sweep ..... 124
  - Softkey ..... 125
  - State ..... 125
  - Trying out ..... 68
- Sequences
  - Aborting (remote) ..... 904
  - Mode (remote) ..... 904
- Sequential commands
  - Errors ..... 1546
- Service functions ..... 796, 800, 801
  - Numeric mode ..... 802
  - Passwords ..... 802
  - Results ..... 802
- Service manual ..... 22
- Service request (SRQ) ..... 816, 823, 824, 825
- Service request enable register (SRE) ..... 823, 824
  - Remote ..... 896
- Set CP Reference
  - Softkey ..... 170
- Settings
  - filename ..... 263, 684, 687
  - Format description (SEM) ..... 272
  - Loading ..... 687
  - Managing ..... 674
  - Provided files (SEM) ..... 272
  - Recalling ..... 677, 679
  - Recalling; restrictions ..... 678
  - Restoring files ..... 264
  - Saving ..... 682, 687
  - Storage location ..... 263, 683, 686
  - Storing ..... 677, 679

- Settings files
  - Deleting ..... 264
  - Deleting (SEM) ..... 269
  - Loading ..... 263
  - Loading (SEM) ..... 269
  - Managing (SEM) ..... 269
  - Restoring (SEM) ..... 269
  - Saving ..... 263
  - Saving (SEM) ..... 269
- Setup files
  - External generator ..... 379, 389, 390
- Sgl (channel bar) ..... 83
- Shift x
  - Limit lines ..... 603
  - Transducer lines ..... 761
- Shift y
  - Limit lines ..... 603
  - Transducer lines ..... 761
- Shifting
  - Limit lines ..... 595
  - Results ..... 545
- Short-circuit reflection measurement
  - Calibration, external generator ..... 391
- Show SCPI command ..... 839
  - Close ..... 840
  - Copy ..... 840
- Shutdown
  - Automatic ..... 731
  - Remote control ..... 1482
- Signal capturing
  - Duration (remote) ..... 1202, 1204
- Signal count
  - Marker ..... 567
  - Remote control ..... 1315
  - Resolution ..... 567
- Signal count markers
  - Programming example ..... 1327
- Signal counter
  - Measurement example ..... 133
- Signal generator
  - Address ..... 226, 794, 811, 847
  - Connection information ..... 226, 794, 795, 811, 847
- Signal ID
  - External Mixer ..... 428
  - External Mixer (remote) ..... 1145
- Signal tracking ..... 477
  - Bandwidth ..... 477
  - Softkey ..... 477
  - State ..... 477
  - Threshold ..... 477
  - Trace ..... 477
- Single Sequencer
  - Softkey ..... 125
- Single sweep
  - Softkey ..... 130, 506, 640
- Single zoom ..... 541, 543
- Sinusoidal signals
  - Measurement example ..... 131
- Slope
  - Edge gate ..... 519
  - Power sensor trigger ..... 373
  - Trigger ..... 519, 1221
  - Trigger (Power sensor) ..... 373
- Smart noise source
  - Connector ..... 50
- SmartGrid
  - Activating ..... 104, 539
  - Arranging windows ..... 105, 540
  - Display ..... 102, 537
  - Evaluation bar ..... 104, 539
  - Features ..... 102, 537
  - Mode ..... 104, 539
  - Programming example ..... 1106
  - Trying out ..... 63
- Smoothing
  - Traces ..... 621
  - Traces (group delay) ..... 625
- Soft front panels
  - Using ..... 746
- softkey
  - Calibration Frequency WB ..... 1400
  - Filter Type (remote control) ..... 1206
  - Trace Mode (remote control) ..... 1062, 1063
- Softkey
  - Calibrate Reflection Open (remote control) ..... 1173
  - Calibrate Reflection Short (remote control) ..... 1173
  - Calibrate Transmission (remote control) ..... 1173
- Softkey bar
  - Hiding/restoring ..... 737
- Softkeys
  - # of Samples (APD, CCDF) ..... 299
  - % Power Bandwidth ..... 213
  - ACLR Mode ..... 169, 179
  - Adjust Settings ..... 170, 180, 209, 214, 318
  - Adjust Settings (APD) ..... 299, 304
  - Adjust X-Axis ..... 288
  - All Functions Off ..... 586
  - Amplitude Config ..... 481
  - Analysis BW (APD, CCDF) ..... 298
  - Auto All ..... 531
  - Auto Freq ..... 531
  - Auto Level ..... 486, 532
  - Bandwidth Config ..... 498
  - BB Power ..... 516
  - C/N ..... 208
  - C/No ..... 209
  - Carrier Noise Config ..... 208
  - Center ..... 474
  - Center = Mkr Freq ..... 565
  - Channel Bandwidth ..... 209, 214
  - Channel-defined Sequencer ..... 125
  - Clear All Messages (remote control) ..... 1450
  - Clear Spectrogram ..... 508, 640
  - Color Mapping ..... 639
  - Comment ..... 696
  - Continue Single Sweep ..... 130, 507
  - Continuous Sequencer ..... 125
  - Continuous Sweep ..... 130, 506, 640
  - CP/ACLR Settings ..... 165
  - CP/ACLR Standard ..... 166, 177
  - Device ..... 696, 700, 703
  - Display Config ..... 534
  - Export ..... 690
  - Export config ..... 692
  - External ..... 514
  - Frame count ..... 508
  - Free Run ..... 514
  - Frequency Config ..... 473
  - Full Span ..... 475
  - Gated Trigger ..... 299
  - Harmonic RBW Auto ..... 318
  - Harmonic Sweep Time ..... 318

History Depth .....	639
Horizontal Line 1/2 .....	592
I/Q Export .....	692
IF Power .....	515
Import .....	690
Input Source Config .....	362
Install Printer .....	702
Last Span .....	475
Line Config .....	597
List evaluation .....	264
Lower Level Hysteresis .....	533
Marker 1/2/3 .....	331
Marker 1/2/3/4 .....	326
Marker Config .....	551, 555
Marker Search Area .....	562
Marker Search Type .....	562
Marker to Trace .....	344, 554
Meastime Auto .....	532
Meastime Manual .....	532
Min .....	564
MSR Configuration .....	259
Next Min .....	564
Next Mode X .....	561
Next Mode Y .....	561
Next Peak .....	564
No. of Harmonics .....	318
Noise cancellation .....	168, 179, 489
Norm/Delta .....	343, 553, 569
Outputs Config .....	466
Peak .....	564
Percent Marker .....	298
Power classes .....	257
Power Mode .....	170, 180
Power Sensor .....	517
Power Sensor Config .....	368
Power Unit .....	169, 180
Preamp .....	488
Print Screen .....	699
R&S Support .....	796
Recall .....	683
Recall File .....	681, 685
Ref Level .....	484
Ref Level (APD; CCDF) .....	302
Ref Level Offset .....	485
Ref Lvl = Mkr Lvl .....	565
Reference .....	779
Reference range .....	256
Repetition interval .....	518
Res BW Auto .....	347, 501
Res BW Auto (remote) .....	1199
Res BW Manual .....	347, 501
RF Atten Auto .....	486
RF Atten Manual .....	486
RF Power .....	516
Save .....	683
Save File .....	685
Scale Config .....	489
Search Config .....	557, 560
Search Signals .....	326, 331
Select Frame .....	507, 639
Select Marker .....	345, 554
Sequencer .....	125
Set CP Reference .....	170
Signal Track .....	477
Single Sequencer .....	125
Single Sweep .....	130, 506, 640
Span Manual .....	474
Standard files .....	262
Start .....	475
Startup Recall .....	685
Startup Recall (On/Off) .....	686
Status .....	91
Stop .....	475
Sweep Config .....	498
Sweep Count .....	504
Sweep List .....	248
Sweep Time .....	170
Sweep Time Auto .....	502
Sweep Time Manual .....	502
System Messages (remote control) .....	1450
Time .....	517
Timestamp .....	639
Trace 1/2/3/4 .....	626
Trace Config .....	622, 646
Transducer .....	756
Trigger Offset .....	518
Trigger/Gate Config .....	512
Upper Level Hysteresis .....	532
Vertical Line 1/2 .....	592
Video .....	515
Video BW Auto .....	501
Video BW Manual .....	501
Zero Span .....	475
Sort mode	
Peak list .....	585
Source offset	
External generator .....	387
Source power	
External generator .....	387
Spacing	
MSR, adjacent channels .....	185
MSR, gap channels .....	189
Spacings	
CP/ACLR .....	172
Span .....	474
Band power measurement .....	579
Carrier-to-Noise .....	207
CP/ACLR .....	157
Manual .....	474
Span/RBW coupling .....	494
Speaker	
Remote control .....	1190
Specifications .....	23
Spectrograms	
3-dimensional .....	639
Activating/Deactivating .....	638, 639
Clearing .....	508, 640
Color curve .....	635, 642, 645
Color mapping .....	634, 639, 641, 644
Color mapping (remote control) .....	1253
Color scheme .....	635, 642
Configuring .....	643
Configuring (remote control) .....	1248
Continue frame .....	631
Display .....	629
Display depth (3-D) .....	639
Displaying .....	642, 643
Evaluation method .....	536
Frame count .....	631
Frames (remote control) .....	1248
History depth .....	639
Markers .....	632, 643
Markers (remote control) .....	1289
Programming example .....	1265

- Removing ..... 643
- Scaling ..... 631
- Selecting frames ..... 507, 639
- Settings ..... 637
- Size ..... 638
- Sweep count ..... 631
- Time frames ..... 630
- Timestamps ..... 632, 639
- Trying out ..... 63
- Value range ..... 635, 644
- Spectrum
  - Application ..... 113
- Spectrum Emission Mask
  - see SEM ..... 233
- Split
  - Window ..... 106
- Split display ..... 52
- Splitters
  - Window size ..... 106
- Spur optimized (channel bar) ..... 84
- Spurious Emissions ..... 279
  - About ..... 279
  - Configuring ..... 283
  - Deleting ranges ..... 288
  - Detector ..... 285
  - Displaying peaks ..... 289
  - Evaluation list ..... 280
  - Exporting results ..... 291
  - Filter type ..... 285
  - Format description of export files ..... 292
  - Inserting ranges ..... 288
  - Limit absolute ..... 288
  - Limit check ..... 287
  - Limit lines ..... 282
  - List details ..... 290
  - List evaluation ..... 288
  - List evaluation state ..... 289
  - Measurement (remote control) ..... 1035
  - Measurement result list ..... 288
  - Peak margins ..... 289
  - Peaks ..... 280
  - Peaks per range ..... 290
  - Performing ..... 283, 290
  - Preamplifier ..... 287
  - Programming example ..... 1048
  - Range start/stop ..... 284
  - Ranges ..... 281
  - RBW ..... 285
  - Reference level ..... 286
  - Result files ..... 291
  - Results ..... 280
  - RF attenuation ..... 286
  - RF attenuation mode ..... 286
  - Saving list evaluation ..... 290
  - Sweep behavior ..... 287
  - Sweep list ..... 283, 1036
  - Sweep points ..... 287
  - Sweep time ..... 285
  - Sweep time mode ..... 285
  - Transducer ..... 287
  - VBW ..... 285
- Spurious Measurements
  - Application ..... 116
- Squelch
  - Level ..... 582
  - Marker Demodulation ..... 581
  - Remote control ..... 1316
- SRE (service request enable register) ..... 824
- SRQ (service request) ..... 824
- Standard
  - MSR TX channel ..... 183
- Standard deviation
  - Power (time domain) ..... 308
- Standard files
  - Multi-SEM ..... 262
  - Softkey ..... 262
- Standards
  - CP/ACLR measurements ..... 166, 177
  - Format description (SEM) ..... 272
  - Provided files (SEM) ..... 272
  - Restoring files (SEM) ..... 264
  - Settings files (Multi-SEM) ..... 255
  - Settings files (SEM) ..... 262
- Star (yellow)
  - see Invalid data icon ..... 81
- Start frequency
  - Softkey ..... 475
- Startup recall
  - Remote ..... 1358
- Startup Recall
  - Softkey ..... 686
- Statistics
  - Default scaling ..... 303
  - Gate (remote control) ..... 1053
  - Gated trigger ..... 296
  - Measurements ..... 293
  - Measurements (remote control) ..... 1051
  - Optimizing ..... 308
  - Programming example
    - ..... 997, 1060, 1322, 1344, 1346, 1388
  - Scaling ..... 301
  - Scaling (remote control) ..... 1056
  - see also APD, CCDF ..... 293
- Status bar
  - Color coding ..... 88, 1543
  - Error messages ..... 88, 1543
  - Error messages, external generator ..... 385
  - Hiding/restoring ..... 737
  - Secure user mode ..... 40, 676
- Status byte
  - Remote ..... 893, 896
- Status byte (STB) ..... 825
- Status byte register (STB) ..... 823
- Status display ..... 87
- Status registers ..... 823
  - STAT:QUES:POW ..... 1110
  - STATus:OPERation ..... 826
  - STATus:QUESTionable ..... 827
  - STATus:QUESTionable:ACPLimit ..... 829
  - STATus:QUESTionable:DIQ ..... 824
  - STATus:QUESTionable:EXTended ..... 829
  - STATus:QUESTionable:EXTended:INFO ..... 830
  - STATus:QUESTionable:FREQuency ..... 830
  - STATus:QUESTionable:LIMit ..... 831
  - STATus:QUESTionable:LMARgin ..... 832
  - STATus:QUESTionable:POWer ..... 832
  - STATus:QUESTionable:SYNC ..... 824
  - STATus:QUESTionable:TEMPerature ..... 833
  - STATUs:QUESTionable:TEMPerature ..... 727, 1401
  - STATus:QUESTionable:TIME ..... 834
- Status reporting system ..... 822
  - Common commands ..... 892

- Step size
  - Markers ..... 556
  - Markers (remote control) ..... 1275
- Stop frequency
  - Softkey ..... 475
- Storage ..... 1554
- Storage location
  - Data files ..... 682
  - Secure user mode ..... 263, 682, 683, 686
  - Settings ..... 263, 683, 686
- Storage settings
  - File type ..... 684
- Storing
  - Settings ..... 677, 679
- Sub blocks
  - Configuring ..... 182
  - MSR, Center frequency ..... 182
  - MSR, number of TX channels ..... 182
  - MSR, RF bandwidth ..... 182
  - MSR, TX channel definition ..... 182
  - Number (Multi-SEM) ..... 255
  - Standard files ..... 262
- Subnet mask
  - External frontend ..... 457
- Subnet Mask ..... 854
- subspans ..... 495, 496
- Subwindows
  - Spectrogram ..... 638
- Suffixes
  - Common ..... 892
- Support ..... 1550
  - Information ..... 796
  - Information (remote) ..... 1455
- Suppressing
  - File name dialog ..... 701
- Sweep
  - Aborting ..... 506, 507, 640
  - Behavior (Spurious Emissions) ..... 287
  - Configuration (Softkey) ..... 498
  - Continuous ..... 130
  - Count ..... 497
  - Count (Spectrograms) ..... 631
  - Default settings ..... 492
  - Mode ..... 130, 498
  - Performing ..... 130
  - Points ..... 497, 609
  - Points (SEM range) ..... 254
  - Points (Spurious Emissions range) ..... 287
  - Settings (Spectrogram) ..... 507
  - Single ..... 130
  - Time (remote) ..... 1202, 1204
  - Type ..... 495, 505
  - Type (remote) ..... 1205
- Sweep Count ..... 504
- Sweep list
  - Deleting ranges ..... 288
  - Detector ..... 285
  - Filter type ..... 285
  - Inserting ranges ..... 288
  - Limit absolute ..... 288
  - Limit check ..... 287
  - Preamplifier ..... 287
  - Range start/stop (Spurious Emissions) ..... 284
  - RBW ..... 285
  - Reference level ..... 286
  - RF attenuation ..... 286
  - RF attenuation mode ..... 286
  - Spurious Emissions ..... 283
  - Sweep behavior ..... 287
  - Sweep points ..... 287
  - Sweep time ..... 285
  - Sweep time mode ..... 285
  - Transducer ..... 287
  - VBW ..... 285
- Sweep List
  - Deleting ranges ..... 254
  - Fast SEM ..... 250
  - Filter type ..... 250
  - Inserting ranges ..... 254
  - Limit absolute ..... 253
  - Limit check ..... 252
  - Limit relative ..... 253
  - Preamplifier ..... 252
  - Range start/stop (SEM) ..... 249
  - RBW ..... 250
  - Reference level ..... 251
  - RF attenuation ..... 251
  - RF attenuation mode ..... 251
  - SEM ..... 248
  - Softkey ..... 248
  - Sweep Points (SEM) ..... 254
  - Sweep Time ..... 251
  - Sweep Time Mode ..... 250
  - Symmetrical ..... 254
  - Transducer ..... 252
  - VBW ..... 250
- Sweep points
  - EMI ..... 337
  - Logarithmic x-axis scaling ..... 472
- Sweep Points ..... 504
- Sweep Repeat
  - GPIB ..... 859
- Sweep status
  - Status register ..... 826
- Sweep time
  - Harmonics ..... 318
  - Spurious Emissions range ..... 285
  - Statistics ..... 299
- Sweep Time ..... 497
  - Auto (Softkey) ..... 502
  - CP/ACLR ..... 156, 170
  - Manual (Softkey) ..... 502
  - SEM range ..... 251
  - Softkey ..... 170
  - Values ..... 502
- Sweep time mode
  - Spurious Emissions range ..... 285
- Sweep Time Mode
  - SEM range ..... 250
- Sweeps
  - Reverse, external generator ..... 384
- Switching
  - Focus area ..... 52
  - Keyboard display ..... 52
  - Maximized/split display ..... 52
- SWT (channel setting) ..... 82
- Symmetric setup
  - SEM ..... 254
  - SEM ranges ..... 239
- SYNC TRIGGER
  - Connector ..... 57
- System
  - Configuration ..... 783
  - Configuration (remote) ..... 1444

- Messages ..... 789
- Preset operating mode ..... 791
- SYSTEM
  - Keys ..... 51
- T**
- Tabs**
  - All ..... 101
  - Channels ..... 109
  - MultiView ..... 81, 119
  - Switching ..... 81
- TCP/IP**
  - Address, External generator ..... 389
  - External generator ..... 389
- TD-SCDMA BTS**
  - Application ..... 118
- TD-SCDMA UE**
  - Application ..... 118
- Tdf (channel bar) ..... 84**
- Technical support ..... 1550**
- Technology**
  - MSR TX channel ..... 183
- Temperature**
  - Check ..... 727
  - Check (remote) ..... 1401
  - Excessive ..... 31
  - Frontend ..... 727
  - Frontend (remote) ..... 1401
  - Frontend, status bit ..... 727, 833
  - Self-alignment ..... 727
  - Self-alignment (remote) ..... 1401
  - Status register ..... 833
- Template ..... 711**
- Test report ..... 710**
- Theme**
  - Display ..... 739, 740
  - Display (remote) ..... 1429
- Third order intercept point**
  - see TOI ..... 319
- Threshold**
  - Limit lines ..... 594, 601
  - Peak search ..... 559, 563
  - Signal tracking ..... 477
- Time**
  - Format ..... 736
  - Hiding/restoring ..... 737
  - Instrument setting ..... 735
- Time Domain Power ..... 308**
  - About ..... 308
  - Configuring ..... 310
  - Limit lines ..... 309, 311
  - Measurement (remote control) ..... 1061
  - Measurement example ..... 312
  - Measuring ..... 311
  - Restricting range ..... 309
  - Results ..... 308, 311
- Time frames**
  - Configuring ..... 507
  - Continuing ..... 507
  - Navigating ..... 507, 632
  - per sweep ..... 508
  - Selecting ..... 507, 639
  - Spectrograms ..... 630
- Time trigger**
  - Repetition interval ..... 518
  - Softkey ..... 517
- Timestamps**
  - Softkey (Spectrogram) ..... 639
  - Spectrograms ..... 632, 639
- TOI ..... 319**
  - About the measurement ..... 320
  - Basics ..... 320
  - Calculation method ..... 322
  - Configuring ..... 325
  - Determining ..... 326
  - Markers ..... 326
  - Programming example ..... 1078
  - Results ..... 324
  - Search signals ..... 326, 327
- TOI (marker functions) ..... 86**
- Toolbar**
  - Hiding/restoring ..... 737
  - Overview ..... 89
- Total Harmonic Distortion**
  - Measurement ..... 317
- Touch screen**
  - Colors (remote) ..... 1429
  - Settings (remote control) ..... 1425
- touchscreen**
  - Alignment ..... 728, 732
- Touchscreen**
  - Alignment ..... 728, 734
  - Colors ..... 739, 740
  - De-/Activating ..... 735
  - Displayed items ..... 736
  - Overview ..... 43
  - Settings ..... 734
  - Theme ..... 740
- Touchstone file (SnP)**
  - Input ..... 1406
- Touchstone files**
  - Programming example ..... 1424
- Touchstone format**
  - Input files ..... 1406
- Trace information ..... 85**
  - Detector type ..... 85
  - Trace number ..... 85
  - Window title bar ..... 85
- Trace math**
  - Functions ..... 647
  - Settings ..... 646
- Trace smoothing ..... 621**
- Traces ..... 626**
  - Average mode ..... 625
  - Averaging ..... 620
  - Averaging (algorithm) ..... 619
  - Averaging (remote control) ..... 1245
  - Configuration ..... 622
  - Configuration (Softkey) ..... 646
  - Configuring ..... 628
  - Configuring (remote control) ..... 1240
  - Copying ..... 627
  - Copying (remote control) ..... 1247
  - Detector ..... 344, 348, 609, 624
  - Detector (remote control) ..... 1246
  - Export format ..... 652, 654, 692
  - Exporting ..... 650, 651, 652, 655, 690
  - Hold ..... 624
  - Mode ..... 623
  - Mode (CP/ACLR) ..... 159
  - Mode (remote) ..... 1241
  - Saving ..... 682
  - Settings ..... 609

- Settings (remote control) ..... 1240
- Settings, predefined ..... 626
- Traces to be Checked
  - Limit lines ..... 599
- Tracking
  - see External generator ..... 386
- Tracking bandwidth ..... 477
- Tracking generator
  - see External generator ..... 375
- Tracking threshold ..... 477
- Transducer factor ..... 338
- Transducers
  - Activating/Deactivating ..... 758
  - Adjusting reference level ..... 759
  - Calibration with external generator ..... 381, 392
  - Checking ..... 764
  - Comment ..... 760
  - Compatibility ..... 758
  - Compatible ..... 764
  - Configuration ..... 755
  - Configuration (remote control) ..... 1402
  - Configuring ..... 763
  - Copying ..... 759, 764
  - Creating ..... 759, 765
  - Data points ..... 761
  - Deleting ..... 759, 765
  - Deleting values ..... 761
  - Editing ..... 759, 764
  - Factors ..... 754
  - Inserting values ..... 761
  - Managing ..... 757
  - Name ..... 760
  - Recalling ..... 678
  - Saving ..... 678, 682, 761
  - Secure user mode ..... 757
  - SEM range ..... 252
  - Settings ..... 756
  - Shifting ..... 761, 766
  - Softkey ..... 756
  - Spurious Emissions range ..... 287
  - Storing ..... 756
  - Unit ..... 761
  - Validity ..... 756
  - View filter ..... 758
  - X-axis ..... 761
  - Y-axis unit ..... 755
- Transient Analysis
  - Application ..... 118, 119
- Transmission measurement
  - Calibration, external generator ..... 391
  - External generator ..... 378
  - How to, external generator ..... 394
- TRG (channel bar) ..... 83
- Trigger
  - Configuration preview ..... 513
  - Drop-out time ..... 518
  - Drop-Out Time ..... 510
  - Drop-out time (Power sensor) ..... 373
  - Event (remote) ..... 896
  - External (remote) ..... 1221
  - External power ..... 372
  - External, errors ..... 1546
  - Holdoff ..... 511, 519
  - Holdoff (Power sensor) ..... 373
  - Hysteresis ..... 509, 518
  - Hysteresis (Power sensor) ..... 373
  - Level (Power sensor) ..... 372
  - Measurements ..... 508
  - Offset ..... 509, 518
  - Output ..... 468
  - Power sensor ..... 372, 375
  - Slope ..... 519, 1221
  - Slope (Power sensor) ..... 373
  - Status register ..... 826
- TRIGGER
  - Connector ..... 57
- TRIGGER INPUT / OUTPUT
  - Connectors ..... 47
- Trigger level ..... 517
  - External trigger (remote) ..... 1219
  - I/Q Power (remote) ..... 1220
  - IF Power (remote) ..... 1220
  - RF Power (remote) ..... 1221
- Trigger source ..... 509, 514
  - BB Power ..... 516
  - External ..... 514
  - Free Run ..... 514
  - I/Q Power ..... 516
  - IF Power ..... 515
  - Power Sensor ..... 517
  - RF Power ..... 516
  - Time ..... 517
  - Video ..... 515
- Trigger/Gate
  - Configuration (Softkey) ..... 512
- TRK (marker functions) ..... 86
- Troubleshooting
  - CP/ACLR ..... 203
  - File name error ..... 1358
  - Hardware ..... 802
  - Input overload ..... 1110
  - Low frequencies ..... 1548
  - Overload, external generator ..... 385
  - Remote control programs ..... 856, 1547
  - Timeout for data capture ..... 1549
  - Trace display ..... 1548
- Trying out
  - Prerequisites ..... 61
- TTL handshake
  - see TTL synchronization ..... 389
- TTL synchronization
  - AUX control, external generator ..... 376
  - External generator ..... 376, 383, 389
- Tuning range
  - External reference ..... 782
- Tx Bandwidth
  - SEM ..... 257
- TX channel
  - MSR, Center frequency ..... 183
  - MSR, technology ..... 183
- TX channels
  - in MSR sub blocks ..... 182
  - MSR, configuring ..... 182
  - MSR, weighting filters ..... 183
- U**
- UNCAL
  - Error ..... 1544
- UNCAL (status display) ..... 1544
- Undo
  - Key ..... 46



- Units
  - Power sensor ..... 371
  - Reference level ..... 484, 485
  - Transducer factors ..... 761
  - Y-axis (statistics) ..... 303
- Update Path
  - Remote control ..... 1450
- Update rate
  - Display ..... 735
- Updating
  - Firmware ..... 790
- Upper Level Hysteresis ..... 532
- USB
  - Address ..... 821
  - Connector ..... 54
  - Connectors ..... 51
  - Interfaces ..... 821
- User ports
  - Remote control ..... 1189
- User standards
  - CP/ACLR ..... 166, 177
  - Loading (CP/ACLR) ..... 196
  - Managing ..... 166, 177
  - Storing (CP/ACLR) ..... 196
- Users
  - Network ..... 878
  - Password ..... 878
- V**
- V network ..... 350
- V-network
  - EMI ..... 338
- VBW
  - CP/ACLR ..... 158
  - see Video bandwidth ..... 493
  - SEM range ..... 250
  - Spurious Emissions range ..... 285
- VBW (channel setting) ..... 82
- VBW/RBW coupling ..... 494
- Vendor ID
  - Rohde & Schwarz ..... 821
- Version information ..... 784
- Vertical Line 1/2
  - Softkeys ..... 592
- Video
  - Output ..... 360
  - Trigger source ..... 515
- Video bandwidth ..... 501
  - Auto (Softkey) ..... 501
  - Impact ..... 493
  - Manual (Softkey) ..... 501
  - RMS detector ..... 494
- Video output ..... 467, 1188
- Videos ..... 24
- View filter
  - Limit lines ..... 599
  - Transducer lines ..... 758
- VISA ..... 817
  - Resource string ..... 818
- Visible
  - Limit lines ..... 599
- Volatile memory
  - Secure user mode ..... 39, 675
- Volume
  - Headphones ..... 51
  - Remote control ..... 1190
- VSA (Vector Signal Analysis)
  - Application ..... 119
- W**
- W-CDMA signals
  - CP/ACLR ..... 200
- Wait
  - Remote ..... 897
- Waiting for trigger
  - Status register ..... 826
- Warmup time ..... 731
- Web browser
  - Configuration interface ..... 875
- Weighting filters
  - CP/ACLR ..... 175
  - MSR ACLR ..... 183
  - MSR, adjacent channels ..... 186
  - MSR, gap channels ..... 191
  - Remote ..... 922
- White noise
  - Measurement example (statistics) ..... 306
- White papers ..... 24
- Wideband
  - PSA89600 ..... 860
- Window title bar ..... 85
- Windows
  - Adding ..... 104, 539
  - Adding (remote) ..... 1100
  - Arranging ..... 105, 540
  - Closing ..... 105, 540
  - Closing (remote) ..... 1105
  - Dialog boxes ..... 94
  - Layout (remote) ..... 1103
  - Maximizing (remote) ..... 1099, 1252
  - Querying (remote) ..... 1101
  - Replacing (remote) ..... 1102
  - Size ..... 106
  - Splitting (remote) ..... 1099, 1252
  - Types (remote) ..... 1100
- Windows 10
  - Access ..... 34
- WLAN
  - Application ..... 119
- WRONG\_FW
  - Error ..... 726, 790, 1544, 1545
- X**
- X-axis
  - Adjusting (Spurious Emissions) ..... 288
  - Limit lines ..... 602
  - Scaling ..... 349, 472, 475
  - Transducer lines ..... 761
- X-Offset
  - Limit lines ..... 599
- X-value
  - Marker ..... 342, 553
- Y**
- Y-axis
  - Limit lines ..... 602
  - Max/Min (statistics) ..... 303
  - Optimizing display ..... 491
  - Scaling ..... 481, 491
  - Settings ..... 489

Y-Offset	
Limit lines .....	600
Yellow star	
see Invalid data icon .....	81
YIG-preselector	
Activating/Deactivating .....	365
Activating/Deactivating (remote) .....	1112

## Z

Zero span	
Measurement .....	129
Measurement examples .....	143
Softkey .....	475
Zeroing	
Power sensor .....	370
Zoom	
Graphical .....	99
Measurement .....	99
Zoom limits	
Search range .....	542
Using for searches .....	560, 563
Zooming .....	541, 545
Activating (remote) .....	1237
Area (Multiple mode, remote) .....	1238
Area (remote) .....	1236
Multiple mode .....	541, 543
Multiple mode (remote) .....	1238, 1239
Remote .....	1236
Restoring original display .....	544
Single mode .....	541, 543
Single mode (remote) .....	1236
Trying out .....	71