

# R&S®FSW-K91

## WLAN Measurements

### User Manual



1173935702  
Version 41



This manual applies to the following FSW models with firmware version 6.10 and later:

- R&S®FSW8 (1331.5003K08 / 1312.8000K08)
- R&S®FSW13 (1331.5003K13 / 1312.8000K13)
- R&S®FSW26 (1331.5003K26 / 1312.8000K26)
- R&S®FSW43 (1331.5003K43 / 1312.8000K43)
- R&S®FSW50 (1331.5003K50 / 1312.8000K50)
- R&S®FSW67 (1331.5003K67 / 1312.8000K67)
- R&S®FSW85 (1331.5003K85 / 1312.8000K85)

The following firmware options are described:

- FSW-K91 WLAN 802.11a (1313.1500.02)
- FSW-K91ac WLAN 802.11ac (1313.4209.02)
- FSW-K91ax WLAN 802.11ax (1331.6345.02)
- FSW-K91be WLAN 802.11be (1350.6730.02)
- FSW-K91n WLAN 802.11n (1313.1516.02)
- FSW-K91p WLAN 802.11p (1321.5646.02)

© 2024 Rohde & Schwarz

Muehldorfstr. 15, 81671 Muenchen, Germany

Phone: +49 89 41 29 - 0

Email: [info@rohde-schwarz.com](mailto:info@rohde-schwarz.com)

Internet: [www.rohde-schwarz.com](http://www.rohde-schwarz.com)

Subject to change – data without tolerance limits is not binding.

R&S® is a registered trademark of Rohde & Schwarz GmbH & Co. KG.

"WiMAX", "Mobile WiMAX", "Fixed WiMAX", "WiMAX Forum", "WiMAX Certified", "WiMAX Forum Certified", "WiGRID", the WiMAX Forum logo, the WiMAX Forum Certified logo and the WiGRID logo are trademarks or registered trademarks of the WiMAX Forum.

All other trademarks are the properties of their respective owners.

1173.9357.02 | Version 41 | R&S®FSW-K91

Throughout this manual, products from Rohde & Schwarz are indicated without the ® symbol, e.g. R&S®FSW is indicated as R&S FSW.

# Contents

<b>1</b>	<b>Documentation overview.....</b>	<b>7</b>
1.1	Getting started manual.....	7
1.2	User manuals and help.....	7
1.3	Service manual.....	7
1.4	Instrument security procedures.....	8
1.5	Printed safety instructions.....	8
1.6	Specifications and brochures.....	8
1.7	Release notes and open-source acknowledgment (OSA).....	8
1.8	Application notes, application cards, white papers, etc.....	9
1.9	Videos.....	9
<b>2</b>	<b>Welcome to the WLAN application.....</b>	<b>10</b>
2.1	Starting the WLAN application.....	11
2.2	Understanding the display information.....	11
<b>3</b>	<b>Measurements and result displays.....</b>	<b>15</b>
3.1	WLAN I/Q measurement (modulation accuracy, flatness and tolerance).....	15
3.2	Frequency sweep measurements.....	58
<b>4</b>	<b>Measurement basics.....</b>	<b>65</b>
4.1	Signal processing for multicarrier measurements (IEEE 802.11a, g (OFDM), j, p) .....	65
4.2	Signal processing for single-carrier measurements (IEEE 802.11b, g (DSSS))....	72
4.3	Signal processing for MIMO measurements (IEEE IEEE 802.11ac, ax, n, be).....	78
4.4	Signal processing for high-efficiency wireless measurements (IEEE 802.11ax)..	87
4.5	Signal processing for extremely high throughput (EHT) wireless measurements (IEEE 802.11be).....	92
4.6	Channels and carriers.....	94
4.7	Recognized vs. analyzed PPDU.....	95
4.8	Demodulation parameters - logical filters.....	95
4.9	I/Q data import and export.....	97
4.10	Basics on input from I/Q data files.....	98
4.11	Trigger basics.....	99
4.12	WLAN I/Q measurements in MSRA operating mode.....	103

<b>5</b>	<b>Configuration.....</b>	<b>105</b>
5.1	Multiple measurement channels and sequencer function.....	105
5.2	Display configuration.....	107
5.3	WLAN I/Q measurement configuration.....	107
5.4	Frequency sweep measurements.....	199
<b>6</b>	<b>Analysis.....</b>	<b>204</b>
<b>7</b>	<b>I/Q data import and export.....</b>	<b>205</b>
<b>8</b>	<b>How to perform measurements in the WLAN application.....</b>	<b>206</b>
8.1	How to determine modulation accuracy, flatness and tolerance parameters for WLAN signals.....	206
8.2	How to analyze WLAN signals in a MIMO measurement setup.....	208
8.3	How to determine the OBW, SEM, ACLR or CCDF for WLAN signals.....	213
<b>9</b>	<b>Optimizing and troubleshooting the measurement.....</b>	<b>215</b>
9.1	Optimizing the measurement results.....	215
9.2	Error messages and warnings.....	216
<b>10</b>	<b>Remote commands for WLAN 802.11 measurements.....</b>	<b>218</b>
10.1	Common suffixes.....	219
10.2	Introduction.....	219
10.3	Activating WLAN 802.11 measurements.....	224
10.4	Selecting a measurement.....	228
10.5	Configuring the WLAN IQ measurement (modulation accuracy, flatness and tolerance).....	235
10.6	Configuring frequency sweep measurements on WLAN 802.11 signals.....	342
10.7	Configuring the result display.....	347
10.8	Starting a measurement.....	367
10.9	Retrieving results.....	372
10.10	Analysis.....	427
10.11	Status registers.....	429
10.12	Deprecated commands.....	436
10.13	Programming examples (R&S FSW WLAN application).....	440
	<b>Annex.....</b>	<b>446</b>
<b>A</b>	<b>Sample rate and maximum usable I/Q bandwidth for RF input.....</b>	<b>446</b>

A.1	Available bandwidth extension options.....	447
A.2	Relationship between sample rate, record length and usable I/Q bandwidth.....	447
A.3	FSW without additional bandwidth extension options.....	449
A.4	FSW with I/Q bandwidth extension option B40 or U40.....	450
A.5	FSW with I/Q bandwidth extension option B80 or U80.....	450
A.6	FSW with activated I/Q bandwidth extension option B160 or U160.....	451
A.7	FSW with activated I/Q bandwidth extension option B320/U320.....	451
A.8	FSW with activated I/Q bandwidth extension option B512.....	452
A.9	FSW with activated I/Q bandwidth extension option B1200.....	454
A.10	FSW with activated I/Q bandwidth extension option B2001.....	456
A.11	FSW with activated I/Q bandwidth extension option B2000.....	459
A.12	FSW with activated I/Q bandwidth extension option B5000.....	460
	List of commands (WLAN).....	462
	Index.....	473



# 1 Documentation overview

This section provides an overview of the FSW user documentation. Unless specified otherwise, you find the documents at:

[www.rohde-schwarz.com/manual/FSW](http://www.rohde-schwarz.com/manual/FSW)

Further documents are available at:

[www.rohde-schwarz.com/product/FSW](http://www.rohde-schwarz.com/product/FSW)

## 1.1 Getting started manual

Introduces the FSW and describes how to set up and start working with the product. Includes basic operations, typical measurement examples, and general information, e.g. safety instructions, etc.

A printed version is delivered with the instrument. A PDF version is available for download on the Internet.

## 1.2 User manuals and help

Separate user manuals are provided for the base unit and the firmware applications:

- Base unit manual  
Contains the description of all instrument modes and functions. It also provides an introduction to remote control, a complete description of the remote control commands with programming examples, and information on maintenance, instrument interfaces and error messages. Includes the contents of the getting started manual.
- Firmware application manual  
Contains the description of the specific functions of a firmware application, including remote control commands. Basic information on operating the FSW is not included.

The contents of the user manuals are available as help in the FSW. The help offers quick, context-sensitive access to the complete information for the base unit and the firmware applications.

All user manuals are also available for download or for immediate display on the Internet.

## 1.3 Service manual

Describes the performance test for checking the rated specifications, module replacement and repair, firmware update, troubleshooting and fault elimination, and contains mechanical drawings and spare part lists.

The service manual is available for registered users on the global Rohde & Schwarz information system (GLORIS):

<https://gloris.rohde-schwarz.com>

## 1.4 Instrument security procedures

Deals with security issues when working with the FSW in secure areas. It is available for download on the internet.

## 1.5 Printed safety instructions

Provides safety information in many languages. The printed document is delivered with the product.

## 1.6 Specifications and brochures

The specifications document, also known as the data sheet, contains the technical specifications of the FSW. It also lists the firmware applications and their order numbers, and optional accessories.

The brochure provides an overview of the instrument and deals with the specific characteristics.

See [www.rohde-schwarz.com/brochure-datasheet/FSW](http://www.rohde-schwarz.com/brochure-datasheet/FSW)

## 1.7 Release notes and open-source acknowledgment (OSA)

The release notes list new features, improvements and known issues of the current software version, and describe the software installation.

The software uses several valuable open source software packages. An open source acknowledgment document provides verbatim license texts of the used open source software.

See [www.rohde-schwarz.com/firmware/FSW](http://www.rohde-schwarz.com/firmware/FSW)



## 1.8 Application notes, application cards, white papers, etc.

These documents deal with special applications or background information on particular topics.

See [www.rohde-schwarz.com/application/FSW](http://www.rohde-schwarz.com/application/FSW)

## 1.9 Videos

Find various videos on Rohde & Schwarz products and test and measurement topics on YouTube: <https://www.youtube.com/@RohdeundSchwarz>

## 2 Welcome to the WLAN application

The R&S FSW WLAN application extends the functionality of the FSW to enable accurate and reproducible Tx measurements of a WLAN device under test (DUT) in accordance with the standards specified for the device. The following standards are currently supported (if the corresponding firmware option is installed):

- IEEE standards 802.11a
- IEEE standards 802.11ac (SISO + MIMO)
- IEEE standards 802.11b
- IEEE standards 802.11be
- IEEE standards 802.11g (OFDM)
- IEEE standards 802.11g (DSSS)
- IEEE standards 802.11j
- IEEE standards 802.11n (SISO + MIMO)
- IEEE standards 802.11p
- IEEE standards 802.11ax (SISO + MIMO)

The R&S FSW WLAN application features:

### Modulation measurements

- "Constellation" diagram for demodulated signal
- "Constellation" diagram for individual carriers
- I/Q offset and I/Q imbalance
- Modulation error (EVM) for individual carriers or symbols
- Amplitude response and group-delay distortion (spectrum flatness)
- Carrier and symbol frequency errors

### Further measurements and results

- Amplitude statistics ("CCDF") and crest factor
- FFT, also over a selected part of the signal, e.g. preamble
- Payload bit information
- Freq/Phase Err vs. Preamble

This user manual contains a description of the functionality that is specific to the application, including remote control operation.

### General FSW functions

The application-independent functions for general tasks on the FSW are also available for WLAN 802.11 measurements and are described in the FSW user manual. In particular, this comprises the following functionality:

- Data management
- General software preferences and information

The latest version is available for download at the product homepage

<http://www.rohde-schwarz.com/product/FSW.html>.

### Installation

You can find detailed installation instructions in the FSW Getting Started manual or in the Release Notes.

## 2.1 Starting the WLAN application

The WLAN measurements require a special application on the FSW.

### To activate the WLAN application

1. Select the [MODE] key.

A dialog box opens that contains all operating modes and applications currently available on your FSW.

2. Select the "WLAN" item.



The FSW opens a new measurement channel for the WLAN application.

The measurement is started immediately with the default settings. It can be configured in the WLAN "Overview" dialog box, which is displayed when you select the "Overview" softkey from any menu (see [Chapter 5.3.1, "Configuration overview"](#), on page 108).

## 2.2 Understanding the display information

The following figure shows a measurement diagram during analyzer operation. All information areas are labeled. They are explained in more detail in the following sections.



- 1 = Channel bar for firmware and measurement settings
- 2 = Window title bar with diagram-specific (trace) information
- 3 = Diagram area with marker information
- 4 = Diagram footer with diagram-specific information, depending on result display
- 5 = Instrument status bar with error messages, progress bar and date/time display



**MSRA operating mode**

In MSRA operating mode, additional tabs and elements are available. A colored background of the screen behind the measurement channel tabs indicates that you are in MSRA operating mode.

For details on the MSRA operating mode see the FSW MSRA User Manual.

**Channel bar information**

In the WLAN application, the FSW shows the following settings:

*Table 2-1: Information displayed in the channel bar in the WLAN application*

Label	Description
"Sample Rate Fs"	Input sample rate
"PPDU / MCS Index / GI"	IEEE 802.11a, ac, g (OFDM), j, n, p: The PPDU type, MCS index and guard interval (GI) used for the analysis of the signal; Depending on the demodulation settings, these values are either detected automatically from the signal or the user settings are applied.
"PPDU / MCS Index / GI+HE-LTF"	WLAN 802.11ax: PPDU type, MCS index, sum of guard interval (GI) length and high efficiency long training field (HE-LTF) length used for the analysis of the signal

Label	Description
"PPDU / MCS/ GI+EHT-LTF"	WLAN 802.11be: PPDU type, MCS index, sum of guard interval (GI) length and extremely high throughput long training field (EHT-LTF) length used for the analysis of the signal
"PPDU / Data Rate"	WLAN 802.11b: The PPDU type and data rate used for the analysis of the signal; Depending on the demodulation settings, these values are either detected automatically from the signal or the user settings are applied.
"Standard"	Selected WLAN measurement standard
"Meas Setup"	Number of Transmitter (Tx) and Receiver (Rx) channels used in the measurement (for MIMO)
"Capt time / Samples"	Duration of signal capture and number of samples captured
"Data Symbols"	The minimum and maximum number of data symbols that a PPDU may have if it is to be considered in results analysis.
"PPDUs" [x of y (z)]	For statistical evaluation over PPDUs (see <a href="#">"PPDU Statistic Count / No of PPDUs to Analyze"</a> on page 185): <x> PPDUs of totally required <y> PPDUs have been analyzed so far. <z> PPDUs were analyzed in the most recent sweep. Note: if noise cancellation is enabled, the defined number of averaged sweeps are considered as one analyzed PPDU.
"IQNC"	I/Q noise cancellation is enabled. See <a href="#">"Reduce Noise on I/Q Data"</a> on page 136.

In addition, the channel bar also displays information on instrument settings that affect the measurement results even though this is not immediately apparent from the display of the measured values (e.g. transducer or trigger settings). This information is displayed only when applicable for the current measurement. For details see the FSW Getting Started manual.

### Window title bar information

For each diagram, the header provides the following information:



**Figure 2-1: Window title bar information in the WLAN application**

- 1 = Window number
- 2 = Window type
- 3 = Further measurement settings
- 4 = Trace color
- 5 = Trace number
- 6 = Trace mode

**Diagram footer information**

The diagram footer (beneath the diagram) contains the start and stop values for the displayed x-axis range.

**Status bar information**

Global instrument settings, the instrument status and any irregularities are indicated in the status bar beneath the diagram. Furthermore, the progress of the current operation is displayed in the status bar. Click on a displayed warning or error message to obtain more details (see also [.](#)

## 3 Measurements and result displays

The R&S FSW WLAN application provides several different measurements in order to determine the parameters described by the WLAN 802.11 specifications.

For details on selecting measurements, see [Chapter 5.2, "Display configuration"](#), on page 107.

- [WLAN I/Q measurement \(modulation accuracy, flatness and tolerance\)](#).....15
- [Frequency sweep measurements](#).....58

### 3.1 WLAN I/Q measurement (modulation accuracy, flatness and tolerance)

The default WLAN I/Q measurement captures the I/Q data from the WLAN signal using a (nearly rectangular) filter with a relatively large bandwidth. The I/Q data captured with this filter includes magnitude and phase information. That allows the R&S FSW WLAN application to demodulate broadband signals and determine various characteristic signal parameters in just one measurement. Modulation accuracy, spectrum flatness, center frequency tolerance and symbol clock tolerance are only a few of the characteristic parameters.

Other parameters specified in the WLAN 802.11 standard require a better signal-to-noise level or a smaller bandwidth filter than the I/Q measurement provides and must be determined in separate measurements (see [Chapter 3.2, "Frequency sweep measurements"](#), on page 58).

- [Modulation accuracy, flatness and tolerance parameters](#).....15
- [Evaluation methods for WLAN IQ measurements](#).....27

#### 3.1.1 Modulation accuracy, flatness and tolerance parameters

The default WLAN I/Q measurement (Modulation Accuracy, Flatness,...) captures the I/Q data from the WLAN signal and determines all the following I/Q parameters in a single sweep.

*Table 3-1: WLAN I/Q parameters for IEEE 802.11a, ac, ax, g (OFDM), j, n, p, be*

Parameter	Description	Keyword for remote query (FETCh:BURSt:)
<b>General measurement parameters</b>		
Sample Rate Fs	Input sample rate	
PPDU	Type of analyzed PPDU	PPDU:TYPE
*) the limits can be changed via remote control (not manually, see <a href="#">Chapter 10.5.9, "Limits"</a> , on page 333); in this case, the currently defined limits are displayed here		

## WLAN I/Q measurement (modulation accuracy, flatness and tolerance)

Parameter	Description	Keyword for remote query (FETCh:BURSt:)
MCS Index	Modulation and Coding Scheme (MCS) index of the analyzed PPDU	MCSindex
Data Rate	Data rate used for analysis of the signal (IEEE 802.11a only)	
GI / GI+HE-LTF / GI+EHT-LTF	Guard interval length for current measurement Guard interval and high-efficiency long training field length (IEEE 802.11ax only) Guard interval and length of EHT long training field (IEEE 802.11be only)	GINterval
Meas Setup	Number of Transmitter (Tx) and Receiver (Rx) channels used in the measurement	
Capture time	Duration of signal capture	
Samples	Number of samples captured	
Data Symbols	The minimum and maximum number of data symbols that a PPDU can have if it is to be considered in results analysis	
<b>PPDU parameters</b>		
Analyzed PPDU	For statistical evaluation of PPDU (see "PPDU Statistic Count / No of PPDU to Analyze" on page 185): <x> PPDU of the required <y> PPDU have been analyzed so far. <z> indicates the number of analyzed PPDU in the most recent sweep.	
Number of recognized PPDU (global)	Number of PPDU recognized in capture buffer	
Number of analyzed PPDU (global)	Number of analyzed PPDU in capture buffer	COUNT
Number of analyzed PPDU in physical channel	Number of PPDU analyzed in entire signal (if available)	COUNT:ALL
<b>TX and Rx carrier parameters</b>		
I/Q offset [dB]	Transmitter center frequency leakage relative to the total Tx channel power (see Chapter 3.1.1.1, "I/Q offset", on page 20)	IQOFset
Gain imbalance [%/dB]	Amplification of the quadrature phase component of the signal relative to the amplification of the in-phase component (see Chapter 3.1.1.2, "Gain imbalance", on page 20)	GIMBalance
Quadrature offset [°]	Deviation of the quadrature phase angle from the ideal 90° (see Chapter 3.1.1.3, "Quadrature offset", on page 21).	QUADoffset
*) the limits can be changed via remote control (not manually, see Chapter 10.5.9, "Limits", on page 333); in this case, the currently defined limits are displayed here		



## WLAN I/Q measurement (modulation accuracy, flatness and tolerance)

Parameter	Description	Keyword for remote query (FETCh:BURSt:)
I/Q skew [s]	Delay of the transmission of the data on the I path compared to the Q path (see <a href="#">Chapter 3.1.1.4, "I/Q skew"</a> , on page 22)	IQSkew
PPDU power [dBm]	Mean PPDU power	
Crest factor [dB]	The ratio of the peak power to the mean power of the signal (also called Peak to Average Power Ratio, PAPR).	CRESt
MIMO Cross Power [dB]	Sum of RMS power from all cross streams	MCPower
MIMO Channel Power [dBm]	RMS power for each effective channel path from all active carriers.	MCHPower
Center frequency error [Hz]	Frequency error between the signal and the current center frequency of the FSW; the corresponding limits specified in the standard are also indicated*)  The absolute frequency error includes the frequency error of the FSW and that of the DUT. If possible, synchronize the transmitter FSW and the DUT using an external reference.  See FSW user manual > Instrument setup > External reference	CFERror
Symbol clock error [ppm]	Clock error between the signal and the sample clock of the FSW in parts per million (ppm), i.e. the symbol timing error; the corresponding limits specified in the standard are also indicated *)  If possible, synchronize the transmitter FSW and the DUT using an external reference.  See FSW user manual > Instrument setup > External reference	
CPE	Common phase error	CPError
<b>Stream parameters</b>		
BER Pilot [%]	Bit error rate (BER) of the pilot carriers	BERPilot
EVM all carriers [%/dB]	EVM (Error Vector Magnitude) of the payload symbols over all carriers; the corresponding limits specified in the standard are also indicated*)	EVM:ALL
EVM data carriers [%/dB]	EVM (Error Vector Magnitude) of the payload symbols over all data carriers; the corresponding limits specified in the standard are also indicated*)	EVM:DATA
EVM pilot carriers [%/dB]	EVM (Error Vector Magnitude) of the payload symbols over all pilot carriers; the corresponding limits specified in the standard are also indicated*)	EVM:PILOt
*) the limits can be changed via remote control (not manually, see <a href="#">Chapter 10.5.9, "Limits"</a> , on page 333); in this case, the currently defined limits are displayed here		

## WLAN I/Q measurement (modulation accuracy, flatness and tolerance)

Table 3-2: WLAN I/Q parameters for IEEE 802.11b or g (DSSS)

Parameter	Description	Keyword for remote query (FETCh:BURSt:)
Sample Rate Fs	Input sample rate	
PPDU	Type of the analyzed PPDU	PPDU:TYPE
Data Rate	Data rate used for analysis of the signal	
Meas Setup	Number of Transmitter (Tx) and Receiver (Rx) channels used in the measurement	
Capture time	Duration of signal capture	
No. of Samples	Number of samples captured (= sample rate * capture time)	
No. of Data Symbols	The minimum and maximum number of data symbols that a PPDU can have if it is to be considered in results analysis	
<b>PPDU parameters</b>		
Analyzed PDUs	For statistical evaluation of PDUs (see " <a href="#">PPDU Statistic Count / No of PDUs to Analyze</a> " on page 185): <x> PDUs of the required <y> PDUs have been analyzed so far. <z> indicates the number of analyzed PDUs in the most recent sweep.	
Number of recognized PDUs (global)	Number of PDUs recognized in capture buffer	
Number of analyzed PDUs (global)	Number of analyzed PDUs in capture buffer	COUNT
Number of analyzed PDUs in physical channel	Number of PDUs analyzed in entire signal (if available)	COUNT:ALL
Peak vector error	Peak vector error (EVM) over the complete PPDU including the preamble in % and in dB; calculated according to the IEEE 802.11b or g (DSSS) definition of the normalized error vector magnitude (see " <a href="#">Peak vector error (IEEE method)</a> " on page 24); The corresponding limits specified in the standard are also indicated *)	EVM:DIRect
PPDU EVM	EVM (Error Vector Magnitude) over the complete PPDU including the preamble in % and dB	PPDU:EVM:ALL
I/Q offset [dB]	Transmitter center frequency leakage relative to the total Tx channel power (see <a href="#">Chapter 3.1.1.1, "I/Q offset"</a> , on page 20)	IQOFset
Gain imbalance [%/dB]	Amplification of the quadrature phase component of the signal relative to the amplification of the in-phase component (see <a href="#">Chapter 3.1.1.2, "Gain imbalance"</a> , on page 20)	GIMBalance
*) the limits can be changed via remote control (not manually, see <a href="#">Chapter 10.5.9, "Limits"</a> , on page 333); in this case, the currently defined limits are displayed here		

## WLAN I/Q measurement (modulation accuracy, flatness and tolerance)

Parameter	Description	Keyword for remote query (FETCh:BURSt:)
Quadrature error [°]	Measure for the crosstalk of the Q-branch into the I-branch (see "Gain imbalance, I/Q offset, quadrature error" on page 75).	QUADoffset
Center frequency error [Hz]	Frequency error between the signal and the current center frequency of the FSW; the corresponding limits specified in the standard are also indicated*)  The absolute frequency error includes the frequency error of the FSW and that of the DUT. If possible, synchronize the transmitter FSW and the DUT using an external reference.  See FSW user manual > Instrument setup > External reference	CFError
Chip clock error [ppm]	Clock error between the signal and the chip clock of the FSW in parts per million (ppm), i.e. the chip timing error; the corresponding limits specified in the standard are also indicated *)  If possible, synchronize the transmitter FSW and the DUT using an external reference.  See FSW user manual > Instrument setup > External reference	
Rise time	Time the signal needs to increase its power level from 10% to 90% of the maximum or the average power (depending on the reference power setting)  The corresponding limits specified in the standard are also indicated *)	TRISe
Fall time	Time the signal needs to decrease its power level from 90% to 10% of the maximum or the average power (depending on the reference power setting)  The corresponding limits specified in the standard are also indicated *)	TFALL
Mean power [dBm]	Mean PPDU power	
Peak power [dBm]	Peak PPDU power	PEAK
Crest factor [dB]	The ratio of the peak power to the mean power of the PPDU (also called Peak to Average Power Ratio, PAPR).	CRESt
*) the limits can be changed via remote control (not manually, see <a href="#">Chapter 10.5.9, "Limits"</a> , on page 333); in this case, the currently defined limits are displayed here		

The R&S FSW WLAN application also performs statistical evaluation over several PPDU's and displays one or more of the following results:

**Table 3-3: Calculated summary results**

Result type	Description
Min	Minimum measured value
Mean/ Limit	Mean measured value / limit defined in standard
Max/Limit	Maximum measured value / limit defined in standard

### 3.1.1.1 I/Q offset

An I/Q offset indicates a carrier offset with fixed amplitude. This results in a constant shift of the I/Q axes. The offset is normalized by the mean symbol power and displayed in dB.

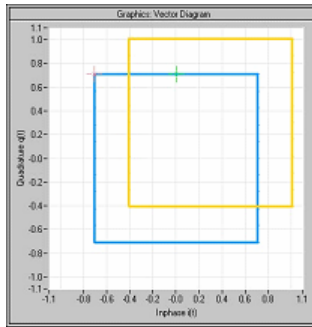

Figure 3-1: I/Q offset in a vector diagram

### 3.1.1.2 Gain imbalance

An ideal I/Q modulator amplifies the I and Q signal path by exactly the same degree. The imbalance corresponds to the difference in amplification of the I and Q channel and therefore to the difference in amplitude of the signal components. In the vector diagram, the length of the I vector changes relative to the length of the Q vector.

The result is displayed in dB and %, where 1 dB offset corresponds to roughly 12 % difference between the I and Q gain, according to the following equation:

$$Imbalance [dB] = 20 \log_{10} \left( \frac{|Gain_Q|}{|Gain_I|} \right)$$

Positive values mean that the Q vector is amplified more than the I vector by the corresponding percentage. For example, using the figures mentioned above:

$$0.98 \approx 20 \log_{10} \left( \frac{1.12}{1} \right)$$

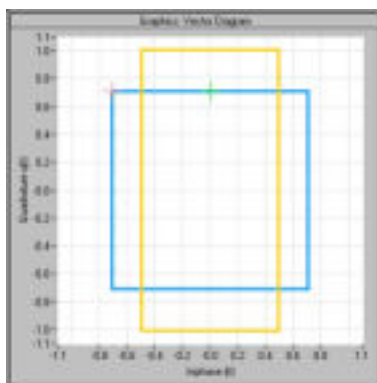

Figure 3-2: Positive gain imbalance

## WLAN I/Q measurement (modulation accuracy, flatness and tolerance)

Negative values mean that the I vector is amplified more than the Q vector by the corresponding percentage. For example, using the figures mentioned above:

$$-0.98 \approx 20 \log_{10}\left(\frac{1}{1.12}\right)$$

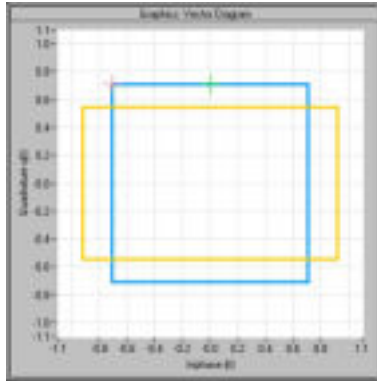

Figure 3-3: Negative gain imbalance

### 3.1.1.3 Quadrature offset

An ideal I/Q modulator sets the phase angle between the I and Q path mixer to exactly 90 degrees. With a quadrature offset, the phase angle deviates from the ideal 90 degrees, the amplitudes of both components are of the same size. In the vector diagram, the quadrature offset causes the coordinate system to shift.

A positive quadrature offset means a phase angle greater than 90 degrees:

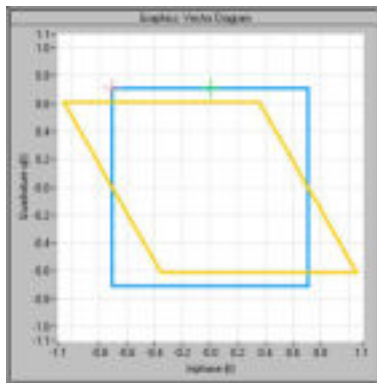

Figure 3-4: Positive quadrature offset

A negative quadrature offset means a phase angle less than 90 degrees:

## WLAN I/Q measurement (modulation accuracy, flatness and tolerance)

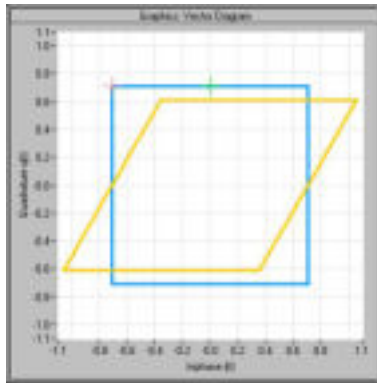

Figure 3-5: Negative quadrature offset

#### 3.1.1.4 I/Q skew

If transmission of the data on the I path is delayed compared to the Q path, or vice versa, the I/Q data becomes *skewed*.

The I/Q skew results can be compensated for together with [Gain imbalance](#) and [Quadrature offset](#) (see "[I/Q Mismatch Compensation](#)" on page 150).

#### 3.1.1.5 I/Q mismatch

I/Q mismatch is a comprehensive term for [Gain imbalance](#), [Quadrature offset](#), and [I/Q skew](#).

Compensation for I/Q mismatch is useful, for example, if the device under test is known to be affected by these impairments but the EVM without these effects is of interest. Note, however, that measurements strictly according to IEEE 802.11-2012, IEEE 802.11ac-2013 WLAN standard must not use compensation.

#### 3.1.1.6 RF carrier suppression (IEEE 802.11b, g (DSSS))

##### Standard definition

The RF carrier suppression, measured at the channel center frequency, shall be at least 15 dB below the peak  $\text{SIN}(x)/x$  power spectrum. The RF carrier suppression shall be measured while transmitting a repetitive 01 data sequence with the scrambler disabled using DQPSK modulation. A 100 kHz resolution bandwidth shall be used to perform this measurement.

##### Comparison to IQ offset measurement in the R&S FSW WLAN application

The IQ offset measurement in the R&S FSW WLAN application returns the current carrier feedthrough normalized to the mean power at the symbol timings. This measurement does not require a special test signal and is independent of the transmit filter shape.

## WLAN I/Q measurement (modulation accuracy, flatness and tolerance)

The RF carrier suppression measured according to the standard is inversely proportional to the IQ offset measured in the R&S FSW WLAN application. The difference (in dB) between the two values depends on the transmit filter shape. Determine it with a reference measurement.

The following table lists the difference exemplarily for three transmit filter shapes ( $\pm 0.5$  dB):

Transmit filter	– IQ-Offset [dB] – RF-Carrier-Suppression [dB]
Rectangular	11 dB
Root raised cosine, "α" = 0.3	10 dB
Gaussian, "α" = 0.3	9 dB

### 3.1.1.7 EVM measurement

The R&S FSW WLAN application provides two different types of EVM calculation.

#### PPDU EVM (direct method)

The PPDU EVM (direct) method evaluates the root mean square EVM over one PPDU. That is the square root of the averaged error power normalized by the averaged reference power:

$$EVM = \sqrt{\frac{\sum_{n=0}^{N-1} |x_{meas}(n) - x_{ref}(n)|^2}{\sum_{n=0}^{N-1} |x_{ref}(n)|^2}} = \sqrt{\frac{\sum_{n=0}^{N-1} |e(n)|^2}{\sum_{n=0}^{N-1} |x_{ref}(n)|^2}}$$

Before calculation of the EVM, tracking errors in the measured signal are compensated for if specified by the user. In the ideal reference signal, the tracking errors are always compensated for. Tracking errors include phase (center frequency error + common phase error), timing (sampling frequency error) and gain errors. Quadrature offset and gain imbalance errors, however, are not corrected.

The PPDU EVM is not part of the IEEE standard and no limit check is specified. Nevertheless, this commonly used EVM calculation can provide some insight in modulation quality and enables comparisons to other modulation standards.

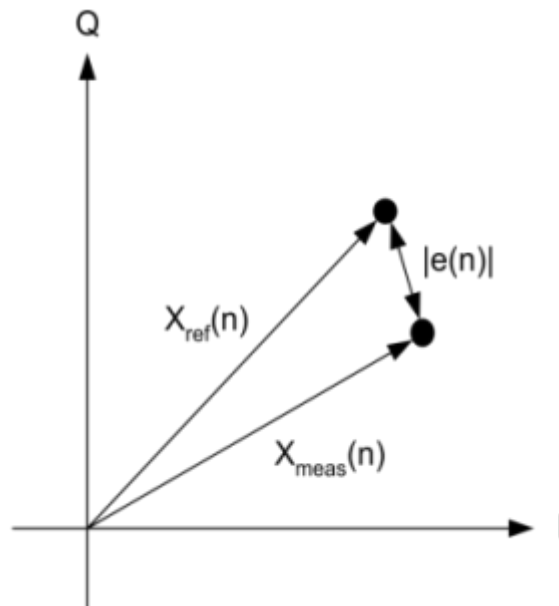

Figure 3-6: I/Q diagram for EVM calculation

#### Peak vector error (IEEE method)

The peak vector error (Peak EVM) is defined in section 18.4.7.8 "Transmit modulation accuracy" of the IEEE 802.11b standard. The phase, timing and gain tracking errors of the measurement signal (center frequency error, common phase error, sampling frequency error) are compensated for before EVM calculation.

The standard does not specify a normalization factor for the error vector magnitude. To get an EVM value that is independent of the level, the R&S FSW WLAN application normalizes the EVM values. Thus, an EVM of 100% indicates that the error power on the I- or Q-channels equals the mean power on the I- or Q-channels, respectively.

The peak vector error is the maximum EVM over all payload symbols and all active carriers for one PPDU. If more than one PPDU is analyzed the Min / Mean / Max columns show the minimum, mean or maximum Peak EVM of all analyzed PDUs. This can be the case, for example, if several analyzed PDUs are in the capture buffer or due to the [PPDU Statistic Count / No of PDUs to Analyze](#) setting.

The IEEE 802.11b or g (DSSS) standards allow a peak vector error of less than 35%. In contrary to the specification, the R&S FSW WLAN application does not limit the measurement to 1000 chips length, but searches the maximum over the whole PPDU.

#### 3.1.1.8 Unused tone error

Similarly to the adjacent channel power requirements for other WLAN standards, the IEEE 802.11ax standard specifies limits for power leakage into neighboring resource units (IEEE P802.11ax/D1.2, "Transmitter modulation accuracy (EVM) test" section). In high-efficiency wireless signals, the subcarriers or frequencies that are not used for active transmission are referred to as *unused tones*. Thus, the parameter that indicates the power leakage into adjacent resource units is referred to as the *unused tone error*.



## WLAN I/Q measurement (modulation accuracy, flatness and tolerance)

The R&S FSW WLAN application provides a dedicated result display for the IEEE 802.11ax standard for HE trigger-based PPDU.

The region in which the power leakage must be determined depends on the size and position within the channel of the resource unit being checked. Up to 3 times the number of subcarriers contained in the resource unit are checked on either side of it. Any remaining subcarriers are checked against the fixed limit of -35 dB. However, only subcarriers in the same channel are evaluated. If the resource unit is at the edge of the channel, possibly no or not enough adjacent subcarriers are available in the channel. Assuming the resource unit contains  $n$  carriers, the adjacent  $n$  subcarriers are assigned a certain limit, the next  $n$  subcarriers have another limit, and the third  $n$  subcarriers have yet another limit. All subcarriers beyond that have a fixed limit of -35 dB in relation to the EVM tolerance limit for the original resource unit ("*[IEEE P802.11ax/D1.2] Equation (28-123)*").

Since the  $n$  subcarriers can be allocated to several different resource units, we refer to such a subset as an *RU group*. The RU group containing the resource unit to be checked is referred to as  $RU_{idx}$ . The other subsets evaluated on either side of the  $RU_{idx}$  are referred to as RU groups  $RU_{idx-1}$ ,  $RU_{idx-2}$ ,  $RU_{idx-3}$ , and  $RU_{idx+1}$ ,  $RU_{idx+2}$ ,  $RU_{idx+3}$ . The remaining subcarriers are referred to as the RU groups *-35 dB LHS* (left-hand side) and *-35 dB RHS* (right-hand side).

The size of the evaluated RU groups corresponds to the size of the  $RU_{idx}$ , even if the actual resource unit allocation in the channel differs. However, the R&S FSW WLAN application measures one unused tone value for each set of 26 subcarriers. For each RU group, the mean, maximum, and minimum of these values is determined. In the [Unused Tone Error Summary](#), the "RU Size [RU26]" is indicated as the quotient of the RU size divided by the RU26 size (see "*[IEEE P802.11ax/D1.2] Equation (28-123)*"). Thus, the "RU Size [RU26]" also indicates the number of measurement points determined for each RU group.

[Figure 3-7](#) illustrates the RU groups for which the unused tone error is determined for different RU indexes. The blue dots indicate individual power measurement points in the channel.

WLAN I/Q measurement (modulation accuracy, flatness and tolerance)

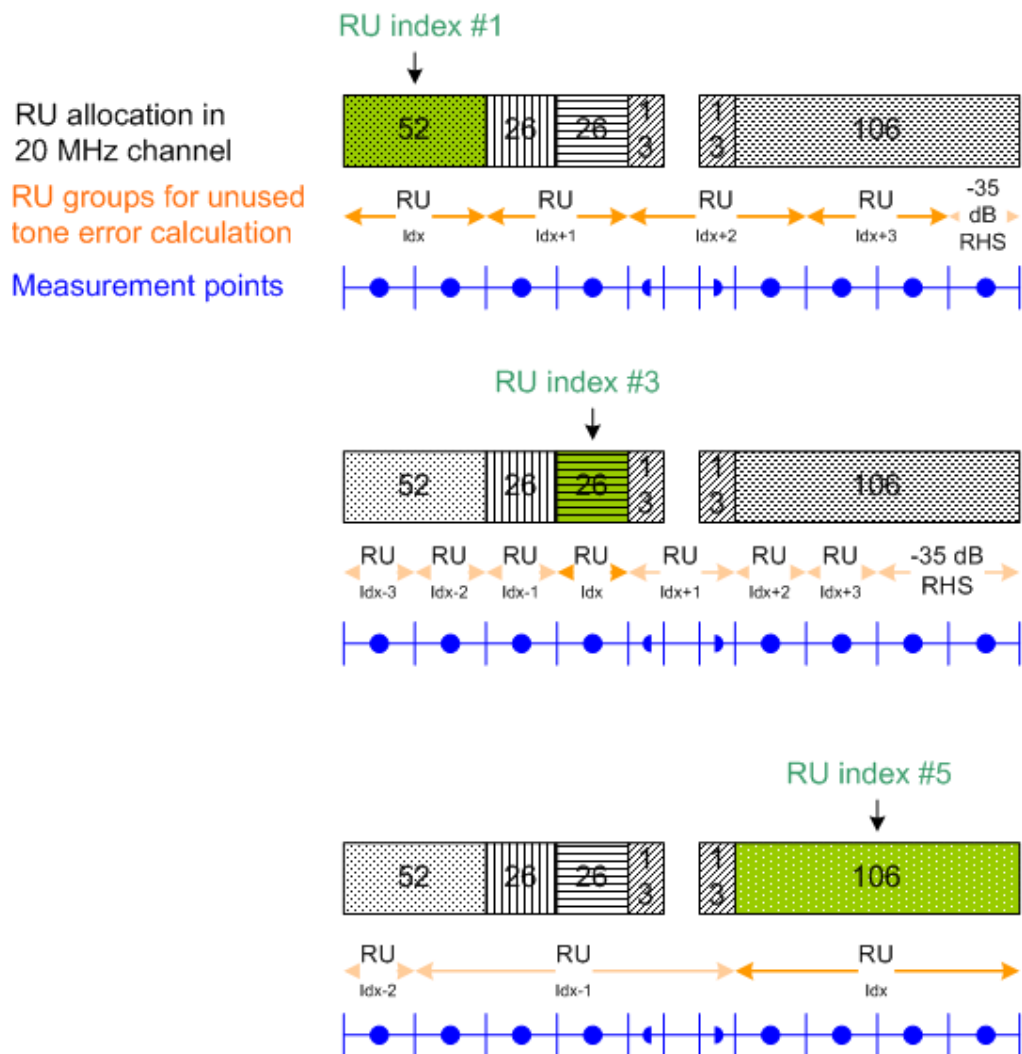

Figure 3-7: RU groups to be checked for unused tone error for different RU indexes

### 3.1.1.9 BER and CWER

The bit error rate (BER) and code word error rate (CWER) are displayed in the "Signal Content Detailed" result display. One value is determined for each resource unit (RU) data part.

If error correction corrects code words successfully, the BER is the ratio of the successfully corrected bits divided by the total number of bits.

The total number of bits contains:

- The code words that were corrected successfully.
- The code words without bit errors.
- No code words that could not be corrected.

The CWER is the ratio of the code words that could not be corrected divided by the total number of code words per resource unit (RU).

## WLAN I/Q measurement (modulation accuracy, flatness and tolerance)

If no bit errors or code word errors are detected, the result is 0 %. If both results are 0 %, the results are highlighted green. Otherwise, the result is highlighted red.

The BER and CWER results are only available under the following conditions:

- IEEE 802.11 ax, be signals
- SISO (1 antenna)
- One user per resource unit
- Non-trigger-based PPDU
- Low Density Parity Check (LDPC) encoding; BER also for Binary Convolutional Coding (BCC)

### 3.1.2 Evaluation methods for WLAN IQ measurements

The captured I/Q data from the WLAN signal can be evaluated using various different methods without having to start a new measurement or sweep. Which results are displayed depends on the selected evaluation.



#### Result display windows

All evaluations available for the selected WLAN measurement are displayed in Smart-Grid mode.

To activate SmartGrid mode, do one of the following:

- 
  - Select "SmartGrid" from the toolbar.
- Select "Display Config" in the configuration "Overview" (see [Chapter 5.2, "Display configuration"](#), on page 107).
- Press [MEAS CONFIG] and then select "Display Config".

To close the SmartGrid mode and restore the previous softkey menu select  "Close" in the right-hand corner of the toolbar, or press any key.

The selected evaluation method not only affects the result display in a window, but also the results of the trace data query in remote control (see [TRACe \[ : DATA \] ?](#) on page 408).

The WLAN measurements provide the following evaluation methods:

<a href="#">AM/AM</a> .....	28
<a href="#">AM/PM</a> .....	29
<a href="#">AM/EVM</a> .....	29
<a href="#">Amplitude Tracking</a> .....	30
<a href="#">Bitstream</a> .....	30
<a href="#">Constellation</a> .....	32
<a href="#">Constellation vs Carrier</a> .....	34
<a href="#">EVM vs Carrier</a> .....	35
<a href="#">EVM vs Chip</a> .....	36
<a href="#">EVM vs Symbol</a> .....	36

## WLAN I/Q measurement (modulation accuracy, flatness and tolerance)

FFT Spectrum.....	37
Freq. Error vs Preamble.....	38
Gain Imbalance vs Carrier.....	39
Group Delay.....	40
Magnitude Capture.....	41
Phase Error vs Preamble.....	42
Phase Tracking.....	43
PLCP Header (IEEE 802.11b, g (DSSS)).....	43
PvT Full PPDU.....	44
PvT Rising Edge.....	45
PvT Falling Edge.....	46
Quad Error vs Carrier.....	47
Result Summary Detailed.....	47
Result Summary Global.....	49
Signal Content Detailed (IEEE 802.11ax, be).....	51
Signal Field.....	52
Spectrum Flatness.....	54
Spectrum Flatness Result Summary.....	56
Unused Tone Error.....	56
Unused Tone Error Summary.....	57

**AM/AM**

This result display shows the measured and the reference signal in the time domain. For each sample, the x-axis value represents the amplitude of the reference signal and the y-axis value represents the amplitude of the measured signal.

The reference signal is derived from the measured signal after frequency and time synchronization, channel equalization and demodulation of the signal. The equivalent time domain representation of the reference signal is calculated by reapplying all the impairments that were removed before demodulation.

The trace is determined by calculating a *polynomial regression model* of a specified degree (see "[Polynomial degree for curve fitting](#)" on page 192) for the scattered measurement vs. reference signal data. The resulting regression polynomial is indicated in the window title of the result display.

Note: The measured signal and reference signal are complex signals.

This result display is **not** available for single-carrier measurements (**IEEE 802.11b, g (DSSS)**).

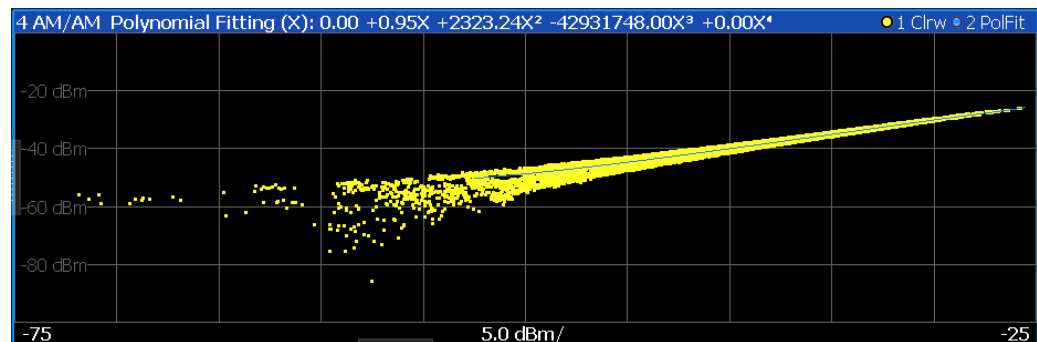

## WLAN I/Q measurement (modulation accuracy, flatness and tolerance)

Remote command:

LAY:ADD? '1', RIGH, AMAM, see LAYout:ADD[:WINDow]? on page 350

Or:

CONFigure:BURSt:AM:AM[:IMMediate] on page 230

Polynomial degree:

CONFigure:BURSt:AM:AM:POLYnomial on page 361

Results:

TRACe[:DATA]?, see Chapter 10.9.4.1, "AM/AM", on page 414

### AM/PM

This result display shows the measured and the reference signal in the time domain. For each sample, the x-axis value represents the amplitude of the reference signal. The y-axis value represents the angle difference of the measured signal minus the reference signal.

This result display is **not** available for single-carrier measurements (IEEE 802.11b, g (DSSS)).

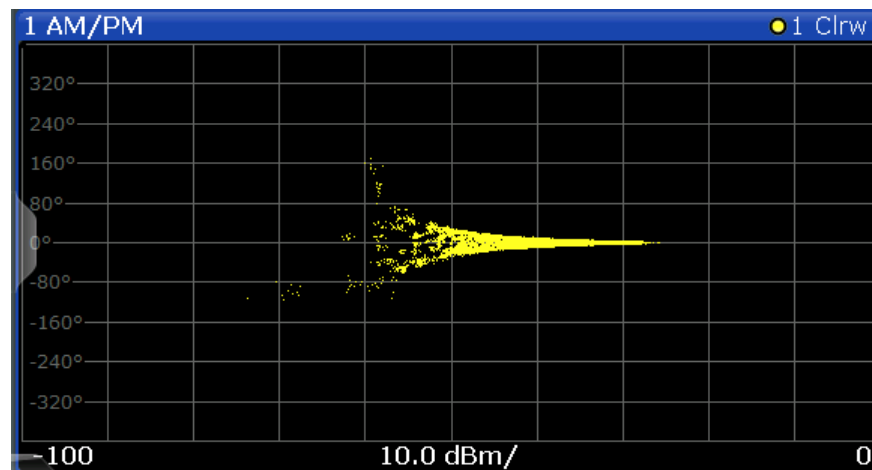

Remote command:

LAY:ADD? '1', RIGH, AMPM, see LAYout:ADD[:WINDow]? on page 350

Or:

CONFigure:BURSt:AM:PM[:IMMediate] on page 230

Querying results:

TRACe[:DATA]?, see Chapter 10.9.4.2, "AM/PM", on page 414

### AM/EVM

This result display shows the measured and the reference signal in the time domain. For each sample, the x-axis value represents the amplitude of the reference signal. The y-axis value represents the length of the error vector between the measured signal and the reference signal.

The length of the error vector is normalized with the power of the corresponding reference signal sample.

This result display is **not** available for single-carrier measurements (IEEE 802.11b, g (DSSS)).

## WLAN I/Q measurement (modulation accuracy, flatness and tolerance)

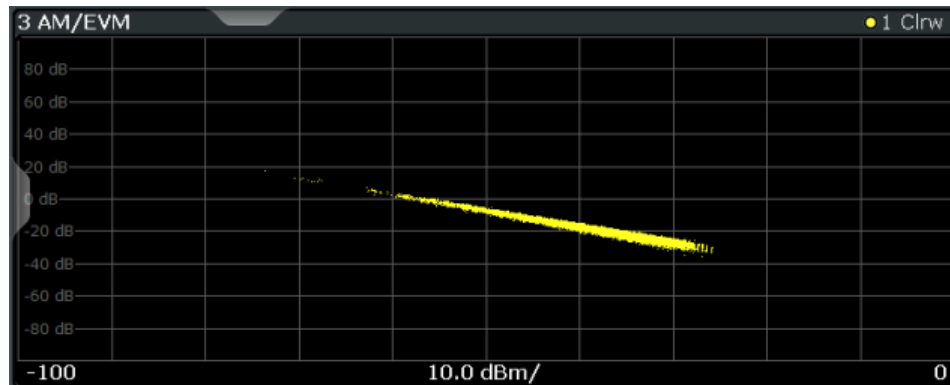

Remote command:

LAY:ADD? '1', RIGH, AMEV, see LAYout:ADD[:WINDow]? on page 350

Or:

CONFigure:BURSt:AM:EVM[:IMMediate] on page 230

Querying results:

TRACe[:DATA]?, see Chapter 10.9.4.3, "AM/EVM", on page 414

### Amplitude Tracking

Displays the average amplitude tracking result per symbol (in dB).

For each OFDM-symbol N, the amplitude error (rel. to preamble) is averaged over the pilot subcarriers of the OFDM-symbol N.

For IEEE 802.11ac, ax, n, be only

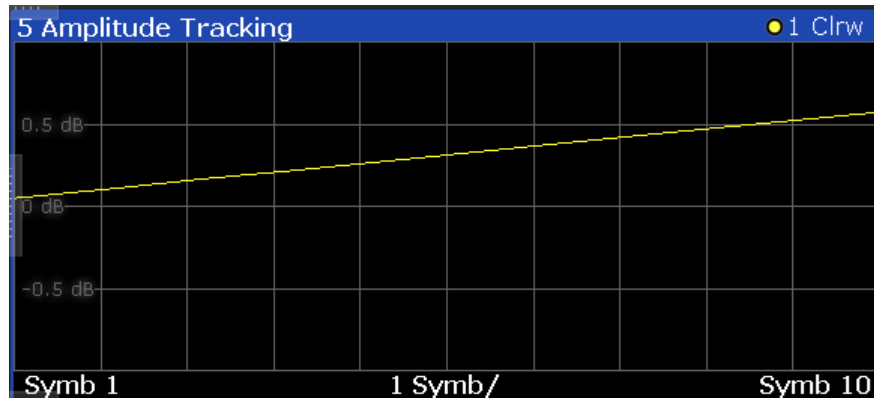

Remote command:

LAY:ADD? '1', RIGH, ATRacking, see LAYout:ADD[:WINDow]? on page 350

### Bitstream

This result display shows a demodulated payload data stream for all analyzed PPDU's of the currently captured I/Q data as indicated in the "Magnitude Capture" display. The bitstream is derived from the constellation diagram points using the 'constellation bit encoding' from the corresponding WLAN standard. See, for example, *IEEE Std. 802.11-2012 'Fig. 18-10 BPSK, QPSK, 16-QAM and 64-QAM constellation bit encoding'*. Thus, the bitstream is *NOT* channel-decoded.

For multicarrier measurements (**IEEE 802.11a, ac, g (OFDM), j, n, p**), the results are grouped by symbol and carrier.

WLAN I/Q measurement (modulation accuracy, flatness and tolerance)

1 Bitstream			
Carrier	Symbol 1		
-26	000010	110111	111110
-23	000001	010100	0
-20	011001	101010	010101
-17	001010	011100	101010
-14	111100	001010	001101
-11	011011	111110	010010
-8	111100	0	001100
-5	001101	111100	101100
-2	101010	100011	NULL
1	101010	101101	101010
4	011010	000101	010001
7	0	101101	001011
10	000110	100100	100101
13	101001	111101	101011
16	011100	111001	010010
19	110100	111001	0
22	000011	101111	101111
25	001111	111100	
Carrier	Symbol 2		

Figure 3-8: Bitstream result display for IEEE 802.11a, ac, g (OFDM), j, n, p standards

For MIMO measurements (IEEE 802.11ac, ax, n, be), the results are grouped by stream, symbol and carrier.

3 Bitstream			
Stream 1..4			
Stream 1		Stream 2	
Carrier	Symbol 1		
-122	01001010	10010110	01110110
-119	11111101	10010010	01110101
-116	10010011	00110000	10000110
-113	11000101	00010010	01111110
-110	10010101	00100101	10100100
-107	10001011	00011011	01001010
-104	10100100	0	10111101
-101	00111000	10101111	10110011
Carrier	Symbol 1		
-122	11001110	11100000	01110011
-119	10100111	01100010	11100001
-116	01000011	01110001	00101110
-113	10110010	10000100	10011010
-110	11100110	11111110	11101101
-107	10001111	01110101	01111010
-104	00001001	0	11011100
-101	11100010	00110011	10101111
Carrier	Symbol 1		
-122	01001101	00111101	10111011
-119	11100110	00000111	00001011
-116	01110110	00001011	01011101
-113	00110011	00010010	01101101
-110	01000000	00011101	00000010
-107	11100010	01000010	01000111
-104	00111110	0	11001001
-101	01001111	11001101	01001101

Figure 3-9: Bitstream result display for IEEE 802.11n MIMO measurements

## WLAN I/Q measurement (modulation accuracy, flatness and tolerance)

For single-carrier measurements (**IEEE 802.11b, g (DSSS)**) the results are grouped by PPDU.

4 Bitstream			
PPDU 1			
PLCP Preamble			
0	11111111	11111111	11111111
24	11111111	11111111	11111111
48	11111111	11111111	11111111
72	11111111	11111111	11111111
96	11111111	11111111	11111111
120	11111111	00000101	11001111
PLCP Header			
0	01010000	00100000	00000000
24	00000100	11001000	01000110
PSDU			
0	10000000	01000010	00110000
24	10011100	10101011	00001101
48	11101001	10111001	00010100

Figure 3-10: Bitstream result display for IEEE 802.11b, g (DSSS) standards

The numeric trace results for this evaluation method are described in [Chapter 10.9.4.4, "Bitstream"](#), on page 414.

Remote command:

LAY:ADD? '1',RIGH, BITS, see [LAYout:ADD\[:WINDow\]?](#) on page 350

Or:

[CONFigure:BURSt:STATistics:BSTReam\[:IMMediate\]](#) on page 234

Querying results:

[TRACe\[:DATA\]?](#), see [Chapter 10.9.4.4, "Bitstream"](#), on page 414

### Constellation

This result display shows the in-phase and quadrature phase results for all payload symbols and all carriers for the analyzed PPDUs of the current capture buffer. The Tracking/Channel Estimation according to the user settings is applied.

The inphase results (I) are displayed on the x-axis, the quadrature phase (Q) results on the y-axis.



## WLAN I/Q measurement (modulation accuracy, flatness and tolerance)

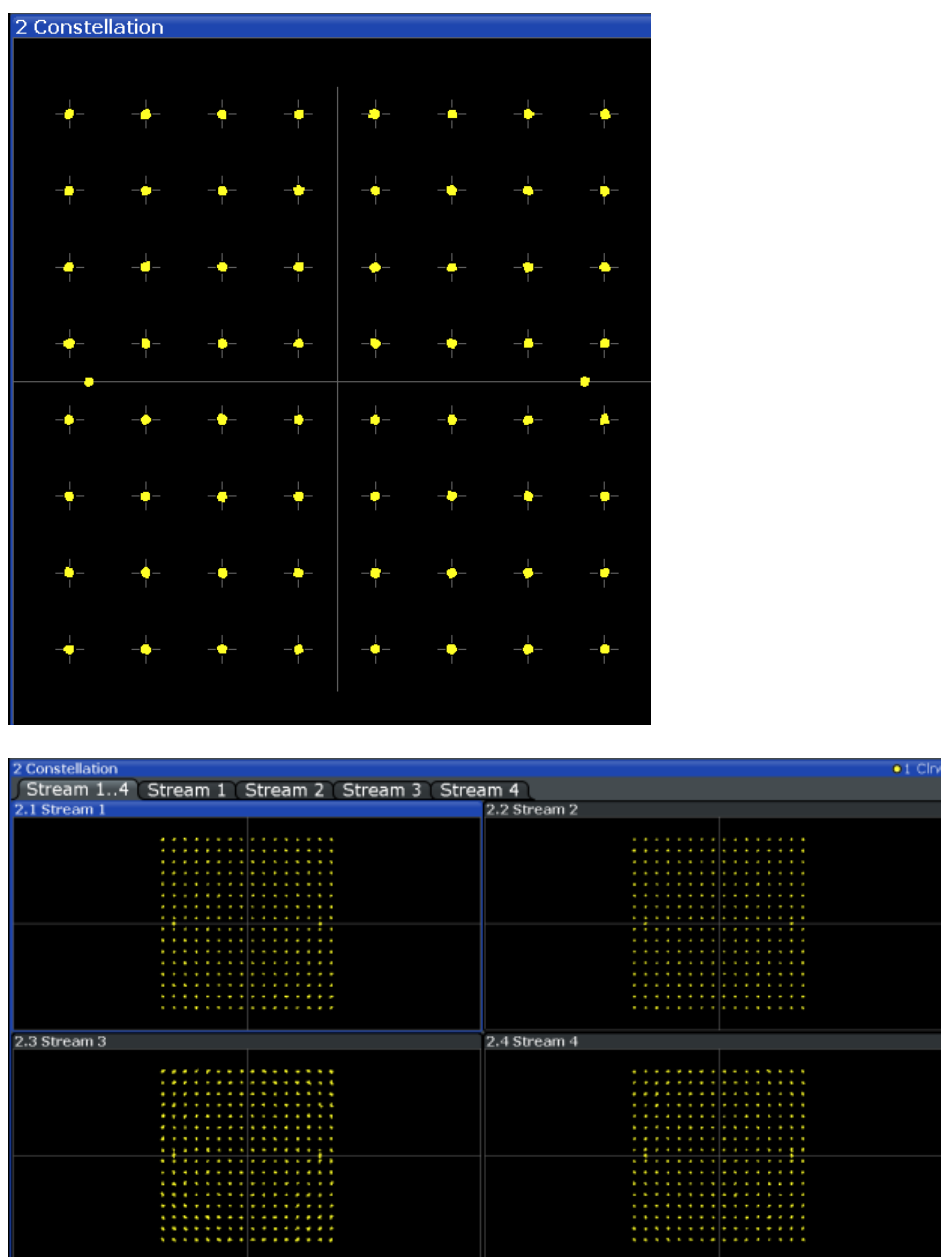

Figure 3-11: Constellation result display for IEEE 802.11n MIMO measurements

The numeric trace results for this evaluation method are described in [Chapter 10.9.4.6, "Constellation"](#), on page 416.

Remote command:

LAY:ADD? '1',RIGH, CONS, see [LAYout:ADD\[:WINDow\]?](#) on page 350

Or:

[CONFigure:BURSt:CONSt:CSYmbol\[:IMMediate\]](#) on page 230

Querying results:

[TRACe\[:DATA\]?](#), see [Chapter 10.9.4.6, "Constellation"](#), on page 416

## WLAN I/Q measurement (modulation accuracy, flatness and tolerance)

**Constellation vs Carrier**

This result display shows the in-phase and quadrature phase results for all payload symbols and all carriers for the analyzed PPDUs of the current capture buffer. The Tracking/Channel Estimation according to the user settings is applied.

This result display is **not** available for single-carrier measurements (IEEE 802.11b, g (DSSS)).

The x-axis represents the carriers. The magnitude of the in-phase and quadrature part is shown on the y-axis, both are displayed as separate traces (I-> trace 1, Q-> trace 2).

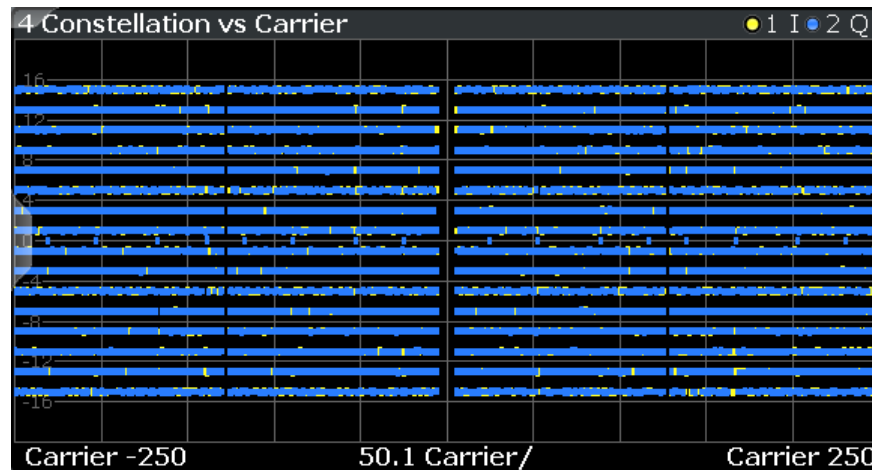

Figure 3-12: Constellation vs. carrier result display for IEEE 802.11n MIMO measurements

The numeric trace results for this evaluation method are described in [Chapter 10.9.4.7, "Constellation vs carrier"](#), on page 417.

Remote command:

LAY:ADD? '1',RIGH, CVC, see [LAYout:ADD\[:WINDOW\]?](#) on page 350

Or:

[CONFigure:BURSt:CONSt:CCARrier\[:IMMediate\]](#) on page 230

Querying results:

[TRACe\[:DATA\]?](#), see [Chapter 10.9.4.7, "Constellation vs carrier"](#), on page 417

## WLAN I/Q measurement (modulation accuracy, flatness and tolerance)

**EVM vs Carrier**

This result display shows all EVM values recorded on a per-subcarrier basis over the number of analyzed PPDU's as defined by the "Evaluation Range > Statistics". The Tracking/Channel Estimation according to the user settings is applied (see [Chapter 5.3.7, "Tracking and channel estimation"](#), on page 146). The minimum, average and maximum traces are displayed.

For **IEEE 802.11be** measurements, the results are displayed for the RUs selected in the PPDU configuration, see ["Result displays for multi-user PPDU's"](#) on page 170.

This result display is **not** available for single-carrier measurements (**IEEE 802.11b, g (DSSS)**).

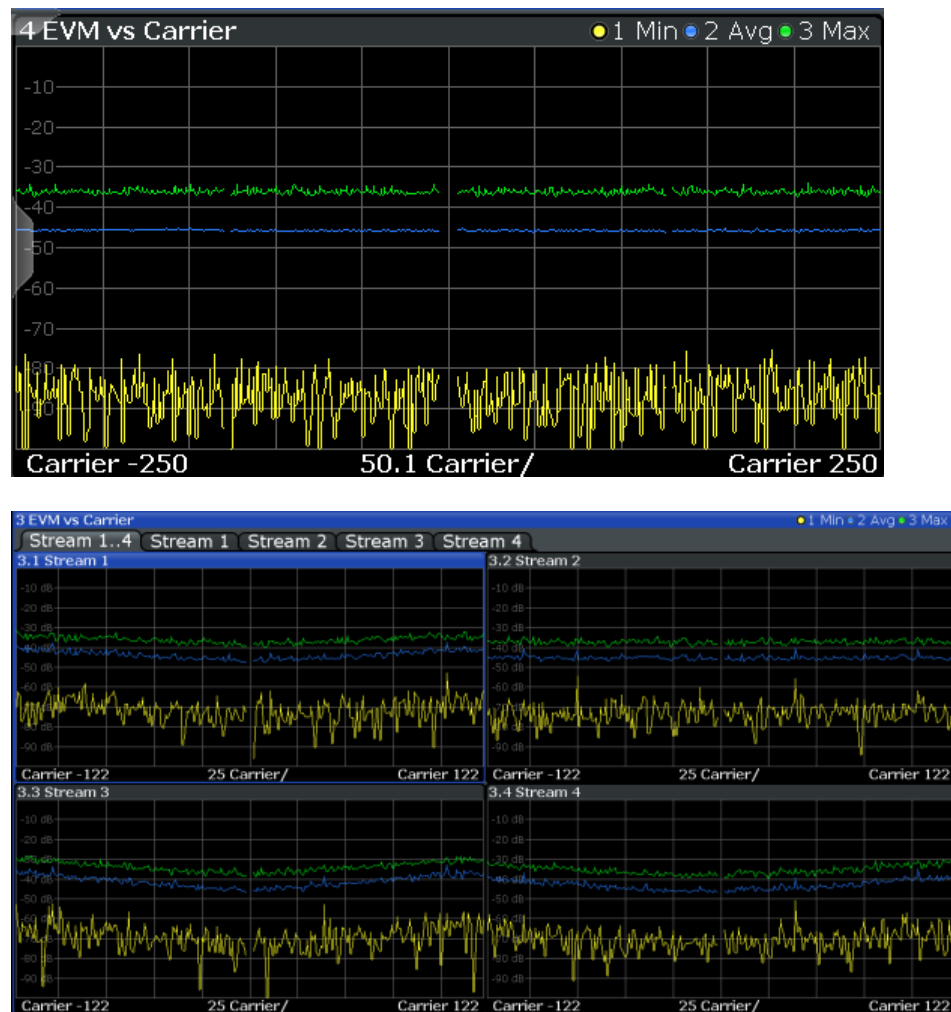

Figure 3-13: EVM vs carrier result display for IEEE 802.11n MIMO measurements

The numeric trace results for this evaluation method are described in [Chapter 10.9.4.10, "EVM vs carrier"](#), on page 417.

Remote command:

LAY:ADD? '1',RIGH, EVC, see [LAYout:ADD\[:WINDow\]?](#) on page 350

Or:

CONFigure:BURSt:EVM:ECARrier[:IMMediate] on page 230

## WLAN I/Q measurement (modulation accuracy, flatness and tolerance)

Querying results:

TRACe[:DATA]?, see [Chapter 10.9.4.10, "EVM vs carrier"](#), on page 417

### EVM vs Chip

This result display shows the error vector magnitude per chip.

This result display is **only** available for single-carrier measurements (**IEEE 802.11b, g (DSSS)**).

Since the R&S FSW WLAN application provides two different methods to calculate the EVM, two traces are displayed:

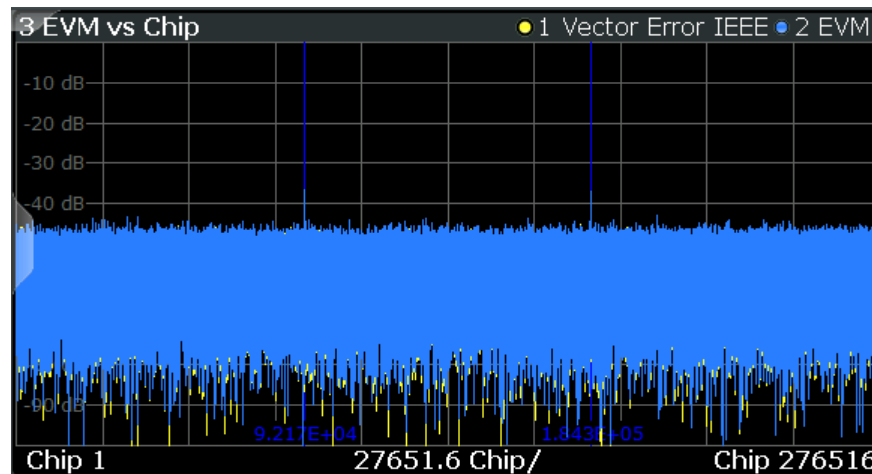

- "Vector Error IEEE" shows the error vector magnitude as defined in the IEEE 802.11b or g (DSSS) standards (see also ["Error vector magnitude \(EVM\) - IEEE 802.11b or g \(DSSS\) method"](#) on page 76)
- "EVM" shows the error vector magnitude calculated with an alternative method that provides higher accuracy of the estimations (see also ["Error vector magnitude \(EVM\) - FSW method"](#) on page 76).

Remote command:

LAY:ADD? '1',RIGH, EVCH, see [LAYout:ADD\[:WINDow\]?](#) on page 350

Or:

[CONFigure:BURSt:EVM:EVChip\[:IMMediate\]](#) on page 231

[CONFigure:BURSt:EVM:ESYMBOL\[:IMMediate\]](#) on page 231

Querying results:

TRACe[:DATA]?, see [Chapter 10.9.4.11, "EVM vs chip"](#), on page 418

### EVM vs Symbol

This result display shows all EVM values calculated on a per-carrier basis over the number of analyzed PPDU as defined by the "Evaluation Range > Statistics" settings (see ["PPDU Statistic Count / No of PPDU to Analyze"](#) on page 185). The "Tracking/ Channel Estimation" according to the user settings is applied (see [Chapter 5.3.7, "Tracking and channel estimation"](#), on page 146). The minimum, average and maximum traces are displayed.

## WLAN I/Q measurement (modulation accuracy, flatness and tolerance)

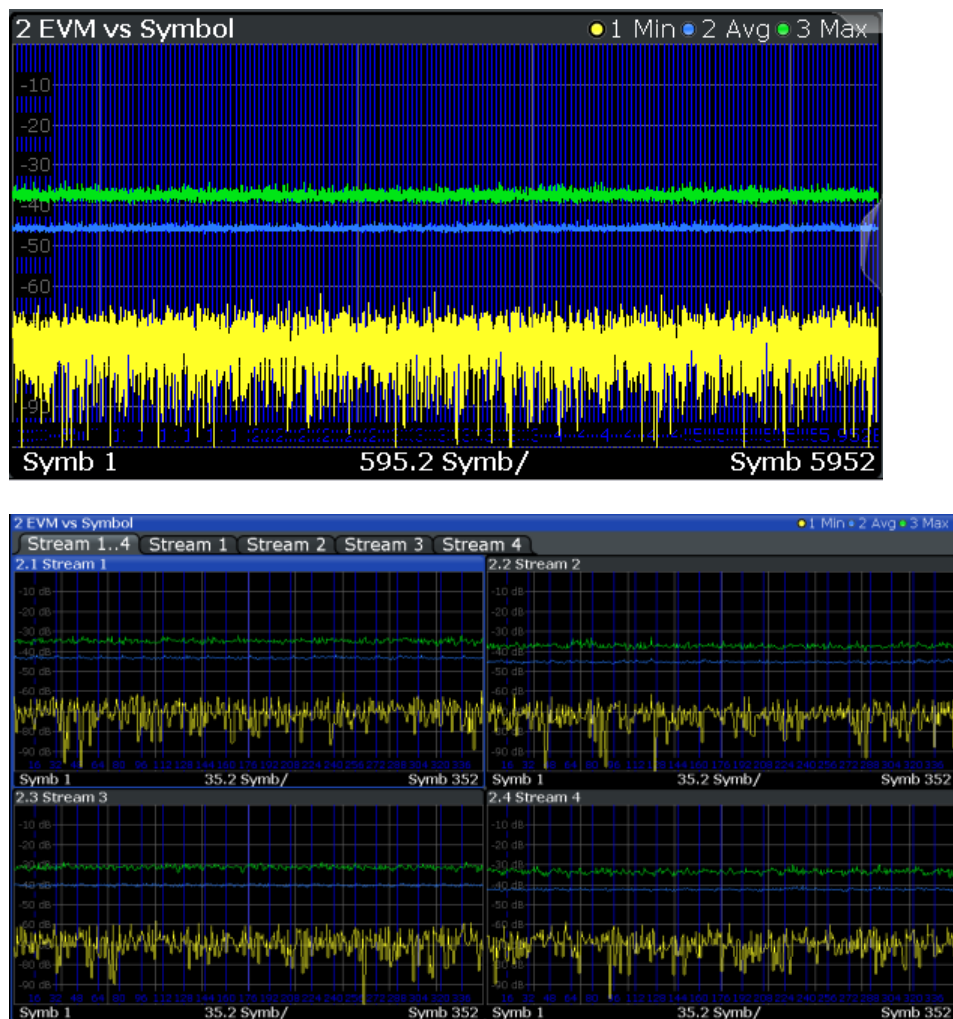

Figure 3-14: EVM vs symbol result display for IEEE 802.11n MIMO measurements

This result display is **not** available for single-carrier measurements (IEEE 802.11b, g (DSSS)).

Remote command:

LAY:ADD? '1',RIGHT, EVSY, see LAYout:ADD[:WINDow]? on page 350

Or:

CONFigure:BURSt:EVM:ESYMBOL[:IMMediate] on page 231

Querying results:

TRACe[:DATA]?, see Chapter 10.9.4.12, "EVM vs symbol", on page 418

### FFT Spectrum

This result display shows the power vs frequency values obtained from an FFT. The FFT is performed over the complete data in the current capture buffer, without any correction or compensation.

## WLAN I/Q measurement (modulation accuracy, flatness and tolerance)

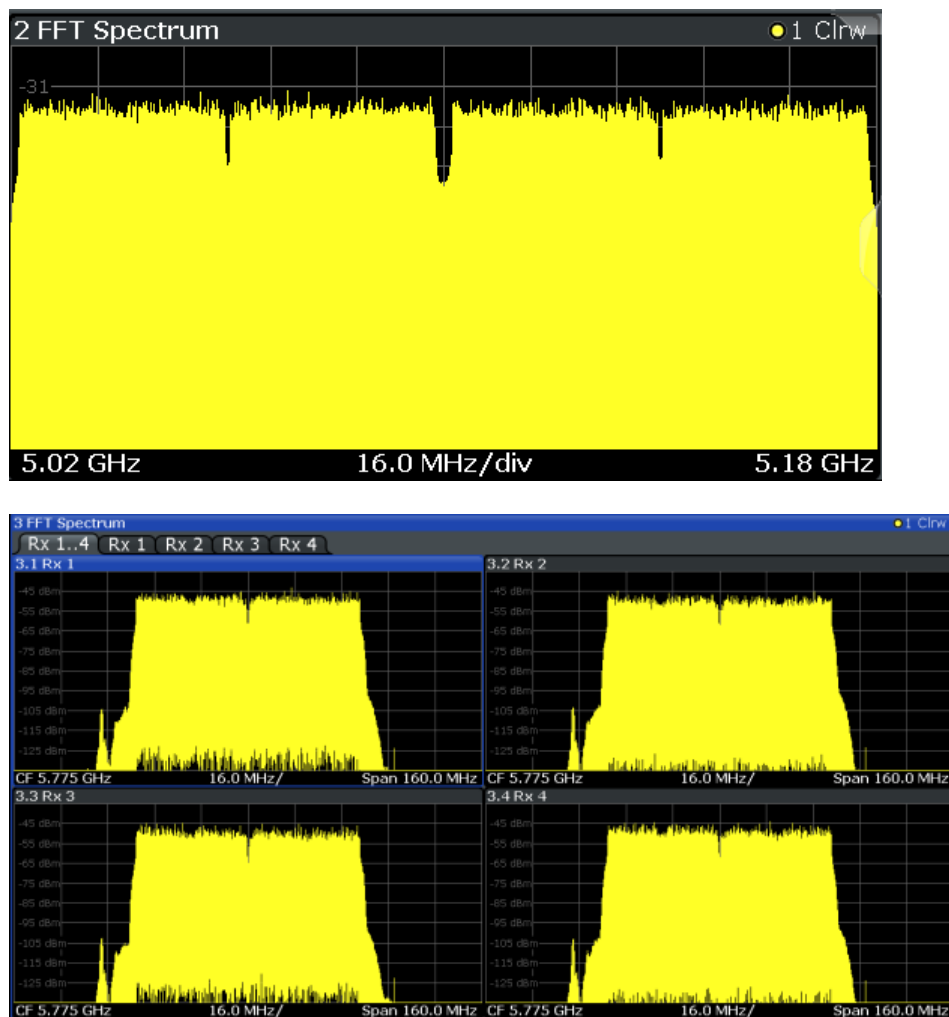

Figure 3-15: FFT spectrum result display for IEEE 802.11n MIMO measurements

The numeric trace results for this evaluation method are described in [Chapter 10.9.4.13, "FFT spectrum"](#), on page 419.

Remote command:

LAY:ADD? '1',RIGH, FSP, see [LAYout:ADD\[:WINDow\]?](#) on page 350

Or:

[CONFigure:BURSt:SPECTrum:FFT\[:IMMediate\]](#) on page 233

Querying results:

[TRACe\[:DATA\]?](#), see [Chapter 10.9.4.13, "FFT spectrum"](#), on page 419

### Freq. Error vs Preamble

Displays the frequency error values recorded over the preamble part of the PPDU. The minimum, average and maximum traces are displayed.

## WLAN I/Q measurement (modulation accuracy, flatness and tolerance)

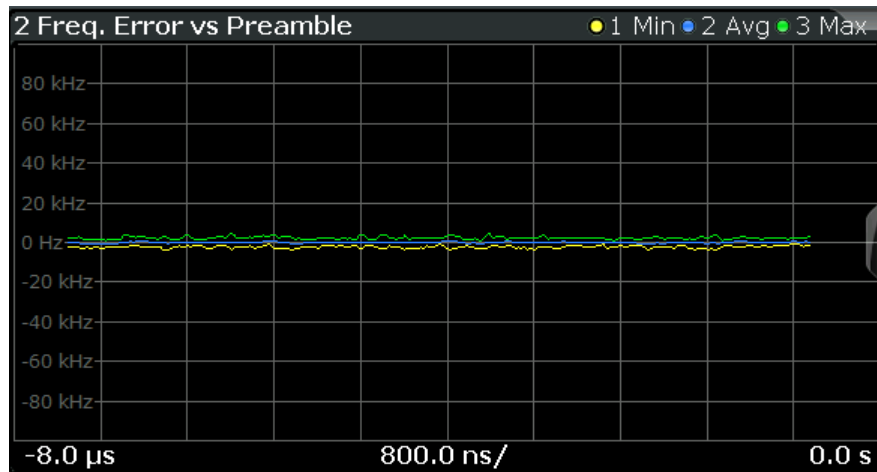

Remote command:

LAY:ADD? '1', RIGH, FEVP, see [LAYout:ADD\[:WINDow\]?](#) on page 350

Or:

[CONFigure:BURSt:PREamble\[:IMMediate\]](#) on page 231

[CONFigure:BURSt:PREamble:SElect](#) on page 232

Querying results:

[TRACe\[:DATA\]?](#), see [Chapter 10.9.4.9, "Error vs preamble"](#), on page 417

### Gain Imbalance vs Carrier

Displays the minimum, average and maximum gain imbalance versus carrier in individual traces. For details on gain imbalance, see [Chapter 3.1.1.2, "Gain imbalance"](#), on page 20.

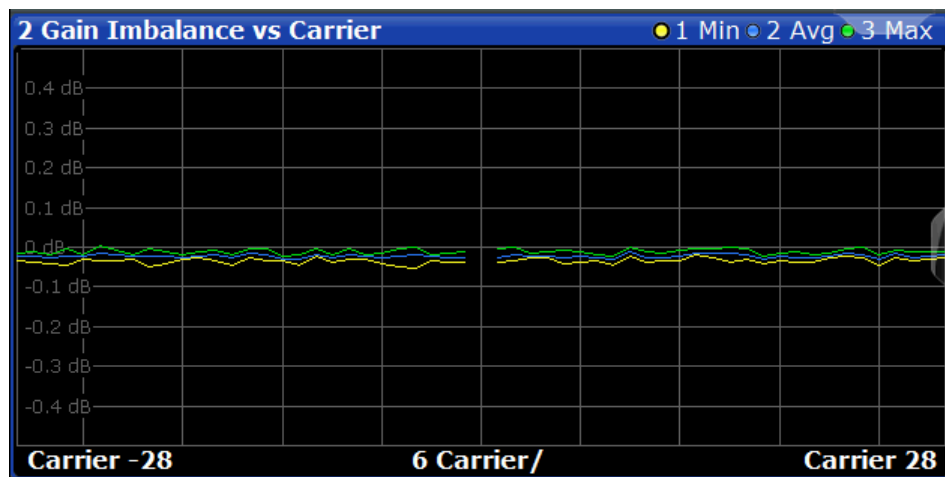

Remote command:

LAY:ADD? '1', RIGH, GAIN, see [LAYout:ADD\[:WINDow\]?](#) on page 350

Or:

[CONFigure:BURSt:GAIN:GCARrier\[:IMMediate\]](#) on page 231

Querying results:

[TRACe\[:DATA\]?](#), see [Chapter 10.9.4.8, "Error vs carrier"](#), on page 417

## WLAN I/Q measurement (modulation accuracy, flatness and tolerance)

**Group Delay**

Displays all "Group Delay" (GD) values recorded on a per-subcarrier basis - over the number of analyzed PPDU's as defined by the "Evaluation Range > Statistics" settings (see "PPDU Statistic Count / No of PPDU's to Analyze" on page 185).

All 57 carriers are shown, including the unused carrier 0.

This result display is **not** available for single-carrier measurements (IEEE 802.11b, g (DSSS)).

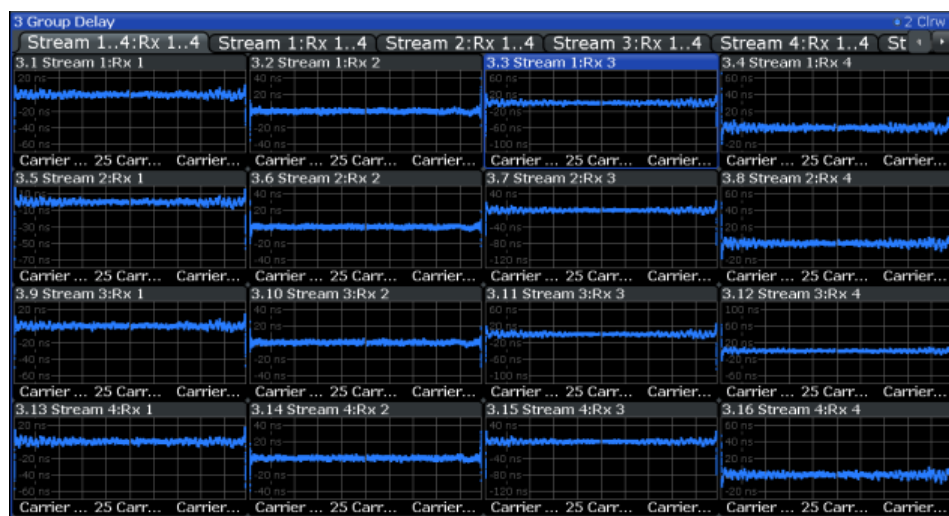
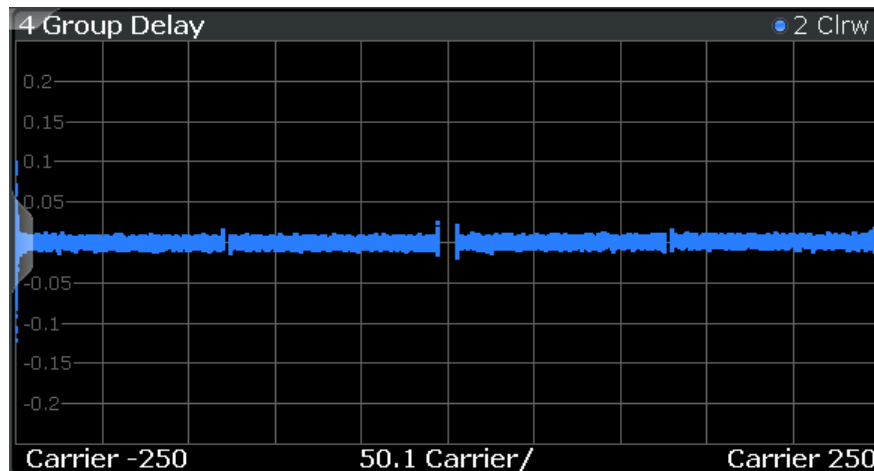

Figure 3-16: Group delay result display for IEEE 802.11n MIMO measurements

Group delay is a measure of phase distortion and defined as the derivation of phase over frequency.

To calculate the group delay, the estimated channel is upsampled, inactive carriers are interpolated, and phases are unwrapped before they are differentiated over the carrier frequencies. Thus, the group delay indicates the time a pulse in the channel is delayed for each carrier frequency. However, not the absolute delay is of interest, but rather the deviation between carriers. Thus, the mean delay over all carriers is deducted.

For an ideal channel, the phase increases linearly, which causes a constant time delay over all carriers. In this case, a horizontal line at the zero value would be the result.



## WLAN I/Q measurement (modulation accuracy, flatness and tolerance)

The numeric trace results for this evaluation method are described in [Chapter 10.9.4.14, "Group delay"](#), on page 419.

Remote command:

LAY:ADD? '1',RIGH, GDEL, see [LAYout:ADD\[:WINDow\]?](#) on page 350

Or:

CONF:BURS:SPEC:FLAT:SEL GRD, see [CONFigure:BURSt:SPECTrum:FLATness:SElect](#) on page 233 and [CONFigure:BURSt:SPECTrum:FLATness\[:IMMediate\]](#) on page 233

Querying results:

TRACe[:DATA]?, see [Chapter 10.9.4.14, "Group delay"](#), on page 419

### Magnitude Capture

The "Magnitude Capture" display shows the complete range of captured data for the last sweep. Green bars at the bottom of the "Magnitude Capture" display indicate the positions of the analyzed PPDU.

A blue bar indicates the selected PPDU if the evaluation range is limited to a single PPDU (see ["Analyze this PPDU / PPDU to Analyze"](#) on page 184).

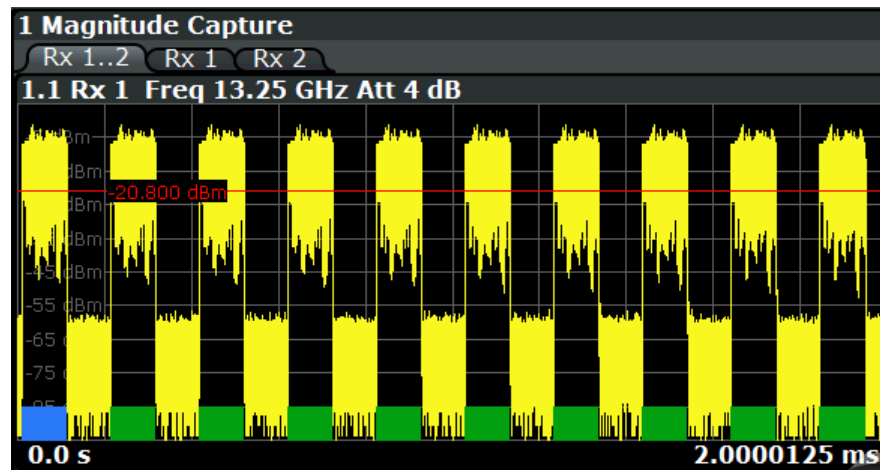

Figure 3-17: Magnitude capture display for single PPDU evaluation

**Note:** I/Q noise cancellation. If I/Q noise cancellation is enabled, the "Magnitude Capture" display shows the captured I/Q data for the last capture of the averaging process. The position of the analyzed PPDU (green bars) and the selected PPDU (blue bar) are not indicated.

## WLAN I/Q measurement (modulation accuracy, flatness and tolerance)

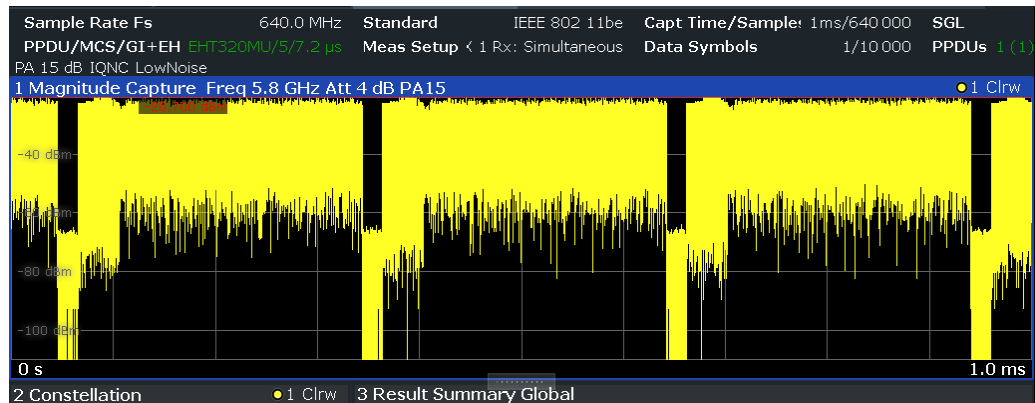

Figure 3-18: Magnitude capture display with enabled I/Q noise cancellation

See ["Reduce Noise on I/Q Data"](#) on page 136.

Numeric trace results are not available for this evaluation method.

Remote command:

LAY:ADD? '1', RIGH, CMEM, see [LAYout:ADD\[:WINDow\]?](#) on page 350

Querying results:

[TRACe\[:DATA\]?](#), see [Chapter 10.9.4.15, "Magnitude capture"](#), on page 420

I/Q data with internal noise removed (I/Q noise cancellation):

[MMEMory:STORe<n>:IQNC:STATe](#) on page 425

### Phase Error vs Preamble

Displays the phase error values recorded over the preamble part of the PPDU. A minimum, average and maximum trace is displayed.

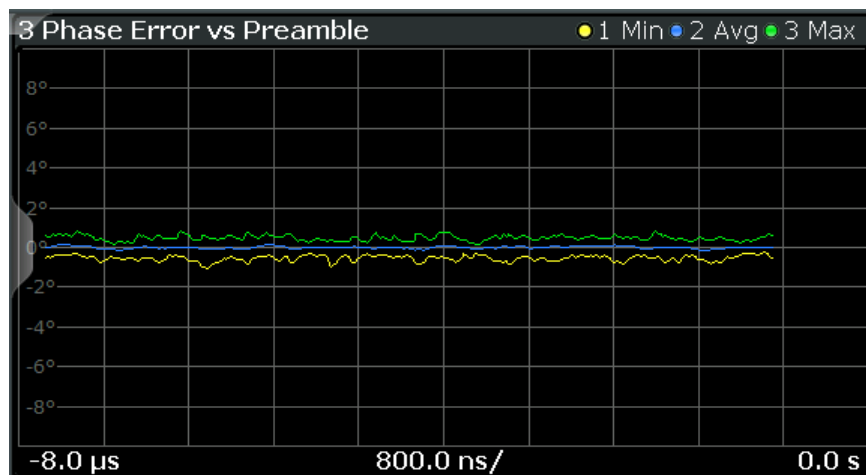

Remote command:

LAY:ADD? '1', RIGH, PEVP, see [LAYout:ADD\[:WINDow\]?](#) on page 350

Or:

[CONFigure:BURSt:PREAmble\[:IMMediate\]](#) on page 231

[CONFigure:BURSt:PREAmble:SElect](#) on page 232

Querying results:

[TRACe\[:DATA\]?](#), see [Chapter 10.9.4.9, "Error vs preamble"](#), on page 417

## WLAN I/Q measurement (modulation accuracy, flatness and tolerance)

**Phase Tracking**

Displays the average phase tracking result per symbol (in radians).

For each OFDM-symbol N, the pilot phase error (rel. to preamble) is averaged over the pilot subcarriers of the OFDM-symbol N.

This result display is **not** available for single-carrier measurements (**IEEE 802.11b, g (DSSS)**).

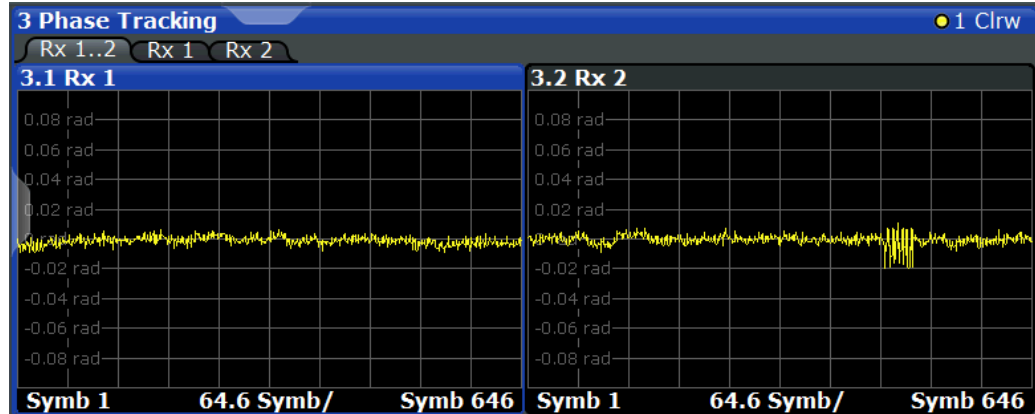

Figure 3-19: Phase tracking result display for IEEE 802.11n MIMO measurements

Remote command:

LAY:ADD? '1', RIGH, PTR, see LAYout:ADD[:WINDow]? on page 350

Or:

CONFigure:BURSt:PTRacking[:IMMediate] on page 232

Querying results:

TRACe[:DATA]?, see Chapter 10.9.4.16, "Phase tracking", on page 420

**PLCP Header (IEEE 802.11b, g (DSSS))**

This result display shows the decoded data from the PLCP header of the PPDU.

This result display is **only** available for single-carrier measurements (**IEEE 802.11b, g (DSSS)**); for other standards, use [Signal Field](#) instead.

1 PLCP Header	Signal	Service	PSDU Length	CRC
Burst 1	01101110 11 Mbits/s	00100000 Lok/CCK / --	0000001011101001 745 µs	1011010110001010 OK
Burst 2	01101110 11 Mbits/s	00100000 Lok/CCK / --	0000001011101001 745 µs	1011010110001010 OK
Burst 3	01101110 11 Mbits/s	00100000 Lok/CCK / --	0000001011101001 745 µs	1011010110001010 OK
Burst 4	01101110 11 Mbits/s	00100000 Lok/CCK / --	0000001011101001 745 µs	1011010110001010 OK
Burst 5	01101110 11 Mbits/s	00100000 Lok/CCK / --	0000001011101001 745 µs	1011010110001010 OK

Figure 3-20: PLCP Header result display for IEEE 802.11b, g (DSSS) standards

The following information is provided:

**Note:** The signal field information is provided as a decoded bit sequence and, where appropriate, also in human-readable form beneath the bit sequence for each PPDU.

## WLAN I/Q measurement (modulation accuracy, flatness and tolerance)

**Table 3-4: Demodulation results in PLCP Header result display (IEEE 802.11b, g (DSSS))**

Result	Description	Example
PPDU	Number of the decoded PPDU A colored block indicates that the PPDU was successfully decoded.	PPDU 1
Signal	Information in "signal" field The decoded data rate is shown below.	01101110 11 Mbits/s
Service	Information in "service" field <Symbol clock state> / <Modulation format> / <Length extension bit state> where: <Symbol clock state>: Locked / - - <Modulation format>: see <a href="#">Table 4-3</a> <Length extension bit state>: 1 (set) / - - (not set)	00100000 Lock/CCK/- -
PSDU Length	Information in "length" field Time required to transmit the PSDU	000000001111000 120 µs
CRC	Information in "CRC" field Result of cyclic redundancy code check: "OK" or "Failed"	1110100111001110 OK

Remote command:

LAY:ADD? '1',RIGH, SFI, see [LAYout:ADD\[:WINDow\]?](#) on page 350

Or:

[CONFigure:BURSt:STATistics:SFIeld\[:IMMediate\]](#) on page 234

Querying results:

[TRACe\[:DATA\]?](#), see [Chapter 10.9.4.18, "Signal field"](#), on page 421

### PvT Full PPDU

Displays the minimum, average and maximum power vs time diagram for all PPDU's.

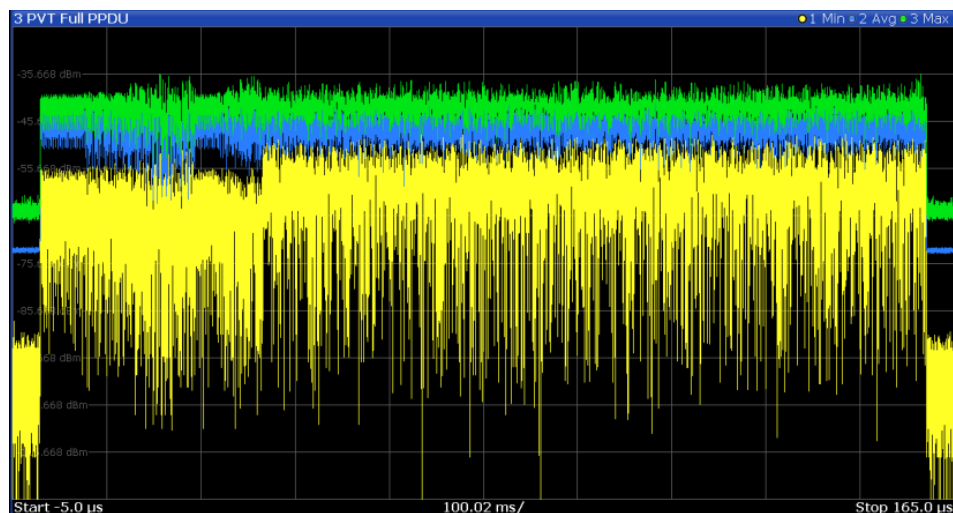

**Figure 3-21: PvT Full PPDU result display for IEEE 802.11a, ac, g (OFDM), j, n, p standards**

## WLAN I/Q measurement (modulation accuracy, flatness and tolerance)

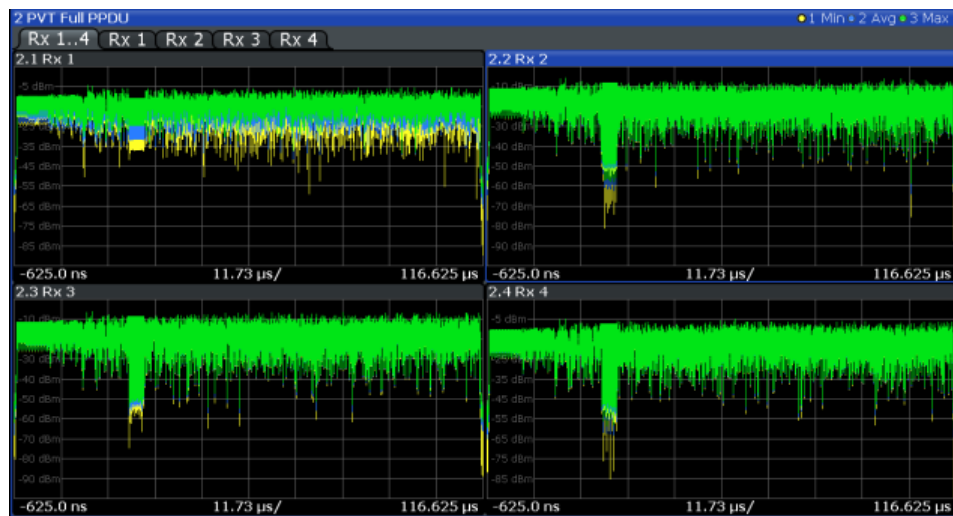

Figure 3-22: PVT Full PPDU result display for IEEE 802.11n MIMO measurements

For single-carrier measurements (IEEE 802.11b, g (DSSS)), the PVT results are displayed as percentage values of the reference power. The reference can be set to either the maximum or mean power of the PPDU.

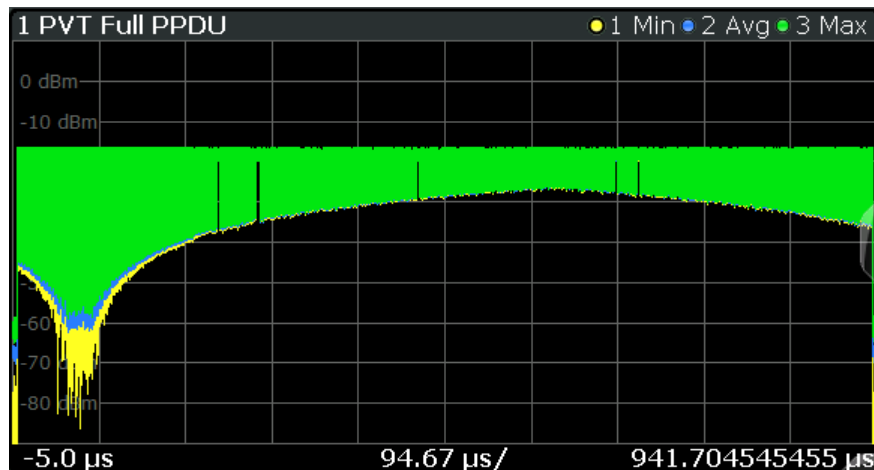

Figure 3-23: PVT Full PPDU result display for IEEE 802.11b, g (DSSS) standards

Remote command:

LAY:ADD:WIND '2', RIGH, PFPP see [LAYout:ADD\[:WINDow\]?](#) on page 350

Or:

[CONFigure:BURSt:PVT:SElect](#) on page 232

[CONFigure:BURSt:PVT\[:IMMediate\]](#) on page 232

Querying results:

[TRACe\[:DATA\]?](#), see [Chapter 10.9.4.17, "Power vs time \(PVT\)"](#), on page 420

### PVT Rising Edge

Displays the minimum, average and maximum power vs time diagram for the rising edge of all PPDUs.

## WLAN I/Q measurement (modulation accuracy, flatness and tolerance)

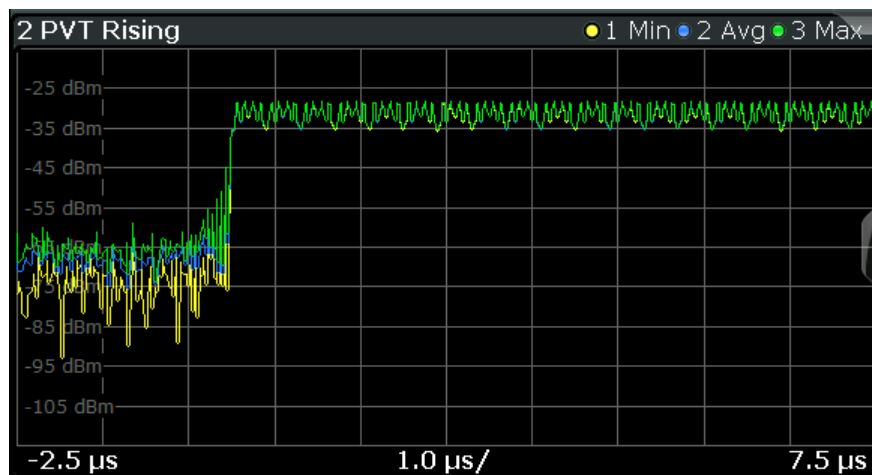

Figure 3-24: PVT Rising Edge result display

Remote command:

LAY:ADD:WIND '2',RIGH,PRIS see [LAYout:ADD\[:WINDow\]?](#) on page 350

Or:

CONF:BURSt:PVT:SElect on page 232

CONF:BURSt:PVT[:IMMediate] on page 232

Querying results:

TRACe[:DATA]?, see [Chapter 10.9.4.17, "Power vs time \(PVT\)"](#), on page 420

### PvT Falling Edge

Displays the minimum, average and maximum power vs time diagram for the falling edge of all PPDU's.

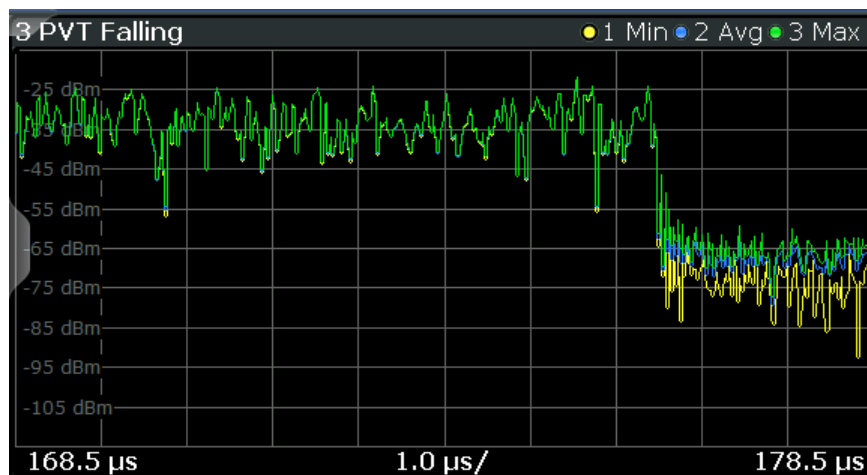

Figure 3-25: PVT Falling Edge result display

Remote command:

LAY:ADD:WIND '2',RIGH,PFAL see [LAYout:ADD\[:WINDow\]?](#) on page 350

Or:

CONF:BURSt:PVT:SElect on page 232

CONF:BURSt:PVT[:IMMediate] on page 232

## WLAN I/Q measurement (modulation accuracy, flatness and tolerance)

Querying results:

`TRACe[:DATA]?`, see [Chapter 10.9.4.17, "Power vs time \(PVT\)"](#), on page 420

### Quad Error vs Carrier

Displays the minimum, average and maximum quadrature offset (error) versus carrier in individual traces. For details on quadrature offset, see [Chapter 3.1.1.3, "Quadrature offset"](#), on page 21.

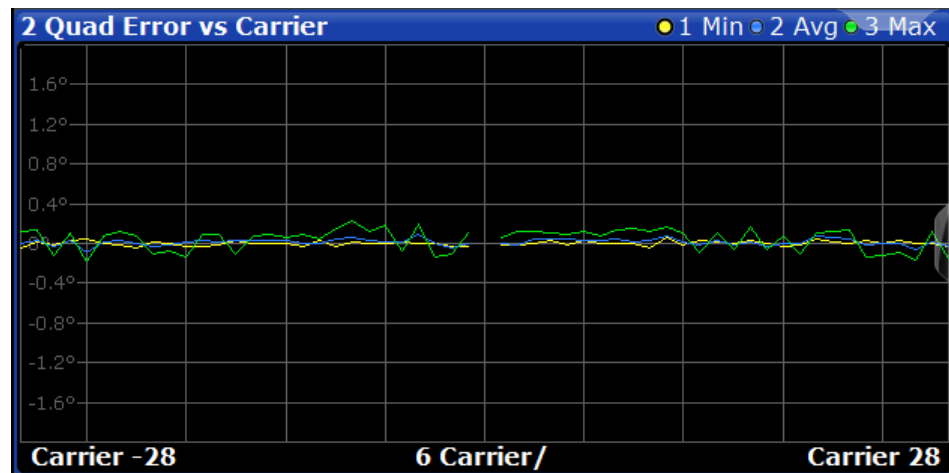

Remote command:

`LAY:ADD? '1',RIGH,QUAD`, see [LAYout:ADD\[:WINDow\]?](#) on page 350

Or:

`CONFigure:BURSt:QUAD:QCARrier[:IMMediate]` on page 233

Querying results:

`TRACe[:DATA]?`, see [Chapter 10.9.4.8, "Error vs carrier"](#), on page 417

### Result Summary Detailed

The *detailed* result summary contains individual measurement results for the Transmitter and Receiver channels and for the bitstream.

This result display is **not** available for single-carrier measurements (**IEEE 802.11b, g (DSSS)**).

## WLAN I/Q measurement (modulation accuracy, flatness and tolerance)

4 Result Summary Detailed						4.2 Tx 2:Rx 2					
4.1 Tx 1:Rx 1						4.2 Tx 2:Rx 2					
Tx 1						Tx 2					
	Min	Mean	Limit	Max	Lir		Min	Mean	Limit	Max	Lir
IQ Offset	-45.70	-45.47	-20.00	-45.37	-20.00	IQ Offset	-62.45	-62.07	-20.00	-61.67	-20.00
Gain Imbalance	-0.26	-0.25		-0.24		Gain Imbalance	-0.06	-0.04		-0.02	
	-0.02	-0.02		-0.02			-0.01	-0.00		-0.00	
Quad. Offset	0.03	0.04		0.05		Quad. Offset	-0.00	0.01		0.02	
IQ Skew	-1.03	-0.41		0.92		IQ Skew	0.88	2.48		3.56	
PPDU Power	---	---		---		PPDU Power	---	---		---	
Crest Factor	---	---		---		Crest Factor	---	---		---	
Rx 1						Rx 2					
	Min	Mean	Limit	Max	Lir		Min	Mean	Limit	Max	Lir
PPDU Power	-11.94	-11.94		-11.94		PPDU Power	-15.52	-15.51		-15.51	
Crest Factor	10.87	10.88		10.88		Crest Factor	10.55	10.57		10.58	
MIMO Cross Power	---	-6.60		---		MIMO Cross Power	---	-6.60		---	
Center Freq Error	---	---		---		Center Freq Error	---	---		---	
Symbol Clock Error	---	---		---		Symbol Clock Error	---	---		---	
CPE	---	---		---		CPE	---	---		---	
Stream 1						Stream 2					
	Min	Mean	Limit	Max	Lir		Min	Mean	Limit	Max	Lir
BER Pilot	---	---	0.00	---	0.00	BER Pilot	---	---	0.00	---	0.00
EVM All Carrier	-46.94	-46.62	-22.00	-46.31	-22.00	EVM All Carrier	-47.17	-46.65	-16.00	-46.16	-16.00
EVM Data Carrier	-46.89	-46.55	-22.00	-46.23	-22.00	EVM Data Carrier	-47.13	-46.61	-16.00	-46.14	-16.00
EVM Pilot Carrier	-49.34	-48.28	-5.00	-47.53	-5.00	EVM Pilot Carrier	-48.13	-47.54	-5.00	-46.43	-5.00

Figure 3-26: Detailed Result Summary result display for IEEE 802.11n MIMO measurements

The "Result Summary Detailed" contains the following information:

**Note:** You can configure which results are displayed (see [Chapter 5.3.10, "Result configuration"](#), on page 189). However, the results are always calculated, regardless of their visibility.

Tx channel ("Tx All"):

- I/Q offset [dB]
- Gain imbalance [%/dB]
- Quadrature offset [°]
- I/Q skew [ps]
- PPDU power [dBm]
- Crest factor [dB]

Receive channel ("Rx All"):

- PPDU power [dBm]
- Crest factor [dB]
- MIMO cross power
- MIMO channel power
- Center frequency error
- Symbol clock error
- CPE

"Bitstream" ("Stream All"):

- Pilot bit error rate [%]
- EVM all carriers [%/dB]
- EVM data carriers [%/dB]
- EVM pilot carriers [%/dB]

For details on the individual parameters and the summarized values, see [Chapter 3.1.1, "Modulation accuracy, flatness and tolerance parameters"](#), on page 15.



## WLAN I/Q measurement (modulation accuracy, flatness and tolerance)

Remote command:

LAY:ADD? '1',RIGH, RSD, see LAYout:ADD[:WINDow]? on page 350

Querying results:

FETCh:BURSt:ALL:FORMatted? on page 378

### Result Summary Global

The *global* result summary provides measurement results based on the complete signal, consisting of all channels and streams. The observation length is the number of PPDU's to be analyzed as defined by the "Evaluation Range > Statistics" settings. In contrast, the *detailed* result summary provides results for each individual channel and stream.

For MIMO measurements (IEEE 802.11ac, ax, n, be), the global result summary provides the results for all data streams, whereas the detailed result summary provides the results for individual streams.

I Result Summary Global						
No. of PPDU's - Recognized: 19		Analyzed: 18		Analyzed Physical Channel: 18		
PPDU's:	Min	Mean	Limit	Max	Limit	Unit
Pilot Bit Error Rate	0.00	0.00	0.00	0.00	0.00	%
EVM All Carriers	0.34	0.38	31.62	0.49	31.62	%
	-49.25	-48.46	-10.00	-46.15	-10.00	dB
EVM Data Carriers	0.34	0.38	31.62	0.50	31.62	%
	-49.25	-48.44	-10.00	-46.07	-10.00	dB
EVM Pilot Carriers	0.29	0.34	56.23	0.45	56.23	%
	-50.62	-49.31	-5.00	-46.99	-5.00	dB
Center Frequency Error	-4.34	-0.85	±100000.00	3.55	±100000.00	Hz
Symbol Clock Error	0.02	0.09	±20.00	0.17	±20.00	ppm

Figure 3-27: Global result summary for IEEE 802.11a, ac, g (OFDM), j, n, p standards

## WLAN I/Q measurement (modulation accuracy, flatness and tolerance)

1 Result Summary Global						
No. of PPDU's - Recognized: 3		Analyzed: 3		Analyzed Physical Channel: 0		
PPDU's:	Min	Mean	Limit	Max	Limit	Unit
Peak Vector Error	1.18	1.37	35.00	1.47	35.00	%
PPDU EVM	0.19	0.19		0.19		%
	-54.59	-54.57		-54.54		dB
IQ Offset	-67.45	-67.33		-67.24		dB
	82.34	82.34		82.34		%
Gain Imbalance	-15.06	-15.06		-15.06		dB
	0.00	0.00		0.00		°
Quadrature Error	0.00	0.00		0.00		°
Center Freq Error	0.00	0.00	±331250.00	0.00	±331250.00	Hz
Chip Clock Error	-0.00	-0.00	±25.00	-0.00	±25.00	ppm
Rise Time	1.00	1.00	2.00	1.00	2.00	µs
Fall Time	3.18	3.18*	2.00	3.18*	2.00	µs
Mean Power	-2.62	-2.62		-2.62		dBm
Peak Power	-1.67	-1.67		-1.66		dBm
Crest Factor	0.94	0.95		0.95		dB

Figure 3-28: Global result summary for IEEE 802.11b, g (DSSS) standards

The "Result Summary Global" contains the following information:

**Note:** You can configure which results are displayed (see [Chapter 5.3.10, "Result configuration"](#), on page 189). However, the results are always calculated, regardless of their visibility.

(not for IEEE 802.11 be standard)

- Number of recognized PPDU's
- Number of analyzed PPDU's
- Number of analyzed PPDU's in entire physical channel, if available

IEEE 802.11 be standard: "PPDU / MCS / GI+EHT-LTF / RUS":

- PPDU type
- MCS index
- sum of guard interval (GI) length and extremely high throughput long training field (EHT-LTF) length
- RU size of the currently displayed resource unit (see also ["Result displays for multi-user PPDU's"](#) on page 91)

IEEE 802.11a, ac, ax, g (OFDM), j, n, p, be standards:

- Pilot bit error rate [%]
- EVM all carriers [%/dB]
- EVM data carriers [%/dB]

## WLAN I/Q measurement (modulation accuracy, flatness and tolerance)

- EVM pilot carriers [%/dB]
- Center frequency error [Hz]
- Symbol clock error [ppm]

**IEEE 802.11b, g (DSSS) standards:**

- Peak vector error
- PPDU EVM
- Quadrature offset
- Gain imbalance
- Quadrature error
- Center frequency error
- Chip clock error
- Rise time
- Fall time
- Mean power
- Peak power
- Crest power

For details on the individual results and the summarized values, see [Chapter 3.1.1, "Modulation accuracy, flatness and tolerance parameters"](#), on page 15.

Remote command:

LAY:ADD? '1',RIGH, RSGL, see LAYout:ADD[:WINDow]? on page 350

Querying results:

All values in result summary table:

[FETCh:BURSt:ALL:FORMatted?](#) on page 378

EVM values only of all PPDUs:

[FETCh:BURSt:PPDU:EVM:ALL:AVERage?](#) on page 386

**Signal Content Detailed (IEEE 802.11ax, be)**

The Signal Content Detailed display contains information on the signal for *all* resource units.

This result display is only available for high-efficiency and extremely high throughput wireless signals (**IEEE 802.11ax, be**).

## WLAN I/Q measurement (modulation accuracy, flatness and tolerance)

4 Signal Content Detailed							
PPDU Index	RU Index	RU Size	Object	EVM	Power	BER	CWER
1	---	---	L-LTF	---	-19.76 dBm	---	---
1	1	2x996	EHT-LTF	---	-55.47 dBm/SC	---	---
1	1	2x996	Data + Pilot	-89.72 dB	-55.47 dBm/SC	---	---
1	1	2x996	Data	-89.76 dB	---	0.00 %	0.00 %
1	1	2x996	Pilot	-87.96 dB	---	---	---
1	2	2x996	EHT-LTF	---	-55.47 dBm/SC	---	---
1	2	2x996	Data + Pilot	-88.10 dB	-53.88 dBm/SC	---	---
1	2	2x996	Data	-88.11 dB	---	0.00 %	0.00 %
1	2	2x996	Pilot	-87.96 dB	---	---	---

Figure 3-29: Signal Content Detailed result display for IEEE 802.11ax measurements

The "Signal Content Detailed" contains information for each decoded RU and for each object in the following order:

- (As of firmware version 3.20:) Legacy long training field (L-LTF)
- Long training field (HE-LTF)
- Data + Pilot
- Data only
- Pilot only

For each object, the following information is provided:

- PPDU index - sequential order of detected PPDU
- RU index - sequential order of resource unit
- RU size - size of the resource unit
- Object
- EVM in dB
- Power in dBm per subcarrier
- Bit error rate (BER)<sup>\*)</sup>
- Code word error rate (CWER)<sup>\*)</sup>

<sup>\*)</sup> Only if channel decoding is enabled in the Demodulation settings, see "[Demodulation Data \(Bitstream\)](#)" on page 166.

For details on the individual parameters and the summarized values, see [Chapter 3.1.1, "Modulation accuracy, flatness and tolerance parameters"](#), on page 15.

Remote command:

LAY:ADD? '1',RIGH, SCD, see [LAYout:ADD\[:WINDow\]?](#) on page 350

Querying results:

[FETCh:SCDetailed:ALL?](#) on page 386

### Signal Field

This result display shows the decoded data from the signal fields of each recognized PPDU. These fields contain information on the modulation used for transmission.

## WLAN I/Q measurement (modulation accuracy, flatness and tolerance)

This result display is **not** available for single-carrier measurements (**IEEE 802.11b, g (DSSS)**); use **PLCP Header (IEEE 802.11b, g (DSSS))** instead.

3 Signal Field				
HT-MF20 PPDU [1] Bits	Field	Value [Binary]	Value	Info/Comment
<b>L-SIG</b>				
B0-B3	Rate	1101	11	
B4	Reserved	0	0	
B5-B16	Length	110001111000	483	
B17	Parity	1	1	1 PASS
B18-B23	Tail	000000	0	0 PASS
<b>HT-SIG-1</b>				
B0-B6	MCS	1000000	1	QPSK 1/2, Nss 1,
B7	CBW 20/40	0	0	20 MHz
B8-B23	HT-Length	0000000000100000	1024	Sig 158 / Est 158
<b>HT-SIG-1</b>				
B0	Smoothing	1	1	
B1	Not Sounding	1	1	
B2	Reserved	1	1	
B3	Aggregation	0	0	
B4-B5	STBC	00	0	

Figure 3-30: Signal Field display for IEEE 802.11n

The signal field information is provided as a decoded bit sequence and, where appropriate, also in human-readable form for each PPDU.

The currently applied user-defined demodulation settings are indicated in the table header for reference (e.g. "HT-MF20 PPDU [1]" in Figure 3-30). Since the demodulation settings define which PPDUs are to be analyzed, this *logical filter* can be the reason if the "Signal Field" display is not as expected.

The values for the individual demodulation parameters are described in Chapter 5.3.8, "Demodulation", on page 151.

The information differs for the different PPDU formats.

Table 3-5: Signal Field contents according to IEEE 802.11 standard

IEEE standard	PPDU format	"Signal Fields" contents	Standard reference
802.11a	Non-HT	L-SIG	[IEEE Std 802.11-2016] '17.3.4 SIGNAL field'
802.11n	HT-mixed	L-SIG, HT-SIG	[IEEE Std 802.11-2016] '19.3.9.4.3 HT-SIG definition'
802.11n	HT-greenfield	HT-SIG	[IEEE Std 802.11-2016] '19.3.9.5.4 HT-greenfield format HT-SIG'
802.11ac	VHT	L-SIG, VHT-SIG-A	[IEEE Std 802.11-2016] '21.3.8.3.3 VHT-SIG-A definition'
802.11ax	HE SU, HE ER SU	L-SIG, SIG-A	[IEEE Std 802.11ax-2021] '27.3.11.5 L-SIG field'
802.11ax	HE MU	L-SIG, HE-SIG-A, HE-SIG-B	[IEEE Std 802.11ax-2021] '27.3.11.7 HE-SIG-A field'
802.11ax	HE TB	L-SIG, HE-SIG-A	[IEEE Std 802.11ax-2021] '27.3.11.8 HE-SIG-B field'

## WLAN I/Q measurement (modulation accuracy, flatness and tolerance)

IEEE standard	PPDU format	"Signal Fields" contents	Standard reference
802.11be	EHT MU non-OFDMA	L-SIG, U-SIG, EHT-SIG common field	[IEEE P802.11be/D3.2, May 2023] '36.3.12.5 L-SIG'
802.11be	EHT MU	L-SIG, U-SIG, EHT-SIG common field	[IEEE P802.11be/D3.2, May 2023] '36.3.12.7 U-SIG'
802.11be	EHT TB	L-SIG, U-SIG	[IEEE P802.11be/D3.2, May 2023] '36.3.12.8 EHT-SIG'

The "Signal Field" measurement indicates certain inconsistencies in the signal or discrepancies between the demodulation settings and the signal to be analyzed. In both cases, an appropriate warning is displayed and the results for the PPDU are highlighted orange - both in the "Signal Field" display and the "Magnitude Capture" display. If the signal was analyzed with warnings, the results – indicated by a message - also contribute to the overall analysis results.

PPDUs detected in the signal that do not pass the logical filter, i.e. are not to be included in analysis, are dismissed. An appropriate message is provided. The corresponding PPDU in the capture buffer is not highlighted.

The numeric trace results for this evaluation method are described in [Chapter 10.9.4.18, "Signal field"](#), on page 421.

Remote command:

LAY:ADD? '1',RIGH, SFI, see [LAYout:ADD\[:WINDow\]?](#) on page 350

Or:

[CONFigure:BURSt:STATistics:SFIeld\[:IMMediate\]](#) on page 234

Querying results:

Complete contents: [FETCh:SFIeld:ALL?](#) on page 390

(Decimal) Values: [TRACe\[:DATA\]?](#), see [Chapter 10.9.4.18, "Signal field"](#), on page 421

### Spectrum Flatness

The "Spectrum Flatness" trace is derived from the magnitude of the estimated channel transfer function. Since this estimated channel is calculated from all payload symbols of the PPDU, it represents a carrier-wise mean gain of the channel. We assume the cable connection between the DUT and the FSW adds no residual channel distortion. Then the "Spectrum Flatness" shows the spectral distortion caused by the DUT, for example the transmit filter.

This result display is **not** available for single-carrier measurements (**IEEE 802.11b, g (DSSS)**).

The diagram shows the relative power per carrier. All carriers are displayed, including the unused carriers.

In contrast to the SISO measurements in previous Rohde & Schwarz signal and spectrum analyzers, the trace is no longer normalized to 0 dB, that is: scaled by the mean gain of all carriers.

## WLAN I/Q measurement (modulation accuracy, flatness and tolerance)

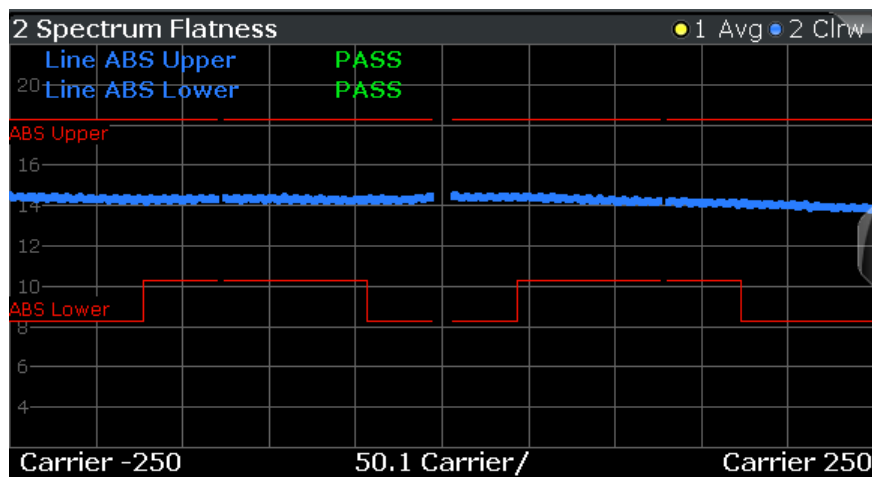

For more information, see [Chapter 4.3.6, "Crosstalk and spectrum flatness"](#), on page 86.

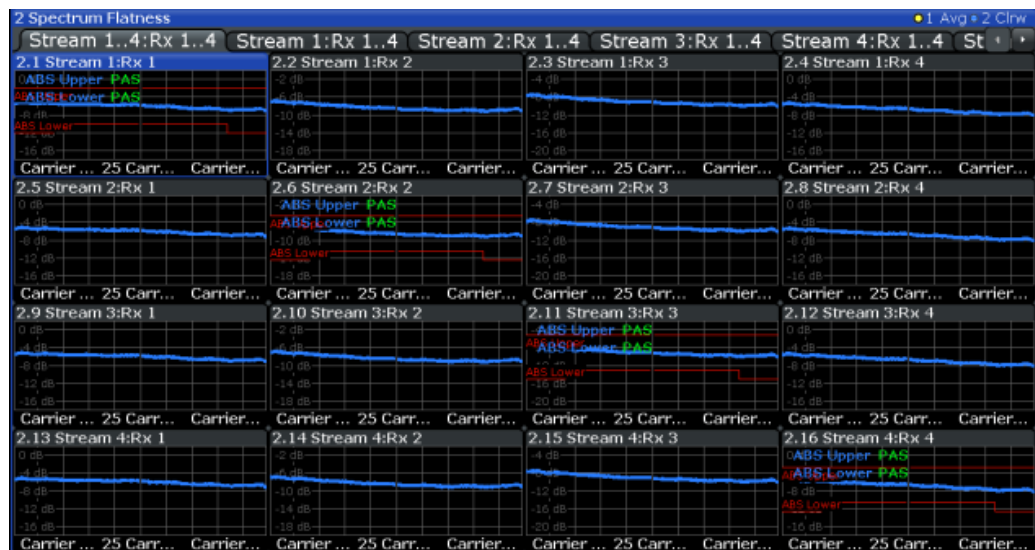

**Figure 3-31: Spectrum flatness result display for IEEE 802.11n MIMO measurements**

The numeric trace results for this evaluation method are described in [Chapter 10.9.4.19, "Spectrum flatness"](#), on page 421.

Remote command:

LAY:ADD? '1',RIGH, SFL, see [LAYout:ADD\[:WINDOW\]?](#) on page 350

Or:

CONF:BURS:SPEC:FLAT:SEL FLAT (see [CONFigure:BURSt:SPECTrum:FLATness:SElect](#) on page 233) and [CONFigure:BURSt:SPECTrum:FLATness\[:IMMediate\]](#) on page 233

Querying results:

TRACe[:DATA]?, see [Chapter 10.9.4.19, "Spectrum flatness"](#), on page 421

## WLAN I/Q measurement (modulation accuracy, flatness and tolerance)

**Spectrum Flatness Result Summary**

Provides numeric results for the [Spectrum Flatness](#) trace. This is useful to check the maximum transmit spectral deviations defined by the IEEE 802.11 ax and be standards.

Range Low /Subc.	Range Up /Subc.	Δ Lower Limit /dB	@Subcarrier	Δ Upper Limit /dB	@Subcarrier
-1012	1012	2.9906	166	3.1331	-826
-1012	-697	4.2194	-1012	3.1331	-826
-696	-515	4.2559	-533	3.3923	-696
-509	-166	4.1220	-167	3.5353	-292
-165	-12	5.3224	-13	3.8853	-165
12	165	4.9335	128	4.7902	12

Maximum deviations are bandwidth and subcarrier dependant. The overall subcarrier range is divided into subranges by the standard. For each subrange, the "Spectrum Flatness" "Result Summary" provides the following values:

(The **first row** indicates the results for the **entire subcarrier range**.)

**Table 3-6: Spectrum Flatness deviation results**

Result	Description
"Range Low/Subc."	Subcarrier number at start of subrange
"Range Up/Subc."	Subcarrier number at end of subrange
"Δ Lower Limit/dB"	The minimal distance from the subcarriers in the subrange to the lower tolerance limit (defined by standard)
"@Subcarrier"	Subcarrier number with the minimal distance to the lower limit
"Δ Upper Limit/dB"	The minimal distance from the subcarriers in the subrange to the upper tolerance limit (defined by standard)
"@Subcarrier"	Subcarrier number with the minimal distance to the upper limit

If the tolerance limit defined by the standard is exceeded, the values are indicated in red font.

Remote command:

LAY:ADD? '1',RIGH, SFL, see [LAYout:ADD\[:WINDow\]?](#) on page 350

Querying results:

[FETCh:SFSummary:ALL?](#) on page 391

**Unused Tone Error**

The unused tone error evaluation determines the error vector magnitude for unoccupied subcarriers, also referred to as *unused tones*. For details on this parameter, see [Chapter 3.1.1.8, "Unused tone error"](#), on page 24.

This result is required by the **IEEE 802.11ax** standard for HE trigger-based PPDU with a maximum channel bandwidth of 80 MHz.



WLAN I/Q measurement (modulation accuracy, flatness and tolerance)

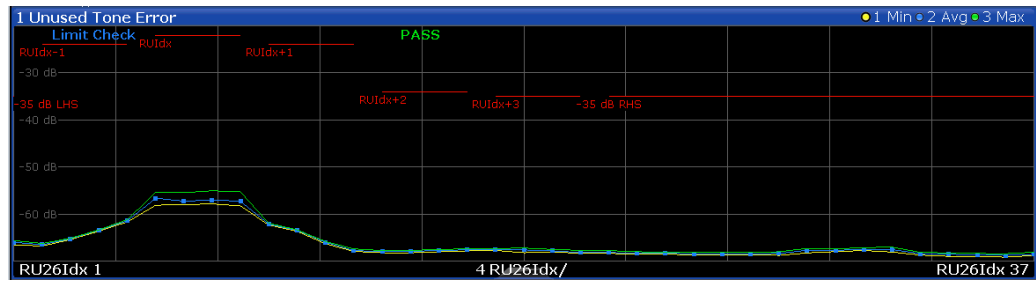

Figure 3-32: Unused tone error for an RU index of 2 and an RU size of 106

The minimum, average and maximum unused tone values are displayed. The x-axis displays the RU index based on an RU size of 26 subcarriers. The individual measurement points are indicated by blue dots. The error vector magnitude limit per RU group, relative to the original RU, as specified by the IEEE 802.11ax standard, is indicated by red lines in the diagram. The result of the overall limit check for the entire channel is indicated as "Pass" or "Fail".

The "Unused Tone Error" diagram provides an overview of the unused tone error results of an entire channel at a glance. For detailed numeric results for individual RU groups, use the [Unused Tone Error Summary](#).

Remote command:

LAY:ADD? '1', RIGH, UTER, see [LAYout:ADD\[:WINDow\]?](#) on page 350

Querying results:

TRACe[:DATA]?, see [Chapter 10.9.4.20, "Unused tone error"](#), on page 421

**Unused Tone Error Summary**

The unused tone error summary determines the error vector magnitude, relative to the original RU, for unoccupied subcarriers, also referred to as *unused tones*. For details on this parameter, see [Chapter 3.1.1.8, "Unused tone error"](#), on page 24.

This result is required by the **IEEE 802.11ax** standard for HE trigger-based PPDU with a maximum channel bandwidth of 80 MHz.

3 Unused Tone Error Summary									
RU Group	RU Size	Min dB	Mean dB	Max dB	Limit dB	Delta dB	Max RU26Idx	Limit Check	
-35 dB LHS	4	-66.01	-66.01	-66.01	-35.00	-31.01	1	PASS	
RUIdx-3	---	---	---	---	---	---	---	---	
RUIdx-2	---	---	---	---	---	---	---	---	
RUIdx-1	4	-66.53	-64.16	-61.43	-24.00	-37.43	5	PASS	
RUIdx	4	-57.29	-57.05	-56.63	-22.00	-34.63	6	PASS	
RUIdx+1	4	-67.78	-64.86	-62.16	-24.00	-38.16	10	PASS	
RUIdx+2	4	-67.97	-67.82	-67.62	-34.00	-33.62	17	PASS	
RUIdx+3	4	-68.18	-67.78	-67.50	-35.00	-32.50	18	PASS	

Figure 3-33: Unused tone error summary for an RU index of 2 and an RU size of 106 (=4\*26)

**Note:** For an overview of the unused tone error results of an entire channel at a glance, use the [Unused Tone Error](#) diagram.

The "Unused Tone Error Summary" provides the following information for up to 9 RU groups. Which subcarriers are evaluated in which RU group depends on the size and index of the resource unit to be checked. For details, see [Chapter 3.1.1.8, "Unused tone error"](#), on page 24.

"RU group"	Set of subcarriers for which a limit is specified in the standard
"RU size"	Size of the RU, indicated as a factor of 26 (RU26 unit)
"Min"	Minimum unused tone error measured in the RU group
"Mean"	Mean unused tone error measured in the RU group
"Max"	Maximum unused tone error measured in the RU group
"Limit"	Limit for unused tone error, relative to the original RU, as specified by the IEEE 802.11ax standard
"Delta"	Limit - Max = distance of maximum value to limit for the RU group
"Max RU26 Idx"	Index of the subcarrier with the maximum value, based on an RU size of 26
"Limit check"	Result of the limit check for the individual RU group

Remote command:

LAY:ADD? '1', RIGH, UTES, see [LAYout:ADD\[:WINDow\]?](#) on page 350

Querying results:

[FETCh:UTESummary:ALL?](#) on page 392

Querying limit results:

[CALCulate<n>:LIMit<li>:CONTrol\[:DATA\]?](#) on page 398

[CALCulate<n>:LIMit<li>:UPPer\[:DATA\]?](#) on page 399

[CALCulate<n>:LIMit<li>:FAIL?](#) on page 398

## 3.2 Frequency sweep measurements

As described above, the WLAN IQ measurement captures the I/Q data from the WLAN signal using a (nearly rectangular) filter with a relatively large bandwidth. However, some parameters specified in the WLAN 802.11 standard require a better signal-to-noise level or a smaller bandwidth filter than the I/Q measurement provides and must be determined in separate measurements.

Parameters that are common to several digital standards and are often required in signal and spectrum test scenarios can be determined by the standard measurements provided in the FSW base unit (Spectrum application). These measurements are performed using a much narrower bandwidth filter, and they capture only the power level (magnitude, which we refer to as *RF data*) of the signal, as opposed to the two components provided by I/Q data.

Frequency sweep measurements can tune on a constant frequency ("Zero span measurement") or sweep a frequency range ("Frequency sweep measurement")

The signal cannot be demodulated based on the captured RF data. However, the required power information can be determined much more precisely, as more noise is filtered out of the signal.

The Frequency sweep measurements provided by the FSW WLAN application are identical to the corresponding measurements in the base unit, but are pre-configured according to the requirements of the selected WLAN 802.11 standard.

For details on these measurements see the FSW User Manual.



**MSRA operating mode**

Frequency sweep measurements are not available in MSRA operating mode.

For details on the MSRA operating mode see the FSW MSRA User Manual.

The FSW WLAN application provides the following frequency sweep measurements:

**3.2.1 Measurement types and results for frequency sweep measurements**

The FSW WLAN application provides the following pre-configured frequency sweep measurements:

Channel Power ACLR..... 59  
 Spectrum Emission Mask.....60  
 Occupied Bandwidth..... 60  
 CCDF..... 61

**Channel Power ACLR**

"Channel Power ACLR" performs an adjacent channel power (also known as adjacent channel leakage ratio) measurement according to WLAN 802.11 specifications.

The FSW measures the channel power and the relative power of the adjacent channels and of the alternate channels. The results are displayed in the "Result Summary".

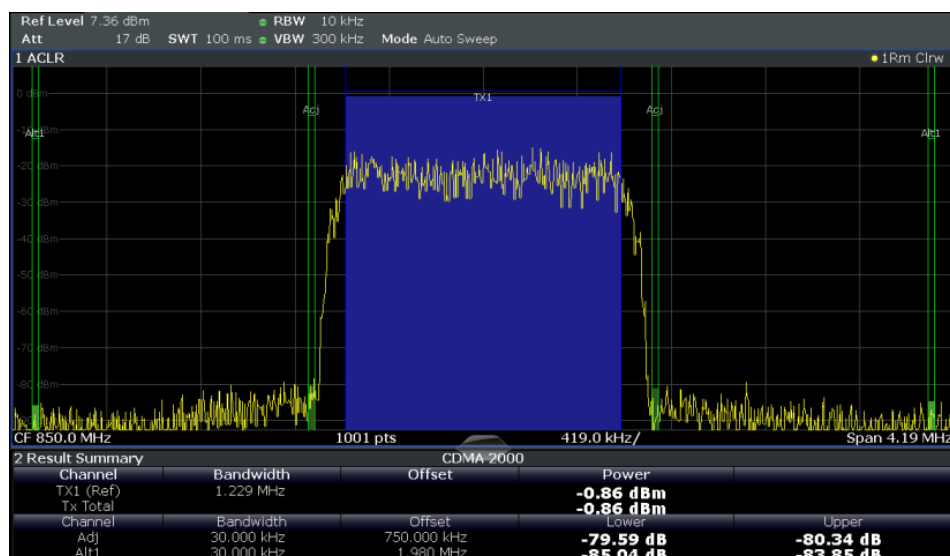

For details see [Chapter 5.4.1, "Channel power \(ACLR\) measurements"](#), on page 200.

Remote command:

`CONFigure:BUSt:SPECTrum:ACPR[:IMMediate]` on page 235

Querying results:

`CALC:MARK:FUNC:POW:RES? ACP`, see `CALCulate<n>:MARKer<m>:FUNCtion:POWer<sb>:RESult?` on page 402

### Spectrum Emission Mask

**Access:** "Overview" > "Select Measurement" > "SEM"

**Or:** [MEAS] > "Select Measurement" > "SEM"

The "Spectrum Emission Mask" (SEM) measurement determines the power of the WLAN 802.11 signal in defined offsets from the carrier and compares the power values with a spectral mask specified by the WLAN 802.11 specifications. The limits depend on the selected bandclass. Thus, the performance of the DUT can be tested and the emissions and their distance to the limit be identified.

**Note:** The WLAN 802.11 standard does not distinguish between spurious and spectral emissions.

For details see [Chapter 5.4.2, "Spectrum emission mask"](#), on page 200.

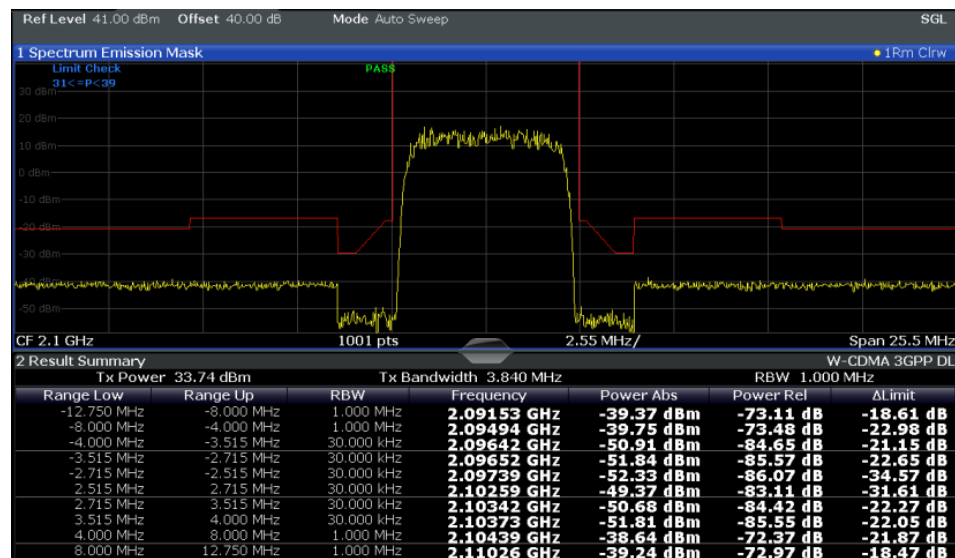

Figure 3-34: SEM measurement results

Remote command:

`CONFigure:BUSt:SPECTrum:MASK[:IMMediate]` on page 235

Querying results:

`CALCulate<n>:LIMit<li>:FAIL?` on page 398

`TRAC:DATA? LIST`, see `TRACe[:DATA]?` on page 408

### Occupied Bandwidth

The "Occupied Bandwidth" (OBW) measurement determines the bandwidth in which a certain percentage of the total signal power is measured. The percentage of the signal power to be included in the bandwidth measurement can be changed; by default settings it is 99 %.

The occupied bandwidth is indicated as the "Occ BW" function result in the marker table; the frequency markers used to determine it are also displayed.



For details, see [Chapter 5.4.3, "Occupied bandwidth"](#), on page 201.

Remote command:

`CONFigure:BURSt:SPECTrum:OBWidth[:IMMediate]` on page 235

Querying results:

`CALC:MARK:FUNC:POW:RES? OBW`, see `CALCulate<n>:MARKer<m>:FUNCtion:POWer<sb>:RESult?` on page 402

### CCDF

The "CCDF" (complementary cumulative distribution function) measurement determines the distribution of the signal amplitudes. The measurement captures a user-definable number of samples and calculates their mean power. As a result, the probability that a sample's power is higher than the calculated mean power + x dB is displayed. The crest factor is displayed in the "Result Summary".

For details see [Chapter 5.4.4, "CCDF"](#), on page 202.



Figure 3-35: CCDF measurement results

Remote command:

`CONFigure:BURSt:STATistics:CCDF[:IMMediate]` on page 235

Querying results:

`CALCulate<n>:MARKer<m>:Y?` on page 428

`CALCulate<n>:STATistics:RESult<res>?` on page 405

### 3.2.2 Evaluation methods for frequency sweep measurements

The evaluation methods for frequency sweep measurements in the FSW WLAN application are identical to those in the FSW base unit (Spectrum application).

<a href="#">Diagram</a> .....	62
<a href="#">Result Summary</a> .....	63
<a href="#">Marker Table</a> .....	63
<a href="#">Marker Peak List</a> .....	64

#### Diagram

Displays a basic level vs. frequency or level vs. time diagram of the measured data to evaluate the results graphically. This is the default evaluation method. Which data is displayed in the diagram depends on the "Trace" settings. Scaling for the y-axis can be configured.

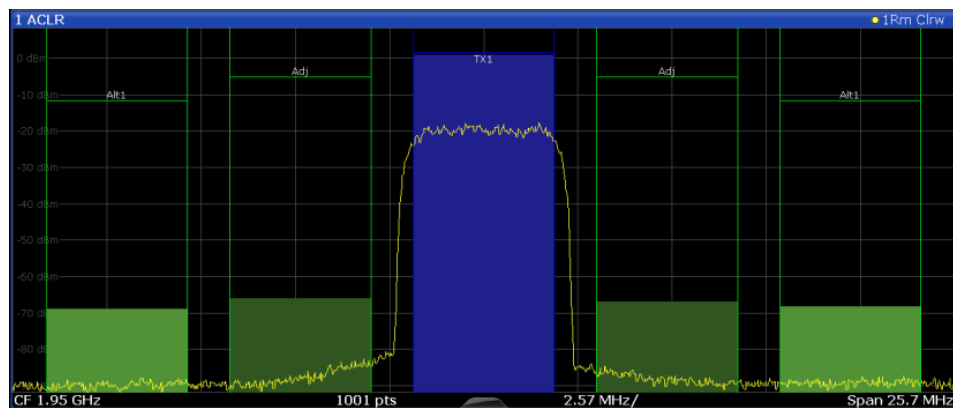

Remote command:

LAY:ADD? '1', RIGH, DIAG, see [LAYout:ADD\[:WINDow\]?](#) on page 350

Results:

### Result Summary

Result summaries provide the results of specific measurement functions in a table for numerical evaluation. The contents of the result summary vary depending on the selected measurement function. See the description of the individual measurement functions for details.

2 Result Summary				
Channel	Bandwidth	Offset	Power	
TX1 (Ref)	1.229 MHz		<b>-0.86 dBm</b>	
Tx Total			<b>-0.86 dBm</b>	
Channel	Bandwidth	Offset	Lower	Upper
Adj	30.000 kHz	750.000 kHz	<b>-79.59 dB</b>	<b>-80.34 dB</b>
Alt1	30.000 kHz	1.980 MHz	<b>-85.04 dB</b>	<b>-83.85 dB</b>

**Tip:** To navigate within long marker tables, simply scroll through the entries with your finger on the touchscreen.

Remote command:

LAY:ADD? '1', RIGH, RSUM, see [LAYout:ADD\[:WINDow\]?](#) on page 350

### Marker Table

Displays a table with the current marker values for the active markers.

This table is displayed automatically if configured accordingly.

1 Marker Table							
Wnd	Type	Ref	Trc	X-Value	Y-Value	Function	Function Result
2	M1		1	<b>2.1725 ms</b>	<b>-6.80 dBm</b>		
2	D2	M1	1	<b>13.859 ms</b>	<b>-0.00 dB</b>		
2	D3	M1	1	<b>4.6259 ms</b>	<b>-0.00 dB</b>		
2	D4	M1	1	<b>9.2331 ms</b>	<b>-0.00 dB</b>		

**Tip:** To navigate within long marker tables, simply scroll through the entries with your finger on the touchscreen.

Remote command:

LAY:ADD? '1', RIGH, MTAB, see [LAYout:ADD\[:WINDow\]?](#) on page 350

Results:

[CALCulate<n>:MARKer<m>:X](#) on page 405

[CALCulate<n>:MARKer<m>:Y?](#) on page 428

### Marker Peak List

The marker peak list determines the frequencies and levels of peaks in the spectrum or time domain. How many peaks are displayed can be defined, as well as the sort order. In addition, the detected peaks can be indicated in the diagram. The peak list can also be exported to a file for analysis in an external application.

3 Marker Peak List			
Wnd	No	X-Value	Y-Value
2	1	1.086245 ms	-75.810 dBm
2	2	2.172490 ms	-6.797 dBm
2	3	3.258736 ms	-76.448 dBm
2	4	4.831918 ms	-76.676 dBm
2	5	6.255274 ms	-76.482 dBm
2	6	6.798397 ms	-6.800 dBm
2	7	9.233084 ms	-76.519 dBm
2	8	10.075861 ms	-76.172 dBm
2	9	11.405574 ms	-6.801 dBm

**Tip:** To navigate within long marker peak lists, simply scroll through the entries with your finger on the touchscreen.

Remote command:

LAY:ADD? '1',RIGH, PEAK, see [LAYout:ADD\[:WINDow\]?](#) on page 350

Results:

[CALCulate<n>:MARKer<m>:X](#) on page 405

[CALCulate<n>:MARKer<m>:Y?](#) on page 428



## 4 Measurement basics

Some background knowledge on basic terms and principles used in WLAN measurements is provided here for a better understanding of the required configuration settings.

### 4.1 Signal processing for multicarrier measurements (IEEE 802.11a, g (OFDM), j, p)

This description gives a rough view of the signal processing when using the R&S FSW WLAN application with the IEEE 802.11a, g (OFDM), j, p standards. Details are disregarded in order to provide a concept overview.

#### Abbreviations

$a_{l,k}$	Symbol at symbol $l$ of subcarrier $k$
$EVM_k$	Error vector magnitude of subcarrier $k$
EVM	Error vector magnitude of current packet
$g$	Signal gain
$\Delta f$	Frequency deviation between Tx and Rx
$l$	Symbol index $l = \{1 \dots \text{nof\_Symbols}\}$
nof_symbols	Number of symbols of payload
$H_k$	Channel transfer function of subcarrier $k$
$k$	Channel index $k = \{-31 \dots 32\}$
$K_{\text{mod}}$	Modulation-dependent normalization factor
$\xi$	Relative clock error of reference oscillator
$r_{l,k}$	Subcarrier of symbol $l$

- [Block diagram for multicarrier measurements](#).....65
- [Literature on the IEEE 802.11a standard](#)..... 72

#### 4.1.1 Block diagram for multicarrier measurements

A diagram of the significant blocks when using the IEEE 802.11a, g (OFDM), j, p standard in the R&S FSW WLAN application is shown in [Figure 4-1](#).

First the RF signal is downconverted to the IF frequency  $f_{\text{IF}}$ . The resulting IF signal  $r_{\text{IF}}(t)$  is shown on the left-hand side of the figure. After bandpass filtering, the signal is sampled by an analog to digital converter (ADC) at a sample rate of  $f_{\text{s1}}$ . This digital

sequence is resampled. Thus, the sample rate of the downsampled sequence  $r(i)$  is the Nyquist rate of  $f_{s3} = 20$  MHz. Up to this point the digital part is implemented in an ASIC.

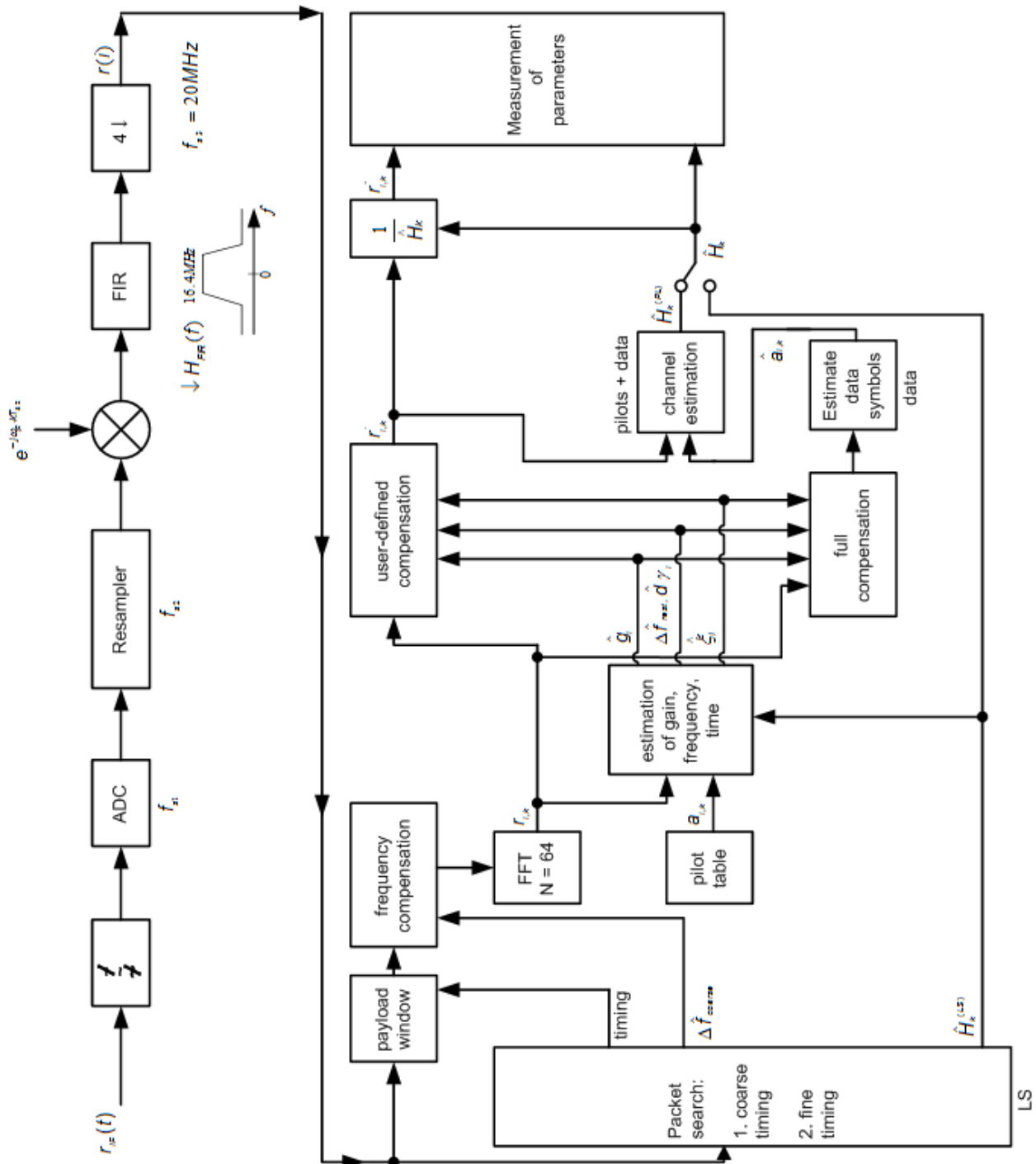

Figure 4-1: Block diagram for the R&S FSW WLAN application using the IEEE 802.11a, g (OFDM), j, p standard

In the lower part of the figure the subsequent digital signal processing is shown.

### Packet search and timing detection

In the first block the **packet search** is performed. This block detects the *long symbol* (LS) and recovers the timing. The **coarse timing** is detected first. This search is implemented in the time domain. The algorithm is based on cyclic repetition within the LS after  $N = 64$  samples. Numerous treatises exist on this subject, e.g. [1] to [3].

Furthermore, a coarse estimate  $\Delta\hat{f}_{\text{coarse}}$  of the Rx-Tx frequency offset  $\Delta f$  is derived from the metric in [6]. (The hat generally indicates an estimate, e.g.  $\hat{x}$  is the estimate of  $x$ .) This can easily be understood because the phase of  $r(i) \cdot \Delta r^*(i + N)$  is determined by the frequency offset. As the frequency deviation  $\Delta f$  can exceed half a bin (distance between neighboring subcarriers) the preceding *short symbol* (SS) is also analyzed in order to detect the ambiguity.

After the coarse timing calculation the time estimate is improved by the **fine timing** calculation. This is achieved by first estimating the coarse frequency response  $\hat{H}_k^{(LS)}$ , where  $k = \{-26..26\}$  denotes the channel index of the *occupied* subcarriers. First the FFT of the LS is calculated. After the FFT calculation the known symbol information of the LS subcarriers is removed by dividing by the symbols. The result is a coarse estimate  $\hat{H}_k$  of the channel transfer function. In the next step, the complex channel impulse response is computed by an IFFT. Then the energy of the windowed impulse response (the window size is equal to the guard period) is calculated for each trial time. Afterwards the trial time of the maximum energy is detected. This trial time is used to adjust the timing.

### Determining the payload window

Now the position of the LS is known and the starting point of the useful part of the first payload symbol can be derived. In the next block this calculated time instant is used to position the **payload window**. Only the payload part is windowed. This is sufficient because the payload is the only subject of the subsequent measurements.

In the next block the windowed sequence is **compensated** by the coarse frequency estimate  $\Delta\hat{f}_{\text{coarse}}$ . This is necessary because otherwise inter-channel interference (ICI) would occur in the frequency domain.

The transition to the frequency domain is achieved by an FFT of length 64. The FFT is performed symbol-wise for each symbol of the payload ("nof\_symbols"). The calculated FFTs are described by  $r_{l,k}$  with:

- $l = \{1 .. \text{nof\_symbols}\}$  as the symbol index
- $k = \{-31 .. 32\}$  as the channel index

In case of an additive white Gaussian noise (AWGN) channel, the FFT is described by [4], [5]

$$r_{l,k} = K_{\text{mod}} \times a_{l,k} \times g_l \times H_k \times e^{j(\text{phase}_l^{(\text{common})} + \text{phase}_{l,k}^{(\text{timing})})} + n_{l,k}$$

#### Equation 4-1: FFT

with:

- $K_{\text{mod}}$ : the modulation-dependant normalization factor

## Signal processing for multicarrier measurements (IEEE 802.11a, g (OFDM), j, p)

- $a_{l,k}$ : the symbol of subcarrier  $k$  at symbol  $l$
- $g_l$ : the gain at the symbol  $l$  in relation to the reference gain  $g = 1$  at the long symbol (LS)
- $H_k$ : the channel frequency response at the long symbol (LS)
- $phase_l^{(common)}$ : the common phase drift phase of all subcarriers at symbol  $l$  (see [Common phase drift](#))
- $phase_{l,k}^{(timing)}$ : the phase of subcarrier  $k$  at symbol  $l$  caused by the timing drift (see [Common phase drift](#))
- $n_{l,k}$ : the independent Gaussian distributed noise samples

**Phase drift and frequency deviation**

The common phase drift in [FFT](#) is given by:

$$phase_l^{(common)} = 2\pi \times N_s / N \times \Delta f_{rest} T \times l + d\gamma_l$$

**Equation 4-2: Common phase drift**

with

- $N_s = 80$ : the number of Nyquist samples of the symbol period
- $N = 64$ : the number of Nyquist samples of the useful part of the symbol
- $\Delta f_{rest}$ : the (not yet compensated) frequency deviation
- $d\gamma_l$ : the phase jitter at the symbol  $l$

In general, the coarse frequency estimate  $\Delta \hat{f}_{coarse}$  (see [Figure 4-1](#)) is not error-free. Therefore the remaining frequency error  $\Delta f_{rest}$  represents the frequency deviation in  $r_{l,k}$  not yet compensated. Consequently, the overall frequency deviation of the device under test (DUT) is calculated by:

$$\Delta f = \Delta \hat{f}_{coarse} + \Delta f_{rest}$$



The common phase drift in [Common phase drift](#) is divided into two parts to calculate the overall frequency deviation of the DUT.

The reason for the phase jitter  $d\gamma_l$  in [Common phase drift](#) may be different. The nonlinear part of the phase jitter may be caused by the phase noise of the DUT oscillator. Another reason for nonlinear phase jitter may be the increase of the DUT amplifier temperature at the beginning of the PPDU. Note that besides the nonlinear part the phase jitter,  $d\gamma_l$  also contains a constant part. This constant part is caused by the frequency deviation  $\Delta f_{rest}$  not yet compensated. To understand this, keep in mind that the measurement of the phase starts at the first symbol  $l = 1$  of the payload. In contrast, the channel frequency response  $H_k$  in [FFT](#) represents the channel at the long symbol of the preamble. Consequently, the frequency deviation  $\Delta f_{rest}$  not yet compensated produces a phase drift between the long symbol and the first symbol of the payload. Therefore, this phase drift appears as a constant value ("DC value") in  $d\gamma_l$ .

### Tracking the phase drift, timing jitter and gain

Referring to the IEEE 802.11a, g (OFDM), j, p measurement standard, chapter 17.3.9.7 "Transmit modulation accuracy test" [6], the common phase drift  $\text{phase}_i^{(\text{common})}$  must be estimated and compensated from the pilots. Therefore this "symbol-wise phase tracking" is activated as the default setting of the R&S FSW WLAN application (see "Phase Tracking" on page 149).

Furthermore, the timing drift in FFT is given by:

$$\text{phase}_{i,k}^{(\text{timing})} = 2\pi \times N_s / N \times \xi \times k \times l$$

#### Equation 4-3: Timing drift

with  $\xi$ : the relative clock deviation of the reference oscillator

Normally, a symbol-wise timing jitter is negligible and thus not modeled in [Timing drift](#). However, there may be situations where the timing drift has to be taken into account. This is illustrated by an example: In accordance to [6], the allowed clock deviation of the DUT is up to  $\xi_{\text{max}} = 20$  ppm. Furthermore, a long packet with 400 symbols is assumed. The result of FFT and [Timing drift](#) is that the phase drift of the highest sub-carrier  $k = 26$  in the last symbol  $l = \text{nof\_symbols}$  is 93 degrees. Even in the noise-free case, this would lead to symbol errors. The example shows that it is actually necessary to estimate and compensate the clock deviation, which is accomplished in the next block.

Referring to the IEEE 802.11a, g (OFDM), j, p measurement standard [6], the timing drift  $\text{phase}_{i,k}^{(\text{timing})}$  is not part of the requirements. Therefore the "time tracking" is not activated as the default setting of the R&S FSW WLAN application (see "[Timing Error Tracking](#)" on page 149). The time tracking option should rather be seen as a powerful analyzing option.

In addition, the tracking of the gain  $g_i$  in FFT is supported for each symbol in relation to the reference gain  $g = 1$  at the time instant of the long symbol (LS). At this time the coarse channel transfer function  $\hat{H}^{(\text{LS})}_k$  is calculated.

This makes sense since the sequence  $r'_{i,k}$  is compensated by the coarse channel transfer function  $\hat{H}^{(\text{LS})}_k$  before estimating the symbols. Consequently, a potential change of the gain at the symbol  $l$  (caused, for example, by the increase of the DUT amplifier temperature) may lead to symbol errors especially for a large symbol alphabet  $M$  of the MQAM transmission. In this case, the estimation and the subsequent compensation of the gain are useful.

Referring to the IEEE 802.11a, g (OFDM), j, p measurement standard [6], the compensation of the gain  $g_i$  is not part of the requirements. Therefore the "gain tracking" is not activated as the default setting of the R&S FSW WLAN application (see "[Level Error \(Gain\) Tracking](#)" on page 150).

### Determining the error parameters (log likelihood function)

How can the parameters above be calculated? In this application the optimum maximum likelihood algorithm is used. In the first estimation step the symbol-independent parameters  $\Delta f_{\text{rest}}$  and  $\xi$  are estimated. The symbol-dependent parameters can be

neglected in this step, i.e. the parameters are set to  $g_l = 1$  and  $d\tilde{\gamma}_l = 0$ . Referring to [FFT](#), the log likelihood function  $L$  must be calculated as a function of the trial parameters  $\Delta\tilde{f}_{rest}$  and  $\tilde{\xi}$ . (The tilde generally describes a trial parameter. Example:  $\tilde{x}$  is the trial parameter of  $x$ .)

$$L_1(\Delta\tilde{f}_{rest}, \tilde{\xi}) = \sum_{l=1}^{nof\_symbols} \sum_{k=-21, -7, 7, 21} \left| r_{l,k} - a_{l,k} \times \hat{H}_k^{(LS)} \times e^{j(\tilde{p}hase_l^{(common)} + \tilde{p}hase_{l,k}^{(timing)})} \right|^2$$

**Equation 4-4: Log likelihood function (step 1)**

with:

$$\tilde{p}hase_l^{(common)} = \frac{2\pi \times N_s}{N \times \Delta\tilde{f}_{rest} \times T \times l}$$

$$\tilde{p}hase_{l,k}^{(timing)} = \frac{2\pi \times N_s}{N \times \tilde{\xi} \times k \times l}$$

The trial parameters leading to the minimum of the log likelihood function are used as estimates  $\Delta\tilde{f}_{rest}$  and  $\tilde{\xi}$ . In [Log likelihood function \(step 1\)](#) the known pilot symbols  $a_{l,k}$  are read from a table.

In the second step, the log likelihood function is calculated for every symbol  $l$  as a function of the trial parameters  $\tilde{g}_l$  and  $d\tilde{\gamma}_l$ :

$$L_2(\tilde{g}_l, d\tilde{\gamma}_l) = \sum_{k=-21, -7, 7, 21} \left| r_{l,k} - a_{l,k} \times \tilde{g}_l \times \hat{H}_k^{(LS)} \times e^{j(\tilde{p}hase_l^{(common)} + \tilde{p}hase_{l,k}^{(timing)})} \right|^2$$

**Equation 4-5: Log likelihood function (step 2)**

with:

$$\tilde{p}hase_l^{(common)} = \frac{2\pi \times N_s}{N \times \Delta\hat{f}_{rest} \times T \times l + d\tilde{\gamma}_l}$$

$$\tilde{p}hase_{l,k}^{(timing)} = \frac{2\pi \times N_s}{N \times \tilde{\xi} \times k \times l}$$

Finally, the trial parameters leading to the minimum of the log likelihood function are used as estimates  $\tilde{g}_l$  and  $d\tilde{\gamma}_l$ .

This robust algorithm works well even at low signal to noise ratios with the Cramer Rao Bound being reached.

### Compensation

After estimation of the parameters, the sequence  $r_{l,k}$  is compensated in the compensation blocks.

In the upper analyzing branch the compensation is user-defined i.e. the user determines which of the parameters are compensated. This is useful in order to extract the influence of these parameters. The resulting output sequence is described by:  $\gamma'_{\delta,k}$ .

### Data symbol estimation

In the lower compensation branch the full compensation is always performed. This separate compensation is necessary in order to avoid symbol errors. After the full compensation the secure estimation of the data symbols  $\hat{a}_{i,k}$  is performed. From FFT it is clear that first the channel transfer function  $H_k$  must be removed. This is achieved by dividing the known coarse channel estimate  $\hat{H}^{(LS)}_k$  calculated from the LS. Usually an error free estimation of the data symbols can be assumed.

### Improving the channel estimation

In the next block a better channel estimate  $\hat{H}^{(PL)}_k$  of the data and pilot subcarriers is calculated by using all "nof\_symbols" symbols of the payload (PL). This can be accomplished at this point because the phase is compensated and the data symbols are known. The long observation interval of nof\_symbols symbols (compared to the short interval of 2 symbols for the estimation of  $\hat{H}^{(LS)}_k$ ) leads to a nearly error-free channel estimate.

In the following equalizer block,  $\hat{H}^{(LS)}_k$  is compensated by the channel estimate. The resulting channel-compensated sequence is described by  $y_{\delta,k}$ . The user may either choose the coarse channel estimate  $\hat{H}^{(LS)}_k$  (from the long symbol) or the nearly error-free channel estimate  $\hat{H}^{(PL)}_k$  (from the payload) for equalization. If the improved estimate  $\hat{H}^{(LS)}_k$  is used, a 2 dB reduction of the subsequent EVM measurement can be expected.

According to the IEEE 802.11a measurement standard [6], the coarse channel estimation  $\hat{H}^{(LS)}_k$  (from the long symbol) has to be used for equalization. Therefore the default setting of the R&S FSW WLAN application is equalization from the coarse channel estimate derived from the long symbol.

### Calculating error parameters

In the last block the parameters of the demodulated signal are calculated. The most important parameter is the error vector magnitude of the subcarrier "k" of the current packet:

$$\overline{EVM} = \sqrt{\frac{1}{\text{nof\_packets}} \sum_{\text{counter}=1}^{\text{nof\_packets}} EVM^2(\text{counter})}$$

**Equation 4-6: Error vector magnitude of the subcarrier k in current packet**

Furthermore, the packet error vector magnitude is derived by averaging the squared  $EVM_k$  versus k:

$$EVM = \sqrt{\frac{1}{52} \sum_{k=-26(k \neq 0)}^{26} EVM_k^2}$$

**Equation 4-7: Error vector magnitude of the entire packet**

Finally, the average error vector magnitude is calculated by averaging the packet EVM of all nof\_symbols detected packets:

## Signal processing for single-carrier measurements (IEEE 802.11b, g (DSSS))

$$EVM_k = \sqrt{\frac{1}{nof\_symbols} \sum_{l=1}^{nof\_symbols} |r_{l,k}^n - K_{mod} \times a_{l,k}|^2}$$

**Equation 4-8: Average error vector magnitude**

This parameter is equivalent to the "RMS average of all errors": Error<sub>RMS</sub> of the IEEE 802.11a measurement commandment (see [6]).

#### 4.1.2 Literature on the IEEE 802.11a standard

[1]	Speth, Classen, Meyr: "Frame synchronization of OFDM systems in frequency selective fading channels", VTC '97, pp. 1807-1811
[2]	Schmidl, Cox: "Robust Frequency and Timing Synchronization of OFDM", IEEE Trans. on Comm., Dec. 1997, pp. 1613-621
[3]	Minn, Zeng, Bhargava: "On Timing Offset Estimation for OFDM", IEEE Communication Letters, July 2000, pp. 242-244
[4]	Speth, Fechtel, Fock, Meyr: "Optimum receive antenna Design for Wireless Broad-Band Systems Using OFDM – Part I", IEEE Trans. On Comm. VOL. 47, NO 11, Nov. 1999
[5]	Speth, Fechtel, Fock, Meyr: "Optimum receive antenna Design for Wireless Broad-Band Systems Using OFDM – Part II", IEEE Trans. On Comm. VOL. 49, NO 4, April. 2001
[6]	IEEE 802.11a, Part 11: WLAN Medium Access Control (MAC) and Physical Layer (PHY) specifications

## 4.2 Signal processing for single-carrier measurements (IEEE 802.11b, g (DSSS))

This description gives a rough overview of the signal processing concept of the WLAN 802.11 application for IEEE 802.11b or g (DSSS) signals.

### Abbreviations

$\varepsilon$	timing offset
$\Delta f$	frequency offset
$\Delta\Phi$	phase offset
$\hat{g}_I$	estimate of the gain factor in the I-branch
$\hat{g}_Q$	estimate of the gain factor in the Q-branch
$\Delta\hat{g}_Q$	accurate estimate of the crosstalk factor of the Q-branch in the I-branch
$\hat{h}_s(v)$	estimated baseband filter of the transmit antenna
$\hat{h}_r(v)$	estimated baseband filter of the receive antenna
$\hat{o}_I$	estimate of the IQ-offset in the I-branch



## Signal processing for single-carrier measurements (IEEE 802.11b, g (DSSS))

$\hat{\omega}_Q$	estimate of the IQ-offset in the I-branch
$r(v)$	measurement signal
$\hat{s}(v)$	estimate of the reference signal
$\hat{s}_n(v)$	estimate of the power-normalized and undisturbed reference signal
ARG{...}	calculation of the angle of a complex value
EVM	error vector magnitude
IMAG{...}	calculation of the imaginary part of a complex value
PPDU	protocol data unit - a burst in the signal containing transmission data
PSDU	protocol service data unit- a burst in the signal containing service data
REAL{...}	calculation of the real part of a complex value

- [Block diagram for single-carrier measurements](#).....73
- [Calculation of signal parameters](#).....75
- [Literature on the IEEE 802.11b standard](#).....78

#### 4.2.1 Block diagram for single-carrier measurements

A block diagram of the measurement application is shown below in [Figure 4-2](#). The baseband signal of an IEEE 802.11b or g (DSSS) wireless LAN system transmit antenna is sampled with a sample rate of 44 MHz.

The first task of the measurement application is to detect the position of the PPDU within the measurement signal  $r_1(v)$ . The detection algorithm is able to find the beginning of short and long PPDU and can distinguish between them. The algorithm also detects the initial state of the scrambler, which is not specified by the IEEE 802.11 standard.

If the start position of the PPDU is known, the header of the PPDU can be demodulated. The bits transmitted in the header provide information about the length of the PPDU and the modulation type used in the PSDU.

Once the start position and the PPDU length are fully known, better estimates of timing offset, timing drift, frequency offset and phase offset can be calculated using the entire data of the PPDU.

At this point of the signal processing, demodulation can be performed without decision error. After demodulation the normalized (in terms of power) and undisturbed reference signal  $s(v)$  is available.

If the frequency offset is not constant and varies with time, the frequency offset and phase offset in several partitions of the PPDU must be estimated and corrected. Additionally, timing offset, timing drift and gain factor can be estimated and corrected in several partitions of the PPDU. These corrections can be switched off individually in the demodulation settings of the application.

Signal processing for single-carrier measurements (IEEE 802.11b, g (DSSS))

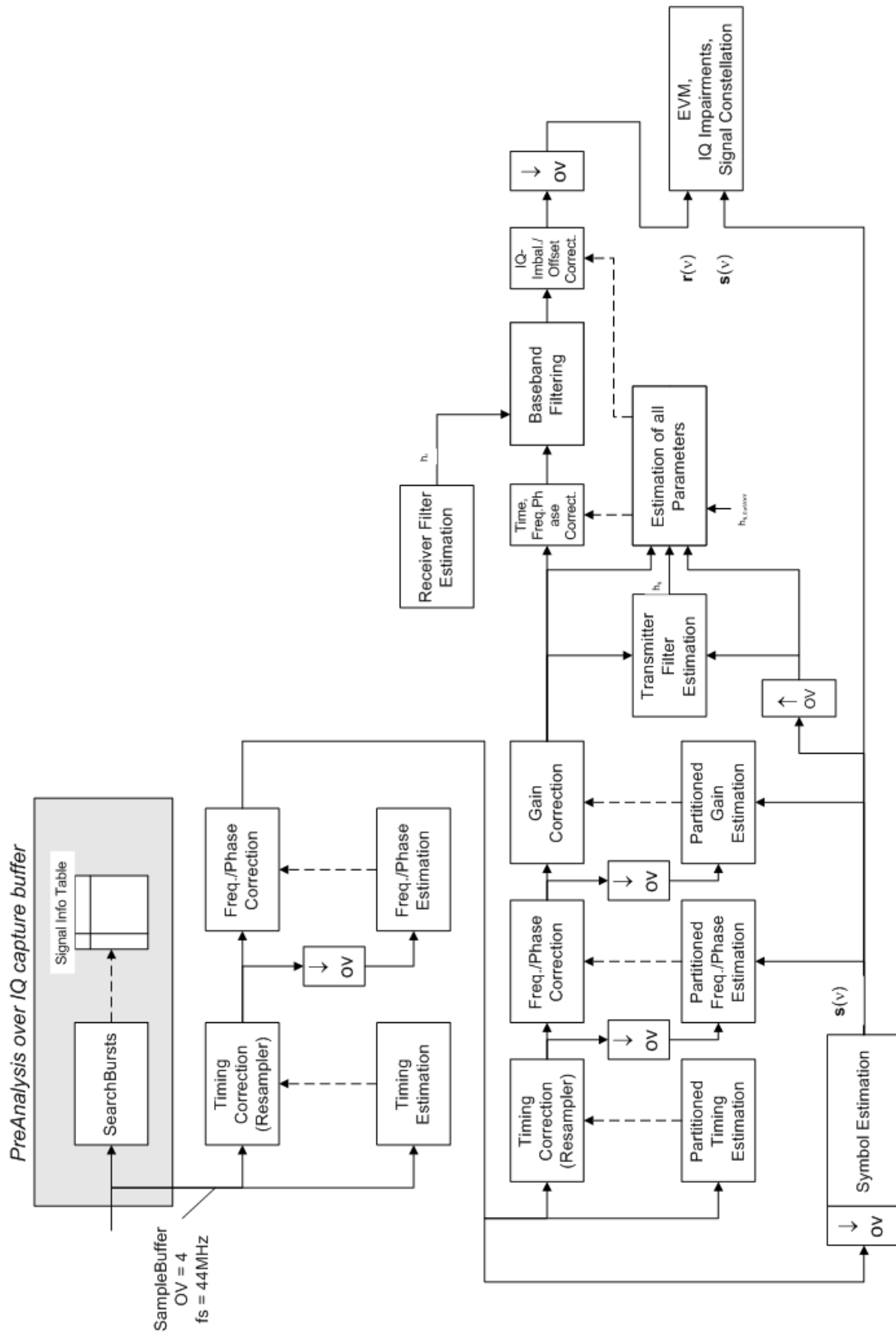

Figure 4-2: Signal processing for IEEE 802.11b or g (DSSS) signals

Once the normalized and undisturbed reference signal is available, the transmit antenna baseband filter (Tx filter) is estimated by minimizing the cost function of a maximum-likelihood-based estimator:

$$L_1 = \sum_{v=0}^{N-1} \left| r(v) \times e^{-j2\pi\Delta\tilde{f}v} \times e^{-j\Delta\tilde{\phi}} - \sum_{i=-L}^{+L} \tilde{h}_s(i) \times \hat{s}_n(v-i) - \tilde{\delta}_i - j\tilde{\delta}_Q \right|^2$$

**Equation 4-9: Transmit antenna baseband filter (Tx filter) estimation**

where:

$r(v)$ : the oversampled measurement signal

$\hat{s}_n(v)$ : the normalized oversampled power of the undisturbed reference signal

$N$ : the observation length

$L$ : the filter length

$\Delta\tilde{f}_v$ : the variation parameters of the frequency offset

$\Delta\tilde{\phi}$ : the variation parameters of the phase offset

$\tilde{\delta}_I \tilde{\delta}_Q$ : the variation parameters of the I/Q offset

$\tilde{h}_s(i)$ : the coefficients of the transmitter filter

## 4.2.2 Calculation of signal parameters

The frequency offset, the phase offset and the IQ-offset are estimated jointly with the coefficients of the transmit filter to increase the estimation quality.

Once the transmit filter is known, all other unknown signal parameters are estimated with a maximum-likelihood-based estimation, which minimizes the cost function:

$$L_2 = \sum_{v=0}^{N-1} \left| r(v - \tilde{\epsilon}) \times e^{-j2\pi\tilde{f}v} \times e^{-j\Delta\tilde{\phi}} - \tilde{g}_I \times s_I(v) - j\tilde{g}_Q \times s_Q(v) + \Delta\tilde{g}_Q \times s_Q(v) - \tilde{\delta}_i - j\tilde{\delta}_Q \right|^2$$

**Equation 4-10: Cost function for signal parameters**

where:

$\tilde{g}_I \tilde{g}_Q$ : the variation parameters of the gain used in the I/Q branch

$\Delta\tilde{g}_Q$ : the crosstalk factor of the Q-branch into the I-branch

$s_I(v) s_Q(v)$ : the filtered reference signal of the I/Q branch

The unknown signal parameters are estimated in a joint estimation process to increase the accuracy of the estimates.

The accurate estimates of the frequency offset, the gain imbalance, the quadrature error and the normalized I/Q offset are displayed by the measurement software.

### Gain imbalance, I/Q offset, quadrature error

The gain imbalance is the quotient of the estimates of the gain factor of the Q-branch, the crosstalk factor and the gain factor of the I-branch:

$$\text{Gain - imbalance} = \left| \frac{\hat{g}_Q + \Delta\hat{g}_Q}{\hat{g}_I} \right|$$

**Equation 4-11: Gain imbalance**

The quadrature error is a measure for the crosstalk of the Q-branch into the I-branch:

$$\text{Quadrature - Error} = \text{ARG} \{ \hat{g}_Q + j \times \Delta\hat{g}_Q \}$$

**Equation 4-12: Quadrature error (crosstalk)**

The normalized I/Q offset is defined as the magnitude of the I/Q offset normalized by the magnitude of the reference signal:

$$\text{IQ - Offset} = \frac{\sqrt{\hat{\sigma}_I^2 + \hat{\sigma}_Q^2}}{\sqrt{\frac{1}{2} \cdot [\hat{g}_I^2 + \hat{g}_Q^2]}}$$

**Equation 4-13: I/Q offset**

At this point of the signal processing all unknown signal parameters such as timing offset, frequency offset, phase offset, I/Q offset and gain imbalance have been evaluated and the measurement signal can be corrected accordingly.

### Error vector magnitude (EVM) - FSW method

Using the corrected measurement signal  $r(v)$  and the estimated reference signal  $\hat{s}(v)$ , the modulation quality parameters can be calculated. The mean error vector magnitude (EVM) is the quotient of the root-mean-square values of the error signal power and the reference signal power:

$$\text{EVM} = \frac{\sqrt{\sum_{v=0}^{N-1} |r(v) - \hat{s}(v)|^2}}{\sqrt{\sum_{v=0}^{N-1} |\hat{s}(v)|^2}}$$

**Equation 4-14: Mean error vector magnitude (EVM)**

Whereas the symbol error vector magnitude is the momentary error signal magnitude normalized by the root mean square value of the reference signal power:

$$\text{EVM}(v) = \frac{|r(v) - \hat{s}(v)|}{\sqrt{\sum_{v=0}^{N-1} |\hat{s}(v)|^2}}$$

**Equation 4-15: Symbol error vector magnitude**

### Error vector magnitude (EVM) - IEEE 802.11b or g (DSSS) method

In [2] a different algorithm is proposed to calculate the error vector magnitude. In a first step the IQ-offset in the I-branch and the IQ-offset of the Q-branch are estimated separately:

$$\hat{\delta}_I = \frac{1}{N} \sum_{v=0}^{N-1} \text{REAL}\{r(v)\}$$

**Equation 4-16: I/Q offset I-branch**

$$\hat{\delta}_Q = \frac{1}{N} \sum_{v=0}^{N-1} \text{IMAG}\{r(v)\}$$

**Equation 4-17: I/Q offset Q-branch**

where  $r(v)$  is the measurement signal which has been corrected with the estimates of the timing offset, frequency offset and phase offset, but not with the estimates of the gain imbalance and I/Q offset

With these values the gain imbalance of the I-branch and the gain imbalance of the Q-branch are estimated in a non-linear estimation in a second step:

$$\hat{g}_I = \frac{1}{N} \sum_{v=0}^{N-1} |\text{REAL}\{r(v) - \hat{\delta}_I\}|$$

**Equation 4-18: Gain imbalance I-branch**

$$\hat{g}_Q = \frac{1}{N} \sum_{v=0}^{N-1} |\text{IMAG}\{r(v) - \hat{\delta}_Q\}|$$

**Equation 4-19: Gain imbalance Q-branch**

Finally, the mean error vector magnitude can be calculated with a non-data-aided calculation:

$$V_{err}(v) = \frac{\sqrt{\frac{1}{2} \sum_{v=0}^{N-1} [|\text{REAL}\{r(v)\} - \hat{\delta}_I - \hat{g}_I|^2 + \frac{1}{2} \sum_{v=0}^{N-1} [|\text{IMAG}\{r(v)\} - \hat{\delta}_Q - \hat{g}_Q|^2]}}{\sqrt{\frac{1}{2} [\hat{g}_I^2 + \hat{g}_Q^2]^2}}$$

**Equation 4-20: Mean error vector magnitude**

The symbol error vector magnitude is the error signal magnitude normalized by the root mean square value of the estimate of the measurement signal power:

$$V_{err}(v) = \frac{\sqrt{\frac{1}{2} [|\text{REAL}\{r(v)\} - \hat{\delta}_I - \hat{g}_I|^2 + \frac{1}{2} [|\text{IMAG}\{r(v)\} - \hat{\delta}_Q - \hat{g}_Q|^2]}}{\sqrt{\frac{1}{2} [\hat{g}_I^2 + \hat{g}_Q^2]^2}}$$

**Equation 4-21: Symbol error vector magnitude**

The advantage of this method is that no estimate of the reference signal is needed, but the I/Q offset and gain imbalance values are not estimated in a joint estimation procedure. Therefore, each estimation parameter disturbs the estimation of the other parameter and the accuracy of the estimates is lower than the accuracy of the estimations achieved by [Transmit antenna baseband filter \(Tx filter\) estimation](#). If the EVM value is dominated by Gaussian noise this method yields similar results as [Cost function for signal parameters](#).



The "EVM vs Symbol" result display shows two traces, each using a different calculation method, so you can easily compare the results (see "EVM vs Symbol" on page 36).

### 4.2.3 Literature on the IEEE 802.11b standard

[1]	Institute of Electrical and Electronic Engineers, Part 11: Wireless LAN Medium Access Control (MAC) and Physical Layer (PHY) specifications, IEEE Std 802.11-1999, Institute of Electrical and Electronic Engineers, Inc., 1999.
[2]	Institute of Electrical and Electronic Engineers, Part 11: Wireless LAN Medium Access Control (MAC) and Physical Layer (PHY) specifications: Higher-Speed Physical Layer Extensions in the 2.4 GHz Band, IEEE Std 802.11b-1999, Institute of Electrical and Electronic Engineers, Inc., 1999.

## 4.3 Signal processing for MIMO measurements (IEEE IEEE 802.11ac, ax, n, be)

For measurements according to the IEEE 802.11a, b, g standards, only a single transmit antenna and a single receive antenna are required (SISO = single in, single out). For measurements according to the IEEE IEEE 802.11ac, ax, n, be standard, the FSW can measure multiple data streams between multiple transmit antennas and multiple receive antennas (MIMO = multiple in, multiple out).



As opposed to other Rohde & Schwarz signal and spectrum analyzers, in the R&S FSW WLAN application, MIMO is not selected as a specific standard. Rather, when you select the IEEE 802.11ac or n standard, MIMO is automatically available. In the default configuration, a single transmit antenna and a single receive antenna are assumed, which corresponds to the common SISO setup.

### Basic technologies

Some basic technologies used in MIMO systems are introduced briefly here.

For more detailed information, see the following application notes, available from the Rohde & Schwarz website:

[1MA142: "Introduction to MIMO"](#)

[1MA192: 802.11ac Technology Introduction](#)

MIMO systems use *transmit diversity* or *space-division multiplexing*, or both. With **transmit diversity**, a bit stream is transmitted simultaneously via two antennas, but with different coding in each case. This improves the signal-to-noise ratio and the cell edge capacity.

For **space-division multiplexing**, multiple (different) data streams are sent simultaneously from the transmit antennas. Each receive antenna captures the superposition of all transmit antennas. In addition, channel effects caused by reflections and scattering etc., are added to the received signals. The receiver determines the originally sent

symbols by multiplying the received symbols with the inverted channel matrix (that is, the mapping between the streams and the transmit antennas, see [Chapter 4.3.2, "Spatial mapping"](#), on page 80).

Using space-division multiplexing, the transmitted data rates can be increased significantly by using additional antennas.

To reduce the correlation between the propagation paths, the transmit antenna can delay all of the transmission signals except one. This method is referred to as *cyclic delay diversity* or **cyclic delay shift**.

The basis of the majority of the applications for broadband transmission is the **OFDM method**. In contrast to single-carrier methods, an OFDM signal is a combination of many orthogonal, separately modulated carriers. Since the data is transmitted in parallel, the symbol length is significantly smaller than in single-carrier methods with identical transmission rates.

### Signal processing chain

In a test setup with multiple antennas, the FSW is likely to receive multiple spatial streams, one from each antenna. Each stream has gone through a variety of transformations during transmission. The signal processing chain is displayed in [Figure 4-3](#), starting with the creation of the spatial streams in the transmitting device, through the wireless transmission and ending with the merging of the spatial streams in the receiving device. This processing chain has been defined by IEEE.

The following figure shows the basic processing steps performed by the transmit antenna and the complementary blocks in reverse order applied at the receive antenna:

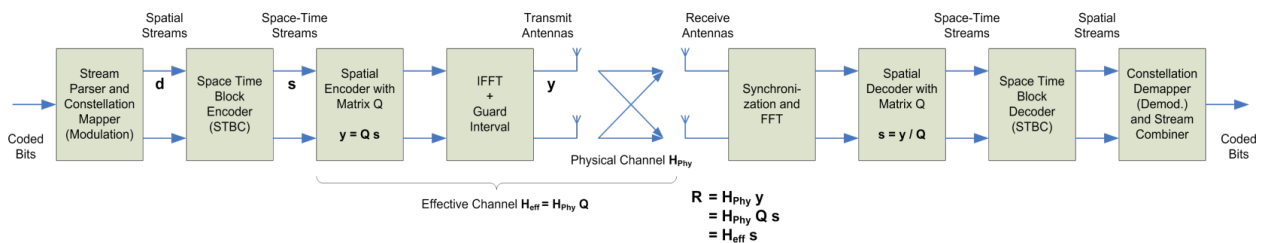

Figure 4-3: Data flow from the transmit antenna to the receive antenna

#### 4.3.1 Space-time block coding (STBC)

The coded bits to be transmitted are modulated to create a data stream, referred to as a *spatial stream*, by the stream parser in the transmitting device under test (see [Figure 4-3](#)).

The Space-Time Block Encoder (STBC) implements the transmit diversity technique (see ["Basic technologies"](#) on page 78). It creates multiple copies of the data streams, each encoded differently, which can then be transmitted by a number of antennas.

To do so, the STBC encodes only the *data* carriers in the spatial stream using a matrix. Each row in the matrix represents an OFDM symbol and each column represents one antenna's transmissions over time (thus the term *space-time encoder*). This means

each block represents the same data, but with a different coding. The resulting blocks are referred to as *space-time streams* (STS). Each stream is sent to a different Tx antenna. This *diversity coding* increases the signal-to-noise ratio at the receive antenna. The *pilot* carriers are inserted after the data carriers went through the STBC. Thus, only the data carriers are decoded by the analyzer to determine characteristics of the demodulated data (see also [Figure 4-6](#)).

In order to transmit the space-time streams, two or more antennas are required by the sender, and one or more antennas are required by the receive antenna.

### 4.3.2 Spatial mapping

The Spatial Encoder (see [Figure 4-3](#)) is responsible for the spatial multiplexing. It defines the mapping between the streams and the transmit antennas - referred to as *spatial mapping* - or as a matrix: the *spatial mapping matrix*.

In the R&S FSW WLAN application, the mapping can be defined using the following methods:

- **Direct mapping:** one single data stream is mapped to an exclusive Tx antenna (The spatial matrix contains "1" on the diagonal and otherwise zeros.)
- **Spatial Expansion:** multiple (different) data streams are assigned to each antenna in a defined pattern
- **User-defined mapping:** the data streams are mapped to the antennas by a user-defined matrix

#### User-defined spatial mapping

You can define your own spatial mapping between streams and Tx antennas.

For each antenna (Tx1..4), the complex element of each STS-stream is defined. The upper value is the real part of the complex element. The lower value is the imaginary part of the complex element.

Additionally, a "Time Shift" can be defined for cyclic delay diversity (CSD).

The stream for each antenna is calculated as:

$$\begin{pmatrix} Tx_1 - Stream \\ \cdot \\ \cdot \\ Tx_4 - Stream \end{pmatrix} = \begin{pmatrix} Tx_1, STS.1 & \cdot & \cdot & Tx_1, STS.4 \\ \cdot & & & \cdot \\ \cdot & & & \cdot \\ Tx_4, STS.1 & \cdot & \cdot & Tx_4, STS.4 \end{pmatrix} \begin{pmatrix} STS - Stream_1 \\ \cdot \\ \cdot \\ STS - Stream_4 \end{pmatrix}$$

### 4.3.3 Physical vs effective channels

The **effective channel** refers to the transmission path starting from the space-time stream and ending at the receive antenna. It is the product of the following components:

- the spatial mapping



## Signal processing for MIMO measurements (IEEE IEEE 802.11ac, ax, n, be)

- the crosstalk inside the device under test (DUT) transmission paths
- the crosstalk of the channel between the transmit antennas and the receive antennas

For each space-time stream, at least one training field (the (V)HT-LTF) is included in every PPDU preamble (see [Figure 4-4](#)). Each sender antenna transmits these training fields, which are known by the receive antenna. The effective channel can be calculated from the received (and known) (V)HT-LTF symbols of the preamble, without knowledge of the spatial mapping matrix or the physical channel. Thus, the effective channel can always be calculated.

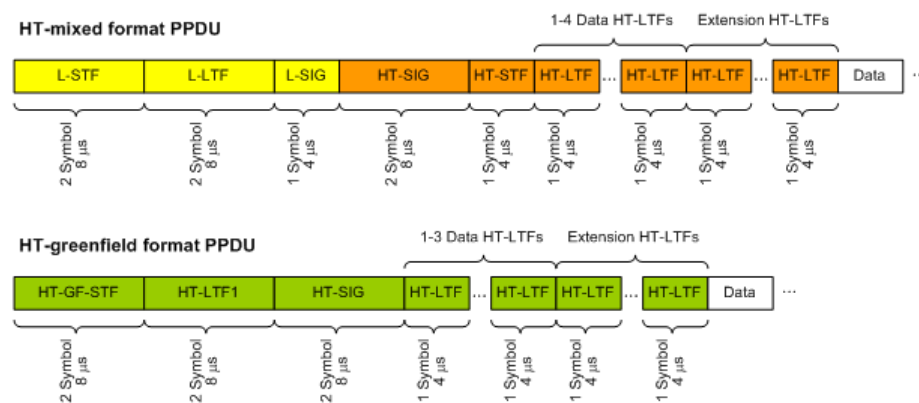

Figure 4-4: Training fields (TF) in the preamble of PPDUs in IEEE 802.11n standard

The effective channel is sufficient to calculate the EVM, the constellation diagram and the bitstream results of the measured signal, so these results are always available.

The **physical channel** refers to the transmission path starting from the transmit antenna streams and ending at the receive antenna. It is the product of the following components:

- the crosstalk inside the device under test (DUT) transmission paths
- the crosstalk of the channel between the transmit antennas and the receive antennas

The physical channel is derived from the effective channel using the inverted spatial mapping matrix  $Q$ :

$$H_{\text{phy}} = H_{\text{eff}}Q^{-1}$$

Thus, if the spatial mapping matrix cannot be inverted, the physical channel cannot be calculated. This may be the case, for example, if the signal contains fewer streams than Rx antenna signals, or if the spatial matrix is close to numerical singularity.

In this case, results that are based on the transmit antenna such as I/Q offset, gain imbalance and quadrature offset are not available.



### Crosstalk in estimated channels

Note that the estimated channel transfer function contains crosstalk from various sources, for example:

- from the transmission paths inside the DUT
- from the connection between the analyzer and the DUT
- from the analyzer itself

The crosstalk from the analyzer can be neglected. If the analyzer and DUT are connected by cable, this source of crosstalk can also be neglected. For further information on crosstalk see [Chapter 4.3.6, "Crosstalk and spectrum flatness"](#), on page 86.

## 4.3.4 Capturing data from MIMO antennas

The primary purpose of many test applications that verify design parameters, or are used in production, is to determine if the transmitted signals adhere to the relevant standards and whether the physical characteristics fall within the specified limits. In such cases there is no need to measure the various transmit paths simultaneously. Instead, they can either be tested as single antenna measurements, or sequentially (with restrictions, see also [Chapter 4.3.4.1, "Sequential MIMO measurement"](#), on page 83). Then only one analyzer is needed to measure parameters such as error vector magnitude (EVM), power and I/Q imbalance.

Measurements that have to be carried out for development or certification testing are significantly more extensive. In order to fully reproduce the data in transmit signals or analyze the crosstalk between the antennas, for example, measurements must be performed simultaneously on all antennas. One analyzer is still sufficient if the system is using transmit diversity (multiple input single output – MISO). However, space-division multiplexing requires two or more analyzers to calculate the precoding matrix and demodulate the signals.

The R&S FSW WLAN application provides the following methods to capture data from the MIMO antennas:

- **Simultaneous MIMO operation**

The data streams are measured simultaneously by multiple analyzers. One of the analyzers is defined as a *primary*, which receives the I/Q data from the other analyzers (the *secondaries*). The IP addresses of each secondary analyzer must be provided to the primary. The only function of the secondaries is to record the data that is then accumulated centrally by the primary.

(Note that only the MIMO primary analyzer requires the R&S FSW-K91n or ac option. The secondary analyzers do not require a R&S FSW WLAN application.) The number of Tx antennas on the DUT defines the number of analyzers required for this measurement setup.

Tip: Use the primary's trigger output (see [Chapter 4.11.5, "Trigger synchronization using the primary's trigger output"](#), on page 102) or an R&S Z11 trigger box (see [Chapter 4.11.6, "Trigger synchronization using an R&S FS-Z11 trigger unit"](#), on page 102) to send the same trigger signal to all devices.

The primary calculates the measurement results based on the I/Q data captured by *all* analyzers (primary and secondaries) and displays them in the selected result displays.

- **Sequential using open switch platform**

The data streams are measured sequentially by a single analyzer connected to an additional switch platform that switches between antenna signals. No manual interaction is necessary during the measurement. The R&S FSW WLAN application captures the I/Q data for all antennas sequentially and calculates and displays the results (individually for each data stream) in the selected result displays automatically.

A single analyzer and the Rohde & Schwarz OSP Switch Platform is required to measure the multiple DUT Tx antennas (the switch platform must be fitted with at least one R&S®OSP-B101 option; the number depends on the number of Tx antennas to measure). The IP address of the OSP and the used module (configuration bank) must be defined on the analyzer; the required connections between the DUT Tx antennas, the switch box and the analyzer are indicated in the MIMO "Signal Capture" dialog box.

For **important restrictions** concerning sequential measurement see [Chapter 4.3.4.1, "Sequential MIMO measurement"](#), on page 83.

- **Sequential using manual operation**

The data streams are captured sequentially by a single analyzer. The antenna signals must be connected to the single analyzer input sequentially by the user.

In the R&S FSW WLAN application, individual capture buffers are provided (and displayed) for each antenna input source, so that results for the individual data streams can be calculated. The user must initiate data capturing for each antenna and result calculation for all data streams manually.

For **important restrictions** concerning sequential measurement see [Chapter 4.3.4.1, "Sequential MIMO measurement"](#), on page 83.

- **Single antenna measurement**

The data from the Tx antenna is measured and evaluated as a single antenna (SISO) measurement ("DUT MIMO configuration" = "1 Tx antenna").

#### 4.3.4.1 Sequential MIMO measurement

Sequential MIMO measurement allows for MIMO analysis with a single analyzer by capturing the receive antennas one after another (sequentially). However, sequential MIMO measurement requires each Tx antenna to transmit **the same PPDU over time**. (The PPDU *content* from different Tx antennas, on the other hand, may be different.) If this requirement can not be fulfilled, use the simultaneous MIMO capture method (see [Chapter 4.3.4, "Capturing data from MIMO antennas"](#), on page 82).

In addition, the following **PPDU attributes must be identical for ALL antennas**:

- PPDU length
- PPDU type
- Channel bandwidth
- MCS Index
- Guard Interval Length
- Number of STBC Streams

Signal processing for MIMO measurements (IEEE IEEE 802.11ac, ax, n, be)

- Number of Extension Streams

Thus, for each PPDU the "Signal Field" bit vector has to be identical for ALL antennas!

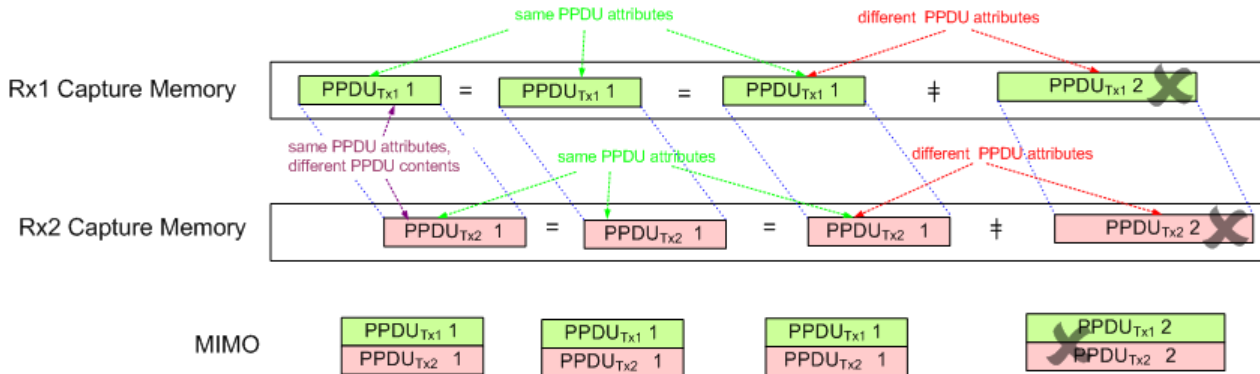

Figure 4-5: Basic principle of "Sequential MIMO Measurement" with 2 receive antennas

Note that, additionally, the data contents of the sent PPDU *payloads* must also be the same for each Tx antenna, but this is not checked. Thus, useless results are returned if different data was sent.



To provide identical PPDU content for each Tx antenna in the measurement, you can use the same pseudo-random bit sequence (PRBS) with the same PRBS seed (initial bit sequence), for example, when generating the useful data for the PPDU.

### 4.3.5 Calculating results

When you analyze a WLAN signal in a MIMO setup, the FSW acts as the receiving device. Since most measurement results have to be calculated at a particular stage in the processing chain, the R&S FSW WLAN application has to do the same decoding that the receive antenna does.

The following diagram takes a closer look at the processing chain and the results at its individual stages.

## Signal processing for MIMO measurements (IEEE IEEE 802.11ac, ax, n, be)

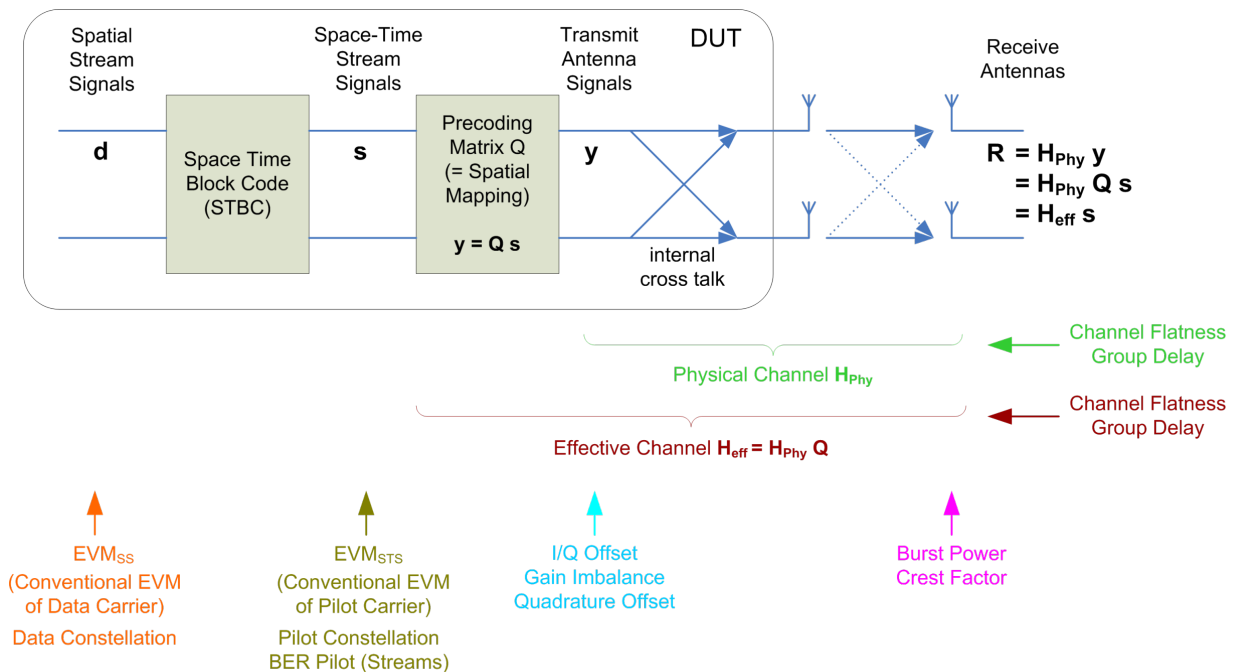

Figure 4-6: Results at individual processing stages

### Receive antenna results

The R&S FSW WLAN application can determine receive antenna results directly from the captured data at the receive antenna, namely:

- PPDU Power
- Crest factor

For all other results, the R&S FSW WLAN application has to revert the processing steps to determine the signal characteristics at those stages.

### Transmit antenna results (based on the physical channel)

If the R&S FSW WLAN application can determine the physical channel (see [Chapter 4.3.3, "Physical vs effective channels"](#), on page 80), it can evaluate the following results:

- "Channel Flatness" (based on the physical channel)
- "Group Delay" (based on the physical channel)
- "I/Q Offset"
- "Quadrature Offset"
- "Gain Imbalance"

### Space-time stream results (based on the effective channel)

If the application knows the effective channel (see [Chapter 4.3.3, "Physical vs effective channels"](#), on page 80), it can evaluate the following results:

- "Channel Flatness" (based on the effective channel)
- "Group Delay" (based on the effective channel)
- "EVM" of pilot carriers
- "Constellation" of pilot carriers
- "Bitstream" of pilot carriers

### Spatial stream results

If space-time encoding is implemented, the demodulated data must first be decoded to determine the following results:

- "EVM" of data carriers
- "Constellation" diagram
- "Bitstream"



The *pilot* carriers are inserted directly after the data carriers went through the STBC (see also [Chapter 4.3.1, "Space-time block coding \(STBC\)"](#), on page 79). Thus, only the data carriers need to be decoded by the analyzer to determine characteristics of the demodulated data. Because of this approach to calculate the "EVM", "Constellation" and "Bitstream" results, you might get results for a different number of streams for pilots and data carriers if STBC is applied.

## 4.3.6 Crosstalk and spectrum flatness

In contrast to the SISO measurements in previous Rohde & Schwarz signal and spectrum analyzers, the spectrum flatness trace is no longer normalized to 0 dB (scaled by the mean gain of all carriers).

For MIMO there may be different gains in the transmission paths and you do not want to lose the relation between these transmission paths. For example, in a MIMO transmission path matrix we have paths carrying power (usually the diagonal elements for the transmitted streams), but also elements with only residual crosstalk power. The power distribution of the transmission matrix depends on the spatial mapping of the transmitted streams. But even if all matrix elements carry power, the gains may be different. This is the reason why the traces are no longer scaled to 0 dB. Although the absolute gain of the "Spectrum Flatness" is not of interest, it is now maintained in order to show the different gains in the transmission matrix elements. Nevertheless, the limit lines are still symmetric to the mean trace, individually for each element of the transmission matrix.

By default, full MIMO equalizing is performed by the R&S FSW WLAN application. However, you can deactivate compensation for crosstalk (see ["Compensate Crosstalk\(MIMO only\)"](#) on page 151). In this case, simple main path equalizing is performed only for direct connections between Tx and Rx antennas, disregarding ancillary trans-

mission between the main paths (crosstalk). This is useful to investigate the effects of crosstalk on results such as EVM.

## 4.4 Signal processing for high-efficiency wireless measurements (IEEE 802.11ax)

The IEEE 802.11ax standard, also known as High Efficiency Wireless (HEW), provides mechanisms to more efficiently utilize the unlicensed spectrum bands (2.4 GHz and 5 GHz) and improve user experience.

It is particularly meant for use in dense environments with large numbers of users (referred to as *stations*) and base stations (referred to as *access points*).

Currently, the specification for this standard is still under development by the IEEE organization. The basic features and processing methods described here and used by the R&S FSW WLAN application are based on the draft version 1.0 from December 2016.

For more information, see also the Rohde & Schwarz White Paper [1MA222: IEEE 802.11ax Technology Introduction](#).

### 4.4.1 Basic signal characteristics

#### PPDU formats

The new 802.11ax standard introduces four new PPDU (Packet Protocol Data Unit) formats:

- **HE SU (Single User) PPDU (HE\_SU)**: used to transmit to a single user
- **HE Extended Range PPDU (HE\_EXT\_SU)**: used to transmit to a single user who is further away from the AP, such as in outdoor scenarios; Only available for 20 MHz channel bandwidths
- **HE MU (Multi-User) PPDU (HE-MU)**: carries one or more transmissions to one or more users
- **HE Trigger-Based PPDU (HE\_Trig)**: carries a single transmission and is sent in response to a trigger frame; Used for OFDMA and/or MU MIMO uplink transmission

#### OFDMA

This new standard allows for the OFDMA method to be employed, where the available channel bandwidth (between 20 MHz and 160 MHz) is divided between multiple users. Each user is assigned a predefined number of subcarriers (also referred to as *tones*). This subset of subcarriers is referred to as a *resource unit (RU)*. RU sizes can vary between 26 subcarriers and (2x) 996 subcarriers. All users transmit their data simultaneously, and each data packet has the same length. However, the resource units used

by the individual users may have different lengths. In other words: each user can use a different number of subcarriers or channel bandwidth.

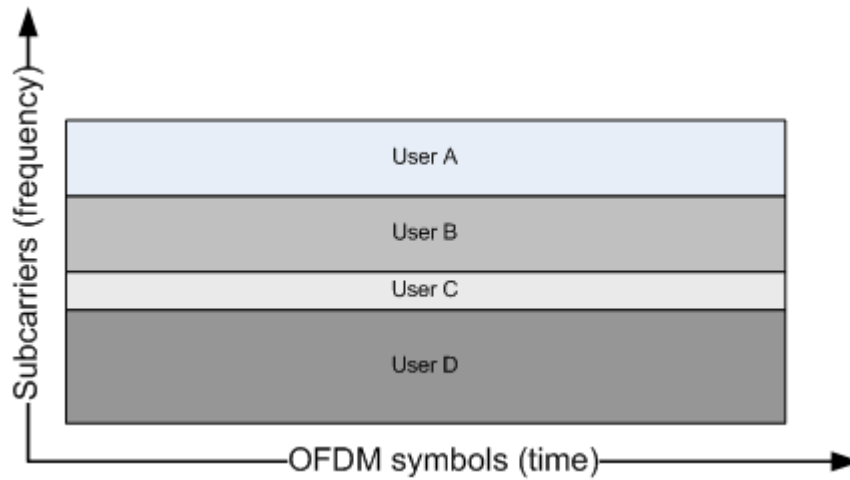

Figure 4-7: OFDMA frequency vs time usage

The OFDMA method provides several advantages versus the OFDM method:

- Flexible bandwidth allocation per user means each user blocks only the frequency range that they need
- Each station can use a different modulation according to the current SNR
- In the time range, less overhead is required

### Resource units (RUs)

Depending on the available channel bandwidth and the size of the used RUs, the following number of resource units are available at the same time:

Table 4-1: Number of RUs depending on channel bandwidth and RU size

Channel bandwidth	20 MHz	40 MHz	80 MHz	160 MHz
RU size (number of subcarriers)				
26	9	18	37	74
52	4	8	16	32
106	2	4	8	16
242	1	2	4	8
484		1	2	4
996			1	2
2*996				1

Each RU in the channel is indexed. Depending on the size of the RU and the available channel bandwidth, the RU index refers to different subcarriers.



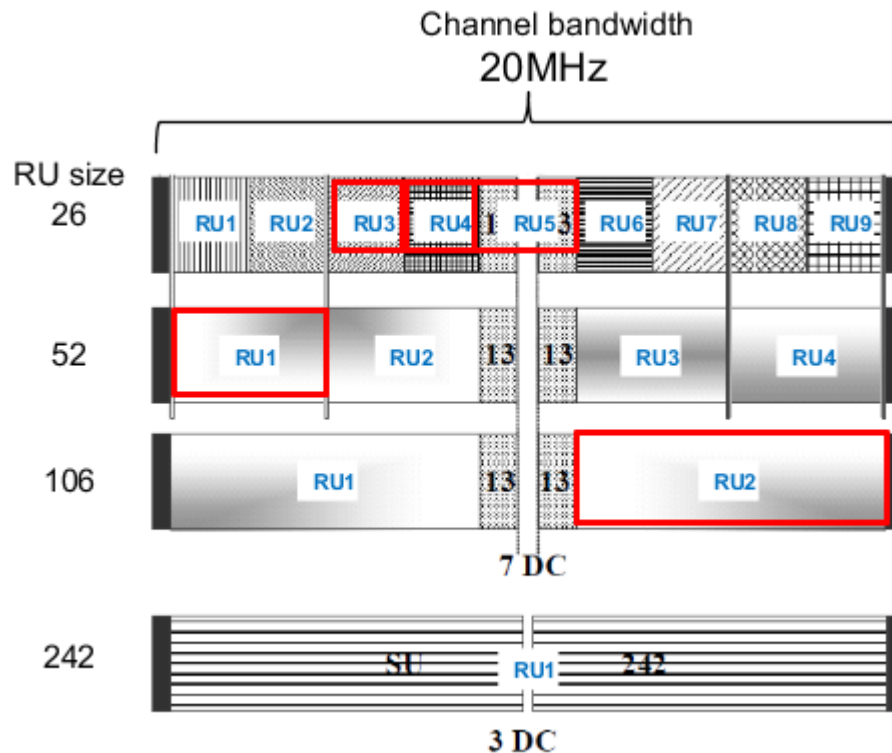

Figure 4-8: Example: RU indexing for 20 MHz channel bandwidth

The available RUs in a channel are assigned to the users sequentially according to the current transmission requirements. Generally, one user is assigned to one RU (for MIMO see "Multi-User (MU-)MIMO" on page 90). Although the RU sizes may vary per user, if both the RU index and the RU size is known, the position of a specific user's RU within the channel is uniquely identifiable.

In [Example: RU indexing for 20 MHz channel bandwidth](#), the RUs indicated by the red boxes are uniquely identifiable by the following information:

Table 4-2: Unique identification of RUs in a channel

User	User 1	User 2	User 3	User 4	User 5
RU size	52	26	26	26 (13+13)	106
RU index	RU1	RU3	RU4	RU5	RU2

### HE Signal fields and PPDU configuration

The combination of RU size and RU indexes for a channel are referred to as the RU allocation. Using 8 bits, each possible combination of RU sizes and positions for a 20 MHz channel (242 subcarriers) can be coded. These codes are defined in the 802.11ax specification.

As all WLAN signals, each HE PPDU contains a signal field (Sig-A) that defines the general PPDU configuration (see also "Signal Field" on page 52). In addition, multi-user PPDUs contain a second signal field (Sig-B) which defines the RU allocation and user assignment. The HE-Sig B field in turn consists of two parts:

Signal processing for high-efficiency wireless measurements (IEEE 802.11ax)

- Common field: contains the RU allocation coding
- User specific field: contains the user ID, MIMO, MCS and coding information

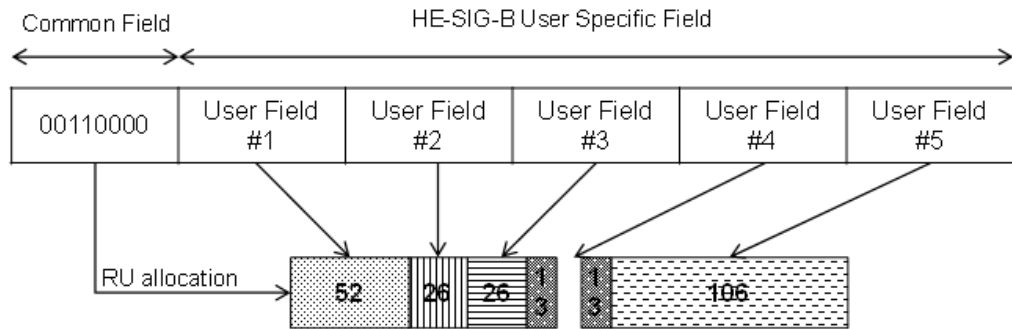

Figure 4-9: HE Sig-B field structure

The HE Sig-B field is a 20 MHz channel that provides the RU allocation for users within a 20 MHz span (242 subcarriers) of the channel. For a 40 MHz channel, two SIG-B channels are required to code the RU allocation for the entire span. For an 80 MHz channel, the common field is extended to 2 x 8 bits, so that the RU allocation of 40 MHz can be coded in one common field (RU1+RU3 or RU2+RU4). Thus, two extended common fields are required to provide the RU allocation information for the entire 80 MHz signal. However, since the 80 MHz signal contains four 20 MHz SIG-B fields, the information in the first two fields is duplicated, and thus redundant:

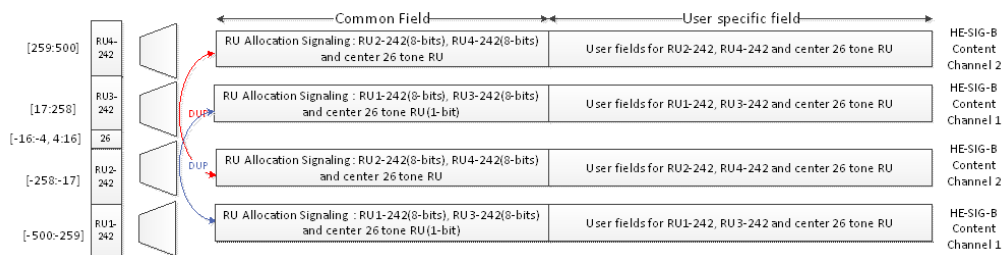

Figure 4-10: HE Sig-B field for 80 MHz channel bandwidth

This coding allows for the receiver to decode only 40 MHz bandwidth and still obtain the RU allocation information for the entire signal.

**Multi-User (MU-)MIMO**

As a rule, each resource unit is assigned to one user (see "Resource units (RUs)" on page 88). However, the 802.11ax standard also supports MIMO mode for HE multi-user PPDUs, both in uplink and downlink transmission. In MIMO mode, each resource unit with a size of 106 subcarriers or more can be assigned to multiple users (8, 16, or 32, depending on the channel bandwidth).

If MIMO is used with HE MU PPDUs, the location of the individual user's data is determined by the station (user) ID and spatial configuration provided in the HE-SIG-B field.

For more information on MIMO see also Chapter 4.3, "Signal processing for MIMO measurements (IEEE IEEE 802.11ac, ax, n, be)", on page 78.

### HE Trigger-based PPDUs

In order for the access point (AP) to decode packets from multiple users, the uplink transmissions need to be synchronized when the AP receives them. After the users receive information from the AP to trigger the uplink transmissions (by a trigger frame), they transmit the HE\_Trig PPDU at a specified time.

The number of users transmitting simultaneously is defined by the high efficiency long training field (HE-LTF). The length of the HE-LTF that the users should use for uplink transmission is defined in the trigger frame sent by the access point. The trigger frame also defines the length of the expected uplink packet.

## 4.4.2 Demodulating 802.11ax signals in the R&S FSW WLAN application

In order to demodulate high-efficiency PPDUs in the R&S FSW WLAN application, the application must have knowledge of the used PPDU format and the PPDU configuration. For multi-user PPDUs, the RU allocation and user assignment are also required.

Depending on the available channel bandwidth, the following multi-user configuration must be defined:

- For channels with 20 MHz bandwidth, only 1 configuration is required (RU1).
- For channels with 40 MHz bandwidth, 2 configurations are required in different tabs (RU1 and RU2).
- For channels with 80 MHz bandwidth, 4 configurations are required, in 4 different tabs (RU1 to RU4), where the contents of RU1 and RU3 are identical, and RU2 and RU4 are identical.
- For channels with 2x80 MHz or 160 MHz bandwidth, 4 configurations are required for each 80-MHz-segment of the channel (Segment 1 and Segment 2).

For single user (HE SU-PPDU) and trigger-based PPDUs (UL), the configuration is detected automatically by the R&S FSW WLAN application. For multi-user downlink PPDUs (HE MU\_PPDU), you must define the configuration manually (see "[HE PPDU Config](#)" on page 161).

For trigger-based PPDUs, you must also define the length of the HE-LTF field in the PPDUs in the R&S FSW WLAN application.

### Result displays for multi-user PPDUs

The result displays show the demodulated data for the selected RUs. The currently displayed RUs are highlighted green in the PPDU configuration table and the result displays. For multi-user configuration, the results cannot be displayed for an individual user. If you select an RU, the rows for all users of the RU are highlighted.

By default, the first RU is selected. To view the results of different RUs, select the RUs in the table by clicking in the first column ("#"), then [Refresh](#).

## 4.5 Signal processing for extremely high throughput (EHT) wireless measurements (IEEE 802.11be)

The IEEE 802.11be standard, also known as extremely high throughput (EHT), provides mechanisms to process data rates over 30 Gbps. In addition, special attention is paid to keeping latency rates low (under 5 ms). It uses the unlicensed spectrum bands at 2.4 GHz, 5 GHz and 6 GHz. The standard aims at remaining compatible to previous standards in the same range. It is particularly meant for use in applications with high data volumes, such as virtual reality, gaming, or videos.

Currently, the specification for this standard is still under development by the IEEE organization. The basic features and processing methods described here and used by the R&S FSW WLAN application are based on the draft version 0.3 from January 2021.

### 4.5.1 Basic signal characteristics

#### PPDU formats

The new 802.11be standard introduces two new PPDU (PHY Protocol Data Unit) formats:

- **EHT MU PPDU:** extremely high throughput multi-user PPDU. This PPDU carries one or more transmissions to one or more users. Only the download PPDU is currently supported for demodulation by the R&S FSW WLAN application.
- **EHT Trigger-Based PPDU (UL):** carries a single transmission and is sent in response to a trigger frame; Used for OFDMA and/or MU MIMO uplink transmission  
Measuring trigger-based PPDUs requires bandwidth information for the signal to be defined by the user.

The physical layer of the 802.11be standard uses some of the same methods as the 802.11ax standard, including OFDMA, resource units, and multi-user MIMO (see [Chapter 4.4, "Signal processing for high-efficiency wireless measurements \(IEEE 802.11ax\)"](#), on page 87). However, to improve the throughput, higher modulation methods are supported, such as 4096QAM. The number of spatial streams is increased to 16. And the channel bandwidth is increased to 320 MHz.

In addition, the 802.11be standard allows for multiple resource units to be assigned to a single user for high throughput requirements.

#### RU allocation

Similar to the 802.11ax standard, resource units are assigned to users in the RU allocation. However, as opposed to the 802.11ax standard, multiple resource units (MRUs) with up to 996 tones = 80 MHz can be assigned to a single user. The MRU allocation is defined in the signal field. To avoid a complex combination of RUs and users, the 802.11be standard defines the following restrictions for RU allocation:

## Signal processing for extremely high throughput (EHT) wireless measurements (IEEE 802.11be)

- Large RUs with 242, 484, or 996 tones can only be combined with other RUs of these sizes.
- Smaller RUs with fewer than 242 tones can only be combined with other small RUs. Not all combinations of small RUs are allowed, see the specification for details.
- Each 80-MHz segment of the RU allocation that is used by a single user (without puncturing) is assigned a single 996-tone RU.
- For all other scenarios, RUs smaller than 996 tones are combined in compliance with the mentioned restrictions.

**Segment puncturing**

Sometimes other services use one or more subcarriers within the same range as a 802.11be standard signal. In this case, these subcarriers cannot be included in the RU allocation. The subcarriers are temporarily blocked in the 80-MHz-segment, which is thus referred to as "punctured". The subcarriers remain unused, while the remaining usable subcarriers are allocated to users as usual. The 802.11be standard defines 12 different configurations of ignored and usable carriers within an 80-MHz-segment. Only those configurations are supported. The used configuration (MRU index) must be defined in the PPDU configuration.

**EHT signal fields**

In addition to the common L-SIG field, the 802.11be standard introduces new signal fields named U-SIG and EHT-SIG to the EHT PPDU. They include version-specific information for the physical layer of the signal.

**Multi-User (MU-)MIMO**

The 802.11be standard also supports MIMO mode for EHT multi-user PPDUs, both in uplink and downlink transmission. In MIMO mode, each resource unit with a size of 106 subcarriers or more can be assigned to multiple users (8, 16, or 32, depending on the channel bandwidth).

If MIMO is used with EHT MU PPDUs, the location of the individual user's data is determined by the station (user) ID and spatial configuration provided in the EHT-SIG-B field.

For more information on MIMO see also [Chapter 4.3, "Signal processing for MIMO measurements \(IEEE IEEE 802.11ac, ax, n, be\)"](#), on page 78.

**EHT Trigger-based PPDUs**

In order for the access point (AP) to decode packets from multiple users, the uplink transmissions need to be synchronized when the AP receives them. After the users receive information from the AP to trigger the uplink transmissions (by a trigger frame), they transmit the EHT\_Trig PPDU at a specified time.

The number of users transmitting simultaneously is defined by the EHT long training field (EHT-LTF). The length of the EHT-LTF that the users should use for uplink transmission is defined in the trigger frame sent by the access point. The trigger frame also defines the length of the expected uplink packet.

### 4.5.2 Demodulating 802.11be signals in the R&S FSW WLAN application

In order to demodulate extremely high throughput (EHT) PPDU in the R&S FSW WLAN application, the application must have knowledge of the used PDU configuration. The RU allocation and user assignment, as well as the MRU assignment, are also required.

Depending on the available channel bandwidth, the following multi-user configuration must be defined:

- For channels with 20 MHz bandwidth, only 1 configuration is required (RU1).
- For channels with 40 MHz bandwidth, 2 configurations are required in different tabs (RU1 and RU2).
- For channels with 80 MHz bandwidth, 4 configurations are required, in 4 different tabs (RU1 to RU4), where the contents of RU1 and RU3 are identical, and RU2 and RU4 are identical.
- For channels with 2x80 MHz or 160 MHz bandwidth, 4 configurations are required for each 80-MHz-segment of the channel (Segment 1 and Segment 2).
- For channels with 320 MHz bandwidth, 4 configurations are required for each 80-MHz-segment of the channel (Segment 1, 2, 3, 4)

For multi-user downlink PPDU (EHT MU PDU), you must define the configuration manually (see ["EHT PDU Config"](#) on page 169).

For trigger-based PPDU, you must also define the length of the EHT-LTF field in the PPDU in the R&S FSW WLAN application.

#### Result displays for multi-user PPDU

The result displays show the demodulated data for the selected RUs. The currently displayed RUs are highlighted green in the PDU configuration table and the result displays. For multi-user configuration, the results cannot be displayed for an individual user. If you select an RU, the rows for all users of the RU are highlighted.

By default, the first RU is selected. To view the results of different RUs, select the RUs in the table by clicking in the first column ("#"), then [Refresh](#).

## 4.6 Channels and carriers

In an OFDM system such as WLAN, the channel is divided into carriers using FFT / IFFT. Depending on the channel bandwidth, the FFT window varies between 64 and 512 (see also [Chapter 4.8, "Demodulation parameters - logical filters"](#), on page 95). Some of these carriers can be used (active carriers), others are inactive (e.g. guard carriers at the edges). The channel can then be determined using the active carriers as known points; inactive carriers are interpolated.

## 4.7 Recognized vs. analyzed PPDU

A PPDU in a WLAN signal consists of the following parts:

(For IEEE 802.11n see also [Figure 4-4](#))

- **Preamble**  
Information required to recognize the PPDU within the signal, for example training fields
- **Signal Field**  
Information on the modulation used for transmission of the useful data
- **Payload**  
The useful data

During signal processing, PPDU are recognized by their preamble symbols. The recognized PPDU and the information on the modulation used for transmission of the useful data are shown in the "Signal Field" result display (see ["Signal Field"](#) on page 52).

Not all of the recognized PPDU are analyzed. Some are dismissed because the PPDU parameters do not match the user-defined demodulation settings, which act as a *logical filter* (see also [Chapter 4.8, "Demodulation parameters - logical filters"](#), on page 95). Others may be dismissed because they contain too many or too few payload symbols (as defined by the user), or due to other irregularities or inconsistency.

Dismissed PPDU are indicated as such in the "Signal Field" result display (highlighted red, with a reason for dismissal).

PPDU with detected inconsistencies are indicated by orange highlighting and a warning in the "Signal Field" result display, but are nevertheless analyzed and included in statistical and global evaluations.

The remaining correct PPDU are highlighted green in the "Magnitude Capture" buffer and "Signal Field" result displays and analyzed according to the current user settings.

### Example:

The evaluation range is configured to take the "Source of Payload Length" from the signal field. If the power period detected for a PPDU deviates from the PPDU length coded in the signal field, a warning is assigned to this PPDU. The decoded signal field length is used to analyze the PPDU. The decoded and measured PPDU length together with the appropriate information is shown in the "Signal Field" result display.

## 4.8 Demodulation parameters - logical filters

The demodulation settings define which PPDU are to be analyzed, thus they define a *logical filter*. They can either be defined using specific values or according to the first measured PPDU.

Which of the WLAN demodulation parameter values are supported depends on the selected digital standard, some are also interdependent.

**Table 4-3: Supported modulation formats, PPDU formats and channel bandwidths depending on standard**

Standard	Modulation formats	PPDU formats	Channel bandwidths
IEEE 802.11a, g (OFDM), j, p	BPSK (6 Mbps & 9 Mbps) QPSK (12 Mbps & 18 Mbps) 16QAM (24 Mbps & 36 Mbps) 64QAM (48 Mbps & 54 Mbps)	Non-HT Short PPDU Long PPDU	2.5 MHz, 5 MHz, 10 MHz, 20 MHz <sup>*)</sup>
IEEE 802.11ac	16QAM 64QAM 256QAM 1024QAM	HT-MF (Mixed format) HT-GF (Greenfield format) VHT NON-HT<Channel Bandwidth>	20 MHz <sup>*)</sup> , 40 MHz <sup>*)</sup> , 80 MHz <sup>*)</sup> , 160 MHz <sup>*)</sup>
IEEE 802.11b, g (DSSS)	DBPSK (1 Mbps) DQPSK (2 Mbps) CCK (5.5 Mbps & 11 Mbps) PBCC (5.5 Mbps & 11 Mbps)	Short PPDU Long PPDU	22 MHz
IEEE 802.11n	<b>SISO:</b> BPSK (6.5, 7.2, 13.5 & 15 Mbps) QPSK (13, 14.4, 19.5, 21.7, 27, 30, 40.5 & 45 Mbps) 16QAM (26, 28.9, 39, 43.3, 54, 60, 81 & 90 Mbps) 64QAM (52, 57.8, 58.5, 65, 72.2, 108, 121.5, 135, 120, 135 & 150 Mbps) <b>MIMO:</b> depends on the MCS index	HT-MF (Mixed format) HT-GF (Greenfield format)	20 MHz <sup>*)</sup> , 40 MHz <sup>*)</sup>
IEEE 802.11ax	BPSK, QPSK, 16QAM, 64QAM, 256QAM, 1024QAM	HE<Channel Bandwidth>SU HE<Channel Bandwidth>MU HE<Channel Bandwidth>EXT HE<Channel Bandwidth>TB (Trigger-based)	20 MHz <sup>*)</sup> , 40 MHz <sup>*)</sup> , 80 MHz <sup>*)</sup> , 160 MHz <sup>*)</sup>

<sup>\*)</sup>: requires FSW bandwidth extension option

See [Chapter A, "Sample rate and maximum usable I/Q bandwidth for RF input"](#), on page 446.



Standard	Modulation formats	PPDU formats	Channel bandwidths
		HE Ext Range SU	20 MHz <sup>*)</sup>
IEEE 802.11be	BPSK, QPSK, 16QAM, 64QAM, 256QAM, 1024QAM, 4096QAM	EHT MU EHT Trigger-Based (TB) EHT non-OFDMA Single User	20 MHz <sup>*)</sup> , 40 MHz <sup>*)</sup> , 80 MHz <sup>*)</sup> , 160 MHz <sup>*)</sup> , 320 MHz <sup>*)</sup>

<sup>\*)</sup>: requires FSW bandwidth extension option  
See [Chapter A, "Sample rate and maximum usable I/Q bandwidth for RF input"](#), on page 446.

## 4.9 I/Q data import and export

Baseband signals mostly occur as so-called complex baseband signals, i.e. a signal representation that consists of two channels; the inphase (I) and the quadrature (Q) channel. Such signals are referred to as I/Q signals. The complete modulation information and even distortion that originates from the RF, IF or baseband domains can be analyzed in the I/Q baseband.

Importing and exporting I/Q signals is useful for various applications:

- Generating and saving I/Q signals in an RF or baseband signal generator or in external software tools to analyze them with the FSW later.  
The FSW supports various I/Q data formats for import.  
For details on formats, see the FSW I/Q Analyzer and I/Q Input user manual.
- Capturing and saving I/Q signals with the FSW to analyze them with the FSW or an external software tool later  
As opposed to storing trace data, which can be averaged or restricted to peak values, I/Q data is stored as it was captured, without further processing. Multi-channel data is not supported.  
The data is stored as complex values in 32-bit floating-point format.  
The file type is determined by the file extension. If no file extension is provided, the file type is assumed to be `.iq.tar`. For `.mat` files, Matlab® v4 is assumed.  
For a detailed description, see the FSW I/Q Analyzer and I/Q Input User Manual.

For example, you can capture I/Q data using the I/Q Analyzer application, if available, and then analyze that data later using the R&S FSW WLAN application.



An application note on converting Rohde & Schwarz I/Q data files is available from the Rohde & Schwarz website:

[1EF85: Converting R&S I/Q data files](#)

The import and export functions are available in the "Save/Recall" menu which is displayed when you select the "Save" or "Open" icon in the toolbar.

See the FSW I/Q Analyzer and I/Q Input User Manual.



### Export only in MSRA mode

In MSRA mode, I/Q data can only be exported to other applications; I/Q data cannot be imported to the MSRA primary or any MSRA secondary applications.

## 4.10 Basics on input from I/Q data files

The I/Q data to be evaluated in a particular FSW application cannot only be captured by the application itself, it can also be loaded from a file, provided it has the correct format. The file is then used as the input source for the application.

For example, you can capture I/Q data using the I/Q Analyzer application, store it to a file, and then analyze the signal parameters for that data later using the AM/FM/PM Modulation Analysis application.

The I/Q data file must be in one of the following supported formats:

- .iq.tar
- .iqw
- .csv
- .mat
- .wv
- .aid



An application note on converting Rohde & Schwarz I/Q data files is available from the Rohde & Schwarz website:

[1EF85: Converting R&S I/Q data files](#)

When importing data from an I/Q data file using the import functions provided by some FSW applications, the data is only stored temporarily in the capture buffer. It overwrites the current measurement data and is in turn overwritten by a new measurement. If you use an I/Q data file as input, the stored I/Q data remains available for any number of subsequent measurements. Furthermore, the (temporary) data import requires the current measurement settings in the current application to match the settings that were applied when the measurement results were stored (possibly in a different application). When the data is used as an input source, however, the data acquisition settings in the current application (attenuation, center frequency, measurement bandwidth, sample rate) can be ignored. As a result, these settings cannot be changed in the current application. Only the measurement time can be decreased, to perform measurements on an extract of the available data (from the beginning of the file) only.

For input files that contain multiple data streams from different channels, you can define which data stream to be used for the currently selected channel in the input settings. You can define whether the data stream is used only once, or repeatedly, to create a larger amount of input data.

When using input from an I/Q data file, the [RUN SINGLE] function starts a single measurement (i.e. analysis) of the stored I/Q data, while the [RUN CONT] function repeatedly analyzes the same data from the file.



### Sample iq.tar files

If you have the optional FSW VSA application (R&S FSW-K70), some sample `iq.tar` files are provided in the `C:\R_S\INSTR\USER\vsa\DemoSignals` directory on the FSW.

### Pre-trigger and post-trigger samples

In applications that use pre-triggers or post-triggers, if no pre-trigger or post-trigger samples are specified in the I/Q data file, or too few trigger samples are provided to satisfy the requirements of the application, the missing pre- or post-trigger values are filled up with zeros. Superfluous samples in the file are dropped, if necessary. For pre-trigger samples, values are filled up or omitted at the beginning of the capture buffer. For post-trigger samples, values are filled up or omitted at the end of the capture buffer.

## 4.11 Trigger basics

In a basic measurement with default settings, the measurement is started immediately. However, sometimes you want the measurement to start only when a specific condition is fulfilled, for example a signal level is exceeded, or in certain time intervals. For these cases, you can define a trigger for the measurement. In FFT sweep mode, the trigger defines when the data acquisition starts for the FFT conversion.

An "Offset" can be defined to delay the measurement after the trigger event, or to include data before the actual trigger event in time domain measurements (pre-trigger offset).

For complex tasks, advanced trigger settings are available:

- Hysteresis to avoid unwanted trigger events caused by noise
- Holdoff to define exactly which trigger event causes the trigger in a jittering signal
- [Trigger offset](#)..... 99
- [Trigger hysteresis](#)..... 100
- [Trigger drop-out time](#)..... 100
- [Trigger holdoff](#)..... 101
- [Trigger synchronization using the primary's trigger output](#)..... 102
- [Trigger synchronization using an R&S FS-Z11 trigger unit](#)..... 102

### 4.11.1 Trigger offset

An offset can be defined to delay the measurement after the trigger event, or to include data before the actual trigger event in time domain measurements (pre-trigger offset). Pre-trigger offsets are possible because the FSW captures data continuously in the time domain, even before the trigger occurs.

See "[Trigger Offset](#)" on page 134.

### 4.11.2 Trigger hysteresis

Setting a hysteresis for the trigger helps avoid unwanted trigger events caused by noise, for example. The hysteresis is a threshold to the trigger level that the signal must fall below on a rising slope or rise above on a falling slope before another trigger event occurs.

#### Example:

In the following example, the signal does not drop below the hysteresis (threshold) before it reaches the trigger level again. Thus, the second possible trigger event on the rising edge is ignored. On the falling edge, however, two trigger events occur. The signal exceeds the hysteresis before it falls to the trigger level the second time.

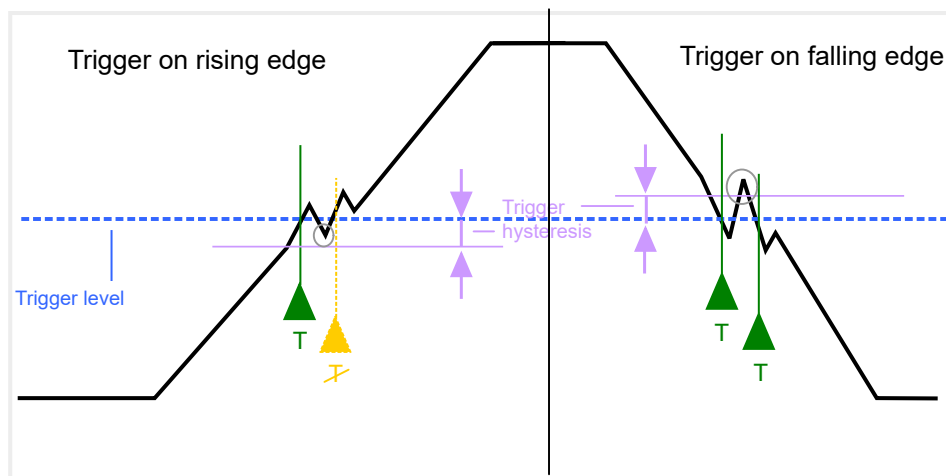

Figure 4-11: Effects of the trigger hysteresis

See "Hysteresis" on page 134

### 4.11.3 Trigger drop-out time

If a modulated signal is instable and produces occasional "drop-outs" during a burst, you can define a minimum duration that the input signal must stay below the trigger level before triggering again. This is called the "drop-out" time. Defining a dropout time helps you stabilize triggering when the analyzer is triggering on undesired events.

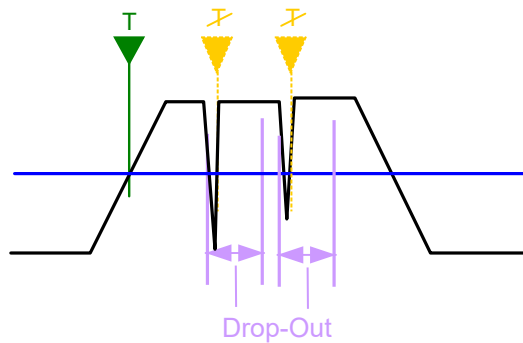

Figure 4-12: Effect of the trigger drop-out time

See "Drop-Out Time" on page 134.



#### Drop-out times for falling edge triggers

If a trigger is set to a falling edge ("Slope" = "Falling", see "Slope" on page 135) the measurement is to start when the power level falls below a certain level. This is useful, for example, to trigger at the end of a burst, similar to triggering on the rising edge for the beginning of a burst.

If a drop-out time is defined, the power level must remain below the trigger level at least for the duration of the drop-out time (as defined above). However, if a drop-out time is defined that is longer than the pulse width, this condition cannot be met before the final pulse. Thus, a trigger event does not occur until the pulsed signal is over.

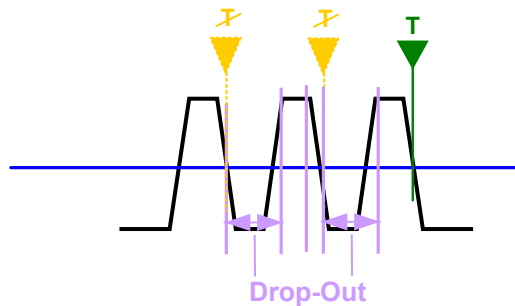

Figure 4-13: Trigger drop-out time for falling edge trigger

For gated measurements, a combination of a falling edge trigger and a drop-out time is generally not allowed.

#### 4.11.4 Trigger holdoff

The trigger holdoff defines a waiting period before the next trigger after the current one will be recognized.

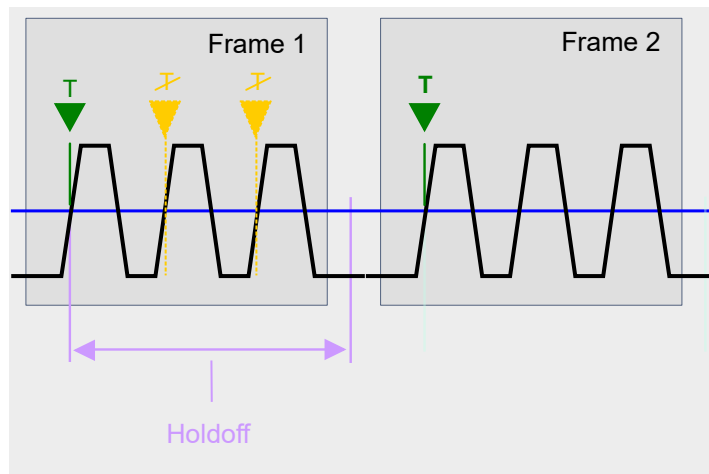

Figure 4-14: Effect of the trigger holdoff

See ["Trigger Holdoff"](#) on page 135.

#### 4.11.5 Trigger synchronization using the primary's trigger output

For MIMO measurements in which the data from the multiple antennas is captured simultaneously by multiple analyzers (see ["Simultaneous Signal Capture Setup"](#) on page 139, the data streams to be analyzed must be synchronized in time. One possibility to ensure that all analyzers start capturing I/Q data at the same time is using the primary's trigger output functionality.

The FSW has variable input/output connectors for trigger signals. If you set the primary's Trigger 2 Input/output connector to "Device Triggered" output, and connect it to the secondaries' trigger input connectors, the primary FSW sends its trigger event signal to any connected secondaries. The secondaries are automatically configured to use the trigger source "External". The primary itself can be configured to use any of the following trigger sources:

- External
- I/Q Power
- IF Power
- RF Power
- Power Sensor

#### 4.11.6 Trigger synchronization using an R&S FS-Z11 trigger unit

For MIMO measurements in which the data from the multiple antennas is captured simultaneously by multiple analyzers (see ["Simultaneous Signal Capture Setup"](#) on page 139, the data streams to be analyzed must be synchronized in time. The R&S FS-Z11 Trigger Unit can ensure that all analyzers start capturing I/Q data at the same time. Compared to using the primary's trigger out function, using the Trigger Unit

provides a more accurate synchronization of the secondaries. However, it requires the additional hardware.

The Trigger Unit is connected to the DUT and all involved analyzers. Then the Trigger Unit can be used in the following operating modes:

- **External mode:** If the DUT has a trigger output, the trigger signal from the DUT triggers all analyzers simultaneously.  
The DUT's TRIGGER OUTPUT is connected to the Trigger Unit's TRIG INPUT connector. Each of the Trigger Unit's TRIG OUT connectors is connected to one of the analyzer's TRIGGER INPUT connectors.
- **Free Run mode:** This mode is used if no trigger signal is available. The primary analyzer sends a trigger impulse to the Trigger Unit to start the measurement as soon as all secondary analyzers are ready to measure.  
The NOISE SOURCE output of the primary analyzer is connected to the Trigger Unit's NOISE SOURCE input. Each of the Trigger Unit's TRIG OUT connectors is connected to one of the analyzer's TRIGGER INPUT connectors. When the primary analyzer sends a signal to the Trigger Unit via its NOISE SOURCE output, the Trigger Unit triggers all analyzers simultaneously via its TRIGGER OUTPUT.
- **Manual mode:** a trigger is generated by the Trigger Unit and triggers all analyzers simultaneously. No connection to the DUT is required.  
Each of the Trigger Unit's TRIG OUT connectors is connected to one of the analyzer's TRIGGER INPUT connectors. A trigger signal is generated when you press (release) [TRIG MANUAL] on the Trigger unit.  
**Note:** In manual mode you must *turn on the NOISE SOURCE output* of the primary analyzer manually (see the manual of the analyzer)!

A Trigger Unit is activated in the [Trigger settings](#). The required connections between the analyzers, the trigger unit, and the DUT are visualized in the dialog box.



The NOISE SOURCE output of the primary analyzer must be connected to the Trigger Unit's NOISE SOURCE input for all operating modes to supply the power for the Trigger Unit.

For more detailed information on the R&S FS-Z11 Trigger Unit and the required connections, see the R&S FS-Z11 Trigger Unit manual.

## 4.12 WLAN I/Q measurements in MSRA operating mode

The R&S FSW WLAN application can also be used to analyze I/Q data in MSRA operating mode.



In MSRA operating mode, the **IEEE 802.11b and g (DSSS)** standards are not supported.

In MSRA operating mode, only the MSRA primary actually captures data; the MSRA applications receive an extract of the captured data for analysis, referred to as the **application data**. For the R&S FSW WLAN application in MSRA operating mode, the

application data range is defined by the same settings used to define the signal capture in Signal and Spectrum Analyzer mode. In addition, a capture offset can be defined, i.e. an offset from the start of the captured data to the start of the analysis interval for the WLAN I/Q measurement.

### Data coverage for each active application

Generally, if a signal contains multiple data channels for multiple standards, separate applications are used to analyze each data channel. Thus, it is of interest to know which application is analyzing which data channel. The MSRA primary display indicates the data covered by each application, restricted to the channel bandwidth used by the corresponding standard, by vertical blue lines labeled with the application name.

### Analysis interval

However, the individual result displays of the application need not analyze the complete data range. The data range that is actually analyzed by the individual result display is referred to as the **analysis interval**.

In the R&S FSW WLAN application the analysis interval is automatically determined according to the selected channel, carrier or PPDU to analyze which is defined for the evaluation range, depending on the result display. The analysis interval can not be edited directly in the R&S FSW WLAN application, but is changed automatically when you change the evaluation range.

### Analysis line

A frequent question when analyzing multi-standard signals is how each data channel is correlated (in time) to others. Thus, an analysis line has been introduced. The analysis line is a common time marker for all MSRA secondary applications. It can be positioned in any MSRA secondary application or the MSRA primary and is then adjusted in all other secondary applications. Thus, you can easily analyze the results at a specific time in the measurement in all secondary applications and determine correlations.

If the analysis interval of the secondary application contains the marked point in time, the line is indicated in all time-based result displays, such as time, symbol, slot or bit diagrams. By default, the analysis line is displayed. However, you can hide it from view manually. In all result displays, the "AL" label in the window title bar indicates whether the analysis line lies within the analysis interval or not:

- **orange "AL"**: the line lies within the interval
- **white "AL"**: the line lies within the interval, but is not displayed (hidden)
- **no "AL"**: the line lies outside the interval

The analysis line is displayed in the following result displays.

- "Magnitude Capture"
- Power vs Time
- "EVM vs Symbol"

For details on the MSRA operating mode see the FSW MSRA User Manual.



## 5 Configuration

The default WLAN I/Q measurement captures the I/Q data from the WLAN signal and determines various characteristic signal parameters such as the modulation accuracy, spectrum flatness, center frequency tolerance and symbol clock tolerance in just one measurement (see [Chapter 3.1, "WLAN I/Q measurement \(modulation accuracy, flatness and tolerance\)"](#), on page 15)

Other parameters specified in the WLAN 802.11 standard must be determined in separate measurements (see [Chapter 5.4, "Frequency sweep measurements"](#), on page 199).

The settings required to configure each of these measurements are described here.

### Selecting the measurement type

► To select a different measurement type, do one of the following:

- Select "Overview". In the "Overview", select "Select Measurement". Select the required measurement.
- Press [MEAS]. In the "Select Measurement" dialog box, select the required measurement.

• <a href="#">Multiple measurement channels and sequencer function</a> .....	105
• <a href="#">Display configuration</a> .....	107
• <a href="#">WLAN I/Q measurement configuration</a> .....	107
• <a href="#">Frequency sweep measurements</a> .....	199

### 5.1 Multiple measurement channels and sequencer function

When you activate an application, a new measurement channel is created which determines the measurement settings for that application. These settings include the input source, the type of data to be processed (I/Q or RF data), frequency and level settings, measurement functions etc. If you want to perform the same measurement but with different center frequencies, for instance, or process the same input data with different measurement functions, there are two ways to do so:

- Change the settings in the measurement channel for each measurement scenario. In this case the results of each measurement are updated each time you change the settings and you cannot compare them or analyze them together without storing them on an external medium.
- Activate a new measurement channel for the same application. In the latter case, the two measurement scenarios with their different settings are displayed simultaneously in separate tabs, and you can switch between the tabs to compare the results.

For example, you can activate one WLAN measurement channel to perform a WLAN modulation accuracy measurement, and a second channel to perform an

## Multiple measurement channels and sequencer function

SEM measurement using the same WLAN input source. Then you can monitor all results at the same time in the "MultiView" tab.

The number of channels that can be configured at the same time depends on the available memory on the instrument.

Only one measurement can be performed on the FSW at any time. If one measurement is running and you start another, or switch to another channel, the first measurement is stopped. In order to perform the different measurements you configured in multiple channels, you must switch from one tab to another.

However, you can enable a Sequencer function that automatically calls up each activated measurement channel in turn. This means the measurements configured in the channels are performed one after the other in the order of the tabs. The currently active measurement is indicated by a  symbol in the tab label. The result displays of the individual channels are updated in the corresponding tab (as well as the "Multi-View") as the measurements are performed. Sequencer operation is independent of the currently *displayed* tab; for example, you can analyze the SEM measurement while the modulation accuracy measurement is being performed by the Sequencer.

For details on the Sequencer function see the FSW User Manual.

The Sequencer functions are only available in the "MultiView" tab.

<a href="#">Sequencer State</a> .....	106
<a href="#">Sequencer Mode</a> .....	106

### Sequencer State

Activates or deactivates the Sequencer. If activated, sequential operation according to the selected Sequencer mode is started immediately.

Remote command:

[SYSTEM:SEQuencer](#) on page 371

[INITiate:SEQuencer:IMMediate](#) on page 370

[INITiate:SEQuencer:ABORt](#) on page 370

### Sequencer Mode

Defines how often which measurements are performed. The currently selected mode softkey is highlighted blue. During an active Sequencer process, the selected mode softkey is highlighted orange.

"Single Sequence"

Each measurement is performed once, until all measurements in all active channels have been performed.

"Continuous Sequence"

The measurements in each active channel are performed one after the other, repeatedly, in the same order, until sequential operation is stopped.

This is the default Sequencer mode.

Remote command:

[INITiate:SEQuencer:MODE](#) on page 370

## 5.2 Display configuration

The measurement results can be displayed using various evaluation methods. All evaluation methods available for the FSW WLAN application are displayed in the evaluation bar in SmartGrid mode when you do one of the following:

- Select  "SmartGrid" from the toolbar.
- Select "Display Config" in the "Overview".
- Select "Display Config" in any WLAN menu.

Then you can drag one or more evaluations to the display area and configure the layout as required.

Up to 16 evaluation methods can be displayed simultaneously in separate windows. The WLAN evaluation methods are described in [Chapter 3, "Measurements and result displays"](#), on page 15.

To close the SmartGrid mode and restore the previous softkey menu select  "Close" in the righthand corner of the toolbar, or press any key.



For details on working with the SmartGrid see the FSW Getting Started manual.

## 5.3 WLAN I/Q measurement configuration

**Access:** [MODE] > "WLAN 802.11"

WLAN 802.11 measurements require a special application on the FSW.

When you activate the R&S FSW WLAN application, an I/Q measurement of the input signal is started automatically with the default configuration. The "WLAN" menu is displayed and provides access to the most important configuration functions.



The "Span", "Bandwidth", "Lines", and "Marker Functions" menus are not available for WLAN I/Q measurements.



### Multiple access paths to functionality

The easiest way to configure a measurement channel is via the "Overview" dialog box. Alternatively, you can access the individual dialog boxes from the corresponding menu items, or via tools in the toolbars, if available.

In this documentation, only the most convenient method of accessing the dialog boxes is indicated - usually via the "Overview".

- [Configuration overview](#).....108
- [Signal description](#)..... 110
- [Input and frontend settings](#)..... 111
- [Signal capture \(data acquisition\)](#)..... 127

- [Secondary application data \(MSRA\)](#)..... 145
- [Synchronization and OFDM demodulation](#)..... 145
- [Tracking and channel estimation](#)..... 146
- [Demodulation](#)..... 151
- [Evaluation range](#)..... 183
- [Result configuration](#)..... 189
- [Automatic settings](#)..... 196
- [Sweep settings](#)..... 197

### 5.3.1 Configuration overview



**Access:** all menus

Throughout the measurement channel configuration, an overview of the most important currently defined settings is provided in the "Overview".

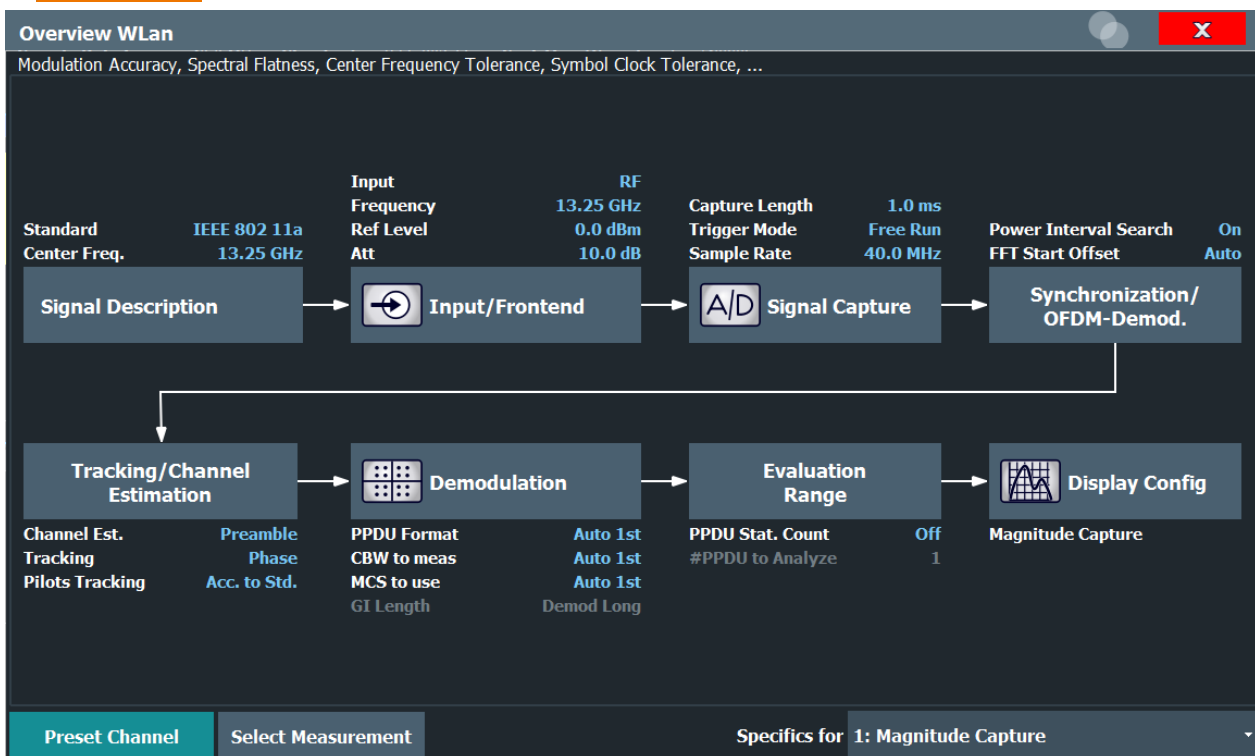

The "Overview" not only shows the main measurement settings, it also provides quick access to the main settings dialog boxes. The indicated signal flow shows which parameters affect which processing stage in the measurement. Thus, you can easily configure an entire measurement channel from input over processing to output and analysis by stepping through the dialog boxes as indicated in the "Overview".



The available settings and functions in the "Overview" vary depending on the currently selected measurement. For frequency sweep measurements see [Chapter 5.4, "Frequency sweep measurements"](#), on page 199.

For the WLAN I/Q measurement, the "Overview" provides quick access to the following configuration dialog boxes (listed in the recommended order of processing):

1. "Select Measurement"  
See ["Selecting the measurement type"](#) on page 105
2. "Signal Description"  
See [Chapter 5.3.2, "Signal description"](#), on page 110
3. "Input/ Frontend"  
See [Chapter 5.3.3, "Input and frontend settings"](#), on page 111
4. "Signal Capture"  
See [Chapter 5.3.4, "Signal capture \(data acquisition\)"](#), on page 127
5. "Synchronization / OFDM demodulation"  
See [Chapter 5.3.6, "Synchronization and OFDM demodulation"](#), on page 145
6. "Tracking / Channel Estimation"  
See [Chapter 5.3.7, "Tracking and channel estimation"](#), on page 146
7. "Demodulation"  
See [Chapter 5.3.8, "Demodulation"](#), on page 151
8. "Evaluation Range"  
See [Chapter 5.3.9, "Evaluation range"](#), on page 183
9. "Display Configuration"  
See [Chapter 5.2, "Display configuration"](#), on page 107

#### To configure settings

- ▶ Select any button in the "Overview" to open the corresponding dialog box.

#### Preset Channel

Select "Preset Channel" in the lower left-hand corner of the "Overview" to restore all measurement settings *in the current channel* to their default values.

**Note:** Do not confuse "Preset Channel" with the [Preset] key, which restores the entire instrument to its default values and thus closes *all channels* on the FSW (except for the default channel)!

Remote command:

[SYSTem:PRESet:CHANnel \[:EXEC\]](#) on page 228

#### Select Measurement

Selects a measurement to be performed.

See ["Selecting the measurement type"](#) on page 105.

#### Specific Settings for

The channel can contain several windows for different results. Thus, the settings indicated in the "Overview" and configured in the dialog boxes vary depending on the selected window.

Select an active window from the "Specific Settings for" selection list that is displayed in the "Overview" and in all window-specific configuration dialog boxes.

The "Overview" and dialog boxes are updated to indicate the settings for the selected window.

### 5.3.2 Signal description

**Access:** "Overview" > "Signal Description"

**Or:** [MEAS CONFIG] > "Signal Description"

The signal description provides information on the expected input signal.

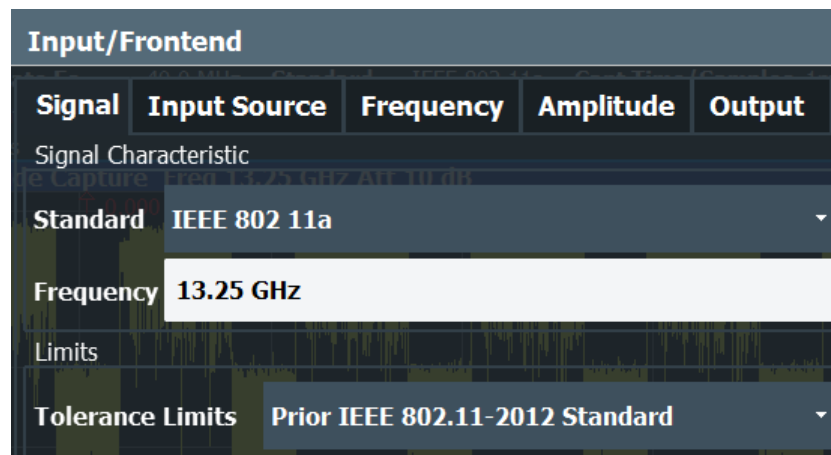

Standard.....	110
Frequency.....	110
Tolerance Limit.....	111
Standard Version for Error Vector Magnitude (IEEE 802.11b and g (DSSS) only).....	111

#### Standard

Defines the WLAN standard (depending on which WLAN options are installed). The measurements are performed according to the specified standard with the correct limit values and limit lines.

Many other WLAN measurement settings depend on the selected standard (see [Chapter 4.8, "Demodulation parameters - logical filters"](#), on page 95).

**Note:** In MSRA operating mode, the **IEEE 802.11b and g (DSSS)** standards are not supported.

Remote command:

[CONFigure:STANdard](#) on page 236

#### Frequency

Specifies the center frequency of the signal to be measured.

Remote command:

[\[SENSe:\]FREQuency:CENTer](#) on page 264

**Tolerance Limit**

Defines the tolerance limit to be used for the measurement. The required tolerance limit depends on the used standard:

"Prior IEEE 802.11-2012 Standard"

Tolerance limits are based on the IEEE 802.11 specification **prior to 2012**.

Default for OFDM standards (except 802.11ac).

"In line with IEEE 802.11-2012 Standard"

Tolerance limits are based on the IEEE 802.11 specification from **2012**.

Required for DSSS standards. Also possible for OFDM standards (except 802.11ac).

"In line with IEEE 802.11ac standard"

Tolerance limits are based on the **IEEE 802.11ac** specification.

Required by IEEE 802.11ac standard.

"In line with IEEE 802.11ax/D0.1"

Tolerance limits are based on the **IEEE 802.11ax** specification (draft).

Required by IEEE 802.11ax standard.

"In line with IEEE 802.11be/D0.1"

Tolerance limits are based on the **IEEE 802.11be** specification (draft).

Required by IEEE 802.11be standard.

Remote command:

[CALCulate<n>:LIMit<li>:TOLerance](#) on page 237

**Standard Version for Error Vector Magnitude (IEEE 802.11b and g (DSSS) only)**

Defines the standard version to be used for the EVM measurement:

"In line with IEEE 802.11b-1999"

EVM measurement based on the IEEE 802.11b specification **prior to 2012**.

"In line with IEEE 802.11b-2012"

EVM measurement based on the IEEE 802.11b specification from **2012**.

"In line with IEEE 802.11b-2016"

EVM measurement based on the **IEEE 802.11b** specification from **2016**.

Remote command:

[CONFigure:BURSt:EVM:STANdard](#) on page 238

**5.3.3 Input and frontend settings**

**Access:** "Overview" > "Input/Frontend"

**Or:** [MEAS CONFIG] > "Input/Frontend"

The FSW can analyze signals from different input sources and provide various types of output (such as noise or trigger signals).



### Importing and Exporting I/Q Data

The I/Q data to be analyzed for WLAN 802.11 can not only be measured by the R&S FSW WLAN application itself, it can also be imported to the application, provided it has the correct format. Furthermore, the analyzed I/Q data from the R&S FSW WLAN application can be exported for further analysis in external applications.

For details, see the FSW I/Q Analyzer and I/Q Input User Manual.

Frequency, amplitude and y-axis scaling settings represent the "frontend" of the measurement setup.

- [Input source settings](#)..... 112
- [Output settings](#)..... 117
- [Frequency settings](#)..... 118
- [Amplitude settings](#)..... 120
- [Y-axis scaling](#)..... 126

#### 5.3.3.1 Input source settings

**Access:** "Overview" > "Input/Frontend" > "Input Source"

The input source determines which data the FSW will analyze.

The default input source for the FSW is "Radio Frequency", i.e. the signal at the "RF Input" connector of the FSW. If no additional options are installed, this is the only available input source.



#### Further input sources

The R&S FSW WLAN application can also process input from the following optional sources:

- I/Q Input files
- External mixer
- "Digital Baseband" interface (FSW-B17)
- "Analog Baseband" interface (FSW-B71)
- Probes

For details, see the FSW I/Q Analyzer and I/Q Input User Manual.



The Digital I/Q input source is currently not available in the R&S FSW WLAN application.

- [Radio frequency input](#)..... 112
- [Settings for input from I/Q data files](#)..... 116

#### Radio frequency input

**Access:** "Overview" > "Input/Frontend" > "Input Source" > "Radio Frequency"



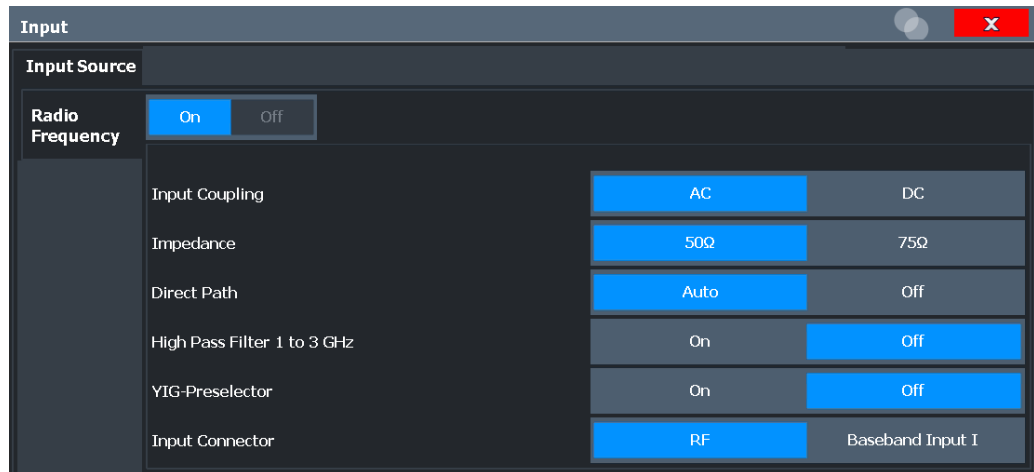

**RF Input Protection**

The RF input connector of the FSW must be protected against signal levels that exceed the ranges specified in the specifications document. Therefore, the FSW is equipped with an overload protection mechanism for DC and signal frequencies up to 30 MHz. This mechanism becomes active as soon as the power at the input mixer exceeds the specified limit. It ensures that the connection between RF input and input mixer is cut off.

When the overload protection is activated, an error message is displayed in the status bar ("INPUT OVLD"), and a message box informs you that the RF input was disconnected. Furthermore, a status bit (bit 3) in the `STAT:QUES:POW` status register is set. In this case, you must decrease the level at the RF input connector and then close the message box. Then measurement is possible again. Reactivating the RF input is also possible via the remote command `INPut:ATTenuation:PROTection:RESet`.

Radio Frequency State..... 113  
 Input Coupling..... 114  
 Impedance..... 114  
 Direct Path..... 114  
 High Pass Filter 1 to 3 GHz..... 115  
 YIG-Preselector..... 115  
 Input Connector..... 115

**Radio Frequency State**

Activates input from the "RF Input" connector.

For FSW85 models with two input connectors, you must define which input source is used for each measurement channel.

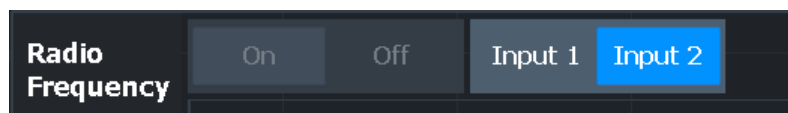

"Input 1" 1.00 mm RF input connector for frequencies up to 85 GHz (90 GHz with option R&S FSW-B90G)

"Input 2" 1.85 mm RF input connector for frequencies up to 67 GHz

Remote command:

[INPut:SElect](#) on page 241

[INPut:TYPE](#) on page 242

### Input Coupling

The RF input of the FSW can be coupled by alternating current (AC) or direct current (DC).

Not available for input from the optional "Analog Baseband" interface.

Not available for input from the optional "Digital Baseband" interface.

AC coupling blocks any DC voltage from the input signal. AC coupling is activated by default to prevent damage to the instrument. Very low frequencies in the input signal can be distorted.

However, some specifications require DC coupling. In this case, you must protect the instrument from damaging DC input voltages manually. For details, refer to the specifications document.

Remote command:

[INPut:COUPling](#) on page 239

### Impedance

For some measurements, the reference impedance for the measured levels of the FSW can be set to 50  $\Omega$  or 75  $\Omega$ .

Select 75  $\Omega$  if the 50  $\Omega$  input impedance is transformed to a higher impedance using a 75  $\Omega$  adapter of the RAZ type. (That corresponds to 25  $\Omega$  in series to the input impedance of the instrument.) The correction value in this case is 1.76 dB = 10 log (75 $\Omega$ /50 $\Omega$ ).

Not available for input from the optional "Digital Baseband" interface.

Not available for input from the optional "Analog Baseband" interface. For analog baseband input, an impedance of 50  $\Omega$  is always used.

Remote command:

[INPut:IMPedance](#) on page 241

### Direct Path

Enables or disables the use of the direct path for small frequencies.

In spectrum analyzers, passive analog mixers are used for the first conversion of the input signal. In such mixers, the LO signal is coupled into the IF path due to its limited isolation. The coupled LO signal becomes visible at the RF frequency 0 Hz. This effect is referred to as LO feedthrough.

To avoid the LO feedthrough the spectrum analyzer provides an alternative signal path to the A/D converter, referred to as the *direct path*. By default, the direct path is selected automatically for RF frequencies close to zero. However, this behavior can be disabled. If "Direct Path" is set to "Off", the spectrum analyzer always uses the analog mixer path.

"Auto" (Default) The direct path is used automatically for frequencies close to zero.

"Off" The analog mixer path is always used.

Remote command:

`INPut:DPATH` on page 240

### High Pass Filter 1 to 3 GHz

Activates an additional internal highpass filter for RF input signals from 1 GHz to 3 GHz. This filter is used to remove the harmonics of the analyzer to measure the harmonics for a DUT, for example.

This function requires an additional hardware option.

**Note:** For RF input signals outside the specified range, the high-pass filter has no effect. For signals with a frequency of approximately 4 GHz upwards, the harmonics are suppressed sufficiently by the YIG-preselector, if available.)

Remote command:

`INPut:FILTer:HPASs[:STATe]` on page 240

### YIG-Preselector

Enables or disables the YIG-preselector.

An internal YIG-preselector at the input of the FSW ensures that image frequencies are rejected. However, the YIG-preselector can limit the bandwidth of the I/Q data and adds some magnitude and phase distortions. You can check the impact in the "Spectrum Flatness" and "Group Delay" result displays.

**Note:** Note that the YIG-preselector is active only on frequencies greater than 8 GHz. Therefore, switching the YIG-preselector on or off has no effect if the frequency is below that value.

To use the optional 90 GHz frequency extension (R&S FSW-B90G), the YIG-preselector must be disabled.

The "YIG-Preselector" is off by default.

Remote command:

`INPut:FILTer:YIG[:STATe]` on page 240

### Input Connector

Determines which connector the input data for the measurement is taken from.

For more information on the optional "Analog Baseband" interface, see the FSW I/Q Analyzer and I/Q Input user manual.

"RF"	(Default:) The "RF Input" connector
"RF Probe"	The "RF Input" connector with an adapter for a modular probe This setting is only available if a probe is connected to the "RF Input" connector.
"Baseband Input I"	The optional "Baseband Input I" connector This setting is only available if the optional "Analog Baseband" interface is installed and active for input. It is not available for the FSW67. For FSW85 models with two input connectors, this setting is only available for "Input 1".

Remote command:

`INPut:CONNector` on page 239

### Settings for input from I/Q data files

**Access:** "Overview" > "Input/Frontend" > "Input Source" > "I/Q File"

**Or:** [INPUT/OUTPUT] > "Input Source Config" > "Input Source" > "I/Q File"

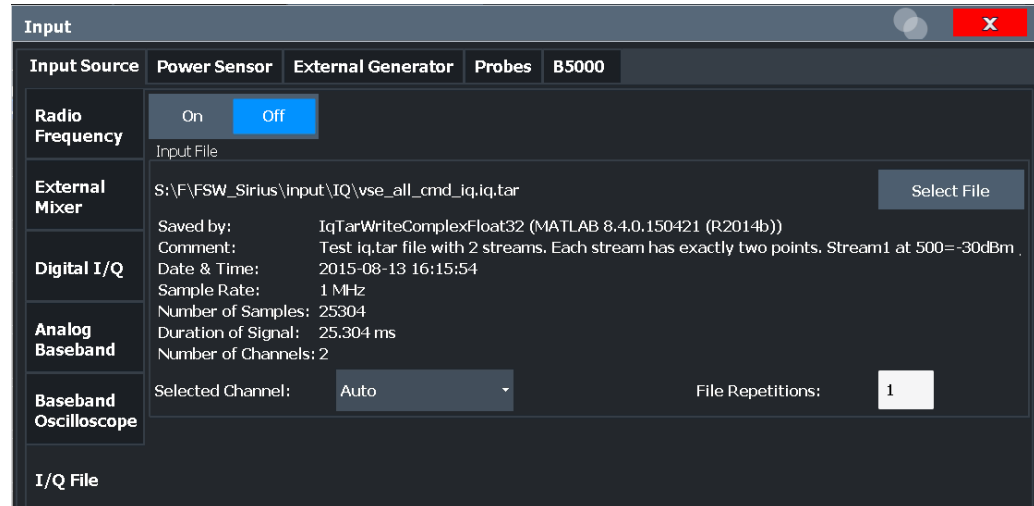

For details, see the FSW I/Q Analyzer and I/Q Input user manual.

<a href="#">I/Q Input File State</a> .....	116
<a href="#">Select I/Q data file</a> .....	116
<a href="#">Selected Channel</a> .....	117
<a href="#">File Repetitions</a> .....	117

### I/Q Input File State

Enables input from the selected I/Q input file.

If enabled, the application performs measurements on the data from this file. Thus, most measurement settings related to data acquisition (attenuation, center frequency, measurement bandwidth, sample rate) cannot be changed. The measurement time can only be decreased to perform measurements on an extract of the available data only.

**Note:** Even when the file input is disabled, the input file remains selected and can be enabled again quickly by changing the state.

Remote command:

[INPut:SElect](#) on page 241

### Select I/Q data file

Opens a file selection dialog box to select an input file that contains I/Q data.

The I/Q data file must be in one of the following supported formats:

- .iq.tar
- .iqw
- .csv
- .mat
- .wv
- .aid

For details on formats, see the FSW I/Q Analyzer and I/Q Input user manual.

The file type is determined by the file extension. If no file extension is provided, the file type is assumed to be `.iq.tar`. For `.mat` files, Matlab® v4 is assumed.

**Note:** Only a single data stream or channel can be used as input, even if multiple streams or channels are stored in the file.

**Note:** For some file formats that do not provide the sample rate and measurement time or record length, you must define these parameters manually. Otherwise the traces are not visible in the result displays.

The default storage location for I/Q data files is `C:\R_S\INSTR\USER`.

Remote command:

[INPut:FILE:PATH](#) on page 261

### Selected Channel

Only available for files that contain more than one data stream from multiple channels: selects the data stream to be used as input for the currently selected channel.

In "Auto" mode (default), the first data stream in the file is used as input for the channel. Applications that support multiple data streams use the first data stream in the file for the first input stream, the second for the second stream etc.

Remote command:

[MMEMory:LOAD:IQ:STReam](#) on page 262

[MMEMory:LOAD:IQ:STReam:AUTO](#) on page 262

[MMEMory:LOAD:IQ:STReam:LIST?](#) on page 262

### File Repetitions

Determines how often the data stream is repeatedly copied in the I/Q data memory to create a longer record. If the available memory is not sufficient for the specified number of repetitions, the largest possible number of complete data streams is used.

Remote command:

[TRACe:IQ:FILE:REPetition:COUNT](#) on page 263

#### 5.3.3.2 Output settings

**Access:** [Input/Output] > "Output"

The FSW can provide output to special connectors for other devices.

For details on connectors, refer to the FSW Getting Started manual, "Front / Rear Panel View" chapters.



How to provide trigger signals as output is described in detail in the FSW base unit user manual.

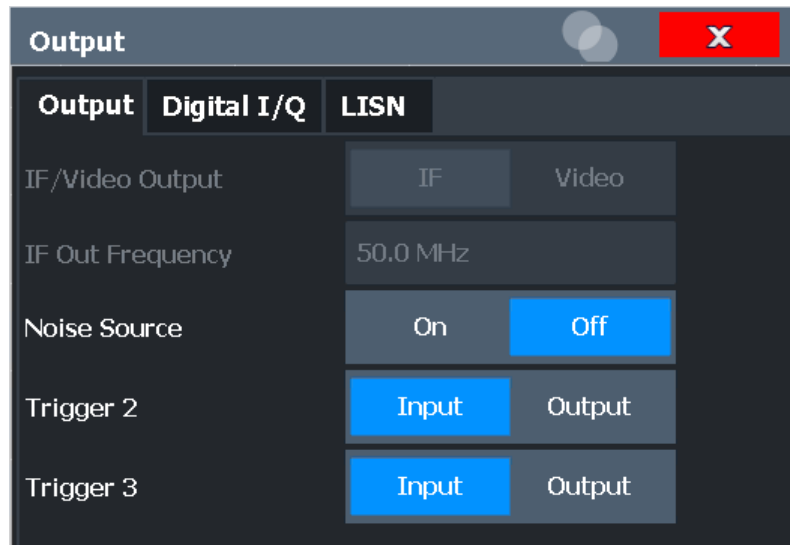

Noise Source Control..... 118

#### Noise Source Control

Enables or disables the 28 V voltage supply for an external noise source connected to the "Noise source control / Power sensor") connector. By switching the supply voltage for an external noise source on or off in the firmware, you can enable or disable the device as required.

External noise sources are useful when you are measuring power levels that fall below the noise floor of the FSW itself, for example when measuring the noise level of an amplifier.

In this case, you can first connect an external noise source (whose noise power level is known in advance) to the FSW and measure the total noise power. From this value, you can determine the noise power of the FSW. Then when you measure the power level of the actual DUT, you can deduct the known noise level from the total power to obtain the power level of the DUT.

Remote command:

[DIAGnostic:SERvice:NSource](#) on page 263

#### 5.3.3.3 Frequency settings

**Access:** "Overview" > "Input/Frontend" > "Frequency"

Center Frequency.....	119
Center Frequency Stepsize.....	119
Frequency Offset.....	119

### Center Frequency

Defines the center frequency of the signal in Hertz.

Remote command:

[\[SENSe:\] FREQuency: CENTer](#) on page 264

### Center Frequency Stepsize

Defines the step size by which the center frequency is increased or decreased using the arrow keys.

When you use the rotary knob the center frequency changes in steps of only 1/10 of the span.

The step size can be coupled to another value or it can be manually set to a fixed value.

"= Center" Sets the step size to the value of the center frequency. The used value is indicated in the "Value" field.

"Manual" Defines a fixed step size for the center frequency. Enter the step size in the "Value" field.

Remote command:

[\[SENSe:\] FREQuency: CENTer: STEP](#) on page 264

### Frequency Offset

Shifts the displayed frequency range along the x-axis by the defined offset.

This parameter has no effect on the instrument's hardware, on the captured data, or on data processing. It is simply a manipulation of the final results in which absolute frequency values are displayed. Thus, the x-axis of a spectrum display is shifted by a constant offset if it shows absolute frequencies. However, if it shows frequencies relative to the signal's center frequency, it is not shifted.

A frequency offset can be used to correct the display of a signal that is slightly distorted by the measurement setup, for example.

The allowed values range from -1 THz to 1 THz. The default setting is 0 Hz.

**Note:** In MSRA mode, this function is only available for the MSRA primary.

Remote command:

[SENSe:] FREQuency: OFFSet on page 265

### 5.3.3.4 Amplitude settings

**Access:** "Overview" > "Input/Frontend" > "Amplitude"

Amplitude settings determine how the FSW must process or display the expected input power levels.

For Analog Baseband input, see the slightly different amplitude settings described in the FSW I/Q Analyzer and I/Q Input User Manual.

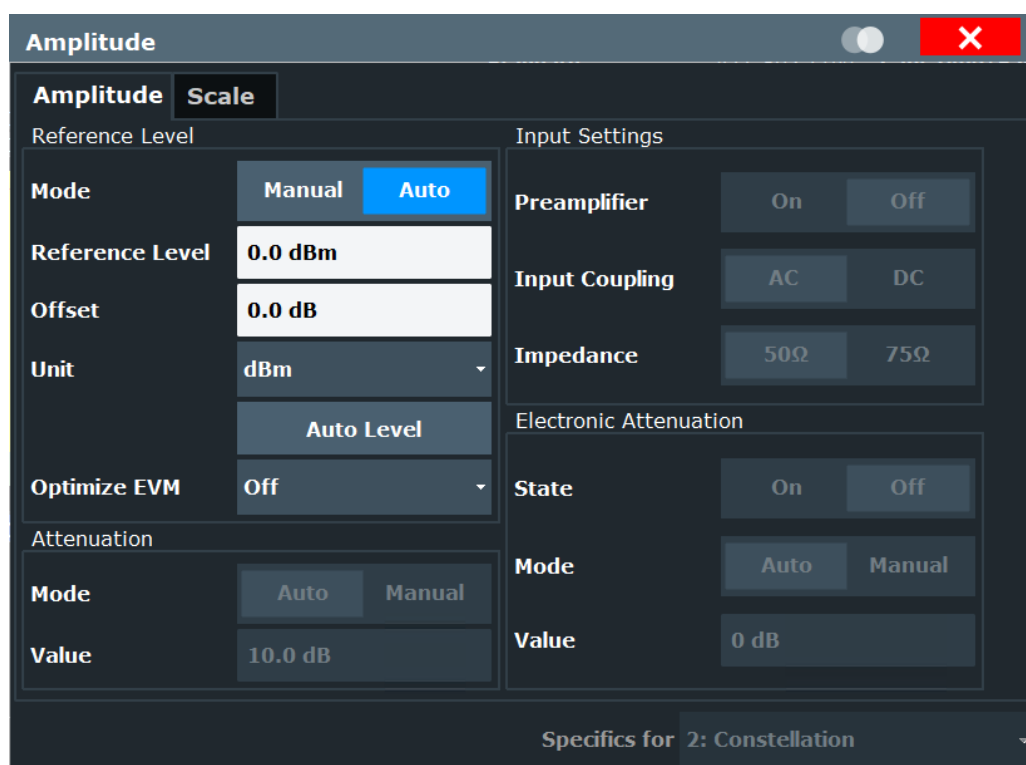

Reference Level Settings.....	121
L Reference Level Mode.....	121
L Reference Level.....	121
L Shifting the Display (Offset).....	121
L Unit.....	122
L Setting the Reference Level Automatically (Auto Level).....	122
L Optimize EVM.....	122
RF Attenuation.....	122
L Attenuation Mode / Value.....	122
Optimization.....	123
Signal Path.....	123
Using Electronic Attenuation.....	124



Input Settings.....	124
L Preamplifier.....	124
L Input Coupling.....	125
L Impedance.....	125
L Ext. PA Correction.....	125

### Reference Level Settings

The reference level defines the expected maximum signal level. Signal levels above this value may not be measured correctly, which is indicated by the "IF OVLD" status display.

#### Reference Level Mode ← Reference Level Settings

By default, the reference level is automatically adapted to its optimal value for the current input data (continuously). At the same time, the internal attenuators and the pre-amplifier are adjusted so the signal-to-noise ratio is optimized, while signal compression, clipping and overload conditions are minimized.

In order to define the reference level manually, switch to "Manual" mode. In this case you must define the following reference level parameters.

If [Optimize EVM](#) is enabled, the reference level mode is automatically set to "Manual".

Remote command:

CONF:POW:AUTO ON, see [CONFigure:POWer:AUTO](#) on page 267

#### Reference Level ← Reference Level Settings

Defines the expected maximum signal level. Signal levels above this value may not be measured correctly, which is indicated by the "IF OVLD" status display.

This value is overwritten if "Auto Level" mode is turned on.

Remote command:

DISPlay[:WINDow<n>][:SUBWindow<w>]:TRACe<t>:Y[:SCALe]:RLEVel  
on page 268

#### Shifting the Display (Offset) ← Reference Level Settings

Defines an arithmetic level offset. This offset is added to the measured level irrespective of the selected unit. The scaling of the y-axis is changed accordingly.

Define an offset if the signal is attenuated or amplified before it is fed into the FSW so the application shows correct power results. All displayed power level results will be shifted by this value.

Note, however, that the [Reference Level](#) value ignores the "Reference Level Offset". It is important to know the actual power level the FSW must handle.

To determine the required offset, consider the external attenuation or gain applied to the input signal. A positive value indicates that an attenuation took place (FSW increases the displayed power values), a negative value indicates an external gain (FSW decreases the displayed power values).

The setting range is  $\pm 200$  dB in 0.01 dB steps.

Remote command:

DISPlay[:WINDow<n>][:SUBWindow<w>]:TRACe<t>:Y[:SCALe]:RLEVel:  
OFFSet on page 269

**Unit ← Reference Level Settings**

The FSW measures the signal voltage at the RF input.

Remote command:

[INPut:IMPedance](#) on page 241

[CALCulate<n>:UNIT:POWer](#) on page 266

**Setting the Reference Level Automatically (Auto Level) ← Reference Level Settings**

Automatically determines the optimal reference level for the current input data. At the same time, the internal attenuators and the preamplifier are adjusted so the signal-to-noise ratio is optimized, while signal compression, clipping and overload conditions are minimized.

In order to do so, a level measurement is performed to determine the optimal reference level.

Note that for sample rates larger than 160 MHz and active B1200 or B2001 bandwidth extension options, auto leveling is not available.

Remote command:

[\[SENSe:\]ADJust:LEVel](#) on page 340

**Optimize EVM ← Reference Level Settings**

Defines whether an optional iterative search is performed to determine the required settings for minimum residual EVM. If enabled, the required reference level, preamplifier and, optionally, attenuation are configured. The [Reference Level Mode](#) is set to "Manual".

**Note:** The R&S FSW WLAN application must be configured correctly to measure and demodulate the signal, otherwise optimization does not work.

"Off" (Default): No optimization performed

"Full" An optional iterative search for minimum residual EVM is performed for the available preamplifier and attenuation settings. The optimal settings are configured.

"PA only" An optional iterative search for minimum residual EVM is performed, but only the available preamplifier settings are considered during the search. The optimal settings are configured.

Remote command:

[CONFigure:POWer:AUTO:OEVM](#) on page 267

**RF Attenuation**

Defines the attenuation applied to the RF input.

This function is not available for input from the "Digital Baseband" interface (FSW-B17).

**Attenuation Mode / Value ← RF Attenuation**

Defines the attenuation applied to the RF input of the FSW.

This function is not available for input from the optional "Digital Baseband" interface.

The RF attenuation can be set automatically as a function of the selected reference level (Auto mode). Automatic attenuation ensures that no overload occurs at the RF Input connector for the current reference level. It is the default setting.

By default and when no (optional) [electronic attenuation](#) is available, mechanical attenuation is applied.

This function is not available for input from the optional **"Digital Baseband" interface**.

In "Manual" mode, you can set the RF attenuation in 1 dB steps (down to 0 dB). Other entries are rounded to the next integer value. The range is specified in the specifications document. If the defined reference level cannot be set for the defined RF attenuation, the reference level is adjusted accordingly and the warning "limit reached" is displayed.

**NOTICE!** Risk of hardware damage due to high power levels. When decreasing the attenuation manually, ensure that the power level does not exceed the maximum level allowed at the RF input, as an overload can lead to hardware damage.

Remote command:

[INPut:ATTenuation](#) on page 269

[INPut:ATTenuation:AUTO](#) on page 269

### Optimization

Selects the priority for signal processing *after* the RF attenuation has been applied.

This function is only available under the following conditions:

- Bandwidth extension FSW-B160/-B320 Extension Board 1, Revision 2 or higher, FSW-B512, or the real-time option FSW-B160R is installed (these options provide a separate wideband processing path in the FSW)
- A sample rate higher than 320 MHz is used (only in this case the wideband path is used)
- The optional "Digital Baseband" interface is not active

"Low distortion"      Optimized for low distortion by avoiding intermodulation

"Low noise"      (Default:) Optimized for high sensitivity and low noise levels  
If this setting is selected, "Low noise" is indicated in the channel information bar.

Remote command:

[INPut:ATTenuation:AUTO:MODE](#) on page 270

### Signal Path

Selects the signal path for signal processing.

"Narrowband"      (Default:) The narrowband signal path is used.

"Wideband"      The wideband signal path is used. With this setting, the dynamic range for EVM measurements is increased.

This function is only available under the following conditions:

- Instrument models FSW50/67/85
- One of the following bandwidth extension options is installed:
  - R&S FSW-B1200
  - R&S FSW-B2001
  - R&S FSW-B800R

- An I/Q bandwidth between 80 MHz and 512 MHz is used.
- The center frequency is higher than 43.5 GHz.
- The optional "Digital Baseband" interface is not active.

Remote command:

[\[SENSe:\] IQ:WBAND](#) on page 273

### Using Electronic Attenuation

If the (optional) Electronic Attenuation hardware is installed on the FSW, you can also activate an electronic attenuator.

In "Auto" mode, the settings are defined automatically; in "Manual" mode, you can define the mechanical and electronic attenuation separately.

This function is not available for input from the optional "**Digital Baseband**" interface.

**Note:** Electronic attenuation is not available for stop frequencies (or center frequencies in zero span) above 15 GHz.

In "Auto" mode, RF attenuation is provided by the electronic attenuator as much as possible to reduce the amount of mechanical switching required. Mechanical attenuation can provide a better signal-to-noise ratio, however.

When you switch off electronic attenuation, the RF attenuation is automatically set to the same mode (auto/manual) as the electronic attenuation was set to. Thus, the RF attenuation can be set to automatic mode, and the full attenuation is provided by the mechanical attenuator, if possible.

The electronic attenuation can be varied in 1 dB steps. If the electronic attenuation is on, the mechanical attenuation can be varied in 5 dB steps. Other entries are rounded to the next lower integer value.

For the FSW85, the mechanical attenuation can be varied only in 10 dB steps.

If the defined reference level cannot be set for the given attenuation, the reference level is adjusted accordingly and the warning "limit reached" is displayed in the status bar.

Remote command:

[INPut:EATT:STATe](#) on page 271

[INPut:EATT:AUTO](#) on page 270

[INPut:EATT](#) on page 270

### Input Settings

Some input settings affect the measured amplitude of the signal, as well.

The parameters "Input Coupling" and "Impedance" are identical to those in the "Input" settings.

### Preamplicifier ← Input Settings

If the (optional) internal preamplicifier hardware is installed on the FSW, a preamplicifier can be activated for the RF input signal.

You can use a preamplicifier to analyze signals from DUTs with low output power.

**Note:** If an optional external preamplicifier is activated, the internal preamplicifier is automatically disabled, and vice versa.

This function is not available for input from the (optional) "Digital Baseband" interface.

For all FSW models except for FSW85, the following settings are available:

"Off"	Deactivates the preamplifier.
"15 dB"	The RF input signal is amplified by about 15 dB.
"30 dB"	The RF input signal is amplified by about 30 dB.

For older FSW43/FSW50/FSW67 models, the input signal is always amplified by about 30 dB when the preamplifier is active.

For FSW85 models, no preamplifier is available.

Remote command:

[INPut:GAIN:STATe](#) on page 272

[INPut:GAIN\[:VALue\]](#) on page 272

### Input Coupling ← Input Settings

The RF input of the FSW can be coupled by alternating current (AC) or direct current (DC).

Not available for input from the optional "Analog Baseband" interface.

Not available for input from the optional "Digital Baseband" interface.

AC coupling blocks any DC voltage from the input signal. AC coupling is activated by default to prevent damage to the instrument. Very low frequencies in the input signal can be distorted.

However, some specifications require DC coupling. In this case, you must protect the instrument from damaging DC input voltages manually. For details, refer to the specifications document.

Remote command:

[INPut:COUPling](#) on page 239

### Impedance ← Input Settings

For some measurements, the reference impedance for the measured levels of the FSW can be set to 50  $\Omega$  or 75  $\Omega$ .

Select 75  $\Omega$  if the 50  $\Omega$  input impedance is transformed to a higher impedance using a 75  $\Omega$  adapter of the RAZ type. (That corresponds to 25 $\Omega$  in series to the input impedance of the instrument.) The correction value in this case is 1.76 dB = 10 log (75 $\Omega$ /50 $\Omega$ ).

Not available for input from the optional "Digital Baseband" interface.

Not available for input from the optional "Analog Baseband" interface. For analog baseband input, an impedance of 50  $\Omega$  is always used.

Remote command:

[INPut:IMPedance](#) on page 241

### Ext. PA Correction ← Input Settings

This function is only available if an external preamplifier is connected to the FSW, and only for frequencies above 1 GHz. For details on connection, see the preamplifier's documentation.

Using an external preamplifier, you can measure signals from devices under test with low output power, using measurement devices which feature a low sensitivity and do not have a built-in RF preamplifier.

When you connect the external preamplifier, the FSW reads out the touchdown (.S2P) file from the EEPROM of the preamplifier. This file contains the s-parameters of the preamplifier. As soon as you connect the preamplifier to the FSW, the preamplifier is permanently on and ready to use. However, you must enable data correction based on the stored data explicitly on the FSW using this setting.

When enabled, the FSW automatically compensates the magnitude and phase characteristics of the external preamplifier in the measurement results. Any internal preamplifier, if available, is disabled.

For FSW85 models with two RF inputs, you can enable correction from the external preamplifier for each input individually, but not for both at the same time.

When disabled, no compensation is performed even if an external preamplifier remains connected.

Remote command:

`INPut:EGAIN[:STATe]` on page 271

### 5.3.3.5 Y-axis scaling

**Access:** "Overview" > "Amplitude" > "Scale" tab

The individual scaling settings that affect the vertical axis are described here. These settings are window-specific.

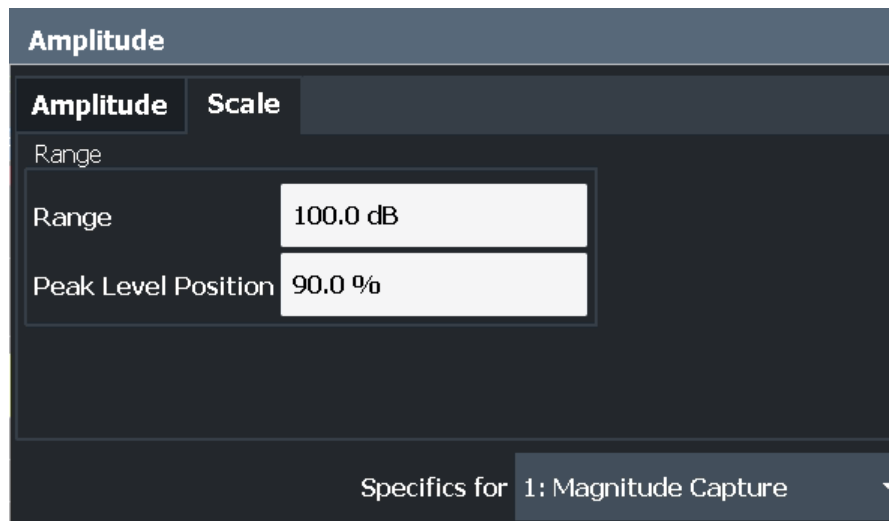

[Range](#).....126  
[Ref Level Position](#)..... 127

#### Range

Defines the displayed y-axis range in dB.

The default value is 100 dB.

Remote command:

`DISPlay[:WINDow<n>][:SUBWindow<w>]:TRACe<t>:Y[:SCALe]` on page 273

#### Ref Level Position

Defines the reference level position, i.e. the position of the maximum AD converter value on the level axis in %.

0 % corresponds to the lower and 100 % to the upper limit of the diagram.

Values from -120 % to +280 % are available.

Larger values are useful for small scales, such as a power range of 10 dB or 20 dB, and low signal levels, for example 60 dB below the reference level. In this case, large reference level position values allow you to see the trace again.

Remote command:

`DISPlay[:WINDow<n>][:SUBWindow<w>]:TRACe<t>:Y[:SCALe]:RPOSition` on page 274

### 5.3.4 Signal capture (data acquisition)

**Access:** "Overview" > "Signal Capture"

**Or:** [MEAS CONFIG] > "Signal Capture"

You can define how much and how data is captured from the input signal.



#### MSRA operating mode

In MSRA operating mode, only the MSRA primary channel actually captures data from the input signal. The data acquisition settings for the R&S FSW WLAN application in MSRA mode define the **application data extract**. See [Chapter 5.3.5, "Secondary application data \(MSRA\)"](#), on page 145.

For details on the MSRA operating mode see the FSW MSRA User Manual.

- [General capture settings](#)..... 127
- [Trigger settings](#)..... 130
- [Optimization](#)..... 136
- [MIMO capture settings](#)..... 137

#### 5.3.4.1 General capture settings

**Access:** "Overview" > "Signal Capture" > "Signal Capture" tab

**Or:** [MEAS CONFIG] > "Signal Capture" > "Signal Capture" tab

The general capture settings define how much and which data is to be captured during the WLAN I/Q measurement.

The screenshot shows a configuration window for 'Signal Capture'. It has a title bar 'Signal Capture' and a sub-header 'Signal Capture'. Below this, there are four main settings:

- Input Sample Rate:** A dropdown menu currently showing '40 MHz'.
- Capture Time:** A text input field containing '1.0 ms'.
- Swap I/Q:** Two buttons, 'On' and 'Off', with 'Off' selected.
- Filter:** A section header followed by 'Filter out Adjacent Channels' with 'On' and 'Off' buttons, where 'On' is selected.

Input Sample Rate.....	128
Capture Time.....	128
Capture Offset.....	128
Swap I/Q.....	129
Suppressing (Filter out) Adjacent Channels (IEEE 802.11a, ac, ax, g (OFDM), j, n, p, be).....	129
Transmit Filter(IEEE 802.11b, g (DSSS)).....	129
Receive Filter (IEEE 802.11b, g (DSSS)).....	129
Equalizer Filter Length (IEEE 802.11b, g (DSSS)).....	129

### Input Sample Rate

This is the sample rate the R&S FSW WLAN application expects the I/Q input data to have. If necessary, the FSW has to resample the data.

During data processing in the FSW, the sample rate usually changes (decreases). The RF input is captured by the FSW using a high sample rate, and is resampled before it is processed by the R&S FSW WLAN application.

Remote command:

[TRACe: IQ: SRATe](#) on page 277

### Capture Time

Specifies the duration (and therefore the amount of data) to be captured in the capture buffer. If the capture time is too short, demodulation will fail. In particular, if the result length does not fit in the capture buffer, demodulation will fail.

Remote command:

[\[SENSe:\] SWEep: TIME](#) on page 277

### Capture Offset

This setting is only available for secondary applications in **MSRA operating mode**. It has a similar effect as the trigger offset in other measurements: it defines the time offset between the capture buffer start and the start of the extracted secondary application data.

In MSRA mode, the offset must be a positive value, as the capture buffer starts at the trigger time = 0.



For details on the MSRA operating mode, see the [R&S®FSW MSRA Mode User Manual](#).

Remote command:

[\[SENSe:\]MSRA:CAPTURE:OFFSet](#) on page 342

### Swap I/Q

Activates or deactivates the inverted I/Q modulation. If the I and Q parts of the signal from the DUT are interchanged, the FSW can do the same to compensate for it.

On	I and Q signals are interchanged Inverted sideband, $Q+j*I$
Off	I and Q signals are not interchanged Normal sideband, $I+j*Q$

Remote command:

[\[SENSe:\]SWAPiq](#) on page 276

### Suppressing (Filter out) Adjacent Channels (IEEE 802.11a, ac, ax, g (OFDM), j, n, p, be)

If activated (default), only the useful signal is analyzed, all signal data in adjacent channels is removed by the filter.

This setting improves the signal to noise ratio and thus the EVM results for signals with strong or a large number of adjacent channels. However, for some measurements information on the effects of adjacent channels on the measured signal may be of interest.

Remote command:

[\[SENSe:\]BANDwidth\[:RESolution\]:FILTer:STATe](#) on page 275

### Transmit Filter(IEEE 802.11b, g (DSSS))

Indicates the used transmit filter setting (read-only)

See also [Chapter 4.2.1, "Block diagram for single-carrier measurements"](#), on page 73

"Auto" default filter

Remote command:

[\[SENSe:\]DEMod:FILTer:MODulation](#) on page 276

### Receive Filter (IEEE 802.11b, g (DSSS))

Indicates the used receive filter setting (read-only)

See also [Chapter 4.2.1, "Block diagram for single-carrier measurements"](#), on page 73

"Auto" default filter

Remote command:

[\[SENSe:\]DEMod:FILTer:MODulation](#) on page 276

### Equalizer Filter Length (IEEE 802.11b, g (DSSS))

Specifies the length of the equalizer filter in chips

Remote command:

[\[SENSe:\]DEMod:FILTer:EFLength](#) on page 276

5.3.4.2 Trigger settings

Access: "Overview" > "Signal Capture" > "Trigger Source"

Trigger settings determine when the FSW starts to capture the input signal.

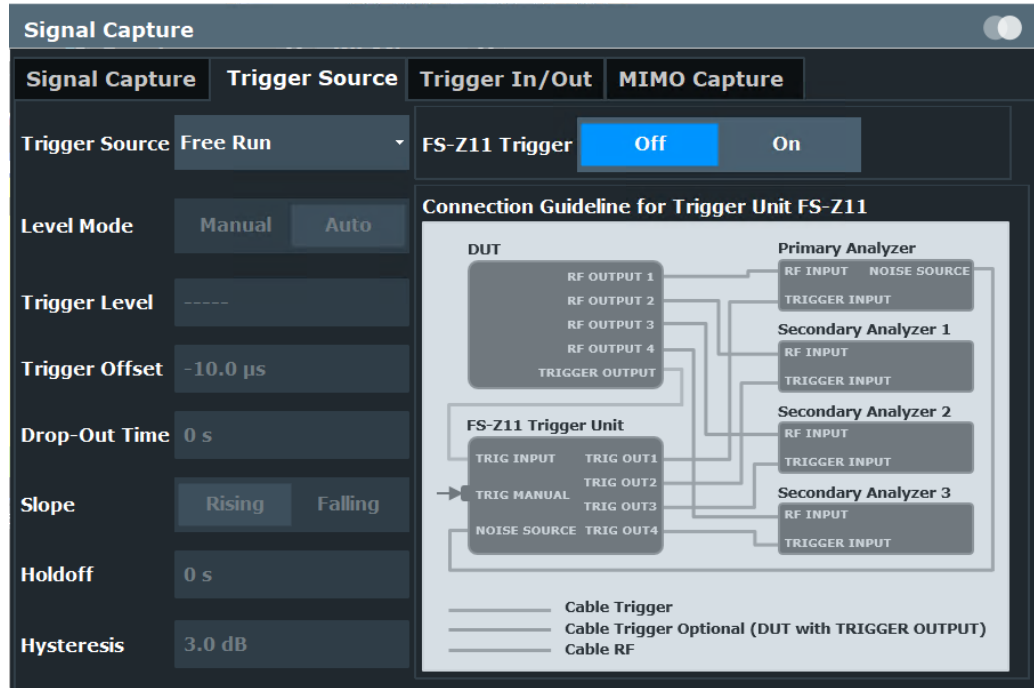

External triggers from one of the [TRIGGER INPUT/OUTPUT] connectors on the FSW are also available.

See the FSW base unit user manual.

For more information on trigger settings see [Chapter 4.11, "Trigger basics"](#), on page 99.

- Trigger Source.....131
  - Free Run.....131
  - External Trigger 1/2/3.....131
  - Baseband Power.....131
  - Digital I/Q.....132
  - RF Power.....132
  - I/Q Power.....133
  - Power Sensor.....133
  - Time.....133
- Trigger Level Mode.....133
- Trigger Level.....133
- Repetition Interval.....134
- Drop-Out Time.....134
- Trigger Offset.....134
- Hysteresis.....134
- Trigger Holdoff.....135

Slope.....	135
FS-Z11 Trigger.....	135
Capture Offset.....	135

### Trigger Source

Defines the trigger source. If a trigger source other than "Free Run" is set, "TRG" is displayed in the channel bar and the trigger source is indicated.

Remote command:

TRIGger [ :SEquence ] :SOURce on page 282

### Free Run ← Trigger Source

No trigger source is considered. Data acquisition is started manually or automatically and continues until stopped explicitly.

Remote command:

TRIG:SOUR IMM, see TRIGger [ :SEquence ] :SOURce on page 282

### External Trigger 1/2/3 ← Trigger Source

Data acquisition starts when the TTL signal fed into the specified input connector meets or exceeds the specified trigger level.

(See "Trigger Level" on page 133).

**Note:** "External Trigger 1" automatically selects the trigger signal from the "TRIGGER 1 INPUT" connector on the front panel.

For details, see the "Instrument Tour" chapter in the FSW Getting Started manual.

"External Trigger 1"

Trigger signal from the "TRIGGER 1 INPUT" connector.

"External Trigger 2"

Trigger signal from the "TRIGGER 2 INPUT / OUTPUT" connector.

Note: Connector must be configured for "Input" in the "Output" configuration

For FSW85 models, "Trigger 2" is not available due to the second RF input connector on the front panel.

(See the FSW base unit user manual).

"External Trigger 3"

Trigger signal from the "TRIGGER 3 INPUT / OUTPUT" connector on the rear panel.

Note: Connector must be configured for "Input" in the "Output" configuration.

(See FSW base unit user manual).

Remote command:

TRIG:SOUR EXT, TRIG:SOUR EXT2

TRIG:SOUR EXT3

See TRIGger [ :SEquence ] :SOURce on page 282

### Baseband Power ← Trigger Source

Defines triggering on the baseband power for baseband input.

Available for input from the optional "Analog Baseband" interface.

Available for input from the optional "Digital Baseband" interface.

Remote command:

TRIG:SOUR BBP, see TRIGger[:SEquence]:SOURce on page 282

### Digital I/Q ← Trigger Source

For applications that process I/Q data, such as the I/Q Analyzer or optional applications, and only if the optional "Digital Baseband" interface is available:

Defines triggering of the measurement directly via the "LVDS" connector. In the selection list, specify which general-purpose bit ("GP0" to "GP5") provides the trigger data.

**Note:** If the Digital I/Q enhanced mode is used, i.e. the connected device supports transfer rates up to 200 Msps, only the general-purpose bits "GP0" and "GP1" are available as a Digital I/Q trigger source.

The following table describes the assignment of the general-purpose bits to the LVDS connector pins.

**Table 5-1: Assignment of general-purpose bits to LVDS connector pins**

Bit	LVDS pin
GP0	SDATA4_P - Trigger1
GP1	SDATA4_P - Trigger2
GP2 *)	SDATA0_P - Reserve1
GP3 *)	SDATA4_P - Reserve2
GP4 *)	SDATA0_P - Marker1
GP5 *)	SDATA4_P - Marker2
*): not available for Digital I/Q enhanced mode	

Remote command:

TRIG:SOUR GP0, see TRIGger[:SEquence]:SOURce on page 282

### RF Power ← Trigger Source

Defines triggering of the measurement via signals which are outside the displayed measurement range.

For this purpose, the instrument uses a level detector at the first intermediate frequency.

The resulting trigger level at the RF input depends on the RF attenuation and preamplification. For details on available trigger levels, see the instrument's specifications document.

**Note:** If the input signal contains frequencies outside of this range (e.g. for fullspan measurements), the measurement can be aborted. A message indicating the allowed input frequencies is displayed in the status bar.

A "Trigger Offset", "Trigger Polarity" and "Trigger Holdoff" (to improve the trigger stability) can be defined for the RF trigger, but no "Hysteresis".

Not available for input from the optional "Analog Baseband" interface.

Not available for input from the optional "Digital Baseband" interface.

If the trigger source "RF Power" is selected and you enable baseband input, the trigger source is automatically switched to "Free Run".

Remote command:

TRIG:SOUR RFP, see [TRIGger\[:SEquence\]:SOURce](#) on page 282

#### **I/Q Power ← Trigger Source**

Not available for the optional "Digital Baseband" interface.

Triggers the measurement when the magnitude of the sampled I/Q data exceeds the trigger threshold.

The trigger bandwidth corresponds to the "Usable I/Q Bandwidth", which depends on the sample rate of the captured I/Q data (see ["Input Sample Rate"](#) on page 128 and

See [Chapter A, "Sample rate and maximum usable I/Q bandwidth for RF input"](#), on page 446).

Remote command:

TRIG:SOUR IQP, see [TRIGger\[:SEquence\]:SOURce](#) on page 282

#### **Power Sensor ← Trigger Source**

Uses an external power sensor as a trigger source. This option is only available if a power sensor is connected and configured.

**Note:** For Rohde & Schwarz power sensors, the "Gate Mode" *Lvl* is not supported. The signal sent by these sensors merely reflects the instant the level is first exceeded, rather than a time period. However, only time periods can be used for gating in level mode. Thus, the trigger impulse from the sensors is not long enough for a fully gated measurement; the measurement cannot be completed.

Remote command:

TRIG:SOUR PSE, see [TRIGger\[:SEquence\]:SOURce](#) on page 282

#### **Time ← Trigger Source**

Triggers in a specified repetition interval.

See ["Repetition Interval"](#) on page 134.

Remote command:

TRIG:SOUR TIME, see [TRIGger\[:SEquence\]:SOURce](#) on page 282

#### **Trigger Level Mode**

By default, the optimum trigger level for power triggers is automatically measured and determined at the start of each sweep (for Modulation Accuracy, Flatness, Tolerance... measurements).

In order to define the trigger level manually, switch to "Manual" mode.

Remote command:

TRIG:SEQ:LEV:POW:AUTO ON, see [TRIGger\[:SEquence\]:LEVel:POWer:AUTO](#) on page 281

#### **Trigger Level**

Defines the trigger level for the specified trigger source.

For details on supported trigger levels, see the instrument specifications document.

For time triggers, the repetition interval is defined. See "[Repetition Interval](#)" on page 134.

Remote command:

[TRIGger\[:SEquence\]:LEVel:IFPower](#) on page 280

[TRIGger\[:SEquence\]:LEVel:IQPower](#) on page 280

[TRIGger\[:SEquence\]:LEVel\[:EXTeRnal<port>\]](#) on page 280

[TRIGger\[:SEquence\]:LEVel:RFPower](#) on page 281

For baseband input only:

[TRIGger\[:SEquence\]:LEVel:BBPower](#) on page 279

### Repetition Interval

Defines the repetition interval for a time trigger.

The shortest interval is 2 ms.

Set the repetition interval to the exact pulse period, burst length, frame length or other repetitive signal characteristic. If the required interval cannot be set with the available granularity, configure a multiple of the interval that can be set. Thus, the trigger remains synchronized to the signal.

Remote command:

[TRIGger\[:SEquence\]:TIME:RINTerval](#) on page 284

### Drop-Out Time

Defines the time that the input signal must stay below the trigger level before triggering again.

For more information on the drop-out time, see [Chapter 4.11.3, "Trigger drop-out time"](#), on page 100.

**Note:** For input from the optional "Analog Baseband" interface using the baseband power trigger (BBP), the default drop out time is set to 100 ns. This avoids unintentional trigger events (as no hysteresis can be configured in this case).

Remote command:

[TRIGger\[:SEquence\]:DTIME](#) on page 278

### Trigger Offset

Defines the time offset between the trigger event and the start of the measurement.

For more information, see [Chapter 4.11.1, "Trigger offset"](#), on page 99.

Offset > 0:	Start of the measurement is delayed
Offset < 0:	Measurement starts earlier (pretrigger)

Remote command:

[TRIGger\[:SEquence\]:HOLDoff\[:TIME\]](#) on page 278

### Hysteresis

Defines the distance in dB to the trigger level that the trigger source must exceed before a trigger event occurs. Setting a hysteresis avoids unwanted trigger events caused by noise oscillation around the trigger level.

This setting is only available for "IF Power" trigger sources. The range of the value is between 3 dB and 50 dB with a step width of 1 dB.

For more information, see [Chapter 4.11.2, "Trigger hysteresis"](#), on page 100.

Remote command:

`TRIGger[:SEquence]:IFPower:HYSteresis` on page 279

### Trigger Holdoff

Defines the minimum time (in seconds) that must pass between two trigger events. Trigger events that occur during the holdoff time are ignored.

For more information, see [Chapter 4.11.4, "Trigger holdoff"](#), on page 101.

Remote command:

`TRIGger[:SEquence]:IFPower:HOLDoFF` on page 279

### Slope

For all trigger sources except time, you can define whether triggering occurs when the signal rises to the trigger level or falls down to it.

Remote command:

`TRIGger[:SEquence]:SLOPe` on page 282

### FS-Z11 Trigger

If activated, the measurement is triggered by a connected R&S FS-Z11 trigger unit, simultaneously for all connected analyzers. This is useful for MIMO measurements in simultaneous measurement mode (see ["Simultaneous Signal Capture Setup"](#) on page 139).

The trigger source is automatically set to ["External Trigger 1/2/3"](#) on page 131. The required connections between the analyzers, the trigger unit, and the DUT are indicated in the graphic.

For details see [Chapter 4.11.6, "Trigger synchronization using an R&S FS-Z11 trigger unit"](#), on page 102.

Remote command:

`TRIGger[:SEquence]:SOURce` on page 282

### Capture Offset

This setting is only available for secondary applications in **MSRA operating mode**. It has a similar effect as the trigger offset in other measurements: it defines the time offset between the capture buffer start and the start of the extracted secondary application data.

In MSRA mode, the offset must be a positive value, as the capture buffer starts at the trigger time = 0.

For details on the MSRA operating mode, see the [R&S®FSW MSRA Mode User Manual](#).

Remote command:

`[SENSe:]MSRA:CAPTure:OFFSet` on page 342

### 5.3.4.3 Optimization

**Access:** "Overview" > "Signal Capture" > "Optimization" tab

**Or:** [MEAS CONFIG] > "Signal Capture" > "Optimization" tab

Depending on the installed options and the input signal, some optimization functions are available.

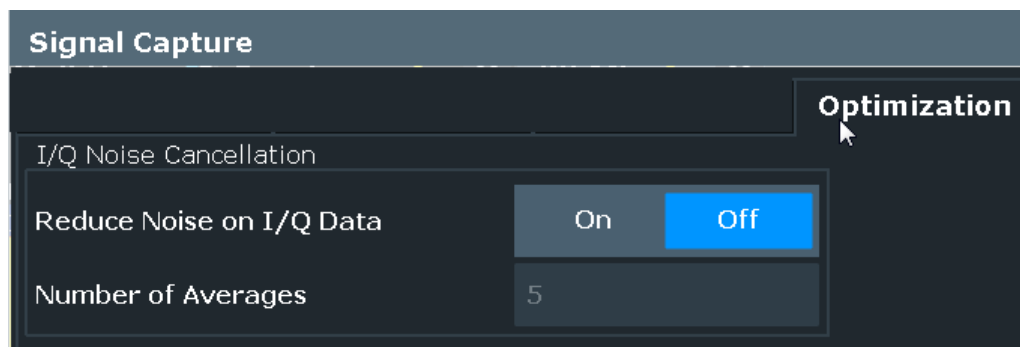

See also "IQNC I/Q Export" on page 205.

[Reduce Noise on I/Q Data](#)..... 136

#### Reduce Noise on I/Q Data

This function requires the R&S FSW-K575 option and a repetitive input signal.

If enabled, initial measurement steps are performed to remove the receiver noise of the spectrum analyzer. The steps include capturing and synchronizing data, averaging the data to estimate the total noise, and measuring the internal noise. Based on these measurements, the I/Q data is corrected so that it only includes the external noise contributions. The number of captures used for averaging is defined by the "Number of Averages".

Using this function, the residual EVM of the signal analyzer can be improved, even for very low signal levels.

If synchronization fails during the initial measurements, the noise cancellation process is not started, and an error message is displayed in the status bar.

If noise cancellation is enabled, "IQNC" is indicated in the channel bar.

Note that the "Magnitude Capture" display shows the most recently captured I/Q data from the averaging process without noise cancellation. All other result displays are based on the corrected data.

For statistical evaluation, the entire noise cancellation process is counted as one measurement.

For details on the concept of I/Q noise cancellation and for troubleshooting tips, see the FSW I/Q Analyzer and I/Q Input User Manual.

Remote command:

[SENSe:]ADJust:NCANcel:AVERage[:STATe] on page 275

[SENSe:]ADJust:NCANcel:AVERage[:COUNT] on page 275



### 5.3.4.4 MIMO capture settings

**Access:** "Overview" > "Signal Capture" > "MIMO Capture" tab

**Or:** [MEAS CONFIG] > "Signal Capture" > "MIMO Capture" tab

The following settings are **only available for the IEEE 802.11ac, ax, n, be standards.**

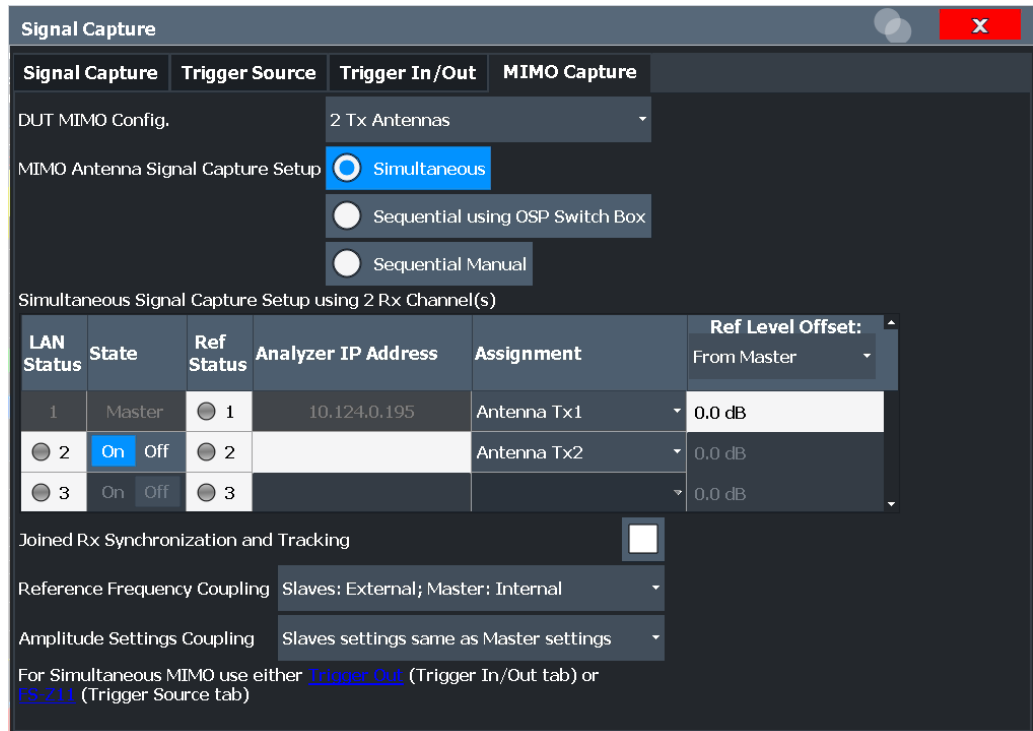

- DUT MIMO Configuration..... 138
- Time Sync..... 138
- MIMO Antenna Signal Capture Setup..... 138
- Simultaneous Signal Capture Setup..... 139
  - └ LAN Status..... 139
  - └ State..... 139
  - └ Reference Status..... 139
  - └ Analyzer IP Address..... 139
  - └ Assignment..... 140
  - └ Reference Level Offset..... 140
  - └ Joined RX Sync and Tracking..... 140
  - └ Reference Frequency Coupling..... 140
  - └ Amplitude Settings Coupling..... 141
- Sequential Using OSP Switch Setup..... 141
  - └ OSP IP Address..... 142
  - └ OSP Switch Bank Configuration..... 143
- Manual Sequential MIMO Data Capture..... 143
  - └ Single / Cont..... 144
  - └ Calc Results..... 144
  - └ Clear All Magnitude Capture Buffers..... 144
  - └ RUN SGL / RUN CONT updates..... 145

**DUT MIMO Configuration**

Defines the number of Tx antennas of the device under test (DUT). Currently up to eight Tx antennas are supported.

Remote command:

[CONFigure:WLAN:DUTConfig](#) on page 290

**Time Sync.**

Determines whether or not the cyclic shift delay (CSD) is used for timing synchronisation.

The R&S FSW WLAN application uses the preamble non-HT/non-VHT/non-HE cyclic shift delay to estimate the timing offset.

For MIMO/Single Antenna MIMO signals, the applied antenna (and therefore the CSD) is detected automatically using the  $N_{STS}$  information from the "Signal Field" and the  $N_{VHTLTF}$  information counting the VHT-LTF preamble symbols. (See 802.11-2016 standard "Table 21-13—Number of VHT-LTFs required for different numbers of space-time streams". For 11n and 11ax the corresponding preamble symbols are used).

For a SISO Signal ( $N_{STS} = 1$ ,  $N_{VHTLTF} = 1$ , see IEEE802.11-2016 Figure 19-2) the R&S FSW WLAN application assumes CSD=0 for the timing-offset estimation.

For antenna A0 this assumption matches with the applied signal and therefore the EVM is good.

However, for antennas A1, A2, A3, A4, if the applied signal contains a CSD other than 0, the wrong assumption leads to a wrong timing offset estimation. In this case, the CSD must be ignored to get the correct results.

"Apply CSD" (Default:) The timing offset estimation result (assuming CSD=0) is used for the subsequent signal analysis.

"Ignore CSD" The timing offset estimation result (assuming CSD=0) is ignored for the subsequent signal analysis.

Remote command:

[CONFigure:WLAN:MIMO:CSD](#) on page 292

**MIMO Antenna Signal Capture Setup**

Defines the MIMO method used by the FSW(s) to capture data from multiple Tx antennas sent by one device under test (DUT).

- |                               |   |
|-------------------------------|---|
| "Simultaneous"                | Simultaneous normal MIMO operation<br>The number of Tx antennas set in <a href="#">DUT MIMO Configuration</a> defines the number of analyzers required for this measurement setup.  |
| "Sequential using OSP switch" | Sequential using open switch platform<br>A single analyzer and the Rohde & Schwarz OSP Switch Platform (with at least one fitted R&S@OSP-B101 option) is required to measure the number of DUT Tx Antennas as defined in <a href="#">DUT MIMO Configuration</a> . |
| "Sequential manual"           | Sequential using manual operation<br>A single analyzer is required to measure the number of DUT Tx Antennas as defined in <a href="#">DUT MIMO Configuration</a> . Data capturing is performed manually via the analyzer's user interface.                        |

Remote command:

[CONFigure:WLAN:MIMO:CAPTURE:TYPE](#) on page 291

### Simultaneous Signal Capture Setup

For each RX antenna from which data is to be captured simultaneously, the settings are configured here.

#### LAN Status ← Simultaneous Signal Capture Setup

The LED symbol indicates the LAN connection state for each individual antenna (except for the primary):

**Table 5-2: Meaning of LED colors**

Color	State
gray	antenna off or IP address not available/valid
red	antenna on and IP address valid, but not accessible
green	antenna on and IP address accessible

Remote command:

[CONFigure:WLAN:ANTMatrix:SOURce:ROSCillator:SOURce:STAT<ant>](#) on page 290

#### State ← Simultaneous Signal Capture Setup

Switches the corresponding secondary analyzer on or off. In "On" state the secondary analyzer captures data. This data is transferred via LAN to the primary for analysis of the MIMO system.

Remote command:

[CONFigure:WLAN:ANTMatrix:STATe<ant>](#) on page 290

#### Reference Status ← Simultaneous Signal Capture Setup

LEDs indicate the connection state of the device providing the individual reference frequency for each channel (for ["Reference Frequency Coupling"](#) on page 140).

**Table 5-3: Meaning of LED colors**

Color	State
gray	external reference off or IP address not available/valid
red	external reference on and IP address valid, but no external reference detected
green	external reference on and IP address accessible

Remote command:

[CONFigure:WLAN:ANTMatrix:ADDRESS<ant>](#) on page 287

#### Analyzer IP Address ← Simultaneous Signal Capture Setup

Defines the IP addresses of the secondaries connected via LAN to the primary.

**Assignment ← Simultaneous Signal Capture Setup**

Assignment of the expected antenna to an analyzer. For a wired connection the assignment of the Tx antenna connected to the analyzer is a possibility. For a wired connection and Direct Spatial Mapping the "Spectrum Flatness" traces in the diagonal contain the useful information, in case the signal transmitted from the antennas matches with the expected antennas. Otherwise the secondary diagonal will contain the useful traces.

Remote command:

[CONFigure:WLAN:ANTMatrix:ANTenna<ant>](#) on page 287

**Reference Level Offset ← Simultaneous Signal Capture Setup**

For simultaneous MIMO setups, you can set the reference level for all secondary devices to the same setting as the primary device, or define individual offsets.

"From primary" The secondary analyzers' reference levels are set to match that of the primary.

"Manual" The secondary analyzers' reference levels are specified individually and are not coupled to the reference level offset of the primary analyzer.

Remote command:

[CONFigure:WLAN:ANTMatrix:SOURce:RLEVel:OFFSet](#) on page 289

[CONFigure:WLAN:ANTMatrix:RLEVel<ant>:OFFSet](#) on page 287

**Joined RX Sync and Tracking ← Simultaneous Signal Capture Setup**

This command configures how PPDU synchronization and tracking is performed for multiple captured antenna signals.

"ON" RX antennas are synchronized and tracked together.

"OFF" RX antennas are synchronized and tracked separately.

Remote command:

[CONFigure:WLAN:RSYNc:JOINed](#) on page 292

**Reference Frequency Coupling ← Simultaneous Signal Capture Setup**

For simultaneous MIMO setups, you can set the reference frequency source for all secondary devices to the same setting as the primary device.

"Secondary reference same as primary setting" Both the primary and all secondaries use the same reference, according to the setting at the primary.

"Secondary: External; primary: Internal" The secondary devices are set to use the external reference from the primary. The primary device uses its internal reference. Configure the primary to send its reference frequency to all secondary devices via one of its [REF OUTPUT] connectors.

"Off" Both the primary and secondary devices use their own internal references; the frequencies are not coupled.

Remote command:

[CONFigure:WLAN:ANTMatrix:SOURce:ROSCillator:SOURce](#) on page 289

**Amplitude Settings Coupling ← Simultaneous Signal Capture Setup**

For simultaneous MIMO setups, you can set the amplitude settings for all secondary devices to the same setting as the primary device. Thus, for example, you can force the secondary devices to auto-level in order to achieve better results. This feature requires that the WLAN 802.11 application FSW-K91 is installed on the secondary device.

"Secondary settings same as primary settings"	Both the primary and all secondaries use the same amplitude settings, according to the settings at the primary. All settings on the secondary are ignored (including "Reference Level Auto"). Note: if "Reference Level Auto" is set at the primary, the primary channel performs an auto-level measurement and the resulting amplitude settings are transferred to the secondaries.
"Secondary auto-level same as primary"	The secondary devices perform an auto-level at the same time as the primary. The amplitude settings are then determined automatically by each device according to the measured values. This feature requires that the WLAN 802.11 application FSW-K91 (version 1.31 or higher) is installed on the secondary devices.
"Off"	Both the primary and secondary devices use their own amplitude settings as defined prior to the measurement; the settings are not coupled.

Remote command:

[CONFigure:WLAN:ANTMatrix:SOURce:AMPLitude:SOURce](#) on page 288

**Sequential Using OSP Switch Setup**

A single analyzer and the Rohde & Schwarz OSP Switch Platform (with at least one fitted R&S@OSP-B101 option) is required to measure the DUT Tx Antennas.

**Note:** For sequential MIMO measurements the DUT has to transmit identical PPDU's over time! The signal field, for example, has to be identical for all PPDU's. For details see [Chapter 4.3.4.1, "Sequential MIMO measurement"](#), on page 83.

This setup requires the analyzer and the OSP switch platform to be connected via LAN. A connection diagram is shown to assist you in connecting the specified number of DUT Tx antennas with the analyzer via the Rohde & Schwarz OSP switch platform.

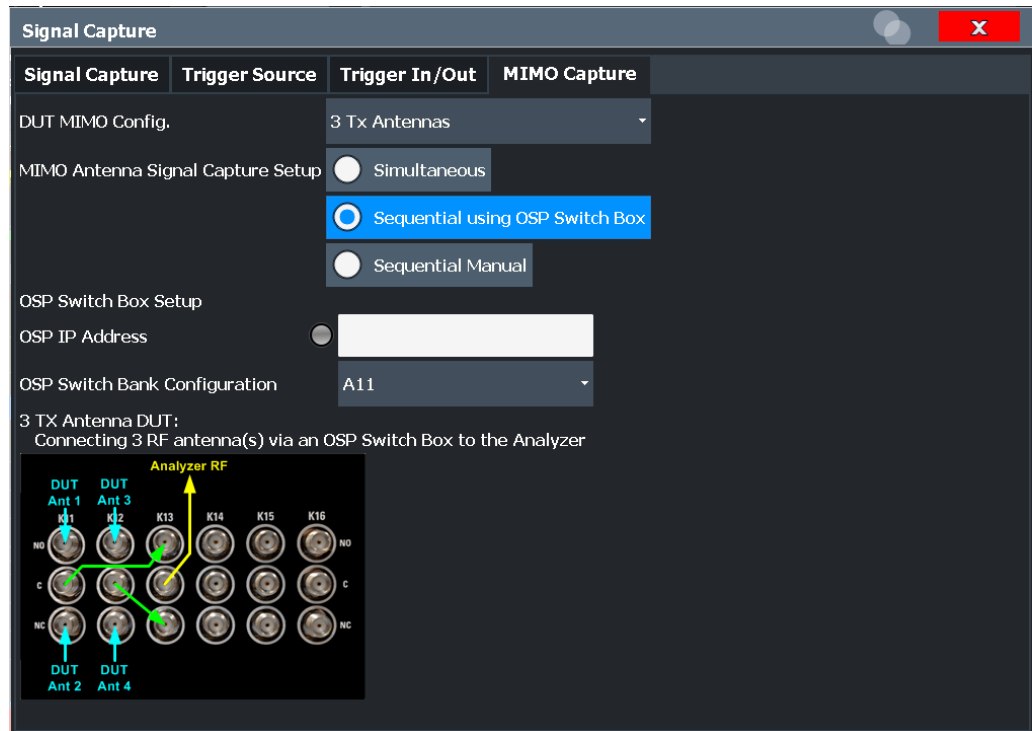

Figure 5-1: Connection instructions for sequential MIMO using an OSP switch

The diagram shows an R&S®OSP-B101 option fitted in one of the three module slots at the rear of the OSP switch platform. The DUT Tx antennas, the OSP switching box and the analyzer have to be connected as indicated in the diagram.

- **Blue** colored arrows represent the connections between the Tx antennas of the DUT and the corresponding SMA plugs of the R&S®OSP-B101 option.
- **Green** colored arrows represent auxiliary connections of SMA plugs of the R&S®OSP-B101 option.
- **Yellow** colored arrows represent the connection between the SMA plug of the R&S®OSP-B101 option with the RF or analog baseband input of the analyzer.

#### OSP IP Address ← Sequential Using OSP Switch Setup

The analyzer and the R&S OSP switch platform have to be connected via LAN. Enter the IP address of the OSP switch platform.

When using an R&S®OSP130 switch platform, the IP address is shown in the front display.

When using a R&S®OSP120 switch platform, connect an external monitor to get the IP address or use the default IP address of the OSP switch platform. For details read the OSP operation manual.

An online keyboard is displayed to enter the address in dotted IPV4 format.

**Tip:** the LED symbol indicates the state of the OSP switch box:

Color	State
gray	OSP switch box off or IP address not available/valid
red	OSP switch box on and IP address valid, but not accessible
green	OSP switch box on and IP address accessible

Remote command:

[CONFigure:WLAN:MIMO:OSP:ADDRess](#) on page 292

### OSP Switch Bank Configuration ← Sequential Using OSP Switch Setup

The R&S@OSP-B101 option is fitted in one of the three module slots (*switch banks*) at the rear of the OSP switch platform. The DUT Tx antennas are connected with the analyzer via the R&S@OSP-B101 module fitted in the OSP switch platform. Select the R&S@OSP-B101 module that is used for this connection.

Remote command:

[CONFigure:WLAN:MIMO:OSP:MODuLe](#) on page 292

### Manual Sequential MIMO Data Capture

**Note:** For sequential MIMO measurements the DUT has to transmit identical PPDU's over time. The signal field, for example, has to be identical for all PPDU's. For details see [Chapter 4.3.4.1, "Sequential MIMO measurement"](#), on page 83.

For this MIMO method you must connect each Tx antenna of the WLAN DUT with the analyzer and start data capturing manually.

(See [Chapter 5.3.12, "Sweep settings"](#), on page 197).

The dialog box shows a preview of the capture memories (one for each RX antenna). The PPDU's detected by the application are highlighted by the green bars.

### Signal Capture

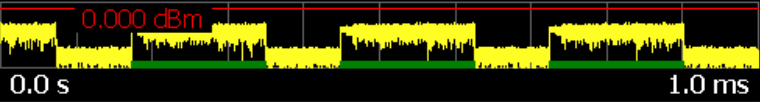
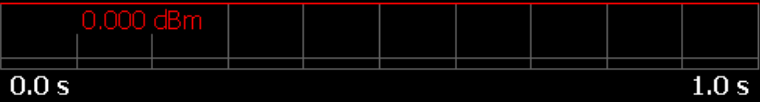
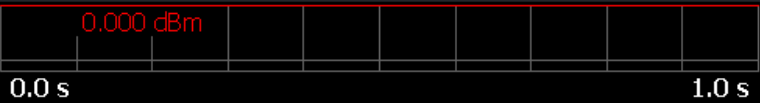
Signal Capture	Trigger Source	Trigger In/Out	MIMO Capture
DUT MIMO Config.		3 Tx Antennas <span style="float: right;">▼</span>	
MIMO Antenna Signal Capture Setup		<input type="radio"/> Simultaneous <input type="radio"/> Sequential using OSP Switch Box <input checked="" type="radio"/> Sequential Manual	
Sequential Signal Capture Overview			
Rx 1 Capture			
Single	Cont.	0.0 s <span style="float: right;">1.0 ms</span>	
Rx 2 Capture			
Single	Cont.	0.0 s <span style="float: right;">1.0 s</span>	
Rx 3 Capture			
Single	Cont.	0.0 s <span style="float: right;">1.0 s</span>	
Calc Results	Clear All Magnitude Capture Buffers		
<RUN SINGLE> or <RUN CONT> updates		Capture Memory Rx 1 <span style="float: right;">▼</span>	

Remote command:

CONF:WLAN:MIMO:CAPT:TYP MAN, see [CONFigure:WLAN:MIMO:CAPTure:TYPE](#) on page 291

#### Single / Cont. ← Manual Sequential MIMO Data Capture

Starts a single or continuous new measurement for the corresponding antenna.

Remote command:

CONF:WLAN:MIMO:CAPT RX1, see [CONFigure:WLAN:MIMO:CAPTure](#) on page 291  
[INITiate<n>\[:IMMediate\]](#) on page 369

#### Calc Results ← Manual Sequential MIMO Data Capture

Calculates the results for the captured antenna signals.

Remote command:

[CALCulate<n>:BURSt\[:IMMediate\]](#) on page 369

#### Clear All Magnitude Capture Buffers ← Manual Sequential MIMO Data Capture

Clears all the capture buffers and previews.



**RUN SGL / RUN CONT updates ← Manual Sequential MIMO Data Capture**

Determines which capture buffer is used to store data if a measurement is started via global [RUN SGL] / [RUN CONT].

**5.3.5 Secondary application data (MSRA)**

For the R&S FSW WLAN application in MSRA operating mode, the secondary application data range is defined by the same settings used to define the signal capturing in Signal and Spectrum Analyzer mode (see [Chapter 5.3.4, "Signal capture \(data acquisition\)"](#), on page 127).

In addition, a capture offset can be defined, i.e. an offset from the start of the captured data to the start of the analysis interval for the WLAN 802.11 I/Q measurement (see ["Capture Offset"](#) on page 128).

The **analysis interval** cannot be edited manually, but is determined automatically according to the selected channel, carrier or PPDU to analyze which is defined for the evaluation range, depending on the result display. Note that the channel/carrier/PPDU is analyzed *within the secondary application data*.

**5.3.6 Synchronization and OFDM demodulation**

**Access:** "Overview" > "Synchronization/ OFDM-Demod."

**Or:** [MEAS CONFIG] > "Synch./OFDM-Demod."

Synchronization settings have an effect on which parts of the input signal are processed during the WLAN 802.11 measurement.

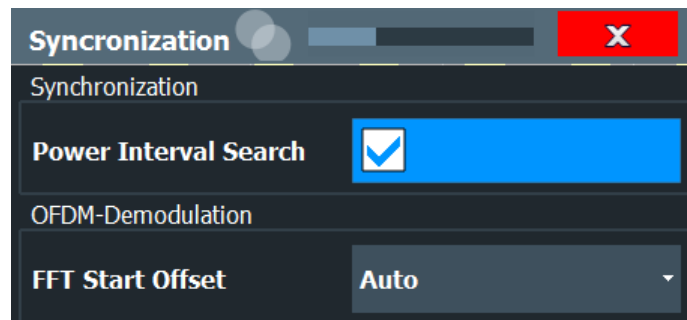

<a href="#">Power Interval Search</a> .....	145
<a href="#">FFT Start Offset</a> .....	146

**Power Interval Search**

If enabled, the R&S FSW WLAN application initially performs a coarse burst search on the input signal in which increases in the power vs time trace are detected. Further time-consuming processing is then only performed where bursts are assumed. This improves the measurement speed for signals with low duty cycle rates.

However, for signals in which the PPDU power levels differ significantly, this option should be disabled as otherwise some PPDUs may not be detected.

Remote command:

[SENSe:] DEMod: TXARea on page 293

#### FFT Start Offset

This command specifies the start offset of the FFT for OFDM demodulation (not for the "FFT Spectrum" display).

"AUTO"

The FFT start offset is automatically chosen to minimize the intersymbol interference.

"Guard Interval Cntr"

Guard Interval Center: The FFT start offset is placed to the center of the guard interval.

"Peak"

The peak of the fine timing metric is used to determine the FFT start offset.

Remote command:

[SENSe:] DEMod: FFT: OFFSet on page 293

### 5.3.7 Tracking and channel estimation

**Access:** "Overview" > "Tracking/Channel Estimation"

The channel estimation settings determine which channels are assumed in the input signal. Tracking settings allow for compensation of some transmission effects in the signal (see "[Tracking the phase drift, timing jitter and gain](#)" on page 69).

**Estimation/Tracking**
⊗

Channel Estimation

<b>Channel Estimation Range</b>	Preamble (EHT-LTF) ▾
<b>Interpolation</b>	Wiener ▾
<b>Wiener Relative Delay Spread</b>	<span style="border: 1px solid gray; padding: 2px 10px;">Off</span> <span style="border: 1px solid gray; padding: 2px 10px;">Manual</span> <span style="border: 1px solid gray; padding: 2px 10px;">---</span>

Tracking

**Preamble Channel Estimation** Payload ▾

Tracking for the signal to be measured

<b>Phase</b>	On	Off
<b>Timing</b>	On	Off
<b>Level</b>	On	Off

**I/Q Mismatch Compensation** Off ▾

**Pilots for Tracking** According to Standard ▾

MIMO

**Compensate Crosstalk**

On
Off

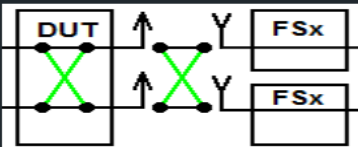

The diagram illustrates a MIMO setup for crosstalk compensation. It shows a Device Under Test (DUT) on the left, two Frequency Selective Networks (FSx) on the right, and two measurement points (Y) in the middle. Green arrows indicate crosstalk paths between the DUT and the FSx components. The 'Compensate Crosstalk' setting is currently set to 'On'.

Figure 5-2: Tracking/channel estimation settings for MIMO setup

Channel Estimation Range.....	147
Interpolation.....	148
Wiener Relative Delay Spread.....	149
Preamble Channel Estimation.....	149
Phase Tracking.....	149
Timing Error Tracking.....	149
Level Error (Gain) Tracking.....	150
I/Q Mismatch Compensation.....	150
Pilots for Tracking.....	150
Compensate Crosstalk(MIMO only).....	151

### Channel Estimation Range

Specifies the signal range used to estimate the channels.

This function is **not** available for **IEEE 802.11b or g (DSSS)**.

"Preamble (HE/EHT-LTF)"	<p>The channel estimation is performed using the preamble of the HE/EHT-LTF as required in the standard.</p> <p>Remote command:  <a href="#">[SENSe:]DEMod:CESTimation:RANGe PRE1t</a></p>
"Preamble (L-LTF + HE/EHT-LTF)"	<p>The channel estimation is performed using the preamble of both training fields.</p> <p>Remote command:  <a href="#">[SENSe:]DEMod:CESTimation:RANGe PRE2t</a></p>
"Payload (Full tracking)"	<p>The channel estimation is performed using the preamble and the payload. The EVM results can be calculated more accurately. All tracking options are applied to the payload symbols used for payload channel estimation.          (Note: this setting corresponds to the simple "Payload" setting in previous firmware versions.)</p> <p>Remote command:  <a href="#">[SENSe:]DEMod:CESTimation:RANGe PFTRacking</a>          ([SENSe:]DEMod:CESTimation 1)</p>
"Payload (User tracking)"	<p>The channel estimation is performed using the preamble and the payload. The EVM results can be calculated more accurately. The user-defined tracking settings as defined in the <a href="#">Tracking and channel estimation</a> are applied to the payload symbols used for payload channel estimation.</p> <p>Remote command:  <a href="#">[SENSe:]DEMod:CESTimation:RANGe PUTRacking</a></p> <p>Remote command:  <a href="#">[SENSe:]DEMod:CESTimation:RANGe</a> on page 294</p>

### Interpolation

Defines the type of interpolation and smoothing used during estimation.

In case all subcarriers are used (4xHE-LTF), sampling points for all subcarriers are available. In this case, the interpolation function smoothes the estimated channel.

This function is only available for standards **IEEE 802.11ax, be**.

"Wiener"	<p>The unused subcarriers of the channel estimation fields (1xHE-LTF, 2xHE-LTF) are determined by Wiener interpolation. The estimated channel is smoothed. The Wiener interpolation overwrites the used subcarrier sampling points.          In case all subcarriers are used (4xHE-LTF), sampling points for all subcarriers are available. The channel is smoothed.</p>
"None/Linear"	<p>The unused subcarriers of the channel estimation fields (1xHE-LTF, 2xHE-LTF) are determined by linear interpolation. Linear interpolation preserves the used subcarrier sampling points.          In case all subcarriers are used (4xHE-LTF), the available sampling points for all subcarriers are preserved, and no interpolation is applied.</p>

Remote command:

[\[SENSe:\]DEMod:INTerpolate](#) on page 295

### Wiener Relative Delay Spread

Defines the filter for Wiener interpolation.

By default, the filter is defined automatically. You can define a value in percent manually, between 0.01 and 50. The value is relative to the DFT (discrete Fourier transform) period that is used for the Wiener filter design. Decrease this setting to finetune the EVM result if there is negligible delay spread, for example for a wired connection.

This function is only available for standards **IEEE 802.11ax, be** and only for [Interpolation](#) = "Wiener".

Remote command:

[\[SENSe:\]DEMod:INTerpolate:WIENer:DSPRead:STATE](#) on page 296

[\[SENSe:\]DEMod:INTerpolate:WIENer:DSPRead](#) on page 295

### Preamble Channel Estimation

Defines which results are used for preamble tracking prior to the preamble channel estimation.

This function is only available for standards **WLAN 802.11ac and n**.

"Payload"	Prior to MIMO channel estimation, global center frequency error and symbol clock error estimates are calculated using known payload pilots. (V)HT-LTF symbols are then corrected using these estimates. Symbol-wise phase tracking over (V)HT-LTF symbols is not performed.
"(V)HT-LTF Symbols + Payload"	Prior to MIMO channel estimation, global center frequency error and symbol clock error estimates are calculated using known payload pilots. (V)HT-LTF symbols are then corrected using these estimates. In addition, a (V)HT-LTF symbol-wise phase estimation and correction (phase tracking) is performed. In case of strong phase drifts, this can help improve the channel estimate based on (V)HT-LTF symbols. However, (V)HT-LTF symbol phase tracking only makes sense if more than one (V)HT-LTF symbol is used for channel estimation. Otherwise, phase tracking is skipped.

Remote command:

[SENSe:TRACking:PREamble](#) on page 298

### Phase Tracking

Activates or deactivates the compensation for phase drifts. If activated, the measurement results are compensated for phase drifts on a per-symbol basis.

Remote command:

[SENSe:TRACking:PHASe](#) on page 297

### Timing Error Tracking

Activates or deactivates the compensation for timing drift. If activated, the measurement results are compensated for timing error on a per-symbol basis.

Remote command:

[SENSe:TRACking:TIME](#) on page 299

**Level Error (Gain) Tracking**

Activates or deactivates the compensation for level drifts within a single PPDU. If activated, the measurement results are compensated for level error on a per-symbol basis.

Remote command:

[SENSe:TRACking:LEVel](#) on page 297

**I/Q Mismatch Compensation**

Activates or deactivates the compensation for I/Q mismatch.

If activated, the measurement results are compensated for gain imbalance and quadrature offset.

This setting is **not available for standards IEEE 802.11b and g (DSSS)**.

For details see [Chapter 3.1.1.5, "I/Q mismatch"](#), on page 22.

**Note:** For EVM measurements according to the IEEE 802.11-2012, IEEE 802.11ac-2013 WLAN standard, I/Q mismatch compensation must be deactivated.

"Off" No compensation is applied.

"Average Subcarrier"

The I/Q mismatches (gain imbalance, quadrature offset, time skew) are averaged over the subcarriers. The scalar results are applied to the subcarriers and used for I/Q mismatch compensation. Note this setting corresponds to the previous "I/Q Mismatch Compensation: On" setting.

"Per Subcarrier"

The individual I/Q mismatches per subcarrier are used for I/Q mismatch compensation.

Remote command:

[SENSe:TRACking:IQMComp](#) on page 296

**Pilots for Tracking**

In case tracking is used, the used pilot sequence has an effect on the measurement results.

This function is **not available for IEEE 802.11b or g (DSSS)**.

"According to standard"

The pilot sequence is determined according to the corresponding WLAN standard. In case the pilot generation algorithm of the device under test (DUT) has a problem, the non-standard-conform pilot sequence might affect the measurement results, or the R&S FSW WLAN application might not synchronize at all onto the signal generated by the DUT.

"Detected"

The pilot sequence detected in the WLAN signal to be analyzed is used by the R&S FSW WLAN application. In case the pilot generation algorithm of the device under test (DUT) has a problem, the non-standard-conform pilot sequence will not affect the measurement results. In case the pilot sequence generated by the DUT is correct, it is recommended that you use the "According to Standard" setting because it generates more accurate measurement results.

Remote command:

[SENSe:TRACking:PILots](#) on page 298

### Compensate Crosstalk(MIMO only)

Activates or deactivates the compensation for crosstalk in MIMO measurement setups.

This setting is **only available for standard IEEE 802.11ac, ax, n, be (MIMO)**.

By default, full MIMO equalizing is performed by the R&S FSW WLAN application. However, you can deactivate compensation for crosstalk. In this case, simple main path equalizing is performed only for direct connections between Tx and Rx antennas, disregarding ancillary transmission between the main paths (crosstalk). This is useful to investigate the effects of crosstalk on results such as EVM.

On the other hand, for cable connections, which have practically no crosstalk, you may get better EVM results if crosstalk is compensated for.

For details see [Chapter 4.3.6, "Crosstalk and spectrum flatness"](#), on page 86.

Remote command:

[SENSe:TRACking:CROSstalk](#) on page 296

## 5.3.8 Demodulation

**Access:** "Overview" > "Demodulation"

**Or:** [MEAS CONFIG] > "Demod."

The demodulation settings define which PPDU's are to be analyzed, thus they define a *logical filter*.

The available demodulation settings vary depending on the selected digital standard in the "Signal Description" (see "[Standard](#)" on page 110).

- [Demodulation - IEEE 802.11a, g \(OFDM\), j, p](#)..... 151
- [Demodulation - IEEE 802.11ac](#)..... 154
- [Demodulation - IEEE 802.11ax](#)..... 159
- [Demodulation - IEEE 802.11be](#)..... 167
- [Demodulation - IEEE 802.11b, g \(DSSS\)](#)..... 175
- [Demodulation - IEEE 802.11n](#)..... 177
- [Demodulation - MIMO \(IEEE 802.11ac, ax, n, be\)](#)..... 182

### 5.3.8.1 Demodulation - IEEE 802.11a, g (OFDM), j, p

**Access:** "Overview" > "Demodulation"

**Or:** [MEAS CONFIG] > "Demod."

The following settings are available for demodulation of IEEE 802.11a, g (OFDM), j, p signals.

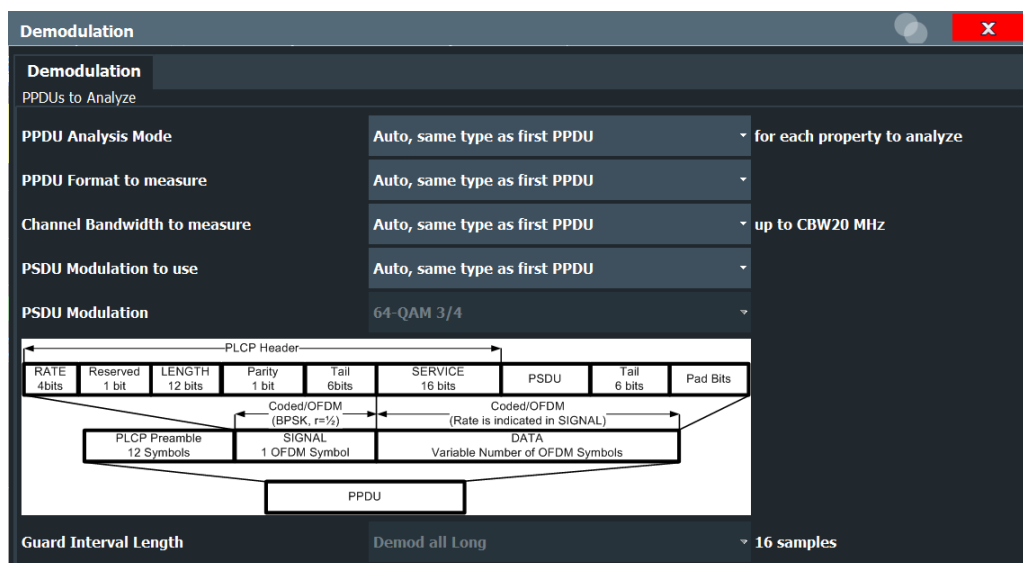

Figure 5-3: Demodulation settings for IEEE 802.11a, g (OFDM), j, p standard

PPDU Analysis Mode..... 152  
 PPDU Format to measure..... 152  
 Channel Bandwidth to measure (CBW)..... 153  
 PSDU Modulation to use..... 153  
 PSDU Modulation..... 154  
 Guard Interval Length..... 154

**PPDU Analysis Mode**

Defines whether all or only specific PPDU are to be analyzed.

"Auto, same type as first PPDU"

The signal symbol field, i.e. the PLCP header field, of the first recognized PPDU is analyzed to determine the details of the PPDU. All PPDU identical to the first recognized PPDU are analyzed. All subsequent settings are set to "Auto" mode.

"Auto, individually for each PPDU"

All PPDU are analyzed

"User-defined"

User-defined settings define which PPDU are analyzed. This setting is automatically selected when any of the subsequent settings are changed to a value other than "Auto".

Remote command:

[SENSe:] DEMod:FORMat [:BCONTent]:AUTO on page 308

**PPDU Format to measure**

Defines which PPDU formats are to be included in the analysis. Depending on which standards the communicating devices are using, different formats of PPDU are available. Thus you can restrict analysis to the supported formats.

**Note:** The PPDU format determines the available channel bandwidths.



For details on supported PPDU formats and channel bandwidths depending on the standard see [Table 4-3](#).

**Note:** The terms in brackets in the following description indicate how the setting is referred to in the "Signal Field" result display ("Format" column).

"Auto, same type as first PPDU (A1st)"

The format of the first valid PPDU is detected and subsequent PDUs are analyzed only if they have the same format.

"Auto, individually for each PPDU (AI)"

All PDUs are analyzed regardless of their format

"Meas only ...(M ...)"

Only PDUs with the specified format are analyzed

"Demod all as ...(D ...)"

All PDUs are assumed to have the specified PPDU format

Remote command:

[SENSe:] DEMod: FORMat: BANalyze: BType: AUTO: TYPE on page 307

[SENSe:] DEMod: FORMat: BANalyze on page 304

### Channel Bandwidth to measure (CBW)

Defines the channel bandwidth of the PDUs taking part in the analysis. Depending on which standards the communicating devices are using, different PPDU formats and channel bandwidths are supported.

For details on supported PPDU formats and channel bandwidths depending on the standard see [Table 4-3](#).

**Note:** The terms in brackets in the following description indicate how the setting is referred to in the "Signal Field" result display ("Format" column, see ["Signal Field"](#) on page 52).

"Auto, same type as first PPDU"(A1st)"

The channel bandwidth of the first valid PPDU is detected and subsequent PDUs are analyzed only if they have the same channel bandwidth.

"Meas only ... signal"(M ...)"

Only PDUs with the specified channel bandwidth are analyzed

"Demod all as ... signal"(D ...)"

All PDUs are assumed to have the specified channel bandwidth

Remote command:

[SENSe:] BANDwidth: CHANnel: AUTO: TYPE on page 302

### PSDU Modulation to use

Specifies which PSDUs are to be analyzed depending on their modulation. Only PSDUs using the selected modulation are considered in measurement analysis.

For details on supported modulation depending on the standard see [Table 4-3](#).

"Auto, same type as first PPDU"(A1st)"

All PSDUs using the same modulation as the first recognized PPDU are analyzed.

"Auto, individually for each PPDU""(AI)"

All PSDUs are analyzed

"Meas only the specified PSDU Modulation""(M ...)"

Only PSDUs with the modulation specified by the [PSDU Modulation](#) setting are analyzed

"Demod all with specified PSDU modulation""(D ...)"

The PSDU modulation of the [PSDU Modulation](#) setting is used for all PSDUs.

Remote command:

[\[SENSe:\] DEMod:FORMat:BANalyze:BTYPe:AUTO:TYPE](#) on page 307

[\[SENSe:\] DEMod:FORMat:BANalyze](#) on page 304

### PSDU Modulation

If analysis is restricted to PSDU with a particular modulation type, this setting defines which type.

For details on supported modulation depending on the standard see [Table 4-3](#).

Remote command:

[\[SENSe:\] DEMod:FORMat:BANalyze](#) on page 304

### Guard Interval Length

Defines the PPDU taking part in the analysis depending on the guard interval length.

**Note:** The terms in brackets in the following description indicate how the setting is referred to in the "Signal Field" result display ("Format" column, see ["Signal Field"](#) on page 52).

"Auto, same type as first PPDU""(A1st)"

All PPDU using the guard interval length identical to the first recognized PPDU are analyzed.

"Auto, individually for each PPDU""(AI)"

All PPDU are analyzed.

"Meas only Short""(MS)"

Only PPDU with short guard interval length are analyzed.

"Meas only Long""(ML)"

Only PPDU with long guard interval length are analyzed.

"Demod all as short""(DS)"

All PPDU are demodulated assuming short guard interval length.

"Demod all as long""(DL)"

All PPDU are demodulated assuming long guard interval length.

Remote command:

[CONFigure:WLAN:GTIMe:AUTO](#) on page 300

[CONFigure:WLAN:GTIMe:AUTO:TYPE](#) on page 437

[CONFigure:WLAN:GTIMe:SElect](#) on page 301

#### 5.3.8.2 Demodulation - IEEE 802.11ac

**Access:** "Overview" > "Demodulation"

Or: [MEAS CONFIG] > "Demod."

The following settings are available for demodulation of IEEE 802.11ac signals.

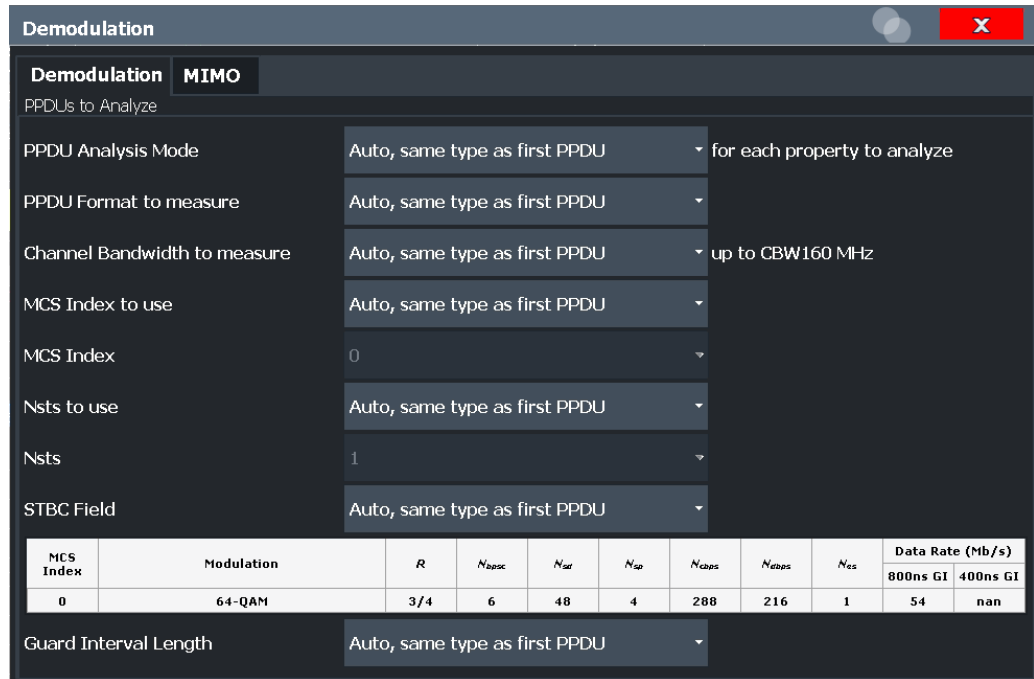

Figure 5-4: Demodulation settings for IEEE 802.11ac standard

PPDU Analysis Mode..... 155

PPDU Format to measure..... 156

Channel Bandwidth to measure (CBW)..... 156

MCS Index to use..... 157

MCS Index..... 157

Nsts to use..... 157

Nsts..... 158

STBC Field..... 158

Table info overview..... 158

Guard Interval Length..... 158

**PPDU Analysis Mode**

Defines whether all or only specific PPDU are to be analyzed.

"Auto, same type as first PPDU"

The signal symbol field, i.e. the PLCP header field, of the first recognized PPDU is analyzed to determine the details of the PPDU. All PPDU identical to the first recognized PPDU are analyzed. All subsequent settings are set to "Auto" mode.

"Auto, individually for each PPDU"

All PPDU are analyzed

"User-defined"

User-defined settings define which PPDU are analyzed. This setting is automatically selected when any of the subsequent settings are changed to a value other than "Auto".

Remote command:

[SENSe:] DEMod:FORMat [:BContent] :AUTO on page 308

#### PPDU Format to measure

Defines which PPDU formats are to be included in the analysis. Depending on which standards the communicating devices are using, different formats of PPDU are available. Thus you can restrict analysis to the supported formats.

**Note:** The PPDU format determines the available channel bandwidths.

For details on supported PPDU formats and channel bandwidths depending on the standard see [Table 4-3](#).

**Note:** The terms in brackets in the following description indicate how the setting is referred to in the "Signal Field" result display ("Format" column).

"Auto, same type as first PPDU (A1st)"

The format of the first valid PPDU is detected and subsequent PPDU are analyzed only if they have the same format.

"Auto, individually for each PPDU (AI)"

All PPDU are analyzed regardless of their format

"Meas only ...(M ...)"

Only PPDU with the specified format are analyzed

"Demod all as ...(D ...)"

All PPDU are assumed to have the specified PPDU format

Remote command:

[SENSe:] DEMod:FORMat:BANalyze:BTYPe:AUTO:TYPE on page 307

[SENSe:] DEMod:FORMat:BANalyze on page 304

#### Channel Bandwidth to measure (CBW)

Defines the channel bandwidth of the PPDU taking part in the analysis. Depending on which standards the communicating devices are using, different PPDU formats and channel bandwidths are supported.

For details on supported PPDU formats and channel bandwidths depending on the standard see [Table 4-3](#).

**Note:** The terms in brackets in the following description indicate how the setting is referred to in the "Signal Field" result display ("Format" column, see ["Signal Field"](#) on page 52).

"Auto, same type as first PPDU""(A1st)"

The channel bandwidth of the first valid PPDU is detected and subsequent PPDU are analyzed only if they have the same channel bandwidth.

"Meas only ... signal""(M ...)"

Only PPDU with the specified channel bandwidth are analyzed

"Demod all as ... signal""(D ...)"

All PPDU are assumed to have the specified channel bandwidth

Remote command:

[SENSe:]BANDwidth:CHANnel:AUTO:TYPE on page 302

### MCS Index to use

Defines the PPDU taking part in the analysis depending on their Modulation and Coding Scheme (MCS) index.

**Note:** The terms in brackets in the following description indicate how the setting is referred to in the "Signal Field" result display ("Format" column, see "Signal Field" on page 52).

"Auto, same type as first PPDU""(A1st)"

All PPDU using the MCS index identical to the first recognized PPDU are analyzed.

" Auto, individually for each PPDU""(AI)"

All PPDU are analyzed

"Meas only the specified MCS""(M ...)"

Only PPDU with the MCS index specified for the [MCS Index](#) setting are analyzed

"Demod all with specified MCS""(D ...)"

The [MCS Index](#) setting is used for all PPDU.

Remote command:

[SENSe:]DEMod:FORMat:MCSindex:MODE on page 309

### MCS Index

Defines the MCS index of the PPDU taking part in the analysis manually. This field is enabled for "MCS index to use" = "Meas only the specified MCS" or "Demod all with specified MCS".

Remote command:

[SENSe:]DEMod:FORMat:MCSindex on page 309

### Nsts to use

Defines the PPDU taking part in the analysis depending on their Nsts.

**Note:** The terms in brackets in the following description indicate how the setting is referred to in the "Signal Field" result display ("NSTS" column, see "Signal Field" on page 52).

"Auto, same type as first PPDU""(A1st)"

All PPDU using the Nsts identical to the first recognized PPDU are analyzed.

" Auto, individually for each PPDU""(AI)"

All PPDU are analyzed

"Meas only the specified Nsts""(M ...)"

Only PPDU with the Nsts specified for the ["Nsts"](#) on page 158 setting are analyzed

"Demod all with specified Nsts""(D ...)"

The ["Nsts"](#) on page 158 setting is used for all PPDU.

Remote command:

[\[SENSe:\] DEMod: FORMat: NSTSindex: MODE](#) on page 310

### Nsts

Defines the Nsts of the PPDU's taking part in the analysis. This field is enabled for [Nsts to use](#) = "Meas only the specified Nsts" or "Demod all with specified Nsts".

Remote command:

[\[SENSe:\] DEMod: FORMat: NSTSindex](#) on page 310

### STBC Field

Defines the PPDU's taking part in the analysis according to the Space-Time Block Coding (STBC) field content.

**Note:** The terms in brackets in the following description indicate how the setting is referred to in the "Signal Field" result display ("Format" column, see ["Signal Field"](#) on page 52).

"Auto, same type as first PPDU" (A1st)

All PPDU's using a STBC field content identical to the first recognized PPDU are analyzed.

"Auto, individually for each PPDU" (AI)

All PPDU's are analyzed.

"Meas only if STBC field = 1 (+1 Stream)" (M1) [(IEEE 802.11N)]

Only PPDU's with the specified STBC field content are analyzed.

"Meas only if STBC field = 2 (+2 Stream)" (M2) [(IEEE 802.11N)]

Only PPDU's with the specified STBC field content are analyzed.

"Demod all as STBC field = 1" (D1) [(IEEE 802.11N)]

All PPDU's are analyzed assuming the specified STBC field content.

"Demod all as STBC field = 2" (D2) [(IEEE 802.11N)]

All PPDU's are analyzed assuming the specified STBC field content.

"Meas only if STBC = 1 (Nsts = 2Nss)" (M1) [(IEEE 802.11ac)]

Only PPDU's with the specified STBC field content are analyzed.

"Demod all as STBC = 1 (Nsts = 2Nss)" (D1) [(IEEE 802.11ac)]

All PPDU's are analyzed assuming the specified STBC field content.

Remote command:

[CONFigure: WLAN: STBC: AUTO: TYPE](#) on page 301

### Table info overview

Depending on the selected channel bandwidth, MCS index or NSS (STBC), the relevant information from the modulation and coding scheme (MCS) as defined in the WLAN 802.11 standard is displayed here. This information is for reference only, for example so you can determine the required data rate.

### Guard Interval Length

Defines the PPDU's taking part in the analysis depending on the guard interval length.

**Note:** The terms in brackets in the following description indicate how the setting is referred to in the "Signal Field" result display ("Format" column, see ["Signal Field"](#) on page 52).

"Auto, same type as first PPDU""(A1st)"

All PPDU using the guard interval length identical to the first recognized PPDU are analyzed.

"Auto, individually for each PPDU""(AI)"

All PPDU are analyzed.

"Meas only Short""(MS)"

Only PPDU with short guard interval length are analyzed.

"Meas only Long""(ML)"

Only PPDU with long guard interval length are analyzed.

"Demod all as short""(DS)"

All PPDU are demodulated assuming short guard interval length.

"Demod all as long""(DL)"

All PPDU are demodulated assuming long guard interval length.

Remote command:

[CONFigure:WLAN:GTIME:AUTO](#) on page 300

[CONFigure:WLAN:GTIME:AUTO:TYPE](#) on page 437

[CONFigure:WLAN:GTIME:SElect](#) on page 301

### 5.3.8.3 Demodulation - IEEE 802.11ax

**Access:** "Overview" > "Demodulation"

**Or:** [MEAS CONFIG] > "Demod."

The following settings are available for demodulation of IEEE 802.11ax signals.

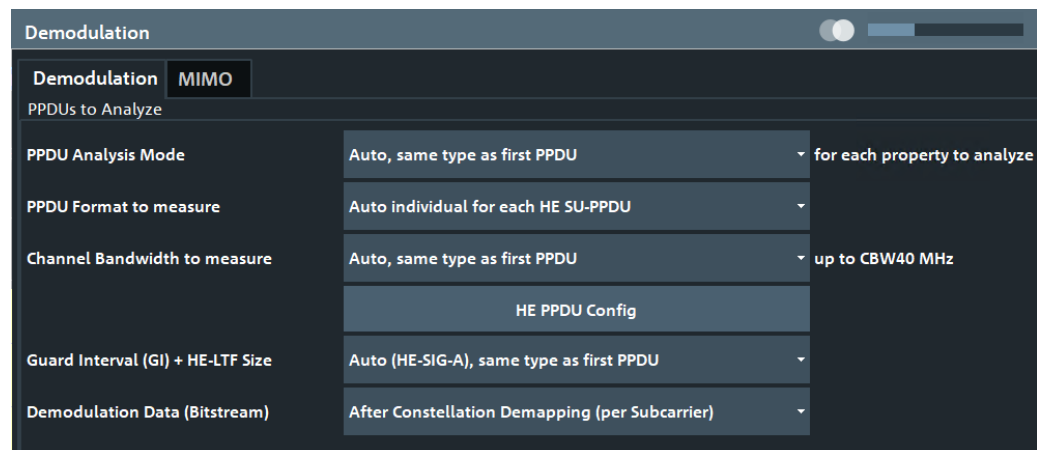

Figure 5-5: Demodulation settings for IEEE 802.11ax standard

PPDU Analysis Mode.....	160
PPDU Format to measure.....	160
Channel Bandwidth to measure (CBW).....	161
HE PDU Config.....	161
L HE PDU Format.....	162
L $N_{HE-LTF}$ .....	163
L Segment 1/2.....	163

L RU1-242 / RU2-242 / RU3-242 / RU4-242.....	163
L RU Count.....	163
L RU26 Index.....	163
L RU Index.....	163
L User Index.....	164
L RU Size.....	164
L MCS Index.....	164
L Nsts per User.....	164
L TX Beamforming.....	164
L DCM.....	165
L Coding.....	165
L Insert User.....	165
L Delete User.....	165
L Refresh.....	165
L OK.....	165
Guard Interval (GI) + HE-LTF Size.....	166
Demodulation Data (Bitstream).....	166

### PPDU Analysis Mode

Defines whether all or only specific PPDU are to be analyzed.

"Auto, same type as first PPDU"

The signal symbol field, i.e. the PLCP header field, of the first recognized PPDU is analyzed to determine the details of the PPDU. All PPDU identical to the first recognized PPDU are analyzed. All subsequent settings are set to "Auto" mode.

"Auto, individually for each PPDU"

All PPDU are analyzed

"User-defined"

User-defined settings define which PPDU are analyzed. This setting is automatically selected when any of the subsequent settings are changed to a value other than "Auto".

Remote command:

`[SENSe:] DEMod:FORMat [:BContent] :AUTO` on page 308

### PPDU Format to measure

Defines which PPDU formats are to be included in the analysis for standard **IEEE 802.11ax**.

**Note:** The PPDU format determines the available channel bandwidths.

In particular, extended range PPDU can only be measured with a channel bandwidth of 20 MHz. If you increase the [Channel Bandwidth to measure \(CBW\)](#), the "PPDU Format to measure" is automatically set to "Auto individual for each HE SU-PPDU".

For details on supported PPDU formats and channel bandwidths depending on the standard see [Table 4-3](#).

"Auto individual for each HE SU-PPDU / HE MU-PPDU / HE Trigger-based PPDU / HE Ext. Range SU-PPDU"

Only PPDU of the specified PPDU type are analyzed



"Demod all as specified HE PPDU"

All PPDU are assumed to have HE PPDU format as defined in the [HE PPDU Config](#) settings

Remote command:

`[SENSe:] DEMod:FORMat:BANalyze:BTYPe:AUTO:TYPE` on page 307

`[SENSe:] DEMod:FORMat:BANalyze` on page 304

### Channel Bandwidth to measure (CBW)

Defines the channel bandwidth of the PPDU taking part in the analysis. Depending on which standards the communicating devices are using, different PPDU formats and channel bandwidths are supported.

For details on supported PPDU formats and channel bandwidths depending on the standard see [Table 4-3](#).

**Note:** The available channel bandwidths depends on the selected PPDU format. In particular, extended range PPDU can only be measured with a channel bandwidth of 20 MHz. If you increase the "Channel Bandwidth to measure (CBW)", the [HE PPDU Format](#) is automatically set to "HE SU-PPDU".

"Auto, same type as first PPDU"

The channel bandwidth of the first valid PPDU is detected and subsequent PPDU are analyzed only if they have the same channel bandwidth.

"Meas only ... signal"

Only PPDU with the specified channel bandwidth are analyzed

"Demod all as ... signal"

All PPDU are assumed to have the specified channel bandwidth

Remote command:

`[SENSe:] BANDwidth:CHANnel:AUTO:TYPE` on page 302

### HE PPDU Config

Defines the PPDU configuration, which also contains the assignment of the stations (users) to the resource units (RUs), that is: the channels and subcarriers. For single user (HE SU-PPDU) and trigger-based PPDU (UL), the configuration is detected automatically by the R&S FSW WLAN application. For multi-user downlink PPDU (HE MU\_PPDU), you must define the configuration manually.

For trigger-based PPDU, you must also define the length of the HE-LTF field in the PPDU in the R&S FSW WLAN application.

#	RU Count	RU26 Index	RU Index	User Index	RU Size	MCS Index	Nsts per User	TX Beam-forming	DCM	Coding
1	1	1	1	1	SU	0	1	0	0	0
2										
3										
4										
5										
6										
7										

**Note:** Result displays for multi-user PPDUs. For multi-user PPDUs, the result displays show the demodulated data for an individual RU at a time. In continuous sweep measurements, the results for the first RU defined in the PPDU configuration table are displayed. In single sweep measurements, you can scroll through the RUs in the table to view the results. The currently displayed RU is highlighted green in the PPDU configuration table. To view the results of a different RU, select the RU in the table, then [Refresh](#).

For details on PPDU configuration see also [Chapter 4.4, "Signal processing for high-efficiency wireless measurements \(IEEE 802.11ax\)"](#), on page 87.

#### HE PPDU Format ← HE PPDU Config

Defines the format of the HE PPDU. This format determines which other PPDU settings are available.

Note that the R&S FSW WLAN application performs plausibility checks concerning the number of RUs, RU sizes, and number of users over all segments and RU configuration tabs according to the 802.11ax standard.

"HE SU-PPDU (DL,UL)" High-efficiency single user PPDU for uplink and downlink

"HE MU-PPDU (DL)" High-efficiency multi-user PPDU for downlink to multiple users at the same time

"HE Trigger-based PPDU (UL)" High-efficiency trigger-based PPDU for uplink from multiple users at the same time

"HE Ext Range High-efficiency single-user PPDU for an extended range SU-PPDU"

Remote command:

[CONFigure:WLAN:RUConfig:HEPPdu](#) on page 313

#### **$N_{HE-LTF}$ ← HE PPDU Config**

Defines the length of the high-efficiency long training field (for **trigger-based uplink PPDUs only**). For more information see "[HE Trigger-based PPDUs](#)" on page 91.

"Auto" The length is determined automatically by the application.

"As Configured STA" The station configuration defines the used length.

"1 / 2 / 4 / 6 / 8 Symbols" The LTF of the PPDUs have a fixed length.

Remote command:

[CONFigure:WLAN:RUConfig:NHELtf](#) on page 313

#### **Segment 1/2 ← HE PPDU Config**

For **160 MHz** channels and multi-user downlink PPDUs (**MU-PPDU (DL)**) **only**: switches between the two possible 80-MHz-segments (242 tones) of the channel to be configured

#### **RU1-242 / RU2-242 / RU3-242 / RU4-242 ← HE PPDU Config**

Switches between the four possible RU allocation configuration tabs for channel bandwidths larger than 20 MHz. Each RU allocation tab configures the resource units for a 20 MHz channel.

A maximum of 9 resource units (with 26 subcarriers each) can be configured for any 20 MHz span.

#### **RU Count ← HE PPDU Config**

The number of used RUs for a single PPDU. Used to connect the results to the PPDU configuration. Up to 9 resource units can be configured for each subchannel, depending on the [RU Size](#).

#### **RU26 Index ← HE PPDU Config**

The index of the resource unit based on 26-subcarrier units. Values from 1 to 74 are possible.

Remote command:

[CONFigure:WLAN:RUConfig:SEGment<seg>:CHANnel<ch>:RULocation<cf>:RU26index](#) on page 315

#### **RU Index ← HE PPDU Config**

The index of the resource unit as defined by the 802.11ax standard. This value determines the position of the resource unit within the channel.

Remote command:

[CONFigure:WLAN:RUConfig:SEGment<seg>:CHANnel<ch>:RULocation<cf>:COUNT:HIGHest?](#) on page 314

**User Index ← HE PPDU Config**

The index of the user assigned to the resource unit. In standard transmissions, only one user is assigned to each RU. In MIMO transmissions, up to 8 users can be assigned to one RU (depending on the size of the RU).

Remote command:

`CONFigure:WLAN:RUConfig:SEGment<seg>:CHANnel<ch>:RULocation<cf>:USER:COUNT?` on page 317

**RU Size ← HE PPDU Config**

Size of the individual resource unit (= number of subcarriers or tones) for a single transmission package.

Remote command:

`CONFigure:WLAN:RUConfig:SEGment<seg>:CHANnel<ch>:RULocation<cf>:RUSize` on page 316

**MCS Index ← HE PPDU Config**

Modulation and Coding Scheme (MCS) index of the PPDU

- 0: BPSK 1/2
- 1: QPSK 1/2
- 2: QPSK 3/4
- 3: 16-QAM 1/2
- 4: 16-QAM 3/4
- 5: 64-QAM 2/3
- 6: 64-QAM 3/4
- 7: 64-QAM 5/6
- 8: 256-QAM 3/4
- 9: 256-QAM 5/6
- 10: 1024-QAM 3/4
- 11: 1024-QAM 5/6

Remote command:

`CONFigure:WLAN:RUConfig:SEGment<seg>:CHANnel<ch>:RULocation<cf>:USER<mu>:MCSindex` on page 321

**Nsts per User ← HE PPDU Config**

For **MIMO** measurements only:

Number of space-time streams (NSTS) assigned to an individual user

Remote command:

`CONFigure:WLAN:RUConfig:SEGment<seg>:CHANnel<ch>:RULocation<cf>:USER<mu>:NSTS` on page 322

**TX Beamforming ← HE PPDU Config**

Use of transmit beamforming

- [1] Beamforming is applied
- [0] No beamforming applied

Remote command:

`CONFigure:WLAN:RUConfig:SEGment<seg>:CHANnel<ch>:RULocation<cf>:USER<mu>:TBEamforming` on page 322

**DCM ← HE PPDU Config**

Dual carrier modulation

- [1] DCM is used
- [0] DCM not used

Remote command:

[CONFigure:WLAN:RUConfig:SEGMENT<seg>:CHANnel<ch>:RULocation<cf>:USER<mu>:DCM](#) on page 319

**Coding ← HE PPDU Config**

The type of coding used by the PPDU

- [1] LDPC is used
- [0] BCC is used

Remote command:

[CONFigure:WLAN:RUConfig:SEGMENT<seg>:CHANnel<ch>:RULocation<cf>:USER<mu>:CODing](#) on page 318

**Insert User ← HE PPDU Config**

For **HE Multi-User Downlink PPDUs** that support **MIMO** only:

Adds another user (station) for the selected resource unit (RU) to the configuration table.

A maximum of 8 users can be assigned to a single resource unit in MIMO mode.

This function is only available for RU sizes of at least 106 subcarriers.

Remote command:

[CONFigure:WLAN:RUConfig:SEGMENT<seg>:CHANnel<ch>:RULocation<cf>:USER<mu>:INSert](#) on page 320

**Delete User ← HE PPDU Config**

Deletes the selected user (station) from the HE Multi-User Downlink PPDU configuration table (for **MIMO** configuration only).

Remote command:

[CONFigure:WLAN:RUConfig:SEGMENT<seg>:CHANnel<ch>:RULocation<cf>:USER<mu>:DELeTe](#) on page 319

**Refresh ← HE PPDU Config**

Updates the result displays for the currently selected RUs in the PPDU configuration table.

See "[Result displays for multi-user PPDUs](#)" on page 91.

Remote command:

[CONFigure:WLAN:RUConfig:REFresh](#) on page 313

**OK ← HE PPDU Config**

Saves the changes to the table and closes the dialog box.

**Guard Interval (GI) + HE-LTF Size**

Defines the PPDUs taking part in the analysis depending on the guard interval (GI) and HE long training field (LTF) length.

"Auto (HE-SIG-A), same type as first PPDU"

All HE PPDUs using the guard interval length identical to the first recognized PPDU are analyzed.

"Auto (HE-SIG-A), individually for each PPDU"

All HE PPDUs are analyzed.

"Meas only 4.0µs (1x HE-LTF + 1x GI1 = 3.2 + 0.8 µs)"

Only HE PPDUs with one long training field (LTF) and one guard interval (GI) with the specified length are analyzed.  
Not available for HE trigger-based PPDUs.

"Meas only 4.8µs (1x HE-LTF + 2x GI1 = 3.2 + 1.6µs)"

Only HE PPDUs with one long training field (LTF) and two guard intervals (GI) with the specified length are analyzed.  
For HE trigger-based PPDUs only.

"Meas only 7.2µs (2x HE-LTF + 1x GI1 = 6.4 + 0.8µs)"

Only HE PPDUs with two long training field (LTF) and one guard interval (GI) with the specified length are analyzed.

"Meas only 8.0µs (2x HE-LTF + 2x GI1 = 6.4 + 1.6µs)"

Only HE PPDUs with two long training fields (LTF) and two guard intervals (GI) with the specified length are analyzed.

"Meas only 13.6µs (4x HE-LTF + 1x GI1 = 12.8 + 0.8µs)"

Only HE PPDUs with four long training fields (LTF) and one guard interval (GI) with the specified length are analyzed.

"Meas only  
16.0µs (4x HE-  
LTF + 4x GI1 =  
12.8 + 3.2µs)"

Only HE PPDUs with four long training fields (LTF) and four guard intervals (GI) with the specified length are analyzed.

Remote command:

[CONFigure:WLAN:GTIme:AUTO](#) on page 300

[CONFigure:WLAN:GTIme:AUTO:TYPE](#) on page 437

[CONFigure:WLAN:GTIme:SElect](#) on page 301

**Demodulation Data (Bitstream)**

Defines when in the demodulation process the bitstream is determined and thus which results are available.

See also [Chapter 3.1.1.9, "BER and CWER"](#), on page 26.

"After Constel-  
lation Demap-  
ping (per Sub-  
carrier)"

(Default:) No channel decoding is performed. Processing time is reduced, but BER and CWER results are not available.

"After  
LDPC/BCC  
Decoder"

Decoding is performed, providing BER and CWER results. Measurement time is increased compared to non-decoding process.

Remote command:

[SENSe:] DEMod:DATA on page 303

#### 5.3.8.4 Demodulation - IEEE 802.11be

**Access:** "Overview" > "Demodulation"

**Or:** [MEAS CONFIG] > "Demod."

The following settings are available for demodulation of IEEE 802.11be signals.

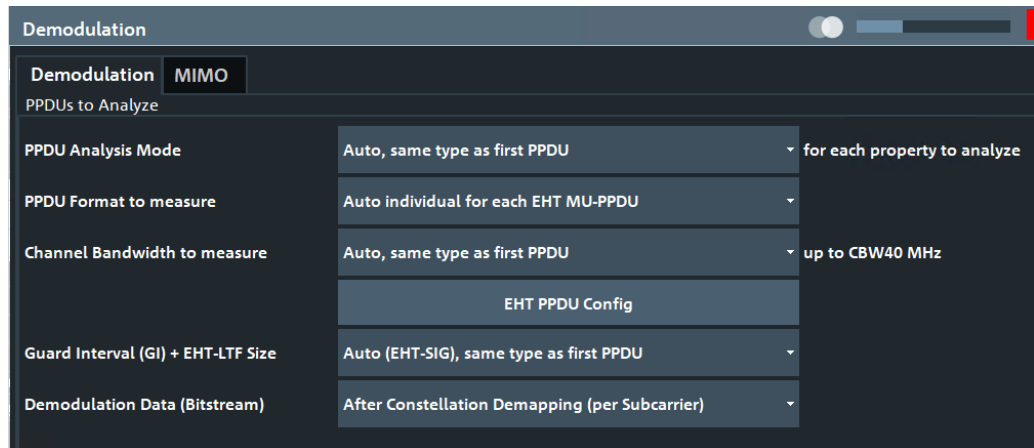

Figure 5-6: Demodulation settings for IEEE 802.11be standard



#### Result displays for multi-user PPDUs

The result displays show the demodulated data for the selected RUs. The currently displayed RUs are highlighted green in the PPDU configuration table and the result displays. For multi-user configuration, the results cannot be displayed for an individual user. If you select an RU, the rows for all users of the RU are highlighted.

By default, the first RU is selected. To view the results of different RUs, select the RUs in the table by clicking in the first column ("#"), then [Refresh](#).

PPDU Analysis Mode.....	168
PPDU Format to measure.....	168
Channel Bandwidth to measure (CBW).....	169
EHT PPDU Config.....	169
L EHT PPDU Format.....	171
L $N_{\text{EHT-LTF}}$ .....	171
L Segment 1/2/3/4.....	171
L RU1-242 / RU2-242 / RU3-242 / RU4-242.....	171
L RU number.....	171
L RU Count.....	172
L RU26 Index.....	172
L RU Index.....	172
L User Index.....	172
L RU Size.....	172

L MRU Index.....	172
L MCS Index.....	173
L Nsts per User.....	173
L TX Beamforming.....	173
L DCM.....	173
L Coding.....	173
L Insert User.....	174
L Delete User.....	174
L Select All.....	174
L Deselect All.....	174
L Refresh.....	174
L OK.....	174
Guard Interval (GI) + EHT-LTF Size.....	174
Demodulation Data (Bitstream).....	175

### PPDU Analysis Mode

Defines whether all or only specific PPDU are to be analyzed.

"Auto, same type as first PPDU"

The signal symbol field, i.e. the PLCP header field, of the first recognized PPDU is analyzed to determine the details of the PPDU. All PPDU identical to the first recognized PPDU are analyzed. All subsequent settings are set to "Auto" mode.

"Auto, individually for each PPDU"

All PPDU are analyzed

"User-defined"

User-defined settings define which PPDU are analyzed. This setting is automatically selected when any of the subsequent settings are changed to a value other than "Auto".

Remote command:

[SENSe:] DEMod: FORMat [: BCONtent] : AUTO on page 308

### PPDU Format to measure

Defines which PPDU formats are to be included in the analysis for standard **IEEE 802.11be**.

For details on supported PPDU formats and channel bandwidths depending on the standard see [Table 4-3](#).

"Auto, same type as first PPDU"

The format of the first valid PPDU is detected and subsequent PPDU are analyzed only if they have the same format.

"Demod all as specified EHT PPDU"

All PPDU are assumed to have EHT PPDU format as defined in the [EHT PPDU Config](#) settings

"Auto individual for each EHT MU-PPDU"

Signal is decoded and analyzed according to the U-SIG and EHT-SIG content. The decoded information is indicated in the [EHT PPDU Config](#) settings.



"Auto individual for each EHT Trigger-based PPDU"

Signal is decoded and analyzed according to the U-SIG content. The decoded information is indicated in the [EHT PPDU Config](#) settings.

Remote command:

[SENSE:] DEMod:FORMat:BANalyze:BTYPe:AUTO:TYPE on page 307

[SENSE:] DEMod:FORMat:BANalyze on page 304

### Channel Bandwidth to measure (CBW)

Defines the channel bandwidth of the PPDUs taking part in the analysis. Depending on which standards the communicating devices are using, different PPDU formats and channel bandwidths are supported.

For details on supported PPDU formats and channel bandwidths depending on the standard see [Table 4-3](#).

**Note:** The available channel bandwidths depend on the selected PPDU format.

"Auto, same type as first PPDU"

The channel bandwidth of the first valid PPDU is detected and subsequent PPDUs are analyzed only if they have the same channel bandwidth.

"Meas only ... signal"

Only PPDUs with the specified channel bandwidth are analyzed

"Demod all as ... signal"

All PPDUs are assumed to have the specified channel bandwidth

Remote command:

[SENSE:] BANDwidth:CHANnel:AUTO:TYPE on page 302

### EHT PPDU Config

Defines the PPDU configuration, which also contains the assignment of the stations (users) to the resource units (RUs), that is: the channels and subcarriers. For multi-user downlink PPDUs (EHT MU\_PPDU), you must define the configuration manually.

EHT PPDU Configuration

EHT PPDU Format: EHT MU PPDU (DL) | N<sub>EHT-LTF</sub>: As Configured AP/STA

Segment 1 | Segment 2 | Segment 3 | Segment 4

RU1-242 | RU2-242 | RU3-242 | RU4-242

#	RU Count	RU26 Index	RU Index	User Index	RU Size	MRU Index	MCS Index	Nsts per User	TX Beam-forming	DCM	Coding
1	1	1	1	1	26	1	9	1	0	0	0
2	2	2	2	1	26	1	10	1	0	0	0
3	3	3	3	1	26	1	1	1	0	0	0
4	4	4	4	1	26	1	10	1	0	0	0
5	5	5	5	1	26	1	7	1	0	0	0
6	6	6	6	1	26	1	1	1	0	0	0
7	7	7	7	1	26	1	3	1	0	0	0
8	8	8	8	1	26	1	6	1	0	0	0

Buttons: Insert User, Delete User, Select All, Deselect All, Refresh, OK, Cancel

**Note:** Result displays for multi-user PPDUs.

The result displays show the demodulated data for the selected RUs. The currently displayed RUs are highlighted green in the PPDU configuration table and the result displays. For multi-user configuration, the results cannot be displayed for an individual user. If you select an RU, the rows for all users of the RU are highlighted.

By default, the first RU is selected. To view the results of different RUs, select the RUs in the table by clicking in the first column ("#"), then [Refresh](#).

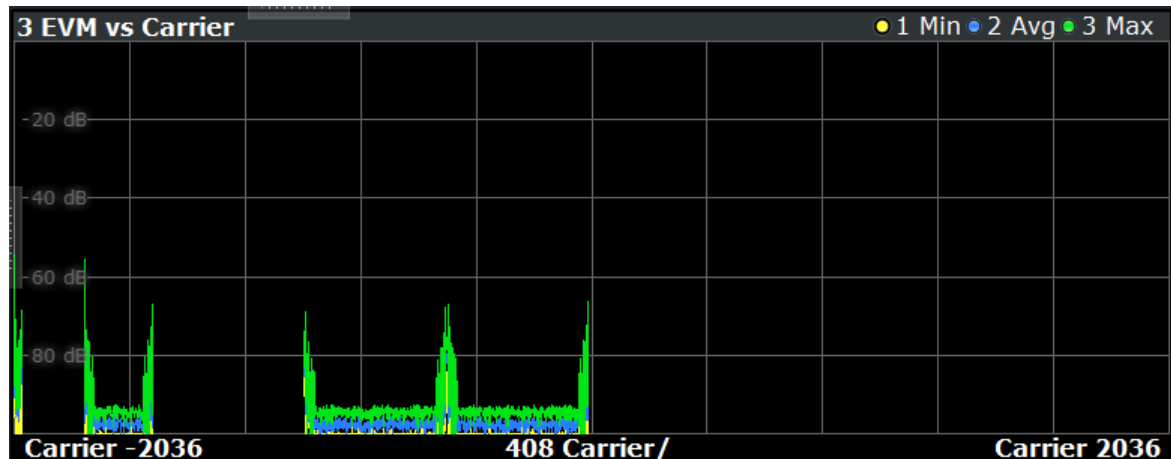

Figure 5-7: Result display for all RUs except 2 and 5

For details on PPDU configuration see also [Chapter 4.5, "Signal processing for extremely high throughput \(EHT\) wireless measurements \(IEEE 802.11be\)"](#), on page 92.

**EHT PPDU Format ← EHT PPDU Config**

Defines the format of the EHT PPDU. This format determines which other PPDU settings are available.

Note that the R&S FSW WLAN application does not perform plausibility checks concerning the number of RUs, RU sizes, and number of users over all segments and RU configuration tabs according to the 802.11be standard.

"EHT MU PPDU (DL)"

Extremely high throughput multi-user PPDU for downlink

"EHT Trigger-based PPDU (UL)"

Extremely high throughput trigger-based PPDU for uplink

Remote command:

[CONFigure:WLAN:RUConfig:EHTPpdu](#) on page 312

**N<sub>EHT-LTF</sub> ← EHT PPDU Config**

Defines the length of the high-efficiency long training field. For more information see "[HE Trigger-based PPDUs](#)" on page 91.

"Auto" The length is determined automatically by the application.

"As Configured AP/STA"

The access point or station configuration defines the used length.

"1 / 2 / 4 / 6 / 8 Symbols"

The LTF of the PPDUs have a fixed length.

Remote command:

[CONFigure:WLAN:RUConfig:NHELtf](#) on page 313

**Segment 1/2/3/4 ← EHT PPDU Config**

For **160 MHz/320 MHz** channels only: switches between the four possible 80-MHz-segments (4\*242 tones) of the channel to be configured.

**RU1-242 / RU2-242 / RU3-242 / RU4-242 ← EHT PPDU Config**

Switches between the four possible RU allocation configuration tabs for channel bandwidths larger than 20 MHz. Each RU allocation tab configures the resource units for a 20 MHz channel.

A maximum of 9 resource units (with 26 subcarriers each) can be configured for any 20 MHz span.

**RU number ← EHT PPDU Config**

Consecutive number of the RUs for a single user and PPDU. Select the number to toggle the selection of results to be displayed. Highlighted rows are selected.

**Note:** For multi-user configuration, the results cannot be displayed for an individual user. If you select an RU, the rows for all users of the RU are highlighted.

Remote command:

[CONFigure:WLAN:RUConfig:COUNT:ACTive](#) on page 312

**RU Count ← EHT PPDU Config**

The number of used RUs for a single PPDU. Used to connect the results to the PPDU configuration. Up to 9 resource units can be configured for each subchannel (=242 subcarriers). The RU Count for the 80-MHz-segments (RU1-242, RU2-242, RU3-242, RU4-242) is cumulative.

**RU26 Index ← EHT PPDU Config**

The index of the resource unit based on 26-subcarrier units. Values from 1 to 144 are possible.

Remote command:

`CONFigure:WLAN:RUConfig:SEGMENT<seg>:CHANnel<ch>:RULocation<cf>:RU26index` on page 315

**RU Index ← EHT PPDU Config**

The index of the resource unit as defined by the 802.11be standard (based on resource units of the specified [RU Size](#)). This value determines the position of the resource unit within the channel. Values from 1 to 144 are possible, depending on the [RU Size](#).

Remote command:

`CONFigure:WLAN:RUConfig:SEGMENT<seg>:CHANnel<ch>:RULocation<cf>:RUIndex` on page 315

`CONFigure:WLAN:RUConfig:SEGMENT<seg>:CHANnel<ch>:RULocation<cf>:COUNT:HIGHEst?` on page 314

**User Index ← EHT PPDU Config**

The index of the user assigned to the resource unit. In standard transmissions, only one user is assigned to each RU. In MIMO transmissions, up to 8 users can be assigned to one RU (depending on the size of the RU). MIMO is only supported for RUs with at least 242 subcarriers.

Remote command:

`CONFigure:WLAN:RUConfig:SEGMENT<seg>:CHANnel<ch>:RULocation<cf>:USER:COUNT?` on page 317

**RU Size ← EHT PPDU Config**

Size of the individual resource unit (= number of subcarriers or tones) for a single transmission package.

Remote command:

`CONFigure:WLAN:RUConfig:SEGMENT<seg>:CHANnel<ch>:RULocation<cf>:RUSize` on page 316

**MRU Index ← EHT PPDU Config**

Index of the subcarrier and resource allocation for multiple RUs (MRU) as defined by the 802.11be standard. This index determines the position of the ignored subcarriers and used RUs within the spectrum. Depending on the MRU size, values from 1 up to 12 are possible.

Remote command:

`CONFigure:WLAN:RUConfig:SEGMENT<seg>:CHANnel<ch>:RULocation<cf>:MRUindex` on page 314

**MCS Index ← EHT PDU Config**

Modulation and Coding Scheme (MCS) index of the PDU

- 0: BPSK 1/2
- 1: QPSK 1/2
- 2: QPSK 3/4
- 3: 16-QAM 1/2
- 4: 16-QAM 3/4
- 5: 64-QAM 2/3
- 6: 64-QAM 3/4
- 7: 64-QAM 5/6
- 8: 256-QAM 3/4
- 9: 256-QAM 5/6
- 10: 1024-QAM 3/4
- 11: 1024-QAM 5/6
- 12: 4096-QAM 3/4
- 13: 4096-QAM 5/6

Remote command:

`CONFigure:WLAN:RUConfig:SEGment<seg>:CHANnel<ch>:RULocation<cf>:USER<mu>:MCSindex` on page 321

**Nsts per User ← EHT PDU Config**

For MIMO measurements only:

Number of space-time streams (NSTS) for each user

Remote command:

`CONFigure:WLAN:RUConfig:SEGment<seg>:CHANnel<ch>:RULocation<cf>:USER<mu>:NSTS` on page 322

**TX Beamforming ← EHT PDU Config**

Use of transmit beamforming

- [1] Beamforming is applied
- [0] No beamforming applied

Remote command:

`CONFigure:WLAN:RUConfig:SEGment<seg>:CHANnel<ch>:RULocation<cf>:USER<mu>:TBeamforming` on page 322

**DCM ← EHT PDU Config**

Dual carrier modulation

- [1] DCM is used
- [0] DCM not used

Remote command:

`CONFigure:WLAN:RUConfig:SEGment<seg>:CHANnel<ch>:RULocation<cf>:USER<mu>:DCM` on page 319

**Coding ← EHT PDU Config**

The type of coding used by the PDU

- [1] LDPC is used

[0] BCC is used

Remote command:

`CONFigure:WLAN:RUConfig:SEGment<seg>:CHANnel<ch>:RULocation<cf>:USER<mu>:CODing` on page 318

#### **Insert User ← EHT PPDU Config**

For PPDUs that support **MIMO** only:

Adds another user (station) for the selected resource unit (RU) to the configuration table.

A maximum of 8 users can be assigned to a single resource unit in MIMO mode.

This function is only available for RU sizes of at least 106 subcarriers.

Remote command:

`CONFigure:WLAN:RUConfig:SEGment<seg>:CHANnel<ch>:RULocation<cf>:USER<mu>:INSert` on page 320

#### **Delete User ← EHT PPDU Config**

Deletes the selected user (station) from the HE Multi-User Downlink PPDU configuration table (for **MIMO** configuration only).

Remote command:

`CONFigure:WLAN:RUConfig:SEGment<seg>:CHANnel<ch>:RULocation<cf>:USER<mu>:DELeTe` on page 319

#### **Select All ← EHT PPDU Config**

Selects all RUs for the result display. Selected RUs are highlighted green.

#### **Deselect All ← EHT PPDU Config**

Deselects all RUs excepts the first RU for the result display. Only the first RU is highlighted.

#### **Refresh ← EHT PPDU Config**

Updates the result displays for the currently selected RUs in the PPDU configuration table.

See "[Result displays for multi-user PPDUs](#)" on page 91.

Remote command:

`CONFigure:WLAN:RUConfig:REFresh` on page 313

#### **OK ← EHT PPDU Config**

Saves the changes to the table and closes the dialog box.

#### **Guard Interval (GI) + EHT-LTF Size**

Defines the PPDUs taking part in the analysis depending on the guard interval (GI) and the EHT long training field (LTF) length.

"Auto (EHT-SIG), same type as first PPDU"

All PPDUs using the guard interval length identical to the first recognized PPDU are analyzed.

"Auto (EHT-SIG), individually for each PPDU"

All PDUs are analyzed.

"Meas only 4.0µs (1x EHT-LTF + 1x GI1 = 3.2 + 0.8 µs)"

Only EHT PDUs with one long training field (LTF) and one guard interval (GI) with the specified length are analyzed.

Not available for HE trigger-based PDUs.

"Meas only 4.8µs (1x EHT-LTF + 2x GI1 = 3.2 + 1.6µs)"

Only EHT PDUs with one long training field (LTF) and two guard intervals (GI) with the specified length are analyzed.

"Meas only 7.2µs (2x EHT-LTF + 1x GI1 = 6.4 + 0.8µs)"

Only EHT PDUs with two long training field (LTF) and one guard interval (GI) with the specified length are analyzed.

"Meas only 8.0µs (2x EHT-LTF + 2x GI1 = 6.4 + 1.6µs)"

Only HEHTE PDUs with two long training fields (LTF) and two guard intervals (GI) with the specified length are analyzed.

"Meas only 13.6µs (4x EHT-LTF + 1x GI1 = 12.8 + 0.8µs)"

Only EHT PDUs with four long training fields (LTF) and one guard interval (GI) with the specified length are analyzed.

"Meas only 16.0µs (4x EHT-LTF + 4x GI1 = 12.8 + 3.2µs)"

Only EHT PDUs with four long training fields (LTF) and four guard intervals (GI) with the specified length are analyzed.

Remote command:

[CONFigure:WLAN:GTIME:AUTO](#) on page 300

[CONFigure:WLAN:GTIME:AUTO:TYPE](#) on page 437

[CONFigure:WLAN:GTIME:SElect](#) on page 301

#### Demodulation Data (Bitstream)

Defines when in the demodulation process the bitstream is determined and thus which results are available.

See also [Chapter 3.1.1.9, "BER and CWER"](#), on page 26.

"After Constellation Demapping (per Sub-carrier)" (Default:) No channel decoding is performed. Processing time is reduced, but BER and CWER results are not available.

"After LDPC/BCC Decoder" Decoding is performed, providing BER and CWER results. Measurement time is increased compared to non-decoding process.

Remote command:

[\[SENSe:\] DEMod:DATA](#) on page 303

#### 5.3.8.5 Demodulation - IEEE 802.11b, g (DSSS)

**Access:** "Overview" > "Demodulation"

**Or:** [MEAS CONFIG] > "Demod."

The following settings are available for demodulation of IEEE 802.11b or g (DSSS) signals.

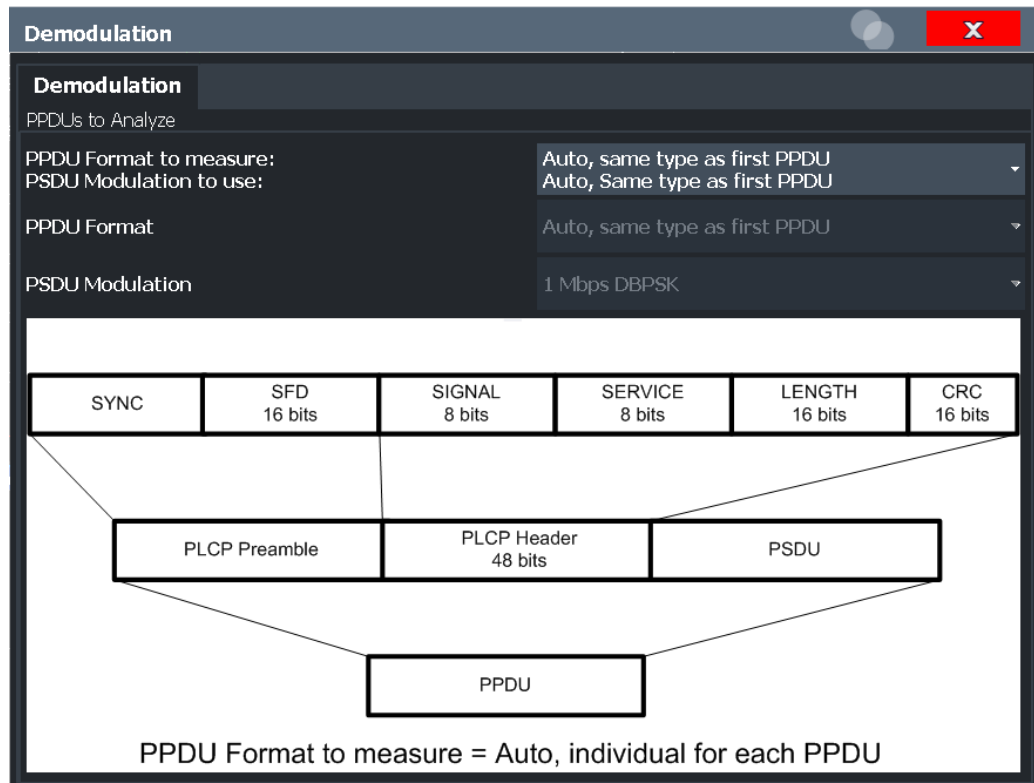

Figure 5-8: Demodulation settings for IEEE 802.11b, g (DSSS) signals

PPDU Format to measure[/] PSDU Modulation to use..... 176  
 PPDU Format..... 177  
 PSDU Modulation..... 177

**PPDU Format to measure[/] PSDU Modulation to use**

Defines which PPDU formats/modulations are to be included in the analysis. Depending on which standards the communicating devices are using, different formats of PPDUs are available. Thus you can restrict analysis to the supported formats.

**Note:** The PPDU format determines the available channel bandwidths.

For details on supported PPDU formats, modulations, and channel bandwidths depending on the standard see [Table 4-3](#).

"Auto, same type as first PPDU"

The format/modulation of the first valid PPDU is detected and subsequent PPDUs are analyzed only if they have the same format.

"Auto, individually for each PPDU"

All PPDUs are analyzed regardless of their format/modulation

"Meas only ..."

Only PPDUs with the specified format or PSDUs with the specified modulation are analyzed



"Demod all as ..."

All PPDUs are assumed to have the specified PPDU format/ PSDU modulation

Remote command:

[SENSe:] DEMod:FORMat:BANalyze:BTYPe:AUTO:TYPE on page 307

[SENSe:] DEMod:FORMat:BANalyze on page 304

[SENSe:] DEMod:FORMat:SIGSymbol on page 311

#### PPDU Format

If analysis is restricted to PPDUs with a particular format (see [PPDU Format to measure\[/\] PSDU Modulation to use](#)), this setting defines which type.

For details on supported modulation depending on the standard see [Table 4-3](#).

Remote command:

[SENSe:] DEMod:FORMat:BANalyze on page 304

[SENSe:] DEMod:FORMat:BANalyze:BTYPe on page 306

#### PSDU Modulation

If analysis is restricted to PSDU with a particular modulation type, this setting defines which type.

For details on supported modulation depending on the standard see [Table 4-3](#).

Remote command:

[SENSe:] DEMod:FORMat:BANalyze on page 304

### 5.3.8.6 Demodulation - IEEE 802.11n

**Access:** "Overview" > "Demodulation"

**Or:** [MEAS CONFIG] > "Demod."

The following settings are available for demodulation of IEEE 802.11n signals.

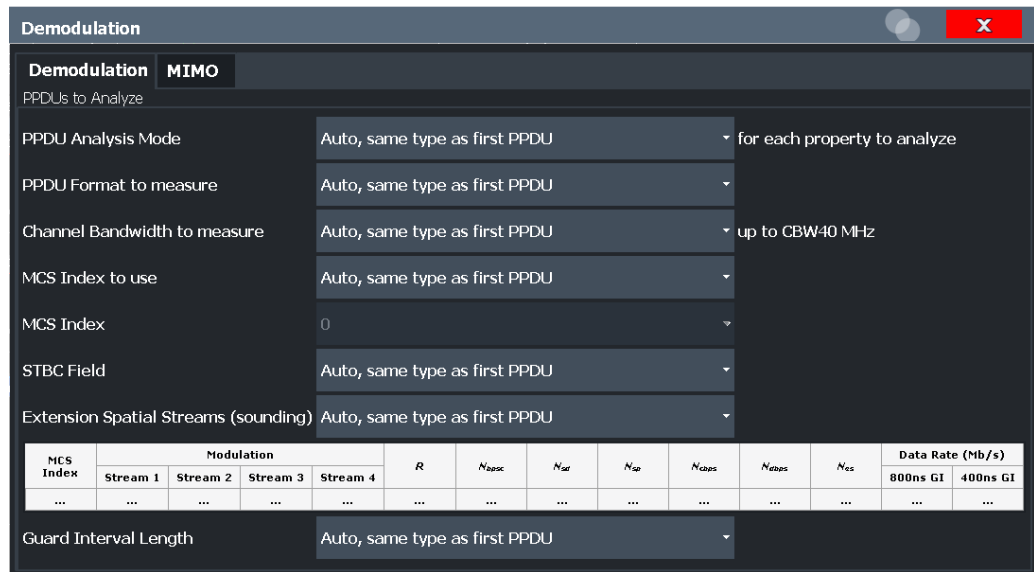

Figure 5-9: Demodulation settings for IEEE 802.11n standard

PPDU Analysis Mode..... 178  
 PPDU Format to measure..... 179  
 Channel Bandwidth to measure (CBW)..... 179  
 MCS Index to use..... 179  
 MCS Index..... 180  
 STBC Field..... 180  
 Extension Spatial Streams (sounding)..... 181  
 Table info overview..... 181  
 Guard Interval Length..... 181

**PPDU Analysis Mode**

Defines whether all or only specific PPDU are to be analyzed.

"Auto, same type as first PPDU"

The signal symbol field, i.e. the PLCP header field, of the first recognized PPDU is analyzed to determine the details of the PPDU. All PPDU identical to the first recognized PPDU are analyzed. All subsequent settings are set to "Auto" mode.

"Auto, individually for each PPDU"

All PPDU are analyzed

"User-defined"

User-defined settings define which PPDU are analyzed. This setting is automatically selected when any of the subsequent settings are changed to a value other than "Auto".

Remote command:

[SENSe:] DEMod:FORMat [:BContent] :AUTO on page 308

**PPDU Format to measure**

Defines which PPDU formats are to be included in the analysis. Depending on which standards the communicating devices are using, different formats of PDUs are available. Thus you can restrict analysis to the supported formats.

**Note:** The PPDU format determines the available channel bandwidths.

For details on supported PPDU formats and channel bandwidths depending on the standard see [Table 4-3](#).

**Note:** The terms in brackets in the following description indicate how the setting is referred to in the "Signal Field" result display ("Format" column).

"Auto, same type as first PPDU (A1st)"

The format of the first valid PPDU is detected and subsequent PDUs are analyzed only if they have the same format.

"Auto, individually for each PPDU (AI)"

All PDUs are analyzed regardless of their format

"Meas only ... (M ...)"

Only PDUs with the specified format are analyzed

"Demod all as ... (D ...)"

All PDUs are assumed to have the specified PPDU format

Remote command:

[\[SENSe:\] DEMod: FORMat: BANalyze: BTYPE: AUTO: TYPE](#) on page 307

[\[SENSe:\] DEMod: FORMat: BANalyze](#) on page 304

**Channel Bandwidth to measure (CBW)**

Defines the channel bandwidth of the PDUs taking part in the analysis. Depending on which standards the communicating devices are using, different PPDU formats and channel bandwidths are supported.

For details on supported PPDU formats and channel bandwidths depending on the standard see [Table 4-3](#).

**Note:** The terms in brackets in the following description indicate how the setting is referred to in the "Signal Field" result display ("Format" column, see ["Signal Field"](#) on page 52).

"Auto, same type as first PPDU" (A1st)"

The channel bandwidth of the first valid PPDU is detected and subsequent PDUs are analyzed only if they have the same channel bandwidth.

"Meas only ... signal" (M ...)"

Only PDUs with the specified channel bandwidth are analyzed

"Demod all as ... signal" (D ...)"

All PDUs are assumed to have the specified channel bandwidth

Remote command:

[\[SENSe:\] BANDwidth: CHANnel: AUTO: TYPE](#) on page 302

**MCS Index to use**

Defines the PDUs taking part in the analysis depending on their Modulation and Coding Scheme (MCS) index.

**Note:** The terms in brackets in the following description indicate how the setting is referred to in the "Signal Field" result display ("Format" column, see "Signal Field" on page 52).

"Auto, same type as first PPDU""(A1st)"

All PDUs using the MCS index identical to the first recognized PDU are analyzed.

" Auto, individually for each PPDU""(AI)"

All PDUs are analyzed

"Meas only the specified MCS""(M ...)"

Only PDUs with the MCS index specified for the [MCS Index](#) setting are analyzed

"Demod all with specified MCS""(D ...)"

The [MCS Index](#) setting is used for all PDUs.

Remote command:

[\[SENSe:\]DEMod:FORMat:MCSindex:MODE](#) on page 309

### MCS Index

Defines the MCS index of the PDUs taking part in the analysis manually. This field is enabled for "MCS index to use" = "Meas only the specified MCS" or "Demod all with specified MCS".

Remote command:

[\[SENSe:\]DEMod:FORMat:MCSindex](#) on page 309

### STBC Field

Defines the PDUs taking part in the analysis according to the Space-Time Block Coding (STBC) field content.

**Note:** The terms in brackets in the following description indicate how the setting is referred to in the "Signal Field" result display ("Format" column, see "Signal Field" on page 52).

"Auto, same type as first PPDU""(A1st)"

All PDUs using a STBC field content identical to the first recognized PDU are analyzed.

"Auto, individually for each PPDU""(AI)"

All PDUs are analyzed.

"Meas only if STBC field = 1 (+1 Stream)""(M1)"[(IEEE 802.11N)]

Only PDUs with the specified STBC field content are analyzed.

"Meas only if STBC field = 2 (+2 Stream)""(M2)"[(IEEE 802.11N)]

Only PDUs with the specified STBC field content are analyzed.

"Demod all as STBC field = 1""(D1)"[(IEEE 802.11N)]

All PDUs are analyzed assuming the specified STBC field content.

"Demod all as STBC field = 2""(D2)"[(IEEE 802.11N)]

All PDUs are analyzed assuming the specified STBC field content.

"Meas only if STBC = 1 (Nsts = 2Nss)""(M1)"[(IEEE 802.11ac)]

Only PDUs with the specified STBC field content are analyzed.

"Demod all as STBC = 1 (Nsts = 2Nss)"(D1)"[(IEEE 802.11ac)]

All PPDU are analyzed assuming the specified STBC field content.

Remote command:

[CONFigure:WLAN:STBC:AUTO:TYPE](#) on page 301

### Extension Spatial Streams (sounding)

Defines the PPDU taking part in the analysis according to the Ness field content.

**Note:** The terms in brackets in the following description indicate how the setting is referred to in the "Signal Field" result display ("NESS" column, see ["Signal Field"](#) on page 52).

"Auto, same type as first PPDU"(A1st)" All PPDU using a Ness value identical to the first recognized PPDU are analyzed.

"Auto, individually for each PPDU"(AI)" All PPDU are analyzed.

"Meas only if Ness = <x>"(M ...)" Only PPDU with the specified Ness value are analyzed.

"Demod all as Ness = <x>" All PPDU are analyzed assuming the specified Ness value.

Remote command:

[CONFigure:WLAN:EXTension:AUTO:TYPE](#) on page 300

### Table info overview

Depending on the selected channel bandwidth, MCS index or NSS (STBC), the relevant information from the modulation and coding scheme (MCS) as defined in the WLAN 802.11 standard is displayed here. This information is for reference only, for example so you can determine the required data rate.

### Guard Interval Length

Defines the PPDU taking part in the analysis depending on the guard interval length.

**Note:** The terms in brackets in the following description indicate how the setting is referred to in the "Signal Field" result display ("Format" column, see ["Signal Field"](#) on page 52).

"Auto, same type as first PPDU"(A1st)" All PPDU using the guard interval length identical to the first recognized PPDU are analyzed.

"Auto, individually for each PPDU"(AI)" All PPDU are analyzed.

"Meas only Short"(MS)" Only PPDU with short guard interval length are analyzed.

"Meas only Long"(ML)" Only PPDU with long guard interval length are analyzed.

"Demod all as short"(DS)" All PPDU are demodulated assuming short guard interval length.

"Demod all as long"(DL)"

All PPDU's are demodulated assuming long guard interval length.

Remote command:

CONFigure:WLAN:GTIme:AUTO on page 300

CONFigure:WLAN:GTIme:AUTO:TYPE on page 437

CONFigure:WLAN:GTIme:SElect on page 301

### 5.3.8.7 Demodulation - MIMO (IEEE 802.11ac, ax, n, be)

**Access:** "Overview" > "Demodulation" > "MIMO" tab

**Or:** [MEAS CONFIG] > "Demod." > "MIMO" tab

The MIMO settings define the mapping between streams and antennas.

This tab is **only available for the standard IEEE 802.11ac, ax, n, be (MIMO)**.

Tx	STS.1	STS.2	STS.3	STS.4	Time shift (ns)
1	1.00	1.00	1.00	1.00	0
	0.00	0.00	0.00	0.00	
2	-1.00	1.00	-1.00	1.00	0
	0.00	0.00	0.00	0.00	
3	-1.00	-1.00	1.00	1.00	0
	0.00	0.00	0.00	0.00	
4	1.00	-1.00	-1.00	1.00	0
	0.00	0.00	0.00	0.00	

Spatial Mapping Mode..... 182

Power Normalise..... 183

User Defined Spatial Mapping..... 183

#### Spatial Mapping Mode

Defines the mapping between streams and antennas.

For details see [Chapter 4.3.2, "Spatial mapping"](#), on page 80.

"Direct" The mapping between streams and antennas is the identity matrix. See also section "20.3.11.10.1 Spatial Mapping" of the IEEE 802.11n WLAN standard.

"Spatial Expansion:" For this mode all streams contribute to all antennas. See also section "20.3.11.10.1 Spatial Mapping" of the IEEE 802.11n WLAN standard.

"User defined" The mapping between streams and antennas is defined by the [User Defined Spatial Mapping](#) table.

Remote command:

CONFigure:WLAN:SMApping:MODE on page 323

**Power Normalise**

Specifies whether an amplification of the signal power due to the spatial mapping is performed according to the matrix entries.

- "On"                      Spatial mapping matrix is scaled by a constant factor to obtain a passive spatial mapping matrix which does not increase the total transmitted power.
- "Off"                      Normalization step is omitted

Remote command:

[CONFigure:WLAN:SMAPping:NORMAlise](#) on page 324

**User Defined Spatial Mapping**

Define your own spatial mapping between streams and antennas.

For each antenna (Tx1..4), the complex element of each STS-Stream is defined. The upper value is the real part of the complex element. The lower value is the imaginary part of the complex element.

Additionally, a "Time Shift" can be defined for cyclic delay diversity (CSD).

Remote command:

[CONFigure:WLAN:SMAPping:TX<ch>](#) on page 324

[CONFigure:WLAN:SMAPping:TX<ch>:STReam<ant>](#) on page 324

[CONFigure:WLAN:SMAPping:TX<ch>:TIMeshift](#) on page 325

**5.3.9 Evaluation range**

**Access:** "Overview" > "Evaluation Range"

**Or:** [MEAS CONFIG] > "Evaluation Range"

The evaluation range defines which objects the result displays are based on. The available settings depend on the selected standard.

- [Evaluation range settings for IEEE 802.11a, ac, ax, g \(OFDM\), j, n, p, be](#)..... 183
- [Evaluation range settings for IEEE 802.11b, g \(DSSS\)](#)..... 186

**5.3.9.1 Evaluation range settings for IEEE 802.11a, ac, ax, g (OFDM), j, n, p, be**

**Access:** "Overview" > "Evaluation Range"

**Or:** [MEAS CONFIG] > "Evaluation Range"

The following settings are available to configure the evaluation range for standards IEEE 802.11a, ac, ax, g (OFDM), j, n, p, be.

Figure 5-10: Evaluation range settings for IEEE 802.11a, ac, ax, g (OFDM), j, n, p, be standards

Analyze this PPDU / PPDU to Analyze.....	184
Stop RUN on Limit Check Fail.....	185
PPDU Statistic Count / No of PPDU's to Analyze.....	185
Source of Payload Length.....	185
Equal PPDU Length.....	185
(Min./Max.) No. of Data Symbols.....	186
Analysis Interval Offset/Analysis Interval Length.....	186

#### Analyze this PPDU / PPDU to Analyze

If enabled, the WLAN I/Q results are based on one individual PPDU only, namely the defined "PPDU to Analyze". The result displays are updated to show the results for the new evaluation range. The selected PPDU is marked by a blue bar in PPDU-based results (see [Chapter 3.1.2, "Evaluation methods for WLAN IQ measurements"](#), on page 27).

**Note:** "AM/AM", "AM/EVM" and "AM/PM" results are not updated when single PPDU analysis is selected.

In MSRA mode, single PPDU analysis is not available.



Remote command:

[SENSE:] BURSt:SElect:STATe on page 328

[SENSE:] BURSt:SElect on page 327

### Stop RUN on Limit Check Fail

If enabled, the measurement is stopped if the limit check fails at any time during the measurement. This is particularly useful if statistical evaluation is performed. If a value exceeds the limit, the R&S FSW WLAN application stops acquiring data, thus allowing you to determine the cause of the limit violation.

If the limit check fails, an error message in the status bar and a status bit in the SYNC register (bit 3) indicate the failure.

Remote command:

[SENSe:] SWEEp:LIMit:ABORt:STATe on page 333

### PPDU Statistic Count / No of PPDUs to Analyze

If the statistic count is enabled, the specified number of PPDUs is taken into consideration for the statistical evaluation. Sweeps are performed continuously until the required number of PPDUs are available. The number of captured and required PPDUs, as well as the number of PPDUs detected in the current sweep, are indicated as "Analyzed PPDUs" in the channel bar.

(See "Channel bar information" on page 12).

If disabled, all valid PPDUs in the current capture buffer are considered. Note that in this case, the number of PPDUs contributing to the current results may vary extremely.

If I/Q noise cancellation is enabled, the entire noise cancellation process is counted as one measurement for statistical evaluation.

Remote command:

[SENSE:] BURSt:COUNT:STATe on page 327

[SENSE:] BURSt:COUNT on page 327

### Source of Payload Length

Defines which signal source is used to determine the payload length of a PPDU.

"Take from Signal Field" [(IEEE 802.11a, j, p)]

Uses the length defined by the signal field

"L-Signal" [(IEEE 802.11ac, ax)]

Determines the length of the L signal

"HT-Signal" [(IEEE 802.11 n)]

Determines the length of the HT signal

"Estimate from signal"

Uses an estimated length

Remote command:

CONFigure:WLAN:PAYLoad:LENGth:SRC on page 326

### Equal PPDU Length

If enabled, only PPDUs with the specified (Min./Max.) Payload Length are considered for measurement analysis.

If disabled, a maximum and minimum (**Min./Max.**) **Payload Length** can be defined and all PPDU's whose length is within this range are considered.

Remote command:

**IEEE 802.11a, ac, ax, g (OFDM), j, n, p, be**

[SENSe:]DEMod:FORMat:BANalyze:SYMBOLs:EQUal on page 330

**IEEE 802.11 b, g (DSSS):**

[SENSe:]DEMod:FORMat:BANalyze:DURation:EQUal on page 329

[SENSe:]DEMod:FORMat:BANalyze:DBYTes:EQUal on page 328

#### **(Min./Max.) No. of Data Symbols**

If the **Equal PPDU Length** setting is enabled, the number of data symbols defines the exact length a PPDU must have to be considered for analysis.

If the **Equal PPDU Length** setting is disabled, you can define the minimum and maximum number of data symbols a PPDU must contain to be considered in measurement analysis.

Remote command:

[SENSe:]DEMod:FORMat:BANalyze:SYMBOLs:MIN on page 332

[SENSe:]DEMod:FORMat:BANalyze:SYMBOLs:MAX on page 332

#### **Analysis Interval Offset/Analysis Interval Length**

The analysis interval defines the symbol range that is actually evaluated by the individual result display. By default it is defined as the length of the detected PPDU, possibly restricted by the minimum or maximum number of data symbols. However, it can be restricted further.

The "Analysis Interval Offset" specifies the number of data symbols from the start of each PPDU that are to be skipped before symbols take part in analysis.

If "Analysis Interval Length" is enabled, then the number of PPDU data symbols after the "Analysis Interval Offset" which are to be analyzed can be specified.

If "Analysis Interval Length" is disabled, then all PPDU data symbols after the "Analysis Interval Offset" are evaluated.

Remote command:

[SENSe:]DEMod:FORMat:BANalyze:SYMBOLs:OFFSet on page 333

[SENSe:]DEMod:FORMat:BANalyze:SYMBOLs:LENGth:STATe on page 331

[SENSe:]DEMod:FORMat:BANalyze:SYMBOLs:LENGth on page 331

### **5.3.9.2 Evaluation range settings for IEEE 802.11b, g (DSSS)**

**Access:** "Overview" > "Evaluation Range"

**Or:** [MEAS CONFIG] > "Evaluation Range"

The following settings are available to configure the evaluation range for standards IEEE 802.11b, g (DSSS).

Figure 5-11: Evaluation range settings for IEEE 802.11b and g (DSSS) standards

PPDU Statistic Count / No of PPDU's to Analyze.....	187
Equal PPDU Length.....	188
(Min./Max.) Payload Length.....	188
PVT [:] Average Length.....	188
PVT : Reference Power.....	188
Peak Vector Error : Meas Range.....	189

#### PPDU Statistic Count / No of PPDU's to Analyze

If the statistic count is enabled, the specified number of PPDU's is taken into consideration for the statistical evaluation. Sweeps are performed continuously until the required number of PPDU's are available. The number of captured and required PPDU's, as well as the number of PPDU's detected in the current sweep, are indicated as "Analyzed PPDU's" in the channel bar.

(See "[Channel bar information](#)" on page 12).

If disabled, all valid PPDU's in the current capture buffer are considered. Note that in this case, the number of PPDU's contributing to the current results may vary extremely.

If I/Q noise cancellation is enabled, the entire noise cancellation process is counted as one measurement for statistical evaluation.

Remote command:

[SENSE:] BURSt: COUNT: STATE on page 327

[SENSE:] BURSt: COUNT on page 327

### Equal PDU Length

If enabled, only PDUs with the specified (Min./Max.) Payload Length are considered for measurement analysis.

If disabled, a maximum and minimum (Min./Max.) Payload Length can be defined and all PDUs whose length is within this range are considered.

Remote command:

**IEEE 802.11a, ac, ax, g (OFDM), j, n, p, be**

[SENSE:] DEMod: FORMat: BANalyze: SYMBols: EQUal on page 330

**IEEE 802.11 b, g (DSSS):**

[SENSE:] DEMod: FORMat: BANalyze: DURation: EQUal on page 329

[SENSE:] DEMod: FORMat: BANalyze: DBYTes: EQUal on page 328

### (Min./Max.) Payload Length

If the Equal PDU Length setting is enabled, the payload length defines the exact length a PDU must have to be considered for analysis.

If the Equal PDU Length setting is disabled, you can define the minimum and maximum payload length a PDU must contain to be considered in measurement analysis.

The payload length can be defined as a duration in  $\mu$ s or a number of bytes (only if specific PDU modulation and format are defined for analysis, see "PDU Format to measure" on page 152).

Remote command:

[SENSE:] DEMod: FORMat: BANalyze: DBYTes: MIN on page 329

[SENSE:] DEMod: FORMat: BANalyze: DURation: MIN on page 330

[SENSE:] DEMod: FORMat: BANalyze: DBYTes: MAX on page 329

[SENSE:] DEMod: FORMat: BANalyze: DURation: MAX on page 330

### PVT [:] Average Length

Defines the number of samples used to adjust the length of the smoothing filter for PVT measurement.

For details see "PvT Full PDU" on page 44.

Remote command:

CONFigure: BURSt: PVT: AVERage on page 326

### PVT : Reference Power

Sets the reference for the rise and fall time in PVT calculation to the maximum or mean PDU power.

For details see "PvT Full PDU" on page 44.

Remote command:

CONFigure: BURSt: PVT: RPOWer on page 326

**Peak Vector Error : Meas Range**

Displays the used measurement range for peak vector error measurement (for reference only).

"All Symbols" Peak Vector Error results are calculated over the complete PPDU

"PSDU only" Peak Vector Error results are calculated over the PSDU only

Remote command:

[CONFigure:WLAN:PVError:MRANge](#) on page 326

**5.3.10 Result configuration**

**Access:** [MEAS CONFIG] > "Result Config"

(The softkey is only available if a window with additional settings is currently selected.)

Depending on the selected result display, different settings are available.

- [Result summary configuration](#).....189
- [Spectrum flatness and group delay configuration](#).....190
- [AM/AM configuration](#).....191

**5.3.10.1 Result summary configuration**

**Access:** [MEAS CONFIG] > "Result Config"

You can configure which results are displayed in "Result Summary" displays (see ["Result Summary Global"](#) on page 49 and ["Result Summary Detailed"](#) on page 47). However, the results are always *calculated*, regardless of their visibility on the screen.

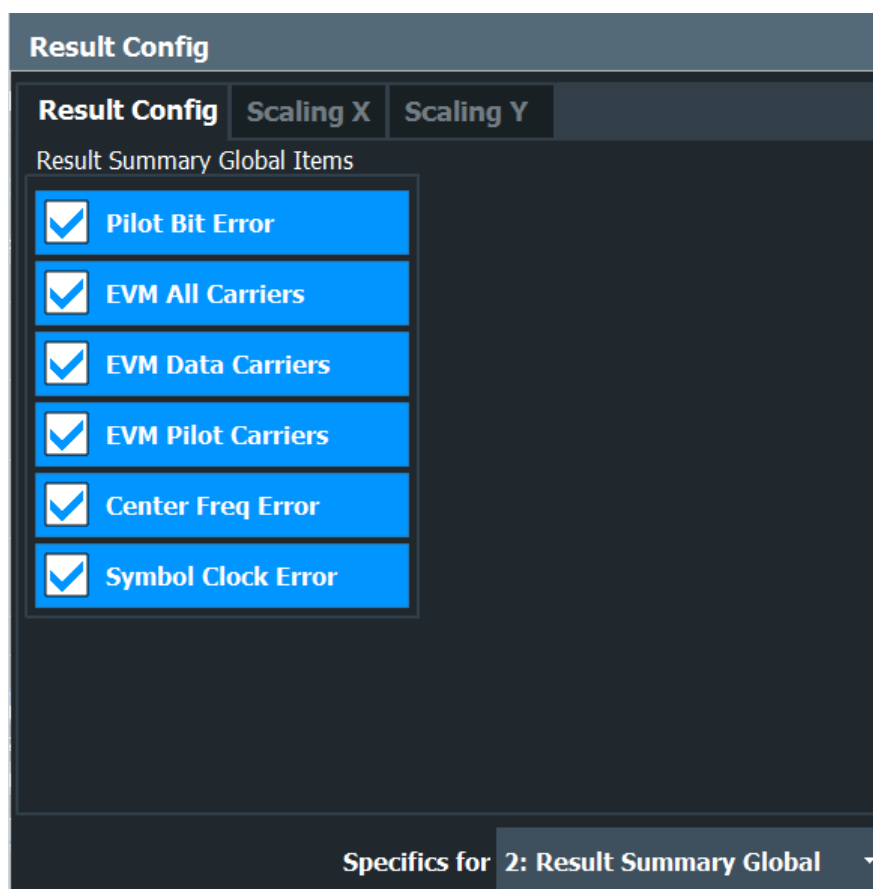

Figure 5-12: Result Summary Global configuration for IEEE 802.11a, ac, ax, g (OFDM), j, n, p, be standards

**Remote command:**

DISPlay[:WINDow<n>]:TABLE:ITEM on page 358

### 5.3.10.2 Spectrum flatness and group delay configuration

**Access:** [MEAS CONFIG] > "Result Config"

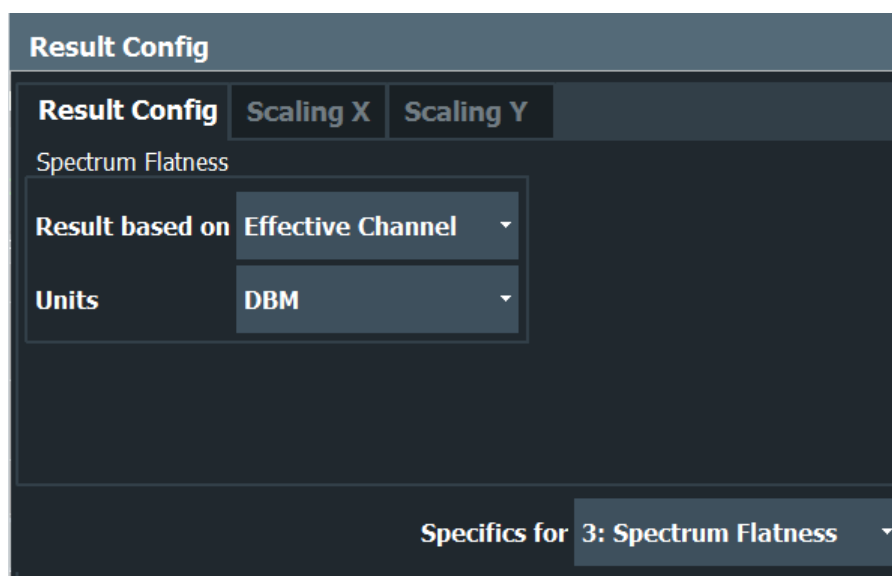

<a href="#">Result based on</a> .....	191
<a href="#">Units</a> .....	191

#### Result based on

"Spectrum Flatness" and "Group Delay" results can be based on either the effective channels or the physical channels.

This setting is **not** available for single-carrier measurements (IEEE 802.11b, g (DSSS)).

While the physical channels cannot always be determined, the effective channel can always be estimated from the known training fields. Thus, for some PPDUs or measurement scenarios, only the results based on the mapping of the space-time stream to the Rx antenna (effective channel) are available, as the mapping of the Rx antennas to the Tx antennas (physical channel) could not be determined.

For more information see [Chapter 4.3.3, "Physical vs effective channels"](#), on page 80.

Remote command:

[CONFigure:BURSt:SPECTrum:FLATness:CSElect](#) on page 360

#### Units

Switches between relative (dB) and absolute (dBm) results.

Remote command:

[UNIT:SFLatness](#) on page 360

### 5.3.10.3 AM/AM configuration

**Access:** [MEAS CONFIG] > "Result Config"

For AM result displays some additional configuration settings are available.

- [General AM/AM settings](#)..... 192
- [Scaling AM result displays](#)..... 192

### General AM/AM settings

**Access:** [MEAS CONFIG] > "Result Config" > "Result Config" tab

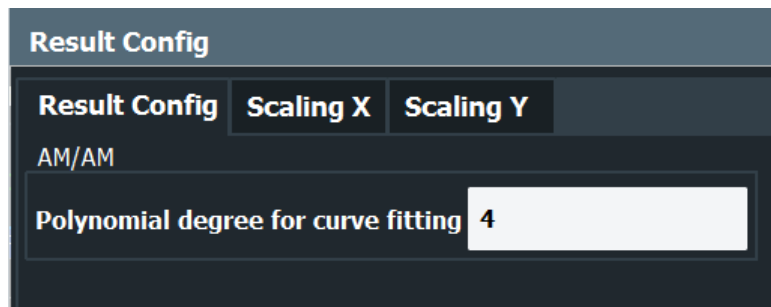

### Polynomial degree for curve fitting

For "AM/AM" result displays, the trace is determined by calculating a polynomial regression model for the scattered measurement vs. reference signal data (see "AM/AM" on page 28). The degree of this model can be specified in the "Result Config" dialog box for this result display.

The resulting regression polynomial is indicated in the window title of the result display.

Remote command:

[CONFigure:BURSt:AM:AM:POLYnomial](#) on page 361

Resulting coefficients:

[FETCh:BURSt:AM:AM:COEFicients?](#) on page 379

### Scaling AM result displays

**Access:** [MEAS CONFIG] > "Result Config" > "Scaling X"/"Scaling Y" tab

Scaling settings are available for the x-axis or y-axis of the following result displays:

- [AM/AM](#)
- [AM/PM](#)
- [AM/EVM](#)

The available scaling settings and functions are identical for both axes, but can be configured separately.



**Result Config** [Close]

**Result Config** | **Scaling X** | **Scaling Y**

**Automatic Grid Scaling**

Auto:  On  Off

Auto Mode:  Hysteresis  Memory

Auto Fix Range:  None  Lower  Upper

Min:  Max:

Hysteresis Interval Upper HIU [ -  , +  ]

Hysteresis Interval Lower HIL [ -  , +  ]

Memory Depth:

Number of Divisions:

Per Division are 10<sup>n</sup> multiples of  1.0  2.0  2.5  5.0

Specifics for: 1: AM/AM

Automatic Grid Scaling.....	193
Auto Mode.....	194
Auto Fix Range.....	194
Hysteresis Interval Upper/Lower.....	194
Minimum / Maximum.....	195
Memory Depth.....	195
Number of Divisions.....	196
Scaling per division.....	196

### Automatic Grid Scaling

Activates or deactivates automatic scaling of the x-axis or y-axis for the specified trace display. If enabled, the R&S FSW WLAN application automatically scales the x-axis or y-axis to best fit the measurement results.

If disabled, the x-axis or y-axis is scaled according to the specified [Minimum / Maximum](#) and [Number of Divisions](#).

Remote command:

`DISPlay[:WINDow<n>]:TRACe<t>:Y[:SCALE]:AUTO` on page 361

**Auto Mode**

Determines which algorithm is used to determine whether the x-axis or y-axis requires automatic rescaling.

- |              |  |
|--------------|--|
| "Hysteresis" | If the minimum and/or maximum values of the current measurement exceed a specific value range (hysteresis interval), the axis is rescaled. The hysteresis interval is defined as a percentage of the currently displayed value range on the x-axis or y-axis. An upper hysteresis interval is defined for the maximum value, a lower hysteresis interval is defined for the minimum value.<br>(See <a href="#">Hysteresis Interval Upper/Lower</a> )       |
| "Memory"     | If the minimum or maximum values of the current measurement exceed the minimum or maximum of the <x> previous results, respectively, the axis is rescaled.<br>The minimum and maximum value of each measurement is added to the memory. After <x> measurements, the oldest results in the memory are overwritten by each new measurement.<br>The number <x> of results in the memory to be considered is configurable (see <a href="#">Memory Depth</a> ). |

Remote command:

`DISPlay[:WINDow<n>]:TRACe<t>:Y[:SCALe]:AUTO:MODE` on page 365

**Auto Fix Range**

This command defines the use of fixed value limits.

- |         |   |
|---------|---|
| "None"  | Both the upper and lower limits are determined by automatic scaling of the x-axis or y-axis.  |
| "Lower" | The lower limit is fixed (defined by the <a href="#">Minimum / Maximum</a> settings), while the upper limit is determined by automatic scaling of the x-axis or y-axis. |
| "Upper" | The upper limit is fixed (defined by the <a href="#">Minimum / Maximum</a> settings), while the lower limit is determined by automatic scaling of the x-axis or y-axis. |

Remote command:

`DISPlay[:WINDow<n>]:TRACe<t>:Y[:SCALe]:AUTO:FIXed:RANGe`  
on page 362

**Hysteresis Interval Upper/Lower**

For automatic scaling based on hysteresis, the hysteresis intervals are defined here. Depending on whether either of the limits are fixed or not (see [Auto Fix Range](#)), one or both limits are defined by a hysteresis value range.

The hysteresis range is defined as a percentage of the currently displayed value range on the x-axis or y-axis.

**Example:**

The currently displayed value range on the y-axis is 0 to 100. The upper limit is fixed by a maximum of 100. The lower hysteresis range is defined as -10% to +10%. If the minimum value in the current measurement drops below -10 or exceeds +10, the y-axis will be rescaled automatically, for example to [-10..+100] or [+10..+100], respectively.

"Upper"[(HIU)] If the maximum value in the current measurement exceeds the specified range, the x-axis or y-axis is rescaled automatically.

"Lower"[(HIL)] If the minimum value in the current measurement exceeds the specified range, the x-axis or y-axis is rescaled automatically.

Remote command:

`DISPlay[:WINDow<n>]:TRACe<t>:Y[:SCALe]:AUTO:HYSTeresis:LOWer:UPPer` on page 362

`DISPlay[:WINDow<n>]:TRACe<t>:Y[:SCALe]:AUTO:HYSTeresis:LOWer:LOWer` on page 363

`DISPlay[:WINDow<n>]:TRACe<t>:Y[:SCALe]:AUTO:HYSTeresis:UPPer:LOWer` on page 363

`DISPlay[:WINDow<n>]:TRACe<t>:Y[:SCALe]:AUTO:HYSTeresis:UPPer:UPPer` on page 364

**Minimum / Maximum**

Defines the minimum and maximum value to be displayed on the x-axis or y-axis of the specified evaluation diagram.

For automatic scaling with a fixed range (see [Auto Fix Range](#)), the minimum defines the fixed lower limit, the maximum defines the fixed upper limit.

Remote command:

`DISPlay[:WINDow<n>]:TRACe<t>:Y[:SCALe]:MAXimum` on page 366

`DISPlay[:WINDow<n>]:TRACe<t>:Y[:SCALe]:MINimum` on page 366

**Memory Depth**

For automatic scaling based on memory (see ["Auto Mode"](#) on page 194), this value defines the number <x> of previous results to be considered when determining if rescaling is required.

The minimum and maximum value of each measurement are added to the memory. After <x> measurements, the oldest results in the memory are overwritten by each new measurement.

If the maximum value in the current measurement exceeds the maximum of the <x>previous results, and the upper limit is not fixed, the x-axis or y-axis is rescaled.

If the minimum value in the current measurement drops below the minimum of the <x>previous results, and the lower limit is not fixed, the x-axis or y-axis is rescaled.

Remote command:

`DISPlay[:WINDow<n>]:TRACe<t>:Y[:SCALe]:AUTO:MEMory:DEPTh` on page 364

**Number of Divisions**

Defines the number of divisions to be used for the x-axis or y-axis. By default, the x-axis or y-axis is divided into 10 divisions.

Remote command:

`DISPlay[:WINDow<n>]:TRACe<t>:Y[:SCALe]:DIVisions` on page 365

**Scaling per division**

Determines the values shown for each division on the x-axis or y-axis.

One or more multiples of  $10^n$  can be selected. The R&S FSW WLAN application then selects the optimal scaling from the selected values.

**Example:**

- Multiples of "2.0" and "**2.5**" selected; division range = [-80..-130]; number of divisions: 10;  
Possible scaling (n=1):  
[-80;-85;-90;-95;-100;-105;-110;-115;-130;]
- Multiples of "**2.0**" selected; division range = [-80..-130]; number of divisions: 10;  
Possible scaling (n=1):  
[0;-20;-40;-60;-80;-100;-120;-140;-160;-180;]

"1.0"	Each division on the x-axis or y-axis displays multiples of $1 \cdot 10^n$ : For example for n= -1; division range = [0..1]; number of divisions: 10; [0, 0.1, 0.2, 0.3, 0.4, 0.5, 0.6, 0.7, 0.8, 0.9, 1.0]
"2.0"	Each division on the x-axis or y-axis displays multiples of $2 \cdot 10^n$ : For example for n= -1; division range = [0..1]; number of divisions: 5; [0, 0.2, 0.4, 0.6, 0.8, 1.0]
"2.5"	Each division on the x-axis or y-axis displays multiples of $2.5 \cdot 10^n$ : For example for n= -1; division range = [0..1]; number of divisions: 5; [0, 0.25, 0.5, 0.75, 1.0]
"5.0"	Each division on the x-axis or y-axis displays multiples of $5 \cdot 10^n$ : For example for n= -1; division range = [0..1]; number of divisions: 5, [-0.5, 0, 0.5, 1.0, 1.5]

Remote command:

`DISPlay[:WINDow<n>]:TRACe<t>:Y[:SCALe]:PDIVision` on page 367

**5.3.11 Automatic settings**

**Access:** [AUTO SET] menu

Some settings can be adjusted by the FSW automatically according to the current measurement settings and signal characteristics.



### MSRA operating mode

In MSRA operating mode, the following automatic settings are not available, as they require a new data acquisition. However, the R&S FSW WLAN application cannot perform data acquisition in MSRA operating mode.

Setting the Reference Level Automatically (Auto Level).....	197
Resetting the Automatic Measurement Time (Meas Time Auto).....	197
Changing the Automatic Measurement Time (Meas Time Manual).....	197

#### Setting the Reference Level Automatically (Auto Level)

Automatically determines the optimal reference level for the current input data. At the same time, the internal attenuators and the preamplifier are adjusted so the signal-to-noise ratio is optimized, while signal compression, clipping and overload conditions are minimized.

In order to do so, a level measurement is performed to determine the optimal reference level.

Note that for sample rates larger than 160 MHz and active B1200 or B2001 bandwidth extension options, auto leveling is not available.

Remote command:

`[SENSe:]ADJust:LEVel` on page 340

#### Resetting the Automatic Measurement Time (Meas Time Auto)

Resets the measurement duration for automatic settings to the default value.

Remote command:

`[SENSe:]ADJust:CONFigure:LEVel:DURation:MODE` on page 340

#### Changing the Automatic Measurement Time (Meas Time Manual)

This function allows you to change the measurement duration for automatic setting adjustments. Enter the value in seconds.

**Note:** For triggered measurements on wide signals ( $\geq 160$  MHz) with small duty cycles (e.g. due to relatively long OFF times), define the measurement time so it includes a full signal period (from PPDU start to PPDU start).

**Note:** The maximum measurement duration depends on the currently selected measurement and the installed (optional) hardware. Thus, the measurement duration actually used to determine the automatic settings can be shorter than the value you define here.

Remote command:

`[SENSe:]ADJust:CONFigure:LEVel:DURation:MODE` on page 340

`[SENSe:]ADJust:CONFigure:LEVel:DURation` on page 339

## 5.3.12 Sweep settings

**Access:** [SWEEP] menu

The sweep settings define how the data is measured.

Continuous Sweep / Run Cont.....	198
Single Sweep / Run Single.....	198
Continue Single Sweep.....	198
Refresh (MSRA only).....	198

### Continuous Sweep / Run Cont

While the measurement is running, "Continuous Sweep" and [RUN CONT] are highlighted. The running measurement can be aborted by selecting the highlighted softkey or key again. The results are not deleted until a new measurement is started.

**Note:** Sequencer. If the Sequencer is active, "Continuous Sweep" only controls the sweep mode for the currently selected channel. However, the sweep mode only takes effect the next time the Sequencer activates that channel, and only for a channel-defined sequence. In this case, a channel in continuous sweep mode is swept repeatedly.

Furthermore, [RUN CONT] controls the Sequencer, not individual sweeps. [RUN CONT] starts the Sequencer in continuous mode.

For details on the Sequencer, see the FSW base unit user manual.

Remote command:

`INITiate<n>:CONTInuous` on page 369

### Single Sweep / Run Single

While the measurement is running, "Single Sweep" and [RUN SINGLE] are highlighted. The running measurement can be aborted by selecting the highlighted softkey or key again.

**Note:** Sequencer. If the Sequencer is active, "Single Sweep" only controls the sweep mode for the currently selected channel. However, the sweep mode only takes effect the next time the Sequencer activates that channel, and only for a channel-defined sequence. In this case, the Sequencer sweeps a channel in single sweep mode only once.

Furthermore, [RUN SINGLE] controls the Sequencer, not individual sweeps. [RUN SINGLE] starts the Sequencer in single mode.

If the Sequencer is off, only the evaluation for the currently displayed channel is updated.

For details on the Sequencer, see the FSW base unit user manual.

Remote command:

`INITiate<n>[:IMMEDIATE]` on page 369

### Continue Single Sweep

After triggering, repeats the number of sweeps set in "Sweep Count", without deleting the trace of the last measurement.

While the measurement is running, "Continue Single Sweep" and [RUN SINGLE] are highlighted. The running measurement can be aborted by selecting the highlighted softkey or key again.

### Refresh (MSRA only)

This function is only available if the Sequencer is deactivated and only for **MSRA secondary applications**.

The data in the capture buffer is re-evaluated by the currently active secondary application only. The results for any other secondary applications remain unchanged.

This is useful, for example, after evaluation changes have been made or if a new sweep was performed from another secondary application. In this case, only that secondary application is updated automatically after data acquisition.

**Note:** To update all active secondary applications at once, use the "Refresh All" function in the "Sequencer" menu.

Remote command:

`INITiate<n>:REFresh` on page 342

## 5.4 Frequency sweep measurements

When you activate a measurement channel in WLAN mode, an IQ measurement of the input signal is started automatically (see [Chapter 3.1, "WLAN I/Q measurement \(modulation accuracy, flatness and tolerance\)"](#), on page 15). However, some parameters specified in the WLAN 802.11 standard require a better signal-to-noise level or a smaller bandwidth filter than the default measurement on I/Q data provides and must be determined in separate measurements based on RF data (see [Chapter 3.2, "Frequency sweep measurements"](#), on page 58). In these measurements, demodulation is not performed.

### Selecting the measurement type

WLAN measurements require a special operating mode on the FSW, which you activate using [MODE].

- ▶ To select a frequency sweep measurement type, do one of the following:
  - Select "Overview". In the "Overview", select "Select Measurement". Select the required measurement.
  - Press [MEAS]. In "Select Measurement" dialog box, select the required measurement.

The FSW WLAN application uses the functionality of the FSW base system (Spectrum application) to perform the WLAN frequency sweep measurements. Some parameters are set automatically according to the WLAN 802.11 standard the first time a measurement is selected (since the last [PRESET] operation). These parameters can be changed, but are not reset automatically the next time you re-enter the measurement. Refer to the description of each measurement type for details.

The main measurement configuration menus for the WLAN frequency sweep measurements are identical to the Spectrum application.

For details refer to "Measurements" in the FSW User Manual.

The measurement-specific settings for the following measurements are available via the "Overview".

- [Channel power \(ACLR\) measurements](#)..... 200
- [Spectrum emission mask](#)..... 200
- [Occupied bandwidth](#)..... 201
- [CCDF](#)..... 202

### 5.4.1 Channel power (ACLR) measurements

The Adjacent Channel Power measurement analyzes the power of the TX channel and the power of adjacent and alternate channels on the left and right side of the TX channel. The number of TX channels and adjacent channels can be modified as well as the band class. The bandwidth and power of the TX channel and the bandwidth, spacing and power of the adjacent and alternate channels are displayed in the "Result Summary".

"Channel Power ACLR" measurements are performed as in the Spectrum application with the following predefined settings according to WLAN specifications (adjacent channel leakage ratio).

**Table 5-4: Predefined settings for WLAN ACLR Channel Power measurements**

Setting	Default value
ACLR Standard	same as defined in WLAN signal description (see " <a href="#">Standard</a> " on page 110)
Number of adjacent channels	3
Reference channel	Max power Tx channel
Channel bandwidth	20 MHz

For further details about the ACLR measurements refer to "Measuring Channel Power and Adjacent-Channel Power" in the FSW User Manual.

To restore adapted measurement parameters, the following parameters are saved on exiting and are restored on re-entering this measurement:

- Reference level and reference level offset
- RBW, VBW
- Sweep time
- Span
- Number of adjacent channels
- Fast ACLR mode

The main measurement menus for the frequency sweep measurements are identical to the Spectrum application.

### 5.4.2 Spectrum emission mask

The "Spectrum Emission Mask" measurement shows the quality of the measured signal by comparing the power values in the frequency range near the carrier against a spectral mask that is defined by the WLAN 802.11 specifications. The limits depend on



the selected power class. Thus, the performance of the DUT can be tested and the emissions and their distance to the limit are identified.



Note that the WLAN standard does not distinguish between spurious and spectral emissions.

The "Result Summary" contains a peak list with the values for the largest spectral emissions including their frequency and power.

The WLAN application performs the SEM measurement as in the Spectrum application with the following settings:

**Table 5-5: Predefined settings for WLAN SEM measurements**

Setting	Default value
Number of ranges	3
Frequency Span	+/- 12.75 MHz
Fast SEM	OFF
Sweep time	140 µs
RBW	30 kHz
Power reference type	Channel Power
Tx Bandwidth	3.84 MHz
Number of power classes	1



You must select the SEM file with the pre-defined settings required by the standard manually (using "Standard Files" in the main "SEMask" menu). The subdirectory displayed in the SEM standard file selection dialog box depends on the standard you selected previously for the WLAN Modulation Accuracy, Flatness,... measurement (see "Standard" on page 110).

For further details about the "Spectrum Emission Mask" measurements refer to "Spectrum Emission Mask Measurement" in the FSW User Manual.

To restore adapted measurement parameters, the following parameters are saved on exiting and are restored on re-entering this measurement:

- Reference level and reference level offset
- Sweep time
- Span

The main measurement menus for the frequency sweep measurements are identical to the Spectrum application.

### 5.4.3 Occupied bandwidth

**Access:** "Overview" > "Select Measurement" > "OBW"

or: [MEAS] > "Select Measurement" > "OBW"

The "Occupied Bandwidth" measurement is performed as in the Spectrum application with default settings.

**Table 5-6: Predefined settings for WLAN 802.11 OBW measurements**

Setting	Default value
% Power Bandwidth	99 %
Channel bandwidth	3.84 MHz

The "Occupied Bandwidth" measurement determines the bandwidth that the signal occupies. The occupied bandwidth is defined as the bandwidth in which – in default settings - 99 % of the total signal power is to be found. The percentage of the signal power to be included in the bandwidth measurement can be changed.

For further details about the "Occupied Bandwidth" measurements refer to "Measuring the Occupied Bandwidth" in the FSW User Manual.

To restore adapted measurement parameters, the following parameters are saved on exiting and are restored on re-entering this measurement:

- Reference level and reference level offset
- RBW, VBW
- Sweep time
- Span

#### 5.4.4 CCDF

**Access:** "Overview" > "Select Measurement" > "CCDF"

or: [MEAS] > "Select Measurement" > "CCDF"

The "CCDF" measurement determines the distribution of the signal amplitudes (complementary cumulative distribution function). The "CCDF" and the Crest factor are displayed. For the purposes of this measurement, a signal section of user-definable length is recorded continuously in zero span, and the distribution of the signal amplitudes is evaluated.

The measurement is useful to determine errors of linear amplifiers. The crest factor is defined as the ratio of the peak power and the mean power. The "Result Summary" displays the number of included samples, the mean and peak power and the crest factor.

The "CCDF" measurement is performed as in the Spectrum application with the following settings:

**Table 5-7: Predefined settings for WLAN 802.11 CCDF measurements**

Setting	Default value
"CCDF"	Active on trace 1
Analysis bandwidth	10 MHz

Setting	Default value
Number of samples	62500
Detector	Sample

For further details about the "CCDF" measurements refer to "Statistical Measurements" in the FSW User Manual.

To restore adapted measurement parameters, the following parameters are saved on exiting and are restored on re-entering this measurement:

- Reference level and reference level offset
- Analysis bandwidth
- Number of samples

## 6 Analysis

General result analysis settings concerning the trace and markers etc. are currently not available for the standard WLAN measurements. Only one (Clear/Write) trace and one marker are available for these measurements.



### **Analysis of frequency sweep measurements**

General result analysis settings concerning the trace, markers, lines etc. for RF measurements are identical to the analysis functions in the Spectrum application except for some special marker functions and spectrograms, which are not available in the R&S FSW WLAN application.

For details see the "Common Analysis and Display Functions" chapter in the FSW User Manual.

The remote commands required to perform these tasks are described in [Chapter 10.10, "Analysis"](#), on page 427.

## 7 I/Q data import and export

Baseband signals mostly occur as so-called complex baseband signals, i.e. a signal representation that consists of two channels; the inphase (I) and the quadrature (Q) channel. Such signals are referred to as I/Q signals. The complete modulation information and even distortion that originates from the RF, IF or baseband domains can be analyzed in the I/Q baseband.

Importing and exporting I/Q signals is useful for various applications:

- Generating and saving I/Q signals in an RF or baseband signal generator or in external software tools to analyze them with the FSW later.
- Capturing and saving I/Q signals with the FSW to analyze them with the FSW or an external software tool later

As opposed to storing trace data, which can be averaged or restricted to peak values, I/Q data is stored as it was captured, without further processing. Multi-channel data is not supported.

The data is stored as complex values in 32-bit floating-point format. The I/Q data is stored in a format with the file extension `.iq.tar`.



For a detailed description, see the FSW I/Q Analyzer and I/Q Input User Manual.

For example, you can capture I/Q data using the I/Q Analyzer application, if available, and then analyze that data later using the R&S FSW WLAN application.



An application note on converting Rohde & Schwarz I/Q data files is available from the Rohde & Schwarz website:

[1EF85: Converting R&S I/Q data files](#)

The import and export functions are available in the "Save/Recall" menu which is displayed when you select the  "Save" or  "Open" icon in the toolbar.

See the FSW I/Q Analyzer and I/Q Input User Manual.



### Export only in MSRA mode

In MSRA mode, I/Q data can only be exported to other applications; I/Q data cannot be imported to the MSRA primary or any MSRA secondary applications.

### IQNC I/Q Export

**Access** : "Save" > "Export" > "I/Q Export"

Saves the I/Q data with the analyzer noise removed to a file. This function is only available in single sweep mode and if the optional I/Q noise cancellation function is enabled.

To export the raw I/Q data to a file, use `MMEMory:STORe<n>:IQ:STATe` on page 425.

Remote command:

`MMEMory:STORe<n>:IQNC:STATe` on page 425

## 8 How to perform measurements in the WLAN application

The following step-by-step instructions demonstrate how to perform measurements in the FSW WLAN application. The following tasks are described:

- [How to determine modulation accuracy, flatness and tolerance parameters for WLAN signals.....](#)206
- [How to analyze WLAN signals in a MIMO measurement setup.....](#)208
- [How to determine the OBW, SEM, ACLR or CCDF for WLAN signals.....](#)213

### 8.1 How to determine modulation accuracy, flatness and tolerance parameters for WLAN signals

1. Press [MODE].

A dialog box opens that contains all operating modes and applications currently available on your FSW.

2. Select the "WLAN" item.



The FSW opens a new measurement channel for the WLAN application.

3. Select "Overview" to display the "Overview" for a WLAN measurement.
4. Select "Signal Description" to define the digital standard to be used.
5. Select "Input/Frontend" and then the "Frequency" tab to define the input signal's center frequency.
6. Select "Signal Capture" to define how much and which data to capture from the input signal.
7. To define a particular starting point for the FFT or to improve the measurement speed for signals with a low duty cycle, select "Synchronization/OFDM-Demod." and set the required parameters.
8. Select "Tracking/Channel Estimation" to define how the data channels are to be estimated and which distortions will be compensated for.
9. Select "Demod" to provide information on the modulated signal and how the PPDU's detected in the capture buffer are to be demodulated.
10. Select "Evaluation Range" to define which data in the capture buffer you want to analyze.

How to determine modulation accuracy, flatness and tolerance parameters for WLAN signals

11. Select "Display Config" and select the displays that are of interest to you (up to 16). Arrange them on the display to suit your preferences.
12. Exit the SmartGrid mode.
13. Start a new sweep with the defined settings.
  - To perform a single sweep measurement, press RUN SINGLE.
  - To perform a continuous sweep measurement, press RUN CONT.

In MSRA mode you may want to stop the continuous measurement mode by the Sequencer and perform a single data acquisition:

- a) Select the Sequencer icon (  ) from the toolbar.
- b) Set the Sequencer state to "OFF".
- c) Press [RUN SINGLE].

Measurement results are updated once the measurement has completed.

### To select the application data for MSRA measurements

In multi-standard radio analysis you can analyze the data captured by the MSRA primary in the R&S FSW WLAN application. Assuming you have detected a suspect area of the captured data in another application, you would now like to analyze the same data in the R&S FSW WLAN application.

1. Select "Overview" to display the "Overview" for WLAN I/Q measurements.
2. Select "Signal Capture".
3. Define the application data range as the "Capture Time".
4. Define the starting point of the application data as the "Capture offset". The offset is calculated according to the following formula:  

$$\text{capture offset} = \text{starting point for application} - \text{starting point in capture buffer}$$
5. The analysis interval is automatically determined according to the selected channel, carrier or PPDU to analyze (defined for the evaluation range), depending on the result display. Note that the channel/carrier/PPDU is analyzed *within the application data*. If the analysis interval does not yet show the required area of the capture buffer, move through the channels/carriers/PPDUs in the evaluation range or correct the application data range.
6. If the Sequencer is off, select "Refresh" in the "Sweep" menu to update the result displays for the changed application data.

## 8.2 How to analyze WLAN signals in a MIMO measurement setup

MIMO measurements are only available for IEEE IEEE 802.11ac, ax, n, be standards. They can be performed automatically or manually (see [Chapter 4.3.4, "Capturing data from MIMO antennas"](#), on page 82).

### To perform a manual sequential measurement

1. Press [MODE].
2. Select "WLAN".



The FSW opens a new measurement channel for the WLAN application.

3. Select "Overview" to display the "Overview" for a WLAN measurement.
4. Select "Signal Description" to select one of the following digital standards:
  - IEEE 802.11ac
  - IEEE 802.11ax
  - IEEE 802.11be
  - IEEE 802.11n
5. Select "Input/Frontend" and then the "Frequency" tab to define the input signal's center frequency.
6. Select "Signal Capture" to define how much and which data to capture from the input signal.
7. Select the "MIMO Capture" tab to define how the data from the MIMO antennas is to be captured.
  - a) For the "DUT MIMO Config." select the number of TX antennas data will be transmitted from.
  - b) Under "MIMO antenna Signal Capture Setup" select "Sequential Manual".
8. To define a particular starting point for the FFT or to improve the measurement speed for signals with a low duty cycle, select "Synchronization/OFDM-Demod." and set the required parameters.
9. Select "Tracking/Channel Estimation" to define how the data channels are to be estimated and which distortions will be compensated for, e.g. crosstalk between the MIMO antennas at the DUT.
10. Select "Demod" and then the "Demod" tab to provide information on the modulated signal and how the PPDU's detected in the capture buffer are to be demodulated.



11. In the "Demodulation" dialog box, select the "MIMO" tab to define which spatial mapping mode is used, that is, how the space-time streams are mapped to the antennas.
  - a) If necessary, include a time shift for the individual antennas.
  - b) If the signal power is amplified according to the maxtrix entries so that the total transmitted power is not increased, the measured powers can be normalised to consider this effect in demodulation.
12. Select "Evaluation Range" to define which data in the capture buffer you want to analyze.
13. Select "Display Config" and select the displays that are of interest to you (up to 16). Arrange them on the display to suit your preferences.
14. Exit the SmartGrid mode.
15. Return to the "Signal Capture" > "MIMO Capture" dialog box tab to perform the measurement.
  - a) Connect the input for the first Tx antenna to the RF input of the FSW.
  - b) Select "Single" or "Cont." for the RX 1 capture buffer to perform a single or continuous measurement for that antenna. For a continuous measurement, select "Cont." again to stop the measurement.
  - c) Connect the input for the second Tx antenna to the RF input of the FSW.
  - d) Select "Single" / "Cont." for the RX 2 capture buffer.
  - e) If necessary, repeat these steps for the third and fourth antennas.
  - f) Select "Calc Results" to determine the results for each individual data stream in the selected result displays.

**Note:** Instead of selecting "Single" / "Cont." in the "Signal Capture" dialog box for each individual antenna capture, which requires keeping the dialog box open, you can press [RUN SINGLE] or [RUN CONT] to perform the measurements. The data is evaluated and the result displays are updated when the measurement is stopped.

However, in this case the data is written to the same capture buffer for all antennas (namely the one selected for "<RUNS SINGLE> or <RUN CONT> updates" in the "MIMO Capture" tab). Thus, the assignment of the individual data streams to antennas is no longer visible in the result displays.

#### To perform an automated sequential measurement (with an OSP switch box)

This measurement setup requires an additional R&S OSP switch box. For details on setting up and using this instrument, see the corresponding documentation!

1. Press [MODE].
2. Select "WLAN".



The FSW opens a new measurement channel for the WLAN application.

3. Select "Overview" to display the "Overview" for a WLAN measurement.
4. Select "Signal Description" to select one of the following digital standards:
  - *IEEE 802.11ac*
  - *IEEE 802.11ax*
  - *IEEE 802.11be*
  - *IEEE 802.11n*
5. Select "Input/Frontend" and then the "Frequency" tab to define the input signal's center frequency.
6. Select "Signal Capture" to define how much and which data to capture from the input signal.
7. Select the "MIMO Capture" tab to define how the data from the MIMO antennas is to be captured.
  - a) For the "DUT MIMO Config." select the number of TX antennas data will be transmitted from.
  - b) Under "MIMO antenna Signal Capture Setup" select "Sequential using OSP switch box".
  - c) Enter the IP address of the connected OSP switch box.
  - d) For the "OSP Switch Bank Configuration" select the module used to connect the OSP switch box to the FSW.
  - e) Connect the antennas and the FSW to the OSP switch box as indicated in the dialog box.
  - f) Configure the OSP switch box to switch between the antenna input as required.
8. To define a particular starting point for the FFT or to improve the measurement speed for signals with a low duty cycle, select "Synchronization/OFDM-Demod." and set the required parameters.
9. Select "Tracking/Channel Estimation" to define how the data channels are to be estimated and which distortions will be compensated for, e.g. crosstalk between the MIMO antennas at the DUT.
10. Select "Demod" to provide information on the modulated signal and how the PPDU's detected in the capture buffer are to be demodulated.
11. Select the "MIMO" tab in the "Demodulation" dialog box to define which spatial mapping mode is used, that is, how the space-time streams are mapped to the antennas.
  - a) If necessary, include a time shift for the individual antennas.
  - b) If the signal power is amplified according to the maxtrix entries so that the total transmitted power is not increased, the measured powers can be normalised to consider this effect in demodulation.
12. Select "Evaluation Range" to define which data in the capture buffer you want to analyze.
13. Select "Display Config" and select the displays that are of interest to you (up to 16). Arrange them on the display to suit your preferences.

14. Exit the SmartGrid mode.
15. Start the measurement via the OSP switch box. The data is captured from all antennas automatically. The data is evaluated and the result displays are updated for the individual data streams when the measurement is stopped.

#### To perform a simultaneous measurement (with multiple FSWs and an R&S FS-Z11 Trigger Unit)

This measurement setup requires as many FSWs as Tx antennas are used! They must all be connected via LAN. Select one FSW as a primary. It is assumed the R&S FS-Z11 Trigger Unit is set up according to the following illustration:

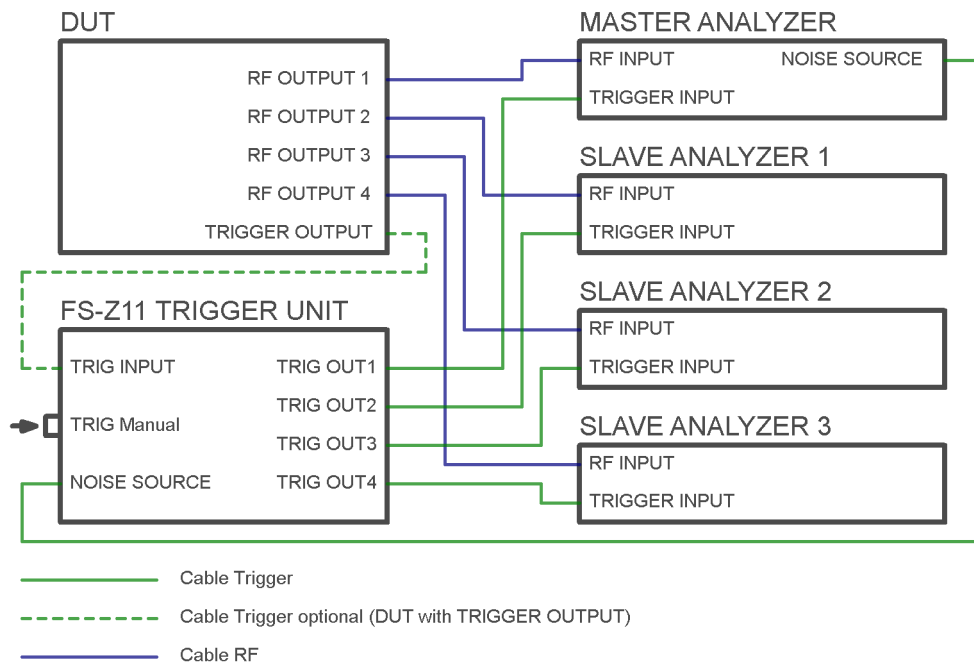

**Figure 8-1: R&S FS-Z11 Trigger Unit connections**

Perform the following configuration **on all FSWs**, except for the MIMO capture settings (step 7). These settings are only required for the primary analyzer.

1. Press [MODE].
2. Select the "WLAN" item.



The FSW opens a new measurement channel for the WLAN application.

3. Select "Overview" to display the "Overview" for a WLAN measurement.
4. Select "Signal Description" to select the digital standard *IEEE 802.11ac* or *IEEE 802.11n*.

5. Select "Input/Frontend" and then the "Frequency" tab to define the input signal's center frequency.
6. Select "Signal Capture" to define how much and which data to capture from the input signal.
7. **For the primary analyzer only:**  
Select the "MIMO Capture" tab to define how the data from the MIMO antennas is to be captured.
  - a) For the "DUT MIMO Config." select the number of TX antennas data will be transmitted from.
  - b) Under "MIMO antenna Signal Capture Setup" select "Simultaneous".
  - c) For each connected FSW, enter the IP address and assign an antenna that this analyzer secondary will capture data from.
  - d) Ensure that the "State" of each analyzer is "On" and the connection is established (the lights should be green in the dialog box).
  - e) Connect the assigned antenna to each FSW.
8. To define a particular starting point for the FFT or to improve the measurement speed for signals with a low duty cycle, select "Synchronization/OFDM-Demod." and set the required parameters.
9. Select "Tracking/Channel Estimation" to define how the data channels are to be estimated and which distortions will be compensated for, e.g. crosstalk between the MIMO antennas at the DUT.
10. Select "Demod" to provide information on the modulated signal and how the PPDU's detected in the capture buffer are to be demodulated.
11. Select the "MIMO" tab in the "Demodulation" dialog box to define which spatial mapping mode is used, that is, how the space-time streams are mapped to the antennas.
  - a) If necessary, include a time shift for the individual antennas.
  - b) If the signal power is amplified according to the maxtrix entries so that the total transmitted power is not increased, the measured powers can be normalised to consider this effect in demodulation.
12. Select "Evaluation Range" to define which data in the capture buffer you want to analyze.
13. Select "Display Config" and select the displays that are of interest to you (up to 16). Arrange them on the display to suit your preferences.
14. Exit the SmartGrid mode.
15. **For the primary analyzer only:**  
Activate the NOISE SOURCE output for the connection to the R&S FS-Z11 Trigger Unit.  
For an FSW as a primary analyzer:
  - a) Press [Input/Output] .
  - b) Select "Output Config".

c) Select "Noise Source": "On".

16. Trigger a new sweep by pressing [TRIG MANUAL] on the Trigger Unit.

The data is captured from all antennas automatically. The data is collected by the primary FSW, which evaluates the entire data and updates the result displays for the individual data streams when the measurement is stopped.

### 8.3 How to determine the OBW, SEM, ACLR or CCDF for WLAN signals

1.



Press [MODE] and select the "WLAN" application.

The FSW opens a new measurement channel for the WLAN application. I/Q data acquisition is performed by default.

2. Select "Signal Description" to define the digital standard to be used.

3. Select the required measurement:

a) Press [MEAS].

b) In the "Select Measurement" dialog box, select the required measurement.

The selected measurement is activated with the default settings for WLAN immediately.

4. For SEM measurements, select the required standard settings file:

a) In the SEMask menu, select "Standard Files".

b) Select the required settings file. The subdirectory displayed in the file selection dialog box depends on the standard you selected in [step 2](#).

5. If necessary, adapt the settings as described for the individual measurements in the FSW User Manual.

6. Select "Display Config" and select the evaluation methods that are of interest to you.

Arrange them on the display to suit your preferences.

7. Exit the SmartGrid mode and select "Overview" to display the "Overview" again.

8. Select "Analysis" in the "Overview" to make use of the advanced analysis functions in the result displays.

- Configure a trace to display the average over a series of sweeps; if necessary, increase the "Sweep Count" in the "Sweep" settings.
- Configure markers and delta markers to determine deviations and offsets within the evaluated signal.

- Use special marker functions to calculate noise or a peak list.
  - Configure a limit check to detect excessive deviations.
9. Optionally, export the trace data of the graphical evaluation results to a file.
    - a) In the "Traces" tab of the "Analysis" dialog box, switch to the "Trace Export" tab.
    - b) Select "Export Trace to ASCII File".
    - c) Define a file name and storage location and select "OK".

## 9 Optimizing and troubleshooting the measurement

- [Optimizing the measurement results](#).....215
- [Error messages and warnings](#)..... 216

### 9.1 Optimizing the measurement results

If the results do not meet your expectations, try the following methods to optimize the measurement.

- [Improving performance](#)..... 215
- [Improving channel estimation and EVM accuracy](#)..... 215

#### 9.1.1 Improving performance

##### Performing a coarse burst search

For signals with **low duty cycle rates**, enable the "Power Interval Search" for synchronization (see "[Power Interval Search](#)" on page 145). In this case, the R&S FSW WLAN application initially performs a coarse burst search on the input signal in which increases in the power vs time trace are detected. Further time-consuming processing is then only performed where bursts are assumed. This improves the measurement speed.

However, for signals in which the PPDU power levels differ significantly, this option should be disabled as otherwise some PPDUs may not be detected.

#### 9.1.2 Improving channel estimation and EVM accuracy

The channels in the WLAN signal are estimated based on the expected input signal description and the information provided by the PPDUs themselves. The more accurate the channel estimation, the more accurate the EVM based on these channels can be calculated.

##### Increasing the basis for channel estimation

The more information that can be used to estimate the channels, the more accurate the results. For measurements that need not be performed strictly according to the WLAN 802.11 standard, set the "Channel Estimation Range" to "Payload" (see "[Channel Estimation Range](#)" on page 147).

The channel estimation is performed in the preamble and the payload. The EVM results can be calculated more accurately.

### Accounting for phase drift in the EVM

According to the WLAN 802.11 standards, the common phase drift must be estimated and compensated from the pilots. Thus, these deviations are not included in the EVM. To include the phase drift, disable "Phase Tracking" (see ["Phase Tracking"](#) on page 149).

### Analyzing time jitter

Normally, a symbol-wise timing jitter is negligible and not required by the IEEE 802.11a measurement standard [6], and thus not considered in channel estimation. However, there may be situations where the timing drift has to be taken into account.

However, to analyze the time jitter per symbol, enable "Timing Tracking" (see ["Timing Error Tracking"](#) on page 149).

### Compensating for non-standard-conform pilot sequences

In case the pilot generation algorithm of the device under test (DUT) has a problem, the non-standard-conform pilot sequence might affect the measurement results, or the R&S FSW WLAN application might not synchronize at all onto the signal generated by the DUT.

In this case, set the "Pilots for Tracking" to "Detected" (see ["Pilots for Tracking"](#) on page 150), so that the pilot sequence detected in the signal is used instead of the sequence defined by the standard.

However, if the pilot sequence generated by the DUT is correct, it is recommended that you use the "According to Standard" setting because it generates more accurate measurement results.

## 9.2 Error messages and warnings

The following messages are displayed in the status bar in case of errors.

### Results contribute to overall results despite inconsistencies:

#### **"Info: Comparison between HT-SIG Payload Length and Estimated Payload Length not performed due to insufficient SNR"**

The R&S FSW WLAN application compares the HT-SIG length against the length estimated from the PPDU power profile. If the two values do not match, the corresponding entry is highlighted orange. If the signal quality is very bad, this comparison is suppressed and the message above is shown.

#### **"Warning: HT-SIG of PPDU was not evaluated"**

Decoding of the HT-SIG was not possible because there was not enough data in the Capture Memory (potential PPDU truncation).

#### **"Warning: Mismatch between HT-SIG and estimated (SNR+Power) PPDU length"**

The HT-SIG length and the length estimated by the R&S FSW WLAN application (from the PPDU power profile) are different.



**"Warning: Physical Channel estimation impossible / Phy Chan results not available Possible reasons: channel matrix not square or singular to working precision"**

The Physical Channel results could not be calculated for one or both of the following reasons:

- The spatial mapping can not be applied due to a rectangular mapping matrix (the number of space time streams is not equal to the number of transmit antennas).
- The spatial mapping matrices are singular to working precision.

**PPDUs are dismissed due to inconsistencies****"Hint: PPDU requires at least one payload symbol"**

Currently at least one payload symbol is required in order to successfully analyze the PPDU. Null data packet (NDP) sounding PPDUs will generate this message.

**"Hint: PPDU dismissed due to a mismatch with the PPDU format to be analyzed"**

The properties causing the mismatches for this PPDU are highlighted.

**"Hint: PPDU dismissed due to truncation"**

The first or the last PPDU was truncated during the signal capture process, for example.

**"Hint: PPDU dismissed due to HT-SIG inconsistencies"**

One or more of the following HT-SIG decoding results are outside of specified range: MCS index, Number of additional STBC streams, Number of space time streams (derived from MCS and STBC), CRC Check failed, Non zero tail bits.

**"Hint: PPDU dismissed because payload channel estimation was not possible"**

The payload based channel estimation was not possible because the channel matrix is singular to working precision.

**"Hint: Channel matrix singular to working precision"**

Channel equalizing (for PPDU Length Detection, fully and user compensated measurement signal) is not possible because the estimated channel matrix is singular to working precision.

## 10 Remote commands for WLAN 802.11 measurements

The following commands are required to perform measurements in the R&S FSW WLAN application in a remote environment.

It is assumed that the FSW has already been set up for remote control in a network as described in the FSW base unit user manual.



Note that basic tasks that are independent of the application are not described here. For a description of such tasks, see the FSW base unit user manual.

In particular, this includes:

- Managing Settings and Results, i.e. storing and loading settings and result data
- Basic instrument configuration, e.g. checking the system configuration, customizing the screen layout, or configuring networks and remote operation
- Using the common status registers



### SCPI Recorder - automating tasks with remote command scripts

The R&S FSW WLAN application also supports the SCPI Recorder functionality.

Using the SCPI Recorder functions, you can create a SCPI script directly on the instrument and then export the script for use on the controller. You can also edit or write a script manually, using a suitable editor on the controller. For manual creation, the instrument supports you by showing the corresponding command syntax for the current setting value.

For details see the "Network and Remote Operation" chapter in the FSW User Manual.

After an introduction to SCPI commands, the following tasks specific to the R&S FSW WLAN application are described here:

- [Common suffixes](#)..... 219
- [Introduction](#)..... 219
- [Activating WLAN 802.11 measurements](#).....224
- [Selecting a measurement](#)..... 228
- [Configuring the WLAN IQ measurement \(modulation accuracy, flatness and tolerance\)](#).....235
- [Configuring frequency sweep measurements on WLAN 802.11 signals](#)..... 342
- [Configuring the result display](#).....347
- [Starting a measurement](#).....367
- [Retrieving results](#)..... 372
- [Analysis](#).....427
- [Status registers](#)..... 429
- [Deprecated commands](#).....436
- [Programming examples \(R&S FSW WLAN application\)](#).....440

## 10.1 Common suffixes

In the R&S FSW WLAN application, the following common suffixes are used in remote commands:

**Table 10-1: Common suffixes used in remote commands in the R&S FSW WLAN application**

Suffix	Value range	Description
<m>	1 to 4 (RF: 1 to 16)	Marker
<n>	1 to 16	Window (in the currently selected channel)
<t>	irrelevant (RF: 1 to 6)	Trace
<li>	1 to 8	Limit line

## 10.2 Introduction

Commands are program messages that a controller (e.g. a PC) sends to the instrument or software. They operate its functions ('setting commands' or 'events') and request information ('query commands'). Some commands can only be used in one way, others work in two ways (setting and query). If not indicated otherwise, the commands can be used for settings and queries.

The syntax of a SCPI command consists of a header and, usually, one or more parameters. To use a command as a query, you have to append a question mark after the last header element, even if the command contains a parameter.

A header contains one or more keywords, separated by a colon. Header and parameters are separated by a "white space" (ASCII code 0 to 9, 11 to 32 decimal, e.g. blank). If there is more than one parameter for a command, they are separated by a comma from one another.

Only the most important characteristics that you need to know when working with SCPI commands are described here. For a more complete description, refer to the user manual of the FSW.



### Remote command examples

Note that some remote command examples mentioned in this general introduction are possibly not supported by this particular application.

### 10.2.1 Conventions used in descriptions

The following conventions are used in the remote command descriptions:

- *Command usage*  
If not specified otherwise, commands can be used both for setting and for querying parameters.  
If a command can be used for setting or querying only, or if it initiates an event, the usage is stated explicitly.

- *Parameter usage*  
If not specified otherwise, a parameter can be used to set a value, and it is the result of a query.  
Parameters required only for setting are indicated as "Setting parameters".  
Parameters required only to refine a query are indicated as "Query parameters".  
Parameters that are only returned as the result of a query are indicated as "Return values".
- *Conformity*  
Commands that are taken from the SCPI standard are indicated as "SCPI confirmed". All commands used by the FSW follow the SCPI syntax rules.
- *Asynchronous commands*  
A command which does not automatically finish executing before the next command starts executing (overlapping command) is indicated as an "Asynchronous command".
- *Reset values (\*RST)*  
Default parameter values that are used directly after resetting the instrument (\*RST command) are indicated as "\*RST" values, if available.
- *Default unit*  
The default unit is used for numeric values if no other unit is provided with the parameter.
- *Manual operation*  
If the result of a remote command can also be achieved in manual operation, a link to the description is inserted.

## 10.2.2 Long and short form

The keywords have a long and a short form. You can use either the long or the short form, but no other abbreviations of the keywords.

The short form is emphasized in uppercase letters. Note however, that this emphasis only serves the purpose to distinguish the short from the long form in the manual. For the instrument, the case does not matter.

### Example:

`SENSe:FREQuency:CENTer` is the same as `SENS:FREQ:CENT`.

## 10.2.3 Numeric suffixes

Some keywords have a numeric suffix if the command can be applied to multiple instances of an object. In that case, the suffix selects a particular instance (e.g. a measurement window).

Numeric suffixes are indicated by angular brackets (<n>) next to the keyword.

If you do not quote a suffix for keywords that support one, a 1 is assumed.

**Example:**

`DISPlay[:WINDow<1...4>]:ZOOM:STATe` enables the zoom in a particular measurement window, selected by the suffix at `WINDow`.

`DISPlay:WINDow4:ZOOM:STATe ON` refers to window 4.

**10.2.4 Optional keywords**

Some keywords are optional and are only part of the syntax because of SCPI compliance. You can include them in the header or not.



If an optional keyword has a numeric suffix and you need to use the suffix, you have to include the optional keyword. Otherwise, the suffix of the missing keyword is assumed to be the value 1.

Optional keywords are emphasized with square brackets.

**Example:**

Without a numeric suffix in the optional keyword:

`[SENSe:]FREQuency:CENTer` is the same as `FREQuency:CENTer`

With a numeric suffix in the optional keyword:

`DISPlay[:WINDow<1...4>]:ZOOM:STATe`

`DISPlay:ZOOM:STATe ON` enables the zoom in window 1 (no suffix).

`DISPlay:WINDow4:ZOOM:STATe ON` enables the zoom in window 4.

**10.2.5 Alternative keywords**

A vertical stroke indicates alternatives for a specific keyword. You can use both keywords to the same effect.

**Example:**

`[SENSe:]BANDwidth|BWIDth[:RESolution]`

In the short form without optional keywords, `BAND 1MHZ` would have the same effect as `BWID 1MHZ`.

**10.2.6 SCPI parameters**

Many commands feature one or more parameters.

If a command supports more than one parameter, they are separated by a comma.

**Example:**

`LAYout:ADD:WINDow Spectrum,LEFT,MTABLE`

Parameters can have different forms of values.

- [Numeric values](#)..... 222
- [Boolean](#)..... 223
- [Character data](#)..... 223
- [Character strings](#)..... 223
- [Block data](#)..... 223

### 10.2.6.1 Numeric values

Numeric values can be entered in any form, i.e. with sign, decimal point or exponent. For physical quantities, you can also add the unit. If the unit is missing, the command uses the basic unit.

#### Example:

With unit: `SENSe:FREQuency:CENTer 1GHZ`

Without unit: `SENSe:FREQuency:CENTer 1E9` would also set a frequency of 1 GHz.

Values exceeding the resolution of the instrument are rounded up or down.

If the number you have entered is not supported (e.g. for discrete steps), the command returns an error.

Instead of a number, you can also set numeric values with a text parameter in special cases.

- `MIN/MAX`  
Defines the minimum or maximum numeric value that is supported.
- `DEF`  
Defines the default value.
- `UP/DOWN`  
Increases or decreases the numeric value by one step. The step size depends on the setting. Sometimes, you can customize the step size with a corresponding command.

#### Querying numeric values

When you query numeric values, the system returns a number. For physical quantities, it applies the basic unit (e.g. Hz for frequencies). The number of digits after the decimal point depends on the type of numeric value.

#### Example:

Setting: `SENSe:FREQuency:CENTer 1GHZ`

Query: `SENSe:FREQuency:CENTer?` would return `1E9`

Sometimes, numeric values are returned as text.

- `INF/NINF`  
Infinity or negative infinity. Represents the numeric values `9.9E37` or `-9.9E37`.
- `NAN`

Not a number. Represents the numeric value 9.91E37. NAN is returned if errors occur.

### 10.2.6.2 Boolean

Boolean parameters represent two states. The "on" state (logically true) is represented by "ON" or the numeric value 1. The "off" state (logically untrue) is represented by "OFF" or the numeric value 0.

#### Querying Boolean parameters

When you query Boolean parameters, the system returns either the value 1 ("ON") or the value 0 ("OFF").

#### Example:

Setting: `DISPlay:WINDow:ZOOM:STATe ON`

Query: `DISPlay:WINDow:ZOOM:STATe?` would return 1

### 10.2.6.3 Character data

Character data follows the syntactic rules of keywords. You can enter text using a short or a long form. For more information, see [Chapter 10.2.2, "Long and short form"](#), on page 220.

#### Querying text parameters

When you query text parameters, the system returns its short form.

#### Example:

Setting: `SENSE:BANDwidth:RESolution:TYPE NORMAL`

Query: `SENSE:BANDwidth:RESolution:TYPE?` would return NORM

### 10.2.6.4 Character strings

Strings are alphanumeric characters. They have to be in straight quotation marks. You can use a single quotation mark ( ' ) or a double quotation mark ( " ).

#### Example:

`INSTRument:DELeTe 'Spectrum'`

### 10.2.6.5 Block data

Block data is a format which is suitable for the transmission of large amounts of data.

The ASCII character # introduces the data block. The next number indicates how many of the following digits describe the length of the data block. The data bytes follow. During the transmission of these data bytes, all end or other control signs are ignored until

all bytes are transmitted. #0 specifies a data block of indefinite length. The use of the indefinite format requires an `NL^END` message to terminate the data block. This format is useful when the length of the transmission is not known or if speed or other considerations prevent segmentation of the data into blocks of definite length.

## 10.3 Activating WLAN 802.11 measurements

WLAN 802.11 measurements require a special application on the FSW (R&S FSW-K91). The measurement is started immediately with the default settings.



These are basic FSW commands, listed here for your convenience.

<a href="#">INSTrument:CREate:DUPLicate</a> .....	224
<a href="#">INSTrument:CREate[:NEW]</a> .....	224
<a href="#">INSTrument:CREate:REPLace</a> .....	225
<a href="#">INSTrument:DELeTe</a> .....	225
<a href="#">INSTrument:LIST?</a> .....	225
<a href="#">INSTrument:REName</a> .....	227
<a href="#">INSTrument[:SELeCt]</a> .....	227
<a href="#">SYSTem:PRESet:CHANnel[:EXEC]</a> .....	228

---

### **INSTrument:CREate:DUPLicate**

Duplicates the currently selected channel, i.e creates a new channel of the same type and with the identical measurement settings. The name of the new channel is the same as the copied channel, extended by a consecutive number (e.g. "IQAnalyzer" -> "IQAnalyzer 2").

The channel to be duplicated must be selected first using the `INST:SEL` command.

Is not available if the MSRA primary channel is selected.

**Example:**

```
INST:SEL 'IQAnalyzer'
```

```
INST:CRE:DUPL
```

Duplicates the channel named 'IQAnalyzer' and creates a new channel named 'IQAnalyzer2'.

**Usage:** Event

---

### **INSTrument:CREate[:NEW] <ChannelType>, <ChannelName>**

Adds a measurement channel. You can configure up to 10 measurement channels at the same time (depending on available memory).

**Parameters:**

<ChannelType> Channel type of the new channel.  
For a list of available channel types, see [INSTrument:LIST?](#) on page 225.



<ChannelName> String containing the name of the channel.  
Note that you cannot assign an existing channel name to a new channel. If you do, an error occurs.

**Example:** `INST:CRE SAN, 'Spectrum 2'`  
Adds a spectrum display named "Spectrum 2".

**INSTrument:CREate:REPLace** <ChannelName1>, <ChannelType>,  
<ChannelName2>

Replaces a channel with another one.

**Setting parameters:**

<ChannelName1> String containing the name of the channel you want to replace.

<ChannelType> Channel type of the new channel.  
For a list of available channel types, see [INSTrument:LIST?](#) on page 225.

<ChannelName2> String containing the name of the new channel.  
**Note:** If the specified name for a new channel already exists, the default name, extended by a sequential number, is used for the new channel (see [INSTrument:LIST?](#) on page 225).  
Channel names can have a maximum of 31 characters, and must be compatible with the Windows conventions for file names. In particular, they must not contain special characters such as ":", "\*", "?".

**Example:** `INST:CRE:REPL 'IQAnalyzer2', IQ, 'IQAnalyzer'`  
Replaces the channel named "IQAnalyzer2" by a new channel of type "IQ Analyzer" named "IQAnalyzer".

**Usage:** Setting only

**INSTrument:DELeTe** <ChannelName>

Deletes a channel.

If you delete the last channel, the default "Spectrum" channel is activated.

**Setting parameters:**

<ChannelName> String containing the name of the channel you want to delete.  
A channel must exist to delete it.

**Example:** `INST:DEL 'IQAnalyzer4'`  
Deletes the channel with the name 'IQAnalyzer4'.

**Usage:** Setting only

**INSTrument:LIST?**

Queries all active channels. The query is useful to obtain the names of the existing channels, which are required to replace or delete the channels.

**Return values:**

<ChannelType>  
<ChannelName>

For each channel, the command returns the channel type and channel name (see tables below).

Tip: to change the channel name, use the `INST:REName` command.

**Example:**

`INST:LIST?`

Result for 3 channels:

```
'ADEM', 'Analog Demod', 'IQ', 'IQ Analyzer', 'IQ', 'IQ Analyzer2'
```

**Usage:**

Query only

**Table 10-2: Available channel types and default channel names in Signal and Spectrum Analyzer mode**

Application	<ChannelType> parameter	Default Channel name*)
Spectrum	SANALYZER	Spectrum
1xEV-DO BTS (R&S FSW-K84)	BDO	1xEV-DO BTS
1xEV-DO MS (R&S FSW-K85)	MDO	1xEV-DO MS
3GPP FDD BTS (R&S FSW-K72)	BWCD	3G FDD BTS
3GPP FDD UE (R&S FSW-K73)	MWCD	3G FDD UE
802.11ad (R&S FSW-K95)	WIGIG	802.11ad
802.11ay (R&S FSW-K97)	EDMG	802.11ay EDMG
Amplifier Measurements (R&S FSW-K18)	AMPLifier	Amplifier
AM/FM/PM Modulation Analysis (R&S FSW-K7)	ADEM	Analog Demod
Avionics (R&S FSW-K15)	AVIonics	Avionics
Bluetooth (R&S FSW-K8)	BTO	Bluetooth
cdma2000 BTS (R&S FSW-K82)	BC2K	CDMA2000 BTS
cdma2000 MS (R&S FSW-K83)	MC2K	CDMA2000 MS
DOCSIS 3.1 (R&S FSW-K192/193)	DOCSis	DOCSIS 3.1
Fast Spur Search (R&S FSW-K50)	SPUR	Spurious
GSM (R&S FSW-K10)	GSM	GSM
HRP UWB (R&S FSW-K149)	UWB	HRP UWB
I/Q Analyzer	IQ	IQ Analyzer
LTE (R&S FSW-K10x)	LTE	LTE
Multi-Carrier "Group Delay" (R&S FSW-K17)	MCGD	MC "Group Delay"
NB-IoT (R&S FSW-K106)	NIOT	NB-IoT
Noise (R&S FSW-K30)	NOISE	Noise
*) If the specified name for a new channel already exists, the default name, extended by a sequential number, is used for the new channel.		

Application	<ChannelType> parameter	Default Channel name*)
5G NR (R&S FSW-K144)	NR5G	5G NR
OFDM VSA (R&S FSW-K96)	OFDMVSA	OFDM VSA
OneWeb (R&S FSW-K201)	OWEB	OneWeb
Phase Noise (R&S FSW-K40)	PNOISE	Phase Noise
Pulse (R&S FSW-K6)	PULSE	Pulse
"Real-Time Spectrum"	RTIM	"Real-Time Spectrum"
TD-SCDMA BTS (R&S FSW-K76)	BTDS	TD-SCDMA BTS
TD-SCDMA UE (R&S FSW-K77)	MTDS	TD-SCDMA UE
Transient Analysis (R&S FSW-K60)	TA	Transient Analysis
Verizon 5GTF Measurement Application (V5GTF, R&S FSW-K118)	V5GT	V5GT
VSA (R&S FSW-K70)	DDEM	VSA
WLAN (R&S FSW-K91)	WLAN	WLAN
*) If the specified name for a new channel already exists, the default name, extended by a sequential number, is used for the new channel.		

---

**INSTrument:REName** <ChannelName1>, <ChannelName2>

Renames a channel.

**Setting parameters:**

<ChannelName1> String containing the name of the channel you want to rename.

<ChannelName2> String containing the new channel name.  
 Note that you cannot assign an existing channel name to a new channel. If you do, an error occurs.  
 Channel names can have a maximum of 31 characters, and must be compatible with the Windows conventions for file names. In particular, they must not contain special characters such as ":", "\*", "?".

**Example:** `INST:REN 'IQAnalyzer2', 'IQAnalyzer3'`  
 Renames the channel with the name 'IQAnalyzer2' to 'IQAnalyzer3'.

**Usage:** Setting only

---

**INSTrument[:SElect]** <ChannelType> | <ChannelName>

This command activates a new measurement channel with the defined channel type, or selects an existing measurement channel with the specified name.

See also [INSTrument:CREate\[:NEW\]](#) on page 224.

For a list of available channel types see [INSTrument:LIST?](#) on page 225.

**Parameters:**

<ChannelType> Channel type of the new channel.  
For a list of available channel types see [INSTrument:LIST?](#) on page 225.

**WLAN**

WLAN option, R&S FSW-K91

<ChannelName> String containing the name of the channel.

**Example:**

```
INST WLAN
```

Activates a measurement channel for the R&S FSW WLAN application.

```
INST 'WLAN'
```

Selects the measurement channel named 'WLAN' (for example before executing further commands for that channel).

---

**SYSTem:PRESet:CHANnel[:EXEC]**

Restores the default instrument settings in the current channel.

Use `INST:SEL` to select the channel.

**Example:**

```
INST:SEL 'Spectrum2'
```

Selects the channel for "Spectrum2".

```
SYST:PRES:CHAN:EXEC
```

Restores the factory default settings to the "Spectrum2" channel.

**Usage:** Event

**Manual operation:** See "[Preset Channel](#)" on page 109

## 10.4 Selecting a measurement

The following commands are required to define the measurement type in a remote environment. The selected measurement must be started explicitly (see [Chapter 10.8, "Starting a measurement"](#), on page 367)!

For details on available measurements see [Chapter 3, "Measurements and result displays"](#), on page 15.



The WLAN IQ measurement captures the I/Q data from the WLAN signal using a (nearly rectangular) filter with a relatively large bandwidth. This measurement is selected when the WLAN measurement channel is activated. The commands to select a different measurement or return to the WLAN IQ measurement are described here.

Note that the `CONF:BURSt:<ResultType>:IMM` commands change the screen layout to display the "Magnitude Capture" buffer in window 1 at the top of the screen and the selected result type in window 2 below that. Any other active windows are closed.

Use the `LAYout` commands to change the display (see [Chapter 10.7, "Configuring the result display"](#), on page 347).

- [Selecting the WLAN IQ measurement \(modulation accuracy, flatness and tolerance\)](#)..... 229
- [Selecting a common RF measurement for WLAN signals](#)..... 234

#### 10.4.1 Selecting the WLAN IQ measurement (modulation accuracy, flatness and tolerance)

Any of the following commands can be used to return to the WLAN IQ measurement. Each of these results is automatically determined when the WLAN IQ measurement is performed.



The selected measurement must be started explicitly (see [Chapter 10.8, "Starting a measurement"](#), on page 367)!

<code>CONFigure:BURSt:AM:AM[:IMMEDIATE]</code> .....	230
<code>CONFigure:BURSt:AM:EVM[:IMMEDIATE]</code> .....	230
<code>CONFigure:BURSt:AM:PM[:IMMEDIATE]</code> .....	230
<code>CONFigure:BURSt:CONSt:CCARrier[:IMMEDIATE]</code> .....	230
<code>CONFigure:BURSt:CONSt:CSYMBOL[:IMMEDIATE]</code> .....	230
<code>CONFigure:BURSt:EVM:ECARrier[:IMMEDIATE]</code> .....	230
<code>CONFigure:BURSt:EVM:ESYMBOL[:IMMEDIATE] (IEEE 802.11b and g (DSSS))</code> .....	231
<code>CONFigure:BURSt:EVM:EVCHIP[:IMMEDIATE]</code> .....	231
<code>CONFigure:BURSt:EVM:ESYMBOL[:IMMEDIATE]</code> .....	231
<code>CONFigure:BURSt:GAIN:GCARrier[:IMMEDIATE]</code> .....	231
<code>CONFigure:BURSt:PREAmble[:IMMEDIATE]</code> .....	231
<code>CONFigure:BURSt:PREAmble:SELEct</code> .....	232
<code>CONFigure:BURSt:PTRacking[:IMMEDIATE]</code> .....	232
<code>CONFigure:BURSt:PVT[:IMMEDIATE]</code> .....	232
<code>CONFigure:BURSt:PVT:SELEct</code> .....	232
<code>CONFigure:BURSt:QUAD:QCARrier[:IMMEDIATE]</code> .....	233
<code>CONFigure:BURSt:SPECTrum:FFT[:IMMEDIATE]</code> .....	233
<code>CONFigure:BURSt:SPECTrum:FLATness:SELEct</code> .....	233
<code>CONFigure:BURSt:SPECTrum:FLATness[:IMMEDIATE]</code> .....	233
<code>CONFigure:BURSt:STATistics:BSTream[:IMMEDIATE]</code> .....	234
<code>CONFigure:BURSt:STATistics:SField[:IMMEDIATE]</code> .....	234

---

**CONFigure:BURSt:AM:AM[:IMMEDIATE]**

This remote control command configures the result display type of window 2 to be "AM vs AM". Results are only displayed after a measurement is executed, e.g. using the [INITiate<n>\[:IMMEDIATE\]](#) command.

**Manual operation:** See "[AM/AM](#)" on page 28

---

**CONFigure:BURSt:AM:EVM[:IMMEDIATE]**

This remote control command configures the result display type of window 2 to be "AM vs. EVM". Results are only displayed after a measurement is executed, e.g. using the [INITiate<n>\[:IMMEDIATE\]](#) command.

**Manual operation:** See "[AM/EVM](#)" on page 29

---

**CONFigure:BURSt:AM:PM[:IMMEDIATE]**

This remote control command configures the result display type of window 2 to be "AM vs PM". Results are only displayed after a measurement is executed, e.g. using the [INITiate<n>\[:IMMEDIATE\]](#) command.

**Manual operation:** See "[AM/PM](#)" on page 29

---

**CONFigure:BURSt:CONSt:CCARrier[:IMMEDIATE]**

This remote control command configures the result display type of window 2 to be "Constellation vs Carrier" .

Results are only displayed after a measurement is executed, e.g. using the [INITiate<n>\[:IMMEDIATE\]](#) command.

**Manual operation:** See "[Constellation vs Carrier](#)" on page 34

---

**CONFigure:BURSt:CONSt:CSYMBOL[:IMMEDIATE]**

This remote control command configures the result display type of window 2 to be "Constellation vs Symbol".

Results are only displayed after a measurement has been executed, e.g. using the [INITiate<n>\[:IMMEDIATE\]](#) command.

**Manual operation:** See "[Constellation](#)" on page 32

---

**CONFigure:BURSt:EVM:ECARrier[:IMMEDIATE]**

This remote control command configures the result display type of window 2 to be "EVM vs Carrier".

Results are only displayed after a measurement is executed, e.g. using the [INITiate<n>\[:IMMEDIATE\]](#) command.

**Manual operation:** See ["EVM vs Carrier"](#) on page 35

---

**CONFigure:BURSt:EVM:ESYMBOL[:IMMEDIATE] (IEEE 802.11b and g (DSSS))**  
**CONFigure:BURSt:EVM:EVCHIP[:IMMEDIATE]**

Both of these commands configure the measurement type to be "EVM vs Chip" for **IEEE 802.11b and g (DSSS)** standards. For compatibility reasons, the `CONFigure:BURSt:EVM:ESYMBOL[:IMMEDIATE]` command is also supported for the IEEE 802.11b and g (DSSS) standards. However, for new remote control programs use the `LAYout` commands (see [Chapter 10.7.2, "Working with windows in the display"](#), on page 349).

Results are only displayed after a measurement is executed, e.g. using the `INITiate<n>[:IMMEDIATE]` command.

**Manual operation:** See ["EVM vs Chip"](#) on page 36

---

**CONFigure:BURSt:EVM:ESYMBOL[:IMMEDIATE]**

This remote control command configures the measurement type to be "EVM vs Symbol".

For **IEEE 802.11b and g (DSSS)** standards, this command selects the "EVM vs Chip" result display.

Results are only displayed after a measurement is executed, e.g. using the `INITiate<n>[:IMMEDIATE]` command.

**Manual operation:** See ["EVM vs Chip"](#) on page 36  
See ["EVM vs Symbol"](#) on page 36

---

**CONFigure:BURSt:GAIN:GCARRIER[:IMMEDIATE]**

This remote control command configures the result display type of window 2 to be "Gain Imbalance vs Carrier". Results are only displayed after a measurement is executed, e.g. using the `INITiate<n>[:IMMEDIATE]` command.

**Manual operation:** See ["Gain Imbalance vs Carrier"](#) on page 39

---

**CONFigure:BURSt:PREAmble[:IMMEDIATE]**

This remote control command configures the measurement type to be "Frequency Error vs Preamble" or "Phase Error vs Preamble". Which of the two is determined by `CONFigure:BURSt:PREAmble:SElect`.

**Manual operation:** See ["Freq. Error vs Preamble"](#) on page 38  
See ["Phase Error vs Preamble"](#) on page 42

**CONFigure:BURSt:PREamble:SElect** <ErrType>

This remote control command specifies whether frequency or phase results are displayed when the measurement type is set to "Error Vs Preamble" ([CONFigure: BURSt:PREamble\[:IMMediate\]](#) on page 231).

**Parameters:**

<ErrType>                    FREQUency | PHASe

**FREQUency**

Displays frequency error results for the preamble of the measured PPDU's only

**PHASe**

Displays phase error results for the preamble of the measured PPDU's only

**Example:**

CONF: BURS: PRE: SEL PHAS

**Manual operation:**

See ["Freq. Error vs Preamble"](#) on page 38

See ["Phase Error vs Preamble"](#) on page 42

**CONFigure:BURSt:PTRacking[:IMMediate]**

This remote control command configures the measurement type to be "Phase Tracking vs Symbol".

**Manual operation:**    See ["Phase Tracking"](#) on page 43

**CONFigure:BURSt:PVT[:IMMediate]**

This remote control command configures the measurement type to be "Power vs Time".

**Manual operation:**

See ["PvT Full PPDU"](#) on page 44

See ["PvT Rising Edge"](#) on page 45

See ["PvT Falling Edge"](#) on page 46

**CONFigure:BURSt:PVT:SElect** <Mode>

This remote command determines how to interpret the "Power vs Time" measurement results.

**Parameters:**

<Mode>                    EDGE | FULL | RISE | FALL

**EDGE**

Displays rising and falling edges only

**FALL**

Displays falling edge only

**FULL**

Displays the full PPDU



**RISE**

Displays the rising edge only

**Manual operation:** See "PvT Full PPDU" on page 44  
 See "PvT Rising Edge" on page 45  
 See "PvT Falling Edge" on page 46

**CONFigure:BURSt:QUAD:QCARrier[:IMMEDIATE]**

This remote control command configures the result display type in window 2 to be "Quadrature Error vs Carrier". Results are only displayed after a measurement is executed, e.g. using the `INITiate<n>[:IMMEDIATE]` command.

**Manual operation:** See "Quad Error vs Carrier" on page 47

**CONFigure:BURSt:SPECTrum:FFT[:IMMEDIATE]**

This remote control command configures the result display type of window 2 to be "FFT Spectrum".

Results are only displayed after a measurement is executed, e.g. using the `INITiate<n>[:IMMEDIATE]` command.

**Manual operation:** See "FFT Spectrum" on page 37

**CONFigure:BURSt:SPECTrum:FLATness:SElect <MeasType>**

This remote control command configures result display type of window 2 to be either "Spectrum Flatness" or "Group Delay".

Results are only displayed after a measurement is executed, e.g. using the `INITiate<n>[:IMMEDIATE]` command.

**Parameters:**

<MeasType>            FLATness | GRDelay

**Example:**

```
CONF: BURS: SPEC: FLAT: SEL FLAT
```

Configures the result display of window 2 to be "Spectrum Flatness".

```
CONF: BURS: SPEC: FLAT: IMM
```

Performs a default WLAN measurement. When the measurement is completed, the "Spectrum Flatness" results are displayed.

**Manual operation:** See "Group Delay" on page 40  
 See "Spectrum Flatness" on page 54

**CONFigure:BURSt:SPECTrum:FLATness[:IMMEDIATE]**

This remote control command configures the result display in window 2 to be "Spectrum Flatness" or "Group Delay", depending on which result display was selected last using `CONFigure:BURSt:SPECTrum:FLATness:SElect` on page 233.

Results are only displayed after a measurement is executed, e.g. using the `INITiate<n>[:IMMEDIATE]` command.

**Example:**

```
CONF:BURS:SPEC:FLAT:SEL FLAT
```

Configures the result display of window 2 to be "Spectrum Flatness".

```
CONF:BURS:SPEC:FLAT:IMM
```

Performs a default WLAN measurement. When the measurement is completed, the "Spectrum Flatness" results are displayed.

**Manual operation:** See "Group Delay" on page 40  
See "Spectrum Flatness" on page 54

#### **CONFigure:BURSt:STATistics:BSTream[:IMMEDIATE]**

This remote control command configures the result display type of window 2 to be "Bitstream".

Results are only displayed after a measurement is executed, e.g. using the `INITiate<n>[:IMMEDIATE]` command.

**Manual operation:** See "Bitstream" on page 30

#### **CONFigure:BURSt:STATistics:SField[:IMMEDIATE]**

This remote control command configures the result display type of window 2 to be "Signal Field".

Results are only displayed after a measurement is executed, e.g. using the `INITiate<n>[:IMMEDIATE]` command.

**Manual operation:** See "PLCP Header (IEEE 802.11b, g (DSSS))" on page 43  
See "Signal Field" on page 52

## 10.4.2 Selecting a common RF measurement for WLAN signals

The following commands are required to select a common RF measurement for WLAN signals in a remote environment.

For details on available measurements see [Chapter 3.2, "Frequency sweep measurements"](#), on page 58.



The selected measurement must be started explicitly (see [Chapter 10.8, "Starting a measurement"](#), on page 367)!

<code>CONFigure:BURSt:SPECTrum:ACPR[:IMMEDIATE]</code> .....	235
<code>CONFigure:BURSt:SPECTrum:MASK[:IMMEDIATE]</code> .....	235
<code>CONFigure:BURSt:SPECTrum:OBWidth[:IMMEDIATE]</code> .....	235
<code>CONFigure:BURSt:STATistics:CCDF[:IMMEDIATE]</code> .....	235

Configuring the WLAN IQ measurement (modulation accuracy, flatness and tolerance)

---

#### **CONFigure:BURSt:SPECtrum:ACPR[:IMMEDIATE]**

This remote control command configures the result display in window 2 to be "ACPR" (adjacent channel power relative). Results are only displayed after a measurement is executed, e.g. using the `INITiate<n>[:IMMEDIATE]` command.

**Manual operation:** See "Channel Power ACLR" on page 59

---

#### **CONFigure:BURSt:SPECtrum:MASK[:IMMEDIATE]**

This remote control command configures the result display in window 2 to be "Spectrum Mask". Results are only displayed after a measurement is executed, e.g. using the `INITiate<n>[:IMMEDIATE]` command

**Manual operation:** See "Spectrum Emission Mask" on page 60

---

#### **CONFigure:BURSt:SPECtrum:OBWidth[:IMMEDIATE]**

This remote control command configures the result display in window 2 to be "ACPR" (adjacent channel power relative). Results are only displayed after a measurement is executed, e.g. using the `INITiate<n>[:IMMEDIATE]` command.

**Manual operation:** See "Occupied Bandwidth" on page 60

---

#### **CONFigure:BURSt:STATistics:CCDF[:IMMEDIATE]**

This remote control command configures the result display in window 2 to be "CCDF" (conditional cumulative distribution function). Results are only displayed after a measurement is executed, e.g. using the `INITiate<n>[:IMMEDIATE]` command.

**Manual operation:** See "CCDF" on page 61

## 10.5 Configuring the WLAN IQ measurement (modulation accuracy, flatness and tolerance)

The following commands are required to configure the WLAN IQ measurement described in [Chapter 3.1, "WLAN I/Q measurement \(modulation accuracy, flatness and tolerance\)"](#), on page 15.

- [Signal description](#).....236
- [Configuring the data input and output](#).....238
- [Frontend configuration](#).....264
- [Signal capturing](#).....274
- [Synchronization and OFDM demodulation](#).....293
- [Tracking and channel estimation](#).....294
- [Demodulation](#).....299
- [Evaluation range](#).....325

Configuring the WLAN IQ measurement (modulation accuracy, flatness and tolerance)

- [Limits](#).....333
- [Automatic settings](#).....338
- [Configuring the secondary application data range \(MSRA mode only\)](#)..... 340

## 10.5.1 Signal description

The signal description provides information on the expected input signal.

Useful commands for describing the WLAN signal described elsewhere:

- [\[SENSe:\] FREQuency:CENTer](#) on page 264

### Remote commands exclusive to describing the WLAN signal:

<a href="#">CONFigure:STANdard</a> .....	236
<a href="#">CALCulate&lt;n&gt;:LIMit&lt;li&gt;:TOLerance</a> .....	237
<a href="#">CONFigure:BURSt:EVM:STANdard</a> .....	238

---

### CONFigure:STANdard <Standard>

This remote control command specifies which WLAN standard the option is configured to measure.

The availability of many commands depends on the selected standard!

#### Parameters:

<Standard>	0	IEEE 802.11a
	1	IEEE 802.11b
	2	IEEE 802.11j (10 MHz)
	3	IEEE 802.11j (20 MHz)
	4	IEEE 802.11g
		To distinguish between OFDM and DSSS use the command <a href="#">[SENSe:] DEMod:FORMat:BANalyze:BTYPe</a> on page 306. By default, the R&S FSW WLAN application selects the most recently defined PPDU type.
	6	IEEE 802.11n
	7	IEEE 802.11n (MIMO)
	8	IEEE 802.11ac
	9	IEEE 802.11p

Configuring the WLAN IQ measurement (modulation accuracy, flatness and tolerance)

**10**  
IEEE 802.11ax

**11**  
IEEE 802.11be

\*RST: 0

**Example:** Select IEEE 802.11g OFDM standard:  
CONF:STAN 4  
SENS:DEM:FORM:BAN:BTYP 'OFDM'

**Manual operation:** See "[Standard](#)" on page 110

### CALCulate<n>:LIMit<li>:TOLerance <Limit>

Defines or queries the tolerance limit to be used for the measurement. The required tolerance limit depends on the used standard.

#### Suffix:

<n> 1..n  
irrelevant

<li> 1..n  
irrelevant

#### Parameters:

<Limit> **'Prior802\_11\_2012'**  
Tolerance limits are based on the IEEE 802.11 specification **prior to 2012**.  
Default for OFDM standards (except 802.11ac).

**'Std802\_11\_2012'**  
Tolerance limits are based on the IEEE 802.11 specification from **2012**.  
Required for DSSS standards. Also possible for OFDM standards (except 802.11ac).

**'P802\_11acD5\_1'**  
Tolerance limits are based on the **IEEE 802.11ac** specification.  
Required by IEEE 802.11ac standard.

**'P802\_11axD0\_1'**  
Tolerance limits are based on the **IEEE 802.11ax** specification.  
Required by IEEE 802.11ax standard.

**'P802\_11beD0\_1'**  
Tolerance limits are based on the **IEEE 802.11be** specification.  
Required by IEEE 802.11be standard.

\*RST: 'Std802\_11\_2012'

**Example:** CALC:LIM:TOL 'Std802\_11\_2012'

**Manual operation:** See "[Tolerance Limit](#)" on page 111

Configuring the WLAN IQ measurement (modulation accuracy, flatness and tolerance)

### CONFigure:BURSt:EVM:STANdard <EVMStandard>

Defines or queries the standard version to be used for the EVM measurement.

Is only available for **IEEE 802.11b and g (DSSS)**

#### Parameters:

<EVMStandard> 'Std802\_11b\_1999' | 'Std802\_11b\_2012' | 'Std802\_11b\_2016'

**'Std802\_11b\_1999'**  
EVM measurement based on the IEEE 802.11b specification **prior to 2012.**

**'Std802\_11b\_2012'**  
EVM measurement based on the IEEE 802.11b specification from **2012.**

**'Std802\_11b\_2016'**  
EVM measurement based on the **IEEE 802.11b** specification from **2016.**

\*RST: 'Std802\_11\_2012'

**Example:** CONF:BURSt:EVM:STAN 'Std802\_11b\_2012'

**Manual operation:** See "[Standard Version for Error Vector Magnitude \(IEEE 802.11b and g \(DSSS\) only\)](#)" on page 111

## 10.5.2 Configuring the data input and output

- [RF input](#).....238
- [Using external mixers](#).....242
- [Configuring digital I/Q input and output](#).....256
- [Configuring input via the optional Analog Baseband interface](#).....258
- [Input from I/Q data files](#).....260
- [Configuring the outputs](#).....263

### 10.5.2.1 RF input

<a href="#">INPut:ATTenuation:PROTection:RESet</a> .....	239
<a href="#">INPut:CONNector</a> .....	239
<a href="#">INPut:COUPling</a> .....	239
<a href="#">INPut:DPATH</a> .....	240
<a href="#">INPut:FILTer:HPASs[:STATe]</a> .....	240
<a href="#">INPut:FILTer:YIG[:STATe]</a> .....	240
<a href="#">INPut:IMPedance</a> .....	241
<a href="#">INPut:SELEct</a> .....	241
<a href="#">INPut:TYPE</a> .....	242

Configuring the WLAN IQ measurement (modulation accuracy, flatness and tolerance)

---

### INPut:ATTenuation:PROTection:RESet

Resets the attenuator and reconnects the RF input with the input mixer for the FSW after an overload condition occurred and the protection mechanism intervened. The error status bit (bit 3 in the `STAT:QUES:POW` status register) and the `INPUT_OVLD` message in the status bar are cleared.

The command works only if the overload condition has been eliminated first.

For details on the protection mechanism, see "[RF Input Protection](#)" on page 113.

**Example:** `INP:ATT:PROT:RES`

---

### INPut:CONNector <ConnType>

Determines which connector the input for the measurement is taken from.

#### Parameters:

<ConnType>

#### RF

RF input connector

#### AIQI

Analog Baseband I connector

This setting is only available if the "Analog Baseband" interface (FSW-B71) is installed and active for input. It is not available for the FSW67 or FSW85.

For more information on the "Analog Baseband" interface (FSW-B71), see the FSW I/Q Analyzer and I/Q Input User Manual.

#### RFPRobe

Active RF probe

\*RST: RF

**Example:** `INP:CONN RF`  
Selects input from the RF input connector.

**Manual operation:** See "[Input Connector](#)" on page 115

---

### INPut:COUPling <CouplingType>

Selects the coupling type of the RF input.

#### Parameters:

<CouplingType>

AC | DC

#### AC

AC coupling

#### DC

DC coupling

\*RST: AC

**Example:** `INP:COUP DC`

**Manual operation:** See "[Input Coupling](#)" on page 114

Configuring the WLAN IQ measurement (modulation accuracy, flatness and tolerance)

---

### INPut:DPATH <DirectPath>

Enables or disables the use of the direct path for frequencies close to 0 Hz.

#### Parameters:

<DirectPath>            AUTO | OFF

**AUTO | 1**  
(Default) the direct path is used automatically for frequencies close to 0 Hz.

**OFF | 0**  
The analog mixer path is always used.

**Example:**            INP:DPAT OFF

**Manual operation:** See "[Direct Path](#)" on page 114

---

### INPut:FILTer:HPASs[:STATe] <State>

Activates an additional internal high-pass filter for RF input signals from 1 GHz to 3 GHz. This filter is used to remove the harmonics of the FSW to measure the harmonics for a DUT, for example.

Requires an additional high-pass filter hardware option.

(Note: for RF input signals outside the specified range, the high-pass filter has no effect. For signals with a frequency of approximately 4 GHz upwards, the harmonics are suppressed sufficiently by the YIG-preselector, if available.)

#### Parameters:

<State>            ON | OFF | 0 | 1

**OFF | 0**  
Switches the function off

**ON | 1**  
Switches the function on

\*RST:            0

**Example:**            INP:FILT:HPAS ON  
Turns on the filter.

**Manual operation:** See "[High Pass Filter 1 to 3 GHz](#)" on page 115

---

### INPut:FILTer:YIG[:STATe] <State>

Enables or disables the YIG filter.

#### Parameters:

<State>            ON | OFF | 0 | 1

**Example:**            INP:FILT:YIG OFF  
Deactivates the YIG-preselector.

**Manual operation:** See "[YIG-Preselector](#)" on page 115



Configuring the WLAN IQ measurement (modulation accuracy, flatness and tolerance)

---

### INPut:IMPedance <Impedance>

Selects the nominal input impedance of the RF input. In some applications, only 50 Ω are supported.

#### Parameters:

<Impedance>            50 | 75  
                               \*RST:        50 Ω  
                               Default unit: OHM

**Example:**            INP:IMP 75

**Manual operation:** See "[Impedance](#)" on page 114  
 See "[Unit](#)" on page 122

---

### INPut:SElect <Source>

Selects the signal source for measurements, i.e. it defines which connector is used to input data to the FSW.

If no additional input options are installed, only RF input or file input is supported.

For FSW85 models with two RF input connectors, you must select the input connector to configure first using [INPut:TYPE](#).

Tip: The I/Q data to be analyzed for WLAN 802.11 cannot only be measured by the R&S FSW WLAN application itself, it can also be imported to the application, provided it has the correct format. Furthermore, the analyzed I/Q data from the R&S FSW WLAN application can be exported for further analysis in external applications.

For details, see the FSW I/Q Analyzer and I/Q Input User Manual.

#### Parameters:

<Source>                **RF**  
 Radio Frequency ("RF INPUT" connector)

**FIQ**  
 I/Q data file  
 (selected by [INPut:FILE:PATH](#) on page 261)  
 Not available for Input2.

**DIQ**  
 Digital IQ data (only available with optional "Digital Baseband" interface)  
 For details on I/Q input see the FSW I/Q Analyzer User Manual.  
 Not available for Input2.

**AIQ**  
 Analog Baseband signal (only available with optional "Analog Baseband" interface)  
 Not available for Input2.

                              \*RST:        RF

Configuring the WLAN IQ measurement (modulation accuracy, flatness and tolerance)

**Example:** `INP:TYPE INP1`  
 For FSW85 models with two RF input connectors: selects the 1.00 mm RF input connector for configuration.  
`INP:SEL RF`

**Manual operation:** See ["Radio Frequency State"](#) on page 113  
 See ["I/Q Input File State"](#) on page 116

### INPut:TYPE <Input>

The command selects the input path.

#### Parameters:

<Input>                   **INPUT1**  
 Selects RF input 1.  
 1 mm [RF Input] connector

**INPUT2**  
 Selects RF input 2.  
 For FSW85 models with two RF input connectors:  
 1.85 mm [RF2 Input] connector  
 For all other models: not available

\*RST:           INPUT1

**Example:**               //Select input path  
`INP:TYPE INPUT1`

**Manual operation:** See ["Radio Frequency State"](#) on page 113

## 10.5.2.2 Using external mixers

The commands required to work with external mixers in a remote environment are described here. Note that these commands require the FSW to have an external mixer option installed and an external mixer to be connected to the FSW.

In MSRA mode, external mixers are not supported.

- [Basic settings](#).....242
- [Mixer settings](#).....245
- [Conversion loss table settings](#).....250
- [Programming example: working with an external mixer](#).....254

### Basic settings

The basic settings concern general usage of an external mixer.

<a href="#">[SENSe:]MIXer&lt;x&gt;[:STATe]</a> .....	243
<a href="#">[SENSe:]MIXer&lt;x&gt;:BIAS:HIGH</a> .....	243
<a href="#">[SENSe:]MIXer&lt;x&gt;:BIAS[:LOW]</a> .....	243
<a href="#">[SENSe:]MIXer&lt;x&gt;:LOPower</a> .....	243
<a href="#">[SENSe:]MIXer&lt;x&gt;:SIGNal</a> .....	244
<a href="#">[SENSe:]MIXer&lt;x&gt;:THReshold</a> .....	244

Configuring the WLAN IQ measurement (modulation accuracy, flatness and tolerance)

### [SENSe:]MIXer<x>[:STATe] <State>

Activates or deactivates the use of a connected external mixer as input for the measurement. This command is only available if the optional External Mixer is installed and an external mixer is connected.

#### Suffix:

<x>                    1..n  
                          irrelevant

#### Parameters:

<State>                ON | OFF | 1 | 0  
\*RST:                 0

**Example:**            MIX ON

### [SENSe:]MIXer<x>:BIAS:HIGH <BiasSetting>

Defines the bias current for the high (last) range.

Is only available if the external mixer is active (see [\[SENSe:\]MIXer<x>\[:STATe\]](#) on page 243).

#### Suffix:

<x>                    1..n  
                          irrelevant

#### Parameters:

<BiasSetting>        \*RST:            0.0 A  
                          Default unit: A

### [SENSe:]MIXer<x>:BIAS[:LOW] <BiasSetting>

Defines the bias current for the low (first) range.

Is only available if the external mixer is active (see [\[SENSe:\]MIXer<x>\[:STATe\]](#) on page 243).

#### Suffix:

<x>                    1..n  
                          irrelevant

#### Parameters:

<BiasSetting>        \*RST:            0.0 A  
                          Default unit: A

### [SENSe:]MIXer<x>:LOPower <Level>

Specifies the LO level of the external mixer's LO port.

#### Suffix:

<x>                    1..n  
                          irrelevant

Configuring the WLAN IQ measurement (modulation accuracy, flatness and tolerance)

**Parameters:**

<Level>                   Range:       13.0 dBm to 17.0 dBm  
 Increment: 0.1 dB  
 \*RST:       15.5 dBm  
 Default unit: DBM

**Example:**               MIX:LOP 16.0dBm

**[SENSe:]MIXer<x>:SIGNal <State>**

Specifies whether automatic signal detection is active or not.

Note that automatic signal identification is only available for measurements that perform frequency sweeps (not in vector signal analysis or the I/Q Analyzer, for instance).

**Suffix:**

<x>                        1..n  
 irrelevant

**Parameters:**

<State>                   OFF | ON | AUTO | ALL  
**OFF | ON | AUTO | ALL**  
**OFF**  
 No automatic signal detection is active.  
**ON**  
 Automatic signal detection (Signal ID) is active.  
**AUTO**  
 Automatic signal detection (Auto ID) is active.  
**ALL**  
 Both automatic signal detection functions (Signal ID+Auto ID) are active.  
 \*RST:       OFF

**[SENSe:]MIXer<x>:THReshold <Value>**

Defines the maximum permissible level difference between test sweep and reference sweep to be corrected during automatic comparison (see [\[SENSe:\]MIXer<x>:SIGNal](#) on page 244).

**Suffix:**

<x>                        1..n  
 irrelevant

**Parameters:**

<Value>                   <numeric value>  
 Range:       0.1 dB to 100 dB  
 \*RST:       10 dB  
 Default unit: DB

**Example:**               MIX:PORT 3

Configuring the WLAN IQ measurement (modulation accuracy, flatness and tolerance)

### Mixer settings

The following commands are required to configure the band and specific mixer settings.

[SENSe:]MIXer<x>:FREQUency:HANdOver.....	245
[SENSe:]MIXer<x>:FREQUency:STARt.....	245
[SENSe:]MIXer<x>:FREQUency:STOP.....	246
[SENSe:]MIXer<x>:HARMonic:BAND:PRESet.....	246
[SENSe:]MIXer<x>:HARMonic:BAND.....	246
[SENSe:]MIXer<x>:HARMonic:HIGH:STATe.....	247
[SENSe:]MIXer<x>:HARMonic:HIGH[:VALue].....	247
[SENSe:]MIXer<x>:HARMonic:TYPE.....	247
[SENSe:]MIXer<x>:HARMonic[:LOW].....	248
[SENSe:]MIXer<x>:IF?.....	248
[SENSe:]MIXer<x>:LOSS:HIGH.....	248
[SENSe:]MIXer<x>:LOSS:TABLE:HIGH.....	249
[SENSe:]MIXer<x>:LOSS:TABLE[:LOW].....	249
[SENSe:]MIXer<x>:LOSS[:LOW].....	249
[SENSe:]MIXer<x>:PORTs.....	250
[SENSe:]MIXer<x>:RFOVerrange[:STATe].....	250

---

#### [SENSe:]MIXer<x>:FREQUency:HANdOver <Frequency>

Defines the frequency at which the mixer switches from one range to the next (if two different ranges are selected). The handover frequency for each band can be selected freely within the overlapping frequency range.

Is only available if the external mixer is active (see [SENSe:]MIXer<x>[:STATe] on page 243).

#### Suffix:

<x>                      1..n  
                             irrelevant

#### Parameters:

<Frequency>            Default unit: HZ

#### Example:

```
MIX ON
Activates the external mixer.
MIX:FREQ:HAND 78.0299GHz
Sets the handover frequency to 78.0299 GHz.
```

---

#### [SENSe:]MIXer<x>:FREQUency:STARt

Sets or queries the frequency at which the external mixer band starts.

#### Suffix:

<x>                      1..n  
                             irrelevant

#### Example:

```
MIX:FREQ:STAR?
Queries the start frequency of the band.
```

Configuring the WLAN IQ measurement (modulation accuracy, flatness and tolerance)

---

### [SENSe:]MIXer<x>:FREQuency:STOP

Sets or queries the frequency at which the external mixer band stops.

**Suffix:**

<x>                    1..n  
                          irrelevant

**Example:**

MIX:FREQ:STOP?  
Queries the stop frequency of the band.

---

### [SENSe:]MIXer<x>:HARMonic:BAND:PRESet

Restores the preset frequency ranges for the selected standard waveguide band.

**Note:** Changes to the band and mixer settings are maintained even after using the [PRESET] function. Use this command to restore the predefined band ranges.

**Suffix:**

<x>                    1..n  
                          irrelevant

**Example:**

MIX:HARM:BAND:PRESet  
Presents the selected waveguide band.

---

### [SENSe:]MIXer<x>:HARMonic:BAND <Band>

Selects the external mixer band. The query returns the currently selected band.

Is only available if the external mixer is active (see [SENSe:]MIXer<x>[:STATe] on page 243).

**Suffix:**

<x>                    1..n  
                          irrelevant

**Parameters:**

<Band>                KA|Q|U|V|E|W|F|D|G|Y|J|USER  
Standard waveguide band or user-defined band.

**Table 10-3: Frequency ranges for pre-defined bands**

Band	Frequency start [GHz]	Frequency stop [GHz]
KA (A) *)	26.5	40.0
Q	33.0	50.0
U	40.0	60.0
V	50.0	75.0
E	60.0	90.0
W	75.0	110.0

\*) The band formerly referred to as "A" is now named "KA".

Configuring the WLAN IQ measurement (modulation accuracy, flatness and tolerance)

Band	Frequency start [GHz]	Frequency stop [GHz]
F	90.0	140.0
D	110.0	170.0
G	140.0	220.0
J	220.0	325.0
Y	325.0	500.0
USER	32.18 (default)	68.22 (default)

\*) The band formerly referred to as "A" is now named "KA".

---

#### [SENSe:]MIXer<x>:HARMonic:HIGH:STATe <State>

Specifies whether a second (high) harmonic is to be used to cover the band's frequency range.

##### Suffix:

<x> 1..n

##### Parameters:

<State> ON | OFF  
\*RST: ON

**Example:** MIX:HARM:HIGH:STAT ON

---

#### [SENSe:]MIXer<x>:HARMonic:HIGH[:VALue] <HarmOrder>

Specifies the harmonic order to be used for the high (second) range.

##### Suffix:

<x> 1..n  
irrelevant

##### Parameters:

<HarmOrder> Range: 2 to 128 (USER band); for other bands: see band definition

**Example:** MIX:HARM:HIGH:STAT ON  
MIX:HARM:HIGH 3

---

#### [SENSe:]MIXer<x>:HARMonic:TYPE <OddEven>

Specifies whether the harmonic order to be used should be odd, even, or both.

Which harmonics are supported depends on the mixer type.

##### Suffix:

<x> 1..n  
irrelevant

Configuring the WLAN IQ measurement (modulation accuracy, flatness and tolerance)

**Parameters:**

<OddEven> ODD | EVEN | EODD

**ODD | EVEN | EODD**

\*RST: EVEN

**Example:**

MIX:HARM:TYPE ODD

**[SENSe:]MIXer<x>:HARMonic[:LOW] <HarmOrder>**

Specifies the harmonic order to be used for the low (first) range.

**Suffix:**

<x> 1..n  
irrelevant

**Parameters:**

<HarmOrder> Range: 2 to 128 (USER band); for other bands: see band definition

\*RST: 2 (for band F)

**Example:**

MIX:HARM 3

**[SENSe:]MIXer<x>:IF?**

Queries the intermediate frequency currently used by the external mixer.

**Suffix:**

<x> 1..n  
irrelevant

**Example:**

MIX:IF?

**Example:**

See "[Programming example: working with an external mixer](#)" on page 254.

**Usage:**

Query only

**[SENSe:]MIXer<x>:LOSS:HIGH <Average>**

Defines the average conversion loss to be used for the entire high (second) range.

**Suffix:**

<x> 1..n  
irrelevant

**Parameters:**

<Average> Range: 0 to 100

\*RST: 24.0 dB

Default unit: dB

**Example:**

MIX:LOSS:HIGH 20dB



Configuring the WLAN IQ measurement (modulation accuracy, flatness and tolerance)

---

**[SENSe:]MIXer<x>:LOSS:TABLE:HIGH <FileName>**

Defines the conversion loss table to be used for the high (second) range.

**Suffix:**

<x>                    1..n  
                         irrelevant

**Parameters:**

<FileName>            String containing the path and name of the file, or the serial number of the external mixer whose file is required. The FSW automatically selects the correct cvl file for the current IF. As an alternative, you can also select a user-defined conversion loss table (.acl file).

**Example:**

```
MIX:LOSS:TABLE:HIGH '101567'
MIX:LOSS:TABLE:HIGH?
//Result for installed B5000, bw<= 4.4 GHz: 101567_B5000_2G8.B5G:
//'101567_MAG_6_B5000_2G8.B5G'
//Result for installed B5000, bw> 4.4 GHz: 101567_B5000_2G8.B5G:
//'101567_MAG_6_B5000_3G5.B5G'
//Result for installed B2001 and bw> 80 MHz:
//'101567_MAG_6_B1200_B2001.B2G'
//Result for installed B2001 and bw<= 80 MHz:
//'101567_MAG_6.ACL'
```

---

**[SENSe:]MIXer<x>:LOSS:TABLE[:LOW] <FileName>**

Defines the file name of the conversion loss table to be used for the low (first) range.

**Suffix:**

<x>                    1..n  
                         irrelevant

**Parameters:**

<FileName>            String containing the path and name of the file, or the serial number of the external mixer whose file is required. The FSW automatically selects the correct cvl file for the current IF. As an alternative, you can also select a user-defined conversion loss table (.acl file).

**Example:**

```
MIX:LOSS:TABLE '101567'
MIX:LOSS:TABLE?
//Result:
'101567_MAG_6_B5000_3G5.B5G'
```

---

**[SENSe:]MIXer<x>:LOSS[:LOW] <Average>**

Defines the average conversion loss to be used for the entire low (first) range.

Configuring the WLAN IQ measurement (modulation accuracy, flatness and tolerance)

**Suffix:**

<x> 1..n  
irrelevant

**Parameters:**

<Average> Range: 0 to 100  
\*RST: 24.0 dB  
Default unit: dB

**Example:** MIX:LOSS 20dB

**[SENSe:]MIXer<x>:PORTs <PortType>**

Selects the mixer type.

**Suffix:**

<x> 1..n  
irrelevant

**Parameters:**

<PortType> 2 | 3  
2  
Two-port mixer.  
3  
Three-port mixer.  
\*RST: 2

**Example:** MIX:PORT 3

**[SENSe:]MIXer<x>:RFOVerrange[:STATe] <State>**

If enabled, the band limits are extended beyond "RF Start" and "RF Stop" due to the capabilities of the used harmonics.

**Suffix:**

<x> 1..n  
irrelevant

**Parameters:**

<State> ON | OFF | 1 | 0  
\*RST: 0

**Conversion loss table settings**

The following settings are required to configure and manage conversion loss tables.

[SENSe:]CORRection:CVL:BAND.....	251
[SENSe:]CORRection:CVL:BIAS.....	251
[SENSe:]CORRection:CVL:CATalog?.....	251
[SENSe:]CORRection:CVL:CLEar.....	252
[SENSe:]CORRection:CVL:COMMeNt.....	252
[SENSe:]CORRection:CVL:DATA.....	252

Configuring the WLAN IQ measurement (modulation accuracy, flatness and tolerance)

[SENSe:]CORRection:CVL:HARMonic.....	253
[SENSe:]CORRection:CVL:MIXer.....	253
[SENSe:]CORRection:CVL:PORTs.....	253
[SENSe:]CORRection:CVL:SElect.....	254
[SENSe:]CORRection:CVL:SNUMber.....	254

---

### [SENSe:]CORRection:CVL:BAND <Band>

Defines the waveguide band for which the conversion loss table is to be used. This setting is checked against the current mixer setting before the table can be assigned to the range.

Before this command can be performed, the conversion loss table must be selected (see [SENSe:]CORRection:CVL:SElect on page 254).

Is only available with option B21 (External Mixer) installed.

#### Parameters:

<Band>                    K | KA | Q | U | V | E | W | F | D | G | Y | J | USER  
 Standard waveguide band or user-defined band.  
 For a definition of the frequency range for the pre-defined bands, see [Table 10-3](#).  
 \*RST:                    F (90 GHz - 140 GHz)

#### Example:

```
CORR:CVL:SEL 'LOSS_TAB_4'
Selects the conversion loss table.
CORR:CVL:BAND KA
Sets the band to KA (26.5 GHz - 40 GHz).
```

---

### [SENSe:]CORRection:CVL:BIAS <BiasSetting>

Defines the bias setting to be used with the conversion loss table.

Before this command can be performed, the conversion loss table must be selected (see [SENSe:]CORRection:CVL:SElect on page 254).

Is only available with option B21 (External Mixer) installed.

#### Parameters:

<BiasSetting>            \*RST:            0.0 A  
 Default unit: A

#### Example:

```
CORR:CVL:SEL 'LOSS_TAB_4'
Selects the conversion loss table.
CORR:CVL:BIAS 3A
```

---

### [SENSe:]CORRection:CVL:CATalog?

Queries all available conversion loss tables saved in the C:\R\_S\INSTR\USER\cv1\ directory on the instrument.

Is only available with option B21 (External Mixer) installed.

Configuring the WLAN IQ measurement (modulation accuracy, flatness and tolerance)

**Return values:**

<Files> 'string'  
Comma-separated list of strings containing the file names.

**Example:** CORR:CVL:CAT?

**Usage:** Query only

**[SENSe:]CORRection:CVL:CLEAr**

Deletes the selected conversion loss table. Before this command can be performed, the conversion loss table must be selected (see [\[SENSe:\]CORRection:CVL:SELEct](#) on page 254).

Is only available with option B21 (External Mixer) installed.

**Example:** CORR:CVL:SEL 'LOSS\_TAB\_4'  
Selects the conversion loss table.  
CORR:CVL:CLE

**[SENSe:]CORRection:CVL:COMMeNt <Text>**

Defines a comment for the conversion loss table. Before this command can be performed, the conversion loss table must be selected (see [\[SENSe:\]CORRection:CVL:SELEct](#) on page 254).

Is only available with option B21 (External Mixer) installed.

**Parameters:**

<Text>

**Example:** CORR:CVL:SEL 'LOSS\_TAB\_4'  
Selects the conversion loss table.  
CORR:CVL:COMM 'Conversion loss table for  
FS\_Z60'

**[SENSe:]CORRection:CVL:DATA {<Freq>, <Level>}...**

Defines the reference values of the selected conversion loss tables. The values are entered as a set of frequency/level pairs. You can define a maximum of 500 frequency/level pairs. Before this command can be performed, you must select the conversion loss table (see [\[SENSe:\]CORRection:CVL:SELEct](#) on page 254).

Is only available with option B21 (External Mixer) installed.

**Parameters:**

<Freq> The frequencies have to be sent in ascending order.  
Default unit: HZ  
<Level> Default unit: DB

Configuring the WLAN IQ measurement (modulation accuracy, flatness and tolerance)

**Example:**

```
CORR:CVL:SEL 'LOSS_TAB_4'
Selects the conversion loss table.
CORR:CVL:DATA 1MHZ,-30DB,2MHZ,-40DB
```

---

#### [SENSe:]CORRection:CVL:HARMonic <HarmOrder>

Defines the harmonic order for which the conversion loss table is to be used. This setting is checked against the current mixer setting before the table can be assigned to the range.

Before this command can be performed, the conversion loss table must be selected (see [SENSe:]CORRection:CVL:SElect on page 254).

Is only available with option B21 (External Mixer) installed.

**Parameters:**  
<HarmOrder>            Range:     2 to 65

**Example:**

```
CORR:CVL:SEL 'LOSS_TAB_4'
Selects the conversion loss table.
CORR:CVL:HARM 3
```

---

#### [SENSe:]CORRection:CVL:MIXer <Type>

Defines the mixer name in the conversion loss table. This setting is checked against the current mixer setting before the table can be assigned to the range.

Before this command can be performed, the conversion loss table must be selected (see [SENSe:]CORRection:CVL:SElect on page 254).

Is only available with option B21 (External Mixer) installed.

**Parameters:**  
<Type>                    string  
Name of mixer with a maximum of 16 characters

**Example:**

```
CORR:CVL:SEL 'LOSS_TAB_4'
Selects the conversion loss table.
CORR:CVL:MIX 'FS_Z60'
```

---

#### [SENSe:]CORRection:CVL:PORTs <PortType>

Defines the mixer type in the conversion loss table. This setting is checked against the current mixer setting before the table can be assigned to the range.

Before this command can be performed, the conversion loss table must be selected (see [SENSe:]CORRection:CVL:SElect on page 254).

Is only available with option B21 (External Mixer) installed.

**Parameters:**  
<PortType>                2 | 3  
\*RST:                      2

Configuring the WLAN IQ measurement (modulation accuracy, flatness and tolerance)

**Example:**                   CORR:CVL:SEL 'LOSS\_TAB\_4'  
                                  Selects the conversion loss table.  
                                  CORR:CVL:PORT 3

---

#### [SENSe:]CORRection:CVL:SElect <FileName>

Selects the conversion loss table with the specified file name. If <file\_name> is not available, a new conversion loss table is created.

Is only available with option B21 (External Mixer) installed.

#### Parameters:

<FileName>                   String containing the path and name of the file.

**Example:**                   CORR:CVL:SEL 'LOSS\_TAB\_4'

---

#### [SENSe:]CORRection:CVL:SNUMber <SerialNo>

Defines the serial number of the mixer for which the conversion loss table is to be used. This setting is checked against the current mixer setting before the table can be assigned to the range.

Before this command can be performed, the conversion loss table must be selected (see [SENSe:]CORRection:CVL:SElect on page 254).

Is only available with option B21 (External Mixer) installed.

#### Parameters:

<SerialNo>                   Serial number with a maximum of 16 characters

**Example:**                   CORR:CVL:SEL 'LOSS\_TAB\_4'  
                                  Selects the conversion loss table.  
                                  CORR:CVL:MIX '123.4567'

### Programming example: working with an external mixer

This example demonstrates how to work with an external mixer in a remote environment. It is performed in the Spectrum application in the default layout configuration. Note that without a real input signal and connected mixer, this measurement will not return useful results.

```
//-----Preparing the instrument -----
//Reset the instrument
*RST
//Activate the use of the connected external mixer.
SENS:MIX ON
//----- Configuring basic mixer behavior -----
//Set the LO level of the mixer's LO port to 15 dBm.
SENS:MIX:LOP 15dBm
//Set the bias current to -1 mA .
SENS:MIX:BIAS:LOW -1mA
//----- Configuring the mixer and band settings -----
//Use band "V" to full possible range extent for assigned harmonic (6).
```

## Configuring the WLAN IQ measurement (modulation accuracy, flatness and tolerance)

```

SENS:MIX:HARM:BAND V
SENS:MIX:RFOV ON
//Query the possible range
SENS:MIX:FREQ:STAR?
//Result: 47480000000 (47.48 GHz)
SENS:MIX:FREQ:STOP?
//Result: 138020000000 (138.02 GHz)
//Use a 3-port mixer type
SENS:MIX:PORT 3
//Split the frequency range into two ranges;
//range 1 covers 47.48 GHz GHz to 80 GHz; harmonic 6, average conv. loss of 20 dB
//range 2 covers 80 GHz to 138.02 GHz; harmonic 8, average conv.loss of 30 dB
SENS:MIX:HARM:TYPE EVEN
SENS:MIX:HARM:HIGH:STAT ON
SENS:MIX:FREQ:HAND 80GHz
SENS:MIX:HARM:LOW 6
SENS:MIX:LOSS:LOW 20dB
SENS:MIX:HARM:HIGH 8
SENS:MIX:LOSS:HIGH 30dB
//----- Activating automatic signal identification functions -----
//Activate both automatic signal identification functions.
SENS:MIX:SIGN ALL
//Use auto ID threshold of 8 dB.
SENS:MIX:THR 8dB

//-----Performing the Measurement-----
//Select single sweep mode.
INIT:CONT OFF
//Initiate a basic frequency sweep and wait until the sweep has finished.
INIT;*WAI
//-----Retrieving Results-----
//Return the trace data for the input signal without distortions
//(default screen configuration)
TRAC:DATA? TRACE3

```

## Configuring a conversion loss table for a user-defined band

```

//-----Preparing the instrument -----
//Reset the instrument
*RST
//Activate the use of the connected external mixer.
SENS:MIX ON
//-----Configuring a new conversion loss table -----
//Define cvl table for range 1 of band as described in previous example
// (extended V band)
SENS:CORR:CVL:SEL 'UserTable'
SENS:CORR:CVL:COMM 'User-defined conversion loss table for USER band'
SENS:CORR:CVL:BAND USER
SENS:CORR:CVL:HARM 6

```

## Configuring the WLAN IQ measurement (modulation accuracy, flatness and tolerance)

```

SENS:CORR:CVL:BIAS -1mA
SENS:CORR:CVL:MIX 'FS_Z60'
SENS:CORR:CVL:SNUM '123.4567'
SENS:CORR:CVL:PORT 3
//Conversion loss is linear from 55 GHz to 75 GHz
SENS:CORR:CVL:DATA 55GHZ,-20DB,75GHZ,-30DB
//----- Configuring the mixer and band settings -----
//Use user-defined band and assign new cvl table.
SENS:MIX:HARM:BAND USER
//Define band by two ranges;
//range 1 covers 47.48 GHz to 80 GHz; harmonic 6, cvl table 'UserTable'
//range 2 covers 80 GHz to 138.02 GHz; harmonic 8, average conv.loss of 30 dB
SENS:MIX:HARM:TYPE EVEN
SENS:MIX:HARM:HIGH:STAT ON
SENS:MIX:FREQ:HAND 80GHz
SENS:MIX:HARM:LOW 6
SENS:MIX:LOSS:TABL:LOW 'UserTable'
SENS:MIX:HARM:HIGH 8

SENS:MIX:LOSS:HIGH 30dB
//Query the possible range
SENS:MIX:FREQ:STAR?
//Result: 47480000000 (47.48 GHz)
SENS:MIX:FREQ:STOP?
//Result: 138020000000 (138.02 GHz)

//-----Performing the Measurement-----
//Select single sweep mode.
INIT:CONT OFF
//Initiate a basic frequency sweep and wait until the sweep has finished.
INIT;*WAI
//-----Retrieving Results-----
//Return the trace data (default screen configuration)
TRAC:DATA? TRACel

```

### 10.5.2.3 Configuring digital I/Q input and output

Useful commands for digital I/Q data described elsewhere:

- `INP:SEL DIQ` (see `INPut:SElect` on page 241)
- `TRIGger[:SEquence]:LEVel:BBPower` on page 279

#### Remote commands exclusive to digital I/Q data input and output

<code>INPut:DIQ:CDEvice</code> .....	257
<code>INPut:DIQ:RANGe:COUPling</code> .....	257
<code>INPut:DIQ:RANGe[:UPPer]</code> .....	257
<code>INPut:DIQ:RANGe[:UPPer]:AUTO</code> .....	257



Configuring the WLAN IQ measurement (modulation accuracy, flatness and tolerance)

INPut:DIQ:RANGe[:UPPer]:UNIT.....	258
INPut:DIQ:SRATe.....	258
INPut:DIQ:SRATe:AUTO.....	258

---

### INPut:DIQ:CDEVice

Queries the current configuration and the status of the digital I/Q input from the optional "Digital Baseband" interface.

For details see the section "Interface Status Information" for the optional "Digital Baseband" interface in the FSW I/Q Analyzer User Manual.

#### Return values:

<Value>

#### Example:

```
INP:DIQ:CDEV?
```

Result:

```
1, SMW200A, 101190, BBMM 1 OUT,
1000000000, 2000000000, Passed, Passed, 1, 1. #QNAN
```

---

### INPut:DIQ:RANGe:COUPling <State>

If enabled, the reference level for digital input is adjusted to the full scale level automatically if the full scale level changes.

Is only available if the optional "Digital Baseband" interface is installed.

#### Parameters:

<State>            ON | OFF | 1 | 0  
\*RST:            0

---

### INPut:DIQ:RANGe[:UPPer] <Level>

Defines or queries the "Full Scale Level", i.e. the level that corresponds to an I/Q sample with the magnitude "1".

Is only available if the optional "Digital Baseband" interface is installed.

#### Parameters:

<Level>            Range:        1  $\mu$ V to 7.071 V  
\*RST:            1 V  
Default unit: DBM

---

### INPut:DIQ:RANGe[:UPPer]:AUTO <State>

If enabled, the digital input full scale level is automatically set to the value provided by the connected device (if available).

Is only available if the optional "Digital Baseband" interface is installed.

#### Parameters:

<State>            ON | OFF | 1 | 0  
\*RST:            0

Configuring the WLAN IQ measurement (modulation accuracy, flatness and tolerance)

---

#### **INPut:DIQ:RANGe[:UPPer]:UNIT** <Level>

Defines the unit of the full scale level. The availability of units depends on the measurement application you are using.

Is only available if the optional "Digital Baseband" interface is installed.

#### **Parameters:**

<Level> DBM | DBPW | WATT | DBUV | DBMV | VOLT | DBUA | AMPere  
\*RST: Volt

---

#### **INPut:DIQ:SRATe** <SampleRate>

Specifies or queries the sample rate of the input signal from the optional "Digital Baseband" interface.

#### **Parameters:**

<SampleRate> Range: 1 Hz to 20 GHz  
\*RST: 32 MHz  
Default unit: HZ

**Example:** INP:DIQ:SRAT 200 MHz

---

#### **INPut:DIQ:SRATe:AUTO** <State>

If enabled, the sample rate of the digital I/Q input signal is set automatically by the connected device.

Is only available if the optional "Digital Baseband" interface is installed.

#### **Parameters:**

<State> ON | OFF | 1 | 0  
\*RST: 0

### 10.5.2.4 Configuring input via the optional Analog Baseband interface

The following commands are required to control the optional "Analog Baseband" interface in a remote environment. They are only available if this option is installed.

Useful commands for Analog Baseband data described elsewhere:

- INP:SEL AIQ (see [INPut:SElect](#) on page 241)
- [\[SENSe:\]FREQuency:CENTer](#) on page 264

Commands for the Analog Baseband calibration signal are described in the FSW User Manual.

Configuring the WLAN IQ measurement (modulation accuracy, flatness and tolerance)

### Remote commands exclusive to Analog Baseband data input and output

<a href="#">INPut:IQ:BALanced[:STATe]</a> .....	259
<a href="#">INPut:IQ:FULLscale:AUTO</a> .....	259
<a href="#">INPut:IQ:FULLscale[:LEVel]</a> .....	259
<a href="#">INPut:IQ:TYPE</a> .....	260
<a href="#">CALibration:AIQ:HATiming[:STATe]</a> .....	260

---

#### **INPut:IQ:BALanced[:STATe]** <State>

Defines whether the input is provided as a differential signal via all 4 Analog Baseband connectors or as a plain I/Q signal via 2 single-ended lines.

##### Parameters:

<State>                    ON | OFF | 1 | 0  
                               **ON | 1**  
                               Differential  
                               **OFF | 0**  
                               Single ended  
                               \*RST:        1

**Example:**                INP:IQ:BAL OFF

---

#### **INPut:IQ:FULLscale:AUTO** <State>

Defines whether the full scale level (i.e. the maximum input power on the Baseband Input connector) is defined automatically according to the reference level, or manually.

##### Parameters:

<State>                    **ON | 1**  
                               Automatic definition  
                               **OFF | 0**  
                               Manual definition according to [INPut:IQ:FULLscale\[:LEVel\]](#) on page 259  
                               \*RST:        1

**Example:**                INP:IQ:FULL:AUTO OFF

---

#### **INPut:IQ:FULLscale[:LEVel]** <PeakVoltage>

Defines the peak voltage at the Baseband Input connector if the full scale level is set to manual mode (see [INPut:IQ:FULLscale:AUTO](#) on page 259).

##### Parameters:

<PeakVoltage>            0.25 V | 0.5 V | 1 V | 2 V  
                               Peak voltage level at the connector.  
                               For probes, the possible full scale values are adapted according to the probe's attenuation and maximum allowed power.  
                               \*RST:        1V  
                               Default unit: V

Configuring the WLAN IQ measurement (modulation accuracy, flatness and tolerance)

**Example:** `INP:IQ:FULL 0.5V`

---

#### **INPut:IQ:TYPE** <DataType>

Defines the format of the input signal.

#### **Parameters:**

<DataType>

`IQ | I | Q`

#### **IQ**

The input signal is filtered and resampled to the sample rate of the application.

Two input channels are required for each input signal, one for the in-phase component, and one for the quadrature component.

#### **I**

The in-phase component of the input signal is filtered and resampled to the sample rate of the application. If the center frequency is not 0, the in-phase component of the input signal is down-converted first (Low IF I).

#### **Q**

The quadrature component of the input signal is filtered and resampled to the sample rate of the application. If the center frequency is not 0, the quadrature component of the input signal is down-converted first (Low IF Q).

\*RST: `IQ`

**Example:** `INP:IQ:TYPE Q`

---

#### **CALibration:AIQ:HATiming[:STATe]** <State>

Activates a mode with enhanced timing accuracy between analog baseband, RF and external trigger signals.

For more information, see the FSW I/Q Analyzer and I/Q Input User Manual.

#### **Parameters:**

<State>

`ON | OFF | 0 | 1`

#### **OFF | 0**

Switches the function off

#### **ON | 1**

Switches the function on

**Example:** `CAL:AIQ:HAT:STAT ON`

### 10.5.2.5 Input from I/Q data files

The input for measurements can be provided from I/Q data files. The commands required to configure the use of such files are described here.

For details see the FSW I/Q Analyzer and I/Q Input User Manual.

Configuring the WLAN IQ measurement (modulation accuracy, flatness and tolerance)

Useful commands for retrieving results described elsewhere:

- `INPut:SElect` on page 241

#### Remote commands exclusive to input from I/Q data files:

<code>INPut:FILE:PATH</code> .....	261
<code>MMEMory:LOAD:IQ:STReam</code> .....	262
<code>MMEMory:LOAD:IQ:STReam:AUTO</code> .....	262
<code>MMEMory:LOAD:IQ:STReam:LIST?</code> .....	262
<code>TRACe:IQ:FILE:REPetition:COUNT</code> .....	263

---

#### `INPut:FILE:PATH` <FileName>[, <AnalysisBW>]

Selects the I/Q data file to be used as input for further measurements.

The I/Q data file must be in one of the following supported formats:

- `.iq.tar`
- `.iqw`
- `.csv`
- `.mat`
- `.wv`
- `.aid`

Only a single data stream or channel can be used as input, even if multiple streams or channels are stored in the file.

For some file formats that do not provide the sample rate and measurement time or record length, you must define these parameters manually. Otherwise the traces are not visible in the result displays.

#### Parameters:

<FileName>	String containing the path and name of the source file. The file type is determined by the file extension. If no file extension is provided, the file type is assumed to be <code>.iq.tar</code> . For <code>.mat</code> files, Matlab® v4 is assumed.
<AnalysisBW>	Optionally: The analysis bandwidth to be used by the measurement. The bandwidth must be smaller than or equal to the bandwidth of the data that was stored in the file. Default unit: HZ

#### Example:

```
INP:FILE:PATH 'C:\R_S\Instr\user\data.iq.tar'
```

Uses I/Q data from the specified file as input.

## Configuring the WLAN IQ measurement (modulation accuracy, flatness and tolerance)

**Example:**

```
//Load an IQW file
INP:SEL:FIQ
INP:FILE:PATH 'C:\R_S\Instr\user\data.iqw'
//Define the sample rate
TRAC:IQ:SRAT 10MHz
//Define the measurement time
SENSe:SWEEp:TIME 0.001001
//Start the measurement
INIT:IMM
```

**Manual operation:** See ["Select I/Q data file"](#) on page 116

**MMEMory:LOAD:IQ:STReam** <Channel>

Only available for files that contain more than one data stream from multiple channels: selects the data stream to be used as input for the currently selected channel.

Automatic mode ([MMEMory:LOAD:IQ:STReam:AUTO](#)) is set to OFF.

**Parameters:**

<Channel> String containing the channel name.

**Example:**

```
MMEM:LOAD:IQ:STR?
//Result: 'Channel1','Channel2'
MMEM:LOAD:IQ:STR 'Channel2'
```

**Manual operation:** See ["Selected Channel"](#) on page 117

**MMEMory:LOAD:IQ:STReam:AUTO** <State>

Only available for files that contain more than one data stream from multiple channels: automatically defines which data stream in the file is used as input for the channel.

**Parameters:**

<State> ON | OFF | 0 | 1

**OFF | 0**

The data stream specified by [MMEMory:LOAD:IQ:STReam](#) is used as input for the channel.

**ON | 1**

The first data stream in the file is used as input for the channel. Applications that support multiple data streams use the first data stream in the file for the first input stream, the second for the second stream etc.

```
*RST: 1
```

**Manual operation:** See ["Selected Channel"](#) on page 117

**MMEMory:LOAD:IQ:STReam:LIST?**

Returns the available channels in the currently loaded input file.

Configuring the WLAN IQ measurement (modulation accuracy, flatness and tolerance)

**Example:** MMEM:LOAD:IQ:STR?  
//Result: 'Channel1','Channel2'

**Usage:** Query only

**Manual operation:** See "[Selected Channel](#)" on page 117

---

#### TRACe:IQ:FILE:REPetition:COUNT <RepetitionCount>

Determines how often the data stream is repeatedly copied in the I/Q data memory. If the available memory is not sufficient for the specified number of repetitions, the largest possible number of complete data streams is used.

**Parameters:**

<RepetitionCount> integer

**Example:** TRAC:IQ:FILE:REP:COUN 3

**Manual operation:** See "[File Repetitions](#)" on page 117

### 10.5.2.6 Configuring the outputs

The following commands are required to provide output from the FSW.



Configuring trigger input/output is described in "[Configuring the trigger output](#)" on page 284.

<a href="#">DIAGnostic:SERVice:NSOource</a> .....	263
<a href="#">SYSTem:SPEaker:VOLume</a> .....	263

---

#### DIAGnostic:SERVice:NSOource <State>

Turns the 28 V supply of the BNC connector labeled [noise source control] on the FSW on and off.

**Parameters:**

<State> ON | OFF | 0 | 1  
**OFF | 0**  
Switches the function off  
**ON | 1**  
Switches the function on

**Example:** DIAG:SERV:NSO ON

**Manual operation:** See "[Noise Source Control](#)" on page 118

---

#### SYSTem:SPEaker:VOLume <Volume>

Defines the volume of the built-in loudspeaker for demodulated signals. This setting is maintained for all applications.

Configuring the WLAN IQ measurement (modulation accuracy, flatness and tolerance)

The command is available in the time domain in Spectrum mode and in Analog Modulation Analysis mode.

**Parameters:**

<Volume> Percentage of the maximum possible volume.  
 Range: 0 to 1  
 \*RST: 0.5

**Example:**

SYST:SPE:VOL 0  
 Switches the loudspeaker to mute.

### 10.5.3 Frontend configuration

The following commands configure frequency, amplitude and y-axis scaling settings, which represent the "frontend" of the measurement setup.

- [Frequency](#).....264
- [Amplitude settings](#).....266
- [Y-axis scaling](#).....273

#### 10.5.3.1 Frequency

<a href="#">[SENSe:]FREQUENCY:CENTer</a> .....	264
<a href="#">[SENSe:]FREQUENCY:CENTer:STEP</a> .....	264
<a href="#">[SENSe:]FREQUENCY:CENTer:STEP:AUTO</a> .....	265
<a href="#">[SENSe:]FREQUENCY:OFFSet</a> .....	265

---

#### **[SENSe:]FREQUENCY:CENTer <Frequency>**

Defines the center frequency.

**Parameters:**

<Frequency> For the allowed range and  $f_{max}$ , refer to the specifications document.  
 \*RST:  $f_{max}/2$   
 Default unit: Hz

**Example:**

FREQ:CENT 100 MHz  
 FREQ:CENT:STEP 10 MHz  
 FREQ:CENT UP  
 Sets the center frequency to 110 MHz.

**Manual operation:** See "[Frequency](#)" on page 110  
 See "[Center Frequency](#)" on page 119

---

#### **[SENSe:]FREQUENCY:CENTer:STEP <StepSize>**

Defines the center frequency step size.



Configuring the WLAN IQ measurement (modulation accuracy, flatness and tolerance)

You can increase or decrease the center frequency quickly in fixed steps using the `SENS:FREQ UP` AND `SENS:FREQ DOWN` commands, see [\[SENSe:\]FREQuency:CENTer](#) on page 264.

**Parameters:**

`<StepSize>` For  $f_{max}$ , refer to the specifications document.  
 Range: 1 to fMAX  
 \*RST: 0.1 x span  
 Default unit: Hz

**Example:**

```
//Set the center frequency to 110 MHz.
FREQ:CENT 100 MHz
FREQ:CENT:STEP 10 MHz
FREQ:CENT UP
```

**Manual operation:** See ["Center Frequency Stepsize"](#) on page 119

**[SENSe:]FREQuency:CENTer:STEP:AUTO <State>**

Couples or decouples the center frequency step size to the span.

In time domain (zero span) measurements, the center frequency is coupled to the RBW.

**Parameters:**

`<State>` ON | OFF | 0 | 1  
 \*RST: 1

**Example:**

```
FREQ:CENT:STEP:AUTO ON
Activates the coupling of the step size to the span.
```

**[SENSe:]FREQuency:OFFSet <Offset>**

Defines a frequency offset.

If this value is not 0 Hz, the application assumes that the input signal was frequency shifted outside the application. All results of type "frequency" will be corrected for this shift numerically by the application.

See also ["Frequency Offset"](#) on page 119.

**Note:** In MSRA mode, the setting command is only available for the MSRA primary application. For MSRA secondary applications, only the query command is available.

**Parameters:**

`<Offset>` Range: -1 THz to 1 THz  
 \*RST: 0 Hz  
 Default unit: HZ

**Example:**

```
FREQ:OFFS 1GHZ
```

**Manual operation:** See ["Frequency Offset"](#) on page 119

Configuring the WLAN IQ measurement (modulation accuracy, flatness and tolerance)

### 10.5.3.2 Amplitude settings

The following commands are required to configure the amplitude settings in a remote environment.

Useful commands for amplitude settings described elsewhere:

- `INPut:COUPling` on page 239
- `INPut:IMPedance` on page 241
- `[SENSe:]ADJust:LEVel` on page 340

#### Remote commands exclusive to amplitude settings:

<code>CALCulate&lt;n&gt;:UNIT:POWER</code> .....	266
<code>CONFigure:POWER:AUTO</code> .....	267
<code>CONFigure:POWER:AUTO:OEVM</code> .....	267
<code>CONFigure:POWER:AUTO:SWEep:TIME</code> .....	267
<code>CONFigure:POWER:EXPeCted:RF</code> .....	268
<code>CONFigure:POWER:EXPeCted:IQ</code> .....	268
<code>DISPlay[:WINDow&lt;n&gt;][:SUBWindow&lt;w&gt;]:TRACe&lt;t&gt;:Y[:SCALe]:RLEVel</code> .....	268
<code>DISPlay[:WINDow&lt;n&gt;][:SUBWindow&lt;w&gt;]:TRACe&lt;t&gt;:Y[:SCALe]:RLEVel:OFFSet</code> .....	269
<code>INPut:ATTenuation</code> .....	269
<code>INPut:ATTenuation:AUTO</code> .....	269
<code>INPut:ATTenuation:AUTO:MODE</code> .....	270
<code>INPut:EATT</code> .....	270
<code>INPut:EATT:AUTO</code> .....	270
<code>INPut:EATT:STATe</code> .....	271
<code>INPut:EGAIIn[:STATe]</code> .....	271
<code>INPut:GAIN:STATe</code> .....	272
<code>INPut:GAIN[:VALue]</code> .....	272
<code>[SENSe:]IQ:WBANd</code> .....	273

---

#### `CALCulate<n>:UNIT:POWER <Unit>`

Selects the power unit.

The unit applies to all power-based measurement windows with absolute values.

In addition, the unit of the reference level is adapted to the same unit.

#### Suffix:

<n>                      irrelevant

#### Parameters:

<Unit>                      \*RST:              dBm

#### Example:

`CALC:UNIT:POW DBM`  
Sets the power unit to dBm.

**Manual operation:** See "[Unit](#)" on page 122

Configuring the WLAN IQ measurement (modulation accuracy, flatness and tolerance)

---

### CONFigure:POWer:AUTO <Mode>

Is used to switch on or off automatic power level detection.

#### Parameters:

<Mode>

#### ON

Automatic power level detection is performed at the start of each measurement sweep, and the reference level is adapted accordingly.

#### OFF

The reference level must be defined manually (see [DISPlay\[:WINDow<n>\]\[:SUBWindow<w>\]:TRACe<t>:Y\[:SCALE\]:RLEVel](#) on page 268)

#### ONCE

Automatic power level detection is performed once at the start of the next measurement sweep, and the reference level is adapted accordingly.

The command with this parameter corresponds to [\[SENSe:\]ADJust:LEVel](#) on page 340.

\*RST: ON

**Manual operation:** See "[Reference Level Mode](#)" on page 121

---

### CONFigure:POWer:AUTO:OEVM <Optimisation>

Defines whether an optional iterative search is performed to determine the required settings for minimum residual EVM. If enabled, the required reference level, preamplifier and, optionally, attenuation are configured. [CONFigure:POWer:AUTO](#) is set to "OFF".

#### Parameters:

<Optimisation>

#### OFF

(Default): No optimization performed

#### FULL

An optional iterative search for minimum residual EVM is performed for the available preamplifier and attenuation settings. The optimal settings are configured.

#### PAONIy

An optional iterative search for minimum residual EVM is performed, but only the available preamplifier settings are considered during the search. The optimal settings are configured.

\*RST: OFF

**Example:** CONF:POW:AUTO:OEVM FULL

**Manual operation:** See "[Optimize EVM](#)" on page 122

---

### CONFigure:POWer:AUTO:SWEep:TIME <Value>

Is used to specify the auto track time, i.e. the sweep time for auto level detection.

Configuring the WLAN IQ measurement (modulation accuracy, flatness and tolerance)

This setting can currently only be defined in remote control, not in manual operation.

**Parameters:**

<Value>                    Auto level measurement sweep time  
                                   Default unit: S

**Example:**                    CONF:POW:AUTO:SWE:TIME 0.01 MS

**CONFigure:POWer:EXPEcted:RF** <Value>

Specifies the mean power level of the source signal as supplied to the instrument's RF input. This value is overwritten if "Auto Level" mode is turned on.

**Parameters:**

<Value>                    Default unit: DBM

**CONFigure:POWer:EXPEcted:IQ** <Value>

Specifies the mean power level of the source signal as supplied to the instrument's digital I/Q input. This value is overwritten if "Auto Level" mode is turned on.

**Parameters:**

<Value>                    Default unit: V

**DISPlay[:WINDow<n>][:SUBWindow<w>]:TRACe<t>:Y[:SCALe]:RLEVel**  
 <ReferenceLevel>

Defines the reference level (for all traces in all windows).

With a reference level offset  $\neq 0$ , the value range of the reference level is modified by the offset.

**Suffix:**

<n>                    irrelevant  
 <w>                    subwindow  
                           Not supported by all applications  
 <t>                    irrelevant

**Parameters:**

<ReferenceLevel>    The unit is variable.  
                           Range:        see specifications document  
                           \*RST:        0 dBm  
                           Default unit: DBM

**Example:**                    DISP:TRAC:Y:RLEV -60dBm

**Manual operation:**    See "[Reference Level](#)" on page 121

Configuring the WLAN IQ measurement (modulation accuracy, flatness and tolerance)

---

**DISPlay[:WINDow<n>][:SUBWindow<w>]:TRACe<t>:Y[:SCALe]:RLEVel:OFFSet**  
<Offset>

Defines a reference level offset (for all traces in all windows).

**Suffix:**

<n>                      irrelevant  
 <w>                      subwindow  
                             Not supported by all applications  
 <t>                      irrelevant

**Parameters:**

<Offset>                Range:        -200 dB to 200 dB  
                             \*RST:        0dB  
                             Default unit: DB

**Example:**                DISP:TRAC:Y:RLEV:OFFS -10dB

**Manual operation:**    See "[Shifting the Display \(Offset\)](#)" on page 121

---

**INPut:ATTenuation** <Attenuation>

Defines the total attenuation for RF input.

If an electronic attenuator is available and active, the command defines a mechanical attenuation (see [INPut:EATT:STATE](#) on page 271).

If you set the attenuation manually, it is no longer coupled to the reference level, but the reference level is coupled to the attenuation. Thus, if the current reference level is not compatible with an attenuation that has been set manually, the command also adjusts the reference level.

Is not available if the optional "Digital Baseband" interface is active.

**Parameters:**

<Attenuation>        Range:        see specifications document  
                             Increment:    5 dB (with optional electr. attenuator: 1 dB)  
                             \*RST:        10 dB (AUTO is set to ON)  
                             Default unit: DB

**Example:**                INP:ATT 30dB  
 Defines a 30 dB attenuation and decouples the attenuation from the reference level.

**Manual operation:**    See "[Attenuation Mode / Value](#)" on page 122

---

**INPut:ATTenuation:AUTO** <State>

Couples or decouples the attenuation to the reference level. Thus, when the reference level is changed, the FSW determines the signal level for optimal internal data processing and sets the required attenuation accordingly.

Is not available if the optional "Digital Baseband" interface is active.

Configuring the WLAN IQ measurement (modulation accuracy, flatness and tolerance)

**Parameters:**

<State> ON | OFF | 0 | 1  
\*RST: 1

**Example:**

INP:ATT:AUTO ON  
Couples the attenuation to the reference level.

**Manual operation:** See "[Attenuation Mode / Value](#)" on page 122

**INPut:ATTenuation:AUTO:MODE <OptMode>**

Selects the priority for signal processing *after* the RF attenuation has been applied.

**Parameters:**

<OptMode> LNOise | LDISTortion

**LNOise**

Optimized for high sensitivity and low noise levels

**LDISTortion**

Optimized for low distortion by avoiding intermodulation

\*RST: LDISTortion (WLAN application: LNOise)

**Example:**

INP:ATT:AUTO:MODE LNO

**Manual operation:** See "[Optimization](#)" on page 123

**INPut:EATT <Attenuation>**

Defines an electronic attenuation manually. Automatic mode must be switched off (INP:EATT:AUTO OFF, see [INPut:EATT:AUTO](#) on page 270).

If the current reference level is not compatible with an attenuation that has been set manually, the command also adjusts the reference level.

Requires the electronic attenuation hardware option.

Is not available if the optional "Digital Baseband" interface is active.

**Parameters:**

<Attenuation> attenuation in dB  
Range: see specifications document  
Increment: 1 dB  
\*RST: 0 dB (OFF)  
Default unit: DB

**Example:**

INP:EATT:AUTO OFF  
INP:EATT 10 dB

**Manual operation:** See "[Using Electronic Attenuation](#)" on page 124

**INPut:EATT:AUTO <State>**

Turns automatic selection of the electronic attenuation on and off.

Configuring the WLAN IQ measurement (modulation accuracy, flatness and tolerance)

If on, electronic attenuation reduces the mechanical attenuation whenever possible.

Requires the electronic attenuation hardware option.

Is not available if the optional "Digital Baseband" interface is active.

**Parameters:**

<State>                    ON | OFF | 0 | 1  
                               **OFF | 0**  
                               Switches the function off  
                               **ON | 1**  
                               Switches the function on  
                               \*RST:        1

**Example:**                INP:EATT:AUTO OFF

**Manual operation:**    See "[Using Electronic Attenuation](#)" on page 124

**INPut:EATT:STATe** <State>

Turns the electronic attenuator on and off.

Requires the electronic attenuation hardware option.

Is not available if the optional "Digital Baseband" interface is active.

**Parameters:**

<State>                    ON | OFF | 0 | 1  
                               **OFF | 0**  
                               Switches the function off  
                               **ON | 1**  
                               Switches the function on  
                               \*RST:        0

**Example:**                INP:EATT:STAT ON  
                               Switches the electronic attenuator into the signal path.

**Manual operation:**    See "[Using Electronic Attenuation](#)" on page 124

**INPut:EGAIN[:STATe]** <State>

Before this command can be used, the external preamplifier must be connected to the FSW. See the preamplifier's documentation for details.

When activated, the FSW automatically compensates the magnitude and phase characteristics of the external preamplifier in the measurement results.

Note that when an optional external preamplifier is activated, the internal preamplifier is automatically disabled, and vice versa.

For FSW85 models with two RF inputs, you must enable correction from the external preamplifier for each input individually. Correction cannot be enabled for both inputs at the same time.

## Configuring the WLAN IQ measurement (modulation accuracy, flatness and tolerance)

When deactivated, no compensation is performed even if an external preamplifier remains connected.

**Parameters:**

<State>                    ON | OFF | 0 | 1  
**OFF | 0**  
 No data correction is performed based on the external preamplifier  
**ON | 1**  
 Performs data corrections based on the external preamplifier  
 \*RST:                    0

**Example:**                    INP:EGA ON

**Manual operation:**    See "[Ext. PA Correction](#)" on page 125

**INPut:GAIN:STATe** <State>

Turns the internal preamplifier on and off. It requires the optional preamplifier hardware.

Note that if an optional external preamplifier is activated, the internal preamplifier is automatically disabled, and vice versa.

Is not available for input from the optional "Digital Baseband" interface.

For FSW85 models, no preamplifier is available.

If option R&S FSW-B22 is installed, the preamplifier is only active below 7 GHz.

If option R&S FSW-B24 is installed, the preamplifier is active for all frequencies.

**Parameters:**

<State>                    ON | OFF | 0 | 1  
**OFF | 0**  
 Switches the function off  
**ON | 1**  
 Switches the function on  
 \*RST:                    0

**Example:**                    INP:GAIN:STAT ON  
 INP:GAIN:VAL 15  
 Switches on 15 dB preamplification.

**Manual operation:**    See "[Preamplifier](#)" on page 124

**INPut:GAIN[:VALue]** <Gain>

Selects the "gain" if the preamplifier is activated (INP:GAIN:STAT ON, see [INPut:GAIN:STATe](#) on page 272).



Configuring the WLAN IQ measurement (modulation accuracy, flatness and tolerance)

The command requires the additional preamplifier hardware option.

**Parameters:**

<Gain> For all FSW models except for FSW85, the following settings are available:  
 15 dB and 30 dB  
 All other values are rounded to the nearest of these two.  
 30 dB  
 For older FSW43/FSW50/FSW67 models, the input signal is always amplified by about 30 dB when the preamplifier is active.  
 For FSW85 models, no preamplifier is available.  
 Default unit: DB

**Example:**

```
INP:GAIN:STAT ON
INP:GAIN:VAL 30
Switches on 30 dB preamplification.
```

**Manual operation:** See "[Preamplifier](#)" on page 124

**[SENSe:]IQ:WBANd <State>**

Selects the signal path for signal processing.

For details and restrictions, see "[Signal Path](#)" on page 123.

**Parameters:**

<State> ON | OFF | 0 | 1  
**OFF | 0**  
 The narrowband signal path is used.  
**ON | 1**  
 The wideband signal path is used.  
 \*RST: 0

**Example:**

```
SENS:IQ:WBAN ON
```

**Manual operation:** See "[Signal Path](#)" on page 123

### 10.5.3.3 Y-axis scaling

<a href="#">DISPlay[:WINDow&lt;n&gt;][:SUBWindow&lt;w&gt;]:TRACe&lt;t&gt;:Y[:SCALe].....</a>	273
<a href="#">DISPlay[:WINDow&lt;n&gt;][:SUBWindow&lt;w&gt;]:TRACe&lt;t&gt;:Y[:SCALe]:RPOSition.....</a>	274

**DISPlay[:WINDow<n>][:SUBWindow<w>]:TRACe<t>:Y[:SCALe] <Range>**

Defines the display range of the y-axis (for all traces).

**Suffix:**

<n> [Window](#)  
 <w> subwindow  
 Not supported by all applications  
 <t> irrelevant

Configuring the WLAN IQ measurement (modulation accuracy, flatness and tolerance)

**Example:** `DISP:TRAC:Y 110dB`

**Manual operation:** See "[Range](#)" on page 126

---

**DISPlay[:WINDow<n>][:SUBWindow<w>]:TRACe<t>:Y[:SCALe]:RPOsition**  
<Position>

Defines the vertical position of the reference level on the display grid (for all traces).

The FSW adjusts the scaling of the y-axis accordingly.

**Suffix:**

<n> [Window](#)

<w> subwindow  
Not supported by all applications

<t> irrelevant

**Example:** `DISP:TRAC:Y:RPOS 50PCT`

**Manual operation:** See "[Ref Level Position](#)" on page 127

## 10.5.4 Signal capturing

The following commands are required to configure how much and how data is captured from the input signal.



### MSRA operating mode

In MSRA operating mode, only the MSRA primary channel actually captures data from the input signal. The data acquisition settings for the WLAN 802.11 secondary application in MSRA mode define the **secondary application data extract**.

For details on the MSRA operating mode see the FSW MSRA User Manual.

- [General capture settings](#).....274
- [Configuring triggered measurements](#).....277
- [MIMO capture settings](#).....286

### 10.5.4.1 General capture settings

<a href="#">[SENSe]:JADJust:NCANcel:AVERAge[:COUNt]</a> .....	275
<a href="#">[SENSe]:JADJust:NCANcel:AVERAge[:STATe]</a> .....	275
<a href="#">[SENSe]:BANDwidth[:RESolution]:FILTer:STATe</a> .....	275
<a href="#">[SENSe]:DEMod:FILTer:CATalog?</a> .....	276
<a href="#">[SENSe]:DEMod:FILTer:EFLength</a> .....	276
<a href="#">[SENSe]:DEMod:FILTer:MODulation</a> .....	276
<a href="#">[SENSe]:SWAPiq</a> .....	276
<a href="#">[SENSe]:SWEp:TIME</a> .....	277
<a href="#">TRACe:IQ:SRATe</a> .....	277

Configuring the WLAN IQ measurement (modulation accuracy, flatness and tolerance)

---

**[SENSe:]ADJust:NCANcel:AVERage[:COUNT] <Length>**

Defines the number of measurements that are performed on the captured I/Q data to determine the average noise density due to the spectrum analyzer.

Only available if I/Q noise cancellation is enabled (`[SENSe:]ADJust:NCANcel:AVERage[:STATE] ON`).

**Parameters:**

<Length>                    integer  
                                   Number of measurements

**Example:**                    `[SENSe:]ADJust:NCANcel:AVERage[:STATE] ON`  
                                   `[SENSe:]ADJust:NCANcel:AVERage[:COUNT] 8`

**Manual operation:**    See "[Reduce Noise on I/Q Data](#)" on page 136

---

**[SENSe:]ADJust:NCANcel:AVERage[:STATE] <State>**

Enables and disables I/Q noise cancellation.

Requires the R&S FSW-K575 option and a synchronized, repetitive input signal.

The number of initial measurements performed is defined by `[SENSe:]ADJust:NCANcel:AVERage[:COUNT]` on page 275.

For details on the concept of I/Q noise cancellation, see the FSW I/Q Analyzer and I/Q Input User Manual.

**Parameters:**

<State>                    `ON | OFF | 0 | 1`  
                                   **OFF | 0**  
                                   Switches the function off  
                                   **ON | 1**  
                                   Switches the function on  
                                   If synchronization fails, the noise cancellation process is not started, and an error message is provided. Status bit 7 in the `STATUS:QUESTIONABLE:SYNC:CONDITION` status register is set (`BIT_K575_FAILED`).  
                                   \*RST:            0

**Example:**                    `[SENSe:]ADJust:NCANcel:AVERage[:STATE] ON`  
                                   `[SENSe:]ADJust:NCANcel:AVERage[:COUNT] 8`

**Manual operation:**    See "[Reduce Noise on I/Q Data](#)" on page 136

---

**[SENSe:]BANDwidth[:RESolution]:FILTer:STATE <State>**

This remote control command enables or disables use of the adjacent channel filter.

Configuring the WLAN IQ measurement (modulation accuracy, flatness and tolerance)

If activated, only the useful signal is analyzed, all signal data in adjacent channels is removed by the filter. This setting improves the signal to noise ratio and thus the EVM results for signals with strong or a large number of adjacent channels. However, for some measurements information on the effects of adjacent channels on the measured signal may be of interest.

**Parameters:**

<State> ON | OFF | 0 | 1  
\*RST: 1

**Manual operation:** See "[Suppressing \(Filter out\) Adjacent Channels \(IEEE 802.11a, ac, ax, g \(OFDM\), j, n, p, be\)](#)" on page 129

**[SENSe:]DEMod:FILTer:CATalog?**

Reads the names of all available filters.

**Return values:**

<Filters> <list>

**Usage:** Query only

**[SENSe:]DEMod:FILTer:EFLength <Length>**

Specifies the equalizer filter length in chips.

**Parameters:**

<Length> Range: 2 to 30  
\*RST: 10

**Manual operation:** See "[Equalizer Filter Length \(IEEE 802.11b, g \(DSSS\)\)](#)" on page 129

**[SENSe:]DEMod:FILTer:MODulation <TXFilter>, <RXFilter>**

Selects the transmit (TX) and receive (RX) filters. The names of the filters correspond to the file names; a query of all available filters is possible by means of the [\[SENSe:\]DEMod:FILTer:CATalog?](#) on page 276 command.

Is only available for **IEEE 802.11b** measurements.

**Parameters:**

<TXFilter> File name of the transmit filter  
<RXFilter> File name of the receive filter

**Manual operation:** See "[Transmit Filter\(IEEE 802.11b, g \(DSSS\)\)](#)" on page 129  
See "[Receive Filter \(IEEE 802.11b, g \(DSSS\)\)](#)" on page 129

**[SENSe:]SWAPiq <State>**

Defines whether or not the recorded I/Q pairs should be swapped (I<->Q) before being processed. Swapping I and Q inverts the sideband.

Configuring the WLAN IQ measurement (modulation accuracy, flatness and tolerance)

This is useful if the DUT interchanged the I and Q parts of the signal; then the FSW can do the same to compensate for it.

**Parameters:**

<State>                    **ON | 1**  
 I and Q signals are interchanged  
 Inverted sideband,  $Q+j*I$

**OFF | 0**  
 I and Q signals are not interchanged  
 Normal sideband,  $I+j*Q$

\*RST:                    0

**Manual operation:** See "[Swap I/Q](#)" on page 129

**[SENSe:]SWEep:TIME** <Time>

Defines the measurement time. It automatically decouples the time from any other settings.

**Parameters:**

<Time>                    refer to specifications document

\*RST:                    depends on current settings (determined automatically)

Default unit: S

**Manual operation:** See "[Capture Time](#)" on page 128

**TRACe:IQ:SRATe** <SampleRate>

Sets the final user sample rate for the acquired I/Q data. Thus, the user sample rate can be modified without affecting the actual data capturing settings on the FSW.

**Parameters:**

<SampleRate>            The valid sample rates are described in [Chapter A, "Sample rate and maximum usable I/Q bandwidth for RF input"](#), on page 446.

\*RST:                    32 MHz

Default unit: HZ

**Manual operation:** See "[Input Sample Rate](#)" on page 128

#### 10.5.4.2 Configuring triggered measurements

The following commands are required to configure a triggered measurement in a remote environment. The tasks for manual operation are described in [Chapter 5.3.4.2, "Trigger settings"](#), on page 130.

Configuring the WLAN IQ measurement (modulation accuracy, flatness and tolerance)



The \*OPC command should be used after commands that retrieve data so that subsequent commands to change the selected trigger source are held off until after the sweep is completed and the data has been returned.

- [Configuring the triggering conditions](#).....278
- [Configuring the trigger output](#).....284

### Configuring the triggering conditions

The following commands are required to configure a triggered measurement.

TRIGger[:SEQuence]:DTIME.....	278
TRIGger[:SEQuence]:HOLDoff[:TIME].....	278
TRIGger[:SEQuence]:IFPower:HOLDoff.....	279
TRIGger[:SEQuence]:IFPower:HYSteresis.....	279
TRIGger[:SEQuence]:LEVel:BBPower.....	279
TRIGger[:SEQuence]:LEVel[:EXternal<port>].....	280
TRIGger[:SEQuence]:LEVel:IFPower.....	280
TRIGger[:SEQuence]:LEVel:IQPower.....	280
TRIGger[:SEQuence]:LEVel:POWer:AUTO.....	281
TRIGger[:SEQuence]:LEVel:RFPower.....	281
TRIGger[:SEQuence]:SLOPe.....	282
TRIGger[:SEQuence]:SOURce.....	282
TRIGger[:SEQuence]:TIME:RINTerval.....	284

---

#### TRIGger[:SEQuence]:DTIME <DropoutTime>

Defines the time the input signal must stay below the trigger level before a trigger is detected again.

For input from the "Analog Baseband" interface using the baseband power trigger (BBP), the default drop out time is set to 100 ns to avoid unintentional trigger events (as no hysteresis can be configured in this case).

##### Parameters:

<DropoutTime> Dropout time of the trigger.  
 Range: 0 s to 10.0 s  
 \*RST: 0 s  
 Default unit: S

**Manual operation:** See "[Drop-Out Time](#)" on page 134

---

#### TRIGger[:SEQuence]:HOLDoff[:TIME] <Offset>

Defines the time offset between the trigger event and the start of the measurement.

##### Parameters:

<Offset> \*RST: 0 s  
 Default unit: S

**Example:** TRIG:HOLD 500us

Configuring the WLAN IQ measurement (modulation accuracy, flatness and tolerance)

**Manual operation:** See ["Trigger Offset"](#) on page 134

#### TRIGger[:SEQuence]:IFPower:HOLDoff <Period>

Defines the holding time before the next trigger event.

Note that this command can be used for **any trigger source**, not just IF Power (despite the legacy keyword).

##### Parameters:

<Period>                    Range:     0 s to 10 s  
                                  \*RST:     0 s  
                                  Default unit: S

##### Example:

```
TRIG:SOUR EXT
Sets an external trigger source.
TRIG:IFP:HOLD 200 ns
Sets the holding time to 200 ns.
```

**Manual operation:** See ["Trigger Holdoff"](#) on page 135

#### TRIGger[:SEQuence]:IFPower:HYSTeresis <Hysteresis>

Defines the trigger hysteresis, which is only available for "IF Power" trigger sources.

##### Parameters:

<Hysteresis>                Range:     3 dB to 50 dB  
                                  \*RST:     3 dB  
                                  Default unit: DB

##### Example:

```
TRIG:SOUR IFP
Sets the IF power trigger source.
TRIG:IFP:HYST 10DB
Sets the hysteresis limit value.
```

**Manual operation:** See ["Hysteresis"](#) on page 134

#### TRIGger[:SEQuence]:LEVel:BBPower <Level>

Sets the level of the baseband power trigger.

Is available for the optional "Digital Baseband" interface.

Is available for the optional "Analog Baseband" interface.

##### Parameters:

<Level>                    Range:     -50 dBm to +20 dBm  
                                  \*RST:     -20 dBm  
                                  Default unit: DBM

##### Example:

```
TRIG:LEV:BBP -30DBM
```

**Manual operation:** See ["Trigger Level"](#) on page 133

Configuring the WLAN IQ measurement (modulation accuracy, flatness and tolerance)

---

**TRIGger[:SEQuence]:LEVel[:EXTernal<port>] <TriggerLevel>**

Defines the level the external signal must exceed to cause a trigger event.

Note that the variable "Input/Output" connectors (ports 2+3) must be set for use as input using the `OUTPut:TRIGger<tp>:DIRection` command.

For details on the trigger source see "[Trigger Source](#)" on page 131.

**Suffix:**

<port>                      Selects the trigger port.  
 1 = trigger port 1 (TRIGGER INPUT connector on front panel)  
 2 = trigger port 2 (TRIGGER INPUT/OUTPUT connector on front panel)  
 (Not available for FSW85 models with two RF input connectors.)  
 3 = trigger port 3 (TRIGGER3 INPUT/OUTPUT connector on rear panel)

**Parameters:**

<TriggerLevel>            Range:        0.5 V to 3.5 V  
                               \*RST:        1.4 V  
                               Default unit: V

**Example:**                TRIG:LEV 2V

**Manual operation:**    See "[Trigger Level](#)" on page 133

---

**TRIGger[:SEQuence]:LEVel:IFPower <TriggerLevel>**

Defines the power level at the third intermediate frequency that must be exceeded to cause a trigger event.

Note that any RF attenuation or preamplification is considered when the trigger level is analyzed. If defined, a reference level offset is also considered.

For compatibility reasons, this command is also available for the "Baseband Power" trigger source when using the "Analog Baseband" interface.

For details on the trigger settings, see "[Trigger Source](#)" on page 131.

**Parameters:**

<TriggerLevel>            For details on available trigger levels and trigger bandwidths, see the specifications document.  
                               \*RST:        -20 dBm  
                               Default unit: DBM

**Example:**                TRIG:LEV:IFP -30DBM

**Manual operation:**    See "[Trigger Level](#)" on page 133

---

**TRIGger[:SEQuence]:LEVel:IQPower <TriggerLevel>**

Defines the magnitude the I/Q data must exceed to cause a trigger event.



Configuring the WLAN IQ measurement (modulation accuracy, flatness and tolerance)

Note that any RF attenuation or preamplification is considered when the trigger level is analyzed. If defined, a reference level offset is also considered.

For details on the trigger source, see ["Trigger Source"](#) on page 131.

**Parameters:**

<TriggerLevel>      Range:      -130 dBm to 30 dBm  
                          \*RST:      -20 dBm  
                          Default unit: DBM

**Example:**            TRIG:LEV:IQP -30DBM

**Manual operation:**    See ["Trigger Level"](#) on page 133

**TRIGger[:SEquence]:LEVel:POWer:AUTO <State>**

By default, the optimum trigger level for power triggers is automatically measured and determined at the start of each sweep (for Modulation Accuracy, Flatness, Tolerance... measurements).

Is only considered for TRIG:SEQ:SOUR IFP and TRIG:SEQ:SOUR RFP, see [TRIGger\[:SEquence\]:SOURce](#) on page 282

To define the trigger level manually, switch this function off and define the level using [TRIGger\[:SEquence\]:LEVel:IFPower](#) on page 280 or [TRIGger\[:SEquence\]:LEVel:RFPower](#) on page 281.

**Parameters for setting and query:**

<State>                **OFF | 0**  
                          Switches the auto level detection function off  
                          **ON | 1**  
                          Switches the auto level detection function on  
                          \*RST:            1

**Manual operation:**    See ["Trigger Level Mode"](#) on page 133

**TRIGger[:SEquence]:LEVel:RFPower <TriggerLevel>**

Defines the power level the RF input must exceed to cause a trigger event. Note that any RF attenuation or preamplification is considered when the trigger level is analyzed. If defined, a reference level offset is also considered.

The input signal must be between 500 MHz and 8 GHz.

For details on the trigger source, see ["Trigger Source"](#) on page 131.

**Parameters:**

<TriggerLevel>      For details on available trigger levels and trigger bandwidths, see the specifications document.  
                          \*RST:            -20 dBm  
                          Default unit: DBM

**Example:**            TRIG:LEV:RFP -30dBm

Configuring the WLAN IQ measurement (modulation accuracy, flatness and tolerance)

**Manual operation:** See ["Trigger Level"](#) on page 133

---

### TRIGger[:SEQUENCE]:SLOPe <Type>

For external and time domain trigger sources, you can define whether triggering occurs when the signal rises to the trigger level or falls down to it.

**Parameters:**

<Type>                    POSitive | NEGative

**POSitive**  
Triggers when the signal rises to the trigger level (rising edge).

**NEGative**  
Triggers when the signal drops to the trigger level (falling edge).

\*RST:                    POSitive

**Example:**                    TRIG:SLOP NEG

**Manual operation:** See ["Slope"](#) on page 135

---

### TRIGger[:SEQUENCE]:SOURce <Source>

Selects the trigger source.

For details on the available trigger sources, see ["Trigger Source"](#) on page 131.

**Note on external triggers:**

If a measurement is configured to wait for an external trigger signal in a remote control program, remote control is blocked until the trigger is received and the program can continue. Make sure that this situation is avoided in your remote control programs.

**Parameters:**

<Source>                    **IMMediate**  
Free Run

**EXTernal**  
Trigger signal from the "Trigger Input" connector.

**EXT2**  
Trigger signal from the "Trigger Input/Output" connector.  
For FSW85 models, Trigger 2 is not available due to the second RF input connector on the front panel. The trigger signal is taken from the "Trigger Input/Output" connector on the rear panel.  
Note: Connector must be configured for "Input".

**EXT3**  
Trigger signal from the "TRIGGER 3 INPUT/ OUTPUT" connector.  
Note: Connector must be configured for "Input".

## Configuring the WLAN IQ measurement (modulation accuracy, flatness and tolerance)

**RFPower**

First intermediate frequency

(Frequency and time domain measurements only.)

Not available for input from the optional "Analog Baseband" interface.

Not available for input from the optional "Digital Baseband" interface.

**IFPower**

Second intermediate frequency

Not available for input from the optional "Digital Baseband" interface.

For input from the optional "Analog Baseband" interface, this parameter is interpreted as `BBPower` for compatibility reasons.

**IQPower**

Magnitude of sampled I/Q data

For applications that process I/Q data, such as the I/Q Analyzer or optional applications.

Not available for input from the optional "Digital Baseband" interface.

**TIME**

Time interval

**BBPower**

Baseband power

For input from the optional "Analog Baseband" interface.

For input from the optional "Digital Baseband" interface.

**PSEN**

External power sensor

**GP0 | GP1 | GP2 | GP3 | GP4 | GP5**

For applications that process I/Q data, such as the I/Q Analyzer or optional applications, and only if the optional "Digital Baseband" interface is available.

Defines triggering of the measurement directly via the LVDS connector. The parameter specifies which general-purpose bit (0 to 5) provides the trigger data.

The assignment of the general-purpose bits used by the Digital IQ trigger to the LVDS connector pins is provided in ["Digital I/Q"](#) on page 132.

**TUNit**

If activated, the measurement is triggered by a connected R&S FS-Z11 trigger unit, simultaneously for all connected analyzers.

For details see [Chapter 4.11.6, "Trigger synchronization using an R&S FS-Z11 trigger unit"](#), on page 102.

\*RST: IMMEDIATE

**Example:**

```
TRIG:SOUR EXT
```

Selects the external trigger input as source of the trigger signal

Configuring the WLAN IQ measurement (modulation accuracy, flatness and tolerance)

**Manual operation:** See "Trigger Source" on page 131  
 See "Free Run" on page 131  
 See "External Trigger 1/2/3" on page 131  
 See "Baseband Power" on page 131  
 See "Digital I/Q" on page 132  
 See "RF Power" on page 132  
 See "I/Q Power" on page 133  
 See "Power Sensor" on page 133  
 See "Time" on page 133  
 See "FS-Z11 Trigger" on page 135

---

**TRIGger[:SEquence]:TIME:RINTerval** <Interval>

Defines the repetition interval for the time trigger.

**Parameters:**

<Interval>                    numeric value  
 Range:                    2 ms to 5000 s  
 \*RST:                    1.0 s  
 Default unit: S

**Example:**

TRIG:SOUR TIME  
 Selects the time trigger input for triggering.  
 TRIG:TIME:RINT 5  
 The measurement starts every 5 s.

**Manual operation:** See "Repetition Interval" on page 134

### Configuring the trigger output

The following commands are required to send the trigger signal to one of the variable "TRIGGER INPUT/OUTPUT" connectors on the FSW.

OUTPut:TRIGger<tp>:DIRection.....	284
OUTPut:TRIGger<tp>:LEVel.....	285
OUTPut:TRIGger<tp>:OTYPe.....	285
OUTPut:TRIGger<tp>:PULSe:IMMEDIATE.....	286
OUTPut:TRIGger<tp>:PULSe:LENGth.....	286

---

**OUTPut:TRIGger<tp>:DIRection** <Direction>

Selects the trigger direction for trigger ports that serve as an input as well as an output.

**Suffix:**

<tp>                    Selects the used trigger port.  
 2 = trigger port 2 (front)  
 (Not available for FSW85 models with two RF input connectors.)  
 3 = trigger port 3 (rear panel)

**Parameters:**

<Direction>            INPut | OUTPut

Configuring the WLAN IQ measurement (modulation accuracy, flatness and tolerance)

**INPut**

Port works as an input.

**OUTPut**

Port works as an output.

\*RST: INPut

**OUTPut:TRIGger<tp>:LEVel <Level>**

Defines the level of the (TTL compatible) signal generated at the trigger output.

Works only if you have selected a user-defined output with [OUTPut:TRIGger<tp>:OTYPe](#).

**Suffix:**

<tp> 1..n  
 Selects the trigger port to which the output is sent.  
 2 = trigger port 2 (front)  
 (Not available for FSW85 models with two RF input connectors.)  
 3 = trigger port 3 (rear)

**Parameters:**

<Level> **HIGH**  
 5 V  
**LOW**  
 0 V  
 \*RST: LOW

**Example:** OUTP:TRIG2:LEV HIGH

**OUTPut:TRIGger<tp>:OTYPe <OutputType>**

Selects the type of signal generated at the trigger output.

**Suffix:**

<tp> 1..n  
 Selects the trigger port to which the output is sent.  
 2 = trigger port 2 (front)  
 (Not available for FSW85 models with two RF input connectors.)  
 3 = trigger port 3 (rear)

**Parameters:**

<OutputType> **DEVice**  
 Sends a trigger signal when the FSW has triggered internally.  
**TARMed**  
 Sends a trigger signal when the trigger is armed and ready for an external trigger event.  
**UDEFinEd**  
 Sends a user-defined trigger signal. For more information, see [OUTPut:TRIGger<tp>:LEVel](#).  
 \*RST: DEVice

Configuring the WLAN IQ measurement (modulation accuracy, flatness and tolerance)

---

### OUTPut:TRIGger<tp>:PULSe:IMMEDIATE

Generates a pulse at the trigger output.

#### Suffix:

<tp> 1..n  
 Selects the trigger port to which the output is sent.  
 2 = trigger port 2 (front)  
 (Not available for FSW85 models with two RF input connectors.)  
 3 = trigger port 3 (rear)

---

### OUTPut:TRIGger<tp>:PULSe:LENGth <Length>

Defines the length of the pulse generated at the trigger output.

#### Suffix:

<tp> Selects the trigger port to which the output is sent.  
 2 = trigger port 2 (front)  
 (Not available for FSW85 models with two RF input connectors.)  
 3 = trigger port 3 (rear)

#### Parameters:

<Length> Pulse length in seconds.  
 Default unit: S

**Example:**           OUTP:TRIG2:PULS:LENG 0.02

#### 10.5.4.3 MIMO capture settings

The following commands are **only available for IEEE 802.11ac, n standards**.

Useful commands for defining MIMO capture settings described elsewhere:

- [CALCulate<n>:BURSt\[:IMMEDIATE\]](#) on page 369

#### Remote commands exclusive to defining MIMO capture settings:

<a href="#">CONFigure:WLAN:ANTMatrix:ADDRes&lt;ant&gt;</a> .....	287
<a href="#">CONFigure:WLAN:ANTMatrix:ANTenna&lt;ant&gt;</a> .....	287
<a href="#">CONFigure:WLAN:ANTMatrix:RLEVel&lt;ant&gt;:OFFSet</a> .....	287
<a href="#">CONFigure:WLAN:ANTMatrix:SOURce:AMPLitude:SOURce</a> .....	288
<a href="#">CONFigure:WLAN:ANTMatrix:SOURce:RLEVel:OFFSet</a> .....	289
<a href="#">CONFigure:WLAN:ANTMatrix:SOURce:ROSCillator:SOURce</a> .....	289
<a href="#">CONFigure:WLAN:ANTMatrix:SOURce:ROSCillator:SOURce:STAT&lt;ant&gt;</a> .....	290
<a href="#">CONFigure:WLAN:ANTMatrix:STATe&lt;ant&gt;</a> .....	290
<a href="#">CONFigure:WLAN:DUTConfig</a> .....	290
<a href="#">CONFigure:WLAN:MIMO:CAPTure</a> .....	291
<a href="#">CONFigure:WLAN:MIMO:CAPTure:BUFFer</a> .....	291
<a href="#">CONFigure:WLAN:MIMO:CAPTure:TYPE</a> .....	291
<a href="#">CONFigure:WLAN:MIMO:CSD</a> .....	292

Configuring the WLAN IQ measurement (modulation accuracy, flatness and tolerance)

<a href="#">CONFigure:WLAN:MIMO:OSP:ADDRes</a> .....	292
<a href="#">CONFigure:WLAN:MIMO:OSP:MODule</a> .....	292
<a href="#">CONFigure:WLAN:RSYNc:JOINed</a> .....	292

---

#### **CONFigure:WLAN:ANTMatrix:ADDRes<ant>** <Address>

This remote control command specifies the TCP/IP address for each receiver path in IPV4 format. Note, it is not possible to set the IP address of ANTMatrix1 (primary)

##### **Suffix:**

<ant> 1..n

##### **Parameters:**

<Address> TCP/IP address in IPV4 format

**Manual operation:** See "[Reference Status](#)" on page 139

---

#### **CONFigure:WLAN:ANTMatrix:ANTenna<ant>** <Antenna>

This remote control command specifies the antenna assignment of the receive path.

##### **Suffix:**

<ant> 1..n  
Analyzer

##### **Parameters:**

<Antenna> ANTenna1 | ANTenna2 | ANTenna3 | ANTenna4 | ANTenna5 |  
ANTenna6 | ANTenna7 | ANTenna8 | ANT1 | ANT2 | ANT3 |  
ANT4 | ANT5 | ANT6 | ANT7 | ANT8  
Antenna assignment of the receiver path

##### **Example:**

```
CONF:WLAN:ANTM:ANT2 ANT1
Analyzer number 2 measures antenna no. 1
CONF:WLAN:ANTM;ANT4 ANT2
Analyzer number 42 measures antenna no. 2
```

**Manual operation:** See "[Assignment](#)" on page 140

---

#### **CONFigure:WLAN:ANTMatrix:RLEVel<ant>:OFFSet** <OffLevel>

This remote control command determines whether the reference value offset for the specified antenna if the primary and secondary devices in a simultaneous MIMO setup are not coupled (see [CONFigure:WLAN:ANTMatrix:SOURce:RLEVel:OFFSet](#) on page 289 ).

##### **Suffix:**

<ant> 1..n  
antenna index as specified by [CONFigure:WLAN:ANTMatrix:STATE<ant>](#) on page 290

Configuring the WLAN IQ measurement (modulation accuracy, flatness and tolerance)

**Parameters:**

<OffLevel> level offset in dB  
 \*RST: 0  
 Default unit: DB

**Example:**

```
CONF:WLAN:ANTM:SOUR:RLEV:OFFS MAN
CONF:WLAN:ANTM:RLEV2:OFFS 10
```

Sets the reference level offset for the second antenna in the antenna matrix to 10 dB.

**Manual operation:** See "[Reference Level Offset](#)" on page 140

**CONFigure:WLAN:ANTMatrix:SOURce:AMPLitude:SOURce <Coupling>**

This remote control command determines whether the amplitude settings for the primary and secondary devices in a simultaneous MIMO setup are coupled or not.

**Parameters:**

<Coupling> PRIMary | AUTO | OFF  
 Coupling mode

**AUTO**

The secondary devices perform an auto-level at the same time as the primary. The amplitude settings are then determined automatically by each device according to the measured values. This feature requires that the WLAN 802.11 application FSW-K91 (version 1.31 or higher) is installed on the secondary device.

**PRIMary**

Both the primary and all secondaries use the same amplitude settings, according to the settings at the primary. All settings on the secondary are ignored (including "Reference Level Auto"). Note: if "Reference Level Auto" is set at the primary, the primary channel performs an auto-level measurement and the resulting amplitude settings are transferred to the secondaries.

**OFF**

Both the primary and secondary devices use their own amplitude settings as defined prior to the measurement; the settings are not coupled.

\*RST: PRIMary

**Example:**

```
CONF:WLAN:ANTM:SOUR:AMPL:SOUR AUTO
```

**Manual operation:** See "[Amplitude Settings Coupling](#)" on page 141



Configuring the WLAN IQ measurement (modulation accuracy, flatness and tolerance)

---

### CONFigure:WLAN:ANTMatrix:SOURce:RLEVel:OFFSet <Coupling>

This remote control command determines whether the reference level for the primary and secondary devices in a simultaneous MIMO setup are coupled or not.

#### Parameters:

<Coupling>            PRIMary | MANual  
Coupling mode

#### PRIMary

The secondary analyzers' reference levels are set to match that of the primary.

#### MANual

The secondary analyzers' reference levels are specified individually (see [CONFigure:WLAN:ANTMatrix:SOURce:RLEVel:OFFSet](#) on page 289) and are not coupled to the reference level offset of the primary analyzer.

\*RST:            PRIMary

#### Example:

```
CONF:WLAN:ANTM:SOUR:RLEV:OFFS MAN
CONF:WLAN:ANTM:RLEV2:OFFS 10
```

Sets the reference level offset for the second antenna in the antenna matrix to 10 dB.

**Manual operation:** See "[Reference Level Offset](#)" on page 140

---

### CONFigure:WLAN:ANTMatrix:SOURce:ROSCillator:SOURce <Coupling>

This remote control command determines whether the reference frequency for the primary and secondary devices in a simultaneous MIMO setup are coupled or not.

#### Parameters:

<Coupling>            AUTO | EXTernal | OFF  
Coupling mode

#### AUTO

Secondaries set to the same external reference source as primary.

Use an R&S Z11 trigger box to send to the same trigger to all devices (see [TRIG:SEQ:SOUR TUN](#)).

#### EXTernal

Secondaries' reference source is set to external.

Configure a trigger output from the primary (see [OUTPut:TRIGger<tp>:OTYPe](#) on page 285).

#### OFF

Secondaries' reference source is set to internal.

\*RST:            EXT

#### Example:

```
CONF:WLAN:ANTM:SOUR:ROSC:SOUR AUTO
```

**Manual operation:** See "[Reference Frequency Coupling](#)" on page 140

Configuring the WLAN IQ measurement (modulation accuracy, flatness and tolerance)

---

**CONFigure:WLAN:ANTMatrix:SOURce:ROSCillator:SOURce:STAT<ant>** <State>

Queries the connection state of the external reference for each channel (see also [CONFigure:WLAN:ANTMatrix:SOURce:ROSCillator:SOURce](#) on page 289).

If the IP address of the antenna is not available or valid, or the selected antenna is not active, an error message is returned.

**Suffix:**

<ant> 1..n  
antenna; 1 is primary

**Parameters:**

<State> ON | OFF | 0 | 1  
**OFF | 0**  
External reference not available  
**ON | 1**  
External reference available  
\*RST: 0

**Manual operation:** See "[LAN Status](#)" on page 139

---

**CONFigure:WLAN:ANTMatrix:STATE<ant>** <State>

This remote control command specifies the state of the specified antenna. Note, it is not possible to change the state of the first antenna (primary).

**Suffix:**

<ant> 1..n  
antenna; 1 is primary

**Parameters:**

<State> ON | OFF | 1 | 0  
State of the antenna

**Manual operation:** See "[State](#)" on page 139

---

**CONFigure:WLAN:DUTConfig** <NoOfAnt>

This remote control command specifies the number of antennas used for MIMO measurement.

**Parameters:**

<NoOfAnt> TX1 | TX2 | TX3 | TX4 | TX5 | TX6 | TX7 | TX8  
TX1: one antenna,  
TX2: two antennas etc.  
\*RST: TX1

**Example:** CONF:WLAN:DUTC TX1

**Manual operation:** See "[DUT MIMO Configuration](#)" on page 138

Configuring the WLAN IQ measurement (modulation accuracy, flatness and tolerance)

---

### CONFigure:WLAN:MIMO:CAPTure <SignalPath>

Specifies the signal path to be captured in MIMO sequential manual measurements. Subsequently, use the `INITiate<n>[:IMMediate]` command to start capturing data.

#### Parameters:

<SignalPath> RX1 | RX2 | RX3 | RX4 | RX5 | RX6 | RX7 | RX8  
 For details see "[Manual Sequential MIMO Data Capture](#)" on page 143.  
 \*RST: RX1

#### Example:

```
CONFigure:WLAN:MIMO:CAPTure RX2
INIT:IMM
Starts capturing data from the receive antenna number 2.
```

**Manual operation:** See "[Single / Cont.](#)" on page 144

---

### CONFigure:WLAN:MIMO:CAPTure:BUFFer <SignalPath>

Specifies the signal path to be captured in MIMO sequential manual measurements and immediately starts capturing data.

#### Parameters:

<SignalPath> RX1 | RX2 | RX3 | RX4 | RX5 | RX6 | RX7 | RX8  
 For details see "[Manual Sequential MIMO Data Capture](#)" on page 143.  
 \*RST: RX1

#### Example:

```
CONFigure:WLAN:MIMO:CAPTure:BUFFer RX2
Starts capturing data from the receive antenna number 2.
```

---

### CONFigure:WLAN:MIMO:CAPTure:TYPE <Method>

Specifies the method used to analyze MIMO signals.

#### Parameters:

<Method> SIMultaneous | OSP | MANual  
**SIMultaneous**  
 Simultaneous normal MIMO operation  
**OSP**  
 Sequential using open switch platform  
**MANual**  
 Sequential using manual operation  
 \*RST: SIM

**Manual operation:** See "[MIMO Antenna Signal Capture Setup](#)" on page 138  
 See "[Manual Sequential MIMO Data Capture](#)" on page 143

Configuring the WLAN IQ measurement (modulation accuracy, flatness and tolerance)

---

### CONFigure:WLAN:MIMO:CSD <Method>

Determines whether or not the cyclic shift delay (CSD) is used for timing synchronisation.

#### Parameters:

<Method>                   IGNore | APPLy

#### **APPLy**

(Default:) The timing offset estimation result (assuming CSD=0) is used for the subsequent signal analysis.

#### **IGNore**

The timing offset estimation result (assuming CSD=0) is ignored for the subsequent signal analysis.

\*RST:           APPLy

#### Example:

```
CONF:WLAN:MIMO:CSD IGN
```

The timing offset estimation result is ignored for the subsequent signal analysis.

**Manual operation:** See ["Time Sync."](#) on page 138

---

### CONFigure:WLAN:MIMO:OSP:ADDRes <Address>

Specifies the TCP/IP address of the switch unit to be used for automated sequential MIMO measurements. The supported unit is Rohde & Schwarz OSP 1505.3009.03 with module option 1505.5101.02

#### Parameters:

<Address>

**Manual operation:** See ["OSP IP Address"](#) on page 142

---

### CONFigure:WLAN:MIMO:OSP:MODule <ID>

Specifies the module of the switch unit to be used for automated sequential MIMO measurements. The supported unit is Rohde & Schwarz OSP 1505.3009.03 with module option 1505.5101.02

#### Parameters:

<ID>                   A11 | A12 | A13

**Manual operation:** See ["OSP Switch Bank Configuration"](#) on page 143

---

### CONFigure:WLAN:RSYNc:JOINed <State>

Configures how PPDU synchronization and tracking is performed for multiple antennas.

#### Parameters:

<State>                   ON | OFF | 1 | 0

#### **ON | 1**

RX antennas are synchronized and tracked together.

Configuring the WLAN IQ measurement (modulation accuracy, flatness and tolerance)

**OFF | 0**

RX antennas are synchronized and tracked separately.

\*RST: 0

**Manual operation:** See "[Joined RX Sync and Tracking](#)" on page 140

## 10.5.5 Synchronization and OFDM demodulation

[\[SENSe:\]DEMod:FFT:OFFSet](#)..... 293

[\[SENSe:\]DEMod:TXARea](#)..... 293

---

### **[SENSe:]DEMod:FFT:OFFSet** <Mode>

Specifies the start offset of the FFT for OFDM demodulation (not for the "FFT Spectrum" display).

**Parameters:**

<Mode> AUTO | GICenter | PEAK

**AUTO**

The FFT start offset is automatically chosen to minimize the intersymbol interference.

**GICenter**

Guard Interval Center: The FFT start offset is placed to the center of the guard interval.

**PEAK**

The peak of the fine timing metric is used to determine the FFT start offset.

\*RST: AUTO

**Manual operation:** See "[FFT Start Offset](#)" on page 146

---

### **[SENSe:]DEMod:TXARea** <State>

If enabled, the R&S FSW WLAN application initially performs a coarse burst search on the input signal in which increases in the power vs time trace are detected. Further time-consuming processing is then only performed where bursts are assumed. This improves the measurement speed for signals with low duty cycle rates.

However, for signals in which the PPDU power levels differ significantly, this option should be disabled as otherwise some PPDUs may not be detected.

**Parameters:**

<State> ON | OFF | 0 | 1

**ON | 1**

A coarse burst search is performed based on the power levels of the input signal.

**OFF | 0**

No pre-evaluation is performed, the entire signal is processed.

\*RST: 1

Configuring the WLAN IQ measurement (modulation accuracy, flatness and tolerance)

**Manual operation:** See "[Power Interval Search](#)" on page 145

## 10.5.6 Tracking and channel estimation

[SENSe:]DEMod:CESTimation:RANGe.....	294
[SENSe:]DEMod:INTerpolate.....	295
[SENSe:]DEMod:INTerpolate:WIENer:DSPrEad.....	295
[SENSe:]DEMod:INTerpolate:WIENer:DSPrEad:STATe.....	296
SENSe:TRACking:CROStalk.....	296
SENSe:TRACking:IQMComp.....	296
SENSe:TRACking:LEVel.....	297
SENSe:TRACking:PHASe.....	297
SENSe:TRACking:PILots.....	298
SENSe:TRACking:PREamble.....	298
SENSe:TRACking:TIME.....	299
[SENSe] (see also SENSe: commands!)	299

---

**[SENSe:]DEMod:CESTimation:RANGe** <Range>

**Parameters:**

<Range>

PRE1t | PRE2t | PFTRacking | PUTRacking

**PRE1t**

The channel estimation is performed using the preamble of the HE/EHT-LTF as required in the standard.

**PRE2t**

The channel estimation is performed using the preamble of both training fields.

**PFTRacking**

The channel estimation is performed using the preamble and the payload. The EVM results can be calculated more accurately.

(Note: this setting corresponds to the

[SENSe:]DEMod:CESTimation 1 command in previous firm-ware versions.)

**PUTRacking**

The channel estimation is performed using the preamble and the payload. The EVM results can be calculated more accurately.

The user-defined tracking settings are applied to the payload symbols used for payload channel estimation (see [Chapter 10.5.6, "Tracking and channel estimation"](#), on page 294).

Configuring the WLAN IQ measurement (modulation accuracy, flatness and tolerance)

**Example:** Channel estimation is performed using the preamble and payload, where only phase tracking is applied to the payload symbols used for payload channel estimation. The pilot sequence detected in the signal is used for tracking.

```
SENS:TRAC:PHAS ON
SENS:TRAC:PIL DET
SENS:TRAC:TIME OFF
SENS:TRAC:LEV OFF
[SENSe:]DEMod:CESTimation:RANGe PUTRacking
```

**Manual operation:** See "[Channel Estimation Range](#)" on page 147

**[SENSe:]DEMod:INTerpolate** <Interpolation>

**Parameters:**

<Interpolation> WIENer | LINear

**WIENer**

The unused subcarriers of the channel estimation fields (1xHE-LTF, 2xHE-LTF) are determined by Wiener interpolation. The estimated channel is smoothed. The Wiener interpolation overwrites the used subcarrier sampling points.

In case all subcarriers are used (4xHE-LTF), sampling points for all subcarriers are available. The channel is smoothed.

**LINear**

The unused subcarriers of the channel estimation fields (1xHE-LTF, 2xHE-LTF) are determined by linear interpolation. Linear interpolation preserves the used subcarrier sampling points.

In case all subcarriers are used (4xHE-LTF), the available sampling points for all subcarriers are preserved, and no interpolation is applied.

\*RST: WIENer

**Example:** DEM:INT:LIN

**Manual operation:** See "[Interpolation](#)" on page 148

**[SENSe:]DEMod:INTerpolate:WIENer:DSPrad** <Value>

Defines the value relative to the DFT period that is used for the Wiener filter design. Decrease this setting to finetune the EVM result if there is negligible delay spread, for example for a wired connection.

This setting is only available for `[SENSe:]DEMod:INTerpolate:WIENer:DSPrad:STATe` OFF.

**Parameters:**

<Value> Range: 0.0001 to 0.5

**Example:**

```
DEM:INT:WIEN
DEM:INT:WIEN:STAT OFF
DEM:INT:WIEN:DSPr 0.05
```

Configuring the WLAN IQ measurement (modulation accuracy, flatness and tolerance)

**Manual operation:** See "[Wiener Relative Delay Spread](#)" on page 149

---

**[SENSe:]DEMod:INTerpolate:WIENer:DSPRead:STATE <State>**

Defines whether the Wiener relative delay spread is disabled or defined manually.

Is only available for standards **IEEE 802.11ax, be** and only for [\[SENSe:\]DEMod:INTerpolateWiener](#).

**Parameters:**

<State>                   OFF | MANual

**OFF**  
No delay spread is used.

**MAN**  
The value is determined manually, using [\[SENSe:\]DEMod:INTerpolate:WIENer:DSPRead](#) on page 295.

\*RST:           OFF

**Example:**

```
DEM:INT:WIEN
DEM:INT:WIEN:DSPR:STAT MAN
DEM:INT:WIEN:DSPR 0.05
```

**Manual operation:** See "[Wiener Relative Delay Spread](#)" on page 149

---

**SENSe:TRACking:CROStalk <State>**

Activates or deactivates the compensation for crosstalk between MIMO carriers.

Is only available for standard **IEEE 802.11ac or n (MIMO)**.

**Parameters:**

<State>                   ON | OFF | 1 | 0

\*RST:           0

**Example:**

```
SENS:TRAC:CROS ON
```

**Manual operation:** See "[Compensate Crosstalk\(MIMO only\)](#)" on page 151

---

**SENSe:TRACking:IQMComp <State>**

Activates or deactivates the compensation for I/Q mismatch (gain imbalance, quadrature offset, I/Q skew, see [Chapter 3.1.1.5, "I/Q mismatch"](#), on page 22).

This setting is **not available for standards IEEE 802.11b and g (DSSS)**.

**Parameters:**

<State>                   **ON | 1 | AVGScarrier**  
The I/Q mismatches (gain imbalance, quadrature offset, time skew) are averaged over the subcarriers. The scalar results are applied to the subcarriers and used for I/Q mismatch compensation.



Configuring the WLAN IQ measurement (modulation accuracy, flatness and tolerance)

**PERScarrier**

The individual I/Q mismatches per subcarrier are used for I/Q mismatch compensation.

**OFF | 0**

Compensation is not applied; this setting is required for measurements strictly according to the IEEE 802.11-2012, IEEE 802.11ac-2013 WLAN standard

\*RST: 0

**Example:**

```
SENS:TRAC:IQMC ON
//Applies I/Q mismatch based on average over
subcarriers.
```

**Manual operation:** See "[I/Q Mismatch Compensation](#)" on page 150

**SENSe:TRACking:LEVel <State>**

Activates or deactivates the compensation for level variations within a single PPDU. If activated, the measurement results are compensated for level error on a per-symbol basis.

**Parameters:**

<State> ON | OFF | 1 | 0  
\*RST: 0

**Example:**

```
SENS:TRAC:LEV ON
```

**Manual operation:** See "[Level Error \(Gain\) Tracking](#)" on page 150

**SENSe:TRACking:PHASe <State>**

Activates or deactivates the compensation for phase drifts.

**Parameters:**

<State> ON | OFF | 0 | 1

**OFF | 0**

Switches the function off

**ON | 1**

Switches the function on. The measurement results are compensated for phase drifts on a per-symbol basis.

\*RST: 1

**Example:**

```
SENS:TRAC:PHAS ON
```

**Manual operation:** See "[Phase Tracking](#)" on page 149

Configuring the WLAN IQ measurement (modulation accuracy, flatness and tolerance)

---

### SENSe:TRACking:PILots <Mode>

In case tracking is used, the used pilot sequence has an effect on the measurement results.

#### Parameters:

<Mode>                      STANdard | DETected

#### STANdard

The pilot sequence is determined according to the corresponding WLAN standard. In case the pilot generation algorithm of the device under test (DUT) has a problem, the non-standard-conform pilot sequence might affect the measurement results, or the R&S FSW WLAN application might not synchronize at all onto the signal generated by the DUT.

#### DETected

The pilot sequence detected in the WLAN signal to be analyzed is used by the R&S FSW WLAN application. In case the pilot generation algorithm of the device under test (DUT) has a problem, the non-standard-conform pilot sequence will not affect the measurement results. In case the pilot sequence generated by the DUT is correct, it is recommended that you use the "According to Standard" setting because it generates more accurate measurement results.

\*RST:                      STANdard

**Example:**                      SENS:TRAC:PIL DET

**Manual operation:**    See "[Pilots for Tracking](#)" on page 150

---

### SENSe:TRACking:PREAmble <Mode>

Defines which results are used for preamble tracking prior to the preamble channel estimation.

#### Parameters:

<Mode>

#### PAYLoad

Payload tracking results are used for preamble tracking prior to the preamble channel estimation

#### VHT

(V)HT-LTF Symbols and Payload tracking results are used for preamble tracking prior to the preamble channel estimation.

\*RST:                      PAYLoad

**Example:**                      SENS:TRAC:PRE VHT

**Manual operation:**    See "[Preamble Channel Estimation](#)" on page 149

Configuring the WLAN IQ measurement (modulation accuracy, flatness and tolerance)

---

### SENSe:TRACking:TIME <State>

Activates or deactivates the compensation for timing drift.

#### Parameters:

<State>

ON | OFF | 0 | 1

**OFF | 0**

Switches the function off

**ON | 1**

Switches the function on. The measurement results are compensated for timing error on a per-symbol basis.

\*RST: 0

**Example:** SENS:TRAC:TIME ON

**Manual operation:** See "[Timing Error Tracking](#)" on page 149

---

[SENSe] (see also SENSE: commands!)

## 10.5.7 Demodulation

The demodulation settings define which PPDU's are to be analyzed, thus they define a *logical filter*.

The available demodulation settings vary depending on the selected digital standard (see [CONFigure:STANdard](#) on page 236).

Manual configuration is described in [Chapter 5.3.8, "Demodulation"](#), on page 151.

- [Common demodulation commands](#)..... 299
- [PPDU configuration](#)..... 311
- [MIMO demodulation commands](#)..... 323

### 10.5.7.1 Common demodulation commands

The following commands are required for demodulation for several or all WLAN 802.11 standards.

<a href="#">CONFigure:WLAN:EXTension:AUTO:TYPE</a> .....	300
<a href="#">CONFigure:WLAN:GTIme:AUTO</a> .....	300
<a href="#">CONFigure:WLAN:GTIme:SElect</a> .....	301
<a href="#">CONFigure:WLAN:STBC:AUTO:TYPE</a> .....	301
<a href="#">[SENSe:]BANDwidth:CHANnel:AUTO</a> .....	301
<a href="#">[SENSe:]BANDwidth:CHANnel:AUTO:TYPE</a> .....	302
<a href="#">[SENSe:]DEMod:DATA</a> .....	303
<a href="#">[SENSe:]DEMod:FORMat:BANalyze</a> .....	304
<a href="#">[SENSe:]DEMod:FORMat:BANalyze:BTYPe</a> .....	306
<a href="#">[SENSe:]DEMod:FORMat:BANalyze:BTYPe:AUTO:TYPE</a> .....	307
<a href="#">[SENSe:]DEMod:FORMat[:BContent]:AUTO</a> .....	308
<a href="#">[SENSe:]DEMod:FORMat:BTRate</a> .....	309

Configuring the WLAN IQ measurement (modulation accuracy, flatness and tolerance)

[SENSe:]DEMod:FORMat:MCsIndex.....	309
[SENSe:]DEMod:FORMat:MCsIndex:MODE.....	309
[SENSe:]DEMod:FORMat:NSTsIndex.....	310
[SENSe:]DEMod:FORMat:NSTsIndex:MODE.....	310
[SENSe:]DEMod:FORMat:SIGSymbol.....	311

---

### CONFigure:WLAN:EXTension:AUTO:TYPE <PPDUType>

Defines the PPDU's taking part in the analysis according to the Ness (Extension Spatial Streams) field content (for **IEEE 802.11n** standard only).

#### Parameters:

<PPDUType>

FBURst | ALL | M0 | M1 | M2 | M3 | D0 | D1 | D2 | D3

The first PPDU is analyzed and subsequent PPDU's are analyzed only if they match

#### FBURst

The Ness field contents of the first PPDU is detected and subsequent PPDU's are analyzed only if they have the same Ness field contents (corresponds to "Auto, same type as first PPDU")

#### ALL

All recognized PPDU's are analyzed according to their individual Ness field contents (corresponds to "Auto, individually for each PPDU")

#### M0 | M1 | M2 | M3

Only PPDU's with the specified Ness value are analyzed.

#### D0 | D1 | D2 | D3

All PPDU's are analyzed assuming the specified Ness value.

\*RST: FBURst

#### Example:

CONF:WLAN:EXT:AUTO:TYPE M0

**Manual operation:** See "[Extension Spatial Streams \(sounding\)](#)" on page 181

---

### CONFigure:WLAN:GTIme:AUTO <State>

This remote control command specifies whether the guard time of the input signal is automatically detected or specified manually (**IEEE 802.11n or ac** only).

#### Parameters:

<State>

ON | 1

The guard time is detected automatically according to [CONFigure:WLAN:GTIme:AUTO:TYPE](#) on page 437.

OFF | 0

The guard time is defined by the [CONFigure:WLAN:GTIme:SElect](#) command.

\*RST: 1

**Manual operation:** See "[Guard Interval Length](#)" on page 154  
 See "[Guard Interval \(GI\) + HE-LTF Size](#)" on page 166  
 See "[Guard Interval \(GI\) + EHT-LTF Size](#)" on page 174

Configuring the WLAN IQ measurement (modulation accuracy, flatness and tolerance)

---

### CONFigure:WLAN:GTIMe:SElect <GuardTime>

This remote control command specifies the guard time the PPDU's in the **IEEE 802.11n** or **ac** input signal should have. If the guard time is specified to be detected from the input signal using the `CONFigure:WLAN:GTIMe:AUTO` command then this command is query only and allows the detected guard time to be obtained.

#### Parameters:

<GuardTime>            SHORT | NORMAl

**SHORT**  
Only the PPDU's with short guard interval are analyzed.

**NORMAl**  
Only the PPDU's with long guard interval are analyzed.  
("Long" in manual operation)

\*RST:            NORMAl

**Example:**            CONF:WLAN:GTIM:SEL SHOR

**Manual operation:** See ["Guard Interval Length"](#) on page 154  
See ["Guard Interval \(GI\) + HE-LTF Size"](#) on page 166  
See ["Guard Interval \(GI\) + EHT-LTF Size"](#) on page 174

---

### CONFigure:WLAN:STBC:AUTO:TYPE <PPDUType>

This remote control command specifies which PPDU's are analyzed according to STBC streams (for **IEEE 802.11n**, **ac** standards only).

#### Parameters:

<PPDUType>            FBURst | ALL | M0 | M1 | M2 | D0 | D1 | D2

**FBURst**  
The STBC of the first PPDU is detected and subsequent PPDU's are analyzed only if they have the same STBC (corresponds to "Auto, same type as first PPDU")

**ALL**  
All recognized PPDU's are analyzed according to their individual STBC (corresponds to "Auto, individually for each PPDU")

**M0 | M1 | M2**  
Measure only if STBC field = 0 | 1 | 2  
For details see ["STBC Field"](#) on page 158

**D0 | D1 | D2**  
Demod all as STBC field = 0 | 1 | 2  
For details see ["STBC Field"](#) on page 158

**Example:**            CONF:WLAN:STBC:AUTO:TYPE M0

**Manual operation:** See ["STBC Field"](#) on page 158

---

### [SENSe:]BANDwidth:CHANnel:AUTO <State>

Defines whether the channel bandwidth to be analyzed is determined automatically.

Configuring the WLAN IQ measurement (modulation accuracy, flatness and tolerance)

Is only available for standards **IEEE 802.11a, ac, n**.

**Parameters:**

<State>                    ON | OFF | 0 | 1  
                               **OFF | 0**  
                               Switches the function off  
                               **ON | 1**  
                               Switches the function on  
                               \*RST:            1

---

**[SENSe:]BANDwidth:CHANnel:AUTO:TYPE <Bandwidth>**

This remote control command specifies the bandwidth in which the PPDU's are analyzed.

Note that channel bandwidths larger than 10 MHz require a bandwidth extension option on the FSW.

See [Chapter A, "Sample rate and maximum usable I/Q bandwidth for RF input"](#), on page 446.

**Parameters:**

<Bandwidth>                FBURst | MB2\_5 | MB5 | MB10 | MB20 | MB40 | MB80 | MB160 |  
                                   MB320 | DB2\_5 | DB5 | DB10 | DB20 | DB40 | DB80 | DB160 |  
                                   DB320

**FBURSt**  
 The channel bandwidth of the first valid PPDU is detected and subsequent PPDU's are analyzed only if they have the same channel bandwidth (corresponds to "Auto, same type as first PPDU")

**MB2\_5**  
 Only PPDU's with a channel bandwidth of 2.5 MHz are analyzed (**IEEE 802.11a, p only**)

**MB5**  
 Only PPDU's with a channel bandwidth of 5 MHz are analyzed (**IEEE 802.11a, p only**)

**MB10**  
 Only PPDU's with a channel bandwidth of 10 MHz are analyzed (**IEEE 802.11a, p only**)

**MB20**  
 Only PPDU's with a channel bandwidth of 20 MHz are analyzed

**MB40**  
 Only PPDU's with a channel bandwidth of 40 MHz are analyzed (**IEEE 802.11 n, ac only**)

**MB80**  
 Only PPDU's with a channel bandwidth of 80 MHz are analyzed (**IEEE 802.11 ac only**)

Configuring the WLAN IQ measurement (modulation accuracy, flatness and tolerance)

**MB160**

Only PPDU's with a channel bandwidth of 160 MHz are analyzed  
(IEEE 802.11 ac only)

**DB2\_5**

The bandwidth indicated in the signal field of the PPDU is overwritten by a bandwidth of 2.5 MHz  
(IEEE 802.11a, p only)

**DB5**

The bandwidth indicated in the signal field of the PPDU is overwritten by a bandwidth of 5 MHz  
(IEEE 802.11a, p only)

**DB10**

The bandwidth indicated in the signal field of the PPDU is overwritten by a bandwidth of 10 MHz  
(IEEE 802.11a, p only)

**DB20**

The bandwidth indicated in the signal field of the PPDU is overwritten by a bandwidth of 20 MHz

**DB40**

The bandwidth indicated in the signal field of the PPDU is overwritten by a bandwidth of 40 MHz  
(IEEE 802.11ac, ax, n, be only)

**DB80**

The bandwidth indicated in the signal field of the PPDU is overwritten by a bandwidth of 80 MHz  
(IEEE 802.11ac, ax, n, be only)

**DB160**

The bandwidth indicated in the signal field of the PPDU is overwritten by a bandwidth of 160 MHz  
(IEEE 802.11ac, ax, n, be only)

**DB320**

The bandwidth indicated in the signal field of the PPDU is overwritten by a bandwidth of 320 MHz  
(IEEE 802.11be only)

\*RST: FBURst

**Example:**

```
SENS:BAND:CHAN:AUTO:TYPE MB20
```

**Manual operation:**

See "[Channel Bandwidth to measure \(CBW\)](#)" on page 153  
See "[Channel Bandwidth to measure \(CBW\)](#)" on page 161  
See "[Channel Bandwidth to measure \(CBW\)](#)" on page 169

---

**[SENSe:]DEMod:DATA <Mode>**

Defines when in the demodulation process the bitstream is determined and thus which results are available.

Configuring the WLAN IQ measurement (modulation accuracy, flatness and tolerance)

See also [Chapter 3.1.1.9, "BER and CWER"](#), on page 26.

**Parameters:**

<Mode> ACDSCarrier | ALBDecoder

**ACDSCarrier**

(Default:) No channel decoding is performed. Processing time is reduced, but BER and CWER results are not available.

**ALBDecoder**

Decoding is performed, providing BER and CWER results. Measurement time is increased compared to non-decoding process.

\*RST: ACDSCarrier

**Example:**

DEM:DATA ALBD

**Manual operation:** See "[Demodulation Data \(Bitstream\)](#)" on page 166

**[SENSe:]DEMod:FORMat:BANalyze <Format>**

Specifies which PSDUs are to be analyzed depending on their modulation. Only PSDUs using the selected modulation are considered in result analysis.

Note: to analyze all PPDU's that are identical to the first detected PPDU (corresponds to "Auto, same type as first PPDU"), use the command:

SENS:DEMO:FORM:BANA:BTYP:AUTO:TYPE FBUR.

To analyze all PPDU's regardless of their format and modulation (corresponds to "Auto, individually for each PPDU"), use the command:

SENS:DEMO:FORM:BANA:BTYP:AUTO:TYPE ALL.

To analyze all PPDU's using the same modulation (corresponds to "Demod all as...", use the command: SENS:DEMO:FORM:BANA:BTYP:AUTO:TYPE . . .

See [\[SENSe:\]DEMod:FORMat:BANalyze:BTYPe:AUTO:TYPE](#) on page 307.

**Parameters:**

<Format> \*RST: QAM64

**Example:**

SENS:DEMO:FORM:BAN 'BPSK6'

**Manual operation:**

See "[PPDU Format to measure](#)" on page 152

See "[PSDU Modulation to use](#)" on page 153

See "[PSDU Modulation](#)" on page 154

See "[PPDU Format to measure](#)" on page 160

See "[PPDU Format to measure](#)" on page 168

See "[PPDU Format to measure\[/\] PSDU Modulation to use](#)" on page 176

See "[PPDU Format](#)" on page 177

*Table 10-4: Modulation format parameters for IEEE 802.11a, g (OFDM), j, p standard*

SCPI parameter	Dialog parameter
BPSK6	BPSK 1/2
BPSK9	BPSK 3/4



Configuring the WLAN IQ measurement (modulation accuracy, flatness and tolerance)

SCPI parameter	Dialog parameter
QPSK12	QPSK 1/2
QPSK18	QPSK 3/4
QAM1624	16-QAM 1/2
QAM1636	16-QAM 3/4
QAM6448	64-QAM 2/3
QAM6454	64-QAM 3/4

**Table 10-5: Modulation format parameters for IEEE 802.11b or g (DSSS) standard**

SCPI parameter	Dialog parameter
CCK11	Complementary Code Keying at 11 Mbps
CCK55	Complementary Code Keying at 5.5 Mbps
DBPSK1	Differential BI-Phase shift keying
DQPSK2	Differential Quadrature phase shift keying
PBCC11	PBCC at 11 Mbps
PBCC22	PBCC at 11 Mbps
PBCC55	PBCC at 5.5 Mbps

**Table 10-6: Modulation format parameters for IEEE 802.11n standard**

SCPI parameter	Dialog parameter
BPSK65	BI-Phase shift keying at 6.5 Mbps
BPSK72	BI-Phase shift keying at 7.2 Mbps
QAM1626	Quadrature Amplitude Modulation at 26 Mbps
QAM1639	Quadrature Amplitude Modulation at 39 Mbps
QAM16289	Quadrature Amplitude Modulation at 28.9 Mbps
QAM16433	Quadrature Amplitude Modulation at 43.3 Mbps
QAM6452	Quadrature Amplitude Modulation at 52 Mbps
QAM6465	Quadrature Amplitude Modulation at 65 Mbps
QAM16289	Quadrature Amplitude Modulation at 28.9 Mbps
QAM16433	Quadrature Amplitude Modulation at 43.3 Mbps
QAM64578	Quadrature Amplitude Modulation at 57.8 Mbps
QAM64585	Quadrature Amplitude Modulation at 58.5 Mbps
QAM64722	Quadrature Amplitude Modulation at 72.2 Mbps
QPSK13	Quadrature phase shift keying at 13 Mbps
QPSK144	Quadrature phase shift keying at 14.4 Mbps

Configuring the WLAN IQ measurement (modulation accuracy, flatness and tolerance)

SCPI parameter	Dialog parameter
QPSK195	Quadrature phase shift keying at 19.5 Mbps
QPSK217	Quadrature phase shift keying at 21.7 Mbps

**[SENSe:]DEMod:FORMat:BANalyze:BTYPe <PPDUType>**

This remote control command specifies the type of PPDU to be analyzed. Only PPDU of the specified type take part in measurement analysis.

**Parameters:**

<PPDUType>

**'LONG'**

Only long (DSSS) PLCP PPDU are analyzed.  
Available for IEEE 802.11b, g.

**'SHORT'**

Only short (DSSS) PLCP PPDU are analyzed.  
Available for IEEE 802.11b, g.

**'OFDM'**

Only OFDM PPDU are analyzed.  
Available for IEEE 802.11g.

**'MM20'**

IEEE 802.11n, Mixed Mode, 20 MHz sample rate  
Note that this setting is maintained for compatibility reasons only. Use the specified commands for new remote control programs (see [\[SENSe:\]DEMod:FORMat:BANalyze:BTYPe:AUTO:TYPE](#) on page 307 and [\[SENSe:\]BANDwidth:CHANnel:AUTO:TYPE](#) on page 302).

For new programs use:

```
[SENSe:]DEMod:FORMat:BANalyze:BTYPe:AUTO:TYPE
MMIX
```

```
[SENSe:]BANDwidth:CHANnel:AUTO:TYPE MB20
```

**'GFM20'**

IEEE 802.11n Green Field Mode, 20 MHz sample rate  
Note that this setting is maintained for compatibility reasons only. Use the specified commands for new remote control programs (see [\[SENSe:\]DEMod:FORMat:BANalyze:BTYPe:AUTO:TYPE](#) on page 307 and [\[SENSe:\]BANDwidth:CHANnel:AUTO:TYPE](#) on page 302).

For new programs use:

```
[SENSe:]DEMod:FORMat:BANalyze:BTYPe:AUTO:TYPE
MGRF
```

```
[SENSe:]BANDwidth:CHANnel:AUTO:TYPE MB20
```

**Example:**

Select IEEE 802.11g OFDM standard:

```
CONF:STAN 4
```

```
SENS:DEM:FORM:BAN:BTYP 'OFDM'
```

**Manual operation:**

See "[PPDU Format](#)" on page 177

Configuring the WLAN IQ measurement (modulation accuracy, flatness and tolerance)

---

**[SENSe:]DEMod:FORMat:BANalyze:BTYPe:AUTO:TYPE** <PPDUFormat>

This remote control command specifies how signals are analyzed.

**Parameters:**

<PPDUFormat>

**FBURst**

The format of the first valid PPDU is detected and subsequent PDUs are analyzed only if they have the same format (corresponds to "Auto, same type as first PPDU")

**ALL**

All PDUs are analyzed regardless of their format (corresponds to "Auto, individually for each PPDU")

**MNHT**

Only PDUs with format "Non-HT" are analyzed

**IEEE 802.11a, g (OFDM), p**

**DNHT**

All PDUs are assumed to have the PDU format "Non-HT"

**IEEE 802.11a, g (OFDM), p**

**MMIX**

Only PDUs with format "HT-MF" (Mixed) are analyzed

**(IEEE 802.11 n)**

**MGRF**

Only PDUs with format "HT-GF" (Greenfield) are analyzed

**(IEEE 802.11 n)**

**DMIX**

All PDUs are assumed to have the PDU format "HT-MF"

**(IEEE 802.11 n)**

**DGRF**

All PDUs are assumed to have the PDU format "HT-GF"

**(IEEE 802.11 n)**

**MVHT**

Only PDUs with format "VHT" are analyzed

**(IEEE 802.11 ac)**

**DVHT**

All PDUs are assumed to have the PDU format "VHT"

**(IEEE 802.11 ac)**

**AIHS**

Only HE Single-User PDUs are analyzed

**(IEEE 802.11 ax)**

**AIHM**

Only HE Multi-User PDUs are analyzed

**(IEEE 802.11 ax)**

**AIES**

Only HE Extended Range PDUs are analyzed

**(IEEE 802.11 ax)**

Configuring the WLAN IQ measurement (modulation accuracy, flatness and tolerance)

**AIHT**

Only HE Trigger-based PPDU are analyzed  
(IEEE 802.11 ax)

**DHEP**

All PPDU are assumed to have HE PPDU format  
(IEEE 802.11 ax)

**FMMM**

Only PPDU with specified format are analyzed (see [SENSe: ] DEMod: FORMat: BANalyze on page 304)  
(IEEE 802.11 b, g (DSSS))

**FMMD**

All PPDU are assumed to have the specified PPDU format (see [SENSe: ] DEMod: FORMat: BANalyze on page 304)  
(IEEE 802.11 b, g (DSSS))

**DEHP**

All PPDU are assumed to have EHT PPDU format  
(IEEE 802.11 be)

**AIEM**

Only EHT MU PPDU are analyzed  
(IEEE 802.11 be)

**AIET**

Only EHT trigger-based PPDU are analyzed  
(IEEE 802.11 be)

**DEHTppdu**

All PPDU are assumed to have EHT PPDU format  
(IEEE 802.11 be)

\*RST: FBURst

**Example:**

```
SENS:DEM:FORM:BAN:BTYP:AUTO:TYPE FBUR
```

**Manual operation:**

See "PPDU Format to measure" on page 152  
See "PSDU Modulation to use" on page 153  
See "PPDU Format to measure" on page 160  
See "PPDU Format to measure" on page 168  
See "PPDU Format to measure[/] PSDU Modulation to use" on page 176

---

[SENSe:]DEMod:FORMat[:BContent]:AUTO <State>

Determines whether the PPDU to be analyzed are determined automatically or by the user.

**Parameters:**

<State>

**ON | 1**

The signal field, i.e. the PLCP header field, of the first recognized PPDU is analyzed to determine the details of the PPDU. All PPDU identical to the first recognized PPDU are analyzed.

Configuring the WLAN IQ measurement (modulation accuracy, flatness and tolerance)

**OFF | 0**

Only PPDU's that match the user-defined PDU type and modulation are considered in results analysis (see [\[SENSe:\]DEMod:FORMat:BANalyze:BTYPe:AUTO:TYPE](#) on page 307 and [\[SENSe:\]DEMod:FORMat:BANalyze](#) on page 304).

**Manual operation:** See "PPDU Analysis Mode" on page 152  
See "PPDU Analysis Mode" on page 160

**[SENSe:]DEMod:FORMat:BTRate <BitRate>**

**Parameters:**  
<BitRate>

**[SENSe:]DEMod:FORMat:MCSindex <Index>**

Specifies the MCS index which controls the data rate, modulation and streams (for **IEEE 802.11n, ac** standards only, see document: IEEE 802.11n/D11.0 June 2009).

Is required if [\[SENSe:\]DEMod:FORMat:MCSindex:MODE](#) is set to MEAS or DEM.

**Parameters:**

<Index>                      Range:        0 to 11  
                                  \*RST:        1

**Example:**                    SENS:DEM:FORM:MCS:MODE MEAS  
                                  SENS:DEM:FORM:MCS 1

**Manual operation:** See "MCS Index" on page 157

**[SENSe:]DEMod:FORMat:MCSindex:MODE <Mode>**

Defines the PPDU's taking part in the analysis depending on their Modulation and Coding Scheme (MCS) index (for **IEEE 802.11n, ac** standards only).

**Parameters:**

<Mode>                        FBURst | ALL | MEASure | DEMod

**FBURst**

The MCS index of the first PDU is detected and subsequent PDU's are analyzed only if they have the same MCS index (corresponds to "Auto, same type as first PDU")

**ALL**

All recognized PDU's are analyzed according to their individual MCS indexes (corresponds to "Auto, individually for each PDU")

**MEASure**

Only PDU's with an MCS index which matches that specified by [\[SENSe:\]DEMod:FORMat:MCSindex](#) are analyzed

Configuring the WLAN IQ measurement (modulation accuracy, flatness and tolerance)

### DEMod

All PPDU's will be analyzed according to the MCS index specified by `[SENSe:]DEMod:FORMat:MCSindex`.

\*RST: FBURst

#### Example:

```
SENS:DEM:FORM:MCS:MODE MEAS
SENS:DEM:FORM:MCS 1
```

**Manual operation:** See "[MCS Index to use](#)" on page 157

### [SENSe:]DEMod:FORMat:NSTSindex <Index>

Defines the PPDU's taking part in the analysis depending on their Nsts.

Is only available for the **IEEE 802.11 ac** standard.

Is available for `DEM:FORM:NSTS:MODE MEAS` or `DEM:FORM:NSTS:MODE DEM` (see [\[SENSe:\]DEMod:FORMat:NSTSindex:MODE](#) on page 310).

#### Parameters:

<Index>

#### Example:

```
SENS:DEM:FORM:NSTS:MODE MEAS
SENS:DEM:FORM:NSTS 1
```

**Manual operation:** See "[Nsts](#)" on page 158

### [SENSe:]DEMod:FORMat:NSTSindex:MODE <Mode>

Defines the PPDU's taking part in the analysis depending on their Nsts.

Is only available for the **IEEE 802.11 ac** standard.

#### Parameters:

<Mode>

FBURst | ALL | MEASure | DEMod

#### FBURst

The Nsts of the first PPDU is detected and subsequent PPDU's are analyzed only if they have the same Nsts (corresponds to "Auto, same type as first PPDU")

#### ALL

All recognized PPDU's are analyzed according to their individual Nsts (corresponds to "Auto, individually for each PPDU")

#### MEASure

Only PPDU's with the Nsts specified by `[SENSe:]DEMod:FORMat:NSTSindex` are analyzed

#### DEMod

The "Nsts" index specified by `[SENSe:]DEMod:FORMat:NSTSindex` is used for all PPDU's.

\*RST: FBURst

#### Example:

```
SENS:DEM:FORM:NSTS:MODE MEAS
SENS:DEM:FORM:NSTS 1
```

Configuring the WLAN IQ measurement (modulation accuracy, flatness and tolerance)

**Manual operation:** See "Nsts to use" on page 157

---

### [SENSe:]DEMod:FORMat:SIGSymbol <State>

Activates and deactivates signal symbol field decoding.

For IEEE 802.11b this command can only be queried as the decoding of the signal field is always performed for this standard.

#### Parameters:

<State>

**OFF | 0**

Deactivates signal symbol field decoding. All PPDU are assumed to have the specified PPDU format / PSDU modulation, regardless of the actual format or modulation.

**ON | 1**

If activated, the signal symbol field of the PPDU is analyzed to determine the details of the PPDU. Only PPDU which match the PPDU type/ PSDU modulation defined by [SENSe:]DEMod:FORMat:BANalyze and [SENSe:]DEMod:FORMat:BANalyze:BTYPe are considered in results analysis.

\*RST: 0

#### Example:

DEM:FORM:SIGS ON

**Manual operation:** See "PPDU Format to measure[/] PSDU Modulation to use" on page 176

## 10.5.7.2 PPDU configuration

The following commands are required to configure PPDU resource units (IEEE 802.11ax, be standards).

CONFigure:WLAN:RUConfig:COUNT:ACTive.....	312
CONFigure:WLAN:RUConfig:COUNT:HIGHest?.....	312
CONFigure:WLAN:RUConfig:EHTPPdu.....	312
CONFigure:WLAN:RUConfig:HEPPdu.....	313
CONFigure:WLAN:RUConfig:NHELf.....	313
CONFigure:WLAN:RUConfig:REFResh.....	313
CONFigure:WLAN:RUConfig:SEGMENT<seg>:CHANnel<ch>:RULocation<cf>:COUNT: HIGHest?.....	314
CONFigure:WLAN:RUConfig:SEGMENT<seg>:CHANnel<ch>:RULocation<cf>:MRUindex.....	314
CONFigure:WLAN:RUConfig:SEGMENT<seg>:CHANnel<ch>:RULocation<cf>:RU26index.....	315
CONFigure:WLAN:RUConfig:SEGMENT<seg>:CHANnel<ch>:RULocation<cf>:RUIndex.....	315
CONFigure:WLAN:RUConfig:SEGMENT<seg>:CHANnel<ch>:RULocation<cf>:RUSize.....	316
CONFigure:WLAN:RUConfig:SEGMENT<seg>:CHANnel<ch>:RULocation<cf>:RUTSix.....	317
CONFigure:WLAN:RUConfig:SEGMENT<seg>:CHANnel<ch>:RULocation<cf>:USER: COUNT?.....	317
CONFigure:WLAN:RUConfig:SEGMENT<seg>:CHANnel<ch>:RULocation<cf>: USER<mu>:CODing.....	318
CONFigure:WLAN:RUConfig:SEGMENT<seg>:CHANnel<ch>:RULocation<cf>: USER<mu>:DCM.....	319

Configuring the WLAN IQ measurement (modulation accuracy, flatness and tolerance)

CONFigure:WLAN:RUConfig:SEGMent<seg>:CHANnel<ch>:RULocation<cf>: USER<mu>:DElete.....	319
CONFigure:WLAN:RUConfig:SEGMent<seg>:CHANnel<ch>:RULocation<cf>: USER<mu>:INSert.....	320
CONFigure:WLAN:RUConfig:SEGMent<seg>:CHANnel<ch>:RULocation<cf>: USER<mu>:MCSindex.....	321
CONFigure:WLAN:RUConfig:SEGMent<seg>:CHANnel<ch>:RULocation<cf>: USER<mu>:NSTS.....	322
CONFigure:WLAN:RUConfig:SEGMent<seg>:CHANnel<ch>:RULocation<cf>: USER<mu>:TBEamforming.....	322

---

### CONFigure:WLAN:RUConfig:COUNT:ACTive <ActiveCount>...

Determines the RUs for which the results are evaluated.

#### Parameters:

<ActiveCount> integer  
Comma-separated list of resource unit numbers from the PPDU configuration table.

#### Example:

CONF:WLAN:RUC:COUN:ACT 1,5,7

Displays the results for the resource units in rows 1, 5, and 7 in the PPDU configuration table.

**Manual operation:** See "[RU number](#)" on page 171

---

### CONFigure:WLAN:RUConfig:COUNT:HIGHest?

Queries the highest configured RU index in the entire signal.

#### Return values:

<MaxIndex> Range: 1 to 9

#### Example:

CONF:WLAN:RUC:COUN:HIGH?

#### Usage:

Query only

---

### CONFigure:WLAN:RUConfig:EHTPpdu <RUConfig\_PPDU>

Defines the format of the EHT PPDU. This format determines which other PPDU settings are available.

#### Parameters:

<RUConfig\_PPDU> **MU**  
High-efficiency multi-user PPDU for downlink to multiple users at the same time  
\*RST: MU

**Manual operation:** See "[EHT PPDU Format](#)" on page 171



Configuring the WLAN IQ measurement (modulation accuracy, flatness and tolerance)

---

### CONFigure:WLAN:RUConfig:HEPPdu <RUConfig\_PPDU>

Defines the format of the HE PPDU. This format determines which other PPDU settings are available.

#### Parameters:

<RUConfig\_PPDU> SU | MU | TRIG | ESU

#### SU

High-efficiency single user PPDU for uplink and downlink

#### MU

High-efficiency multi-user PPDU for downlink to multiple users at the same time

#### TRIG

High-efficiency trigger-based PPDU for uplink from multiple users at the same time

#### ESU

High-efficiency single-user PPDU for an extended range

\*RST: SU

**Manual operation:** See "[HE PPDU Format](#)" on page 162

---

### CONFigure:WLAN:RUConfig:NHELtf <RUConfig\_N\_HE\_LTF>

Defines the length of the high-efficiency long training field (for **trigger-based uplink PPDUs only**). For more information see "[HE Trigger-based PPDUs](#)" on page 91.

#### Parameters:

<RUConfig\_N\_HE\_LTF> AUTO | STA | S1 | S2 | S4 | S6 | S8

#### AUTO

The application determines the length automatically.

#### STA

The station configuration defines the used length.

#### S1 | S2 | S4 | S6 | S8

The LTF of the PPDUs have a fixed length (1 / 2 / 4 / 6 / 8 symbols).

\*RST: STA

**Manual operation:** See "[N<sub>HE-LTF</sub>](#)" on page 163

See "[N<sub>EHT-LTF</sub>](#)" on page 171

---

### CONFigure:WLAN:RUConfig:REFresh

Updates the result displays for the currently selected RUs in the PPDU configuration table.

#### Example:

CONF:WLAN:RUC:REFR

#### Usage:

Event

**Manual operation:** See "[Refresh](#)" on page 165

Configuring the WLAN IQ measurement (modulation accuracy, flatness and tolerance)

---

**CONFigure:WLAN:RUConfig:SEGment<seg>:CHANnel<ch>:RULocation<cf>:  
COUNT:HIGHEST?**

Queries the highest configured RU index in the specified RU allocation table.

**Suffix:**

<seg>	1   2   3   4 80-MHz-segment to be configured Segment 1: first 80 MHz of the channel Segment 2: next 80 MHz of the channel (for <b>160 MHz</b> channels and <b>MU-PPDU (DL)</b> only) Segment 3 + 4: only for <b>320 MHz</b> channels and <b>EHT MU-PPDU (DL)</b>
<ch>	1 to 4 20-MHz-subchannel (=242 subcarriers) that RU allocation applies to
<cf>	1..n irrelevant

**Return values:**

<MaxIndex> Range: 1 to 9

**Usage:** Query only

**Manual operation:** See "[RU Index](#)" on page 163  
See "[RU Index](#)" on page 172

---

**CONFigure:WLAN:RUConfig:SEGment<seg>:CHANnel<ch>:RULocation<cf>:  
MRUindex <MRUInd>**

Sets or queries the index of the subcarrier and resource allocation for multiple RUs (MRU) as defined by the 802.11be standard. This index determines the position of the ignored subcarriers and used RUs within the spectrum.

**Suffix:**

<seg>	1   2   3   4 80-MHz-segment to be configured Segment 1: first 80 MHz of the channel Segment 2: next 80 MHz of the channel (for <b>160 MHz</b> channels and <b>MU-PPDU (DL)</b> only) Segment 3 + 4: only for <b>320 MHz</b> channels and <b>EHT MU-PPDU (DL)</b>
<ch>	1 to 4 20-MHz-subchannel (=242 subcarriers) that RU allocation applies to
<cf>	1 to 9 Index of the entry in the RU allocation table

Configuring the WLAN IQ measurement (modulation accuracy, flatness and tolerance)

**Parameters:**

<MRUInd> integer  
Range: 1 to 12

**Manual operation:** See "MRU Index" on page 172

**CONFIGure:WLAN:RUConfig:SEGment<seg>:CHANnel<ch>:RULocation<cf>:  
RU26index <Index>**

Sets or queries the index of the resource unit based on 26-subcarrier units.

**Suffix:**

<seg> 1 | 2 | 3 | 4  
80-MHz-segment to be configured  
Segment 1: first 80 MHz of the channel  
Segment 2: next 80 MHz of the channel (for **160 MHz** channels and **MU-PPDU (DL)** only)  
Segment 3 + 4: only for **320 MHz** channels and **EHT MU-PPDU (DL)**

<ch> 1 to 4  
20-MHz-subchannel (=242 subcarriers) that RU allocation applies to

<cf> 1 to 9  
Index of the entry in the RU allocation table

**Parameters:**

<Index> integer  
Range: 1 to 143

**Manual operation:** See "RU26 Index" on page 163  
See "RU26 Index" on page 172

**CONFIGure:WLAN:RUConfig:SEGment<seg>:CHANnel<ch>:RULocation<cf>:  
RUIndex <Index>**

Sets or queries the index of the resource unit as defined by the IEEE 802.11ax, be standard (based on resource units of the specified RU size, see [CONFIGure:WLAN:RUConfig:SEGment<seg>:CHANnel<ch>:RULocation<cf>:RUSize](#)). This value determines the position of the resource unit within the channel.

Note that you can specify any possible RU index value for the entire channel, regardless of the specified segment and subchannel.

To determine the highest allocated RU index for a specific segment and subchannel, use [CONFIGure:WLAN:RUConfig:SEGment<seg>:CHANnel<ch>:RULocation<cf>:COUNT:HIGHEST?](#) on page 314. To determine the highest allocated RU index for the entire channel, see [CONFIGure:WLAN:RUConfig:COUNT:HIGHEST?](#) on page 312.

Configuring the WLAN IQ measurement (modulation accuracy, flatness and tolerance)

**Suffix:**

<seg> 1 | 2 | 3 | 4  
80-MHz-segment to be configured  
Segment 1: first 80 MHz of the channel  
Segment 2: next 80 MHz of the channel (for **160 MHz** channels and **MU-PPDU (DL)** only)  
Segment 3 + 4: only for **320 MHz** channels and **EHT MU-PPDU (DL)**

<ch> 1 to 4  
20-MHz-subchannel (=242 subcarriers) that RU allocation applies to

<cf> 1 to 9  
Index of the entry in the RU allocation table

**Parameters:**

<Index> integer  
RU index  
Range: 1 to 144

**Example:** CONFigure:WLAN:RUConfig:SEGment1:CHANnel1:RULocation2:RUIndex 2

**Manual operation:** See "[RU Index](#)" on page 172

**CONFigure:WLAN:RUConfig:SEGment<seg>:CHANnel<ch>:RULocation<cf>:RUSize <RUSize>**

Defines the size of the individual resource unit (= number of subcarriers or tones) for a single transmission package.

**Suffix:**

<seg> 1 | 2 | 3 | 4  
80-MHz-segment to be configured  
Segment 1: first 80 MHz of the channel  
Segment 2: next 80 MHz of the channel (for **160 MHz** channels and **MU-PPDU (DL)** only)  
Segment 3 + 4: only for **320 MHz** channels and **EHT MU-PPDU (DL)**

<ch> 1 to 4  
20-MHz-subchannel (=242 subcarriers) that RU allocation applies to

<cf> 1 to 9  
Index of the entry in the RU allocation table

**Parameters:**

<RUSize> SU | S0 | S26 | S52 | S106 | S242 | S484 | S996 | S2X996 | S4X996 | S52S26 | S106s26 | S484s242 | S996s484 | S996s484s242 | S2X996s484 | S3X996 | S3X996s484

Configuring the WLAN IQ measurement (modulation accuracy, flatness and tolerance)

**Example:**           CONFigure:WLAN:RUConfig:SEGMENT1:CHANnel1:  
                          RULocation2:RUSize?  
                          //Result: S106

**Manual operation:** See "RU Size" on page 164  
                          See "RU Size" on page 172

**CONFigure:WLAN:RUConfig:SEGMENT<seg>:CHANnel<ch>:RULocation<cf>:  
                          RUTSix <Index>**

**Suffix:**

<seg>                   1 | 2 | 3 | 4  
                          80-MHz-segment to be configured  
                          Segment 1: first 80 MHz of the channel  
                          Segment 2: next 80 MHz of the channel (for **160 MHz** channels  
                          and **MU-PPDU (DL)** only)  
                          Segment 3 + 4: only for **320 MHz** channels and **EHT MU-PPDU  
(DL)**

<ch>                    1 to 4  
                          20-MHz-subchannel (=242 subcarriers) that RU allocation  
                          applies to

<cf>                    1 to 9  
                          Index of the entry in the RU allocation table

**Parameters:**

<Index>

**CONFigure:WLAN:RUConfig:SEGMENT<seg>:CHANnel<ch>:RULocation<cf>:  
                          USER:COUNT?**

Queries the number of users configured for the specified RU.

**Suffix:**

<seg>                   1 | 2 | 3 | 4  
                          80-MHz-segment to be configured  
                          Segment 1: first 80 MHz of the channel  
                          Segment 2: next 80 MHz of the channel (for **160 MHz** channels  
                          and **MU-PPDU (DL)** only)  
                          Segment 3 + 4: only for **320 MHz** channels and **EHT MU-PPDU  
(DL)**

<ch>                    1 to 4  
                          20-MHz-subchannel (=242 subcarriers) that RU allocation  
                          applies to

<cf>                    1 to 9  
                          Index of the entry in the RU allocation table

**Return values:**

<MaxUsers>            Range:     1 to 8

Configuring the WLAN IQ measurement (modulation accuracy, flatness and tolerance)

**Example:**

```

CONFigure:WLAN:RUConfig:SEGMENT1:CHANNEL1:
RULocation1:USER:INSert
Inserts a new user (User 1) under the default User 0 for the RU
1.
:CONFigure:WLAN:RUConfig:SEGMENT1:CHANNEL1:
RULocation1:USER:COUNT?
Queries the number of users for RU 1.
//Result: 2

```

**Usage:** Query only

**Manual operation:** See "User Index" on page 164  
See "User Index" on page 172

---

**CONFigure:WLAN:RUConfig:SEGMENT<seg>:CHANNEL<ch>:RULocation<cf>:  
USER<mu>:CODing <Type>**

The type of coding used by the PPDU

**Suffix:**

<seg>	1   2   3   4 80-MHz-segment to be configured Segment 1: first 80 MHz of the channel Segment 2: next 80 MHz of the channel (for <b>160 MHz</b> channels and <b>MU-PPDU (DL)</b> only) Segment 3 + 4: only for <b>320 MHz</b> channels and <b>EHT MU-PPDU (DL)</b>
<ch>	1 to 4 20-MHz-subchannel (=242 subcarriers) that RU allocation applies to
<cf>	1 to 9 Index of the entry in the RU allocation table
<mu>	1 to 8 User index for RU in MIMO mode

**Parameters:**

<Type>	<b>1</b> LDPC is used
	<b>0</b> BCC is used

**Example:**

```

:CONFigure:WLAN:RUConfig:SEGMENT1:CHANNEL1:
RULocation1:USER1:CODing?
//Result: 0

```

**Manual operation:** See "Coding" on page 165  
See "Coding" on page 173

Configuring the WLAN IQ measurement (modulation accuracy, flatness and tolerance)

---

**CONFigure:WLAN:RUConfig:SEGment<seg>:CHANnel<ch>:RULocation<cf>:  
USER<mu>:DCM <Type>**

Defines the use of dual carrier modulation for the specified user.

**Suffix:**

<seg>	1   2   3   4 80-MHz-segment to be configured Segment 1: first 80 MHz of the channel Segment 2: next 80 MHz of the channel (for <b>160 MHz</b> channels and <b>MU-PPDU (DL)</b> only) Segment 3 + 4: only for <b>320 MHz</b> channels and <b>EHT MU-PPDU (DL)</b>
<ch>	1 to 4 20-MHz-subchannel (=242 subcarriers) that RU allocation applies to
<cf>	1 to 9 Index of the entry in the RU allocation table
<mu>	1 to 8 User index for RU in MIMO mode

**Parameters:**

<Type>	ON   OFF   0   1 <b>OFF   0</b> DCM not used <b>ON   1</b> DCM is used *RST: 0
--------	---

**Example:** :CONFigure:WLAN:RUConfig:SEGment1:CHANnel1:  
RULocation1:USER1:DCM?  
//Result: 0

**Manual operation:** See "[DCM](#)" on page 165  
See "[DCM](#)" on page 173

---

**CONFigure:WLAN:RUConfig:SEGment<seg>:CHANnel<ch>:RULocation<cf>:  
USER<mu>:DElete**

Deletes the selected user (station) from the HE Multi-User Downlink PPDU configuration table (for **MIMO** configuration only).

**Suffix:**

<seg>	1   2   3   4 80-MHz-segment to be configured Segment 1: first 80 MHz of the channel Segment 2: next 80 MHz of the channel (for <b>160 MHz</b> channels and <b>MU-PPDU (DL)</b> only) Segment 3 + 4: only for <b>320 MHz</b> channels and <b>EHT MU-PPDU (DL)</b>
-------	---

Configuring the WLAN IQ measurement (modulation accuracy, flatness and tolerance)

<ch>	1 to 4 20-MHz-subchannel (=242 subcarriers) that RU allocation applies to
<cf>	1 to 9 Index of the entry in the RU allocation table
<mu>	1 to 8 User index for RU in MIMO mode

**Example:** `CONFigure:WLAN:RUConfig:SEGMENT1:CHANnel1:RULocation1:USER1:DELEte`  
Deletes User 1 for the RU 1.

**Usage:** Event

**Manual operation:** See "[Delete User](#)" on page 165  
See "[Delete User](#)" on page 174

### **CONFigure:WLAN:RUConfig:SEGMENT<seg>:CHANnel<ch>:RULocation<cf>:USER<mu>:INSert**

For **HE Multi-User Downlink PPDUs** that support **MIMO** only:

Adds another user (station) for the selected resource unit (RU) to the configuration table.

A maximum of 8 users can be assigned to a single resource unit in MIMO mode.

Is only available for RU sizes of at least 106 subcarriers.

**Suffix:**

<seg>	1   2   3   4 80-MHz-segment to be configured Segment 1: first 80 MHz of the channel Segment 2: next 80 MHz of the channel (for <b>160 MHz</b> channels and <b>MU-PPDU (DL)</b> only) Segment 3 + 4: only for <b>320 MHz</b> channels and <b>EHT MU-PPDU (DL)</b>
-------	---

<ch>	1 to 4 20-MHz-subchannel (=242 subcarriers) that RU allocation applies to
<cf>	1 to 9 Index of the entry in the RU allocation table
<mu>	1 to 8 User index for RU in MIMO mode

**Example:** `CONFigure:WLAN:RUConfig:SEGMENT1:CHANnel1:RULocation1:USER1:INSert`  
Inserts a new user (User 1) under the default User 0 for the RU 1.

**Usage:** Event



Configuring the WLAN IQ measurement (modulation accuracy, flatness and tolerance)

**Manual operation:** See "Insert User" on page 165  
See "Insert User" on page 174

---

**CONFigure:WLAN:RUConfig:SEGment<seg>:CHANnel<ch>:RULocation<cf>:  
USER<mu>:MCSindex <ModCodInd>**

Modulation and Coding Scheme (MCS) index of the PPDU

**Suffix:**

<seg> 1 | 2 | 3 | 4  
80-MHz-segment to be configured  
Segment 1: first 80 MHz of the channel  
Segment 2: next 80 MHz of the channel (for **160 MHz** channels and **MU-PPDU (DL)** only)  
Segment 3 + 4: only for **320 MHz** channels and **EHT MU-PPDU (DL)**

<ch> 1 to 4  
20-MHz-subchannel (=242 subcarriers) that RU allocation applies to

<cf> 1 to 9  
Index of the entry in the RU allocation table

<mu> 1 to 8  
User index for RU in MIMO mode

**Parameters:**

<ModCodInd> integer  
Modulation and Coding Scheme (MCS) index of the PPDU  
Range: 0 to 11

**Example:** :CONFigure:WLAN:RUConfig:SEGment1:CHANnel1:  
RULocation1:USER1:MCSindex?  
//Result: 0

**Manual operation:** See "MCS Index" on page 164  
See "MCS Index" on page 173

MCS index	Modulation and coding scheme
0	BPSK 1/2
1	QPSK 1/2
2	QPSK 3/4
3	16-QAM 1/2
4	16-QAM 3/4
5	64-QAM 2/3
6	64-QAM 3/4
7	64-QAM 5/6

Configuring the WLAN IQ measurement (modulation accuracy, flatness and tolerance)

MCS index	Modulation and coding scheme
8	256-QAM 3/4
9	256-QAM 5/6
10	1024-QAM 3/4
11	1024-QAM 5/6

---

**CONFigure:WLAN:RUConfig:SEGment<seg>:CHANnel<ch>:RULocation<cf>:  
USER<mu>:NSTS <NoStreams>**

For **MIMO** measurements only:

Number of space-time streams (NSTS) for each user

**Suffix:**

<seg>                    1 | 2 | 3 | 4  
                           80-MHz-segment to be configured  
                           Segment 1: first 80 MHz of the channel  
                           Segment 2: next 80 MHz of the channel (for **160 MHz** channels  
                           and **MU-PPDU (DL)** only)  
                           Segment 3 + 4: only for **320 MHz** channels and **EHT MU-PPDU  
(DL)**

<ch>                     1 to 4  
                           20-MHz-subchannel (=242 subcarriers) that RU allocation  
                           applies to

<cf>                     1 to 9  
                           Index of the entry in the RU allocation table

<mu>                     1 to 8  
                           User index for RU in MIMO mode

**Parameters:**

<NoStreams>            Number of space-time streams (NSTS) for each user  
                           Range:        1 to 8

**Example:**

```
CONFigure:WLAN:RUConfig:SEGment1:CHANnel1:
RULocation1:USER1:NSTS?
//Result: 1
```

**Manual operation:** See "[Nsts per User](#)" on page 164  
 See "[Nsts per User](#)" on page 173

---

**CONFigure:WLAN:RUConfig:SEGment<seg>:CHANnel<ch>:RULocation<cf>:  
USER<mu>:TBEamforming <State>**

Defines whether transmit beamforming is used.

Configuring the WLAN IQ measurement (modulation accuracy, flatness and tolerance)

**Suffix:**

<seg>	1   2   3   4 80-MHz-segment to be configured Segment 1: first 80 MHz of the channel Segment 2: next 80 MHz of the channel (for <b>160 MHz</b> channels and <b>MU-PPDU (DL)</b> only) Segment 3 + 4: only for <b>320 MHz</b> channels and <b>EHT MU-PPDU (DL)</b>
<ch>	1 to 4 20-MHz-subchannel (=242 subcarriers) that RU allocation applies to
<cf>	1 to 9 Index of the entry in the RU allocation table
<mu>	1 to 8 User index for RU in MIMO mode

**Parameters:**

<State>	ON   OFF   0   1 <b>OFF   0</b> No beamforming applied <b>ON   1</b> Beamforming is applied *RST: 0
---------	--

**Example:**                   :CONFigure:WLAN:RUConfig:SEGment1:CHANnel1:  
                              RULocation1:USER1:TBEamforming?  
                              //Result: 0

**Manual operation:** See ["TX Beamforming"](#) on page 164  
                          See ["TX Beamforming"](#) on page 173

**10.5.7.3 MIMO demodulation commands**

The following commands are required for WLAN 802.11 standards that support MIMO only.

CONFigure:WLAN:SMAPping:MODE.....	323
CONFigure:WLAN:SMAPping:NORMalise.....	324
CONFigure:WLAN:SMAPping:TX<ch>.....	324
CONFigure:WLAN:SMAPping:TX<ch>:STReam<ant>.....	324
CONFigure:WLAN:SMAPping:TX<ch>:TIMeshift.....	325

**CONFigure:WLAN:SMAPping:MODE <Mode>**

This remote control command specifies the special mapping mode.

**Parameters:**

<Mode>	DIRect   SEXPansion   USER
--------	----------------------------

Configuring the WLAN IQ measurement (modulation accuracy, flatness and tolerance)

**DIRect**

direct

**SEXPansion**

expansion

**USER**

user defined

**Manual operation:** See "[Spatial Mapping Mode](#)" on page 182

**CONFigure:WLAN:SMAPPing:NORMalise <State>**

This remote control command specifies whether an amplification of the signal power due to the spatial mapping is performed according to the matrix entries. If this command is set to ON then the spatial mapping matrix is scaled by a constant factor to obtain a passive spatial mapping matrix which does not increase the total transmitted power. If this command is set to OFF the normalization step is omitted.

**Parameters:**

<State> ON | OFF | 0 | 1  
**OFF | 0**  
 Switches the function off  
**ON | 1**  
 Switches the function on  
 \*RST: 0

**Manual operation:** See "[Power Normalise](#)" on page 183

**CONFigure:WLAN:SMAPPing:TX<ch> <STSI>...**

This remote control command specifies the mapping for all streams (real & imaginary data pairs) and timeshift for a specified antenna.

**Suffix:**

<ch> 1..n

**Parameters:**

<STSI> Imag part of the complex element of the STS-Stream

**Example:**

```
CONF:WLAN:SMAP:TX
1.0,1.0,2.0,2.0,3.0,3.0,4.0,4.0,1e-9
```

**Manual operation:** See "[User Defined Spatial Mapping](#)" on page 183

**CONFigure:WLAN:SMAPPing:TX<ch>:STReam<ant> <STSI>, <STSQ>**

This remote control command specifies the mapping for a specific stream and antenna.

**Suffix:**

<ch> 1..n

<ant> 1..n

Configuring the WLAN IQ measurement (modulation accuracy, flatness and tolerance)

**Parameters:**

<STSI>                    Imag part of the complex element of the STS-Stream

<STSQ>                    Real part of the complex element of the STS-Stream

**Example:**                    CONF:WLAN:SMAP:TX4:STR1 1.0,1.0

**Manual operation:**    See "[User Defined Spatial Mapping](#)" on page 183

**CONFigure:WLAN:SMAPping:TX<ch>:TIMeshift <TimeShift>**

This remote control command specifies the timeshift for a specific antenna.

**Suffix:**

<ch>                        1..n

**Parameters:**

<TimeShift>                Time shift (in s) for specification of user defined CSD (cyclic delay diversity) for the Spatial Mapping.

Range:                    -32 ns to 32 ns

Default unit: S

**Manual operation:**    See "[User Defined Spatial Mapping](#)" on page 183

## 10.5.8 Evaluation range

The evaluation range defines which data is evaluated in the result display.

Note that, as opposed to manual operation, the PPDU's to be analyzed can be defined either by the number of data symbols, the number of data bytes, or the measurement duration.

<a href="#">CONFigure:BURSt:PVT:AVERage</a> .....	326
<a href="#">CONFigure:BURSt:PVT:RPOWer</a> .....	326
<a href="#">CONFigure:WLAN:PAYLoad:LENGth:SRC</a> .....	326
<a href="#">CONFigure:WLAN:PVERror:MRANge</a> .....	326
<a href="#">[SENSe:]BURSt:COUNt</a> .....	327
<a href="#">[SENSe:]BURSt:COUNt:STATe</a> .....	327
<a href="#">[SENSe:]BURSt:SELEct</a> .....	327
<a href="#">[SENSe:]BURSt:SELEct:STATe</a> .....	328
<a href="#">[SENSe:]DEMod:FORMat:BANalyze:DBYTes:EQUal</a> .....	328
<a href="#">[SENSe:]DEMod:FORMat:BANalyze:DBYTes:MAX</a> .....	329
<a href="#">[SENSe:]DEMod:FORMat:BANalyze:DBYTes:MIN</a> .....	329
<a href="#">[SENSe:]DEMod:FORMat:BANalyze:DURation:EQUal</a> .....	329
<a href="#">[SENSe:]DEMod:FORMat:BANalyze:DURation:MAX</a> .....	330
<a href="#">[SENSe:]DEMod:FORMat:BANalyze:DURation:MIN</a> .....	330
<a href="#">[SENSe:]DEMod:FORMat:BANalyze:SYMBols:EQUal</a> .....	330
<a href="#">[SENSe:]DEMod:FORMat:BANalyze:SYMBols:LENGth:STATe</a> .....	331
<a href="#">[SENSe:]DEMod:FORMat:BANalyze:SYMBols:LENGth</a> .....	331
<a href="#">[SENSe:]DEMod:FORMat:BANalyze:SYMBols:MAX</a> .....	332

Configuring the WLAN IQ measurement (modulation accuracy, flatness and tolerance)

[SENSe:]DEMod:FORMat:BANalyze:SYMBOLs:MIN.....	332
[SENSe:]DEMod:FORMat:BANalyze:SYMBOLs:OFFSet.....	333
[SENSe:]SWEep:LIMit:ABORt:STATe.....	333

---

#### CONFigure:BURSt:PVT:AVERAge <Value>

Defines the number of samples used to adjust the length of the smoothing filter for PVT measurement.

Is **only** available for **IEEE 802.11b, g (DSSS)** standards.

##### Parameters:

<Value>

**Manual operation:** See "[PVT \[:\] Average Length](#)" on page 188

---

#### CONFigure:BURSt:PVT:RPOWER <Mode>

This remote control command configures the use of either mean or maximum PPDU power as a reference power for the 802.11b, g (DSSS) PVT measurement.

##### Parameters:

<Mode>                    MEAN | MAXimum

**Manual operation:** See "[PVT : Reference Power](#)" on page 188

---

#### CONFigure:WLAN:PAYLoad:LENGth:SRC <Source>

Defines which payload length is used to determine the minimum or maximum number of required data symbols (**IEEE 802.11n, ac**).

##### Parameters:

<Source>                    ESTimate | HTSignal | LSiGnal | SFieLd

##### **ESTimate**

Uses a length estimated from the input signal

##### **HTSignal**

(**IEEE811.02 n**)

Determines the length of the HT signal (from the signal field)

##### **LSiGnal**

(**IEEE811.02 ac**)

Determines the length of the L signal (from the signal field)

**Manual operation:** See "[Source of Payload Length](#)" on page 185

---

#### CONFigure:WLAN:PVERror:MRANge <Range>

This remote control command defines or queries whether the Peak Vector Error results are calculated over the complete PPDU or just over the PSDU.

Configuring the WLAN IQ measurement (modulation accuracy, flatness and tolerance)

Is supported for **802.11b** and **802.11g (DSSS)** only.

**Parameters:**

<Range> ALL | PSDU  
**ALL**  
 Peak Vector Error results are calculated over the complete PPDU  
**PSDU**  
 Peak Vector Error results are calculated over the PSDU only

**Manual operation:** See "[Peak Vector Error : Meas Range](#)" on page 189

**[SENSe:]BURSt:COUNt** <Value>

If the statistic count is enabled (see [\[SENSe:\]BURSt:COUNt:STATe](#) on page 327), the specified number of PPDU is taken into consideration for the statistical evaluation (maximally the number of PPDU detected in the current capture buffer).

If disabled, all detected PPDU in the current capture buffer are considered.

**Parameters:**

<Value> integer  
 \*RST: 1

**Example:**  
 SENS:BURS:COUN:STAT ON  
 SENS:BURS:COUN 10

**Manual operation:** See "[PPDU Statistic Count / No of PPDU to Analyze](#)" on page 185

**[SENSe:]BURSt:COUNt:STATe** <State>

If the statistic count is enabled, the specified number of PPDU is taken into consideration for the statistical evaluation (maximally the number of PPDU detected in the current capture buffer).

If disabled, all detected PPDU in the current capture buffer are considered.

**Parameters:**

<State> ON | OFF | 1 | 0  
 \*RST: 0

**Example:**  
 SENS:BURS:COUN:STAT ON  
 SENS:BURS:COUN 10

**Manual operation:** See "[PPDU Statistic Count / No of PPDU to Analyze](#)" on page 185

**[SENSe:]BURSt:SELEct** <Value>

If single PPDU analysis is enabled (see [\[SENSe:\]BURSt:SELEct:STATe](#) on page 328), the WLAN 802.11 I/Q results are based on the specified PPDU.

Configuring the WLAN IQ measurement (modulation accuracy, flatness and tolerance)

If disabled, all detected PPDU in the current capture buffer are evaluated.

**Parameters:**

<Value> integer  
\*RST: 1

**Example:**

```
SENS:BURS:SEL:STAT ON
SENS:BURS:SEL 2
```

Results are based on the PPDU number 2 only.

**Manual operation:** See "[Analyze this PPDU / PPDU to Analyze](#)" on page 184

**[SENSe:]BURSt:SElect:STATe <State>**

Defines the evaluation basis for result displays.

Note that this setting is only applicable *after* a measurement has been performed.

**Parameters:**

<State> ON | OFF | 0 | 1

**OFF | 0**

All detected PPDU in the current capture buffer are evaluated.

**ON | 1**

The WLAN 802.11 I/Q results are based on one individual PPDU only, namely the defined using [\[SENSe:\]BURSt:SElect](#) on page 327. As soon as a new measurement is started, the evaluation range is reset to all PPDU in the current capture buffer.

\*RST: 0

**Example:**

```
SENS:BURS:SEL:STAT ON
SENS:BURS:SEL 2
```

Results are based on the PPDU number 2 only.

**Manual operation:** See "[Analyze this PPDU / PPDU to Analyze](#)" on page 184

**[SENSe:]DEMod:FORMat:BANalyze:DBYTes:EQUal <State>**

For IEEE 802.11b and g (DSSS) signals only:

If **enabled**, only PPDU with a **specific** payload length are considered for measurement analysis.

If **disabled**, only PPDU whose length is within a specified **range** are considered.

The payload length is specified by the [\[SENSe:\]DEMod:FORMat:BANalyze:DBYTes:MIN](#) command.

A payload length **range** is defined as a minimum and maximum number of symbols the payload may contain (see [\[SENSe:\]DEMod:FORMat:BANalyze:DBYTes:MAX](#) on page 329 and [\[SENSe:\]DEMod:FORMat:BANalyze:DBYTes:MIN](#)).



Configuring the WLAN IQ measurement (modulation accuracy, flatness and tolerance)

**Parameters:**

<State> ON | OFF | 1 | 0  
 \*RST: 0

**Manual operation:** See "[Equal PPDU Length](#)" on page 185

**[SENSe:]DEMod:FORMat:BANalyze:DBYtes:MAX <NumDataBytes>**

If the `[SENSe:]DEMod:FORMat:BANalyze:DBYtes:EQUal` command is set to **false**, this command specifies the maximum number of data bytes allowed for a PPDU to take part in measurement analysis.

If the `[SENSe:]DEMod:FORMat:BANalyze:DBYtes:EQUal` command is set to **true**, then this command has no effect.

**Parameters:**

<NumDataBytes> \*RST: 64  
 Default unit: bytes

**Manual operation:** See "[\(Min./Max.\) Payload Length](#)" on page 188

**[SENSe:]DEMod:FORMat:BANalyze:DBYtes:MIN <NumDataBytes>**

For **IEEE 802.11b and g (DSSS)** signals only:

If the `[SENSe:]DEMod:FORMat:BANalyze:DBYtes:EQUal` command is set to **true**, then this command specifies the exact number of data bytes a PPDU must have to take part in measurement analysis.

If the `[SENSe:]DEMod:FORMat:BANalyze:DBYtes:EQUal` command is set to **false**, this command specifies the minimum number of data bytes required for a PPDU to take part in measurement analysis.

**Parameters:**

<NumDataBytes> \*RST: 1  
 Default unit: bytes

**Manual operation:** See "[\(Min./Max.\) Payload Length](#)" on page 188

**[SENSe:]DEMod:FORMat:BANalyze:DURation:EQUal <State>**

For **IEEE 802.11b and g (DSSS)** signals only:

If **enabled**, only PPDU's with a **specific** duration are considered for measurement analysis.

If **disabled**, only PPDU's whose duration is within a specified **range** are considered.

The duration is specified by the `[SENSe:]DEMod:FORMat:BANalyze:DURation:MIN` command.

A duration **range** is defined as a minimum and maximum duration the PPDU may have (see `[SENSe:]DEMod:FORMat:BANalyze:DURation:MAX` and `[SENSe:]DEMod:FORMat:BANalyze:DURation:MIN`).

Configuring the WLAN IQ measurement (modulation accuracy, flatness and tolerance)

**Parameters:**

<State> ON | OFF | 1 | 0  
 \*RST: 0

**Manual operation:** See "[Equal PPDU Length](#)" on page 185

**[SENSe:]DEMod:FORMat:BANalyze:DURation:MAX <Duration>**

For IEEE 802.11b and g (DSSS) signals only:

If the `[SENSe:]DEMod:FORMat:BANalyze:DURation:EQUal` command is set to **false**, this command specifies the maximum number of symbols allowed for a PPDU to take part in measurement analysis.

If the `[SENSe:]DEMod:FORMat:BANalyze:DURation:EQUal` command is set to **true**, then this command has no effect.

**Parameters:**

<Duration> \*RST: 5464  
 Default unit: us

**Manual operation:** See "[\(Min./Max.\) Payload Length](#)" on page 188

**[SENSe:]DEMod:FORMat:BANalyze:DURation:MIN <Duration>**

For IEEE 802.11b and g (DSSS) signals only:

If the `[SENSe:]DEMod:FORMat:BANalyze:DURation:EQUal` command is set to **true** then this command specifies the **exact** duration required for a PPDU to take part in measurement analysis.

If the `[SENSe:]DEMod:FORMat:BANalyze:DURation:EQUal` command is set to **false** this command specifies the **minimum** duration required for a PPDU to take part in measurement analysis.

**Parameters:**

<Duration> \*RST: 1  
 Default unit: us

**Manual operation:** See "[\(Min./Max.\) Payload Length](#)" on page 188

**[SENSe:]DEMod:FORMat:BANalyze:SYMBols:EQUal <State>**

For IEEE 802.11a, ac, g (OFDM), j, n, p signals only:

If **enabled**, only PPDU's with a **specific** number of symbols are considered for measurement analysis.

If **disabled**, only PPDU's whose length is within a specified **range** are considered.

The number of symbols is specified by the `[SENSe:]DEMod:FORMat:BANalyze:SYMBols:MIN` command.

Configuring the WLAN IQ measurement (modulation accuracy, flatness and tolerance)

A **range** of data symbols is defined as a minimum and maximum number of symbols the payload may contain (see [\[SENSe:\]DEMod:FORMat:BANalyze:SYMBols:MAX](#) on page 332 and [\[SENSe:\]DEMod:FORMat:BANalyze:SYMBols:MIN](#) on page 332).

**Parameters:**

<State> ON | OFF | 1 | 0  
\*RST: 0

**Manual operation:** See ["Equal PPDU Length"](#) on page 185

**[SENSe:]DEMod:FORMat:BANalyze:SYMBols:LENGth:STATe** <State>

For IEEE 802.11a, ac, g (OFDM), j, n, p signals only:

If **enabled**, the number of PPDU data symbols after the "Analysis Interval Offset" which are to be analyzed can be specified (see [\[SENSe:\]DEMod:FORMat:BANalyze:SYMBols:LENGth](#) on page 331).

If **disabled**, all PPDU data symbols after the "Analysis Interval Offset" are evaluated.

**Parameters:**

<State> ON | OFF | 0 | 1  
**OFF | 0**  
Switches the function off  
**ON | 1**  
Switches the function on  
\*RST: 1

**Example:**

```
SENS:DEMod:FORMat:BANalyze:SYMB:OFFS 10
PPDUs are analyzed after the 10th symbol in the PPDU.
SENS:DEMod:FORMat:BANalyze:SYMB:LENG:STAT OFF
PPDUs are analyzed after the symbol offset (10) until the end of
each PPDU.
SENS:DEMod:FORMat:BANalyze:SYMB:LENG 100
100 symbols after the symbol offset (10-110) are analyzed in
each PPDU.
```

**Manual operation:** See ["Analysis Interval Offset/Analysis Interval Length"](#) on page 186

**[SENSe:]DEMod:FORMat:BANalyze:SYMBols:LENGth** <NumDataSymbols>

For IEEE 802.11a, ac, g (OFDM), j, n, p signals only:

If the [\[SENSe:\]DEMod:FORMat:BANalyze:SYMBols:LENGth:STATe](#) command is set to **false**, this command specifies the number of PPDU data symbols after the Analysis Interval Offset (see [\[SENSe:\]DEMod:FORMat:BANalyze:SYMBols:OFFSet](#) on page 333) which are to be analyzed.

If the [\[SENSe:\]DEMod:FORMat:BANalyze:SYMBols:LENGth:STATe](#) command is set to **true**, then this command has no effect.

Configuring the WLAN IQ measurement (modulation accuracy, flatness and tolerance)

**Parameters:**

<NumDataSymbols> Range: 0 to 10000  
\*RST: 0

**Example:**

```
SENS:DEM:FORM:BAN:SYMB:OFFS 10
SENS:DEM:FORM:BAN:SYMB:LENG:STAT OFF
SENS:DEM:FORM:BAN:SYMB:LENG 100
```

**Manual operation:** See "[Analysis Interval Offset/Analysis Interval Length](#)" on page 186

**[SENSe:]DEMod:FORMat:BANalyze:SYMBOLs:MAX** <NumDataSymbols>

For IEEE 802.11a, ac, g (OFDM), j, n, p signals only:

If the `[SENSe:]DEMod:FORMat:BANalyze:SYMBOLs:EQUal` command is set to **false**, this command specifies the maximum number of payload symbols allowed for a PPDU to take part in measurement analysis.

The number of payload symbols is defined as the uncoded bits including service and tail bits.

If the `[SENSe:]DEMod:FORMat:BANalyze:SYMBOLs:EQUal` command has been set to **true**, then this command has no effect.

**Parameters:**

<NumDataSymbols> integer  
\*RST: 64

**Manual operation:** See "[\(Min./Max.\) No. of Data Symbols](#)" on page 186

**[SENSe:]DEMod:FORMat:BANalyze:SYMBOLs:MIN** <NumDataSymbols>

For IEEE 802.11a, ac, g (OFDM), j, n, p signals only:

If the `[SENSe:]DEMod:FORMat:BANalyze:SYMBOLs:EQUal` command has been set to **true**, then this command specifies the exact number of payload symbols a PPDU must have to take part in measurement analysis.

If the `[SENSe:]DEMod:FORMat:BANalyze:SYMBOLs:EQUal` command is set to **false**, this command specifies the minimum number of payload symbols required for a PPDU to take part in measurement analysis.

The number of payload symbols is defined as the uncoded bits including service and tail bits.

**Parameters:**

<NumDataSymbols> integer  
\*RST: 1

**Example:**

```
SENS:DEM:FORM:BAN:SYMB:EQU ON
SENS:DEMO:FORM:BAN:SYMB:MIN
```

**Manual operation:** See "[\(Min./Max.\) No. of Data Symbols](#)" on page 186

Configuring the WLAN IQ measurement (modulation accuracy, flatness and tolerance)

---

**[SENSe:]DEMod:FORMat:BANalyze:SYMBOLs:OFFSet** <NumDataSymbols>

For IEEE 802.11a, ac, g (OFDM), j, n, p signals only:

Specifies the number of data symbols from the start of each PPDU that are to be skipped before symbols take part in analysis.

**Parameters:**

<NumDataSymbols> integer

Range: 0 to 10000

\*RST: 0

**Example:**

SENS:DEMod:FORMat:BANalyze:SYMBOLs:OFFSet 10

PPDUs are analyzed after the 10th symbol in the PPDU.

SENS:DEMod:FORMat:BANalyze:SYMBOLs:OFFSet 0

PPDUs are analyzed with a symbol offset of 0, i.e. starting with the first symbol

**Manual operation:** See "[Analysis Interval Offset/Analysis Interval Length](#)" on page 186

---

**[SENSe:]SWEep:LIMit:ABORt:STATe** <State>

Determines the behavior of the application after a limit check fails.

**Parameters:**

<State> ON | OFF | 0 | 1

**OFF | 0**

A limit check has no effects on the measurement.

**ON | 1**

The measurement is stopped if the limit check fails at any time during the measurement.

\*RST: 0

**Example:**

SWE:LIM:ABORt:STATe ON

**Manual operation:** See "[Stop RUN on Limit Check Fail](#)" on page 185

## 10.5.9 Limits

The following commands are required to define the limits against which the individual parameter results are checked. Principally, the limits are defined in the WLAN 802.11 standards. However, you can change the limits for your own test cases and reset the limits to the standard values later. Note that changing limits is currently only possible via remote control, not manually via the user interface.

The commands required to retrieve the limit check results are described in [Chapter 10.9.1.3, "Limit check results"](#), on page 393.

Useful commands for defining limits described elsewhere:

- [UNIT:EVM](#) on page 393

Configuring the WLAN IQ measurement (modulation accuracy, flatness and tolerance)

- [UNIT:GIMBalance](#) on page 393

#### Remote commands exclusive to defining limits:

<a href="#">CALCulate&lt;n&gt;:LIMit&lt;li&gt;:BURSt:ALL</a> .....	334
<a href="#">CALCulate&lt;n&gt;:LIMit&lt;li&gt;:BURSt:EVM:ALL[:AVERAge]</a> .....	335
<a href="#">CALCulate&lt;n&gt;:LIMit&lt;li&gt;:BURSt:EVM:ALL:MAXimum</a> .....	335
<a href="#">CALCulate&lt;n&gt;:LIMit&lt;li&gt;:BURSt:EVM:DATA[:AVERAge]</a> .....	335
<a href="#">CALCulate&lt;n&gt;:LIMit&lt;li&gt;:BURSt:EVM:DATA:MAXimum</a> .....	335
<a href="#">CALCulate&lt;n&gt;:LIMit&lt;li&gt;:BURSt:EVM:PILOt[:AVERAge]</a> .....	336
<a href="#">CALCulate&lt;n&gt;:LIMit&lt;li&gt;:BURSt:EVM:PILOt:MAXimum</a> .....	336
<a href="#">CALCulate&lt;n&gt;:LIMit&lt;li&gt;:BURSt:EVM[:AVERAge]</a> .....	336
<a href="#">CALCulate&lt;n&gt;:LIMit&lt;li&gt;:BURSt:EVM:MAXimum</a> .....	336
<a href="#">CALCulate&lt;n&gt;:LIMit&lt;li&gt;:BURSt:FERRor[:AVERAge]</a> .....	336
<a href="#">CALCulate&lt;n&gt;:LIMit&lt;li&gt;:BURSt:FERRor:MAXimum</a> .....	336
<a href="#">CALCulate&lt;n&gt;:LIMit&lt;li&gt;:BURSt:IQOFFset[:AVERAge]</a> .....	337
<a href="#">CALCulate&lt;n&gt;:LIMit&lt;li&gt;:BURSt:IQOFFset:MAXimum</a> .....	337
<a href="#">CALCulate&lt;n&gt;:LIMit&lt;li&gt;:BURSt:SYMBOLerror[:AVERAge]</a> .....	337
<a href="#">CALCulate&lt;n&gt;:LIMit&lt;li&gt;:BURSt:SYMBOLerror:MAXimum</a> .....	337
<a href="#">CALCulate&lt;n&gt;:LIMit&lt;li&gt;:BURSt:TFALI[:AVERAge]</a> .....	337
<a href="#">CALCulate&lt;n&gt;:LIMit&lt;li&gt;:BURSt:TFALI:MAXimum</a> .....	337
<a href="#">CALCulate&lt;n&gt;:LIMit&lt;li&gt;:BURSt:TRISe[:AVERAge]</a> .....	338
<a href="#">CALCulate&lt;n&gt;:LIMit&lt;li&gt;:BURSt:TRISe:MAXimum</a> .....	338

---

#### **CALCulate<n>:LIMit<li>:BURSt:ALL** <Limits>...

Sets or returns the limit values for the parameters determined by the default WLAN measurement all in one step.

For details see [Chapter 3.1.1, "Modulation accuracy, flatness and tolerance parameters"](#), on page 15.

To define individual limit values use the individual `CALCulate<n>:LIMit<k>:BURSt...` commands.

Note that the units for the EVM and gain imbalance parameters must be defined in advance using the following commands:

- [UNIT:EVM](#) on page 393
- [UNIT:GIMBalance](#) on page 393

#### **Suffix:**

<n>	Window
<li>	1..n

Configuring the WLAN IQ measurement (modulation accuracy, flatness and tolerance)

**Parameters:**

<Limits>                    The parameters are input or output as a list of (ASCII) values separated by ',' in the following order:  
 <average CF error>, <max CF error>, <average symbol clock error>, <max symbol clock error>, <average I/Q offset>, <maximum I/Q offset>, <average EVM all carriers>, <max EVM all carriers>, <average EVM data carriers>, <max EVM data carriers> <average EVM pilots>, <max EVM pilots>

---

**CALCulate<n>:LIMit<li>:BURSt:EVM:ALL[:AVERAge] <Limit>**

**CALCulate<n>:LIMit<li>:BURSt:EVM:ALL:MAXimum <Limit>**

Sets or queries the average or maximum error vector magnitude limit for all carriers as determined by the default WLAN measurement.

For details see [Chapter 3.1.1, "Modulation accuracy, flatness and tolerance parameters"](#), on page 15.

**Suffix:**

<n>                            [Window](#)

<li>                            1..n

**Parameters:**

<Limit>                    numeric value in dB  
 The unit for the EVM parameters can be changed in advance using [UNIT:EVM](#) on page 393.  
 Default unit: DB

---

**CALCulate<n>:LIMit<li>:BURSt:EVM:DATA[:AVERAge] <Limit>**

**CALCulate<n>:LIMit<li>:BURSt:EVM:DATA:MAXimum <Limit>**

Sets or queries the average or maximum error vector magnitude limit for the data carrier determined by the default WLAN measurement.

For details see [Chapter 3.1.1, "Modulation accuracy, flatness and tolerance parameters"](#), on page 15.

**Suffix:**

<n>                            [Window](#)

<li>                            1..n

**Parameters:**

<Limit>                    numeric value in dB  
 The unit for the EVM parameters can be changed in advance using [UNIT:EVM](#) on page 393.  
 Default unit: DB

Configuring the WLAN IQ measurement (modulation accuracy, flatness and tolerance)

---

**CALCulate<n>:LIMit<li>:BURSt:EVM:PILot[:AVERAge] <Limit>**

**CALCulate<n>:LIMit<li>:BURSt:EVM:PILot:MAXimum <Limit>**

Sets or queries the average or maximum error vector magnitude limit for the pilot carriers determined by the default WLAN measurement.

For details see [Chapter 3.1.1, "Modulation accuracy, flatness and tolerance parameters"](#), on page 15.

**Suffix:**

<n> [Window](#)

<li> 1..n

**Parameters:**

<Limit> numeric value in dB  
The unit for the EVM parameters can be changed in advance using [UNIT:EVM](#) on page 393.

Default unit: DB

---

**CALCulate<n>:LIMit<li>:BURSt:EVM[:AVERAge] <Limit>**

**CALCulate<n>:LIMit<li>:BURSt:EVM:MAXimum <Limit>**

Sets or queries the average or maximum error vector magnitude limit determined by the default WLAN measurement.

For details see [Chapter 3.1.1, "Modulation accuracy, flatness and tolerance parameters"](#), on page 15.

Is only available for **IEEE 802.11b and g (DSSS)**.

**Suffix:**

<n> [Window](#)

<li> 1..n

**Parameters:**

<Limit> numeric value in dB  
The unit for the EVM parameters can be changed in advance using [UNIT:EVM](#) on page 393.

Default unit: PCT

---

**CALCulate<n>:LIMit<li>:BURSt:FERRor[:AVERAge] <Limit>**

**CALCulate<n>:LIMit<li>:BURSt:FERRor:MAXimum <Limit>**

Sets or queries the average or maximum center frequency error limit determined by the default WLAN measurement.

For details see [Chapter 3.1.1, "Modulation accuracy, flatness and tolerance parameters"](#), on page 15.

**Suffix:**

<n> [Window](#)

<li> 1..n



Configuring the WLAN IQ measurement (modulation accuracy, flatness and tolerance)

**Parameters:**

<Limit>                    numeric value in Hertz  
                                   Default unit: HZ

**CALCulate<n>:LIMit<li>:BURSt:IQOFFset[:AVERAge] <Limit>**

**CALCulate<n>:LIMit<li>:BURSt:IQOFFset:MAXimum <Limit>**

Sets or queries the average or maximum I/Q offset error limit determined by the default WLAN measurement..

For details see [Chapter 3.1.1, "Modulation accuracy, flatness and tolerance parameters"](#), on page 15.

**Suffix:**

<n>                            [Window](#)

<li>                           1..n

**Parameters:**

<Limit>                    Range:        -1000000 to 1000000  
                                   Default unit: DB

**CALCulate<n>:LIMit<li>:BURSt:SYMBOLerror[:AVERAge] <Limit>**

**CALCulate<n>:LIMit<li>:BURSt:SYMBOLerror:MAXimum <Limit>**

Sets or queries the average or maximum symbol clock error limit determined by the default WLAN measurement.

For details see [Chapter 3.1.1, "Modulation accuracy, flatness and tolerance parameters"](#), on page 15.

**Suffix:**

<n>                            [Window](#)

<li>                           1..n

**Parameters:**

<Limit>                    numeric value in parts per million  
                                   Default unit: PPM

**CALCulate<n>:LIMit<li>:BURSt:TFALI[:AVERAge] <Limit>**

**CALCulate<n>:LIMit<li>:BURSt:TFALI:MAXimum <Limit>**

Sets or queries the average or maximum fall time limit for the data carrier determined by the default WLAN measurement.

For details see [Chapter 3.1.1, "Modulation accuracy, flatness and tolerance parameters"](#), on page 15.

**Suffix:**

<n>                            [Window](#)

<li>                           1..n

Configuring the WLAN IQ measurement (modulation accuracy, flatness and tolerance)

**Parameters:**

<Limit> Default unit: S

---

**CALCulate<n>:LIMit<li>:BURSt:TRISe[:AVERage] <Limit>**

**CALCulate<n>:LIMit<li>:BURSt:TRISe:MAXimum <Limit>**

Sets or queries the average or maximum rise time limit for the data carrier determined by the default WLAN measurement.

For details see [Chapter 3.1.1, "Modulation accuracy, flatness and tolerance parameters"](#), on page 15.

**Suffix:**

<n> [Window](#)

<li> 1..n

**Parameters:**

<Limit> Default unit: S

## 10.5.10 Automatic settings



### MSRA operating mode

In MSRA operating mode, the following commands are not available, as they require a new data acquisition. However, WLAN 802.11 secondary applications cannot perform data acquisition in MSRA operating mode.

Useful commands for automatic configuration described elsewhere:

- [CONFigure:POWer:AUTO](#) on page 267
- [CONFigure:POWer:AUTO:SWEep:TIME](#) on page 267

### Remote commands exclusive to automatic configuration:

<a href="#">[SENSe:]ADJust:CONFigure:HYSTeresis:LOWer</a> .....	338
<a href="#">[SENSe:]ADJust:CONFigure:HYSTeresis:UPPer</a> .....	339
<a href="#">[SENSe:]ADJust:CONFigure:LEVel:DURation</a> .....	339
<a href="#">[SENSe:]ADJust:CONFigure:LEVel:DURation:MODE</a> .....	340
<a href="#">[SENSe:]ADJust:LEVel</a> .....	340

---

**[SENSe:]ADJust:CONFigure:HYSTeresis:LOWer <Threshold>**

When the reference level is adjusted automatically using the [\[SENSe:\]ADJust:LEVel](#) on page 340 command, the internal attenuators and the preamplifier are also adjusted. To avoid frequent adaptation due to small changes in the input signal, you can define a hysteresis. This setting defines a lower threshold the signal must fall below (compared to the last measurement) before the reference level is adapted automatically.

Configuring the WLAN IQ measurement (modulation accuracy, flatness and tolerance)

**Parameters:**

<Threshold>           Range:       0 dB to 200 dB  
                           \*RST:        +1 dB  
                           Default unit: dB

**Example:**

```
SENS:ADJ:CONF:HYST:LOW 2
```

For an input signal level of currently 20 dBm, the reference level is only adjusted when the signal level falls below 18 dBm.

**[SENSe:]ADJust:CONFigure:HYSteresis:UPPer <Threshold>**

When the reference level is adjusted automatically using the [\[SENSe:\]ADJust:LEVel](#) on page 340 command, the internal attenuators and the preamplifier are also adjusted. To avoid frequent adaptation due to small changes in the input signal, you can define a hysteresis. This setting defines an upper threshold the signal must exceed (compared to the last measurement) before the reference level is adapted automatically.

**Parameters:**

<Threshold>           Range:       0 dB to 200 dB  
                           \*RST:        +1 dB  
                           Default unit: dB

**Example:**

```
SENS:ADJ:CONF:HYST:UPP 2
```

**Example:**

For an input signal level of currently 20 dBm, the reference level is only adjusted when the signal level rises above 22 dBm.

**[SENSe:]ADJust:CONFigure:LEVel:DURation <Duration>**

To determine the ideal reference level, the FSW performs a measurement on the current input data. This command defines the length of the measurement if [\[SENSe:\]ADJust:CONFigure:LEVel:DURation:MODE](#) is set to `MANual`.

**Parameters:**

<Duration>           Numeric value in seconds  
                           Range:       0.001 to 16000.0  
                           \*RST:        0.001  
                           Default unit: s

**Example:**

```
ADJ:CONF:DUR:MODE MAN
```

Selects manual definition of the measurement length.

```
ADJ:CONF:LEV:DUR 5ms
```

Length of the measurement is 5 ms.

**Manual operation:**

See ["Changing the Automatic Measurement Time \(Meas Time Manual\)"](#) on page 197

Configuring the WLAN IQ measurement (modulation accuracy, flatness and tolerance)

---

### [SENSe:]ADJust:CONFigure:LEVel:DURation:MODE <Mode>

To determine the ideal reference level, the FSW performs a measurement on the current input data. This command selects the way the FSW determines the length of the measurement .

#### Parameters:

<Mode>

#### AUTO

The FSW determines the measurement length automatically according to the current input data.

#### MANual

The FSW uses the measurement length defined by [SENSe:]ADJust:CONFigure:LEVel:DURation on page 339.

\*RST: AUTO

**Manual operation:** See "[Resetting the Automatic Measurement Time \(Meas Time Auto\)](#)" on page 197  
See "[Changing the Automatic Measurement Time \(Meas Time Manual\)](#)" on page 197

---

### [SENSe:]ADJust:LEVel

Initiates a single (internal) measurement that evaluates and sets the ideal reference level for the current input data and measurement settings. Thus, the settings of the RF attenuation and the reference level are optimized for the signal level. The FSW is not overloaded and the dynamic range is not limited by an S/N ratio that is too small.

**Example:** ADJ:LEV

**Manual operation:** See "[Setting the Reference Level Automatically \(Auto Level\)](#)" on page 122

## 10.5.11 Configuring the secondary application data range (MSRA mode only)

In MSRA operating mode, only the MSRA primary actually captures data; the MSRA secondary applications define an extract of the captured data for analysis, referred to as the **secondary application data**.

For the R&S FSW WLAN application, the secondary application data range is defined by the same commands used to define the signal capture in Signal and Spectrum Analyzer mode (see [Chapter 10.5.4, "Signal capturing"](#), on page 274). Be sure to select the correct measurement channel before executing this command.

In addition, a capture offset can be defined, i.e. an offset from the start of the captured data to the start of the secondary application data for the WLAN I/Q measurement.

The **analysis interval** used by the individual result displays cannot be edited, but is determined automatically. However, you can query the currently used analysis interval for a specific window.

The **analysis line** is displayed by default but can be hidden or re-positioned.

Configuring the WLAN IQ measurement (modulation accuracy, flatness and tolerance)

### Remote commands exclusive to MSRA secondary applications

The following commands are only available for MSRA secondary application channels:

CALCulate<n>:MSRA:ALINe:SHOW.....	341
CALCulate<n>:MSRA:ALINe[:VALue].....	341
CALCulate<n>:MSRA:WINDow<n>:IVAL.....	341
INITiate<n>:REFResh.....	342
[SENSe:]MSRA:CAPTure:OFFSet.....	342

---

#### CALCulate<n>:MSRA:ALINe:SHOW

Defines whether or not the analysis line is displayed in all time-based windows in all MSRA secondary applications and the MSRA primary application.

**Note:** even if the analysis line display is off, the indication whether or not the currently defined line position lies within the analysis interval of the active secondary application remains in the window title bars.

**Suffix:**

<n> irrelevant

**Parameters:**

<State> ON | OFF | 0 | 1

**OFF | 0**

Switches the function off

**ON | 1**

Switches the function on

---

#### CALCulate<n>:MSRA:ALINe[:VALue] <Position>

Defines the position of the analysis line for all time-based windows in all MSRA secondary applications and the MSRA primary application.

**Suffix:**

<n> irrelevant

**Parameters:**

<Position> Position of the analysis line in seconds. The position must lie within the measurement time of the MSRA measurement.

Default unit: s

---

#### CALCulate<n>:MSRA:WINDow<n>:IVAL

Returns the current analysis interval for applications in MSRA operating mode.

**Suffix:**

<n> irrelevant

<n> 1..n

Window

**Return values:**

<IntStart>	Analysis start = Capture offset time Default unit: s
<IntStop>	Analysis end = capture offset + capture time Default unit: s

**INITiate<n>:REFResh**

Updates the current measurement results to reflect the current measurement settings.

No new I/Q data is captured. Thus, measurement settings apply to the I/Q data currently in the capture buffer.

The command applies exclusively to I/Q measurements. It requires I/Q data.

**Suffix:**

<n> irrelevant

**Example:**

INIT:REFR  
Updates the IQ measurement results.

**Usage:**

Asynchronous command

**Manual operation:** See "[Refresh \(MSRA only\)](#)" on page 198

**[SENSe:]MSRA:CAPTure:OFFSet <Offset>**

This setting is only available for secondary applications in MSRA mode, not for the MSRA primary application. It has a similar effect as the trigger offset in other measurements.

**Parameters:**

<Offset> This parameter defines the time offset between the capture buffer start and the start of the extracted secondary application data. The offset must be a positive value, as the secondary application can only analyze data that is contained in the capture buffer.

Range: 0 to <Record length>

\*RST: 0

Default unit: S

**Manual operation:** See "[Capture Offset](#)" on page 128

## 10.6 Configuring frequency sweep measurements on WLAN 802.11 signals

The R&S FSW WLAN application uses the functionality of the FSW base system (Spectrum application, see the FSW base unit user manual) to perform the WLAN frequency sweep measurements. The R&S FSW WLAN application automatically sets the

## Configuring frequency sweep measurements on WLAN 802.11 signals

parameters to predefined settings as described in [Chapter 5.4, "Frequency sweep measurements"](#), on page 199.

The WLAN RF measurements must be activated for a measurement channel in the R&S FSW WLAN application, see [Chapter 10.3, "Activating WLAN 802.11 measurements"](#), on page 224.

For details on configuring these RF measurements in a remote environment, see the Remote Commands chapter of the FSW base unit user manual.

### Remote commands exclusive to RF measurements in the R&S FSW WLAN application:

<a href="#">CONFigure:BURSt:SPECTrum:MASK:SElect</a> .....	343
<a href="#">[SENSe:]POWer:SEM</a> .....	343
<a href="#">[SENSe:]POWer:ACHannel:CBWidth</a> .....	345
<a href="#">[SENSe:]POWer:SEM:CLASs</a> .....	346
<a href="#">[SENSe:]FREQuency:SPAN</a> .....	346
<a href="#">[SENSe:]FREQuency:SPAN:FULL</a> .....	346
<a href="#">[SENSe:]FREQuency:START</a> .....	346
<a href="#">[SENSe:]FREQuency:STOP</a> .....	346

---

**CONFigure:BURSt:SPECTrum:MASK:SElect** <Standard>  
**[SENSe:]POWer:SEM** <Standard>

Sets the "Spectrum Emission Mask" (SEM) measurement type.

#### Parameters:

<Standard>

IEEE | ETSI | User

#### User

Settings and limits are configured via a user-defined XML file.

Load the file using [MMEMory:LOAD:SEM:STATe](#) on page 440.

#### IEEE

Settings and limits are as specified in the IEEE Std 802.11n™-2009 Figure 20-17—Transmit spectral mask for 20 MHz transmission. For other IEEE standards see the parameter values in the table below.

After a query, **IEEE** is returned for all IEEE standards.

#### ETSI

Settings and limits are as specified in the ETSI standard.

\*RST: IEEE

#### Example:

POW:SEM ETSI

**Table 10-7: Supported IEEE standards**

Manual operation	The spectrum emission mask measurement is performed according to the standard	Parameter value
IEEE 802.11n-2009 20M@2.4G	IEEE Std 802.11n™-2009 Figure 20-17—Transmit spectral mask for 20 MHz transmission	IEEE or 'IEEE_2009_20_2_4'
IEEE 802.11n-2009 40M@2.4G	IEEE Std 802.11n™-2009 Figure 20-18—Transmit spectral mask for a 40 MHz channel	'IEEE_2009_40_2_4'

## Configuring frequency sweep measurements on WLAN 802.11 signals

Manual operation	The spectrum emission mask measurement is performed according to the standard	Parameter value
IEEE 802.11n-2009 20M@5G	IEEE Std 802.11n™-2009 Figure 20-17—Transmit spectral mask for 20 MHz transmission	'IEEE_2009_20_5'
IEEE 802.11n-2009 40M@5G	IEEE Std 802.11n™-2009 Figure 20-18—Transmit spectral mask for a 40 MHz channel	'IEEE_2009_40_5'
IEEE 802.11mb/D08 20M@2.4G	IEEE Std 802.11n™-2009 Figure 20-17—Transmit spectral mask for 20 MHz transmission IEEE Draft P802.11-REVmb™/D8.0, March 2011 Figure 19-17—Transmit spectral mask for 20 MHz transmission in the 2.4 GHz band	'IEEE_D08_20_2_4'
IEEE 802.11mb/D08 40M@2.4G	IEEE Std 802.11n™-2009 Figure 20-18—Transmit spectral mask for a 40 MHz channel IEEE Draft P802.11-REVmb™/D8.0, March 2011 Figure 19-18—Transmit spectral mask for a 40 MHz channel in the 2.4 GHz band	'IEEE_D08_40_2_4'
IEEE 802.11mb/D08 20M@5G	IEEE Draft P802.11-REVmb™/D8.0, March 2011 Figure 19-19—Transmit spectral mask for 20 MHz transmission in the 5 GHz band	'IEEE_D08_20_5'
IEEE 802.11mb/D08 40M@5G	IEEE Draft P802.11-REVmb™/D8.0, March 2011 Figure 19-20—Transmit spectral mask for a 40 MHz channel in the 5 GHz band	'IEEE_D08_40_5'
IEEE 802.11ac/D1.1 20M@5G	IEEE P802.11ac™/D1.1, August 2011 Figure 22-17—Transmit spectral mask for a 20 MHz channel	'IEEE_AC_D1_1_20_5'
IEEE 802.11ac/D1.1 40M@5G	IEEE P802.11ac™/D1.1, August 2011 Figure 22-18—Transmit spectral mask for a 40 MHz channel	'IEEE_AC_D1_1_40_5'
IEEE 802.11ac/D1.1 80M@5G	IEEE P802.11ac™/D1.1, August 2011 Figure 22-19—Transmit spectral mask for a 80 MHz channel	'IEEE_AC_D1_1_80_5'
IEEE 802.11ax-2021 20M@5G	IEEE Std 802.11ax-2021 Figure 27-47—Example transmit spectral mask for a 20 MHz mask PPDU	'IEEE_AX_2021_20'
IEEE 802.11ax-2021 40M@5G	IEEE Std 802.11ax-2021 Figure 27-48—Example transmit spectral mask for a 40 MHz mask PPDU	'IEEE_AX_2021_40'
IEEE 802.11ax-2021 80M@5G	IEEE Std 802.11ax-2021 Figure 27-49—Example transmit spectral mask for an 80 MHz mask PPDU	'IEEE_AX_2021_80'
IEEE 802.11ax-2021 160M@5G	IEEE Std 802.11ax-2021 Figure 27-50—Example transmit spectral mask for a 160 MHz mask PPDU	'IEEE_AX_2021_160'
IEEE 802.11be/D1.4 20M@5G	IEEE Std 802.11be/D1.4 January 2022 Figure 36-64—Example transmit spectral mask for a 20 MHz mask PPDU	'IEEE_BE_D1_4_20'



## Configuring frequency sweep measurements on WLAN 802.11 signals

Manual operation	The spectrum emission mask measurement is performed according to the standard	Parameter value
IEEE 802.11be/D1.4 40M@5G	IEEE Std 802.11be/D1.4 January 2022 Figure 36-65—Example transmit spectral mask for a 40 MHz mask PPDU	'IEEE_BE_D1_4_40'
IEEE 802.11be/D1.4 80M@5G	IEEE Std 802.11 be/D1.4 January 2022 Figure 36-66—Example transmit spectral mask for an 80 MHz mask PPDU	'IEEE_BE_D1_4_80'
IEEE 802.11be/D1.4 160M@5G	IEEE Std 802.11 be/D1.4 January 2022 Figure 36-67—Example transmit spectral mask for a 160 MHz mask PPDU	'IEEE_BE_D1_4_160'
IEEE 802.11be/D1.4 320M@5G	IEEE Std 802.11 be/D1.4 January 2022 Figure 36-68—Example transmit spectral mask for a 320 MHz mask PPDU	'IEEE_BE_D1_4_320'
IEEE 802.11ad-2016 2160M@60G	IEEE Std 802.11-2016 Figure 20-1—Transmit mask	'IEEE_AD_2016_2160'
IEEE 802.11ay/D7.0 2160M@60G	IEEE Std 802.11ay/D7.0 December 2020 IEEE Std 802.11-2016 Figure 20-1—Transmit mask	'IEEE_AD_2016_2160'
IEEE 802.11ay/D7.0 4320M@60G	IEEE Std 802.11ay/D7.0 December 2020 Figure 28-8 – Example transmit spectral mask for a 4.32 GHz mask PPDU	'IEEE_AY_D7_0_4320'
IEEE 802.11ay/D7.0 6480M@60G	IEEE Std 802.11ay/D7.0 December 2020 Figure 28-9 – Example transmit spectral mask for a 6.48 GHz mask PPDU	'IEEE_AY_D7_0_6480'
IEEE 802.11ay/D7.0 8640M@60G	IEEE Std 802.11ay/D7.0 December 2020 Figure 28-10 – Example transmit spectral mask for an 8.64 GHz mask PPDU	'IEEE_AY_D7_0_8640'

**[SENSe:]POWER:ACHannel:CBWidth <ChannelBandwidth>**

Sets the channel bandwidth to be applied for the "Spectrum Emission Mask" measurement.

**Parameters:**

<ChannelBandwidth> BW2\_5 | BW5 | BW10 | BW20 | BW40 | BW80 | BW160 | BW320

**BW2\_5**

2.5 MHz

**BW5**

5 MHz

**BW10**

10 MHz

**BW20**

20 MHz

**BW40**

40 MHz

(Requires a bandwidth extension option.)

**BW80**

80 MHz

(Requires a bandwidth extension option.)

**BW160**

160 MHz

(Requires a bandwidth extension option.)

---

**[SENSe:]POWer:SEM:CLASs <Index>**

Sets the "Spectrum Emission Mask" (SEM) power class index. The index represents the power classes to be applied. The index is directly related to the entries displayed in the power class drop-down box, within the SEM settings configuration page.

**Parameters:**

<Index>                      \*RST:        0

---

**[SENSe:]FREQuency:SPAN <Span>**

Defines the frequency span.

**Parameters:**

<Span>                      The minimum span for measurements in the frequency domain is 10 Hz.  
 For SEM and spurious emission measurements, the minimum span is 20 Hz.  
 Range:                      0 Hz to fmax  
 \*RST:                        Full span  
 Default unit: Hz

---

**[SENSe:]FREQuency:SPAN:FULL**

Restores the full span.

---

**[SENSe:]FREQuency:STARt <Frequency>****Parameters:**

<Frequency>                0 to (fmax - min span)  
 \*RST:                        0  
 Default unit: HZ

**Example:**                `FREQ:STAR 20MHz`

---

**[SENSe:]FREQuency:STOP <Frequency>****Parameters:**

<Frequency>                min span to fmax  
 \*RST:                        fmax  
 Default unit: HZ

**Example:**                `FREQ:STOP 2000 MHz`

## 10.7 Configuring the result display

The following commands are required to configure the screen display in a remote environment. The corresponding tasks for manual operation are described in [Chapter 5.2, "Display configuration"](#), on page 107.



The suffix <n> in the following remote commands represents the window (1..16) in the currently selected measurement channel.

- [General window commands](#)..... 347
- [Working with windows in the display](#)..... 349
- [Configuring the result summary display](#)..... 358
- [Configuring the spectrum flatness and group delay result displays](#)..... 360
- [Configuring the AM/AM result display](#)..... 361
- [Configuring constellation diagrams](#)..... 367

### 10.7.1 General window commands

The following commands are required to configure general window layout, independent of the application.

Note that the suffix <n> always refers to the window *in the currently selected channel* (see [INSTrument\[:SElect\]](#) on page 227).

<a href="#">DISPlay:FORMat</a> .....	347
<a href="#">DISPlay[:WINDow&lt;n&gt;]:SIZE</a> .....	347
<a href="#">DISPlay[:WINDow&lt;n&gt;][:SUBWindow&lt;w&gt;]:SElect</a> .....	348
<a href="#">DISPlay[:WINDow&lt;n&gt;]:SUBWindow&lt;w&gt;:SIZE</a> .....	348
<a href="#">DISPlay[:WINDow&lt;n&gt;]:TAB&lt;1..n&gt;:SElect</a> .....	349

---

#### **DISPlay:FORMat** <Format>

Determines which tab is displayed.

##### **Parameters:**

<Format>

##### **SPLit**

Displays the MultiView tab with an overview of all active channels

##### **SINGle**

Displays the measurement channel that was previously focused.

\*RST: SING

##### **Example:**

DISP:FORM SPL

---

#### **DISPlay[:WINDow<n>]:SIZE** <Size>

Maximizes the size of the selected result display window *temporarily*. To change the size of several windows on the screen permanently, use the [LAY:SPL](#) command (see [LAYout:SPLitter](#) on page 354).

**Suffix:**<n> [Window](#)**Parameters:**

&lt;Size&gt;

**LARGe**

Maximizes the selected window to full screen.  
Other windows are still active in the background.

**SMALI**

Reduces the size of the selected window to its original size.  
If more than one measurement window was displayed originally, these are visible again.

\*RST: SMALI

**Example:**

DISP:WIND2:SIZE LARG

**DISPlay[:WINDow<n>][:SUBWindow<w>]:SELEct**

Sets the focus on the selected result display window.

This window is then the active window.

For measurements with multiple results in subwindows, the command also selects the subwindow. Use this command to select the (sub)window before querying trace data.

**Suffix:**<n> [Window](#)

<w> subwindow  
Not supported by all applications

**Example:**

```
//Put the focus on window 1
DISP:WIND1:SEL
```

**Example:**

```
//Put the focus on subwindow 2 in window 1
DISP:WIND1:SUBW2:SEL
```

**DISPlay[:WINDow<n>]:SUBWindow<w>:SIZE <Size>**

Maximizes the size of the selected result display subwindow *temporarily*. To change the size of several windows on the screen permanently, use the [LAY:SPLit](#) command (see [LAYout:SPLit](#) on page 354).

**Suffix:**<n> [Window](#)

&lt;w&gt; 1..n

**Parameters:**

&lt;Size&gt;

FULL | SPLit

**FULL**

Maximizes the selected subwindow to full screen.  
Other windows are still active in the background.

**SPLit**

Reduces the size of the selected subwindow to its original size. If more than one measurement window was displayed originally, these are visible again.

\*RST: SPLit

**DISPlay[:WINDow<n>]:TAB<1..n>:SElect** [<SUBWindowName>]

Sets the focus on the selected result display subwindow for measurements with multiple result windows (MIMO). The subwindow is selected either by its number (<No> suffix) or by its name (<SubWindowName> parameter).

This window is then the active window.

Use this command to select the (sub)window before querying trace data.

**Suffix:**

<n>	1..n Window
<1..n>	1..n Number of the subwindow

**Parameters:**

<SUBWindowName> Name of the subwindow

**Example:**

Both the following commands select the same window for a 2-antenna MIMO setup:

```
DISPlay:WINDow2:TAB1:SElect 'Stream 2'
DISPlay:WINDow2:TAB3:SElect
```

## 10.7.2 Working with windows in the display

The following commands are required to change the evaluation type and rearrange the screen layout for a channel as you do using the SmartGrid in manual operation. Since the available evaluation types depend on the selected application, some parameters for the following commands also depend on the selected channel.

Note that the suffix <n> always refers to the window *in the currently selected channel*.

(See [INSTrument\[:SElect\]](#) on page 227).

<a href="#">LAYout:ADD[:WINDow]?</a> .....	350
<a href="#">LAYout:CATalog[:WINDow]?</a> .....	352
<a href="#">LAYout:IDENtify[:WINDow]?</a> .....	353
<a href="#">LAYout:MOVE[:WINDow]</a> .....	353
<a href="#">LAYout:REMove[:WINDow]</a> .....	354
<a href="#">LAYout:REPLace[:WINDow]</a> .....	354
<a href="#">LAYout:SPLitter</a> .....	354
<a href="#">LAYout:WINDow&lt;n&gt;:ADD?</a> .....	356
<a href="#">LAYout:WINDow&lt;n&gt;:IDENtify?</a> .....	356
<a href="#">LAYout:WINDow&lt;n&gt;:REMove</a> .....	357
<a href="#">LAYout:WINDow&lt;n&gt;:REPLace</a> .....	357

---

**LAYout:ADD[:WINDow]?** <WindowName>, <Direction>, <WindowType>

Adds a window to the display in the active channel.

Is always used as a query so that you immediately obtain the name of the new window as a result.

To replace an existing window, use the [LAYout:REPLace\[:WINDow\]](#) command.

**Query parameters:**

<b>&lt;WindowName&gt;</b>	String containing the name of the existing window the new window is inserted next to. By default, the name of a window is the same as its index. To determine the name and index of all active windows, use the <a href="#">LAYout:CATalog[:WINDow]?</a> query.
<b>&lt;Direction&gt;</b>	LEFT   RIGHT   ABOVE   BELOW Direction the new window is added relative to the existing window.
<b>&lt;WindowType&gt;</b>	text value Type of result display (evaluation method) you want to add. See the table below for available parameter values.

**Return values:**

<b>&lt;NewWindowName&gt;</b>	When adding a new window, the command returns its name (by default the same as its number) as a result.
------------------------------	---

**Example:**

```
LAY:ADD? '1', LEFT, MTAB
```

Result:

```
'2'
```

Adds a new window named '2' with a marker table to the left of window 1.

**Usage:**

Query only

<b>Manual operation:</b>	See <a href="#">"AM/AM"</a> on page 28
	See <a href="#">"AM/PM"</a> on page 29
	See <a href="#">"AM/EVM"</a> on page 29
	See <a href="#">"Amplitude Tracking"</a> on page 30
	See <a href="#">"Bitstream"</a> on page 30
	See <a href="#">"Constellation"</a> on page 32
	See <a href="#">"Constellation vs Carrier"</a> on page 34
	See <a href="#">"EVM vs Carrier"</a> on page 35
	See <a href="#">"EVM vs Chip"</a> on page 36
	See <a href="#">"EVM vs Symbol"</a> on page 36
	See <a href="#">"FFT Spectrum"</a> on page 37
	See <a href="#">"Freq. Error vs Preamble"</a> on page 38
	See <a href="#">"Gain Imbalance vs Carrier"</a> on page 39
	See <a href="#">"Group Delay"</a> on page 40
	See <a href="#">"Magnitude Capture"</a> on page 41
	See <a href="#">"Phase Error vs Preamble"</a> on page 42
	See <a href="#">"Phase Tracking"</a> on page 43
	See <a href="#">"PLCP Header (IEEE 802.11b, g (DSSS))"</a> on page 43
	See <a href="#">"PvT Full PPDU"</a> on page 44
	See <a href="#">"PvT Rising Edge"</a> on page 45
	See <a href="#">"PvT Falling Edge"</a> on page 46
	See <a href="#">"Quad Error vs Carrier"</a> on page 47
	See <a href="#">"Result Summary Detailed"</a> on page 47
	See <a href="#">"Result Summary Global"</a> on page 49
	See <a href="#">"Signal Content Detailed (IEEE 802.11ax, be)"</a> on page 51
	See <a href="#">"Signal Field"</a> on page 52
	See <a href="#">"Spectrum Flatness"</a> on page 54
	See <a href="#">"Spectrum Flatness Result Summary"</a> on page 56
	See <a href="#">"Unused Tone Error"</a> on page 56
	See <a href="#">"Unused Tone Error Summary"</a> on page 57
	See <a href="#">"Diagram"</a> on page 62
	See <a href="#">"Result Summary"</a> on page 63
	See <a href="#">"Marker Table"</a> on page 63
	See <a href="#">"Marker Peak List"</a> on page 64

**Table 10-8:** <WindowType> parameter values for WLAN application

Parameter value	Window type
<b>Window types for I/Q data</b>	
AMAM	"AM/AM" (IEEE 802.11a, ac, ax, g (OFDM), j, n, p, be only)
AMEV	"AM/EVM" (IEEE 802.11a, ac, ax, g (OFDM), j, n, p, be only)
AMPM	"AM/PM" (IEEE 802.11a, ac, ax, g (OFDM), j, n, p, be only)
ATRacking	"Amplitude Tracking" (IEEE 802.11ac, ax, n, be only)
BITStream	"Bitstream"
CMEMory	"Magnitude Capture"
CONStellation	"Constellation"
CVCARRIER	"Constellation vs. Carrier"(IEEE 802.11a, ac, g (OFDM), j, n, p only)

Parameter value	Window type
EVCARRIER	"EVM vs. Carrier" (IEEE 802.11a, ac, g (OFDM), j, n, p only)
EVCHIP	"EVM vs. Chip" (IEEE 802.11b and g (DSSS) only)
EVSYMBOL	"EVM vs. Symbol" (IEEE 802.11a, ac, g (OFDM), j, n, p only)
FEVPREAMBLE	"Frequency Error vs. Preamble"
FSPPECTRUM	"FFT Spectrum"
GAIN	"Gain Imbalance vs. Carrier"
GDELAY	"Group Delay" (IEEE 802.11a, ac, g (OFDM), j, n, p only)
PEVPREAMBLE	"Phase Error vs. Preamble"
PFALLING	"PvT Falling Edge"
PFPPDU	"PvT Full PPDU"
PRISING	"PvT Rising Edge"
PTRACKING	"Phase Tracking vs. Symbol"
QUAD	"Quadrature Error vs. Carrier"
RSDetailed	"Result Summary Detailed" (IEEE 802.11a, ac, g (OFDM), j, n, p only)
RSGlobal	"Result Summary Global"
SCDetailed	"Signal Content Detailed"
SField	"Signal Field" (IEEE 802.11a, ac, g (OFDM), j, n, p) "PLCP Header" (IEEE 802.11b and g (DSSS))
SFlatness	"Spectrum Flatness" (IEEE 802.11a, ac, g (OFDM), j, n, p only)
SFSummary	"Spectrum Flatness Result Summary" (IEEE 802.11ax only)""
UTERror	"Unused Tone Error" (IEEE 802.11ax only)
UTESummary	"Unused Tone Error" Summary (IEEE 802.11ax only)
<b>Window types for RF data</b>	
DIAGram	"Diagram" (SEM, ACLR)
MTABLE	"Marker table" (SEM, ACLR)
PEAKlist	"Marker peak list" (SEM, ACLR)
RSUMmary	"Result summary" (SEM, ACLR)

### LAYout:CATalog[:WINDow]?

Queries the name and index of all active windows in the active channel from top left to bottom right. The result is a comma-separated list of values for each window, with the syntax:

```
<WindowName_1>,<WindowIndex_1>..<WindowName_n>,<WindowIndex_n>
```



**Return values:**

<WindowName> string  
Name of the window.  
In the default state, the name of the window is its index.

<WindowIndex> **numeric value**  
Index of the window.

**Example:**

```
LAY:CAT?
```

Result:

```
'2',2,'1',1
```

Two windows are displayed, named '2' (at the top or left), and '1' (at the bottom or right).

**Usage:** Query only

**LAYout:IDENTify[:WINDow]?** <WindowName>

Queries the **index** of a particular display window in the active channel.

**Note:** to query the **name** of a particular window, use the [LAYout:WINDow<n>:IDENTify?](#) query.

**Query parameters:**

<WindowName> String containing the name of a window.

**Return values:**

<WindowIndex> Index number of the window.

**Example:**

```
LAY:IDEN:WIND? '2'
```

Queries the index of the result display named '2'.

Response:

```
2
```

**Usage:** Query only

**LAYout:MOVE[:WINDow]** <WindowName>, <WindowName>, <Direction>

**Setting parameters:**

<WindowName> String containing the name of an existing window that is to be moved.

By default, the name of a window is the same as its index. To determine the name and index of all active windows in the active channel, use the [LAYout:CATalog\[:WINDow\]?](#) query.

<WindowName> String containing the name of an existing window the selected window is placed next to or replaces.

By default, the name of a window is the same as its index. To determine the name and index of all active windows in the active channel, use the [LAYout:CATalog\[:WINDow\]?](#) query.

<Direction>	LEFT   RIGHT   ABOVE   BELOW   REPLACE Destination the selected window is moved to, relative to the reference window.
<b>Example:</b>	LAY:MOVE '4', '1', LEFT Moves the window named '4' to the left of window 1.
<b>Example:</b>	LAY:MOVE '1', '3', REPL Replaces the window named '3' by window 1. Window 3 is deleted.
<b>Usage:</b>	Setting only

**LAYout:REMove[:WINDow] <WindowName>**

Removes a window from the display in the active channel.

**Setting parameters:**

<WindowName> String containing the name of the window. In the default state, the name of the window is its index.

**Example:** LAY:REM '2'  
Removes the result display in the window named '2'.

**Usage:** Setting only

**LAYout:REPLace[:WINDow] <WindowName>, <WindowType>**

Replaces the window type (for example from "Diagram" to "Result Summary") of an already existing window in the active channel while keeping its position, index and window name.

To add a new window, use the [LAYout:ADD\[:WINDow\] ?](#) command.

**Setting parameters:**

<WindowName> String containing the name of the existing window.  
By default, the name of a window is the same as its index. To determine the name and index of all active windows in the active channel, use the [LAYout:CATalog\[:WINDow\] ?](#) query.

<WindowType> Type of result display you want to use in the existing window.  
See [LAYout:ADD\[:WINDow\] ?](#) on page 350 for a list of available window types.

**Example:** LAY:REPL:WIND '1', MTAB  
Replaces the result display in window 1 with a marker table.

**Usage:** Setting only

**LAYout:SPLitter <Index1>, <Index2>, <Position>**

Changes the position of a splitter and thus controls the size of the windows on each side of the splitter.

Compared to the `DISPlay[:WINDow<n>]:SIZE` on page 347 command, the `LAYout:SPLitter` changes the size of all windows to either side of the splitter permanently, it does not just maximize a single window temporarily.

Note that windows must have a certain minimum size. If the position you define conflicts with the minimum size of any of the affected windows, the command does not work, but does not return an error.

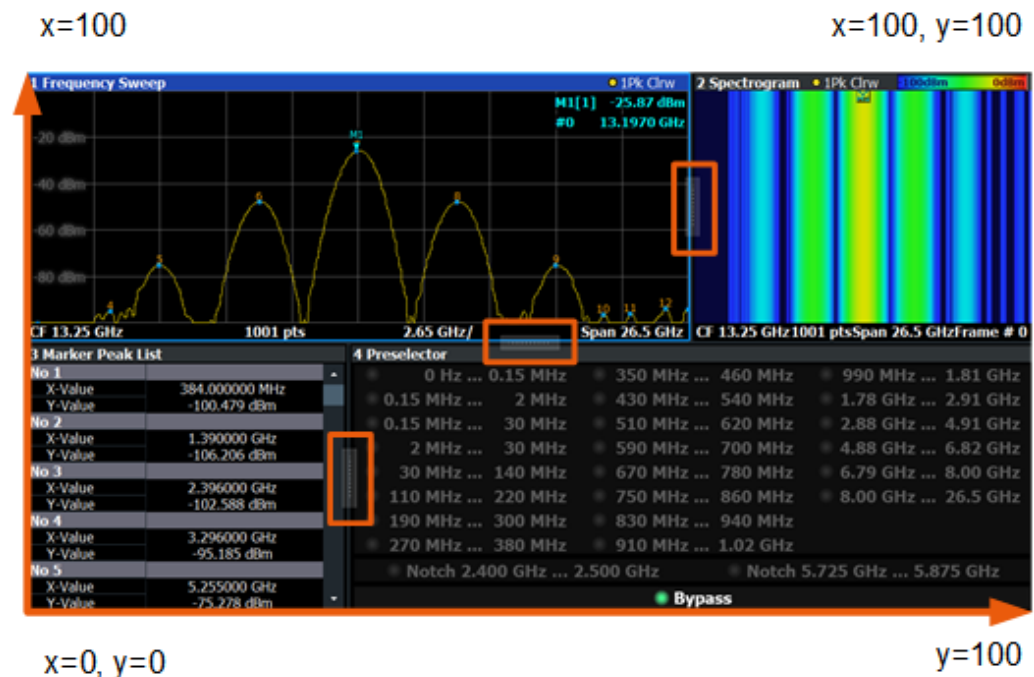

Figure 10-1: SmartGrid coordinates for remote control of the splitters

#### Setting parameters:

- <Index1> The index of one window the splitter controls.
- <Index2> The index of a window on the other side of the splitter.
- <Position> New vertical or horizontal position of the splitter as a fraction of the screen area (without channel and status bar and softkey menu).  
The point of origin ( $x = 0$ ,  $y = 0$ ) is in the lower left corner of the screen. The end point ( $x = 100$ ,  $y = 100$ ) is in the upper right corner of the screen. (See Figure 10-1.)  
The direction in which the splitter is moved depends on the screen layout. If the windows are positioned horizontally, the splitter also moves horizontally. If the windows are positioned vertically, the splitter also moves vertically.

Range: 0 to 100

#### Example:

```
LAY:SPL 1, 3, 50
```

Moves the splitter between window 1 ('Frequency Sweep') and 3 ('Marker Table') to the center (50%) of the screen, i.e. in the figure above, to the left.

**Example:** `LAY:SPL 1,4,70`  
 Moves the splitter between window 1 ('Frequency Sweep') and 3 ('Marker Peak List') towards the top (70%) of the screen. The following commands have the exact same effect, as any combination of windows above and below the splitter moves the splitter vertically.  
`LAY:SPL 3,2,70`  
`LAY:SPL 4,1,70`  
`LAY:SPL 2,1,70`

**Usage:** Setting only

### **LAYout:WINDow<n>:ADD? <Direction>,<WindowType>**

Adds a measurement window to the display. Note that with this command, the suffix <n> determines the existing window next to which the new window is added. Unlike [LAYout:ADD\[:WINDow\]?](#), for which the existing window is defined by a parameter.

To replace an existing window, use the [LAYout:WINDow<n>:REPLace](#) command.

Is always used as a query so that you immediately obtain the name of the new window as a result.

**Suffix:**

<n> [Window](#)

**Query parameters:**

<Direction> LEFT | RIGHT | ABOVE | BELOW

<WindowType> Type of measurement window you want to add.  
 See [LAYout:ADD\[:WINDow\]?](#) on page 350 for a list of available window types.

**Return values:**

<NewWindowName> When adding a new window, the command returns its name (by default the same as its number) as a result.

**Example:** `LAY:WIND1:ADD? LEFT,MTAB`  
**Result:**  
`'2'`  
 Adds a new window named '2' with a marker table to the left of window 1.

**Usage:** Query only

### **LAYout:WINDow<n>:IDENTify?**

Queries the **name** of a particular display window (indicated by the <n> suffix) in the active channel.

**Note:** to query the **index** of a particular window, use the [LAYout:IDENTify\[:WINDow\]?](#) command.

<b>Suffix:</b>	
<n>	Window
<b>Return values:</b>	
<WindowName>	String containing the name of a window. In the default state, the name of the window is its index.
<b>Example:</b>	LAY:WIND2:IDEN? Queries the name of the result display in window 2. Response: '2'
<b>Usage:</b>	Query only

---

#### LAYout:WINDow<n>:REMove

Removes the window specified by the suffix <n> from the display in the active channel.  
The result of this command is identical to the [LAYout:REMove\[:WINDow\]](#) command.

<b>Suffix:</b>	
<n>	Window
<b>Example:</b>	LAY:WIND2:REM Removes the result display in window 2.
<b>Usage:</b>	Event

---

#### LAYout:WINDow<n>:REPLace <WindowType>

Changes the window type of an existing window (specified by the suffix <n>) in the active channel.

The effect of this command is identical to the [LAYout:REPLace\[:WINDow\]](#) command.

To add a new window, use the [LAYout:WINDow<n>:ADD?](#) command.

<b>Suffix:</b>	
<n>	Window
<b>Setting parameters:</b>	
<WindowType>	Type of measurement window you want to replace another one with. See <a href="#">LAYout:ADD[:WINDow]?</a> on page 350 for a list of available window types.
<b>Example:</b>	LAY:WIND2:REPL MTAB Replaces the result display in window 2 with a marker table.
<b>Usage:</b>	Setting only

### 10.7.3 Configuring the result summary display

The following command defines which items are displayed in the "Result Summary".

---

**DISPlay[:WINDow<n>]:TABLE <State>**

Displays or removes the "Result Summary" Global window.

**Suffix:**

<n> 1..n

**Parameters:**

<State> ON | OFF | 0 | 1

**OFF | 0**

Removes the "Result Summary" Global window

**ON | 1**

Displays the "Result Summary" Global window

\*RST: 1

---

**DISPlay[:WINDow<n>]:TABLE:ITEM <Item>, <State>**

Defines which items are *displayed* in the "Result Summary" (see ["Result Summary Detailed"](#) on page 47 and ["Result Summary Global"](#) on page 49).

Note that the results are always *calculated*, regardless of their visibility in the "Result Summary".

**Suffix:**

<n> 1..n  
[Window](#)

**Parameters:**

<Item> Item to be included in "Result Summary". For an overview of possible results and the required parameters see the tables below.

<State> ON | OFF | 0 | 1

**OFF | 0**

Item is displayed in "Result Summary".

**ON | 1**

Item is not displayed in "Result Summary".

\*RST: 1

**Table 10-9: Parameters for the items of the "Result Summary Detailed"**

Result in table	SCPI parameter
TX channel ("Tx All")	TALL
I/Q offset	IOFSset
Gain imbalance	GIMBalance
Quadrature offset	QOFFset

Result in table	SCPI parameter
I/Q skew	IQSKew
PPDU power	TPPower
Crest factor	TCFactor
<b>Receive channel ("Rx All")</b>	RALL
PPDU power	RPPower
Crest factor	RCFactor
Center frequency error	RCError
Symbol clock error	RSError
Common phase error	RCPerror
MIMO cross power	RMCPower
MIMO channel power	RMCHpower
<b>Bitstream ("Stream All")</b>	SALL
Pilot bit error rate	BPILot
EVM all carriers	SEACarriers
EVM data carriers	SEDCarriers
EVM pilot carriers	SEPCarriers
Only available for <b>IEEE 802.11b and g</b> :	
Peak vector error	PVERror
PPDU EVM	PEVM
I/Q offset	GIOFset
Gain imbalance	GGIMbalance
Quadrature error	QERRor
Center frequency error	GCFerror
Chip clock error	CCERRor
Rise time	RTIME
Fall time	FTIME
Mean power	MPOWER
Peak power	PPOWER
Crest factor	GCFactor

**Table 10-10: Parameters for the items of the "Result Summary Global"**

Result in table	SCPI parameter
Pilot bit error rate	PBERate
EVM all carriers	EACarriers

Result in table	SCPI parameter
EVM data carriers	EDCarriers
EVM pilot carriers	EPCarriers
Center frequency error	CFERror
Symbol clock error	SCERror

#### 10.7.4 Configuring the spectrum flatness and group delay result displays

The following command is only relevant for the "Spectrum Flatness" and "Group Delay" result displays.

---

**CONFigure:BURSt:SPECTrum:FLATness:CSElect** <ChannelType>

This remote control command configures the "Spectrum Flatness" and "Group Delay" results to be based on either effective or physical channels. This command is only valid for IEEE 802.11n and IEEE 802.11ac standards.

While the physical channels cannot always be determined, the effective channel can always be estimated from the known training fields. Thus, for some PPDU or measurement scenarios, only the results based on the mapping of the space-time stream to the Rx antenna (effective channel) are available, as the mapping of the Rx antennas to the Tx antennas (physical channel) could not be determined.

For more information see [Chapter 4.3.3, "Physical vs effective channels"](#), on page 80.

**Parameters:**

<ChannelType>      EFFective | PHYSical  
 \*RST:              EFF

**Example:**

```
CONF:BURSt:SPECTrum:FLAT:CSEL PHYS
```

Configures the "Spectrum Flatness" and "Group Delay" result displays to calculate the results based on the physical channel.

**Manual operation:** See ["Result based on"](#) on page 191

---

**UNIT:SFLatness** <Unit>

Switches between relative (dB) and absolute (dBm) results for "Spectrum Flatness" results (see ["Spectrum Flatness"](#) on page 54).

**Parameters:**

<Unit>              DB | DBM  
 \*RST:              DBM

**Example:**

```
UNIT:SFL DBM
```

**Manual operation:** See ["Units"](#) on page 191



## 10.7.5 Configuring the AM/AM result display

The following commands are only relevant for the "AM/AM" result display.

---

### CONFigure:BURSt:AM:AM:POLYnomial <Degree>

This remote control command specifies the degree of the polynomial regression model used to determine the "AM/AM" result display.

The resulting coefficients of the regression polynomial can be queried using the [FETCh:BURSt:AM:AM:COEFicients?](#) command.

#### Parameters:

<Degree> integer  
 Range: 1 to 20  
 \*RST: 4

**Example:** CONF:BURSt:AM:AM:POLY 3

**Manual operation:** See ["AM/AM"](#) on page 28  
 See ["Polynomial degree for curve fitting"](#) on page 192

---

### DISPlay[:WINDow<n>]:TRACe<t>:X[:SCALe]:AUTO <State>

### DISPlay[:WINDow<n>]:TRACe<t>:Y[:SCALe]:AUTO <Auto>

Activates or deactivates automatic scaling of the x-axis or y-axis for the specified trace display.

#### Suffix:

<n> 1..n  
[Window](#)  
 <t> 1..n  
[Trace](#)

#### Parameters:

<Auto> ON | OFF | 0 | 1

#### OFF | 0

The x-axis or y-axis is scaled according to the specified minimum/maximum values (see [DISPlay\[:WINDow<n>\]:TRACe<t>:Y\[:SCALe\]:MINimum](#)/[DISPlay\[:WINDow<n>\]:TRACe<t>:Y\[:SCALe\]:MAXimum](#)) and number of divisions (see [DISPlay\[:WINDow<n>\]:TRACe<t>:Y\[:SCALe\]:DIVisions](#)).

#### ON | 1

The R&S FSW WLAN application automatically scales the x-axis or y-axis to best fit the measurement results.

\*RST: 1

**Example:** DISP:WIND2:TRAC:Y:SCAL:AUTO ON

**Manual operation:** See ["Automatic Grid Scaling"](#) on page 193

---

**DISPlay[:WINDow<n>]:TRACe<t>:X[:SCALe]:AUTO:FIXed:RANGe**  
<AutoFixRange>

**DISPlay[:WINDow<n>]:TRACe<t>:Y[:SCALe]:AUTO:FIXed:RANGe**  
<AutoFixRange>

Defines the use of fixed value limits.

**Suffix:**

<n> [Window](#)

<t> [Trace](#)

**Parameters:**

<AutoFixRange> NONE | LOWer | UPPer

**NONE**

Both the upper and lower limits are determined by automatic scaling of the x-axis or y-axis.

**LOWer**

The lower limit is fixed (defined by `DISPlay[:WINDow<n>]:TRACe<t>:Y[:SCALe]:MINimum/DISPlay[:WINDow<n>]:TRACe<t>:Y[:SCALe]:MAXimum`), while the upper limit is determined by automatic scaling of the x-axis or y-axis.

**UPPer**

The upper limit is fixed, while the lower limit is determined by automatic scaling of the x-axis or y-axis.

**Example:**

`DISP:WIND1:TRAC:Y:AUTO:FIX:RANG LOW`

`DISP:WIND1:TRAC:Y:MIN 0dBm`

Sets the lower limit of the y-axis to a fixed value of 0 dBm.

**Manual operation:** See ["Auto Fix Range"](#) on page 194

---

**DISPlay[:WINDow<n>]:TRACe<t>:X[:SCALe]:AUTO:HYSTEResis:LOWer:UPPer**  
<Value>

**DISPlay[:WINDow<n>]:TRACe<t>:Y[:SCALe]:AUTO:HYSTEResis:LOWer:UPPer**  
<Value>

For automatic scaling based on hysteresis, this command defines the upper limit of the lower hysteresis interval.

If the minimum value in the current measurement exceeds this limit, the x-axis or y-axis is rescaled automatically.

For details see ["Hysteresis Interval Upper/Lower"](#) on page 194.

**Suffix:**

<n> [Window](#)

<t> [Trace](#)

**Parameters:**

<Value> numeric value

Percentage of the currently displayed value range on the x-axis or y-axis.

**Example:** `DISP:WIND2:TRAC:Y:SCAL:AUTO:HYST:LOW:UPP 5`

**Manual operation:** See "[Hysteresis Interval Upper/Lower](#)" on page 194

**DISPlay[:WINDow<n>]:TRACe<t>:X[:SCALe]:AUTO:HYSTeresis:LOWer:LOWer**  
<Value>

**DISPlay[:WINDow<n>]:TRACe<t>:Y[:SCALe]:AUTO:HYSTeresis:LOWer:LOWer**  
<Value>

For automatic scaling based on hysteresis, this command defines the lower limit of the lower hysteresis interval.

If the minimum value in the current measurement drops below this limit, the x-axis or y-axis is rescaled automatically.

For details see "[Hysteresis Interval Upper/Lower](#)" on page 194.

**Suffix:**

<n> [Window](#)

<t> [Trace](#)

**Parameters:**

<Value> numeric value  
Percentage of the currently displayed value range on the x-axis or y-axis.

**Example:** `DISP:WIND2:TRAC:Y:SCAL:AUTO:HYST:LOW:LOW 5`

**Manual operation:** See "[Hysteresis Interval Upper/Lower](#)" on page 194

**DISPlay[:WINDow<n>]:TRACe<t>:X[:SCALe]:AUTO:HYSTeresis:UPPer:LOWer**  
<Value>

**DISPlay[:WINDow<n>]:TRACe<t>:Y[:SCALe]:AUTO:HYSTeresis:UPPer:LOWer**  
<Value>

For automatic scaling based on hysteresis, this command defines the lower limit of the upper hysteresis interval.

If the maximum value in the current measurement drops below this limit, the x-axis or y-axis is rescaled automatically.

For details see "[Hysteresis Interval Upper/Lower](#)" on page 194.

**Suffix:**

<n> [Window](#)

<t> [Trace](#)

**Parameters:**

<Value> numeric value  
Percentage of the currently displayed value range on the x-axis or y-axis.

**Example:** `DISP:WIND2:TRAC:Y:AUTO:HYST:UPP:LOW 25`

**Manual operation:** See ["Hysteresis Interval Upper/Lower"](#) on page 194

---

**DISPlay[:WINDow<n>]:TRACe<t>:X[:SCALe]:AUTO:HYSTerisis:UPPer:UPPer**  
<Value>

**DISPlay[:WINDow<n>]:TRACe<t>:Y[:SCALe]:AUTO:HYSTerisis:UPPer:UPPer**  
<Value>

For automatic scaling based on hysteresis, this command defines the upper limit of the upper hysteresis interval.

If the maximum value in the current measurement exceeds this limit, the x-axis or y-axis is rescaled automatically.

For details see ["Hysteresis Interval Upper/Lower"](#) on page 194.

**Suffix:**

<n> [Window](#)

<t> [Trace](#)

**Parameters:**

<Value> numeric value  
Percentage of the currently displayed value range on the x-axis or y-axis.

**Example:** `DISP:WIND2:TRAC:Y:AUTO:HYST:UPP:UPP 20`

**Manual operation:** See ["Hysteresis Interval Upper/Lower"](#) on page 194

---

**DISPlay[:WINDow<n>]:TRACe<t>:X[:SCALe]:AUTO:MEMory:DEPTh <NoMeas>**  
**DISPlay[:WINDow<n>]:TRACe<t>:Y[:SCALe]:AUTO:MEMory:DEPTh <NoMeas>**

For automatic scaling based on memory, this value defines the number <x> of previous results to be considered when determining if rescaling is required.

The minimum and maximum value of each measurement are added to the memory. After <x> measurements, the oldest results in the memory are overwritten by each new measurement.

For details see ["Auto Mode"](#) on page 194.

**Suffix:**

<n> [Window](#)

<t> [Trace](#)

**Parameters:**

<NoMeas> integer value  
Number of measurement results to be stored for autoscaling

**Example:** `DISP:WIND2:TRAC:Y:AUTO:MEM:DEPT 16`

**Manual operation:** See ["Memory Depth"](#) on page 195

---

**DISPlay[:WINDow<n>]:TRACe<t>:X[:SCALe]:AUTO:MODE <AutoMode>**

**DISPlay[:WINDow<n>]:TRACe<t>:Y[:SCALe]:AUTO:MODE <AutoMode>**

Determines which algorithm is used to determine whether the x-axis or y-axis requires automatic rescaling.

**Suffix:**

<n> 1..n  
Window

<t> 1..n  
Trace

**Parameters:**

<AutoMode>

**HYSTeresis**

If the minimum and/or maximum values of the current measurement exceed a specific value range (hysteresis interval), the axis is rescaled. The hysteresis interval is defined as a percentage of the currently displayed value range on the x-axis or y-axis. An upper hysteresis interval is defined for the maximum value, a lower hysteresis interval is defined for the minimum value.

**MEMory**

If the minimum and/or maximum values of the current measurement exceed the minimum and/or maximum of the <x> previous results, the axis is rescaled.

The minimum and maximum value of each measurement are added to the memory. After <x> measurements, the oldest results in the memory are overwritten by each new measurement.

The number of results in the memory to be considered is configurable (see [DISPlay\[:WINDow<n>\]:TRACe<t>:Y\[:SCALe\]:AUTO:MEMory:DEPTh](#)).

\*RST: HYSTeresis

**Example:**

DISP:WIND2:TRAC:Y:AUTO:MODE MEM

**Manual operation:** See ["Auto Mode"](#) on page 194

---

**DISPlay[:WINDow<n>]:TRACe<t>:X[:SCALe]:DIVisions <NoDivisions>**

**DISPlay[:WINDow<n>]:TRACe<t>:Y[:SCALe]:DIVisions <Divisions>**

Defines the number of divisions to be used for the x-axis or y-axis in the specified window.

Separate division settings can be configured for individual result displays.

**Suffix:**

<n> 1..n  
Window

<t> 1..n  
Trace

**Parameters:**

<Divisions> integer

**Example:**

DISP:WIND2:TRAC:Y:SCAL:DIV 10

**Manual operation:** See ["Number of Divisions"](#) on page 196

**DISPlay[:WINDow<n>]:TRACe<t>:X[:SCALe]:MAXimum <Max>**

**DISPlay[:WINDow<n>]:TRACe<t>:Y[:SCALe]:MAXimum <Max>**

Defines the maximum value to be displayed on the x-axis or y-axis of the specified evaluation diagram.

For automatic scaling with a fixed range (see [DISPlay\[:WINDow<n>\]:TRACe<t>:Y\[:SCALe\]:AUTO:FIXed:RANGe](#) on page 362), the maximum defines the fixed upper limit.

**Suffix:**

<n> 1..n  
[Window](#)

<t> 1..n  
[Trace](#)

**Parameters:**

<Max> numeric value

**Example:**

DISP:WIND2:TRAC:Y:SCAL:MAX 100

**Manual operation:** See ["Minimum / Maximum"](#) on page 195

**DISPlay[:WINDow<n>]:TRACe<t>:X[:SCALe]:MINimum <Min>**

**DISPlay[:WINDow<n>]:TRACe<t>:Y[:SCALe]:MINimum <Min>**

Defines the minimum value to be displayed on the x-axis or y-axis of the specified evaluation diagram.

For automatic scaling with a fixed range (see [DISPlay\[:WINDow<n>\]:TRACe<t>:Y\[:SCALe\]:AUTO:FIXed:RANGe](#) on page 362), the minimum defines the fixed lower limit.

**Suffix:**

<n> 1..n  
[Window](#)

<t> 1..n  
[Trace](#)

**Parameters:**

<Min> numeric value

**Example:**

DISP:WIND2:TRAC:Y:SCAL:MIN -20

**Manual operation:** See ["Minimum / Maximum"](#) on page 195

---

**DISPlay[:WINDow<n>]:TRACe<t>:X[:SCALe]:PDIVision <Multiple>[,<Multiple>]**  
**DISPlay[:WINDow<n>]:TRACe<t>:Y[:SCALe]:PDIVision <Multiple>[,<Multiple>]**

Determines the values shown for each division on the x-axis or y-axis in the specified window.

One or more multiples of  $10^n$  can be selected. The R&S FSW WLAN application then selects the optimal scaling from the selected values.

For details see "[Scaling per division](#)" on page 196.

**Suffix:**

<n> [Window](#)

<t> [Trace](#)

**Parameters:**

<Multiple> 1.0 | 2.0 | 2.5 | 5.0

Each division on the x-axis or y-axis displays the selected multiple of  $10^n$ .

\*RST: 1.0,5.0

**Example:**

DISP:WIND:TRAC:Y:SCAL:PDIV 2.0,2.5

Multiples of  $2.0 \cdot 10^n$  or multiples of  $2.5 \cdot 10^n$  are displayed on the x-axis or y-axis.

**Manual operation:** See "[Scaling per division](#)" on page 196

## 10.7.6 Configuring constellation diagrams

---

**CONFigure:BURSt:CONSt:CARRier:SElect <Carriers>**

Defines the carriers included in the constellation diagram.

**Parameters:**

<Carriers> **ALL**  
Results for all carriers

**PILots**  
Results for pilot carriers only

<integer>  
Specific carrier number only

**Example:** CONF:BURS:CONS:CARR:SEL 4

## 10.8 Starting a measurement

When a WLAN measurement channel is activated on the FSW, a WLAN IQ measurement (Modulation Accuracy, Flatness and Tolerance, see [Chapter 3.1, "WLAN I/Q measurement \(modulation accuracy, flatness and tolerance\)"](#), on page 15), is started immediately. However, you can stop and start a new measurement any time.

Furthermore, you can perform a sequence of measurements using the Sequencer (see [Chapter 5.1, "Multiple measurement channels and sequencer function"](#), on page 105).

ABORt.....	368
CALCulate<n>:BURSt[:IMMEDIATE].....	369
INITiate<n>:CONTinuous.....	369
INITiate<n>[:IMMEDIATE].....	369
INITiate:SEQuencer:ABORt.....	370
INITiate:SEQuencer:IMMEDIATE.....	370
INITiate:SEQuencer:MODE.....	370
INITiate:SEQuencer:REFresh[:ALL].....	371
SYSTem:SEQuencer.....	371

## ABORt

Aborts the measurement in the current channel and resets the trigger system.

To prevent overlapping execution of the subsequent command before the measurement has been aborted successfully, use the `*OPC?` or `*WAI` command after `ABOR` and before the next command.

For details on overlapping execution see [Remote control via SCPI](#).

To abort a sequence of measurements by the Sequencer, use the `INITiate:SEQuencer:ABORt` command.

### Note on blocked remote control programs:

If a sequential command cannot be completed, for example because a triggered sweep never receives a trigger, the remote control program will never finish and the remote channel to the FSW is blocked for further commands. In this case, you must interrupt processing on the remote channel first in order to abort the measurement.

To do so, send a "Device Clear" command from the control instrument to the FSW on a parallel channel to clear all currently active remote channels. Depending on the used interface and protocol, send the following commands:

- **Visa:** `viClear()`
- **GPIB:** `ibclr()`
- **RSIB:** `RSDLLibclr()`

Now you can send the `ABORt` command on the remote channel performing the measurement.

**Example:** `ABOR; :INIT:IMM`  
Aborts the current measurement and immediately starts a new one.

**Example:** `ABOR; *WAI`  
`INIT:IMM`  
Aborts the current measurement and starts a new one once abortion has been completed.

**Usage:** Event



**CALCulate<n>:BURSt[:IMMEDIATE]**

Forces the IQ measurement results to be recalculated according to the current settings.

**Suffix:**

<n> 1..n  
Window

**Manual operation:** See "[Calc Results](#)" on page 144

**INITiate<n>:CONTinuous <State>**

Controls the measurement mode for an individual channel.

Note that in single measurement mode, you can synchronize to the end of the measurement with \*OPC, \*OPC? or \*WAI. In continuous measurement mode, synchronization to the end of the measurement is not possible. Thus, it is not recommended that you use continuous measurement mode in remote control, as results like trace data or markers are only valid after a single measurement end synchronization.

For details on synchronization see [Remote control via SCPI](#).

If the measurement mode is changed for a channel while the Sequencer is active (see [INITiate:SEQuencer:IMMEDIATE](#) on page 370), the mode is only considered the next time the measurement in that channel is activated by the Sequencer.

**Suffix:**

<n> irrelevant

**Parameters:**

<State> ON | OFF | 0 | 1  
**ON | 1**  
Continuous measurement  
**OFF | 0**  
Single measurement  
\*RST: 1 (some applications can differ)

**Example:**

```
INIT:CONT OFF
Switches the measurement mode to single measurement.
INIT:CONT ON
Switches the measurement mode to continuous measurement.
```

**Manual operation:** See "[Continuous Sweep / Run Cont](#)" on page 198

**INITiate<n>[:IMMEDIATE]**

Starts a (single) new measurement.

You can synchronize to the end of the measurement with \*OPC, \*OPC? or \*WAI.

For details on synchronization see [Remote control via SCPI](#).

<b>Suffix:</b>	<n>	irrelevant
<b>Usage:</b>		Asynchronous command
<b>Manual operation:</b>		See "Single / Cont." on page 144 See "Single Sweep / Run Single" on page 198

**INITiate:SEQuencer:ABORt**

Stops the currently active sequence of measurements.

You can start a new sequence any time using `INITiate:SEQuencer:IMMediate` on page 370.

<b>Usage:</b>	Event
<b>Manual operation:</b>	See "Sequencer State" on page 106

**INITiate:SEQuencer:IMMediate**

Starts a new sequence of measurements by the Sequencer.

Its effect is similar to the `INITiate<n>[:IMMediate]` command used for a single measurement.

Before this command can be executed, the Sequencer must be activated (see `SYSTem:SEQuencer` on page 371).

<b>Example:</b>	<code>SYST:SEQ ON</code> Activates the Sequencer.
	<code>INIT:SEQ:MODE SING</code> Sets single sequence mode so each active measurement is performed once.
	<code>INIT:SEQ:IMM</code> Starts the sequential measurements.

<b>Manual operation:</b>	See "Sequencer State" on page 106
--------------------------	-----------------------------------

**INITiate:SEQuencer:MODE <Mode>**

Defines the capture mode for the entire measurement sequence and all measurement groups and channels it contains.

**Note:** To synchronize to the end of a measurement sequence using `*OPC`, `*OPC?` or `*WAI`, use `SINGle` Sequencer mode.

<b>Parameters:</b>	
<Mode>	<b>SINGle</b> Each measurement group is started one after the other in the order of definition. All measurement channels in a group are started simultaneously and performed once. After <i>all</i> measurements are completed, the next group is started. After the last group, the measurement sequence is finished.

**CONTInuous**

Each measurement group is started one after the other in the order of definition. All measurement channels in a group are started simultaneously and performed once. After *all* measurements are completed, the next group is started. After the last group, the measurement sequence restarts with the first one and continues until it is stopped explicitly.

\*RST: CONTInuous

**Manual operation:** See "[Sequencer Mode](#)" on page 106

**INITiate:SEQuencer:REFResh[:ALL]**

Is only available if the Sequencer is deactivated (`SYSTem:SEQuencer SYST:SEQ:OFF`) and only in MSRA mode.

The data in the capture buffer is re-evaluated by all active MSRA secondary applications.

**Example:**

`SYST:SEQ:OFF`

Deactivates the scheduler

`INIT:CONT OFF`

Switches to single sweep mode.

`INIT;*WAI`

Starts a new data measurement and waits for the end of the sweep.

`INIT:SEQ:REFR`

Refreshes the display for all channels.

**SYSTem:SEQuencer <State>**

Turns the Sequencer on and off. The Sequencer must be active before any other Sequencer commands (`INIT:SEQ. . .`) are executed, otherwise an error occurs.

A detailed programming example is provided in the "Operating Modes" chapter in the FSW User Manual.

**Parameters:**

<State> ON | OFF | 0 | 1

**ON | 1**

The Sequencer is activated and a sequential measurement is started immediately.

**OFF | 0**

The Sequencer is deactivated. Any running sequential measurements are stopped. Further Sequencer commands (`INIT:SEQ. . .`) are not available.

\*RST: 0

**Example:**

```

SYST:SEQ ON
Activates the Sequencer.
INIT:SEQ:MODE SING
Sets single Sequencer mode so each active measurement is
performed once.
INIT:SEQ:IMM
Starts the sequential measurements.
SYST:SEQ OFF

```

**Manual operation:** See "[Sequencer State](#)" on page 106

## 10.9 Retrieving results

The following commands are required to retrieve the results from a WLAN measurement in a remote environment.



Before retrieving measurement results, check if PPDU synchronization was successful or not by checking the status register (see [Chapter 10.11.1, "The STATUS:QUESTIONABLE:SYNC register"](#), on page 430). If no PPDUs were found, `STAT:QUES:SYNC:COND?` returns 0 (see [STATUS:QUESTIONABLE:SYNC:CONDition?](#) on page 435).



The `*OPC` command should be used after commands that retrieve data so that subsequent commands to change the trigger or data capturing settings are held off until after the data capture is completed and the data has been returned.

- [Numeric modulation accuracy, flatness and tolerance results](#)..... 372
- [Numeric results for frequency sweep measurements](#)..... 401
- [Retrieving trace results](#)..... 406
- [Measurement results for TRACe<n>\[:DATA\]? TRACE<n>](#)..... 410
- [Retrieving captured I/Q data](#)..... 422
- [Importing and exporting I/Q data and results](#)..... 423
- [Exporting trace results](#)..... 426

### 10.9.1 Numeric modulation accuracy, flatness and tolerance results

The following commands describe how to retrieve the numeric results from the standard WLAN measurements.



The commands to retrieve results from frequency sweep measurements for WLAN signals are described in [Chapter 10.9.2, "Numeric results for frequency sweep measurements"](#), on page 401.

- [PPDU and symbol count results](#)..... 373
- [Error parameter results](#)..... 376
- [Limit check results](#).....393

### 10.9.1.1 PPDU and symbol count results

The following commands are required to retrieve PPDU and symbol count results from the WLAN IQ measurement on the captured I/Q data (see [Chapter 3.1.1, "Modulation accuracy, flatness and tolerance parameters"](#), on page 15).

<a href="#">FETCh:BURSt:COUNT?</a> .....	373
<a href="#">FETCh:BURSt:COUNT:ALL?</a> .....	373
<a href="#">FETCh:SYMBol:COUNT?</a> .....	373
<a href="#">FETCh:BURSt:GINTerval?</a> .....	374
<a href="#">FETCh:BURSt:LENGthS?</a> .....	374
<a href="#">FETCh:BURSt:MCSindex?</a> .....	374
<a href="#">FETCh:BURSt:PPDU:STATus?</a> .....	375
<a href="#">FETCh:BURSt:PPDU:TYPE?</a> .....	375
<a href="#">FETCh:BURSt:STARts?</a> .....	375
<a href="#">UNIT:BURSt</a> .....	376

---

#### FETCh:BURSt:COUNT?

Returns the number of analyzed PPDU's from the current capture buffer. If multiple measurements are required because the number of PPDU's to analyze is greater than the number of PPDU's that can be captured in one buffer, this command only returns the number of captured PPDU's *in the current capture buffer* (as opposed to [FETCh: BURSt: COUNT: ALL?](#)).

**Return values:**

<PPDUCount>

**Usage:**                      Query only

---

#### FETCh:BURSt:COUNT:ALL?

Returns the number of analyzed PPDU's for the entire measurement. If multiple measurements are required because the number of PPDU's to analyze is greater than the number of PPDU's that can be captured in one buffer, this command returns the number of analyzed PPDU's in *all* measurements (as opposed to [FETCh: BURSt: COUNT?](#)).

**Return values:**

<PPDUCount>

**Usage:**                      Query only

---

#### FETCh:SYMBol:COUNT?

Returns the number of symbols in each analyzed PPDU as a comma-separated list. The length of the list corresponds to the number of PPDU's, i.e. the result of [FETCh: BURSt: COUNT: ALL?](#).

**Return values:**

&lt;Result&gt; &lt;list&gt;

**Usage:** Query only**FETCh:BURSt:GINterval?**

Queries the guard interval of the first analyzed PPDU.

**Return values:**

&lt;GuardInterval&gt; Guard interval in microseconds.

**Example:** FETC:BURS:GINT?  
//Result: '24'**Usage:** Query only**FETCh:BURSt:LENGths?**Returns the length of the analyzed PPDU's from the current measurement. If the number of PPDU's to analyze is greater than the number of PPDU's that can be captured in one buffer, this command only returns the lengths of the PPDU's *in the current capture buffer*.

The result is a comma-separated list of lengths, one for each PPDU.

**Return values:**<PPDULength> Length of the PPDU in the unit specified by the [UNIT:BURSt](#) command.

Tip: To obtain the result in seconds, divide the number of samples by the input sample rate. This value is indicated as "Sample Rate Fs" in the channel bar.

**Example:** UNIT:BURS SAMP  
FETC:BURS:LENG?  
//Result: 39,39,39  
Result in seconds for an input sample rate of 40 MHz:  
0.001 ms**Usage:** Query only**FETCh:BURSt:MCSindex?**

Queries the Modulation and Coding Scheme (MCS) index of the first analyzed PPDU.

**Return values:**

&lt;MCSIndex&gt;

**Example:** SENS:DEM:FORM:MCS 1  
FETC:BURS:MCS?  
//Result: '1'**Usage:** Query only

---

**FETCh:BURSt:PPDU:STATus?**

Queries the status of the analyzed PPDU in the current capture buffer (see [FETCh: BURSt: COUNt?](#) on page 373).

**Return values:**

<Result> Comma-separated list of values; one value for each analyzed PPDU

**OK**

Analysis correct

**WARN**

Warning, an error occurred

**SEL**

Selected PPDU

**Example:**

```
FETC:BURS:COUN?
//Result: 3
FETCh:BURSt:PPDU:STATus?
OK,OK,OK
```

**Usage:**

Query only

---

**FETCh:BURSt:PPDU:TYPE?**

Queries the type of the first analyzed PPDU in the current capture buffer.

**Return values:**

<PPDUType> See [Table 4-3](#).

**Example:**

```
SENS:DEM:FORM:BAN:BTYP 'OFDM'
FETC:BURS:PPDU:TYPE?
//Result: 'OFDM'
```

**Usage:**

Query only

---

**FETCh:BURSt:STARts?**

Returns the start position of each analyzed PPDU in the current capture buffer.

**Return values:**

<Position> <list>

Comma-separated list of sample numbers indicating the start position of each PPDU.

Tip: To obtain the result in seconds, divide the sample number by the input sample rate. This value is indicated as "Sample Rate Fs" in the channel bar.

**Example:**

```
FETC:BURS:STAR?
//Result: 6922,17962,29002
Result in seconds for an input sample rate of 40 MHz:
0.17 ms, 0.45 ms, 0.73 ms
```

**Usage:** Query only

---

**UNIT:BURSt** <Unit>

Specifies the units for PPDU length results (see [FETCh:BURSt:LENGths?](#) on page 374).

**Parameters:**

<Unit> SYMBol | SAMPlE

**SYMBol**

Number of OFDM data symbols for each analyzed PPDU. Pre-amble symbols are NOT included.

**SAMPlE**

Number of samples each analyzed PPDU contains.

Tip: To obtain the result in seconds, divide the number of samples by the input sample rate. This value is indicated as "Sample Rate Fs" in the channel bar.

\*RST: SYMBol

**Example:**

```
UNIT:BURSt SAMP
```

```
FETCh:BURSt:LENG?
```

```
//Result: 39,39,39
```

Result in seconds for an input sample rate of 40 MHz:

0.001 ms

### 10.9.1.2 Error parameter results

The following commands are required to retrieve individual results from the WLAN IQ measurement on the captured I/Q data (see [Chapter 3.1.1, "Modulation accuracy, flatness and tolerance parameters"](#), on page 15).

<a href="#">FETCh:BURSt:ALL:FORMatted?</a> .....	378
<a href="#">FETCh:BURSt:AM:AM:COEFicients?</a> .....	379
<a href="#">FETCh:BURSt:BERPilot:AVERage?</a> .....	379
<a href="#">FETCh:BURSt:BERPilot:MAXimum?</a> .....	379
<a href="#">FETCh:BURSt:BERPilot:MINimum?</a> .....	379
<a href="#">FETCh:BURSt:CPERror:AVERage?</a> .....	379
<a href="#">FETCh:BURSt:CPERror:MAXimum?</a> .....	379
<a href="#">FETCh:BURSt:CPERror:MINimum?</a> .....	379
<a href="#">FETCh:BURSt:CRESt[:AVERage]?</a> .....	380
<a href="#">FETCh:BURSt:CRESt:MAXimum?</a> .....	380
<a href="#">FETCh:BURSt:CRESt:MINimum?</a> .....	380
<a href="#">FETCh:BURSt:ECMGain?</a> .....	380
<a href="#">FETCh:BURSt:PCMGain?</a> .....	380
<a href="#">FETCh:BURSt:EVM:ALL:AVERage?</a> .....	381
<a href="#">FETCh:BURSt:EVM:ALL:MAXimum?</a> .....	381
<a href="#">FETCh:BURSt:EVM:ALL:MINimum?</a> .....	381
<a href="#">FETCh:BURSt:EVM:DATA:AVERage?</a> .....	381
<a href="#">FETCh:BURSt:EVM:DATA:MAXimum?</a> .....	381
<a href="#">FETCh:BURSt:EVM:DATA:MINimum?</a> .....	381



FETCh:BURSt:EVM:DIRect:AVERage?	381
FETCh:BURSt:EVM:DIRect:MAXimum?	381
FETCh:BURSt:EVM:DIRect:MINimum?	381
FETCh:BURSt:EVM:PILot:AVERage?	381
FETCh:BURSt:EVM:PILot:MAXimum?	381
FETCh:BURSt:EVM:PILot:MINimum?	381
FETCh:BURSt:EVM[:IEEE]:AVERage?	382
FETCh:BURSt:EVM[:IEEE]:MAXimum?	382
FETCh:BURSt:EVM[:IEEE]:MINimum?	382
FETCh:BURSt:CFERror:AVERage?	382
FETCh:BURSt:CFERror:MAXimum?	382
FETCh:BURSt:CFERror:MINimum?	382
FETCh:BURSt:FERRor:AVERage?	382
FETCh:BURSt:FERRor:MAXimum?	382
FETCh:BURSt:FERRor:MINimum?	382
FETCh:BURSt:GIMBalance:AVERage?	382
FETCh:BURSt:GIMBalance:MAXimum?	382
FETCh:BURSt:GIMBalance:MINimum?	382
FETCh:BURSt:IQOFset:AVERage?	382
FETCh:BURSt:IQOFset:MAXimum?	382
FETCh:BURSt:IQOFset:MINimum?	382
FETCh:BURSt:IQSKew:AVERage?	383
FETCh:BURSt:IQSKew:MAXimum?	383
FETCh:BURSt:IQSKew:MINimum?	383
FETCh:BURSt:MCPower:AVERage?	383
FETCh:BURSt:MCPower:MAXimum?	383
FETCh:BURSt:MCPower:MINimum?	383
FETCh:BURSt:MCHPower:AVERage?	383
FETCh:BURSt:MCHPower:MAXimum?	383
FETCh:BURSt:MCHPower:MINimum?	383
FETCh:BURSt:PAYLoad[:AVERage]?	383
FETCh:BURSt:PAYLoad:MINimum?	383
FETCh:BURSt:PAYLoad:MAXimum?	383
FETCh:BURSt:PEAK[:AVERage]?	384
FETCh:BURSt:PEAK:MINimum?	384
FETCh:BURSt:PEAK:MAXimum?	384
FETCh:BURSt:PREamble[:AVERage]?	384
FETCh:BURSt:PREamble:MAXimum?	384
FETCh:BURSt:PREamble:MINimum?	384
FETCh:BURSt:QUADoffset:AVERage?	384
FETCh:BURSt:QUADoffset:MAXimum?	384
FETCh:BURSt:QUADoffset:MINimum?	384
FETCh:BURSt:RMS[:AVERage]?	384
FETCh:BURSt:RMS:MAXimum?	384
FETCh:BURSt:RMS:MINimum?	384
FETCh:BURSt:SYMBolerror:AVERage?	385
FETCh:BURSt:SYMBolerror:MAXimum?	385
FETCh:BURSt:SYMBolerror:MINimum?	385
FETCh:BURSt:TFALI:AVERage?	385
FETCh:BURSt:TFALI:MAXimum?	385

FETCh:BURSt:TFAL:MINimum?	385
FETCh:BURSt:TRISe:AVERAge?	385
FETCh:BURSt:TRISe:MAXimum?	385
FETCh:BURSt:TRISe:MINimum?	385
FETCh:BURSt:PPDU:EVM:ALL:AVERAge?	386
FETCh:BURSt:PPDU:EVM:DATA:AVERAge?	386
FETCh:BURSt:PPDU:EVM:PILot:AVERAge?	386
FETCh:SCDetailed:ALL?	386
FETCh:SCDetailed:EVM:ALL?	388
FETCh:SCDetailed:EVM:DATA?	388
FETCh:SCDetailed:EVM:PILot?	388
FETCh:SCDetailed:POWer:PPDU?	389
FETCh:SCDetailed:POWer:RU?	389
FETCh:SCDetailed:POWer[:SC]?	390
FETCh:SFIeld:ALL?	390
FETCh:SFSummary:ALL?	391
FETCh:UTESummary:ALL?	392
UNIT:EVM	393
UNIT:GIMBalance	393
UNIT:PREamble	393

---

#### FETCh:BURSt:ALL:FORMatted?

Returns all results from the default WLAN measurement (Modulation Accuracy, Flatness and Tolerance).

For details see [Chapter 3.1.1, "Modulation accuracy, flatness and tolerance parameters"](#), on page 15.

The results are output as a list of result strings separated by commas in ASCII format. The results are output in the following order:

<Global Result>, <Stream 1 result> ... <Stream n result>

#### Return values:

```
<GlobalResult>      <list>
                    <preamble power>, <payload power>, <peak power>,
                    'nan','nan','nan',
                    'nan','nan','nan',
                    <min freq error>,<avg freq error>, <max freq error>,
                    <min symbol error>, <avg symbol error>, <max symbol error>,
                    'nan','nan','nan',
                    'nan','nan','nan',
                    'nan','nan','nan',
                    <min EVM all>, <avg EVM all>, <max EVM all>,
                    <min EVM data>, <avg EVM data >, <max EVM data>
                    <min EVM pilots>, <avg EVM pilots >, <max EVM pilots>
                    'nan','nan','nan',
                    'nan','nan','nan',
                    'nan','nan','nan',
                    'nan','nan','nan',
```

- Example:** `FETC:BURS:ALL:FORM?`  
 For sample results see ["Example of results from a WLAN 802.11 MIMO measurement"](#) on page 443.
- Usage:** Query only
- Manual operation:** See ["Result Summary Detailed"](#) on page 47  
 See ["Result Summary Global"](#) on page 49

#### FETCh:BURSt:AM:AM:COEFicients?

This remote control returns the coefficients of the polynomial regression model used to determine the "AM/AM" result display.

See ["AM/AM"](#) on page 28 for details.

**Return values:**  
 <Coefficients>

**Example:** `FETC:BURS:AM:AM:COEF?`

**Usage:** Query only

**Manual operation:** See ["Polynomial degree for curve fitting"](#) on page 192

#### FETCh:BURSt:BERPilot:AVERAge?

#### FETCh:BURSt:BERPilot:MAXimum?

#### FETCh:BURSt:BERPilot:MINimum?

Returns the Bit Error Rate (BER) for Pilots (average, maximum or minimum value) in % for the IEEE 802.11n (MIMO) standard. For details see [Chapter 3.1.1, "Modulation accuracy, flatness and tolerance parameters"](#), on page 15.

**Return values:**  
 <Result> <Global Result>, <Stream 1 result> ... <Stream n result>

**Usage:** Query only

#### FETCh:BURSt:CPERror:AVERAge?

#### FETCh:BURSt:CPERror:MAXimum?

#### FETCh:BURSt:CPERror:MINimum?

Returns the common phase error (average, maximum or minimum value) in degrees for the IEEE 802.11n (MIMO) standard. For details see [Chapter 3.1.1, "Modulation accuracy, flatness and tolerance parameters"](#), on page 15.

**Return values:**  
 <Result> <Stream 1 result> ... <Stream n result>

**Usage:** Query only

**FETCh:BURSt:CRESt[:AVERage]?****FETCh:BURSt:CRESt:MAXimum?****FETCh:BURSt:CRESt:MINimum?**

Returns the average, maximum or minimum determined CREST factor (= ratio of peak power to average power) in dB.

For details see [Chapter 3.1.1, "Modulation accuracy, flatness and tolerance parameters"](#), on page 15.

**Return values:**

<Result>                    <list>

**Usage:**                    Query only

**FETCh:BURSt:ECMGain?**

Returns the effective channel gain result which is used as the reference for the "Spectrum Flatness" limits when "Spectrum Flatness" results are based on effective channels (see [CONFigure:BURSt:SPECTrum:FLATness:CSElect](#) on page 360).

For details see [Chapter 3.1.1, "Modulation accuracy, flatness and tolerance parameters"](#), on page 15.

**Return values:**

<Result>                    comma-separated list of values; one value for each RX stream  
Default unit: dBm

**Example:**                    FETC:BURSt:ECMG?

**Usage:**                    Query only

**FETCh:BURSt:PCMGain?**

Returns the physical channel gain result which is used as the reference for the "Spectrum Flatness" limits when "Spectrum Flatness" results are based on physical channels (see [CONFigure:BURSt:SPECTrum:FLATness:CSElect](#) on page 360).

For details see [Chapter 3.1.1, "Modulation accuracy, flatness and tolerance parameters"](#), on page 15.

**Return values:**

<Result>                    comma-separated list of values; one value for each RX stream  
Default unit: dBm

**Example:**                    FETC:BURSt:PCMG?

**Usage:**                    Query only

---

**FETCh:BURSt:EVM:ALL:AVERage?**  
**FETCh:BURSt:EVM:ALL:MAXimum?**  
**FETCh:BURSt:EVM:ALL:MINimum?**

Returns the average, maximum or minimum EVM in dB. This is a combined figure that represents the pilot, data and the free carrier.

For details see [Chapter 3.1.1, "Modulation accuracy, flatness and tolerance parameters"](#), on page 15.

**Return values:**

<Result>                    <Global Result>, <Stream 1 result> ... <Stream n result>

**Usage:**                    Query only

---

**FETCh:BURSt:EVM:DATA:AVERage?**  
**FETCh:BURSt:EVM:DATA:MAXimum?**  
**FETCh:BURSt:EVM:DATA:MINimum?**

Returns the average, maximum or minimum EVM for the data carrier in dB.

For details see [Chapter 3.1.1, "Modulation accuracy, flatness and tolerance parameters"](#), on page 15.

**Return values:**

<Result>                    <Global Result>, <Stream 1 result> ... <Stream n result>

**Usage:**                    Query only

---

**FETCh:BURSt:EVM:DIRect:AVERage?**  
**FETCh:BURSt:EVM:DIRect:MAXimum?**  
**FETCh:BURSt:EVM:DIRect:MINimum?**

Returns the average, maximum or minimum EVM in dB for the IEEE 802.11b standard. This result is the value after filtering.

For details see [Chapter 3.1.1, "Modulation accuracy, flatness and tolerance parameters"](#), on page 15.

**Return values:**

<Result>                    <list>

**Usage:**                    Query only

---

**FETCh:BURSt:EVM:PILot:AVERage?**  
**FETCh:BURSt:EVM:PILot:MAXimum?**  
**FETCh:BURSt:EVM:PILot:MINimum?**

Returns the average, maximum or minimum EVM in dB for the pilot carrier.

For details see [Chapter 3.1.1, "Modulation accuracy, flatness and tolerance parameters"](#), on page 15.

**Return values:**

<Result>                    <Global Result>, <Stream 1 result> ... <Stream n result>

**Usage:** Query only

---

**FETCh:BURSt:EVM[:IEEE]:AVERAge?**  
**FETCh:BURSt:EVM[:IEEE]:MAXimum?**  
**FETCh:BURSt:EVM[:IEEE]:MINimum?**

Returns the average, maximum or minimum EVM in dB for the IEEE 802.11b standard. This result is the value before filtering.

For details see [Chapter 3.1.1, "Modulation accuracy, flatness and tolerance parameters"](#), on page 15.

**Return values:**

<Result> <list>

**Usage:** Query only

---

**FETCh:BURSt:CFERror:AVERAge?**  
**FETCh:BURSt:CFERror:MAXimum?**  
**FETCh:BURSt:CFERror:MINimum?**  
**FETCh:BURSt:FERRor:AVERAge?**  
**FETCh:BURSt:FERRor:MAXimum?**  
**FETCh:BURSt:FERRor:MINimum?**

Returns the average, maximum or minimum center frequency errors in Hertz.

For details see [Chapter 3.1.1, "Modulation accuracy, flatness and tolerance parameters"](#), on page 15.

**Return values:**

<Result> <Global Result>, <Stream 1 result> ... <Stream n result>

**Usage:** Query only

---

**FETCh:BURSt:GIMBalance:AVERAge?**  
**FETCh:BURSt:GIMBalance:MAXimum?**  
**FETCh:BURSt:GIMBalance:MINimum?**

Returns the average, maximum or minimum I/Q imbalance in dB.

For details see [Chapter 3.1.1, "Modulation accuracy, flatness and tolerance parameters"](#), on page 15.

**Return values:**

<Result> <list>

**Usage:** Query only

---

**FETCh:BURSt:IQOFfset:AVERAge?**  
**FETCh:BURSt:IQOFfset:MAXimum?**  
**FETCh:BURSt:IQOFfset:MINimum?**

Returns the average, maximum or minimum I/Q offset in dB.

For details see [Chapter 3.1.1, "Modulation accuracy, flatness and tolerance parameters"](#), on page 15.

**Return values:**

<Result>                      <list>

**Usage:**                      Query only

**FETCH:BURSt:IQSKew:AVERage?**

**FETCH:BURSt:IQSKew:MAXimum?**

**FETCH:BURSt:IQSKew:MINimum?**

Returns the average, maximum or minimum I/Q skew in picoseconds.

For details see [Chapter 3.1.1, "Modulation accuracy, flatness and tolerance parameters"](#), on page 15.

**Usage:**                      Query only

**FETCH:BURSt:MCPower:AVERage?**

**FETCH:BURSt:MCPower:MAXimum?**

**FETCH:BURSt:MCPower:MINimum?**

Returns the MIMO cross power (average, maximum or minimum value) in dB for the IEEE 802.11n (MIMO) standard. For details see [Chapter 3.1.1, "Modulation accuracy, flatness and tolerance parameters"](#), on page 15.

**Return values:**

<Result>                      <Stream 1 result> ... <Stream n result>

**Usage:**                      Query only

**FETCH:BURSt:MCHPower:AVERage?**

**FETCH:BURSt:MCHPower:MAXimum?**

**FETCH:BURSt:MCHPower:MINimum?**

Returns the MIMO channel power (average, maximum or minimum value) in dBm for the IEEE 802.11n (MIMO) standard. For details see [Chapter 3.1.1, "Modulation accuracy, flatness and tolerance parameters"](#), on page 15.

**Return values:**

<Result>                      <Stream 1 result> ... <Stream n result>

**Usage:**                      Query only

**FETCH:BURSt:PAYLoad[:AVERage]?**

**FETCH:BURSt:PAYLoad:MINimum?**

**FETCH:BURSt:PAYLoad:MAXimum?**

Returns the average, maximum or minimum of the "Payload Power per PPDU" (in dBm). All analyzed PPDU's, up to the statistic length, take part in the statistical evaluation.

**Return values:**

&lt;Result&gt; &lt;list&gt;

**Usage:** Query only**FETCh:BURSt:PEAK[:AVERAge]?****FETCh:BURSt:PEAK:MINimum?****FETCh:BURSt:PEAK:MAXimum?**

Returns the average, maximum or minimum of the "Peak Power per PPDU" (in dBm). All analyzed PDUs, up to the statistic length, take part in the statistical evaluation.

**Return values:**

&lt;Result&gt; &lt;list&gt;

**Usage:** Query only**FETCh:BURSt:PREAmble[:AVERAge]?****FETCh:BURSt:PREAmble:MAXimum?****FETCh:BURSt:PREAmble:MINimum?**

Returns the average, maximum or minimum of the "Preamble Power per PPDU" (in dBm). All symbols prior to the first data symbol of the PPDU are used to calculate the preamble power.

All analyzed PDUs, up to the statistic length, take part in the statistical evaluation.

**Return values:**

&lt;Result&gt; &lt;list&gt;

**Usage:** Query only**FETCh:BURSt:QUADoffset:AVERAge?****FETCh:BURSt:QUADoffset:MAXimum?****FETCh:BURSt:QUADoffset:MINimum?**

Returns the average, maximum or minimum quadrature offset of symbols within a PPDU. This value indicates the phase accuracy.

For details see [Chapter 3.1.1, "Modulation accuracy, flatness and tolerance parameters"](#), on page 15.

**Return values:**

&lt;Result&gt; &lt;list&gt;

**Usage:** Query only**FETCh:BURSt:RMS[:AVERAge]?****FETCh:BURSt:RMS:MAXimum?****FETCh:BURSt:RMS:MINimum?**

Returns the average, maximum or minimum RMS power in dBm for all analyzed PDUs.



For details see [Chapter 3.1.1, "Modulation accuracy, flatness and tolerance parameters"](#), on page 15.

**Return values:**

<Result>                    <Global Result>, <Stream 1 result> ... <Stream n result>

**Usage:**                    Query only

---

**FETCh:BURSt:SYMBolerror:AVERage?****FETCh:BURSt:SYMBolerror:MAXimum?****FETCh:BURSt:SYMBolerror:MINimum?**

Returns the average, maximum or minimum percentage of symbols that were outside the allowed demodulation range within a PPDU (as defined by the standard).

For details see [Chapter 3.1.1, "Modulation accuracy, flatness and tolerance parameters"](#), on page 15.

**Return values:**

<Result>                    <Global Result>, <Stream 1 result> ... <Stream n result>

**Usage:**                    Query only

---

**FETCh:BURSt:TFALI:AVERage?****FETCh:BURSt:TFALI:MAXimum?****FETCh:BURSt:TFALI:MINimum?**

Returns the average, maximum or minimum PPDU fall time in seconds.

Is only applicable to IEEE802.11b & IEEE802.11g (DSSS) signals.

For details see [Chapter 3.1.1, "Modulation accuracy, flatness and tolerance parameters"](#), on page 15.

**Return values:**

<Result>                    <list>

**Usage:**                    Query only

---

**FETCh:BURSt:TRISe:AVERage?****FETCh:BURSt:TRISe:MAXimum?****FETCh:BURSt:TRISe:MINimum?**

Returns the average, maximum or minimum burst rise time in seconds.

Is only applicable to IEEE802.11b & IEEE802.11g (DSSS) signals.

For details see [Chapter 3.1.1, "Modulation accuracy, flatness and tolerance parameters"](#), on page 15.

**Return values:**

<Result>                    <list>

**Usage:**                    Query only

---

**FETCh:BURSt:PPDU:EVM:ALL:AVERAge?**

Returns the error vector magnitude results for each PPDU, averaged over all data and pilot subcarriers for all symbols and streams.

**Return values:**

<Result> Comma-separated list of EVM values, one for each PPDU  
Default unit: dB

**Example:**

```
FETC:BURS:PPDU:EVM:ALL:AVER?
//Result:
-83.2953,-83.2953....
```

**Usage:** Query only

**Manual operation:** See "[Result Summary Global](#)" on page 49

---

**FETCh:BURSt:PPDU:EVM:DATA:AVERAge?**

Returns the error vector magnitude results for each PPDU, averaged over all data subcarriers for all symbols and streams.

**Return values:**

<Result> Comma-separated list of EVM values, one for each PPDU  
Default unit: dB

**Example:**

```
FETC:BURS:PPDU:EVM:DATA:AVER?
//Result:
-83.2953,-83.2953....
```

**Usage:** Query only

---

**FETCh:BURSt:PPDU:EVM:PILot:AVERAge?**

Returns the error vector magnitude results for each PPDU, averaged over all pilot subcarriers for all symbols and streams.

**Return values:**

<Result> Comma-separated list of EVM values, one for each PPDU  
Default unit: dB

**Example:**

```
FETC:BURS:PPDU:EVM:PIL:AVER?
//Result:
-83.2953,-83.2953....
```

**Usage:** Query only

---

**FETCh:SCDetailed:ALL?**

Returns detailed signal information for each decoded RU and for each object. The result is a comma-separated list of values with 5 rows per RU, in the same order as the Signal Content Detailed result display (see "[Signal Content Detailed \(IEEE 802.11ax, be\)](#)" on page 51).

These results are only available if the Signal Content Detailed result display is currently active (see [LAYout:ADD\[:WINDow\]?](#) on page 350).

The information for each decoded RU is returned in the following object order:

- (As of firmware version 3.20:) Legacy long training field (L-LTF)
- Long training field (HE-LTF)
- Data + Pilot
- Data only
- Pilot only

**Return values:**

1:<PPDUIndex>	integer sequential order of detected PPDU
2:<RUIndex>	integer sequential order of resource unit
3:<RUSize>	integer size of the resource unit Range: 26 to 996
4:<Object>	L-LTF   HE-LTF   Data + Pilot   Data   Pilot Type of object
5:<EVM>	numeric value Default unit: dB
6:<Power>	numeric value Power per subcarrier Default unit: dBm
7:<BER>	numeric value Bit error rate
8:<BERCheck>	PASS   FAIL Check whether any bit errors occurred.
9:<CWER>	numeric value Code word error rate
10:<CWERCheck>	PASS   FAIL Check whether any code word errors occurred.

**Example:**

```
LAY:ADD:WIND? '1', RIGH, SCD
FETC:SCD:ALL?
//Result:
1,nan,nan,L-LTF,nan,0.5497,nan,PASS,nan,PASS,
1,1,S996S484,HE-LTF,nan,-30.8854,nan,PASS,nan,PASS,
1,1,S996S484,Data + Pilot,-88.6586,-30.9008,nan,PASS,nan,PASS,
1,1,S996S484,Data,-88.6741,nan,nan,PASS,nan,PASS,
1,1,S996S484,Pilot,-88.0084,nan,nan,PASS,nan,PASS
```

**Usage:** Query only

**Manual operation:** See "Signal Content Detailed (IEEE 802.11ax, be)" on page 51

#### **FETCh:SCDetailed:EVM:ALL?**

Returns the EVM for all data and pilot subcarriers. The result is a comma-separated list of values, one for each PPDU and each RU.

These results are only available if the Signal Content Detailed result display is currently active (see [LAYout:ADD\[:WINDow\]?](#) on page 350).

**Return values:**

<Result> Default unit: dB

**Example:**

```
LAY:ADD:WIND? '1', RIGH, SCD
FETC:SCD:EVM:ALL?
//Result:
//-45.3692,-40.0135,-36.0258,-37.8301,-37.1719
```

**Usage:** Query only

#### **FETCh:SCDetailed:EVM:DATA?**

Returns the EVM for all data subcarriers. The result is a comma-separated list of values, one for each PPDU and each RU.

These results are only available if the Signal Content Detailed result display is currently active (see [LAYout:ADD\[:WINDow\]?](#) on page 350).

**Return values:**

<Result> Default unit: dB

**Example:**

```
LAY:ADD:WIND? '1', RIGH, SCD
FETC:SCD:EVM:DATA?
//Result:
//-45.0616,-39.6757,-35.6879,-37.4979,-36.9032
```

**Usage:** Query only

#### **FETCh:SCDetailed:EVM:PILot?**

Returns the EVM for all pilot subcarriers. The result is a comma-separated list of values, one for each PPDU and each RU.

These results are only available if the Signal Content Detailed result display is currently active (see [LAYout:ADD\[:WINDow\]?](#) on page 350).

**Return values:**

<Result> Default unit: dB

**Example:** LAY:ADD:WIND? '1', RIGH, SCD  
 FETC:SCD:EVM:PIL?  
 //Result:  
 //-54.6124,-55.3704,-51.4149,-51.1958,-43.4808

**Usage:** Query only

#### **FETCh:SCDetailed:POWer:PPDU? <SCDetailedObject>**

Returns the power results for each PPDU for the selected subcarriers.

These results are only available if the Signal Content Detailed result display is currently active (see [LAYout:ADD\[:WINDow\]?](#) on page 350).

#### **Query parameters:**

<SCDetailedObject> HELTf | EHTLtf | DPILot | LLTF

##### **HELTf**

Includes long training field (HE-LTF) subcarriers only

##### **DPILot**

Includes data and pilot subcarriers only

##### **LLTF**

Includes legacy long training field (L-LTF) subcarriers only

Default unit: dBm

**Example:** LAY:ADD:WIND? '1', RIGH, SCD  
 FETC:SCDE:POWE:PPDU? LLTF  
 //Result for 3 PPDUs:  
 //-11.1802, -11.1770, -11.1751

**Usage:** Query only

#### **FETCh:SCDetailed:POWer:RU? <SCDetailedObject>**

Returns the power in all PPDUs for each RU. The result is a comma-separated list of power values, one per RU.

These results are only available if the Signal Content Detailed result display is currently active (see [LAYout:ADD\[:WINDow\]?](#) on page 350).

Tip: to obtain the results for an individual subcarrier, use [FETCh:SCDetailed:POWer\[:SC\]?](#) on page 390.

#### **Query parameters:**

<SCDetailedObject> HELTf | EHTLtf | DPILot | LLTF

##### **HELTf**

Includes long training field (HE-LTF) subcarriers only

##### **DPILot**

Includes data and pilot subcarriers only

Default unit: dBm

**Example:** LAY:ADD:WIND? '1', RIGH, SCD  
FETC:SCD:POW:RU?

**Usage:** Query only

#### FETCh:SCDetailed:POWer[:SC]? <SCDetailedObject>

Returns the power per subcarrier in all PPDUs and all RUs. The result is a comma-separated list of power values, one per subcarrier.

These results are only available if the Signal Content Detailed result display is currently active (see [LAYout:ADD\[:WINDow\]?](#) on page 350).

Tip: to obtain the results for an individual resource unit, use [FETCh:SCDetailed:POWer:RU?](#) on page 389.

#### Query parameters:

<SCDetailedObject> HELTf | EHTLf | DPILot | LLTF

##### HELTf

Includes long training field (HE-LTF) subcarriers only

##### DPILot

Includes data and pilot subcarriers only

Default unit: dBm

**Example:** LAY:ADD:WIND? '1', RIGH, SCD  
FETC:SCD:POW:SC?

**Usage:** Query only

#### FETCh:SField:ALL?

Returns the results of the Signal Fields table, including column headers. The result is a comma-separated list of values for the selected PPDU. For details on the provided information see ["Signal Field"](#) on page 52

Is only available for the **IEEE 802.11ax, be** standards. For other standards, see [TRACe\[:DATA\]?](#) on page 408.

#### Return values:

<Result> <Signal\_field\_type>[,<Occupied\_bits>,<Field\_name>,  
<Binary\_value>,<Human\_readable\_value>],...

**Example:**

```

FETC:SFI:ALL?
// Result:
// L-SIG,
// B0-B3,Rate,0000,0,
// B4,Reserved,1,1,
// B5-B16,Length,000000000010,2,
// B17,Parity,0,0,
// B18-B23,Tail,010100,20,
// HE-SIG-A1,
// B0,Format,1,1,
// B1,Beam Change,1,1,
// B2,UL/DL,0,0,
// B3-B6,MCS,1010,10,B7,DCM,0,0,
// B8-B13,BSS Color,000000,0,
// B14,Reserved,0,0,
// B15-B18,Spatial Reuse,0000,0,
// B19-B20,Bandwidth,10,2,
// B21-B22,GI + LTF Size,010,2,
// B23-B25,Nsts,001,1,
// HE-SIG-A2
// B0-B6, TXOP Duration,0000000,0,
// B7,Coding,0,0,B8,LDPC Extra Symbol,0,0,
// B9,STBC,0,0,
// B10,TxBF,0,0,
// B11-B12,Pre-FEC Padding Factor,00,0,
// B13,PE Disambiguity,0,0,B14,Reserved,0,0,
// B15,Doppler,0,0,
// B16-B19,CRC,0000,0,
// B20-B25,Tail,000000,0

```

**Usage:** Query only

**Manual operation:** See "[Signal Field](#)" on page 52

---

**FETCh:SFSummary:ALL?**

Returns the numeric results of the "Spectrum Flatness" trace.

Is only available for the **IEEE 802.11ax, be** standards.

For details see "[Spectrum Flatness Result Summary](#)" on page 56.

**Return values:**

<Result> <SC\_Start\_No>,<SC\_End\_No>,<MinDist\_Low>,<SC\_MinDist\_Low>,<MinDist\_Up>,<SC\_MinDist\_Up>,<LimitCheckResult>,...

Comma-separated list of values for the overall subcarrier range and each subrange.

**Example:**

```
FETC:SFS:ALL?
//Result:
'-1012', '1012', '2.9906', '166', 'PASS',
'3.1331', '-826', 'PASS', '-1012', '-697',
'4.2194', '-1012', 'PASS', '3.1331', '-826',
'PASS', '-696', '-515', '4.2559', '-533',
'FAIL', '3.3923', '-696', 'PASS', '-509',
'-166', '4.1220', '-167', 'FAIL', '3.5353',
'-292', 'PASS', '-165', '-12', '5.3224', '-13',
'PASS', '3.8853', '-165', 'PASS', '12', '165',
'4.9335', '128', 'PASS', '4.7902', '12',
'PASS', '166', '509', '2.9906', '166', 'FAIL',
'3.9672', '508', 'PASS', '515', '696',
'3.7037', '695', 'FAIL', '3.9859', '519',
'PASS', '697', '1012', '3.6607', '1011',
'PASS', '4.1990', '953', 'PASS'
```

**Usage:** Query only

**Manual operation:** See "[Spectrum Flatness Result Summary](#)" on page 56

---

### FETCh:UTESummary:ALL?

Returns the results of the "Unused Tone Error" Summary. The result is a comma-separated list of values for up to 37 measurement points in the channel. Which subcarriers are measured depends on the size and position of the RU being transmitted.

This result is required by the **IEEE 802.11ax** standard for HE trigger-based PPDU with a maximum channel bandwidth of 80 MHz.

#### Return values:

<Result> -35 dB LHS | RUIIdx-3 | RUIIdx-2 | RUIIdx-1 | RUIIdx | RUIIdx+1 | RUIIdx+2 | RUIIdx+3 | -35 dB RHS

Set of n subcarriers, where n is the number of subcarriers in the resource unit to be checked.

For details see [Chapter 3.1.1.8, "Unused tone error"](#), on page 24

Default unit: -

**Example:**

```
FETC:UTES:ALL?
//Result:
// -35 dB LHS, -1, nan, nan, nan, nan, nan, -1, NONE,
// RUIIdx-3, -1, nan, nan, nan, nan, nan, -1, NONE,
// RUIIdx-2, -1, nan, nan, nan, nan, nan, -1, NONE,
// RUIIdx-1, -1, nan, nan, nan, nan, nan, -1, NONE,
// RUIIdx, 4, -59.64, -58.80, -58.11, -30.00, -28.11, 2, PASS,
// RUIIdx+1, 4, -68.39, -67.93, -67.28, -32.00, -35.28, 7, PASS,
// RUIIdx+2, 4, -66.06, -65.14, -63.41, -35.00, -28.41, 12, PASS,
// RUIIdx+3, 4, -68.06, -67.31, -65.97, -35.00, -30.97, 13, PASS,
// -35 dB RHS, 4, -73.80, -71.81, -69.82, -35.00, -34.82, 17, PASS
```

**Usage:** Query only



**Manual operation:** See ["Unused Tone Error Summary"](#) on page 57

---

#### UNIT:EVM <Unit>

Specifies the units for EVM limits and results

For details see [Chapter 3.1.1, "Modulation accuracy, flatness and tolerance parameters"](#), on page 15.

#### Parameters:

<Unit> DB | PCT  
\*RST: DB

---

#### UNIT:GIMBalance <Unit>

Specifies the units for gain imbalance results

For details see [Chapter 3.1.1, "Modulation accuracy, flatness and tolerance parameters"](#), on page 15.

#### Parameters:

<Unit> DB | PCT  
\*RST: DB

---

#### UNIT:PREamble <Unit>

Specifies the units for preamble error results.

#### Parameters:

<Unit> HZ | PCT

### 10.9.1.3 Limit check results

The following commands are required to query the results of the limit checks.

Useful commands for retrieving results described elsewhere:

- [UNIT:EVM](#) on page 393
- [UNIT:GIMBalance](#) on page 393

#### Remote commands exclusive to retrieving limit check results

<a href="#">CALCulate&lt;n&gt;:LIMit&lt;li&gt;:BURSt:ALL:RESult?</a> .....	394
<a href="#">CALCulate&lt;n&gt;:LIMit&lt;li&gt;:BURSt:EVM:ALL[:AVERAge]:RESult?</a> .....	394
<a href="#">CALCulate&lt;n&gt;:LIMit&lt;li&gt;:BURSt:EVM:ALL:MAXimum:RESult?</a> .....	394
<a href="#">CALCulate&lt;n&gt;:LIMit&lt;li&gt;:BURSt:EVM:DATA[:AVERAge]:RESult?</a> .....	395
<a href="#">CALCulate&lt;n&gt;:LIMit&lt;li&gt;:BURSt:EVM:DATA:MAXimum:RESult?</a> .....	395
<a href="#">CALCulate&lt;n&gt;:LIMit&lt;li&gt;:BURSt:EVM[:AVERAge]:RESult?</a> .....	395
<a href="#">CALCulate&lt;n&gt;:LIMit&lt;li&gt;:BURSt:EVM:MAXimum:RESult?</a> .....	395
<a href="#">CALCulate&lt;n&gt;:LIMit&lt;li&gt;:BURSt:EVM:PILOt[:AVERAge]:RESult?</a> .....	396
<a href="#">CALCulate&lt;n&gt;:LIMit&lt;li&gt;:BURSt:EVM:PILOt:MAXimum:RESult?</a> .....	396

CALCulate<n>:LIMit<li>:BURSt:FERRor[:AVERAge]:RESult?	396
CALCulate<n>:LIMit<li>:BURSt:FERRor:MAXimum:RESult?	396
CALCulate<n>:LIMit<li>:BURSt:IQOFFset[:AVERAge]:RESult?	396
CALCulate<n>:LIMit<li>:BURSt:IQOFFset:MAXimum:RESult?	396
CALCulate<n>:LIMit<li>:BURSt:SYMBolerror[:AVERAge]:RESult?	397
CALCulate<n>:LIMit<li>:BURSt:SYMBolerror:MAXimum:RESult?	397
CALCulate<n>:LIMit<li>:BURSt:TFALI[:AVERAge]:RESult?	397
CALCulate<n>:LIMit<li>:BURSt:TFALI:MAXimum:RESult?	397
CALCulate<n>:LIMit<li>:BURSt:TRISe[:AVERAge]:RESult?	398
CALCulate<n>:LIMit<li>:BURSt:TRISe:MAXimum:RESult?	398
CALCulate<n>:LIMit<li>:CONTRol[:DATA]?	398
CALCulate<n>:LIMit<li>:FAIL?	398
CALCulate<n>:LIMit<li>:UPPER[:DATA]?	399
CALCulate<n>:LIMit<li>:LOWer:FULL?	400
CALCulate<n>:LIMit<li>:UPPER:FULL?	400
CALCulate<n>:LIMit<li>:ESPectrum:CHECK:X?	400
CALCulate<n>:LIMit<li>:SPECtrum:MASK:CHECK:X?	400
CALCulate<n>:LIMit<li>:ESPectrum:CHECK:Y?	401
CALCulate<n>:LIMit<li>:SPECtrum:MASK:CHECK:Y?	401

---

### CALCulate<n>:LIMit<li>:BURSt:ALL:RESult?

Returns the result of the EVM limit check for all carriers. The limit value is defined by the standard or the user (see [CALCulate<n>:LIMit<li>:BURSt:ALL](#) on page 334).

**Suffix:**

<n>                      Window  
 <li>                     1..n

**Return values:**

<LimitCheck>        PASS | FAILED

**PASS**  
 The defined limit for the parameter was not exceeded.

**FAILED**  
 The defined limit for the parameter was exceeded.

**Usage:**              Query only

---

### CALCulate<n>:LIMit<li>:BURSt:EVM:ALL[:AVERAge]:RESult?

### CALCulate<n>:LIMit<li>:BURSt:EVM:ALL:MAXimum:RESult?

Returns the result of the average or maximum EVM limit check. The limit value is defined by the standard or the user (see [CALCulate<n>:LIMit<li>:BURSt:EVM:ALL:MAXimum](#) on page 335).

**Suffix:**

<n>                      Window

<li> 1..n

**Return values:**

<LimitCheck> PASS | FAILED

**PASS**

The defined limit for the parameter was not exceeded.

**FAILED**

The defined limit for the parameter was exceeded.

**Usage:** Query only

**CALCulate<n>:LIMit<li>:BURSt:EVM:DATA[:AVERAge]:RESult?**

**CALCulate<n>:LIMit<li>:BURSt:EVM:DATA:MAXimum:RESult?**

Returns the result of the average or maximum EVM limit check for data carriers. The limit value is defined by the standard or the user (see [CALCulate<n>:LIMit<li>:BURSt:EVM:DATA:MAXimum](#) on page 335).

**Suffix:**

<n> [Window](#)

<li> 1..n

**Return values:**

<LimitCheck> PASS | FAILED

**PASS**

The defined limit for the parameter was not exceeded.

**FAILED**

The defined limit for the parameter was exceeded.

**Usage:** Query only

**CALCulate<n>:LIMit<li>:BURSt:EVM[:AVERAge]:RESult?**

**CALCulate<n>:LIMit<li>:BURSt:EVM:MAXimum:RESult?**

Returns the result of the average or maximum EVM limit check. The limit value is defined by the standard or the user (see [CALCulate<n>:LIMit<li>:BURSt:EVM:MAXimum](#) on page 336).

Is only available for **IEEE 802.11b and g (DSSS)**.

**Suffix:**

<n> [Window](#)

<li> 1..n

**Usage:** Query only

**CALCulate<n>:LIMit<li>:BURSt:EVM:PILot[:AVERage]:RESult?****CALCulate<n>:LIMit<li>:BURSt:EVM:PILot:MAXimum:RESult?**

Returns the result of the average or maximum EVM limit check for pilot carriers. The limit value is defined by the standard or the user (see [CALCulate<n>:LIMit<li>:BURSt:EVM:PILot:MAXimum](#) on page 336).

**Suffix:**

<n> [Window](#)

<li> 1..n

**Return values:**

<LimitCheck> PASS | FAILED

**PASS**

The defined limit for the parameter was not exceeded.

**FAILED**

The defined limit for the parameter was exceeded.

**Usage:** Query only

**CALCulate<n>:LIMit<li>:BURSt:FERRor[:AVERage]:RESult?****CALCulate<n>:LIMit<li>:BURSt:FERRor:MAXimum:RESult?**

Returns the result of the average or maximum center frequency error limit check. The limit value is defined by the standard or the user (see [CALCulate<n>:LIMit<li>:BURSt:FERRor:MAXimum](#) on page 336).

**Suffix:**

<n> [Window](#)

<li> 1..n

**Return values:**

<LimitCheck> PASS | FAILED

**PASS**

The defined limit for the parameter was not exceeded.

**FAILED**

The defined limit for the parameter was exceeded.

**Usage:** Query only

**CALCulate<n>:LIMit<li>:BURSt:IQOFFset[:AVERage]:RESult?****CALCulate<n>:LIMit<li>:BURSt:IQOFFset:MAXimum:RESult?**

Returns the result of the average or maximum I/Q offset limit check. The limit value is defined by the standard or the user (see [CALCulate<n>:LIMit<li>:BURSt:IQOFFset:MAXimum](#) on page 337).

**Suffix:**

<n> [Window](#)

<li> 1..n

**Return values:**

<LimitCheck> PASS | FAILED

**PASS**

The defined limit for the parameter was not exceeded.

**FAILED**

The defined limit for the parameter was exceeded.

**Usage:** Query only

**CALCulate<n>:LIMit<li>:BURSt:SYMBolerror[:AVERAge]:RESult?**

**CALCulate<n>:LIMit<li>:BURSt:SYMBolerror:MAXimum:RESult?**

Returns the result of the average or maximum symbol clock error limit check. The limit value is defined by the standard or the user (see [CALCulate<n>:LIMit<li>:BURSt:SYMBolerror:MAXimum](#) on page 337).

**Suffix:**

<n> [Window](#)

<li> 1..n

**Return values:**

<LimitCheck> PASS | FAILED

**PASS**

The defined limit for the parameter was not exceeded.

**FAILED**

The defined limit for the parameter was exceeded.

**Usage:** Query only

**CALCulate<n>:LIMit<li>:BURSt:TFALI[:AVERAge]:RESult?**

**CALCulate<n>:LIMit<li>:BURSt:TFALI:MAXimum:RESult?**

Returns the result of the average or maximum fall time limit check. The limit value is defined by the standard or the user (see [CALCulate<n>:LIMit<li>:BURSt:TFALI:MAXimum](#) on page 337).

Is **only** available for **IEEE 802.11b**.

**Suffix:**

<n> [Window](#)

<li> 1..n

**Return values:**

<LimitCheck> PASS | FAILED

**Usage:** Query only

**CALCulate<n>:LIMit<li>:BURSt:TRISe[:AVERage]:RESult?****CALCulate<n>:LIMit<li>:BURSt:TRISe:MAXimum:RESult?**

Returns the result of the average or maximum rise time limit check. The limit value is defined by the standard or the user (see [CALCulate<n>:LIMit<li>:BURSt:TRISe:MAXimum](#) on page 338).

Is **only** available for **IEEE 802.11b**.

**Suffix:**

<n> [Window](#)

<li> 1..n

**Usage:** Query only

**CALCulate<n>:LIMit<li>:CONTrol[:DATA]?**

Queries the x-axis values for the specified limit line.

**Suffix:**

<n> 1..n

<li> 1..n

Limit line for unused tone error RU group:

// 1 = -35dB LHS

// 2 = RUIdx-3

// 3 = RUIdx-2

// 4 = RUIdx-1

// 5 = RUIdx

// 6 = RUIdx+1

// 7 = RUIdx+2

// 8 = RUIdx+3

// 9 = -35dB RHS

**Return values:**

<Result>

**Usage:** Query only

**Manual operation:** See "[Unused Tone Error Summary](#)" on page 57

**CALCulate<n>:LIMit<li>:FAIL?**

Queries the result of a limit check in the specified window.

To get a valid result, you have to perform a complete measurement with synchronization to the end of the measurement before reading out the result. This is only possible for single measurement mode.

See also [INITiate<n>:CONTinuous](#) on page 369.

**Suffix:**

<n> 1..n

[Window](#)

<li> 1..n  
 SEM: Limit line according to [Table 10-11](#)  
 Limit line for unused tone error RU group:  
 // 1 = -35dB LHS  
 // 2 = RUIdx-3  
 // 3 = RUIdx-2  
 // 4 = RUIdx-1  
 // 5 = RUIdx  
 // 6 = RUIdx+1  
 // 7 = RUIdx+2  
 // 8 = RUIdx+3  
 // 9 = -35dB RHS

**Return values:**

<Result> **OFF | 0**  
 PASS  
**ON | 1**  
 FAIL

**Example:**

```
INIT; *WAI
Starts a new sweep and waits for its end.
CALC2:LIM4:FAIL?
Queries the result of the check for spectrum flatness (upper)
limit line in window 2.
```

**Usage:**

Query only

**Manual operation:**

See "[Unused Tone Error Summary](#)" on page 57  
 See "[Spectrum Emission Mask](#)" on page 60

**Table 10-11: Limit line suffix <k> for SEM measurements in R&S FSW WLAN application**

Suffix	Limit
1 to 2	These indexes are not used
3	Limit line for "Spectrum Emission Mask" as defined by ETSI
4	"Spectrum Flatness" (Upper) limit line
5	"Spectrum Flatness" (Lower) limit line
6	Limit line for "Spectrum Emission Mask" as defined by IEEE
7	PVT Rising Edge max limit
8	PVT Rising Edge mean limit
9	PVT Falling Edge max limit
10	PVT Falling Edge mean limit

**CALCulate<n>:LIMit<li>:UPPer[:DATA]?**

Queries the y-axis values for the specified limit line.

**Suffix:**

<n> 1..n

<li> 1..n  
 Limit line for unused tone error RU group:  
 // 1 = -35dB LHS  
 // 2 = RUIdx-3  
 // 3 = RUIdx-2  
 // 4 = RUIdx-1  
 // 5 = RUIdx  
 // 6 = RUIdx+1  
 // 7 = RUIdx+2  
 // 8 = RUIdx+3  
 // 9 = -35dB RHS

**Return values:**

<Result> Default unit: DB

**Usage:** Query only

**Manual operation:** See "[Unused Tone Error Summary](#)" on page 57

**CALCulate<n>:LIMit<li>:LOWer:FULL?**

**CALCulate<n>:LIMit<li>:UPPer:FULL?**

Queries the limit line y-values as defined by the standard for the specified window.

**Tip:** to query the corresponding x-values, use the [TRACe<n>\[:DATA\]:X?](#) command.

Note: both commands have the same effect; the suffix determines whether the upper or lower limit is returned. For compatibility reasons, both commands are maintained.

**Suffix:**

<n> 1..n  
[Window](#)

<li> 4 | 5  
 The limit line to query  
**4:** "Spectrum Flatness" **upper** limit line  
**5:** "Spectrum Flatness" **lower** limit line

**Example:** CALC2:LIM4:UPP:FULL?

**Usage:** Query only

**CALCulate<n>:LIMit<li>:ESPECTrum:CHECK:X?**

**CALCulate<n>:LIMit<li>:SPECTrum:MASK:CHECK:X?**

Returns the highest frequency for which the SEM limit was exceeded. If no limit was exceeded, an error is returned.

**Suffix:**

<n> 1..n  
[Window](#)

<li> 1..n

**Usage:** Query only



**CALCulate<n>:LIMit<li>:ESPEctrum:CHECK:Y?****CALCulate<n>:LIMit<li>:SPECtrum:MASK:CHECK:Y?**

Returns the highest (absolute) power level that exceeds the SEM limit. If no limit was exceeded, an error is returned.

**Suffix:**

<n> 1..n  
Window

<li> 1..n

**Usage:** Query only

## 10.9.2 Numeric results for frequency sweep measurements

The following commands are required to retrieve the numeric results of the WLAN frequency sweep measurements (see [Chapter 3.2, "Frequency sweep measurements"](#), on page 58).



In the following commands used to retrieve the numeric results for RF data, the suffixes <n> for CALCulate and <k> for LIMit are irrelevant.

CALCulate<n>:LIMit<li>:ACPpower:ACHannel:RESult?	401
CALCulate<n>:LIMit<li>:ACPpower:ALternate<ch>:RESult?	401
CALCulate<n>:MARKer<m>:FUNction:POWer<sb>:RESult?	402
CALCulate<n>:MARKer<m>:FUNction:POWer:RESult:MAXHold	404
CALCulate<n>:MARKer<m>:FUNction:POWer<sb>:RESult:PHZ	404
CALCulate<n>:MARKer<m>:X	405
CALCulate<n>:STATistics:RESult<res>?	405

**CALCulate<n>:LIMit<li>:ACPpower:ACHannel:RESult?****CALCulate<n>:LIMit<li>:ACPpower:ALternate<ch>:RESult?**

Queries the state of the limit check for the adjacent or alternate channels in an ACLR measurement.

To get a valid result, you have to perform a complete measurement with synchronization to the end of the measurement before reading out the result. This is only possible for single measurement mode.

See also [INITiate<n>:CONTinuous](#) on page 369.

**Suffix:**

<n> irrelevant

<li> irrelevant

<ch> Alternate channel number

**Return values:**

<LowerChan> text value

The state of the limit check for the lower alternate or adjacent channels.

**PASSED**

Limit check has passed.

**FAIL**

Limit check has failed.

<UpperChan>

text value

The state of the limit check for the upper alternate or adjacent channels.

**PASSED**

Limit check has passed.

**FAIL**

Limit check has failed.

**Example:**

```
INIT:IMM;*WAI;
CALC:LIM:ACP:ACH:RES?
PASSED,PASSED
```

**Usage:**

Query only

**CALCulate<n>:MARKer<m>:FUNction:POWer<sb>:RESult? <Measurement>**

Queries the results of power measurements.

Is only available for measurements on RF data (see [Chapter 3.2, "Frequency sweep measurements"](#), on page 58).

To get a valid result, you have to perform a complete measurement with synchronization to the end of the measurement before reading out the result. This is only possible for single measurement mode.

See also [INITiate<n>:CONTinuous](#) on page 369.

**Suffix:**

<n> irrelevant

<m> irrelevant

&lt;sb&gt;

Sub block in a Multi-standard radio measurement;  
 MSR ACLR: 1 to 8  
 Multi-SEM: 1 to 8  
 for all other measurements: irrelevant

**Parameters:**

&lt;Measurement&gt;

**ACPower | MCACpower**

ACLR measurements (also known as adjacent channel power or multicarrier adjacent channel measurements).

Returns the power for every active transmission and adjacent channel. The order is:

- power of the transmission channels
- power of adjacent channel (lower, upper)
- power of alternate channels (lower, upper)

**MSR ACLR results:**

For MSR ACLR measurements, the order of the returned results is slightly different:

- power of the transmission channels
- total power of the transmission channels for each sub block
- power of adjacent channels (lower, upper)
- power of alternate channels (lower, upper)
- power of gap channels (lower1, upper1, lower2, upper2)

The unit of the return values depends on the scaling of the y-axis:

- logarithmic scaling returns the power in the current unit
- linear scaling returns the power in W

**GACLR**

For MSR ACLR measurements only: returns a list of ACLR values for each gap channel (lower1, upper1, lower2, upper2)

**MACM**

For MSR ACLR measurements only: returns a list of CACLR values for each gap channel (lower1, upper1, lower2, upper2)

**CN**

Carrier-to-noise measurements.

Returns the C/N ratio in dB.

**CNO**

Carrier-to-noise measurements.

Returns the C/N ratio referenced to a 1 Hz bandwidth in dBm/Hz.

**CPOWER**

Channel power measurements.

Returns the channel power. The unit of the return values depends on the scaling of the y-axis:

- logarithmic scaling returns the power in the current unit
- linear scaling returns the power in W

For SEM measurements, the return value is the channel power of the reference range (in the specified sub block).

**PPOwer**

Peak power measurements.

Returns the peak power. The unit of the return values depends on the scaling of the y-axis:

- logarithmic scaling returns the power in the current unit
- linear scaling returns the power in W

For SEM measurements, the return value is the peak power of the reference range (in the specified sub block).

**OBANdwidth | OBWidth**

Occupied bandwidth.

Returns the occupied bandwidth in Hz.

**Manual operation:** See ["Channel Power ACLR"](#) on page 59  
See ["Occupied Bandwidth"](#) on page 60

**CALCulate<n>:MARKer<m>:FUNction:POWer:RESult:MAXHold**

Returns a comma-separated list of the maxhold trace results for power measurements.

**Suffix:**

<n> 1..n  
irrelevant

<m> 1..n

**Example:**

```
CALC:MARK:FUNC:POW:RES:MAXH?
-36.1680526733,0.76843261719,0.76843261719,
0.76984405518,0.76984405518,0.02191543579,
0.02191543579
```

**CALCulate<n>:MARKer<m>:FUNction:POWer<sb>:RESult:PHZ <State>**

Selects the unit the FSW returns results for power measurements.

You can query results with [CALCulate<n>:MARKer<m>:FUNction:POWer<sb>:RESult?](#).

**Suffix:**

<n> [Window](#)

<m> [Marker](#)

<sb> irrelevant

**Parameters:**

<State> ON | OFF | 1 | 0

**ON | 1**

Channel power density in dBm/Hz

**OFF | 0**

Channel power in dBm

\*RST: 0

**Example:** `CALC:MARK:FUNC:POW:RES:PHZ ON`  
Output of results referred to the channel bandwidth.

---

### **CALCulate<n>:MARKer<m>:X <Position>**

Moves a marker to a specific coordinate on the x-axis.

If necessary, the command activates the marker.

If the marker has been used as a delta marker, the command turns it into a normal marker.

#### **Suffix:**

<n> [Window](#)

<m> [Marker](#)

#### **Parameters:**

<Position> Numeric value that defines the marker position on the x-axis.  
The unit depends on the result display.

Range: The range depends on the current x-axis range.  
Default unit: Hz

**Example:** `CALC:MARK2:X 1.7MHz`  
Positions marker 2 to frequency 1.7 MHz.

**Manual operation:** See ["Marker Table"](#) on page 63  
See ["Marker Peak List"](#) on page 64

---

### **CALCulate<n>:STATistics:RESult<res>? <ResultType>**

Queries the results of a measurement for a specific trace.

#### **Suffix:**

<n> [Window](#)

<res> [Trace](#)

#### **Query parameters:**

<ResultType> **MEAN**  
Average (=RMS) power in dBm measured during the measurement time.

**PEAK**  
Peak power in dBm measured during the measurement time.

**CFACTOR**  
Determined crest factor (= ratio of peak power to average power) in dB.

**ALL**  
Results of all three measurements mentioned before, separated by commas: <mean power>,<peak power>,<crest factor>

- Example:** `CALC:STAT:RES2? ALL`  
 Reads out the three measurement results of trace 2. Example of answer string: 5.56,19.25,13.69 i.e. mean power: 5.56 dBm, peak power 19.25 dBm, crest factor 13.69 dB
- Usage:** Query only
- Manual operation:** See "CCDF" on page 61

### 10.9.3 Retrieving trace results

The following commands describe how to retrieve the trace data from the WLAN IQ measurement (Modulation Accuracy, Flatness and Tolerance). Note that for these measurements, only 1 trace per window can be configured.



#### MIMO results in subwindows

For MIMO measurements, the results for each data stream are displayed in a separate tab. In addition, an overview tab is provided in which all data streams are displayed at once, in individual subwindows. To query the trace data for a specific data stream, you must select the subwindow first (see `DISPlay[:WINDow<n>][:SUBWindow<w>]:SElect`).

Useful commands for retrieving trace results described elsewhere:

- The traces for frequency sweep measurements are identical to those in the Spectrum application.
- `[SENSe:]BURSt:SElect` on page 327

#### Remote commands exclusive to retrieving trace results:

<code>DISPlay[:WINDow&lt;n&gt;]:FLAGs</code> .....	406
<code>FORMat[:DATA]</code> .....	407
<code>[SENSe:]BURSt:COUNT:SElect:STATe</code> .....	408
<code>TRACe[:DATA]?</code> .....	408
<code>TRACe&lt;n&gt;[:DATA]:X?</code> .....	410

---

#### `DISPlay[:WINDow<n>]:FLAGs <State>`

Configures the output of bitstream data in ASCII format

##### Suffix:

<n> [Window](#)

##### Parameters:

<State> 0 | 2

**0**

Switches the function off

**2**

In bitstream trace results, any DC (empty) carriers found in the bitstream are indicated by `NULL` in the bitstream, if the output format is ASCII.

\*RST: 0

**Example:**

```
DISP:WIND3:FLAG 2
//Result:
//.....02,37,3E,01,"NULL",01,19,2A.....
```

**FORMat[:DATA] <Format>[, <BitLength>]**

Selects the data format that is used for transmission of trace data from the FSW to the controlling computer.

Note that the command has no effect for data that you send to the FSW. The FSW automatically recognizes the data it receives, regardless of the format.

**Parameters:**

<Format>

**ASCIi**

ASCII format, separated by commas.

This format is almost always suitable, regardless of the actual data format. However, the data is not as compact as other formats can be.

**REAL**

Floating-point numbers (according to IEEE 754) in the "definite length block format".

In the Spectrum application, the format setting `REAL` is used for the binary transmission of trace data.

**UINT**

In the R&S FSW WLAN application, bitstream data can be sent as unsigned integers format to improve the data transfer speed (compared to ASCII format).

<BitLength>

Length in bits for floating-point results

**16**

16-bit floating-point numbers.

Compared to `REAL, 32` format, half as many numbers are returned.

**32**

32-bit floating-point numbers

For I/Q data, 8 bytes per sample are returned for this format setting.

**64**

64-bit floating-point numbers

Compared to `REAL, 32` format, twice as many numbers are returned.

**Example:**

```
FORM REAL, 32
```

**[SENSe:]BURSt:COUNT:SElect:STATe** <State>

Determines whether a selected PPDU (using `[SENSe:]BURSt:SElect`) is considered or ignored.

**Parameters:**

<State> ON | OFF | 1 | 0

**ON | 1**

Only the results for the selected PPDU are considered by a subsequent `TRACe[:DATA]?` query for "EVM vs Symbol" and "EVM vs Carrier" result displays.

**OFF | 0**

"EVM vs Symbol" result display: query returns all detected PPDUs in the current capture buffer

"EVM vs Carrier" result display: query returns the statistical results for all analyzed PPDUs

\*RST: 0

**Example:**

```
LAY:WIND2:REPL EVSY
SENS:BURS:SEL:STAT ON
SENS:BURS:SEL 10
TRAC2:DATA? TRACE1
```

Returns the trace results for the PPDU number 10 in window 2 ("EVM vs Symbol").

**TRACe[:DATA]?** <TraceNumber>

Queries current trace data and measurement results from the window previously selected using `DISPlay[:WINDow<n>][:SUBWindow<w>]:SElect`.

As opposed to the FSW base unit, the window suffix <n> is not considered in the R&S FSW WLAN application! Use the `DISPlay[:WINDow<n>][:SUBWindow<w>]:SElect` to select the (sub)window before you query trace results!

For details see [Chapter 10.9.4, "Measurement results for TRACe<n>\[:DATA\]? TRACe<n>"](#), on page 410.

**Query parameters:**

<TraceNumber> TRACE1 | ... | TRACE6

Selects the type of result to be returned.

**TRACE1 | ... | TRACE6**

Returns the trace data for the corresponding trace.

Note that for the default WLAN I/Q measurement (Modulation Accuracy, Flatness and Tolerance), only 1 trace per window (TRACE1) is available.

**LIST**

Returns the results of the peak list evaluation for "Spectrum Emission Mask" measurements.



**Example:**            `DISP:WIND2:SEL`  
                       `TRAC? TRACE3`  
 Queries the data of trace 3 in window 2.

**Manual operation:** See "[AM/AM](#)" on page 28  
 See "[AM/PM](#)" on page 29  
 See "[AM/EVM](#)" on page 29  
 See "[Bitstream](#)" on page 30  
 See "[Constellation](#)" on page 32  
 See "[Constellation vs Carrier](#)" on page 34  
 See "[EVM vs Carrier](#)" on page 35  
 See "[EVM vs Chip](#)" on page 36  
 See "[EVM vs Symbol](#)" on page 36  
 See "[FFT Spectrum](#)" on page 37  
 See "[Freq. Error vs Preamble](#)" on page 38  
 See "[Gain Imbalance vs Carrier](#)" on page 39  
 See "[Group Delay](#)" on page 40  
 See "[Magnitude Capture](#)" on page 41  
 See "[Phase Error vs Preamble](#)" on page 42  
 See "[Phase Tracking](#)" on page 43  
 See "[PLCP Header \(IEEE 802.11b, g \(DSSS\)\)](#)" on page 43  
 See "[PvT Full PPDU](#)" on page 44  
 See "[PvT Rising Edge](#)" on page 45  
 See "[PvT Falling Edge](#)" on page 46  
 See "[Quad Error vs Carrier](#)" on page 47  
 See "[Signal Field](#)" on page 52  
 See "[Spectrum Flatness](#)" on page 54  
 See "[Unused Tone Error](#)" on page 56  
 See "[Spectrum Emission Mask](#)" on page 60

**Table 10-12: Return values for TRACE1 to TRACE6 parameter**

For I/Q data traces, the results depend on the evaluation method (window type) selected for the current window (see `LAYout:ADD[:WINDow]?` on page 350). The results for the various window types are described in [Chapter 10.9.4, "Measurement results for TRACe<n>\[:DATA\]? TRACE<n>"](#), on page 410.

For RF data traces, the trace data consists of a list of 1001 power levels that have been measured. The unit depends on the measurement and on the unit you have currently set.

For SEM measurements, the x-values should be queried as well, as they are not equi-distant (see `TRACe<n>[:DATA]:X?` on page 410).

**Table 10-13: Return values for LIST parameter**

<p>This parameter is only available for SEM measurements.</p> <p>For each sweep list range you have defined (range 1...n), the command returns eight values in the following order.</p> <p>&lt;No&gt;,&lt;StartFreq&gt;,&lt;StopFreq&gt;,&lt;RBW&gt;,&lt;PeakFreq&gt;,&lt;PowerAbs&gt;,&lt;PowerRel&gt;,&lt;PowerDelta&gt;,&lt;LimitCheck&gt;,&lt;Unused1&gt;,&lt;Unused2&gt;</p> <ul style="list-style-type: none"> <li>• &lt;No&gt;: range number</li> <li>• &lt;StartFreq&gt;,&lt;StopFreq&gt;: start and stop frequency of the range</li> <li>• &lt;RBW&gt;: resolution bandwidth</li> <li>• &lt;PeakFreq&gt;: frequency of the peak in a range</li> <li>• &lt;PowerAbs&gt;: absolute power of the peak in dBm</li> <li>• &lt;PowerRel&gt;: power of the peak in relation to the channel power in dBc</li> <li>• &lt;PowerDelta&gt;: distance from the peak to the limit line in dB, positive values indicate a failed limit check</li> <li>• &lt;LimitCheck&gt;: state of the limit check (0 = PASS, 1 = FAIL)</li> <li>• &lt;Unused1&gt;,&lt;Unused2&gt;: reserved (0.0)</li> </ul>
---

**TRACe<n>[:DATA]:X? <TraceNumber>**

Queries the horizontal trace data for each sweep point in the specified window, for example the frequency in frequency domain or the time in time domain measurements.

This is especially useful for traces with non-equidistant x-values, e.g. for SEM or Spurious Emissions measurements.

**Suffix:**

<n> [Window](#)

**Query parameters:**

<TraceNumber> Trace number.

**TRACE1 | TRACE2 | TRACE3 | TRACE4 | TRACE5 | TRACE6**

**Return values:**

<X-Values>

**Example:**

TRAC3:X? TRACE1

Returns the x-values for trace 1 in window 3.

**Usage:**

Query only

**10.9.4 Measurement results for TRACe<n>[:DATA]? TRACE<n>**

The evaluation method selected by the LAY:ADD:WIND command also affects the results of the trace data query (see [TRACe<n>\[:DATA\]? TRACE<n>](#)).

Details on the returned trace data depending on the evaluation method are provided here.



No trace data is available for the following evaluation methods:

- "Magnitude Capture"
- "Result Summary" (Global/Detailed)

As opposed to the FSW base unit, the window suffix <n> is not considered in the R&S FSW WLAN application! Use the `DISPlay[:WINDow<n>][:SUBWindow<w>]:SELect` to select the window before you query trace results!

For details on the graphical results of these evaluation methods, see [Chapter 3.1.2, "Evaluation methods for WLAN IQ measurements"](#), on page 27.

The following table provides an overview of the main characteristics of the WLAN OFDM symbol structure in the frequency domain for various standards. The description of the TRACe results refers to these values to simplify the description.

Table 10-14: WLAN OFDM symbol structure in the frequency domain

Standard	CBW / MHz	$N_{FFT}$	$N_{SD}$ No. of data sc	$N_{SP}$ No. of pilot sc	Pilot subcarrier (sc)	$N_{ST}$ No. of sc total: $=N_{SD}+N_{SP}$	$N_{Null}$ No. of DC/Null sc	DC / Null subcarrier	$N_{Used}$ No. of used sc := $N_{ST} + N_{Null}$	$N_{guard} := N_F - N_{Used}$	Comment
IEEE 802.11 a, j, p	5	64	48	4	{-21,-7,7,21}	52	1	{0}	53	11	IEEE Std 802.11-2012 Tab Table 18-5—Timing-related parameters
	10	64	48	4	{-21,-7,7,21}	52	1	{0}	53	11	IEEE Std 802.11-2012 Tab Table 18-5—Timing-related parameters
	20	64	48	4	{-21,-7,7,21}	52	1	{0}	53	11	IEEE Std 802.11-2012 Tab Table 18-5—Timing-related parameters
11n	20	64	52	4	{-21,-7,7,21} <sup>1)</sup>	56	1	{0}	57	7	IEEE Std 802.11-2012 Tab Table 20-6—Timing-related constants
	40	128	108	6	{-53, -25, -11, 11, 25, 53} <sup>1)</sup>	114	3	{-1,0,1} <sup>3)</sup>	117	11	IEEE Std 802.11-2012 Tab Table 20-6—Timing-related constants
11ac	20	64	52	4	{-21,-7,7,21} <sup>2)</sup>	56	1	{0}	57	7	IEEE P802.11ac/D2.1, March 2012 Table 22-5—Timing-related constants
	40	128	108	6	{-53, -25, -11, 11, 25, 53} <sup>2)</sup>	114	3	{-1,0,1} <sup>4)</sup>	117	11	IEEE P802.11ac/D2.1, March 2012 Table 22-5—Timing-related constants

1) IEEE Std 802.11-2012 Section 20.3.11.10 Pilot subcarriers

2) IEEE P802.11ac/D2.1, March 2012 Section 22.3.10.10 Pilot subcarriers

3) IEEE Std 802.11-2012 equation (20-59)

4) IEEE P802.11ac/D2.1, March 2012 equation (22-94)

5) IEEE P802.11ac/D2.1, March 2012 equation (22-95)

6) IEEE P802.11ac/D2.1, March 2012 equation (22-96)

Standard	CBW / MHz	$N_{FFT}$	$N_{SD}$ No. of data sc	$N_{SP}$ No. of pilot sc	Pilot subcarrier (sc)	$N_{ST}$ No. of sc total: $=N_{SD}+N_{SP}$	$N_{Null}$ No. of DC/Null sc	DC / Null subcarrier	$N_{used}$ No. of used sc := $N_{ST} + N_{Null}$	$N_{guard} := N_{FT} - N_{used}$	Comment
	80	256	234	8	{-103, -75, -39, -11, 11, 39, 75, 103} <sup>2)</sup>	242	3	{-1, 0, 1} <sup>5)</sup>	245	11	IEEE P802.11ac/D2.1, March 2012 Table 22-5—Timing-related constants
	160	512	468	16	{-231, -203, -167, -139, -117, -89, -53, -25, 25, 53, 89, 117, 139, 167, 203, 231} <sup>2)</sup>	484	17	{-129, -128, -127, -5:1.5, 127, 128, 129} <sup>6)</sup>	501	11	IEEE P802.11ac/D2.1, March 2012 Table 22-5—Timing-related constants
<p>1) IEEE Std 802.11-2012 Section 20.3.11.10 Pilot subcarriers</p> <p>2) IEEE P802.11ac/D2.1, March 2012 Section 22.3.10.10 Pilot subcarriers</p> <p>3) IEEE Std 802.11-2012 equation (20-59)</p> <p>4) IEEE P802.11ac/D2.1, March 2012 equation (22-94)</p> <p>5) IEEE P802.11ac/D2.1, March 2012 equation (22-95)</p> <p>6) IEEE P802.11ac/D2.1, March 2012 equation (22-96)</p>											

• <a href="#">AM/AM</a> .....	414
• <a href="#">AM/PM</a> .....	414
• <a href="#">AM/EVM</a> .....	414
• <a href="#">Bitstream</a> .....	414
• <a href="#">CCDF – complementary cumulative distribution function</a> .....	415
• <a href="#">Constellation</a> .....	416
• <a href="#">Constellation vs carrier</a> .....	417
• <a href="#">Error vs carrier</a> .....	417
• <a href="#">Error vs preamble</a> .....	417
• <a href="#">EVM vs carrier</a> .....	417
• <a href="#">EVM vs chip</a> .....	418
• <a href="#">EVM vs symbol</a> .....	418
• <a href="#">FFT spectrum</a> .....	419
• <a href="#">Group delay</a> .....	419
• <a href="#">Magnitude capture</a> .....	420
• <a href="#">Phase tracking</a> .....	420
• <a href="#">Power vs time (PVT)</a> .....	420
• <a href="#">Signal field</a> .....	421
• <a href="#">Spectrum flatness</a> .....	421
• <a href="#">Unused tone error</a> .....	421

#### 10.9.4.1 AM/AM

For each sample, the x-axis value represents the amplitude of the reference-signal and the y-axis value represents the amplitude of the measured-signal.

Note: The measured signal and reference signal are complex signals.

#### 10.9.4.2 AM/PM

For each sample, the x-axis value represents the amplitude of the reference signal. The y-axis value represents the angle difference of the measured signal minus the reference signal.

Note: The measured signal and reference signal are complex signals.

#### 10.9.4.3 AM/EVM

For each sample, the x-axis value represents the amplitude of the reference-signal. The y-axis value represents the length of the error vector between the measured signal and the reference signal.

Note: The measured signal and reference signal are complex signals.

#### 10.9.4.4 Bitstream

Data is returned depending on the selected standard for which the measurement was executed (see [CONFigure:STANdard](#) on page 236):

**IEEE 802.11a, ac, g (OFDM), j, n, p standard (OFDM physical layers)**

For a given OFDM symbol and a given subcarrier, the bitstream result is derived from the corresponding complex constellation point according to *Std IEEE802.11-2012 "Figure 18-10—BPSK, QPSK, 16-QAM, and 64-QAM constellation bit encoding"*. The bit pattern (binary representation) is converted to its equivalent integer value as the final measurement result. The number of values returned for each analyzed OFDM symbol corresponds to the number of data subcarriers plus the number of pilot subcarriers ( $N_{SD}+N_{SP}$ ) in remote mode.



As opposed to the graphical "Bitstream" results, the DC and NULL carriers are not available in remote mode.

Standard	CBW in MHz	$N_{SD}$ (Number of data subcarriers)	$N_{SP}$ (Number of pilot subcarriers)	$N_{ST}$ (Total number of subcarriers: $N_{SD}+N_{SP}$ )
IEEE 802.11a, p	5	48	4	52
IEEE 802.11a, j, p	10	48	4	52
IEEE 802.11a, j, p	20	48	4	52
IEEE 802.11n	20	52	4	56
IEEE 802.11n	40	108	6	114
IEEE 802.11ac	20	52	4	56
IEEE 802.11ac	40	108	6	114
IEEE 802.11ac	80	234	8	242
IEEE 802.11ac	160	468	16	484

**IEEE 802.11b and g (DSSS) standard (DSSS physical layers)**

For the IEEE 802.11b and g (DSSS) standard, the data is returned in PPDU order. Each PPDU is represented as a series of bytes. For each PPDU, the first 9 or 18 bytes represent the PLCP preamble for short and long PPDU types, respectively. The next 6 bytes represent the PLCP header. The remaining bytes represent the PSDU. Data is returned in ASCII printable hexadecimal character format.

TRACE1 is used for these measurement results.

**10.9.4.5 CCDF – complementary cumulative distribution function**

The length of the results varies; up to a maximum of 201 data points is returned, following a data count value. The first value in the return data represents the quantity of probability values that follow. Each of the potential 201 data points is returned as a probability value and represents the total number of samples that are equal to or exceed the current mean power level.

Probability data is returned up to the power level that contains at least one sample. It is highly unlikely that the full 201 data values will ever be returned.

Each probability value is returned as a floating point number, with a value between 0 and 1.

The syntax of the result is thus:

N, "CCDF"(0), "CCDF"(1/10), "CCDF"(2/10), ..., "CCDF"((N-1)/10)

#### 10.9.4.6 Constellation

This measurement represents the complex constellation points as I and Q data. See for example IEEE Std. 802.11-2012 'Fig. 18-10 BPSK, QPSK, 16-QAM and 64-QAM constellation bit encoding'. Each I and Q point is returned in floating point format.

Data is returned as a repeating array of interleaved I and Q data in groups of selected carriers per OFDM-Symbol, until all the I and Q data for the analyzed OFDM-Symbols is exhausted.

The following carrier selections are possible:

- "All Carriers": `CONFigure:BURSt:CONStellation:CARRier:SElect ALL`  
 $N_{ST}$  pairs of I and Q data per OFDM-Symbol  
 OFDM-Symbol 1:  $(I_{1,1}, Q_{1,1}), (I_{1,2}, Q_{1,2}), \dots, (I_{1,Nst}, Q_{1,Nst})$   
 OFDM-Symbol 2:  $(I_{2,1}, Q_{2,1}), (I_{2,2}, Q_{2,2}), \dots, (I_{2,Nst}, Q_{2,Nst})$   
 ...  
 OFDM-Symbol N:  
 $(I_{N,1}, Q_{N,1}), (I_{N,2}, Q_{N,2}), \dots, (I_{N,Nst}, Q_{N,Nst})$
- "Pilots Only": `CONFigure:BURSt:CONStellation:CARRier:SElect PILOTS`  
 $N_{SP}$  pairs of I and Q data per OFDM-Symbol in the natural number order.  
 OFDM-Symbol 1:  $(I_{1,1}, Q_{1,1}), (I_{1,2}, Q_{1,2}), \dots, (I_{1,Nsp}, Q_{1,Nsp})$   
 OFDM-Symbol 2:  $(I_{2,1}, Q_{2,1}), (I_{2,2}, Q_{2,2}), \dots, (I_{2,Nsp}, Q_{2,Nsp})$   
 ...  
 OFDM-Symbol N:  
 $(I_{N,1}, Q_{N,1}), (I_{N,2}, Q_{N,2}), \dots, (I_{N,Nsp}, Q_{N,Nsp})$
- Single carrier:  
 1 pair of I and Q data per OFDM-Symbol for the selected carrier  
`CONFigure:BURSt:CONStellation:CARRier:SElect k`  
 With  
 $k \in \left\{ -\frac{(N_{used} - 1)}{2}, -\frac{(N_{used} - 1)}{2} + 1, \dots, \frac{(N_{used} - 1)}{2} \right\}$   
 OFDM-Symbol 1:  $(I_{1,1}, Q_{1,1})$   
 OFDM-Symbol 2:  $(I_{2,1}, Q_{2,1})$   
 ...  
 OFDM-Symbol N:  $(I_{N,1}, Q_{N,1})$



#### 10.9.4.7 Constellation vs carrier

This measurement represents the complex constellation points as I and Q data. See for example IEEE Std. 802.11-2012 'Fig. 18-10 BPSK, QPSK, 16-QAM and 64-QAM constellation bit encoding'. Each I and Q point is returned in floating point format. Data is returned as a repeating array of interleaved I and Q data in groups of  $N_{\text{used}}$  subcarriers per OFDM-Symbol, until all the I and Q data for the analyzed OFDM-Symbols is exhausted.

Note that as opposed to the "Constellation" results, the DC/null subcarriers are included as NaNs.

$N_{\text{used}}$  pairs of I and Q data per OFDM-Symbol

OFDM-Symbol 1:  $(I_{1,1}, Q_{1,1}), (I_{1,2}, Q_{1,2}), \dots, (I_{1,N_{\text{used}}}, Q_{1,N_{\text{used}}})$

OFDM-Symbol 2:  $(I_{2,1}, Q_{2,1}), (I_{2,2}, Q_{2,2}), \dots, (I_{2,N_{\text{used}}}, Q_{2,N_{\text{used}}})$

...

OFDM-Symbol N:

$(I_{N,1}, Q_{N,1}), (I_{N,2}, Q_{N,2}), \dots, (I_{N,N_{\text{used}}}, Q_{N,N_{\text{used}}})$

#### 10.9.4.8 Error vs carrier

Three trace types are provided for gain imbalance/quadrature error evaluation:

TRACE1	The minimum gain imbalance/quadrature error value - over the analyzed PPDU's - for each of the $N_{\text{used}}$ subcarriers
TRACE2	The average gain imbalance/quadrature error value - over the analyzed PPDU's - for each of the $N_{\text{used}}$ subcarriers
TRACE3	The maximum gain imbalance/quadrature error value - over the analyzed PPDU's - for each of the $N_{\text{used}}$ subcarriers

Each gain imbalance/quadrature error value is returned as a floating point number, expressed in units of dB.

Supported data formats (see [FORMat \[ :DATA \]](#) on page 407): ASCii|UINT

#### 10.9.4.9 Error vs preamble

Three traces types are available for frequency or phase error measurement. The basic trace types show either the minimum, mean or maximum frequency or phase value as measured over the preamble part of the PPDU.

Supported data formats (see [FORMat \[ :DATA \]](#) on page 407): ASCii|REAL

#### 10.9.4.10 EVM vs carrier

Three trace types are provided for this evaluation:

**Table 10-15: Query parameter and results for EVM vs Carrier**

TRACE1	The minimum EVM value - over the analyzed PPDU's - for each of the $N_{\text{used}}$ subcarriers
TRACE2	The average EVM value - over the analyzed PPDU's - for each of the $N_{\text{used}}$ subcarriers
TRACE3	The maximum EVM value - over the analyzed PPDU's - for each of the $N_{\text{used}}$ subcarriers

Each EVM value is returned as a floating point number, expressed in units of dB.

Supported data formats (see [FORMat \[:DATA\]](#) on page 407): ASCii|UINT

**Example:**

For  $EVM_{m,n}$ : the EVM of the m-th analyzed PPDU for the subcarrier  $n = \{1, 2, \dots, N_{\text{used}}\}$

TRACE1: Minimum EVM value per subcarrier

Minimum( $EVM_{1,1}$ ,  $EVM_{2,1}$ , ...,  $EVM_{\text{Statistic Length},1}$ ),

//Minimum EVM value for subcarrier  $-(N_{\text{used}}-1)/2$

Minimum( $EVM_{1,2}$ ,  $EVM_{2,2}$ , ...,  $EVM_{\text{Statistic Length},2}$ ),

// Minimum EVM value for subcarrier  $-(N_{\text{used}}-1)/2 + 1$

...

Minimum( $EVM_{1,N_{\text{used}}}$ ,  $EVM_{2,N_{\text{used}}}$ , ...,  $EVM_{\text{Statistic Length},N_{\text{used}}}$ )

// Minimum EVM value for subcarrier  $+(N_{\text{used}}-1)/2$

**10.9.4.11 EVM vs chip**

These results are **only** available for single-carrier measurements (**IEEE 802.11b, g (DSSS)**).

Since the R&S FSW WLAN application provides two different methods to calculate the EVM, two traces are available:

TRACE1	EVM IEEE values
TRACE2	EVM Direct values

Each trace shows the EVM value as measured over the complete capture period.

The number of repeating groups that are returned is equal to the number of measured chips.

Each EVM value is returned as a floating point number, expressed in units of dBm.

Supported data formats (see [FORMat \[:DATA\]](#) on page 407): ASCii|REAL

**10.9.4.12 EVM vs symbol**

Three traces types are available with this measurement. The basic trace types show either the minimum, mean or maximum EVM value, as measured over the complete capture period.

The number of repeating groups that are returned is equal to the number of measured symbols.

Each EVM value is returned as a floating point number, expressed in units of dBm.

Supported data formats (see [FORMat \[ :DATA \]](#) on page 407): ASCii|REAL

TRACE1	Minimum EVM values
TRACE2	Mean EVM values
TRACE3	Maximum EVM values

These results are **not** available for single-carrier measurements (**IEEE 802.11b, g (DSSS)**).

#### 10.9.4.13 FFT spectrum

Returns the power vs frequency values obtained from the FFT. This is an exhaustive call, due to the fact that there are nearly always more FFT points than I/Q samples. The number of FFT points is a power of 2 that is higher than the total number of I/Q samples, i.e.; number of FFT points := round number of I/Q-samples to next power of 2.

E.g. if there were 20000 samples, then 32768 FFT points are returned.

Data is returned in floating point format in dBm.

#### 10.9.4.14 Group delay

Currently the following trace types are provided with this measurement:

- TRACE2  
A repeating list of group delay values for each subcarrier. The number of repeating lists corresponds to the number of fully analyzed PPDU's as displayed in the current "Magnitude Capture". Each group delay value is returned as a floating point number, expressed in units of seconds.

**Example:**

For  $GD_{m,n}$ : the group delay of the m-th analyzed PPDU for the subcarrier corresponding to  $n = \{1, 2, \dots, N_{used}\}$ ;

```
TRACE:DATA? TRACE2
```

Analyzed PPDU 1:

$GD_{1,1}, GD_{1,2}, \dots,$

Analyzed PPDU 2:

$GD_{2,1}, GD_{2,2}, \dots,$

...

Analyzed PPDU N :

$GD_{N,1}, GD_{N,2}, \dots,$

**10.9.4.15 Magnitude capture**

Returns the magnitude for each measurement point as measured over the complete capture period. The number of measurement points depends on the input sample rate and the capture time (see ["Input Sample Rate"](#) on page 128 and ["Capture Time"](#) on page 128).

If I/Q noise cancellation is enabled, the captured I/Q data for the last capture of the averaging process is returned.

**10.9.4.16 Phase tracking**

Returns the average phase tracking result per symbol (in Radians).

These results are **not** available for single-carrier measurements (**IEEE 802.11b, g (DSSS)**).

**10.9.4.17 Power vs time (PVT)**

All complete PPDU within the capture time are analyzed in three primary PPDU. The three primary PPDU relate to the minimum, maximum and average values across all complete PPDU. This data is returned in dBm values on a per sample basis. Each sample relates to an analysis of each corresponding sample within each processed PPDU.

For PVT Rising and PVT Falling displays, the results are restricted to the rising or falling edge of the analyzed PPDU.

The type of PVT data returned is determined by the TRACE number passed as an argument to the SCPI command:

TRACE1	minimum PPDU data values
TRACE2	mean PPDU data values
TRACE3	maximum PPDU data values

Supported data formats (see [FORMat \[:DATA\]](#) on page 407): `ASCIi|REAL`

#### 10.9.4.18 Signal field

The bits are returned as read from the corresponding signal field parts in transmit order. I.e. the first transmitted bit has the highest significance and the last transmitted bit has the lowest significance.

See also "[Signal Field](#)" on page 52

The `TRAC:DATA?` command returns the information as read from the signal field for each analyzed PPDU. The signal field bit sequence is converted to an equivalent sequence of hexadecimal digits for each analyzed PPDU in transmit order.



For **IEEE 802.11ax, be**, the data is displayed in the "Value" column of the Signal Fields table. To retrieve all values from the table in human-readable format, use `FETCh:SFieLd:ALL?` on page 390.

#### 10.9.4.19 Spectrum flatness

The spectrum flatness evaluation returns absolute power values per carrier (in dBm).

Two trace types are provided for this evaluation:

*Table 10-16: Query parameter and results for Spectrum Flatness*

TRACE1	An average spectrum flatness value for each of the 53 (or 57/117 within the IEEE 802.11 n standard) carriers
TRACE2	All spectrum flatness values per channel

Supported data formats (see [FORMat \[:DATA\]](#) on page 407): `ASCIi|REAL`

#### 10.9.4.20 Unused tone error

Returns a comma-separated list of EVM values in dB. One value is provided for each measurement point. The maximum number of measurement points is 37 (up to 37 RU26 groups in an 80 MHz channel).

The type of EVM data returned is determined by the TRACE number passed as an argument to the SCPI command:

TRACE1	Minimum EVM data values
TRACE2	Mean EVM data values
TRACE3	Maximum EVM data values

Supported data formats (see [FORMat \[:DATA\]](#) on page 407): `ASCIi|REAL`

### 10.9.5 Retrieving captured I/Q data

The raw captured I/Q data is output in the form of a list.

<a href="#">TRACe:IQ:DATA?</a> .....	422
<a href="#">TRACe:IQ:DATA:MEMory?</a> .....	422

---

#### TRACe:IQ:DATA?

Initiates a measurement with the current settings and returns the captured data from I/Q measurements.

Corresponds to:

```
INIT:IMM;*WAI;:TRACe:IQ:DATA:MEMory?
```

However, the `TRACe:IQ:DATA?` command is quicker in comparison.

#### Return values:

<Results>                      Measured voltage for I and Q component for each sample that has been captured during the measurement.  
Default unit: V

#### Example:

```
TRAC:IQ:STAT ON
Enables acquisition of I/Q data
TRAC:IQ:SET NORM,10MHz,32MHz,EXT,POS,0,4096
Measurement configuration:
Sample Rate = 32 MHz
Trigger Source = External
Trigger Slope = Positive
Pretrigger Samples = 0
Number of Samples = 4096
FORMat REAL,32
Selects format of response data
TRAC:IQ:DATA?
Starts measurement and reads results
```

**Usage:**                      Query only

---

#### TRACe:IQ:DATA:MEMory? [<OffsetSamples>,<NoOfSamples>]

Queries the I/Q data currently stored in the capture buffer of the FSW.

By default, the command returns all I/Q data in the memory. You can, however, narrow down the amount of data that the command returns using the optional parameters.

If no parameters are specified with the command, the entire trace data is retrieved.

In this case, the command returns the same results as `TRACe:IQ:DATA?`. (Note, however, that the `TRAC:IQ:DATA?` command initiates a new measurement before returning the captured values, rather than returning the existing data in the memory.)

The command returns a comma-separated list of the measured values in floating point format (comma-separated values = CSV). The number of values returned is 2 \* the number of complex samples.

The total number of complex samples is displayed in the channel bar in manual operation and can be calculated as:

`<SampleRate> * <CaptureTime>`

**Query parameters:**

`<OffsetSamples>` Selects an offset at which the output of data should start in relation to the first data. If omitted, all captured samples are output, starting with the first sample.

Range: 0 to `<# of samples> - 1`, with `<# of samples>` being the maximum number of captured values

\*RST: 0

`<NoOfSamples>` Number of samples you want to query, beginning at the offset you have defined. If omitted, all captured samples (starting at offset) are output.

Range: 1 to `<# of samples> - <offset samples>` with `<# of samples>` maximum number of captured values

\*RST: `<# of samples>`

**Return values:**

`<IQData>` Measured value pair (I,Q) for each sample that has been recorded.

The first half of the list contains the I values, the second half the Q values.

The data format of the individual values depends on [FORMat \[ : DATA \]](#) on page 407.

Default unit: V

**Example:**

```
// Perform a single I/Q capture.
INIT; *WAI
// Determine output format (binary float32)
FORMat REAL,32
// Read 1024 I/Q samples starting at sample 2048.
TRAC:IQ:DATA:MEM? 2048,1024
```

**Usage:** Query only

### 10.9.6 Importing and exporting I/Q data and results

The I/Q data to be evaluated in the R&S FSW WLAN application can not only be measured by the R&S FSW WLAN application itself, it can also be imported to the application, provided it has the correct format. Furthermore, the evaluated I/Q data from the R&S FSW WLAN application can be exported for further analysis in external applications.

For details on importing and exporting I/Q data see the FSW base unit user manual.

MMEMory:LOAD:IQ:STATe.....	424
MMEMory:STORe<n>:IQ:COMMeNt.....	424
MMEMory:STORe<n>:IQ:FORMat.....	424
MMEMory:STORe<n>:IQ:STATe.....	425
MMEMory:STORe<n>:IQNC:STATe.....	425

---

### MMEMory:LOAD:IQ:STATe 1, <FileName>

Restores I/Q data from a file.

#### Setting parameters:

<FileName> string  
String containing the path and name of the source file.  
The file type is determined by the file extension. If no file extension is provided, the file type is assumed to be `.iq.tar`.  
For `.mat` files, Matlab® v4 is assumed.

**Example:** `MMEM:LOAD:IQ:STAT 1, 'C:\R_S\Instr\user\data.iqw'`  
Loads IQ data from the specified file.

**Usage:** Setting only

---

### MMEMory:STORe<n>:IQ:COMMeNt <Comment>

Adds a comment to a file that contains I/Q data.

#### Suffix:

<n> irrelevant

#### Parameters:

<Comment> String containing the comment.

**Example:** `MMEM:STOR:IQ:COMM 'Device test 1b'`  
Creates a description for the export file.  
`MMEM:STOR:IQ:STAT 1, 'C:\R_S\Instr\user\data.iq.tar'`  
Stores I/Q data and the comment to the specified file.

---

### MMEMory:STORe<n>:IQ:FORMat <Format>, <DataFormat>

Sets or queries the format of the I/Q data to be stored.

#### Suffix:

<n> irrelevant

#### Parameters:

<Format> **FLOat32**  
32-bit floating point format.  
**INT32**  
32-bit integer format.



\*RST: FLOat32

<DataFormat> **COMPLex**  
Exports complex data.

**REAL**  
Exports real data.

\*RST: COMPLex

**Example:** MMEM:STOR:IQ:FORM INT32,REAL

### MMEMory:STORe<n>:IQ:STATe <1>, <FileName>

Writes the captured I/Q data to a file.

By default, the contents of the file are in 32-bit floating point format.

#### Suffix:

<n> 1..n

#### Parameters:

<1>

<FileName> String containing the path and name of the target file.  
The file type is determined by the file extension. If no file extension is provided, the file type is assumed to be `.iq.tar`.  
For `.mat` files, Matlab® v4 is assumed.

**Example:** MMEM:STOR:IQ:STAT 1, 'C:\R\_S\Instr\user\data.iq.tar'  
Stores the captured I/Q data to the specified file.

**Usage:** Asynchronous command

### MMEMory:STORe<n>:IQNC:STATe 1, <FileName>

Exports the I/Q data for a single PPDU with the analyzer noise removed to a file.

Prerequisites for this command:

- Turn on I/Q noise cancellation.  
(See [\[SENSe:\]ADJust:NCANcel:AVERage\[:STATe\]](#)).

#### Suffix:

<n> irrelevant

#### Parameters:

1

<FileName> String containing the path and name of the file.  
The file extension is `.iq.tar`.

**Example:** //Export corrected I/Q data  
ADJ:NCAN:AVER ON  
MMEM:STOR:IQNC:STAT 1,'c:\corrected\_iqdata'

**Manual operation:** See "Magnitude Capture" on page 41  
See "IQNC I/Q Export" on page 205

## 10.9.7 Exporting trace results

Trace results can be exported to a file.

For more commands concerning data and results storage see the "Data Management" chapter in the FSW base unit user manual.

MMEMory:STORe<n>:TRACe.....	426
FORMat:DEXPort:DSEParator.....	426

---

### MMEMory:STORe<n>:TRACe <Trace>, <Filename>

Exports trace data from the specified window to an ASCII file.

#### Secure User Mode

In secure user mode, settings that are stored on the instrument are stored to volatile memory, which is restricted to 256 MB. Thus, a "memory limit reached" error can occur although the hard disk indicates that storage space is still available.

To store data permanently, select an external storage location such as a USB memory device.

For details, see "Protecting Data Using the Secure User Mode" in the "Data Management" section of the FSW base unit user manual.

#### Suffix:

<n>                      Window

#### Setting parameters:

<Trace>                      Number of the trace to be stored  
<Filename>                      String containing the path and name of the target file.

#### Example:

MMEM:STOR1:TRAC 1, 'C:\TEST.ASC'  
Stores trace 1 from window 1 in the file TEST.ASC.

#### Usage:

Setting only

---

### FORMat:DEXPort:DSEParator <Separator>

Selects the decimal separator for data exported in ASCII format.

#### Parameters:

<Separator>                      **COMMa**  
Uses a comma as decimal separator, e.g. 4,05.  
**POINT**  
Uses a point as decimal separator, e.g. 4.05.  
**\*RST:**                      \*RST has no effect on the decimal separator.  
Default is POINT.

**Example:**                   FORM:DEXP:DSEP POIN  
Sets the decimal point as separator.

## 10.10 Analysis

The following commands define general result analysis settings concerning the traces and markers in standard WLAN measurements. Currently, only one (Clear/Write) trace and one marker are available for standard WLAN measurements.



### Analysis for RF measurements

General result analysis settings concerning the trace, markers, lines etc. for RF measurements are identical to the analysis functions in the Spectrum application except for some special marker functions and spectrograms, which are not available in the R&S FSW WLAN application.

For details see the "General Measurement Analysis and Display" chapter in the FSW base unit user manual.

- [Markers](#)..... 427

### 10.10.1 Markers

Markers help you analyze your measurement results by determining particular values in the diagram. Currently, only 1 marker per window can be configured for standard WLAN measurements.

<a href="#">CALCulate&lt;n&gt;:DELTaMarker&lt;m&gt;:AOFF</a> .....	427
<a href="#">CALCulate&lt;n&gt;:MARKer&lt;m&gt;:AOFF</a> .....	428
<a href="#">CALCulate&lt;n&gt;:MARKer&lt;m&gt;[:STATe]</a> .....	428
<a href="#">CALCulate&lt;n&gt;:MARKer&lt;m&gt;:Y?</a> .....	428
<a href="#">CALCulate&lt;n&gt;:MARKer&lt;m&gt;:BSYMBol</a> .....	428
<a href="#">CALCulate&lt;n&gt;:MARKer&lt;m&gt;:CARRier</a> .....	429
<a href="#">CALCulate&lt;n&gt;:MARKer&lt;m&gt;:SYMBol</a> .....	429

---

#### **CALCulate<n>:DELTaMarker<m>:AOFF**

Turns off *all* delta markers.

#### **Suffix:**

<n>                    [Window](#)  
<m>                    irrelevant

**Example:**                   CALC:DELT:AOFF  
Turns off all delta markers.

**CALCulate<n>:MARKer<m>:AOFF**

Turns off all markers.

**Suffix:**

<n> [Window](#)

<m> [Marker](#)

**Example:**

CALC:MARK:AOFF  
Switches off all markers.

**CALCulate<n>:MARKer<m>[:STATe] <State>**

Turns markers on and off. If the corresponding marker number is currently active as a delta marker, it is turned into a normal marker.

**Suffix:**

<n> [Window](#)

<m> [Marker](#)

**Parameters:**

<State> ON | OFF | 0 | 1  
**OFF | 0**  
Switches the function off  
**ON | 1**  
Switches the function on

**Example:**

CALC:MARK3 ON  
Switches on marker 3.

**CALCulate<n>:MARKer<m>:Y?**

Queries the result at the position of the specified marker.

**Suffix:**

<n> 1..n

<m> 1..n

**Return values:**

<Result> Default unit: DBM

**Usage:** Query only

**Manual operation:** See "[CCDF](#)" on page 61  
See "[Marker Table](#)" on page 63  
See "[Marker Peak List](#)" on page 64

**CALCulate<n>:MARKer<m>:BSYMBOL <PPDU>, <Symbol>****Suffix:**

<n> 1..n

<m> 1..n

**Parameters:**

<PPDU>

<Symbol>

**CALCulate<n>:MARKer<m>:CARRier <CarrierNo>**

Positions the selected marker to the indicated carrier.

Is query only for the following result displays:

- "Constellation" vs Symbol
- "Constellation" vs Carrier

**Suffix:**

<n> 1..n

<m> 1..n

**Parameters:**

<CarrierNo> integer

**CALCulate<n>:MARKer<m>:SYMBol <Symbol>**

Positions the selected marker to the indicated symbol.

Is query only for the following result displays:

- "Constellation" vs Symbol
- "Constellation" vs Carrier

**Suffix:**

<n> 1..n

<m> 1..n

**Parameters:**

<Symbol> integer

## 10.11 Status registers

The R&S FSW WLAN application uses the standard status registers of the FSW (depending on the measurement type). However, some registers are used differently. Only those differences are described in the following sections.

For details on the common FSW status registers refer to the description of remote control basics in the FSW User Manual.



\*RST does not influence the status registers.

- [The STATUS:QUESTIONABLE:SYNC register](#).....430
- [STATUS:QUESTIONABLE:DIQ register](#).....430
- [Querying the status registers](#).....433

### 10.11.1 The STATUS:QUESTIONABLE:SYNC register

The STATUS:QUESTIONABLE:SYNC register contains application-specific information about synchronization errors or errors during pilot symbol detection. If any errors occur in this register, the status bit #11 in the STATUS:QUESTIONABLE register is set to 1.



Each active channel uses a separate STATUS:QUESTIONABLE:SYNC register. Thus, if the status bit #11 in the STATUS:QUESTIONABLE register indicates an error, the error may have occurred in any of the channel-specific STATUS:QUESTIONABLE:SYNC registers. In this case, you must check the register of each channel to determine which channel caused the error. By default, querying the status of a register always returns the result for the currently selected channel. However, you can specify any other channel name as a query parameter.

*Table 10-17: Meaning of the bits used in the STATUS:QUESTIONABLE:SYNC register*

Bit No.	Meaning
0	PPDU not found This bit is set if an IQ measurement is performed and no PPDU are detected
1	This bit is not used
2	No PPDU of REQuired type This bit is set if an IQ measurement is performed and no PPDU of the specified type are detected
3	Limit check failed
4-6	These bits are not used.
7	I/Q noise cancellation error This bit is set if an error occurs during I/Q noise cancellation, e.g. due to failed synchronization.
8-14	These bits are not used.
15	This bit is always 0.

### 10.11.2 STATUS:QUESTIONABLE:DIQ register

This register contains information about the state of the digital I/Q input and output. This register is used by the optional "Digital Baseband" interface.

The status of the `STATUS:QUESTIONABLE:DIQ` register is indicated in bit 14 of the `STATUS:QUESTIONABLE` register.

You can read out the state of the register with `STATUS:QUESTIONABLE:DIQ:CONDITION?` on page 432 and `STATUS:QUESTIONABLE:DIQ[:EVENT]?` on page 433.

Bit No.	Meaning
0	<p><b>Digital I/Q Input Device connected</b></p> <p>This bit is set if a device is recognized and connected to the "Digital Baseband" interface of the analyzer.</p>
1	<p><b>Digital I/Q Input Connection Protocol in progress</b></p> <p>This bit is set while the connection between analyzer and digital baseband data signal source (e.g. R&amp;S SMW) is established.</p>
2	<p><b>Digital I/Q Input Connection Protocol error</b></p> <p>This bit is set if an error occurred during establishing of the connect between analyzer and digital I/Q data signal source (e.g. R&amp;S SMW) is established.</p>
3	<p><b>Digital I/Q Input PLL unlocked</b></p> <p>This bit is set if the PLL of the Digital I/Q input is out of lock due to missing or unstable clock provided by the connected Digital I/Q TX device. To solve the problem the Digital I/Q connection has to be newly initialized after the clock has been restored.</p>
4	<p><b>Digital I/Q Input DATA Error</b></p> <p>This bit is set if the data from the Digital I/Q input module is erroneous. Possible reasons:</p> <ul style="list-style-type: none"> <li>• Bit errors in the data transmission. The bit will only be set if an error occurred at the current measurement.</li> <li>• Protocol or data header errors. May occur due to data synchronization problems or vast transmission errors. The bit will be set constantly and all data will be erroneous. To solve the problem the Digital I/Q connection has to be newly initialized.</li> </ul> <p>NOTE: If this error is indicated repeatedly either the Digital I/Q LVDS connection cable or the receiving or transmitting device might be defect.</p>
5	Not used
6	<p><b>Digital I/Q Input FIFO Overload</b></p> <p>This bit is set if the sample rate on the connected instrument is higher than the input sample rate setting on the FSW. Possible solution:</p> <ul style="list-style-type: none"> <li>• Reduce the sample rate on the connected instrument</li> <li>• Increase the input sample rate setting on the FSW</li> </ul>
7	Not used
8	<p><b>Digital I/Q Output Device connected</b></p> <p>This bit is set if a device is recognized and connected to the Digital I/Q Output.</p>
9	<p><b>Digital I/Q Output Connection Protocol in progress</b></p> <p>This bit is set while the connection between analyzer and digital I/Q data signal source (e.g. R&amp;S SMW) is established.</p>
10	<p><b>Digital I/Q Output Connection Protocol error</b></p> <p>This bit is set if an error occurred while the connection between analyzer and digital I/Q data signal source (e.g. R&amp;S SMW) is established.</p>

Bit No.	Meaning
11	<b>Digital I/Q Output FIFO Overload</b> This bit is set if an overload of the Digital I/Q Output FIFO occurred. This happens if the output data rate is higher than the maximal data rate of the connected instrument. Reduce the sample rate to solve the problem.
12-14	Not used
15	This bit is always set to 0.

<code>STATus:QUESTIONable:DIQ:CONDition?</code> .....	432
<code>STATus:QUESTIONable:DIQ:ENABLE</code> .....	432
<code>STATus:QUESTIONable:DIQ:NTRansition</code> .....	432
<code>STATus:QUESTIONable:DIQ:PTRansition</code> .....	433
<code>STATus:QUESTIONable:DIQ[:EVENT]?</code> .....	433

---

### **STATus:QUESTIONable:DIQ:CONDition? <ChannelName>**

Reads out the CONDition section of the `STATus:QUESTIONable:DIQ:CONDition` status register.

The command does not delete the contents of the EVENT section.

#### **Query parameters:**

<ChannelName> String containing the name of the channel.  
The parameter is optional. If you omit it, the command works for the currently active channel.

**Example:** `STAT:QUES:DIQ:COND?`

**Usage:** Query only

---

### **STATus:QUESTIONable:DIQ:ENABLE <BitDefinition>, <ChannelName>**

Controls the ENABLE part of a register.

The ENABLE part allows true conditions in the EVENT part of the status register to be reported in the summary bit. If a bit is 1 in the enable register and its associated event bit transitions to true, a positive transition will occur in the summary bit reported to the next higher level.

#### **Parameters:**

<ChannelName> String containing the name of the channel.  
The parameter is optional. If you omit it, the command works for the currently active channel.

#### **Setting parameters:**

<SumBit> Range: 0 to 65535

---

### **STATus:QUESTIONable:DIQ:NTRansition <BitDefinition>, <ChannelName>**

Controls the Negative TRansition part of a register.



Setting a bit causes a 1 to 0 transition in the corresponding bit of the associated register. The transition also writes a 1 into the associated bit of the corresponding EVENT register.

**Parameters:**

<ChannelName> String containing the name of the channel.  
The parameter is optional. If you omit it, the command works for the currently active channel.

**Setting parameters:**

<BitDefinition> Range: 0 to 65535

**STATus:QUESTionable:DIQ:PTRansition** <BitDefinition>,<ChannelName>

Controls the Positive TRansition part of a register.

Setting a bit causes a 0 to 1 transition in the corresponding bit of the associated register. The transition also writes a 1 into the associated bit of the corresponding EVENT register.

**Parameters:**

<ChannelName> String containing the name of the channel.  
The parameter is optional. If you omit it, the command works for the currently active channel.

**Setting parameters:**

<BitDefinition> Range: 0 to 65535

**STATus:QUESTionable:DIQ[:EVENT]?** <ChannelName>

Queries the contents of the "EVENT" section of the STATus:QUESTionable:DIQ register for IQ measurements.

Readout deletes the contents of the "EVENT" section.

**Query parameters:**

<ChannelName> String containing the name of the channel.  
The parameter is optional. If you omit it, the command works for the currently active channel.

**Example:** STAT:QUES:DIQ?

**Usage:** Query only

### 10.11.3 Querying the status registers

The following commands are required to query the status of the FSW and the R&S FSW WLAN application.

For details on the common FSW status registers refer to the description of remote control basics in the FSW User Manual.

- [General status register commands](#)..... 434
- [Reading out the EVENT part](#).....434
- [Reading out the CONDition part](#)..... 435
- [Controlling the ENABle part](#)..... 435
- [Controlling the negative transition part](#).....435
- [Controlling the positive transition part](#)..... 436

### 10.11.3.1 General status register commands

- [STATus:PRESet](#).....434
- [STATus:QUEue\[:NEXT\]?](#)..... 434

---

#### STATus:PRESet

Resets the edge detectors and ENABle parts of all registers to a defined value. All PTRansition parts are set to FFFFh, i.e. all transitions from 0 to 1 are detected. All NTRansition parts are set to 0, i.e. a transition from 1 to 0 in a CONDition bit is not detected. The ENABle part of the STATus:OPERation and STATus:QUEStionable registers are set to 0, i.e. all events in these registers are not passed on.

**Usage:**                   Event

---

#### STATus:QUEue[:NEXT]?

Queries the most recent error queue entry and deletes it.

Positive error numbers indicate device-specific errors, negative error numbers are error messages defined by SCPI. If the error queue is empty, the error number 0, "No error", is returned.

**Usage:**                   Query only

### 10.11.3.2 Reading out the EVENT part

---

#### STATus:OPERation[:EVENT]?

#### STATus:QUEStionable[:EVENT]?

#### STATus:QUEStionable:ACPLimit[:EVENT]? <ChannelName>

#### STATus:QUEStionable:LIMit<n>[:EVENT]? <ChannelName>

#### STATus:QUEStionable:SYNC[:EVENT]? <ChannelName>

Reads out the EVENT section of the status register.

The command also deletes the contents of the EVENT section.

#### Query parameters:

<ChannelName>           String containing the name of the channel.  
The parameter is optional. If you omit it, the command works for the currently active channel.

**Usage:**                   Query only

### 10.11.3.3 Reading out the CONDition part

---

**STATus:OPERation:CONDition?**  
**STATus:QUESTionable:CONDition?**  
**STATus:QUESTionable:ACPLimit:CONDition?** <ChannelName>  
**STATus:QUESTionable:LIMit<n>:CONDition?** <ChannelName>  
**STATus:QUESTionable:SYNC:CONDition?** <ChannelName>

Reads out the CONDition section of the status register.

The command does not delete the contents of the EVENT section.

**Query parameters:**

<ChannelName> String containing the name of the channel.  
 The parameter is optional. If you omit it, the command works for the currently active channel.

**Usage:** Query only

### 10.11.3.4 Controlling the ENABLE part

---

**STATus:OPERation:ENABLE** <SumBit>  
**STATus:QUESTionable:ENABLE** <SumBit>  
**STATus:QUESTionable:ACPLimit:ENABLE** <SumBit>, <ChannelName>  
**STATus:QUESTionable:LIMit<n>:ENABLE** <SumBit>, <ChannelName>  
**STATus:QUESTionable:SYNC:ENABLE** <BitDefinition>, <ChannelName>

Controls the ENABLE part of a register.

The ENABLE part allows true conditions in the EVENT part of the status register to be reported in the summary bit. If a bit is 1 in the enable register and its associated event bit transitions to true, a positive transition will occur in the summary bit reported to the next higher level.

**Parameters:**

<BitDefinition> Range: 0 to 65535  
 <ChannelName> String containing the name of the channel.  
 The parameter is optional. If you omit it, the command works for the currently active channel.

### 10.11.3.5 Controlling the negative transition part

---

**STATus:OPERation:NTRansition** <SumBit>  
**STATus:QUESTionable:NTRansition** <SumBit>  
**STATus:QUESTionable:ACPLimit:NTRansition** <SumBit>, <ChannelName>  
**STATus:QUESTionable:LIMit<n>:NTRansition** <SumBit>, <ChannelName>  
**STATus:QUESTionable:SYNC:NTRansition** <BitDefinition>[, <ChannelName>]

Controls the Negative TRansition part of a register.

Setting a bit causes a 1 to 0 transition in the corresponding bit of the associated register. The transition also writes a 1 into the associated bit of the corresponding EVENT register.

**Parameters:**

<BitDefinition>           Range:     0 to 65535

<ChannelName>           String containing the name of the channel.  
The parameter is optional. If you omit it, the command works for the currently active channel.

**10.11.3.6 Controlling the positive transition part**

---

**STATus:OPERation:PTRansition** <SumBit>  
**STATus:QUESTionable:PTRansition** <SumBit>  
**STATus:QUESTionable:ACPLimit:PTRansition** <SumBit>,<ChannelName>  
**STATus:QUESTionable:LIMit<n>:PTRansition** <SumBit>,<ChannelName>  
**STATus:QUESTionable:SYNC:PTRansition** <BitDefinition>[,<ChannelName>]

These commands control the Positive TRansition part of a register.

Setting a bit causes a 0 to 1 transition in the corresponding bit of the associated register. The transition also writes a 1 into the associated bit of the corresponding EVENT register.

**Parameters:**

<BitDefinition>           Range:     0 to 65535

<ChannelName>           String containing the name of the channel.  
The parameter is optional. If you omit it, the command works for the currently active channel.

**10.12 Deprecated commands**

The following commands are provided only for compatibility to remote control programs from R&S FSW WLAN applications on previous signal analyzers. For new remote control programs use the specified alternative commands.



The **CONF:BURS:<ResultType>:IMM** commands used in former R&S Signal and Spectrum Analyzers to change the result display are still supported for compatibility reasons; however they have been replaced by the **LAY:ADD:WIND** commands in the FSW (see [Chapter 10.7, "Configuring the result display"](#), on page 347). Note that the **CONF:BURS:<ResultType>:IMM** commands change the screen layout to display the "Magnitude Capture" buffer in window 1 at the top of the screen and the selected result type in window 2 below that.

[\[SENSe:\]DEMod:CESTimation](#)..... 437  
[CONFigure:WLAN:GTime:AUTO:TYPE](#).....437  
[DISPlay:WSElect?](#)..... 439

<a href="#">FETCh:BURSt:ALL?</a> .....	439
<a href="#">MMEMory:LOAD:SEM:STATE</a> .....	440
<a href="#">TRIGger[:SEQuence]:MODE</a> .....	440

---

### **[SENSe:]DEMod:CESTimation <State>**

Note that this command is maintained for compatibility reasons only. Use [\[SENSe:\]DEMod:CESTimation:RANGe](#) on page 294 for new remote control programs.

Defines whether channel estimation uses preamble and payload or only preamble. Channel estimation using both the preamble and the payload improves the EVM measurement results.

However, this functionality is not supported by the IEEE 802.11 standard and must be disabled if the results are to be measured strictly according to the standard.

#### **Parameters:**

<State>

ON | OFF | 1 | 0

#### **ON | 1**

The channel estimation is performed using the preamble and the payload. The EVM results can be calculated more accurately.

#### **OFF | 0**

The channel estimation is performed using the preamble only as required in the standard.

\*RST: 0

#### **Example:**

```
[SENSe:]DEMod:CESTimation 1
```

---

### **CONFigure:WLAN:GTIMe:AUTO:TYPE <GuardInterval>**

This remote control command specifies which PPDU's are analyzed depending on their guard length if automatic detection is used (`CONF:WLAN:GTIM:AUTO ON`, see [CONFigure:WLAN:GTIMe:AUTO](#) on page 300).

Note that this command is maintained for compatibility reasons only. Use [CONFigure:WLAN:GTIMe:SElect](#) on page 301 for new remote control programs.

Is available for IEEE 802.11ac, ax, n, be standards only.

**Note:** On previous Rohde & Schwarz signal and spectrum analyzers, this command configured both the guard interval type and the channel bandwidth. On the FSW, this command only configures the guard type. The channel bandwidth of the PPDU to be measured must be configured separately using the [\[SENSe:\]BANDwidth:CHANnel:AUTO:TYPE](#) command.

#### **Parameters:**

<GuardInterval>

#### **FBURst**

The Guard interval length of the first PPDU is detected and subsequent PPDU's are analyzed only if they have the same length (corresponds to "Auto, same type as first PPDU")

**ALL**

All PPDU's are analyzed regardless of their guard length (corresponds to "Auto, individually for each PPDU").

**MS**

Only PPDU's with short guard interval length are analyzed. (corresponds to "Meas only Short" in manual operation; MN8 | MN16 parameters in previous Rohde & Schwarz signal and spectrum analyzers)

**ML**

Only PPDU's with long guard interval length are analyzed. (corresponds to "Meas only Long" in manual operation; ML16 | ML32 parameters in previous Rohde & Schwarz signal and spectrum analyzers)

**DS**

All PPDU's are demodulated assuming short guard interval length. (corresponds to "Demod all as short" in manual operation; DN8 | DN16 parameters in previous Rohde & Schwarz signal and spectrum analyzers)

**DL**

All PPDU's are demodulated assuming long guard interval length. (corresponds to "Demod all as long" in manual operation; DL16 | DL32 parameters in previous Rohde & Schwarz signal and spectrum analyzers)

**L1G1**

Only HE/EHT PPDU's with one guard interval (GI) and one long training field (LTF) with the specified length are analyzed. Not available for HE trigger-based PPDU's. (For IEEE 802.11ax, be only; corresponds to "Meas only 4.0µs (1x HE-LTF + 1x GI1 = 3.2 + 0.8 µs)" in manual operation.)

**L1G2**

Only HE/EHT PPDU's with one long training field (LTF) and two guard intervals (GI) with the specified length are analyzed. For HE trigger-based PPDU's only. (For IEEE 802.11ax, be only; corresponds to "Meas only 4.8µs (1x HE-LTF + 2x GI1 = 3.2 + 1.6µs)" in manual operation.)

**L2G1**

Only HE/EHT PPDU's with two long training field (LTF) and one guard interval (GI) with the specified length are analyzed. (For IEEE 802.11ax, be only; corresponds to "Meas only 7.2µs (2x HE-LTF + 1x GI1 = 6.4 + 0.8µs)" in manual operation.)

**L2G2**

Only HE/EHT PPDU's with two long training fields (LTF) and two guard intervals (GI) with the specified length are analyzed. (For IEEE 802.11ax, be only; corresponds to "Meas only 8.0µs (2x HE-LTF + 2x GI1 = 6.4 + 1.6µs)" in manual operation.)

**L4G1**

Only HE/EHT PPDU with four long training fields (LTF) and one guard interval (GI) with the specified length are analyzed.

(For IEEE 802.11ax,be only; corresponds to "Meas only 13.6µs (4x HE-LTF + 1x GI1 = 12.8 + 0.8µs)" in manual operation.)

**L4G4**

Only HE/EHT PPDU with four guard intervals (GI) and four long training fields (LTF) with the specified length are analyzed.

(For IEEE 802.11ax,be only; corresponds to "Meas only 16.0µs (4x HE-LTF + 4x GI1 = 12.8 + 3.2µs)" in manual operation.)

\*RST: 'ALL'

**Example:**

```
CONF:WLAN:GTIM:AUTO:TYPE DL
```

**Manual operation:**

See ["Guard Interval Length"](#) on page 154

See ["Guard Interval \(GI\) + HE-LTF Size"](#) on page 166

See ["Guard Interval \(GI\) + EHT-LTF Size"](#) on page 174

**DISPlay:WSElect?**

Queries the currently active window (the one that is focused) *in the currently selected measurement channel*.

**Return values:**

<SelectedWindow> Index number of the currently active window.

Range: 1 to 16

**Usage:**

Query only

**FETCh:BURSt:ALL?**

Note that this command is maintained for compatibility reasons only. Use the [FETCh: BURSt:ALL:FORMatted?](#) command for new remote control programs.

Returns all results from the default WLAN measurement (Modulation Accuracy, Flatness and Tolerance). The results are output as a list of result strings separated by commas in ASCII format. The results are output in the following order:

**Return values:**

<Result> <list>

<preamble power>, <payload power>, <min rms power>, <average rms power>, <max rms power>, <peak power>, <min crest factor>, <average crest factor>, <max crest factor>, <min frequency error>, <average frequency error>, <max frequency error>, <min symbol error>, <average symbol error>, <max symbol error>, <min IQ offset>, <average IQ offset>, <maximum IQ offset>, <min gain imbalance>, <average gain imbalance>, <max gain imbalance>, <min quadrature offset>, <average quadrature offset>, <max quadrature offset>, <min EVM all bursts>, <average EVM all bursts>.

<max EVM all bursts>, <min EVM data carriers>,  
 <average EVM data carriers >, <max EVM data carriers>  
 <min EVM pilots>, <average EVM pilots >, <max EVM pilots>  
 <min IQ skew>, <average IQ skew>, <max IQ skew>

**Usage:** Query only

**MMEMory:LOAD:SEM:STATe** <1>, <FileName>

Loads a spectrum emission mask setup from an xml file.

Note that this command is maintained for compatibility reasons only. Use the `SENS:ESP:PRES` command for new remote control programs.

See the FSW User Manual, "Remote commands for SEM measurements" chapter.

**Parameters:**

<1>

<FileName> string  
 Path and name of the .xml file that contains the SEM setup information.

**Example:** `MMEM:LOAD:SEM:STAT 1, '..\sem_std\WLAN\802_11a\802_11a_10MHz_5GHz_band.XML'`

**TRIGger[:SEQuence]:MODE** <Source>

Defines the trigger source.

Note that this command is maintained for compatibility reasons only. Use the `TRIGger[:SEQuence]:SOURce` on page 282 commands for new remote control programs.

Configures how triggering is to be performed.

**Parameters:**

<Source> MANual | IMMEDIATE | EXTernal | VIDeo | RFPower | IFPower | TV | AF | AM | FM | PM | AMRelative | LXI | TIME | SLEFt | SRIGHt | SMPX | SMONo | SSTereo | SRDS | SPILot | BBPower | MASK | PSEnSor | TDTRigger | IQPower | EXT2 | EXT3 | TUNit

## 10.13 Programming examples (R&S FSW WLAN application)

This example demonstrates how to configure a WLAN 802.11 measurement in a remote environment.

- [Measurement 1: measuring modulation accuracy for WLAN 802.11n standard...](#) 441
- [Measurement 2: determining the spectrum emission mask.....](#) 444



### 10.13.1 Measurement 1: measuring modulation accuracy for WLAN 802.11n standard

This example demonstrates how to configure a WLAN IQ measurement for a signal according to WLAN 802.11n standard in a remote environment.

```
//----- Preparing the application -----
// Preset the instrument
*RST
// Enter the WLAN option K91n
INSTrument:SElect WLAN
// Switch to single sweep mode and stop sweep
INITiate:CONTinuous OFF;;ABORT

//----- Configuring the result display -----
// Activate following result displays:
// 1: Magnitude Capture (default, upper left)
// 2: Result Summary Detailed (below Mag Capt)
// 3: Result Summary Global (default, lower right)
// 4: EVM vs Carrier (next to Mag Capt)

LAY:REPL '2',RSD
LAY:ADD:WIND? '1',RIGH,EVC
//Result: '4'

//----- Signal description -----
//Use measurement standard IEEE 802 11n
CONF:STAN 6
//Center frequency is 13.25 GHz
FREQ:CENT 13.25GHZ

//----- Configuring Data Acquisition -----
//Each measurement captures data for 10 ms.
SWE:TIME 10ms
//Set the input sample rate for the captured I/Q data to 20MHz
TRAC:IQ:SRAT 20MHZ
// Number of samples captured per measurement: 0.01s * 20e6 samples per second
// = 200 000 samples
//Include effects from adjacent channels - switch off filter
BAND:FILT OFF

//----- Synchronization -----
//Improve performance - perform coarse burst search initially
SENS:DEM:TXAR ON
//Minimize the intersymbol interference - FFT start offset determined automatically
SENS:DEM:FFT:OFFS AUTO

//----- Tracking and channel estimation -----
//Improve EVM accuracy - estimate channel from preamble and payload
SENS:DEM:CEST ON
```

```

//Use pilot sequence as defined in standard
SENS:TRAC:PIL STAN
//Disable all tracking and compensation functions
SENS:TRAC:LEV OFF
SENS:TRAC:PHAS OFF
SENS:TRAC:TIME OFF

//----- Demodulation -----
//Define a user-defined logical filter to analyze:
SENS:DEM:FORM:BCON:AUTO OFF
//all PPDU formats
SENS:DEM:FORM:BAN:BTYP:AUTO:TYPE ALL
//20MHZ channel bandwidth
SENS:BAND:CHAN:AUTO:TYPE MB20
//an MCS Index '1'
SENS:DEM:FORM:MCS:MODE MEAS
SENS:DEM:FORM:MCS 1
//STBC field = '1'
CONF:WLAN:STBC:AUTO:TYPE M1
//Ness = 1
CONF:WLAN:EXT:AUTO:TYPE M1
//short guard interval length (8 samples)
CONF:WLAN:GTIM:AUTO ON
CONF:WLAN:GTIM:AUTO:TYPE MS

//----- Evaluation range settings -----
//Calculate statistics over 10 PPDU's
SENS:BURS:COUN:STAT ON
SENS:BURS:COUN 10
//Determine payload length from HT signal
CONF:WLAN:PAYL:LENG:SRC HTS
//Payload length: 8-16 symbols
SENS:DEM:FORM:BAN:SYMB:EQU OFF
SENS:DEM:FORM:BAN:SYMB:MIN 8
SENS:DEM:FORM:BAN:SYMB:MAX 16

//----- Measurement settings -----
//Define units for EVM and Gain imbalance results
UNIT:EVM PCT
UNIT:GIMB PCT

//----- Defining Limits -----
//Define non-standard limits for demonstration purposes
//and return to standard limits later.
//Query current limit settings:
CALC:LIM:BURS:ALL?
//Set new limits:
//Average CF error: 5HZ
//max CF error: 10HZ
//average symbol clock error: 5

```

```

//max symbol clock error: 10
//average I/Q offset: 5
//maximum I/Q offset: 10
//average EVM all carriers: 0.1%
//max EVM all carriers: 0.5%
//average EVM data carriers: 0.1%
//max EVM data carriers: 0.5%
//average EVM pilots: 0.1%
//max EVM pilots: 0.5%
CALC:LIM:BURS:ALL 5,10,5,10,5,10,0.1,0.5,0.1,0.5,0.1,0.5

//----- Performing the Measurements -----
// Run 10 (blocking) single measurements
INITiate:IMMEDIATE;*WAI

//----- Retrieving Results -----
//Query the I/Q data from magnitude capture buffer for first ms
// 200 000 samples per second -> 200 samples
TRACel:IQ:DATA:MEMory? 0,200
//Note: result will be too long to display in IECWIN, but is stored in log file
//Query the I/Q data from magnitude capture buffer for second ms
TRACel:IQ:DATA:MEMory? 201,400
//Note: result will be too long to display in IECWIN, but is stored in log file

//Select window 4 (EVM vs carrier)
DISP:WIND4:SEL
//Query the current EVM vs carrier trace
TRAC:DATA? TRACE1
//Note: result will be too long to display in IECWIN, but is stored in log file
//Query the result of the average EVM for all carriers
FETC:BURS:EVM:ALL:AVER?
//Query the result of the EVM limit check for all carriers
CALC:LIM:BURS:ALL:RES?

//Return to standard-defined limits
CALC:LIM:BURS:ALL
//Query the result of the EVM limit check for all carriers again
CALC:LIM:BURS:ALL:RES?

//----- Exporting Captured I/Q Data-----
//Store the captured I/Q data to a file.
MMEStor:IQ:STAT 1, 'C:\R_S\Instr\user\data.iq.tar'

```

### Example of results from a WLAN 802.11 MIMO measurement

```

FETC:BURS:ALL:FORM?

//Global Results from "Result Summary Global" for 11n/11ac standard
-11.0804,-11.0921,-0.9189,    //<preamble power>, <payload power>, <peak power>,

```

## Programming examples (R&amp;S FSW WLAN application)

```

nan,nan,nan, //<min rms power>, <avg rms power>, <max rms power>
nan,nan,nan, //<min crest factor>,<avg crest factor>,<max crest factor>,
199.0661,211.5656,222.7475, //<min freq error>,<avg freq error>, <max freq error>,
-0.0281,0.1477,0.3204, //<min symbol error>, <avg symbol error>, <max symbol error>,
nan,nan,nan, //<min IQ offset>, <avg IQ offset>, <max IQ offset>,
nan,nan,nan, //<min gain imb>, <avg gain imb>, <max gain imb>,
nan,nan,nan, //<min quad offset>, <avg quad offset>, <max quad offset>,
-43.8807,-43.4476,-43.0819, //<min EVM all>, <avg EVM all>, <max EVM all>,
-43.9346,-43.4823,-43.1164, //<min EVM data>, <avg EVM data >, <max EVM data>
-44.0135,-42.5833,-41.7621, //<min EVM pilots>, <avg EVM pilots >, <max EVM pilots>
nan,nan,nan, //<min BER>, <avg BER >, <max BER>
nan,nan,nan, //<min IQ skew>, <avg IQ skew>, <max IQ skew>
nan,nan,nan, //<min MIMO CP>, <avg MIMO CP>, <max MIMO CP>
nan,nan,nan, //<min CPE>, <avg CPE>, <max CPE>

//MIMO Stream 1 Results from "Result Summary Detailed" for 11n/11ac standard
nan,nan,nan, //<preamble power>, <payload power>, <peak power>,
-11.0882,-11.0876,-11.0866, //<min rms power>, <avg rms power>, <max rms power>
10.1580,10.1687,10.1756, //<min crest factor>,<avg crest factor>,<max crest factor>,
199.0661,211.5656,222.7475, //<min freq error>,<avg freq error>, <max freq error>,
-0.0281,0.1477,0.3204, //<min symbol error>, <avg symbol error>, <max symbol error>,
-60.1847,-59.6930,-59.2831, //<min IQ offset>, <avg IQ offset>, <max IQ offset>,
-0.0011,-0.0001,0.0010, //<min gain imb>, <avg gain imb>, <max gain imb>,
-0.0377,-0.0394,-0.0409, //<min quad offset>, <avg quad offset>, <max quad offset>,
-43.8807,-43.4476,-43.0819, //<min EVM all>, <avg EVM all>, <max EVM all>,
-43.9346,-43.4823,-43.1164, //<min EVM data>, <avg EVM data >, <max EVM data>
-44.0135,-42.5833,-41.7621, //<min EVM pilots>, <avg EVM pilots >, <max EVM pilots>
nan,nan,nan, //<min BER>, <avg BER >, <max BER>
1.4105,2.0148,2.4481, //<min IQ skew>, <avg IQ skew>, <max IQ skew>
nan,nan,nan, //<min MIMO CP>, <avg MIMO CP>, <max MIMO CP>
0.0026,-0.1309,-0.6969 //<min CPE>, <avg CPE>, <max CPE>

```

### 10.13.2 Measurement 2: determining the spectrum emission mask

```

//----- Preparing the application -----
*RST
//Reset the instrument
INST:CRE:NEW WLAN,'SEMMeasurement'
//Activate a WLAN measurement channel named "SEMMeasurement"

//----- Configuring the measurement -----
DISP:TRAC:Y:SCAL:RLEV 0
//Set the reference level to 0 dBm
FREQ:CENT 2.1175 GHz
//Set the center frequency to 2.1175 GHz
CONF:BURS:SPEC:MASK
//Select the spectrum emission mask measurement

//----- Performing the Measurement-----

```

```

INIT:CONT OFF
//Stops continuous sweep
SWE:COUN 100
//Sets the number of sweeps to be performed to 100
INIT;*WAI
//Start a new measurement with 100 sweeps and wait for the end

//----- Retrieving Results-----
CALC:LIM:FAIL?
//Queries the result of the limit check
//Result: 0 [passed]
TRAC:DATA? LIST
//Retrieves the peak list of the spectrum emission mask measurement
//Result:
//+1.000000000,-1.275000000E+007,-8.500000000E+006,+1.000000000E+006,
//+2.108782336E+009,-8.057177734E+001,-7.882799530E+001,-2.982799530E+001,
//+0.000000000,+0.000000000,+0.000000000,

//+2.000000000,-8.500000000E+006,-7.500000000E+006,+1.000000000E+006,
//+2.109000064E+009,-8.158547211E+001,-7.984169006E+001,-3.084169006E+001,
//+0.000000000,+0.000000000,+0.000000000,

//+3.000000000,-7.500000000E+006,-3.500000000E+006,+1.000000000E+006,
//+2.113987200E+009,-4.202708435E+001,-4.028330231E+001,-5.270565033,
//+0.000000000,+0.000000000,+0.000000000,

[...]

```

Table 10-18: Trace results for SEM measurement

Range No.	Start freq. [Hz]	Stop freq. [Hz]	RBW [Hz]	Freq. peak power [Hz]	Abs. peak power [dBm]	Rel. peak power [%]	Delta to margin [dB]	Limit check result	-	-	-
1	+1.00000000	-1.27500000E+007	-8.50000000E+006	+1.00000000E+006	+2.108782336E+009	-8.057177734E+001	-7.882799530E+001	-2.982799530E+001	+0.00000000	+0.00000000	+0.00000000
2	+2.00000000	-8.50000000E+006	-7.50000000E+006	+1.00000000E+006	+2.109000064E+009	-8.158547211E+001	-7.984169006E+001	-3.084169006E+001	+0.00000000	+0.00000000	+0.00000000
3	+3.00000000	-7.50000000E+006	-3.50000000E+006	+1.00000000E+006	+2.113987200E+009	-4.202708435E+001	-4.028330231E+001	-5.270565033	+0.00000000	+0.00000000	+0.00000000
...	...										

## Annex

# A Sample rate and maximum usable I/Q bandwidth for RF input

### Definitions

- **Input sample rate (ISR):** the sample rate of the useful data provided by the device connected to the input of the FSW
- (User, Output) **Sample rate (SR):** the user-defined sample rate (e.g. in the "Data Acquisition" dialog box in the "I/Q Analyzer" application) which is used as the basis for analysis or output
- **Usable I/Q (analysis) bandwidth:** the bandwidth range in which the signal remains undistorted in regard to amplitude characteristic and group delay; this range can be used for accurate analysis by the FSW
- **Record length:** the number of I/Q samples to capture during the specified measurement time; calculated as the measurement time multiplied by the sample rate

For the I/Q data acquisition, digital decimation filters are used internally in the FSW. The passband of these digital filters determines the *maximum usable I/Q bandwidth*. In consequence, signals within the usable I/Q bandwidth (passband) remain unchanged, while signals outside the usable I/Q bandwidth (passband) are suppressed. Usually, the suppressed signals are noise, artifacts, and the second IF sideband. If frequencies of interest to you are also suppressed, try to increase the output sample rate, which increases the maximum usable I/Q bandwidth.

### Bandwidth extension options

You can extend the maximum usable I/Q bandwidth provided by the FSW in the basic installation by adding options. These options can either be included in the initial installation (B-options) or updated later (U-options). The maximum bandwidth provided by the individual option is indicated by its number, for example, B40 extends the bandwidth to 40 MHz.

Note that the U-options as of U40 always require all lower-bandwidth options as a prerequisite, while the B-options already include them.

As a rule, the usable I/Q bandwidth is proportional to the output sample rate. Yet, when the I/Q bandwidth reaches the bandwidth of the analog IF filter (at very high output sample rates), the curve breaks.

- [Available bandwidth extension options](#)..... 447
- [Relationship between sample rate, record length and usable I/Q bandwidth](#)..... 447
- [FSW without additional bandwidth extension options](#)..... 449
- [FSW with I/Q bandwidth extension option B40 or U40](#)..... 450
- [FSW with I/Q bandwidth extension option B80 or U80](#)..... 450
- [FSW with activated I/Q bandwidth extension option B160 or U160](#)..... 451
- [FSW with activated I/Q bandwidth extension option B320/U320](#)..... 451

Relationship between sample rate, record length and usable I/Q bandwidth

- FSW with activated I/Q bandwidth extension option B512..... 452
- FSW with activated I/Q bandwidth extension option B1200..... 454
- FSW with activated I/Q bandwidth extension option B2001..... 456
- FSW with activated I/Q bandwidth extension option B2000..... 459
- FSW with activated I/Q bandwidth extension option B5000..... 460

## A.1 Available bandwidth extension options

Table A-1: Available bandwidth extension options

Max. usable I/Q bandwidth	Required B-option	Required U-options
28 MHz	-	-
40 MHz	B40	U40
80 MHz	B80	U40+U80 <b>or</b> B40+U80
160 MHz	B160	U40+U80+U160 <b>or</b> B40+U80+U160 <b>or</b> B80+U160
320 MHz	B320	U40+U80+U160+U320 <b>or</b> B40+U80+U160+U320 <b>or</b> B80+U160+U320 <b>or</b> B160+U320
512 MHz	B512	U40+U80+U512 <b>or</b> B40+U80+U512 <b>or</b> B80+U512 <b>or</b>
1200 MHz	B1200	B40 + U80 + U1200 <b>or</b> B80 + U1200
2000 MHz	B2001	U2001

## A.2 Relationship between sample rate, record length and usable I/Q bandwidth

Up to the maximum bandwidth, the following rule applies:

$$\text{Usable I/Q bandwidth} = 0.8 * \text{Output sample rate}$$

Regarding the record length, the following rule applies:

$$\text{Record length} = \text{Measurement time} * \text{sample rate}$$

**Maximum record length for RF input**

The maximum record length, that is, the maximum number of samples that can be captured, depends on the sample rate.

For activated option B1200, see [Table A-11](#).

For activated option B2001, see [Chapter A.10, "FSW with activated I/Q bandwidth extension option B2001"](#), on page 456.

**Table A-2: Maximum record length (without I/Q bandwidth extension options FSW-B160/-B320/-B512/-B1200/-B2001)**

Sample rate	Maximum record length
100 Hz to 200 MHz	440 Msamples
200 MHz to 20 GHz (upsampling)	220 Msamples

The [Figure A-1](#) shows the maximum usable I/Q bandwidths depending on the output sample rates.



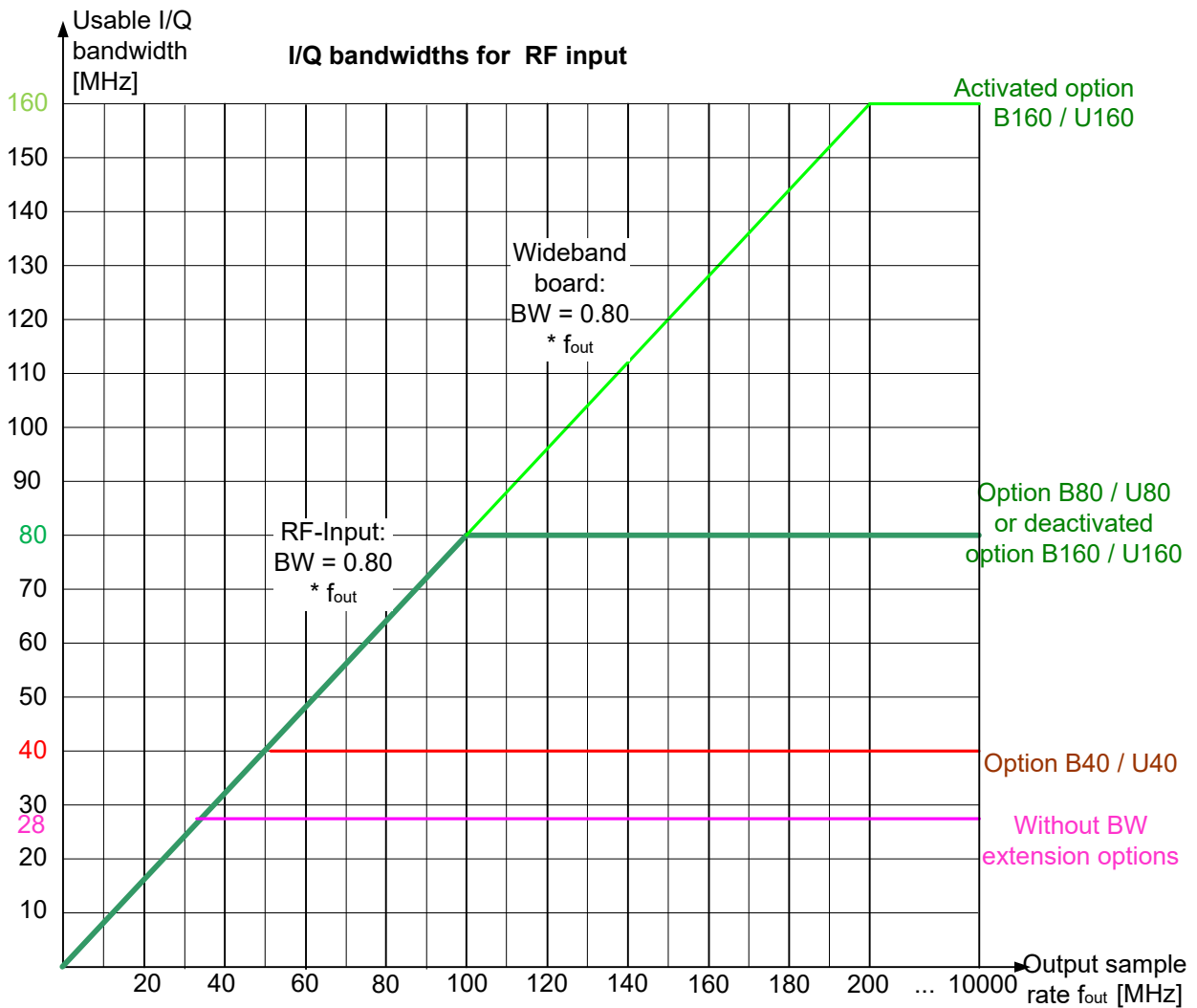

Figure A-1: Relationship between maximum usable I/Q bandwidth and output sample rate with and without bandwidth extensions



#### General notes and restrictions

- In MSRA operating mode, the MSRA primary is restricted to a sample rate of 600 MHz.

### A.3 FSW without additional bandwidth extension options

Sample rate: 100 Hz - 20 GHz

Maximum I/Q bandwidth: 28 MHz

**Table A-3: Maximum I/Q bandwidth**

Sample rate	Maximum I/Q bandwidth
100 Hz to 28 MHz	Proportional up to maximum 28 MHz
28 MHz to 20 GHz	28 MHz

**MSRA operating mode**

In MSRA operating mode, the MSRA primary is restricted to a sample rate of 600 MHz.

## A.4 FSW with I/Q bandwidth extension option B40 or U40

Sample rate: 100 Hz - 20 GHz

Maximum bandwidth: 40 MHz

**Table A-4: Maximum I/Q bandwidth**

Sample rate	Maximum I/Q bandwidth
100 Hz to 50 MHz	Proportional up to maximum 40 MHz
50 MHz to 20 GHz	40 MHz

**MSRA operating mode**

In MSRA operating mode, the MSRA primary is restricted to a sample rate of 600 MHz.

## A.5 FSW with I/Q bandwidth extension option B80 or U80

Sample rate: 100 Hz - 20 GHz

Maximum bandwidth: 80 MHz

**Table A-5: Maximum I/Q bandwidth**

Sample rate	Maximum I/Q bandwidth
100 Hz to 100 MHz	Proportional up to maximum 80 MHz
100 MHz to 20 GHz	80 MHz

**MSRA operating mode**

In MSRA operating mode, the MSRA primary is restricted to a sample rate of 600 MHz.

## A.6 FSW with activated I/Q bandwidth extension option B160 or U160

Sample rate: 100 Hz - 20 GHz

Maximum bandwidth: 160 MHz

*Table A-6: Maximum I/Q bandwidth*

Sample rate	Maximum I/Q bandwidth
100 Hz to 200 MHz	Proportional up to maximum 160 MHz
200 MHz to 20 GHz	160 MHz



### Notes and restrictions for FSW-B160 or U160

- In MSRA operating mode, the MSRA primary is restricted to a sample rate of 600 MHz.

## A.7 FSW with activated I/Q bandwidth extension option B320/U320

*Table A-7: Maximum I/Q bandwidth*

Sample rate	Maximum I/Q bandwidth
100 Hz to 400 MHz	Proportional up to maximum 320 MHz
400 MHz to 20 GHz	320 MHz

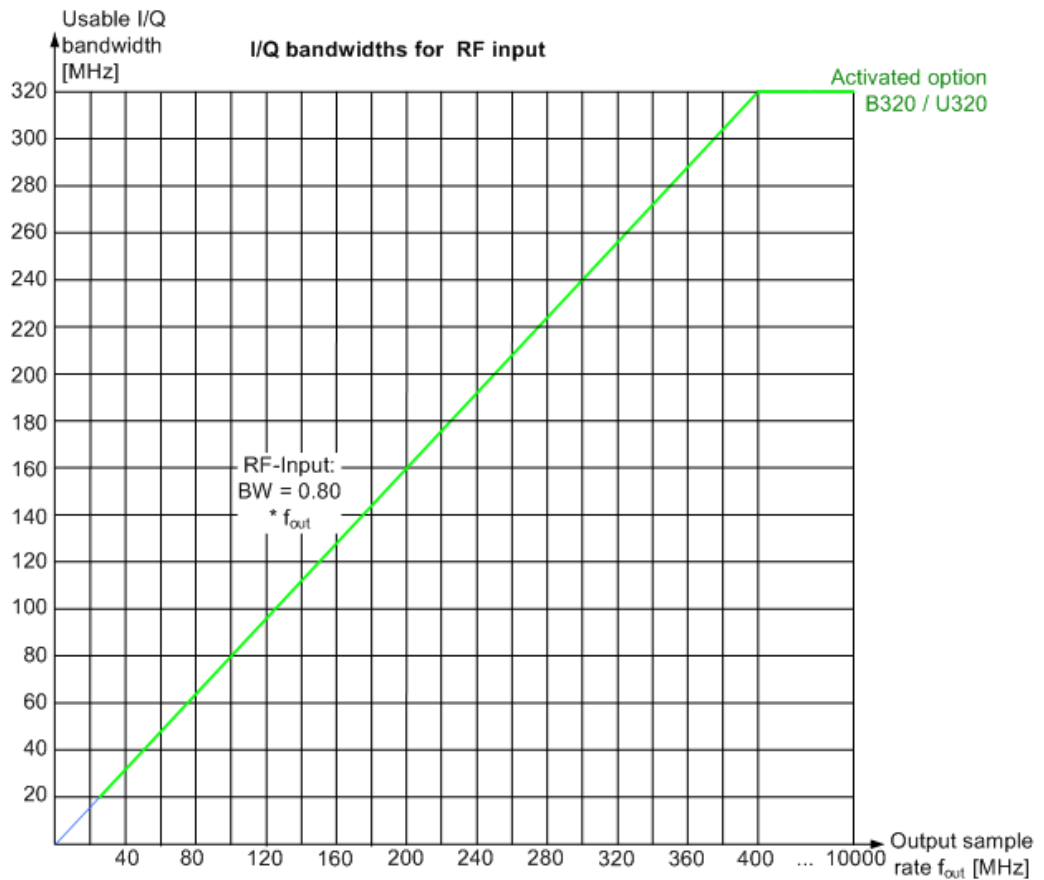

Figure A-2: Relationship between maximum usable I/Q bandwidth and output sample rate for active FSW-B320



#### Notes and restrictions for FSW-B320

- In MSRA operating mode, the MSRA primary is restricted to a sample rate of 600 MHz.

## A.8 FSW with activated I/Q bandwidth extension option B512

The bandwidth extension option FSW-B512 provides measurement bandwidths up to 512 MHz.

Table A-8: Maximum I/Q bandwidth

Sample rate	Maximum I/Q bandwidth
100 Hz to 600 MHz	0.8 * sample rate (up to maximum 512 MHz)
600 MHz to 20 GHz	512 MHz

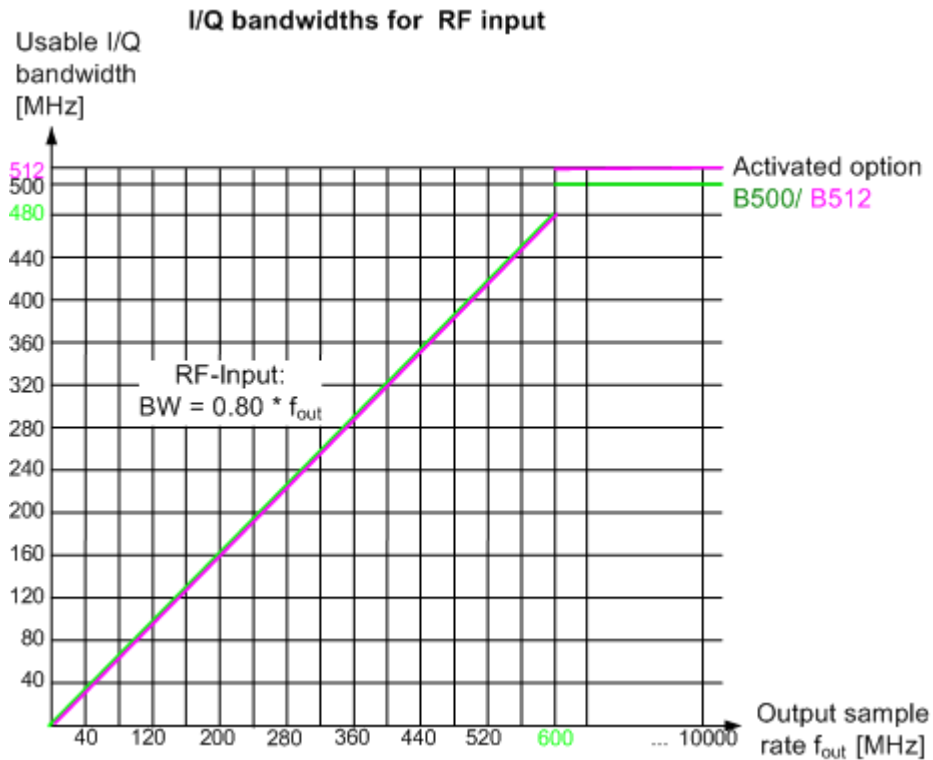

Figure A-3: Relationship between maximum usable I/Q bandwidth and output sample rate for active FSW-B512

Table A-9: Maximum record length with activated I/Q bandwidth extension option FSW-B512

Sample rate	Maximum record length
100 Hz to 20 GHz	440 Msamples



#### Notes and restrictions for FSW-B512

- In MSRA operating mode, the MSRA primary is restricted to a sample rate of 600 MHz and a maximum record length of 220 Msamples.
- The memory extension options FSW-B106/-B108/-B124 are not available together with the -B512 option.



### Bandwidths between 480 MHz and 512 MHz with FSW-B512 option

Note the irregular behavior of the relationship between the sample rate and the usable I/Q bandwidth for bandwidths between 480 MHz and 512 MHz with the -B512 options, depending on which setting you change.

For compatibility reasons, the common relationship is maintained for bandwidths  $\leq 480$  MHz:

$$\text{Usable I/Q bandwidth} = 0.8 * \text{output sample rate}$$

However, to make use of the maximum sample rate of 600 MHz at the maximum bandwidth of 512 MHz, there is an exception. If you **change the bandwidth** between 480 MHz and 500 MHz, the sample rate is adapted according to the relationship:

$$\text{Output sample rate} = \text{usable I/Q bandwidth} / (500/600)$$

Or

$$\text{Output sample rate} = \text{usable I/Q bandwidth} / 0.8333$$

When using option R&S FSW-B512R, if you **change the bandwidth** between 500 MHz and 512 MHz, the sample rate is adapted according to the relationship:

$$\text{Output sample rate} = \text{usable I/Q bandwidth} / (512/600)$$

Or

$$\text{Output sample rate} = \text{usable I/Q bandwidth} / 0.8533$$

On the other hand, if you **decrease the sample rate** under 600 MHz, the I/Q bandwidth is adapted according to the common relationship:

$$\text{Usable I/Q bandwidth} = 0.8 * \text{output sample rate}.$$

## A.9 FSW with activated I/Q bandwidth extension option B1200

The bandwidth extension option FSW-B1200 provides measurement bandwidths up to 1200 MHz.

**Table A-10: Maximum I/Q bandwidth**

Sample rate	Maximum I/Q bandwidth
100 Hz to 600 MHz	0.8 * sample rate
600 MHz	0.8533 * sample rate (=512 MHz)
600 MHz to 1500 MHz	0.8 * sample rate *)
1500 MHz to 20 GHz	1200 MHz
*) Exception: for active digital I/Q 40G streaming output, a sample rate of 1200 MHz provides a maximum I/Q bandwidth of 1000 MHz	

FSW with activated I/Q bandwidth extension option B1200

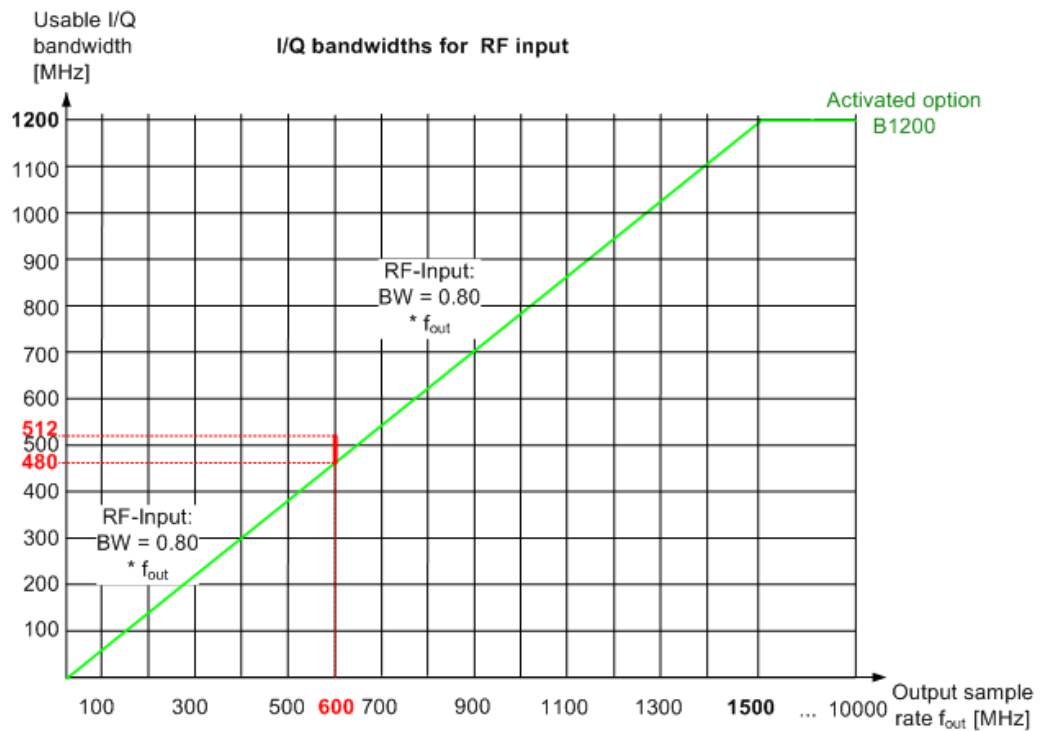

Figure A-4: Relationship between maximum usable I/Q bandwidth and output sample rate for active FSW-B1200

Table A-11: Maximum record length with activated I/Q bandwidth extension option FSW-B1200

Sample rate	Maximum record length
100 Hz to 600 MHz	440 Msamples
600 MHz to 1250 MHz	480 Msamples * (sample rate / 1250 MHz); max. 440 Msamples
1250 MHz to 20 GHz	max. 440 Msamples



#### Notes and restrictions for FSW-B1200

- The memory extension option FSW-B106 is not available together with the B1200 option.
- Real-time measurements, and thus the entire MSRT operating mode, together with the FSW-B1200 bandwidth extension option, are only available with the R&S FSW-K800RE option.  
In MSRT operating mode, the MSRT primary application is then restricted to a sample rate of 1000 MHz.
- In MSRA operating mode, the MSRA primary is restricted to a sample rate of 600 MHz.
- When the FSW-B1200 option is active, only an external trigger (or no trigger) is available.



### Irregular behavior in bandwidths between 480 MHz and R&S FSW512 MHz with FSW-B1200 option

Note that the B1200 bandwidth extension option has the same irregular behavior of the relationship between the sample rate and the usable I/Q bandwidth for bandwidths between 480 MHz and 512 MHz as the B512 option. The FSW uses the same hardware for both options up to 512 MHz.

For compatibility reasons, the common relationship is maintained for bandwidths  $\leq 480$  MHz:

$$\text{Output sample rate} = \text{usable I/Q bandwidth} / 0.8$$

However, to make use of the maximum sample rate of 600 MHz at the maximum bandwidth of 500 MHz, there is an exception. If you **change the bandwidth** between 480 MHz and 500 MHz, the sample rate is adapted according to the relationship:

$$\text{Output sample rate} = \text{usable I/Q bandwidth} / (500/600)$$

Or

$$\text{Output sample rate} = \text{usable I/Q bandwidth} / 0.8333$$

If you **change the bandwidth** between 500 MHz and 512 MHz, the sample rate is adapted according to the relationship:

$$\text{Output sample rate} = \text{usable I/Q bandwidth} / (512/600)$$

Or

$$\text{Output sample rate} = \text{usable I/Q bandwidth} / 0.8533$$

If you increase the bandwidth above 512 MHz, the common relationship is maintained again:

$$\text{Output sample rate} = \text{usable I/Q bandwidth} / 0.8$$

On the other hand, if you **set the sample rate** to **600 MHz**, the I/Q bandwidth is set to:

$$\text{Output sample rate} * 0.8533 = 512 \text{ MHz}$$

However, if you **decrease the sample rate** under 600 MHz or **increase the sample rate** above 600 MHz, the I/Q bandwidth is adapted according to the common relationship:

$$\text{Usable I/Q bandwidth} = 0.8 * \text{output sample rate}.$$

## A.10 FSW with activated I/Q bandwidth extension option B2001

The (internal) bandwidth extension option FSW-B2001 provides measurement bandwidths up to 2 GHz, with no additional devices required.



Table A-12: Maximum I/Q bandwidth

Sample rate	Maximum I/Q bandwidth
100 Hz to 600 MHz	0.8 * sample rate
600 MHz	0.8533 * sample rate (=512 MHz)
600 MHz to 2500 MHz	0.8 * sample rate *)
2500 MHz to 20 GHz	2000 MHz

\*) Exception: for active digital I/Q 40G streaming output, a sample rate of 1200 MHz provides a maximum I/Q bandwidth of 1000 MHz

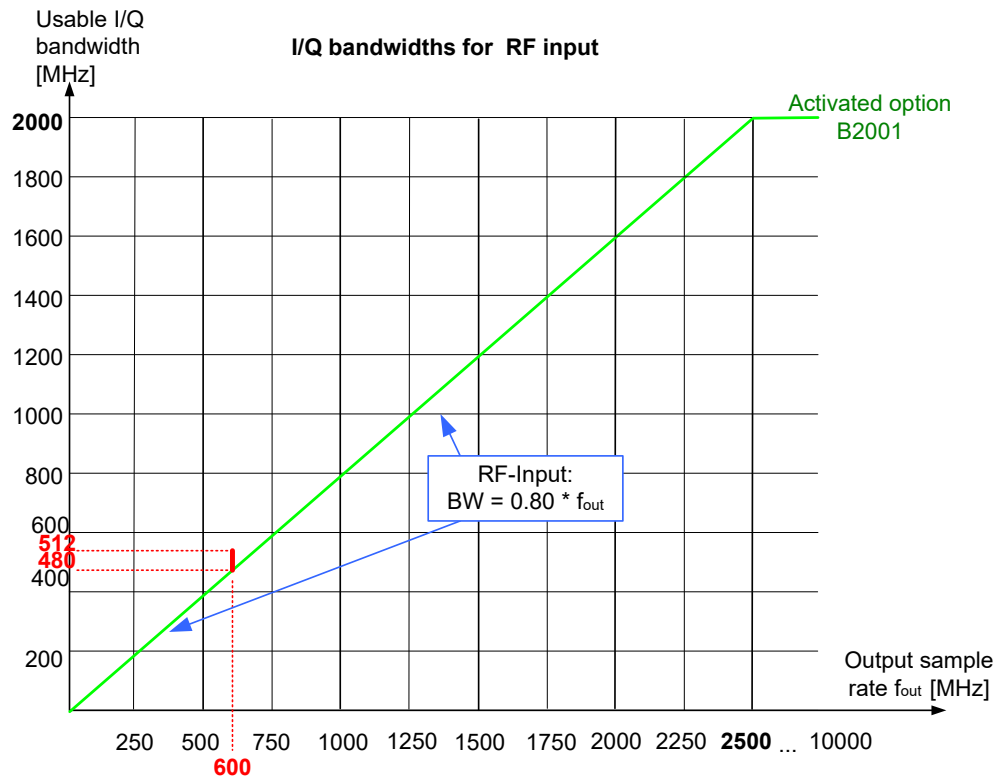

Figure A-5: Relationship between maximum usable I/Q bandwidth and output sample rate for active FSW-B2001

**Notes and restrictions for FSW-B2001**

- The memory extension option FSW-B106 is not available together with the B2001 option.
- Real-time measurements, and thus the entire MSRT operating mode, together with the FSW-B2001 bandwidth extension option, are only available with the R&S FSW-K800RE option.  
In MSRT operating mode, the MSRT primary application is then restricted to a sample rate of 1000 MHz.
- In MSRA operating mode, the MSRA primary is restricted to a sample rate of 600 MHz.
- When the FSW-B2001 option is active, only an external trigger (or no trigger) is available.



### Irregular behavior in bandwidths between 480 MHz and 512 MHz with FSW-B2001 option

Note that the B2001 bandwidth extension option has the same irregular behavior of the relationship between the sample rate and the usable I/Q bandwidth for bandwidths between 480 MHz and 512 MHz as the -B512 options. The FSW uses the same hardware for both options up to 512 MHz.

For compatibility reasons, the common relationship is maintained for bandwidths  $\leq 480$  MHz:

$$\text{Output sample rate} = \text{usable I/Q bandwidth} / 0.8$$

However, to make use of the maximum sample rate of 600 MHz at the maximum bandwidth of 500 MHz, there is an exception. If you **change the bandwidth** between 480 MHz and 500 MHz, the sample rate is adapted according to the relationship:

$$\text{Output sample rate} = \text{usable I/Q bandwidth} / (500/600)$$

Or

$$\text{Output sample rate} = \text{usable I/Q bandwidth} / 0.8333$$

If you **change the bandwidth** between 500 MHz and 512 MHz, the sample rate is adapted according to the relationship:

$$\text{Output sample rate} = \text{usable I/Q bandwidth} / (512/600)$$

Or

$$\text{Output sample rate} = \text{usable I/Q bandwidth} / 0.8533$$

If you increase the bandwidth above 512 MHz, the common relationship is maintained again:

$$\text{Output sample rate} = \text{usable I/Q bandwidth} / 0.8$$

On the other hand, if you **set the sample rate** to **600 MHz**, the I/Q bandwidth is set to:

$$\text{Output sample rate} * 0.8533 = \mathbf{512\ MHz}$$

However, if you **decrease the sample rate** under 600 MHz or **increase the sample rate** above 600 MHz, the I/Q bandwidth is adapted according to the common relationship:

$$\text{Usable I/Q bandwidth} = 0.8 * \text{output sample rate}.$$

## A.11 FSW with activated I/Q bandwidth extension option B2000

The bandwidth extension option FSW-B2000 provides measurement bandwidths up to 2 GHz.

**Table A-13: Maximum I/Q bandwidth**

Sample rate	Maximum I/Q bandwidth
10 kHz to 20 GHz	Proportional up to maximum 2 GHz

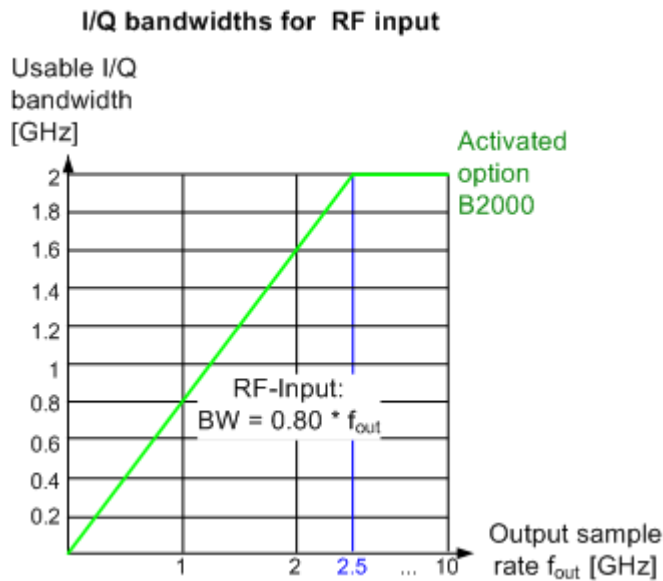

Figure A-6: Relationship between maximum usable I/Q bandwidth and output sample rate for active FSW-B2000



#### Notes and restrictions for FSW-B2000

- The memory extension options FSW-B106/-B108/-B124 are not available together with the B2000 option.
- If the FSW-B2000 bandwidth extension option is active, MSRA operating mode is not available.
- The maximum memory size, and thus record length, available for a single input channel can be reduced by half in the following cases:
  - When using an external trigger in common B2000 mode, which uses another channel on the oscilloscope.
  - In power splitter mode, which uses two input channels on the oscilloscope.
 For details, see the oscilloscope's specifications document and documentation.

## A.12 FSW with activated I/Q bandwidth extension option B5000

The bandwidth extension option FSW-B5000 provides measurement bandwidths up to 5 GHz.

Table A-14: Maximum I/Q bandwidth

Sample rate	Maximum I/Q bandwidth
10 kHz to 20 GHz	Proportional up to maximum 5 GHz

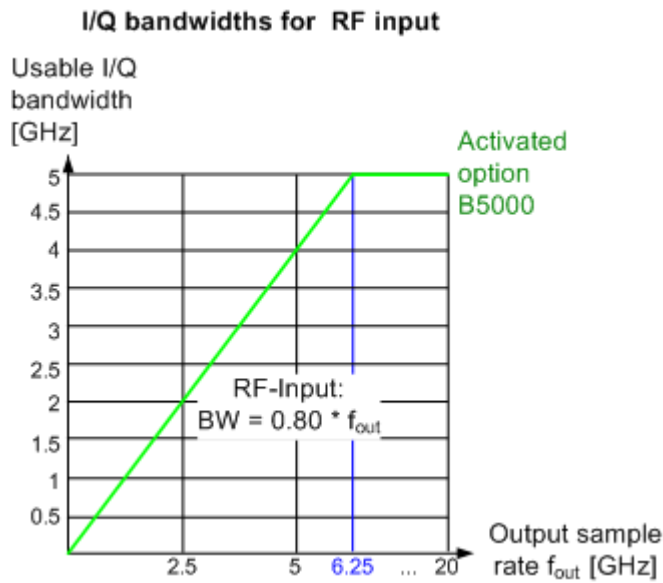

Figure A-7: Relationship between maximum usable I/Q bandwidth and output sample rate for active FSW-B5000



#### Notes and restrictions for FSW-B5000

- The memory extension options FSW-B106/-B108/-B124 are not available together with the B5000 option.
- If the FSW-B5000 bandwidth extension option is active, MSRA operating mode is not available.
- The maximum memory size, and thus record length, available for a single input channel can be reduced by half in the following cases:
  - When using an external trigger in common B5000 mode, which uses another channel on the oscilloscope.
  - In power splitter mode, which uses two input channels on the oscilloscope.
 For details, see the oscilloscope's specifications document and documentation.

## List of commands (WLAN)

[SENSe:]ADJust:CONFigure:HYSTeresis:LOWer.....	338
[SENSe:]ADJust:CONFigure:HYSTeresis:UPPer.....	339
[SENSe:]ADJust:CONFigure:LEVel:DURation.....	339
[SENSe:]ADJust:CONFigure:LEVel:DURation:MODE.....	340
[SENSe:]ADJust:LEVel.....	340
[SENSe:]ADJust:NCANcel:AVERage[:COUNt].....	275
[SENSe:]ADJust:NCANcel:AVERage[:STATe].....	275
[SENSe:]BANDwidth:CHANnel:AUTO.....	301
[SENSe:]BANDwidth:CHANnel:AUTO:TYPE.....	302
[SENSe:]BANDwidth[:RESolution]:FILTer:STATe.....	275
[SENSe:]BURSt:COUNt.....	327
[SENSe:]BURSt:COUNt:SELEct:STATe.....	408
[SENSe:]BURSt:COUNt:STATe.....	327
[SENSe:]BURSt:SELEct.....	327
[SENSe:]BURSt:SELEct:STATe.....	328
[SENSe:]CORRection:CVL:BAND.....	251
[SENSe:]CORRection:CVL:BIAS.....	251
[SENSe:]CORRection:CVL:CATalog?.....	251
[SENSe:]CORRection:CVL:CLEar.....	252
[SENSe:]CORRection:CVL:COMMeNt.....	252
[SENSe:]CORRection:CVL:DATA.....	252
[SENSe:]CORRection:CVL:HARMonic.....	253
[SENSe:]CORRection:CVL:MIXer.....	253
[SENSe:]CORRection:CVL:PORTs.....	253
[SENSe:]CORRection:CVL:SELEct.....	254
[SENSe:]CORRection:CVL:SNUMber.....	254
[SENSe:]DEMod:CEStimation.....	437
[SENSe:]DEMod:CEStimation:RANGe.....	294
[SENSe:]DEMod:DATA.....	303
[SENSe:]DEMod:FFT:OFFSet.....	293
[SENSe:]DEMod:FILTer:CATalog?.....	276
[SENSe:]DEMod:FILTer:EFLength.....	276
[SENSe:]DEMod:FILTer:MODulation.....	276
[SENSe:]DEMod:FORMat:BANalyze.....	304
[SENSe:]DEMod:FORMat:BANalyze:BTYPe.....	306
[SENSe:]DEMod:FORMat:BANalyze:BTYPe:AUTO:TYPE.....	307
[SENSe:]DEMod:FORMat:BANalyze:DBYTes:EQUal.....	328
[SENSe:]DEMod:FORMat:BANalyze:DBYTes:MAX.....	329
[SENSe:]DEMod:FORMat:BANalyze:DBYTes:MIN.....	329
[SENSe:]DEMod:FORMat:BANalyze:DURation:EQUal.....	329
[SENSe:]DEMod:FORMat:BANalyze:DURation:MAX.....	330
[SENSe:]DEMod:FORMat:BANalyze:DURation:MIN.....	330
[SENSe:]DEMod:FORMat:BANalyze:SYMBols:EQUal.....	330
[SENSe:]DEMod:FORMat:BANalyze:SYMBols:LENGth.....	331
[SENSe:]DEMod:FORMat:BANalyze:SYMBols:LENGth:STATe.....	331
[SENSe:]DEMod:FORMat:BANalyze:SYMBols:MAX.....	332
[SENSe:]DEMod:FORMat:BANalyze:SYMBols:MIN.....	332

[SENSe:]DEMod:FORMat:BANalyze:SYMBOLs:OFFSet.....	333
[SENSe:]DEMod:FORMat:BTRate.....	309
[SENSe:]DEMod:FORMat:MCSIndex.....	309
[SENSe:]DEMod:FORMat:MCSIndex:MODE.....	309
[SENSe:]DEMod:FORMat:NSTSIndex.....	310
[SENSe:]DEMod:FORMat:NSTSIndex:MODE.....	310
[SENSe:]DEMod:FORMat:SIGSymbol.....	311
[SENSe:]DEMod:FORMat:[BCONtent]:AUTO.....	308
[SENSe:]DEMod:INTerpolate.....	295
[SENSe:]DEMod:INTerpolate:WIENer:DSPRead.....	295
[SENSe:]DEMod:INTerpolate:WIENer:DSPRead:STATe.....	296
[SENSe:]DEMod:TXARea.....	293
[SENSe:]FREQUency:CENTer.....	264
[SENSe:]FREQUency:CENTer:STEP.....	264
[SENSe:]FREQUency:CENTer:STEP:AUTO.....	265
[SENSe:]FREQUency:OFFSet.....	265
[SENSe:]FREQUency:SPAN.....	346
[SENSe:]FREQUency:SPAN:FULL.....	346
[SENSe:]FREQUency:START.....	346
[SENSe:]FREQUency:STOP.....	346
[SENSe:]IQ:WBAND.....	273
[SENSe:]MIXer<x>:BIAS:HIGH.....	243
[SENSe:]MIXer<x>:BIAS[:LOW].....	243
[SENSe:]MIXer<x>:FREQUency:HANDover.....	245
[SENSe:]MIXer<x>:FREQUency:START.....	245
[SENSe:]MIXer<x>:FREQUency:STOP.....	246
[SENSe:]MIXer<x>:HARMonic:BAND.....	246
[SENSe:]MIXer<x>:HARMonic:BAND:PRESet.....	246
[SENSe:]MIXer<x>:HARMonic:HIGH:STATe.....	247
[SENSe:]MIXer<x>:HARMonic:HIGH[:VALue].....	247
[SENSe:]MIXer<x>:HARMonic:TYPE.....	247
[SENSe:]MIXer<x>:HARMonic[:LOW].....	248
[SENSe:]MIXer<x>:IF?.....	248
[SENSe:]MIXer<x>:LOPower.....	243
[SENSe:]MIXer<x>:LOSS:HIGH.....	248
[SENSe:]MIXer<x>:LOSS:TABLE:HIGH.....	249
[SENSe:]MIXer<x>:LOSS:TABLE[:LOW].....	249
[SENSe:]MIXer<x>:LOSS[:LOW].....	249
[SENSe:]MIXer<x>:PORTs.....	250
[SENSe:]MIXer<x>:RFOVerrange[:STATe].....	250
[SENSe:]MIXer<x>:SIGNal.....	244
[SENSe:]MIXer<x>:THReshold.....	244
[SENSe:]MIXer<x>[:STATe].....	243
[SENSe:]MSRA:CAPTure:OFFSet.....	342
[SENSe:]POWer:ACHannel:CBWidth.....	345
[SENSe:]POWer:SEM.....	343
[SENSe:]POWer:SEM:CLASs.....	346
[SENSe:]SWAPiq.....	276
[SENSe:]SWEep:LIMit:ABORt:STATe.....	333
[SENSe:]SWEep:TIME.....	277

[SENSe] (see also SENSe: commands!)	299
ABORT	368
CALCulate<n>:BURSt[:IMMediate]	369
CALCulate<n>:DELTAmarker<m>:AOFF	427
CALCulate<n>:LIMit<li>:ACPower:ACHannel:RESult?	401
CALCulate<n>:LIMit<li>:ACPower:ALternate<ch>:RESult?	401
CALCulate<n>:LIMit<li>:BURSt:ALL	334
CALCulate<n>:LIMit<li>:BURSt:ALL:RESult?	394
CALCulate<n>:LIMit<li>:BURSt:EVM:ALL:MAXimum	335
CALCulate<n>:LIMit<li>:BURSt:EVM:ALL:MAXimum:RESult?	394
CALCulate<n>:LIMit<li>:BURSt:EVM:ALL[:AVERAge]	335
CALCulate<n>:LIMit<li>:BURSt:EVM:ALL[:AVERAge]:RESult?	394
CALCulate<n>:LIMit<li>:BURSt:EVM:DATA:MAXimum	335
CALCulate<n>:LIMit<li>:BURSt:EVM:DATA:MAXimum:RESult?	395
CALCulate<n>:LIMit<li>:BURSt:EVM:DATA[:AVERAge]	335
CALCulate<n>:LIMit<li>:BURSt:EVM:DATA[:AVERAge]:RESult?	395
CALCulate<n>:LIMit<li>:BURSt:EVM:MAXimum	336
CALCulate<n>:LIMit<li>:BURSt:EVM:MAXimum:RESult?	395
CALCulate<n>:LIMit<li>:BURSt:EVM:PILot:MAXimum	336
CALCulate<n>:LIMit<li>:BURSt:EVM:PILot:MAXimum:RESult?	396
CALCulate<n>:LIMit<li>:BURSt:EVM:PILot[:AVERAge]	336
CALCulate<n>:LIMit<li>:BURSt:EVM:PILot[:AVERAge]:RESult?	396
CALCulate<n>:LIMit<li>:BURSt:EVM[:AVERAge]	336
CALCulate<n>:LIMit<li>:BURSt:EVM[:AVERAge]:RESult?	395
CALCulate<n>:LIMit<li>:BURSt:FERRor:MAXimum	336
CALCulate<n>:LIMit<li>:BURSt:FERRor:MAXimum:RESult?	396
CALCulate<n>:LIMit<li>:BURSt:FERRor[:AVERAge]	336
CALCulate<n>:LIMit<li>:BURSt:FERRor[:AVERAge]:RESult?	396
CALCulate<n>:LIMit<li>:BURSt:IQOFfset:MAXimum	337
CALCulate<n>:LIMit<li>:BURSt:IQOFfset:MAXimum:RESult?	396
CALCulate<n>:LIMit<li>:BURSt:IQOFfset[:AVERAge]	337
CALCulate<n>:LIMit<li>:BURSt:IQOFfset[:AVERAge]:RESult?	396
CALCulate<n>:LIMit<li>:BURSt:SYMBOLerror:MAXimum	337
CALCulate<n>:LIMit<li>:BURSt:SYMBOLerror:MAXimum:RESult?	397
CALCulate<n>:LIMit<li>:BURSt:SYMBOLerror[:AVERAge]	337
CALCulate<n>:LIMit<li>:BURSt:SYMBOLerror[:AVERAge]:RESult?	397
CALCulate<n>:LIMit<li>:BURSt:TFALI:MAXimum	337
CALCulate<n>:LIMit<li>:BURSt:TFALI:MAXimum:RESult?	397
CALCulate<n>:LIMit<li>:BURSt:TFALI[:AVERAge]	337
CALCulate<n>:LIMit<li>:BURSt:TFALI[:AVERAge]:RESult?	397
CALCulate<n>:LIMit<li>:BURSt:TRISe:MAXimum	338
CALCulate<n>:LIMit<li>:BURSt:TRISe:MAXimum:RESult?	398
CALCulate<n>:LIMit<li>:BURSt:TRISe[:AVERAge]	338
CALCulate<n>:LIMit<li>:BURSt:TRISe[:AVERAge]:RESult?	398
CALCulate<n>:LIMit<li>:CONTRol[:DATA]?	398
CALCulate<n>:LIMit<li>:ESpectrum:CHECK:X?	400
CALCulate<n>:LIMit<li>:ESpectrum:CHECK:Y?	401
CALCulate<n>:LIMit<li>:FAIL?	398
CALCulate<n>:LIMit<li>:LOWer:FULL?	400
CALCulate<n>:LIMit<li>:SPECTrum:MASK:CHECK:X?	400



CALCulate<n>:LIMit<li>:SPEctrum:MASk:CHECK:Y?	401
CALCulate<n>:LIMit<li>:TOLerance	237
CALCulate<n>:LIMit<li>:UPPer:FULL?	400
CALCulate<n>:LIMit<li>:UPPer[:DATA]?	399
CALCulate<n>:MARKer<m>:AOFF	428
CALCulate<n>:MARKer<m>:BSYMBOL	428
CALCulate<n>:MARKer<m>:CARRier	429
CALCulate<n>:MARKer<m>:FUNction:POWer:RESult:MAXHold	404
CALCulate<n>:MARKer<m>:FUNction:POWer<sb>:RESult:PHZ	404
CALCulate<n>:MARKer<m>:FUNction:POWer<sb>:RESult?	402
CALCulate<n>:MARKer<m>:SYMBOL	429
CALCulate<n>:MARKer<m>:X	405
CALCulate<n>:MARKer<m>:Y?	428
CALCulate<n>:MARKer<m>[:STATe]	428
CALCulate<n>:MSRA:ALINe:SHOW	341
CALCulate<n>:MSRA:ALINe[:VALue]	341
CALCulate<n>:MSRA:WINDow<n>:IVAL	341
CALCulate<n>:STATistics:RESult<res>?	405
CALCulate<n>:UNIT:POWer	266
CALibration:AIQ:HATiming[:STATe]	260
CONFigure:BURSt:AM:AM:POLYnomial	361
CONFigure:BURSt:AM:AM[:IMMediate]	230
CONFigure:BURSt:AM:EVM[:IMMediate]	230
CONFigure:BURSt:AM:PM[:IMMediate]	230
CONFigure:BURSt:CONST:CARRier:SElect	367
CONFigure:BURSt:CONST:CCARRier[:IMMediate]	230
CONFigure:BURSt:CONST:CSYMBOL[:IMMediate]	230
CONFigure:BURSt:EVM:ECARRier[:IMMediate]	230
CONFigure:BURSt:EVM:ESYMBOL[:IMMediate]	231
CONFigure:BURSt:EVM:ESYMBOL[:IMMediate] (IEEE 802.11b and g (DSSS))	231
CONFigure:BURSt:EVM:EVCHip[:IMMediate]	231
CONFigure:BURSt:EVM:STANdard	238
CONFigure:BURSt:GAIN:GCARRier[:IMMediate]	231
CONFigure:BURSt:PREAmble:SElect	232
CONFigure:BURSt:PREAmble[:IMMediate]	231
CONFigure:BURSt:PTRacking[:IMMediate]	232
CONFigure:BURSt:PVT:AVERAge	326
CONFigure:BURSt:PVT:RPOWer	326
CONFigure:BURSt:PVT:SElect	232
CONFigure:BURSt:PVT[:IMMediate]	232
CONFigure:BURSt:QUAD:QCARRier[:IMMediate]	233
CONFigure:BURSt:SPEctrum:ACPR[:IMMediate]	235
CONFigure:BURSt:SPEctrum:FFT[:IMMediate]	233
CONFigure:BURSt:SPEctrum:FLATness:CSElect	360
CONFigure:BURSt:SPEctrum:FLATness:SElect	233
CONFigure:BURSt:SPEctrum:FLATness[:IMMediate]	233
CONFigure:BURSt:SPEctrum:MASk:SElect	343
CONFigure:BURSt:SPEctrum:MASk[:IMMediate]	235
CONFigure:BURSt:SPEctrum:OBWidth[:IMMediate]	235
CONFigure:BURSt:STATistics:BSTReam[:IMMediate]	234

CONFigure:BURSt:STATistics:CCDF[:IMMediate].....	235
CONFigure:BURSt:STATistics:SField[:IMMediate].....	234
CONFigure:POWer:AUTO.....	267
CONFigure:POWer:AUTO:OEVM.....	267
CONFigure:POWer:AUTO:SWEep:TIME.....	267
CONFigure:POWer:EXPected:IQ.....	268
CONFigure:POWer:EXPected:RF.....	268
CONFigure:STANdard.....	236
CONFigure:WLAN:ANTMatrix:ADDRes<ant>.....	287
CONFigure:WLAN:ANTMatrix:ANTenna<ant>.....	287
CONFigure:WLAN:ANTMatrix:RLEVel<ant>:OFFSet.....	287
CONFigure:WLAN:ANTMatrix:SOURce:AMPLitude:SOURce.....	288
CONFigure:WLAN:ANTMatrix:SOURce:RLEVel:OFFSet.....	289
CONFigure:WLAN:ANTMatrix:SOURce:ROSCillator:SOURce.....	289
CONFigure:WLAN:ANTMatrix:SOURce:ROSCillator:SOURce:STAT<ant>.....	290
CONFigure:WLAN:ANTMatrix:STATe<ant>.....	290
CONFigure:WLAN:DUTConfig.....	290
CONFigure:WLAN:EXTension:AUTO:TYPE.....	300
CONFigure:WLAN:GTIme:AUTO.....	300
CONFigure:WLAN:GTIme:AUTO:TYPE.....	437
CONFigure:WLAN:GTIme:SELEct.....	301
CONFigure:WLAN:MIMO:CAPTure.....	291
CONFigure:WLAN:MIMO:CAPTure:BUFFer.....	291
CONFigure:WLAN:MIMO:CAPTure:TYPE.....	291
CONFigure:WLAN:MIMO:CSD.....	292
CONFigure:WLAN:MIMO:OSP:ADDRes.....	292
CONFigure:WLAN:MIMO:OSP:MODule.....	292
CONFigure:WLAN:PAYLoad:LENGth:SRC.....	326
CONFigure:WLAN:PVERror:MRANge.....	326
CONFigure:WLAN:RSYNc:JOINed.....	292
CONFigure:WLAN:RUConfig:COUNT:ACTive.....	312
CONFigure:WLAN:RUConfig:COUNT:HIGHest?.....	312
CONFigure:WLAN:RUConfig:EHTPpdu.....	312
CONFigure:WLAN:RUConfig:HEPPdu.....	313
CONFigure:WLAN:RUConfig:NHELf.....	313
CONFigure:WLAN:RUConfig:REFResh.....	313
CONFigure:WLAN:RUConfig:SEGMENT<seg>:CHANnel<ch>:RULocation<cf>:COUNT:HIGHest?.....	314
CONFigure:WLAN:RUConfig:SEGMENT<seg>:CHANnel<ch>:RULocation<cf>:MRUindex.....	314
CONFigure:WLAN:RUConfig:SEGMENT<seg>:CHANnel<ch>:RULocation<cf>:RU26index.....	315
CONFigure:WLAN:RUConfig:SEGMENT<seg>:CHANnel<ch>:RULocation<cf>:RUINdex.....	315
CONFigure:WLAN:RUConfig:SEGMENT<seg>:CHANnel<ch>:RULocation<cf>:RUSize.....	316
CONFigure:WLAN:RUConfig:SEGMENT<seg>:CHANnel<ch>:RULocation<cf>:RUTSix.....	317
CONFigure:WLAN:RUConfig:SEGMENT<seg>:CHANnel<ch>:RULocation<cf>:USER:COUNT?.....	317
CONFigure:WLAN:RUConfig:SEGMENT<seg>:CHANnel<ch>:RULocation<cf>:USER<mu>:CODing.....	318
CONFigure:WLAN:RUConfig:SEGMENT<seg>:CHANnel<ch>:RULocation<cf>:USER<mu>:DCM.....	319
CONFigure:WLAN:RUConfig:SEGMENT<seg>:CHANnel<ch>:RULocation<cf>:USER<mu>:DELete.....	319
CONFigure:WLAN:RUConfig:SEGMENT<seg>:CHANnel<ch>:RULocation<cf>:USER<mu>:INSert.....	320
CONFigure:WLAN:RUConfig:SEGMENT<seg>:CHANnel<ch>:RULocation<cf>:USER<mu>:MCSindex.....	321
CONFigure:WLAN:RUConfig:SEGMENT<seg>:CHANnel<ch>:RULocation<cf>:USER<mu>:NSTS.....	322

CONFigure:WLAN:RUConfig:SEGment<seg>:CHANnel<ch>:RULocation<cf>:USER<mu>: TBEamforming.....	322
CONFigure:WLAN:SMAPping:MODE.....	323
CONFigure:WLAN:SMAPping:NORMalise.....	324
CONFigure:WLAN:SMAPping:TX<ch>.....	324
CONFigure:WLAN:SMAPping:TX<ch>:STReam<ant>.....	324
CONFigure:WLAN:SMAPping:TX<ch>:TIMeshift.....	325
CONFigure:WLAN:STBC:AUTO:TYPE.....	301
DIAGnostic:SERvice:NSource.....	263
DISPlay:FORMat.....	347
DISPlay:WSElect?.....	439
DISPlay[:WINDow<n>]:FLAGs.....	406
DISPlay[:WINDow<n>]:SIZE.....	347
DISPlay[:WINDow<n>]:SUBWindow<w>:SIZE.....	348
DISPlay[:WINDow<n>]:TAB<1..n>:SElect.....	349
DISPlay[:WINDow<n>]:TABLe.....	358
DISPlay[:WINDow<n>]:TABLe:ITEM.....	358
DISPlay[:WINDow<n>]:TRACe<t>:X[:SCALe]:AUTO.....	361
DISPlay[:WINDow<n>]:TRACe<t>:X[:SCALe]:AUTO:FIXed:RANGe.....	362
DISPlay[:WINDow<n>]:TRACe<t>:X[:SCALe]:AUTO:HYSTEResis:LOWer:LOWer.....	363
DISPlay[:WINDow<n>]:TRACe<t>:X[:SCALe]:AUTO:HYSTEResis:LOWer:UPPer.....	362
DISPlay[:WINDow<n>]:TRACe<t>:X[:SCALe]:AUTO:HYSTEResis:UPPer:LOWer.....	363
DISPlay[:WINDow<n>]:TRACe<t>:X[:SCALe]:AUTO:HYSTEResis:UPPer:UPPer.....	364
DISPlay[:WINDow<n>]:TRACe<t>:X[:SCALe]:AUTO:MEMory:DEPTh.....	364
DISPlay[:WINDow<n>]:TRACe<t>:X[:SCALe]:AUTO:MODE.....	365
DISPlay[:WINDow<n>]:TRACe<t>:X[:SCALe]:DIVisions.....	365
DISPlay[:WINDow<n>]:TRACe<t>:X[:SCALe]:MAXimum.....	366
DISPlay[:WINDow<n>]:TRACe<t>:X[:SCALe]:MINimum.....	366
DISPlay[:WINDow<n>]:TRACe<t>:X[:SCALe]:PDIVision.....	367
DISPlay[:WINDow<n>]:TRACe<t>:Y[:SCALe]:AUTO.....	361
DISPlay[:WINDow<n>]:TRACe<t>:Y[:SCALe]:AUTO:FIXed:RANGe.....	362
DISPlay[:WINDow<n>]:TRACe<t>:Y[:SCALe]:AUTO:HYSTEResis:LOWer:LOWer.....	363
DISPlay[:WINDow<n>]:TRACe<t>:Y[:SCALe]:AUTO:HYSTEResis:LOWer:UPPer.....	362
DISPlay[:WINDow<n>]:TRACe<t>:Y[:SCALe]:AUTO:HYSTEResis:UPPer:LOWer.....	363
DISPlay[:WINDow<n>]:TRACe<t>:Y[:SCALe]:AUTO:HYSTEResis:UPPer:UPPer.....	364
DISPlay[:WINDow<n>]:TRACe<t>:Y[:SCALe]:AUTO:MEMory:DEPTh.....	364
DISPlay[:WINDow<n>]:TRACe<t>:Y[:SCALe]:AUTO:MODE.....	365
DISPlay[:WINDow<n>]:TRACe<t>:Y[:SCALe]:DIVisions.....	365
DISPlay[:WINDow<n>]:TRACe<t>:Y[:SCALe]:MAXimum.....	366
DISPlay[:WINDow<n>]:TRACe<t>:Y[:SCALe]:MINimum.....	366
DISPlay[:WINDow<n>]:TRACe<t>:Y[:SCALe]:PDIVision.....	367
DISPlay[:WINDow<n>][:SUBWindow<w>]:SElect.....	348
DISPlay[:WINDow<n>][:SUBWindow<w>]:TRACe<t>:Y[:SCALe].....	273
DISPlay[:WINDow<n>][:SUBWindow<w>]:TRACe<t>:Y[:SCALe]:RLEVel.....	268
DISPlay[:WINDow<n>][:SUBWindow<w>]:TRACe<t>:Y[:SCALe]:RLEVel:OFFSet.....	269
DISPlay[:WINDow<n>][:SUBWindow<w>]:TRACe<t>:Y[:SCALe]:RPOSition.....	274
FETCh:BURSt:ALL:FORMatted?.....	378
FETCh:BURSt:ALL?.....	439
FETCh:BURSt:AM:AM:COEFicients?.....	379
FETCh:BURSt:BERPilot:AVERAge?.....	379

FETCh:BURSt:BERPilot:MAXimum?.....	379
FETCh:BURSt:BERPilot:MINimum?.....	379
FETCh:BURSt:CFERror:AVERage?.....	382
FETCh:BURSt:CFERror:MAXimum?.....	382
FETCh:BURSt:CFERror:MINimum?.....	382
FETCh:BURSt:COUNt:ALL?.....	373
FETCh:BURSt:COUNt?.....	373
FETCh:BURSt:CPError:AVERage?.....	379
FETCh:BURSt:CPError:MAXimum?.....	379
FETCh:BURSt:CPError:MINimum?.....	379
FETCh:BURSt:CRESt:MAXimum?.....	380
FETCh:BURSt:CRESt:MINimum?.....	380
FETCh:BURSt:CRESt[:AVERage]?.....	380
FETCh:BURSt:ECMGain?.....	380
FETCh:BURSt:EVM:ALL:AVERage?.....	381
FETCh:BURSt:EVM:ALL:MAXimum?.....	381
FETCh:BURSt:EVM:ALL:MINimum?.....	381
FETCh:BURSt:EVM:DATA:AVERage?.....	381
FETCh:BURSt:EVM:DATA:MAXimum?.....	381
FETCh:BURSt:EVM:DATA:MINimum?.....	381
FETCh:BURSt:EVM:DIRect:AVERage?.....	381
FETCh:BURSt:EVM:DIRect:MAXimum?.....	381
FETCh:BURSt:EVM:DIRect:MINimum?.....	381
FETCh:BURSt:EVM:PILot:AVERage?.....	381
FETCh:BURSt:EVM:PILot:MAXimum?.....	381
FETCh:BURSt:EVM:PILot:MINimum?.....	381
FETCh:BURSt:EVM[:IEEE]:AVERage?.....	382
FETCh:BURSt:EVM[:IEEE]:MAXimum?.....	382
FETCh:BURSt:EVM[:IEEE]:MINimum?.....	382
FETCh:BURSt:FERRor:AVERage?.....	382
FETCh:BURSt:FERRor:MAXimum?.....	382
FETCh:BURSt:FERRor:MINimum?.....	382
FETCh:BURSt:GIMBalance:AVERage?.....	382
FETCh:BURSt:GIMBalance:MAXimum?.....	382
FETCh:BURSt:GIMBalance:MINimum?.....	382
FETCh:BURSt:GINTerval?.....	374
FETCh:BURSt:IQOFfset:AVERage?.....	382
FETCh:BURSt:IQOFfset:MAXimum?.....	382
FETCh:BURSt:IQOFfset:MINimum?.....	382
FETCh:BURSt:IQSKew:AVERage?.....	383
FETCh:BURSt:IQSKew:MAXimum?.....	383
FETCh:BURSt:IQSKew:MINimum?.....	383
FETCh:BURSt:LENGths?.....	374
FETCh:BURSt:MCHPower:AVERage?.....	383
FETCh:BURSt:MCHPower:MAXimum?.....	383
FETCh:BURSt:MCHPower:MINimum?.....	383
FETCh:BURSt:MCPower:AVERage?.....	383
FETCh:BURSt:MCPower:MAXimum?.....	383
FETCh:BURSt:MCPower:MINimum?.....	383
FETCh:BURSt:MCSindex?.....	374

FETCh:BURSt:PAYLoad:MAXimum?	383
FETCh:BURSt:PAYLoad:MINimum?	383
FETCh:BURSt:PAYLoad[:AVERage]?	383
FETCh:BURSt:PCMGain?	380
FETCh:BURSt:PEAK:MAXimum?	384
FETCh:BURSt:PEAK:MINimum?	384
FETCh:BURSt:PEAK[:AVERage]?	384
FETCh:BURSt:PPDU:EVM:ALL:AVERage?	386
FETCh:BURSt:PPDU:EVM:DATA:AVERage?	386
FETCh:BURSt:PPDU:EVM:PILot:AVERage?	386
FETCh:BURSt:PPDU:STATus?	375
FETCh:BURSt:PPDU:TYPE?	375
FETCh:BURSt:PREamble:MAXimum?	384
FETCh:BURSt:PREamble:MINimum?	384
FETCh:BURSt:PREamble[:AVERage]?	384
FETCh:BURSt:QUADoffset:AVERage?	384
FETCh:BURSt:QUADoffset:MAXimum?	384
FETCh:BURSt:QUADoffset:MINimum?	384
FETCh:BURSt:RMS:MAXimum?	384
FETCh:BURSt:RMS:MINimum?	384
FETCh:BURSt:RMS[:AVERage]?	384
FETCh:BURSt:STARts?	375
FETCh:BURSt:SYMBOLerror:AVERage?	385
FETCh:BURSt:SYMBOLerror:MAXimum?	385
FETCh:BURSt:SYMBOLerror:MINimum?	385
FETCh:BURSt:TFALI:AVERage?	385
FETCh:BURSt:TFALI:MAXimum?	385
FETCh:BURSt:TFALI:MINimum?	385
FETCh:BURSt:TRISe:AVERage?	385
FETCh:BURSt:TRISe:MAXimum?	385
FETCh:BURSt:TRISe:MINimum?	385
FETCh:SCDetailed:ALL?	386
FETCh:SCDetailed:EVM:ALL?	388
FETCh:SCDetailed:EVM:DATA?	388
FETCh:SCDetailed:EVM:PILot?	388
FETCh:SCDetailed:POWer:PPDU?	389
FETCh:SCDetailed:POWer:RU?	389
FETCh:SCDetailed:POWer[:SC]?	390
FETCh:SField:ALL?	390
FETCh:SFSummary:ALL?	391
FETCh:SYMBOL:COUNT?	373
FETCh:UTESummary:ALL?	392
FORMat:DEXPort:DSEPARATOR	426
FORMat[:DATA]	407
INITiate:SEQuencer:ABORT	370
INITiate:SEQuencer:IMMediate	370
INITiate:SEQuencer:MODE	370
INITiate:SEQuencer:REFResh[:ALL]	371
INITiate<n>:CONTinuous	369
INITiate<n>:REFResh	342

INITiate<n>[:IMMEDIATE].....	369
INPut:ATTenuation.....	269
INPut:ATTenuation:AUTO.....	269
INPut:ATTenuation:AUTO:MODE.....	270
INPut:ATTenuation:PROTection:RESet.....	239
INPut:CONNector.....	239
INPut:COUPling.....	239
INPut:DIQ:CDEvice.....	257
INPut:DIQ:RANGe:COUPling.....	257
INPut:DIQ:RANGe[:UPPer].....	257
INPut:DIQ:RANGe[:UPPer]:AUTO.....	257
INPut:DIQ:RANGe[:UPPer]:UNIT.....	258
INPut:DIQ:SRATe.....	258
INPut:DIQ:SRATe:AUTO.....	258
INPut:DPAth.....	240
INPut:EATT.....	270
INPut:EATT:AUTO.....	270
INPut:EATT:STATe.....	271
INPut:EGain[:STATe].....	271
INPut:FILE:PATH.....	261
INPut:FILTer:HPASs[:STATe].....	240
INPut:FILTer:YIG[:STATe].....	240
INPut:GAIN:STATe.....	272
INPut:GAIN[:VALue].....	272
INPut:IMPedance.....	241
INPut:IQ:BALanced[:STATe].....	259
INPut:IQ:FULLscale:AUTO.....	259
INPut:IQ:FULLscale[:LEVel].....	259
INPut:IQ:TYPE.....	260
INPut:SElect.....	241
INPut:TYPE.....	242
INSTrument:CREate:DUPLicate.....	224
INSTrument:CREate:REPLace.....	225
INSTrument:CREate[:NEW].....	224
INSTrument:DElete.....	225
INSTrument:LIST?.....	225
INSTrument:REName.....	227
INSTrument[:SElect].....	227
LAYout:ADD[:WINDow]?.....	350
LAYout:CATalog[:WINDow]?.....	352
LAYout:IDENtify[:WINDow]?.....	353
LAYout:MOVE[:WINDow].....	353
LAYout:REMove[:WINDow].....	354
LAYout:REPLace[:WINDow].....	354
LAYout:SPLitter.....	354
LAYout:WINDow<n>:ADD?.....	356
LAYout:WINDow<n>:IDENtify?.....	356
LAYout:WINDow<n>:REMove.....	357
LAYout:WINDow<n>:REPLace.....	357
MMEMemory:LOAD:IQ:STATe.....	424

MMEMory:LOAD:IQ:STReam.....	262
MMEMory:LOAD:IQ:STReam:AUTO.....	262
MMEMory:LOAD:IQ:STReam:LIST?.....	262
MMEMory:LOAD:SEM:STATe.....	440
MMEMory:STORe<n>:IQ:COMMeNt.....	424
MMEMory:STORe<n>:IQ:FORMat.....	424
MMEMory:STORe<n>:IQ:STATe.....	425
MMEMory:STORe<n>:IQNC:STATe.....	425
MMEMory:STORe<n>:TRACe.....	426
OUTPut:TRIGGer<tp>:DIReCtion.....	284
OUTPut:TRIGGer<tp>:LEVel.....	285
OUTPut:TRIGGer<tp>:OTYPe.....	285
OUTPut:TRIGGer<tp>:PULSe:IMMediate.....	286
OUTPut:TRIGGer<tp>:PULSe:LENGth.....	286
SENSe:TRACking:CROStalk.....	296
SENSe:TRACking:IQMComp.....	296
SENSe:TRACking:LEVel.....	297
SENSe:TRACking:PHASe.....	297
SENSe:TRACking:PILOts.....	298
SENSe:TRACking:PREAmble.....	298
SENSe:TRACking:TIME.....	299
STATus:OPERation:CONDition?.....	435
STATus:OPERation:ENABle.....	435
STATus:OPERation:NTRansition.....	435
STATus:OPERation:PTRansition.....	436
STATus:OPERation[:EVENT]?.....	434
STATus:PRESet.....	434
STATus:QUEStionable:ACPLimit:CONDition?.....	435
STATus:QUEStionable:ACPLimit:ENABle.....	435
STATus:QUEStionable:ACPLimit:NTRansition.....	435
STATus:QUEStionable:ACPLimit:PTRansition.....	436
STATus:QUEStionable:ACPLimit[:EVENT]?.....	434
STATus:QUEStionable:CONDition?.....	435
STATus:QUEStionable:DIQ:CONDition?.....	432
STATus:QUEStionable:DIQ:ENABle.....	432
STATus:QUEStionable:DIQ:NTRansition.....	432
STATus:QUEStionable:DIQ:PTRansition.....	433
STATus:QUEStionable:DIQ[:EVENT]?.....	433
STATus:QUEStionable:ENABle.....	435
STATus:QUEStionable:LIMit<n>:CONDition?.....	435
STATus:QUEStionable:LIMit<n>:ENABle.....	435
STATus:QUEStionable:LIMit<n>:NTRansition.....	435
STATus:QUEStionable:LIMit<n>:PTRansition.....	436
STATus:QUEStionable:LIMit<n>[:EVENT]?.....	434
STATus:QUEStionable:NTRansition.....	435
STATus:QUEStionable:PTRansition.....	436
STATus:QUEStionable:SYNC:CONDition?.....	435
STATus:QUEStionable:SYNC:ENABle.....	435
STATus:QUEStionable:SYNC:NTRansition.....	435
STATus:QUEStionable:SYNC:PTRansition.....	436

STATus:QUEStionable:SYNC[:EVENT]?	434
STATus:QUEStionable[:EVENT]?	434
STATus:QUEue[:NEXT]?	434
SYSTem:PRESet:CHANnel[:EXEC]	228
SYSTem:SEQuencer	371
SYSTem:SPEaker:VOLume	263
TRACe:IQ:DATA:MEMory?	422
TRACe:IQ:DATA?	422
TRACe:IQ:FILE:REPetition:COUNT	263
TRACe:IQ:SRATe	277
TRACe[:DATA]?	408
TRACe<n>[:DATA]:X?	410
TRIGger[:SEQuence]:DTIME	278
TRIGger[:SEQuence]:HOLDoff[:TIME]	278
TRIGger[:SEQuence]:IFPower:HOLDoff	279
TRIGger[:SEQuence]:IFPower:HYSTeresis	279
TRIGger[:SEQuence]:LEVel:BBPower	279
TRIGger[:SEQuence]:LEVel:IFPower	280
TRIGger[:SEQuence]:LEVel:IQPower	280
TRIGger[:SEQuence]:LEVel:POWer:AUTO	281
TRIGger[:SEQuence]:LEVel:RFPower	281
TRIGger[:SEQuence]:LEVel[:EXTernal<port>]	280
TRIGger[:SEQuence]:MODE	440
TRIGger[:SEQuence]:SLOPe	282
TRIGger[:SEQuence]:SOURce	282
TRIGger[:SEQuence]:TIME:RINTerval	284
UNIT:BURSt	376
UNIT:EVM	393
UNIT:GIMBalance	393
UNIT:PREAmble	393
UNIT:SFLatness	360



# Index

## A

Abbreviations	
Signal processing IEEE 802.11a, g (OFDM), j, p	65
Aborting	
Sweep	198
AC/DC coupling	114, 125
ACLR	
Configuring (cdma2000)	200
Results	59
Results (remote)	402
Activating	
WLAN measurements (remote)	224
Additive white Gaussian noise (AWGN)	67
Adjacent channel leakage ratio	
see ACLR	59
Adjacent channels	
Filtering out	129, 275
AM/AM	
Polynomial degree	191
Result displays	28
Trace data	414
AM/EVM	
Result displays	29
Trace data	414
AM/PM	
Result displays	29
Trace data	414
Amplitude	
Configuration (remote)	266
Configuration (softkey)	120
Settings	120
Analog Baseband	
Input	115
Analysis	
Bandwidth, definition	446
Remote control	427
RF measurements	204
Settings	204
Analysis interval	
MSRA	127, 145, 274
Analysis line	104
Antennas	
Assignment (MIMO)	140
Mapping (MIMO)	183
MIMO settings	138
OSP switch box	143
State (MIMO)	139
Application cards	9
Application notes	9
Applications	
Adopted parameters	107
Switching	107
Attenuation	122
Auto	122
Electronic	124
Manual	122
Option	124
Protective (remote)	239
Audio demodulation	
Volume (remote control)	263

Auto ID	
External Mixer (remote)	244
Threshold (External Mixer, remote control)	244
Auto level	
Reference level	122, 197
Softkey	122, 197
Auto settings	196
Meastime Auto	197
Meastime Manual	197
Remote control	338
Auto track time	
Remote control	267

## B

Band	
External Mixer (remote)	246
Bandwidth	
Coverage, MSRA mode	104
Extension options	446, 447
Maximum usable	446
Menu	107
Relationship to sample rate	447
BB Power	
Trigger (softkey)	131
Bias	
External Mixer (remote)	243
Bit error rate (BER)	
Pilot	15
Bitstream	
Result display	30
Trace data	414
Block diagram	
IEEE 802.11a, g (OFDM), j, p	65
Brochures	8

## C

Capture buffer	
Results	41
Capture buffers	
Clearing (MIMO)	144
Used (MIMO)	145
Capture offset	
MSRA secondary applications	128, 135, 145
Remote	342
Softkey	128, 135
Capture time	15, 18, 128
Displayed	12
see also Measurement time	277
Carriers	
Active	94
CCDF	
Configuring (applications)	202
Results	61
Trace data	415
Center frequency	119
Error	15
Softkey	119
Step size	119
Channel	
Creating (remote)	225
Deleting (remote)	225

- Duplicating (remote) ..... 224
- Estimating ..... 147, 437
- Estimating (IEEE 802.11a, g (OFDM), j, p) ..... 71
- Querying (remote) ..... 225
- Renaming (remote) ..... 227
- Replacing (remote) ..... 225
- Channel bandwidth
  - MSRA mode ..... 104
- Channel bandwidth (CBW)
  - PPDU 152, 153, 156, 160, 161, 168, 169, 176, 179, 302
- Channel bar
  - Displayed information ..... 12
- Channel estimation
  - Remote control ..... 294
- Channel power
  - ACLR, see ACLR ..... 59
- Channels
  - Active carriers ..... 94
  - AWGN (IEEE 802.11a, g (OFDM), j, p) ..... 67
  - Effective ..... 80
  - Physical ..... 80
- Closing
  - Channels (remote) ..... 225
  - Windows (remote) ..... 357
- Compensating
  - IEEE 802.11a, g (OFDM), j, p ..... 70
  - Payload window (IEEE 802.11a, g (OFDM), j, p) ..... 67
- Compensation
  - I/Q Mismatch ..... 150
- Complementary cumulative distribution function
  - see CCDF ..... 61
- Constellation
  - Result display ..... 32
  - vs carrier (result display) ..... 34
  - vs carrier (trace data) ..... 417
  - vs symbol (trace data) ..... 416
- Continue single sweep
  - Softkey ..... 198
- Continuous Sequencer
  - Softkey ..... 106
- Continuous sweep
  - Softkey ..... 198
- Conventions
  - SCPI commands ..... 219
- Conversion loss
  - External Mixer (remote) ..... 248, 249
- Conversion loss tables
  - Available (remote) ..... 251
  - Band (remote) ..... 251
  - Bias (remote) ..... 251
  - Deleting (remote) ..... 252
  - External Mixer (remote) ..... 249
  - Harmonic order (remote) ..... 253
  - Mixer type (remote) ..... 253
  - Selecting (remote) ..... 254
- Copying
  - Channel (remote) ..... 224
- Crest Factor ..... 15
- Crosstalk
  - MIMO ..... 296
- D**
- Data acquisition
  - Manual (MIMO) ..... 143, 144
  - MIMO capture method ..... 138
  - MIMO settings ..... 137
- MSRA ..... 127, 145, 274
  - see Signal capturing ..... 127
- Data input ..... 111
- Data output ..... 111
- Data sheets ..... 8
- Data streams
  - Mapping (MIMO) ..... 183
- Data symbols
  - Estimating (IEEE 802.11a, g (OFDM), j, p) ..... 71
  - Number ..... 15
  - Number of; displayed ..... 12
  - Required ..... 185, 326
- DC offset
  - Analog Baseband (B71, remote control) ..... 260
- Demodulation
  - Basics ..... 95
  - Configuring ..... 151
  - Configuring (remote) ..... 299
  - Dependencies ..... 96
  - Parameters ..... 95
  - Settings (MIMO) ..... 182
- Diagram footer ..... 14
- Diagrams
  - Evaluation method ..... 62
- Digital Baseband interface
  - Status registers ..... 430
- Digital I/Q
  - Enhanced mode ..... 132
  - Triggering ..... 132
- Digital standard ..... 15, 18
  - Channel bandwidths ..... 153, 156, 161, 169, 179
  - Displayed ..... 12
  - Selecting ..... 110
  - Selecting (remote) ..... 236
- Direct path
  - Input configuration ..... 114
- Display
  - Configuration (softkey) ..... 107
  - Understanding ..... 11
- Drop-out time
  - Trigger ..... 100, 134
- Duplicating
  - Channel (remote) ..... 224
- E**
- Electronic input attenuation ..... 122, 124
- Enhanced mode
  - Digital I/Q ..... 132
- Equalizer filter
  - Length ..... 129
- Errors
  - Calculating parameters ..... 69
  - Calculating parameters (IEEE 802.11a, g (OFDM), j, p) ..... 71
  - Center frequency ..... 15
  - crosstalk ..... 296
  - Device connections ..... 430
  - EVM ..... 23
  - Gain imbalance ..... 15, 20, 22
  - I/Q offset ..... 15, 20
  - I/Q skew ..... 22
  - Messages ..... 216
  - Phase drift ..... 149, 297
  - Pilots ..... 150, 298
  - PPDU levels ..... 150, 296, 297
  - PPDU timing ..... 149, 299

- Quadrature (phase angle I, Q) ..... 21, 22
- Quadrature offset ..... 15
- Status bits ..... 430
- Symbol timing ..... 15
- Estimates
  - Signal processing (IEEE 802.11a, g (OFDM), j, p) ..... 67
- Estimating
  - Channels (IEEE 802.11a, g (OFDM), j, p) ..... 71
- Evaluation methods
  - Frequency sweep measurement ..... 62
  - Remote ..... 350
  - Trace data ..... 410
  - WLAN ..... 27
- Evaluation range
  - Remote ..... 325
  - Result displays ..... 183
  - Settings ..... 204
- EVM
  - All carriers ..... 15
  - Calculating (IEEE 802.11a, g (OFDM), j, p) ..... 71
  - Calculating (WLAN) ..... 23
  - Data carriers ..... 15
  - Data carriers, limit check result (remote) ..... 394, 395
  - I/Q diagram ..... 24
  - IEEE 802.11b, g (DSSS) ..... 24
  - Limit check result (remote) ..... 394
  - Limits (remote) ..... 335, 336
  - Optimizing ..... 147, 437
  - Pilot carriers ..... 15
  - Pilot carriers, limit check result (remote) ..... 396
  - PPDU (direct) ..... 23
  - Units ..... 393
  - vs carrier (result display) ..... 35
  - vs carrier (trace data) ..... 417
  - vs chip (result display) ..... 36
  - vs symbol (result display) ..... 36
- Exporting
  - I/Q data ..... 97, 112, 205
  - I/Q data (remote) ..... 423
  - Trace results (remote) ..... 426
- Extension Spatial Streams
  - PPDUs ..... 181, 300
- External Mixer
  - Activating (remote) ..... 243
  - Band ..... 245, 246
  - Programming example ..... 254
  - RF overrange ..... 250
  - Type ..... 250
- External trigger ..... 131
  - Level (remote) ..... 280
- F**
- Fall time
  - Limit check result (remote) ..... 397
- FFT
  - AWGN channel (IEEE 802.11a, g (OFDM), j, p) ..... 67
  - Carriers ..... 94
  - Signal processing (IEEE 802.11a, g (OFDM), j, p) ..... 67
  - Spectrum (result display) ..... 37
  - Spectrum (trace data) ..... 419
  - Start offset ..... 146
  - Start offset (remote) ..... 293
- Files
  - I/Q data input ..... 98, 116
- Filters
  - Adjacent channels ..... 275
  - Equalizer ..... 129
  - High-pass (RF input) ..... 115
  - Receive ..... 129
  - Transmit ..... 129
  - YIG (remote) ..... 240
- Format
  - PPDU (remote) ..... 307
- Free Run
  - Trigger ..... 131
- Freq. Error vs Preamble
  - Result displays ..... 38
- Frequency
  - Configuration ..... 118
  - Configuration (remote) ..... 264
  - Deviation ..... 68
  - Error limit (remote) ..... 336
  - Offset ..... 119
- Frequency offset
  - Error, limit check result (remote) ..... 396
  - Rx-Tx ..... 67
- Frequency sweep measurements
  - Configuring ..... 199
  - Selecting ..... 199
  - WLAN ..... 58
- Frontend
  - Configuration (remote) ..... 264
- G**
- Gain
  - Tracking (IEEE 802.11a, g (OFDM), j, p) ..... 69
- Gain imbalance ..... 15, 20, 22
  - Units ..... 393
- Getting started ..... 7
- Group delay
  - Result display ..... 40
  - Trace data ..... 419
- Guard interval ..... 15
  - Displayed ..... 12
  - Length (PPDUs) 154, 158, 166, 174, 181, 300, 301, 437
- H**
- Handover frequency
  - External Mixer (remote) ..... 245
- Harmonics
  - External Mixer (remote) ..... 247, 248
- High-pass filter
  - RF input ..... 115
- Hysteresis
  - Trigger ..... 134
- I**
- I/Q data
  - Exporting ..... 112
  - Exporting (remote) ..... 423
  - Importing ..... 112
  - Importing (remote) ..... 423
  - Importing/Exporting ..... 97, 205
  - Input file ..... 116
  - Input files ..... 98, 116
  - Maximum bandwidth ..... 446
  - Sample rate ..... 446

- I/Q measurements
    - Configuring (remote) ..... 235
  - I/Q mismatch ..... 22
  - I/Q Mismatch
    - Compensation ..... 150
  - I/Q offset ..... 15, 20
    - Limit check result (remote) ..... 396
    - Limits (remote) ..... 337
  - I/Q Power
    - Trigger ..... 133
    - Trigger level (remote) ..... 280
  - I/Q skew ..... 22
  - IEEE 802.11a
    - Signal processing ..... 65
  - IEEE 802.11a, g (OFDM), j, p
    - Literature ..... 72
    - Modulation formats ..... 95
  - IEEE 802.11g (OFDM)
    - Signal processing ..... 65
  - IEEE 802.11n
    - Modulation formats ..... 95
  - IF Power
    - Trigger level (remote) ..... 280
  - Impedance
    - Setting ..... 114, 125
  - Importing
    - I/Q data ..... 97, 112, 205
    - I/Q data (remote) ..... 423
  - Input
    - Coupling ..... 114, 125
    - I/Q data files ..... 116
    - Overload (remote) ..... 239
    - RF ..... 113
    - Settings ..... 112, 124
    - Source Configuration (softkey) ..... 112
    - Source, connection errors ..... 430
    - Source, Radio frequency (RF) ..... 112
  - Input sample rate ..... 128
    - Displayed ..... 12
    - Remote ..... 277
  - Input sample rate (ISR)
    - Definition ..... 446
  - Input sources
    - I/Q data file ..... 116
    - I/Q data files ..... 98, 116
  - Installation ..... 11
  - Instrument security procedures ..... 8
  - Inter-channel interference (ICI) ..... 67
  - IP address
    - OSP switchbox (MIMO) ..... 142
- J**
- Joined RX Sync and Tracking
    - MIMO ..... 140
- K**
- Keys
    - BW ..... 107
    - LINES ..... 107
    - MKR FUNCT ..... 107
    - RUN CONT ..... 198
    - RUN SINGLE ..... 198
    - SPAN ..... 107
- L**
- Level
    - Tracking ..... 150
    - Tracking (IEEE 802.11a, g (OFDM), j, p) ..... 69
  - Level error tracking ..... 296, 297
  - Limits
    - Defining (remote) ..... 333
    - EVM ..... 335, 336
    - EVM pilot carriers, result ..... 396
    - EVM, result ..... 394, 395
    - Fall time, result ..... 397
    - Frequency error ..... 336
    - Frequency error, result ..... 396
    - I/Q offset ..... 337
    - I/Q offset, result ..... 396
    - Rise time, result ..... 398
    - Symbol clock error ..... 337
    - Symbol clock error, result ..... 397
  - Lines
    - Menu ..... 107
  - Literature
    - IEEE 802.11a, g (OFDM), j, p ..... 72
  - LO feedthrough ..... 114
  - Log likelihood function
    - IEEE 802.11a, g (OFDM), j, p ..... 69
  - Logical filter ..... 95
  - Long symbol (LS)
    - IEEE 802.11a, g (OFDM), j, p ..... 67
- M**
- Magnitude Capture
    - Result display ..... 41
    - Trace data ..... 410
  - Marker Functions
    - Menu ..... 107
  - Marker table
    - Evaluation method ..... 63
  - Markers
    - Configuration (remote) ..... 427
    - Table (evaluation method) ..... 63
  - Maximizing
    - Windows (remote) ..... 347
  - Maximum
    - Y-axis ..... 195
  - MCS index ..... 15, 157, 179, 180
    - Displayed ..... 12
    - Displayed information ..... 158, 181
    - Remote ..... 309
  - Measurement channel
    - Creating (remote) ..... 227
    - Selecting (remote) ..... 227
  - Measurement time
    - Auto settings ..... 197
    - Remote ..... 277
  - Measurements
    - Frequency sweep ..... 58
    - RF, results ..... 59
    - RF, types ..... 59
    - Selecting ..... 105, 109
    - Selecting (remote) ..... 228
    - Setup, displayed ..... 12
    - Starting (remote) ..... 367
    - Types ..... 15
  - Messages
    - Signal Field ..... 216

- MIMO ..... 78
  - Antenna assignment ..... 140
  - Calculating results ..... 144
  - Capture buffers ..... 144, 145
  - Capture method ..... 138
  - Capture settings ..... 137
  - Crosstalk ..... 296
  - Demodulation settings ..... 182
  - DUT configuration ..... 138
  - How to perform measurement ..... 208
  - Joined RX Sync and Tracking ..... 140
  - Manual data capture ..... 144
  - Manual sequential capture ..... 143
  - Normalizing power ..... 183
  - OSP IP address ..... 142
  - PPDU synchronization ..... 140
  - Reference frequency coupling ..... 140
  - Secondary analyzers ..... 139
  - Sequential capture using OSP ..... 141
  - Simultaneous capture settings ..... 139
  - Spatial mapping mode ..... 182
  - User-defined spatial mapping ..... 183
- Minimum
  - Y-axis ..... 195
- Modulation
  - Formats ..... 95
  - Inverted (I/Q, remote) ..... 276
  - Inverted (I/Q) ..... 129
  - PPDU ..... 153, 154, 177, 307
  - PPDU (remote) ..... 306
  - PPDUs ..... 157, 179
- Modulation Accuracy
  - Parameters ..... 15
- Modulation and Coding Scheme
  - see MCS ..... 157, 179
- MSR ACLR
  - Results (remote) ..... 402
- MSRA
  - Analysis interval ..... 127, 145, 274
  - Operating mode ..... 103
  - RF measurements ..... 59
- MSRA primary
  - Data coverage ..... 104
- MSRA secondary applications
  - Capture offset ..... 145
  - Capture offset (remote) ..... 342
- Multiple
  - Measurement channels ..... 105
- N**
- Ness
  - PPDUs ..... 181, 300
- Nof\_symbols ..... 67
- Noise
  - Additive white Gaussian (AWG) ..... 67
  - Source ..... 118
- Normalizing
  - Power (MIMO) ..... 183
- Nsts
  - PPDUs ..... 157, 158, 310
- Number of samples
  - Displayed ..... 12
- O**
- OBW
  - Configuring (applications) ..... 201
  - Results ..... 60
- Occupied bandwidth
  - see OBW ..... 60
- Offset
  - Amplification I, Q ..... 20, 22
  - Analysis interval ..... 128, 135
  - Carriers ..... 20
  - Frequency ..... 119
  - Phase angle I, Q ..... 21, 22
  - Quadrature ..... 21, 22
  - Reference level ..... 121
- Options
  - Bandwidth extension ..... 446, 447
  - Electronic attenuation ..... 124
  - High-pass filter ..... 115
  - Preamplifier ..... 124
- OSP switch box
  - Antenna connection (MIMO) ..... 143
  - IP address ..... 142
  - Setup ..... 141
  - State (MIMO) ..... 142
- Output
  - Configuration ..... 117
  - Configuration (remote) ..... 263
  - Noise source ..... 118
  - Sample rate, definition ..... 446
  - Settings ..... 117
- Overload
  - RF input (remote) ..... 239
- Overview
  - Configuring WLAN measurements ..... 108
- P**
- Packet search
  - IEEE 802.11a, g (OFDM), j, p ..... 67
- Parameters
  - WLAN ..... 15
- Payload
  - Channel estimation ..... 147, 437
  - Length ..... 185, 186, 188, 326
  - Length (source, remote) ..... 326
  - Length (source) ..... 185
  - Window ..... 67
- Peak list
  - Evaluation method ..... 64
- Peak vector error
  - Measurement range ..... 189
- Peak Vector Error ..... 24
- Phase drift ..... 68
  - Tracking ..... 149
  - Tracking (IEEE 802.11a, g (OFDM), j, p) ..... 69
- Phase Error vs Preamble
  - Result displays ..... 42
- Phase tracking ..... 297
- Phase Tracking
  - Result displays ..... 43
- Pilot bit error rate ..... 15
- Pilots
  - for tracking ..... 150, 298
- Polynomial degree
  - AM/AM ..... 191

- Ports
  - External Mixer (remote) ..... 250
- Power
  - Interval search ..... 145
  - PPDU ..... 15
  - vs frequency ..... 37
  - vs time, see PvT ..... 44, 45, 46
- Power interval search ..... 293
- Power normalize
  - MIMO ..... 183
- Power sensors
  - Trigger mode ..... 133
- PPDU
  - Amount to analyze ..... 185, 187, 327
  - Amount to analyze (remote) ..... 327
  - Analysis mode ..... 152, 155, 160, 168, 178
  - Analyzed ..... 12, 95
  - Channel bandwidth
    - ..... 152, 153, 156, 160, 161, 168, 169, 176, 179, 302
  - Count (remote) ..... 373
  - Currently analyzed ..... 15, 18
  - Demodulation ..... 151
  - Displayed ..... 12
  - EVM (Direct) ..... 23
  - Extension Spatial Streams (IEEE 802.11 n) ..... 181, 300
  - Format ..... 152, 156, 160, 168, 176, 179
  - Format (remote) ..... 304, 307
  - Guard interval length (IEEE 802.11 n, ac)
    - ..... 154, 158, 166, 174, 181, 300, 301
  - Guard interval length (IEEE 802.11ac, ax, n, be) ..... 437
  - Length ..... 376
  - Level errors ..... 150, 296, 297
  - Maximum length (remote) ..... 331, 332
  - Minimum length (remote) ..... 332, 333
  - Modulation ..... 153, 307
  - Modulation (IEEE 802.11 a) ..... 154, 177
  - Modulation (IEEE 802.11 n, ac) ..... 157, 179
  - Modulation (remote) ..... 306
  - Ness (IEEE 802.11 n) ..... 181, 300
  - Nsts ..... 157
  - Nsts (IEEE 802.11 ac) ..... 158, 310
  - Number to analyze ..... 328
  - Number to analyze (remote) ..... 327
  - Payload length ..... 185, 186, 188
  - Payload length (remote) ..... 326
  - Phase drift ..... 149, 297
  - Physical channel ..... 15, 18
  - Pilots ..... 150, 298
  - Power ..... 15
  - Power search ..... 145, 293
  - Recognized ..... 15, 18, 95
  - Selecting ..... 408
  - Signal field ..... 52, 152, 155, 160, 168, 178, 308
  - Start position ..... 375
  - STBC (IEEE 802.11 ac,n) ..... 158, 180, 301
  - Synchronization (MIMO) ..... 140
  - Timing errors ..... 149, 299
  - Total analyzed ..... 15, 18
  - Valid ..... 95
- PPDUs
  - Evaluation range ..... 184
  - PvT ..... 232
- Preamble
  - Channel estimation ..... 147, 298, 437
  - Units ..... 393
- Preamplifier
  - Setting ..... 124
  - Softkey ..... 124
- Preset
  - Bands (External Mixer, remote) ..... 246
- Presetting
  - Channels ..... 109
- Pretrigger ..... 134
- Programming examples
  - External Mixer ..... 254
  - SEM ..... 444
  - Statistics ..... 441
  - WLAN ..... 440
- Protection
  - RF input (remote) ..... 239
- PvT
  - Falling edge, result display ..... 46
  - Full PPDU ..... 232
  - Full PPDU, result display ..... 44
  - Rising & Falling ..... 232
  - Rising edge, result display ..... 45
- PvT Full Burst
  - Trace data ..... 420
- Q**
  - Quadrature offset ..... 21, 22
  - Error ..... 15
- R**
  - Range ..... 126
  - Receive filter ..... 129
  - Record length
    - Definition ..... 446
    - Relationship to sample rate ..... 447
  - Reference frequency
    - Coupling (MIMO) ..... 140
  - Reference level
    - Auto level ..... 122, 197
    - Auto level (continuous) ..... 121
    - Offset ..... 121
    - Offset (softkey) ..... 121
    - Position ..... 127
    - Unit ..... 122
    - Value ..... 121
  - Refreshing
    - MSRA secondary applications ..... 198
    - Softkey ..... 198
  - Release notes ..... 8
  - Remote commands
    - Basics on syntax ..... 219
    - Boolean values ..... 223
    - Capitalization ..... 220
    - Character data ..... 223
    - Data blocks ..... 223
    - Deprecated ..... 436
    - Numeric values ..... 222
    - Optional keywords ..... 221
    - Parameters ..... 221
    - Strings ..... 223
    - Suffixes ..... 220
  - Repetition interval ..... 134
    - Softkey ..... 134
  - Resetting
    - RF input protection ..... 239

Restoring	
Channel settings	109
Result configuration	
Softkey	189
Result displays	
AM/AM	28
AM/EVM	29
AM/PM	29
Amplitude Tracking	30
Bitstream	30
Configuration (remote)	347
Configuring	107
Constellation	32
Constellation vs carrier	34
Diagram	62
Evaluated data	183
EVM vs carrier	35
EVM vs chip	36
EVM vs Symbol	36
FFT spectrum	37
Freq. Error vs Preamble	38
Gain Imbalance vs Carrier	39
Group Delay	40
Magnitude Capture	41
Marker table	63
Peak list	64
Phase Error vs Preamble	42
Phase Tracking	43
PvT Falling Edge	46
PvT Full PPDU	44
PvT Rising Edge	45
Quad Error vs Carrier	47
Result Summary	63
Result Summary Detailed	47
Result Summary Global	49
Result Summary, items	189
Result Summary, items (remote)	358
see also Evaluation methods	15
Signal Content Detailed	51
Signal Field	52
Signal Field (K91/91n)	43
Spectrum Flatness	54
Spectrum Flatness Result Summary	56
Unused Tone Error	56, 57
WLAN	27
Result Summary	
Detailed (result display)	47
Evaluation method	63
Global (result display)	49
Items to display	189
Items to display (remote)	358
Result display	63
Trace data	410
Results	
AM/AM	414
AM/EVM	414
AM/PM	414
Bitstream	414
CCDF	415
Constellation vs carrier	417
Constellation vs symbol	416
Evaluating	204
EVM vs Carrier	417
Exporting (remote)	426
FFT Spectrum	419
Group delay	419
Magnitude Capture	410
Numeric (remote)	372
PvT Full Burst	420
Result summary	410
Retrieving (remote)	372
RF (remote)	401
Signal field	421
Spectrum Flatness	421
Trace (remote)	406
Trace data query (remote)	410
Updating the display	198
Retrieving	
Numeric results (remote)	372
Results (remote)	372
RF Results (remote)	401
Trace results (remote)	406
RF attenuation	
Auto	122
Manual	122
RF input	112
Overload protection (remote)	239
Remote	238
RF measurements	
Analysis	204
Configuration (remote)	342
MSRA	59
Results (remote)	401
Step by step	213
RF overrange	
External Mixer	250
RF Power	
Trigger	132
Trigger level (remote)	281
Rise time	
Limit check result (remote)	398
RUN CONT	
Key	198
RUN SINGLE	
Key	198
<b>S</b>	
Safety instructions	8
Sample rate	15, 18
Definition	446
Displayed	12
Maximum	446
Relationship to bandwidth	447
Remote	277
Samples	
Number	15, 18
Scaling	
Y-axis	195
Secondary analyzers	
IP address (MIMO)	139
State (MIMO)	139
Security procedures	8
Select meas	105
SEM	
Configuring (cdma2000)	200
Programming example	444
Results	60
Sequencer	105
Activating (remote)	370
Mode	106
Remote	369
Softkey	106
State	106

- Sequences
  - Aborting (remote) ..... 370
  - Mode (remote) ..... 370
- Sequential
  - MIMO capture method ..... 141
- Sequential (manual)
  - MIMO capture method ..... 143
- Service manual ..... 7
- Settings
  - Overview ..... 108
- Short symbol (SS)
  - IEEE 802.11a, g (OFDM), j, p ..... 67
- Signal capturing
  - Duration ..... 128
  - Duration (remote) ..... 277
  - Remote control ..... 274
  - Softkey ..... 127
- Signal Content
  - Detailed (result display) ..... 51
- Signal description
  - Configuring ..... 110
  - Remote control ..... 236
  - Softkey ..... 110
- Signal field ..... 308
- Signal Field
  - PPDU analysis ..... 152, 155, 160, 168, 178
  - Result display ..... 52
  - Trace data ..... 421
- Signal ID
  - External Mixer (remote) ..... 244
- Signal processing
  - IEEE 802.11a, g (OFDM), j, p ..... 65
  - IEEE 802.11b, g (DSSS) ..... 72
- Simultaneous
  - MIMO capture method ..... 139
- Single Sequencer
  - Softkey ..... 106
- Single sweep
  - Softkey ..... 198
- SISO ..... 78
- Skew ..... 22
- Slope
  - Trigger ..... 135, 282
- SmartGrid ..... 27, 107
- softkey
  - Average Length (K91/91n) ..... 188
  - Ref Pow Max/Mean (K91/91n) ..... 188
- Softkeys
  - Amplitude Config ..... 120
  - Auto Level ..... 122, 197
  - BB Power ..... 131
  - Capture Offset ..... 128, 135
  - Center ..... 119
  - Continue Single Sweep ..... 198
  - Continuous Sequencer ..... 106
  - Continuous Sweep ..... 198
  - Digital I/Q ..... 132
  - Display Config ..... 107
  - External ..... 131
  - Free Run ..... 131
  - Frequency Config ..... 118
  - Input Source Config ..... 112
  - Meastime Auto ..... 197
  - Meastime Manual ..... 197
  - Outputs Config ..... 117
  - Power Sensor ..... 133
  - Preamp ..... 124
  - Ref Level Offset ..... 121
  - Refresh ..... 198
  - Repetition interval ..... 134
  - Result Config ..... 189
  - RF Atten Auto ..... 122
  - RF Atten Manual ..... 122
  - RF Power ..... 132
  - Sequencer ..... 106
  - Signal Capture ..... 127
  - Signal Description ..... 110
  - Single Sequencer ..... 106
  - Single Sweep ..... 198
  - Sweep Config ..... 197
  - Time ..... 133
  - Trigger Config ..... 130
  - Trigger Offset ..... 134
- Space-Time Block Coding
  - see STBC ..... 158, 180
- Space-time stream ..... 80
- Span
  - Menu ..... 107
- Spatial mapping mode
  - MIMO ..... 182
  - User-defined (MIMO) ..... 183
- Speaker
  - Remote control ..... 263
- Specifications ..... 8
- Specifics for
  - Configuration ..... 109
- Spectrum Emission Mask
  - see SEM ..... 60
- Spectrum Flatness
  - Parameters ..... 15
  - Result display ..... 54
  - Trace data ..... 421
  - Units ..... 360
- Standard
  - see Digital standard ..... 12
- Standard WLAN measurements ..... 15
- Starting
  - WLAN application ..... 11
- Statistic count ..... 185, 187, 327
  - Remote ..... 327
- Statistics
  - PPDUs ..... 19
  - Programming example ..... 441
- Status bar ..... 14
  - Error messages ..... 216
- Status registers
  - Contents ..... 430
  - Querying ..... 430, 433
  - STAT:QUES:POW ..... 239
  - STATus:QUESTionable:DIQ ..... 430
  - STATus:QUESTionable:SYNC ..... 430
  - WLAN ..... 430
- STBC
  - PPDUs ..... 158, 180
  - PPDUs (remote) ..... 301
- Suffixes
  - Common ..... 219
  - Remote commands ..... 220
- Swap I/Q ..... 129
  - Remote ..... 276
- Sweep
  - Aborting ..... 198
  - Configuration (softkey) ..... 197
  - Time (remote) ..... 277



- Symbol clock
  - Error ..... 15
  - error limit (remote) ..... 337
  - Error, limit check result (remote) ..... 397
- Symbols
  - Count (remote) ..... 373
  - Data ..... 71
  - Long (IEEE 802.11a, g (OFDM), j, p) ..... 67
  - Short (IEEE 802.11a, g (OFDM), j, p) ..... 67
- Synchronization ..... 145
  - Remote control ..... 293
- T**
- Time trigger
  - Repetition interval ..... 134
  - Softkey ..... 133
- Timing
  - Coarse ..... 67
  - Detection (IEEE 802.11a, g (OFDM), j, p) ..... 67
  - Deviations ..... 40
  - Fine ..... 67
  - Tracking ..... 149
  - Tracking (IEEE 802.11a, g (OFDM), j, p) ..... 69
- Timing error tracking ..... 299
- Tolerance
  - Parameters ..... 15
- Traces
  - Exporting (remote) ..... 426
  - Querying results ..... 27
  - Results (remote) ..... 406
  - Retrieving (remote) ..... 422
- Tracking ..... 69
  - crosstalk ..... 296
  - Level errors ..... 150, 296, 297
  - Phase drift ..... 149, 297
  - Pilots ..... 150, 298
  - Remote control ..... 294
  - Timing errors ..... 149, 299
- Transmit filter ..... 129
- Trigger
  - Configuration (remote) ..... 277
  - Configuration (softkey) ..... 130
  - Drop-out time ..... 134
  - Drop-Out Time ..... 100
  - External (remote) ..... 282
  - Holdoff ..... 101, 135
  - Hysteresis ..... 100, 134
  - Measurements ..... 99
  - Offset ..... 99, 134
  - Slope ..... 135, 282
  - Synchronization ..... 102
- Trigger level ..... 133
  - Auto ..... 133
  - Auto (remote) ..... 281
  - External trigger (remote) ..... 280
  - I/Q Power (remote) ..... 280
  - IF Power (remote) ..... 280
  - RF Power (remote) ..... 281
- Trigger source ..... 131
  - BB Power ..... 131
  - Digital I/Q ..... 132
  - External ..... 131
  - Free Run ..... 131
  - I/Q Power ..... 133
  - Power Sensor ..... 133
  - RF Power ..... 132
  - Time ..... 133
- Troubleshooting ..... 215
  - Input overload ..... 239
- U**
- Units
  - EVM results ..... 393
  - Gain imbalance results ..... 393
  - PPDU length results ..... 376
  - Preamble results ..... 393
  - Reference level ..... 122
  - Spectrum Flatness results ..... 360
- Unused tone error ..... 24
- Unused Tone Error ..... 56, 57
- Updating
  - Result display ..... 198
- Usable I/Q bandwidth
  - Definition ..... 446
- User sample rate
  - Definition ..... 446
- V**
- Videos ..... 9
- Volume
  - Remote control ..... 263
- W**
- White papers ..... 9
- Window title bar ..... 13
- Windows
  - Adding (remote) ..... 350
  - Closing (remote) ..... 357
  - Configuring ..... 109
  - Layout (remote) ..... 354
  - Maximizing (remote) ..... 347
  - Querying (remote) ..... 352, 353
  - Replacing (remote) ..... 354
  - Splitting (remote) ..... 347
  - Types (remote) ..... 350
- WLAN
  - Measurements ..... 15
  - Measurements, step by step ..... 206
  - Parameters ..... 15
  - Programming examples ..... 440
  - Remote control ..... 218
  - Results ..... 15
- Y**
- Y-maximum, Y-minimum
  - Scaling ..... 195
- YIG-preselector
  - Activating/Deactivating ..... 115
  - Activating/Deactivating (remote) ..... 240