

# R&S®FSW-K7

## AM/FM/PM Modulation Analysis

### Option

### User Manual



1173924002  
Version 42



This manual applies to the following FSW models with firmware version 6.00 and later:

- R&S®FSW8 (1331.5003K08 / 1312.8000K08)
- R&S®FSW13 (1331.5003K13 / 1312.8000K13)
- R&S®FSW26 (1331.5003K26 / 1312.8000K26)
- R&S®FSW43 (1331.5003K43 / 1312.8000K43)
- R&S®FSW50 (1331.5003K50 / 1312.8000K50)
- R&S®FSW67 (1331.5003K67 / 1312.8000K67)
- R&S®FSW85 (1331.5003K85 / 1312.8000K85)

The following firmware options are described:

- FSW-K7 (1313.1339.02)

© 2024 Rohde & Schwarz

Muehdorfstr. 15, 81671 Muenchen, Germany

Phone: +49 89 41 29 - 0

Email: [info@rohde-schwarz.com](mailto:info@rohde-schwarz.com)

Internet: [www.rohde-schwarz.com](http://www.rohde-schwarz.com)

Subject to change – data without tolerance limits is not binding.

R&S® is a registered trademark of Rohde & Schwarz GmbH & Co. KG.

All other trademarks are the properties of their respective owners.

1173.9240.02 | Version 42 | R&S®FSW-K7

Throughout this manual, products from Rohde & Schwarz are indicated without the ® symbol, e.g. R&S®FSW is indicated as R&S FSW. Products of the R&S®SMW family, e.g. R&S®SMW200A, are indicated as R&S SMW.

# Contents

<b>1</b>	<b>Documentation overview.....</b>	<b>7</b>
1.1	Getting started manual.....	7
1.2	User manuals and help.....	7
1.3	Service manual.....	7
1.4	Instrument security procedures.....	8
1.5	Printed safety instructions.....	8
1.6	Specifications and brochures.....	8
1.7	Release notes and open-source acknowledgment (OSA).....	8
1.8	Application notes, application cards, white papers, etc.....	9
1.9	Videos.....	9
<b>2</b>	<b>Welcome to the R&amp;S FSW AM/FM/PM Modulation Analysis applica- tion.....</b>	<b>10</b>
2.1	Starting AM/FM/PM Modulation Analysis.....	10
2.2	Understanding the display information.....	11
<b>3</b>	<b>Measurements and result displays.....</b>	<b>15</b>
<b>4</b>	<b>Measurement basics.....</b>	<b>27</b>
4.1	Demodulation process.....	27
4.2	Demodulation bandwidth.....	29
4.3	Sample rate and demodulation bandwidth.....	30
4.4	AF triggers.....	32
4.5	AF filters.....	32
4.6	Time domain zoom.....	32
4.7	I/Q data import and export.....	34
4.8	Analog modulation analysis in MSRA/MSRT operating mode.....	34
<b>5</b>	<b>Configuration.....</b>	<b>37</b>
5.1	Configuration overview.....	37
5.2	Configuration according to standards.....	39
5.3	Input and frontend settings.....	41
5.3.1	Input source settings.....	41
5.3.2	Amplitude settings.....	45

5.3.3	Frequency.....	50
<b>5.4</b>	<b>Trigger configuration.....</b>	<b>51</b>
5.4.1	Trigger source settings.....	52
5.4.2	Trigger input and output settings.....	59
<b>5.5</b>	<b>Data acquisition.....</b>	<b>61</b>
5.5.1	Bandwidth settings.....	61
5.5.2	Sweep settings.....	63
<b>5.6</b>	<b>Demodulation display.....</b>	<b>66</b>
<b>5.7</b>	<b>Demodulation.....</b>	<b>67</b>
5.7.1	Basic demodulation measurement parameters (Demod).....	67
5.7.2	Demodulation spectrum.....	70
5.7.3	AF filter.....	73
5.7.4	Scaling.....	77
5.7.5	Units.....	81
5.7.6	Result table settings.....	82
5.7.7	Settling time.....	85
<b>5.8</b>	<b>Output settings.....</b>	<b>87</b>
5.8.1	Output settings.....	87
5.8.2	Analog demod output settings.....	88
5.8.3	Digital I/Q 40G output settings.....	90
<b>5.9</b>	<b>Adjusting settings automatically.....</b>	<b>92</b>
<b>6</b>	<b>Analysis.....</b>	<b>96</b>
<b>6.1</b>	<b>Trace settings.....</b>	<b>96</b>
<b>6.2</b>	<b>Spectrogram settings.....</b>	<b>100</b>
6.2.1	General spectrogram settings.....	100
6.2.2	Color map settings.....	104
<b>6.3</b>	<b>Trace / data export configuration.....</b>	<b>105</b>
<b>6.4</b>	<b>Working with markers in the R&amp;S FSW AM/FM/PM Modulation Analysis application.....</b>	<b>109</b>
6.4.1	Marker settings.....	109
6.4.2	Marker search settings and positioning functions.....	114
6.4.3	Marker search settings for spectrograms.....	117
6.4.4	Marker function configuration.....	120

6.5	Analysis in MSRA/MSRT mode.....	133
7	I/Q data import and export.....	134
8	How to perform measurements in the R&S FSW AM/FM/PM Modulation Analysis application.....	135
8.1	How to export trace data and numerical results.....	136
9	Measurement example: demodulating an FM signal.....	138
10	Optimizing and troubleshooting the measurement.....	143
11	Remote commands for AM/FM/PM Modulation Analysis.....	144
11.1	Introduction.....	145
11.1.1	Conventions used in descriptions.....	146
11.1.2	Long and short form.....	146
11.1.3	Numeric suffixes.....	147
11.1.4	Optional keywords.....	147
11.1.5	Alternative keywords.....	147
11.1.6	SCPI parameters.....	148
11.2	Common suffixes.....	150
11.3	Activating analog modulation analysis.....	150
11.4	Configuring the measurement.....	155
11.4.1	Managing standard settings.....	155
11.4.2	Configuring the input.....	156
11.4.3	Configuring the output.....	211
11.4.4	Digital I/Q 40G streaming output commands.....	213
11.4.5	Frequency settings.....	215
11.4.6	Configuring the vertical axis (amplitude, scaling).....	216
11.4.7	Configuring data acquisition.....	225
11.4.8	Triggering.....	230
11.4.9	Configuring demodulation.....	241
11.4.10	Adjusting settings automatically.....	260
11.5	Capturing data and performing sweeps.....	264
11.6	Configuring the result display.....	269
11.6.1	General window commands.....	269
11.6.2	Working with windows in the display.....	270

<b>11.7 Retrieving results</b> .....	<b>277</b>
11.7.1 Retrieving trace results.....	278
11.7.2 Exporting trace results.....	281
11.7.3 Retrieving result summary values.....	284
11.7.4 Formats for returned values: ASCII format and binary format.....	288
11.7.5 Reference: ASCII file export format.....	289
<b>11.8 Analyzing results</b> .....	<b>291</b>
11.8.1 Configuring spectrograms.....	291
11.8.2 Configuring standard traces.....	299
11.8.3 Working with markers remotely.....	306
11.8.4 Marker search (spectrograms).....	346
11.8.5 Defining limit checks.....	354
11.8.6 Configuring an analysis interval and line (MSRA mode only).....	370
11.8.7 Configuring an analysis interval and line (MSRT mode only).....	372
<b>11.9 Importing and exporting I/Q data and results</b> .....	<b>373</b>
<b>11.10 Deprecated commands</b> .....	<b>375</b>
<b>11.11 Programming example</b> .....	<b>376</b>
<b>Annex</b> .....	<b>379</b>
<b>A Predefined standards and settings</b> .....	<b>379</b>
<b>List of Commands (Analog Modulation Analysis)</b> .....	<b>381</b>
<b>Index</b> .....	<b>394</b>

# 1 Documentation overview

This section provides an overview of the FSW user documentation. Unless specified otherwise, you find the documents at:

[www.rohde-schwarz.com/manual/FSW](http://www.rohde-schwarz.com/manual/FSW)

Further documents are available at:

[www.rohde-schwarz.com/product/FSW](http://www.rohde-schwarz.com/product/FSW)

## 1.1 Getting started manual

Introduces the FSW and describes how to set up and start working with the product. Includes basic operations, typical measurement examples, and general information, e.g. safety instructions, etc.

A printed version is delivered with the instrument. A PDF version is available for download on the Internet.

## 1.2 User manuals and help

Separate user manuals are provided for the base unit and the firmware applications:

- Base unit manual  
Contains the description of all instrument modes and functions. It also provides an introduction to remote control, a complete description of the remote control commands with programming examples, and information on maintenance, instrument interfaces and error messages. Includes the contents of the getting started manual.
- Firmware application manual  
Contains the description of the specific functions of a firmware application, including remote control commands. Basic information on operating the FSW is not included.

The contents of the user manuals are available as help in the FSW. The help offers quick, context-sensitive access to the complete information for the base unit and the firmware applications.

All user manuals are also available for download or for immediate display on the Internet.

## 1.3 Service manual

Describes the performance test for checking the rated specifications, module replacement and repair, firmware update, troubleshooting and fault elimination, and contains mechanical drawings and spare part lists.

The service manual is available for registered users on the global Rohde & Schwarz information system (GLORIS):

<https://gloris.rohde-schwarz.com>

## 1.4 Instrument security procedures

Deals with security issues when working with the FSW in secure areas. It is available for download on the internet.

## 1.5 Printed safety instructions

Provides safety information in many languages. The printed document is delivered with the product.

## 1.6 Specifications and brochures

The specifications document, also known as the data sheet, contains the technical specifications of the FSW. It also lists the firmware applications and their order numbers, and optional accessories.

The brochure provides an overview of the instrument and deals with the specific characteristics.

See [www.rohde-schwarz.com/brochure-datasheet/FSW](http://www.rohde-schwarz.com/brochure-datasheet/FSW)

## 1.7 Release notes and open-source acknowledgment (OSA)

The release notes list new features, improvements and known issues of the current firmware version, and describe the firmware installation.

The firmware makes use of several valuable open source software packages. An open-source acknowledgment document provides verbatim license texts of the used open source software.

See [www.rohde-schwarz.com/firmware/FSW](http://www.rohde-schwarz.com/firmware/FSW)



## 1.8 Application notes, application cards, white papers, etc.

These documents deal with special applications or background information on particular topics.

See [www.rohde-schwarz.com/application/FSW](http://www.rohde-schwarz.com/application/FSW)

## 1.9 Videos

Find various videos on Rohde & Schwarz products and test and measurement topics on YouTube: <https://www.youtube.com/@RohdeundSchwarz>

## 2 Welcome to the R&S FSW AM/FM/PM Modulation Analysis application

The R&S FSW AM/FM/PM Modulation Analysis application converts the FSW into an analog modulation analyzer for amplitude-, frequency- or phase-modulated signals. It measures not only characteristics of the useful modulation, but also factors such as residual FM or synchronous modulation.

The digital signal processing in the FSW, used in the Spectrum application for digital IF filters, is also ideally suited for demodulating AM, FM, or PM signals.

The firmware option R&S FSW-K7 provides the necessary measurement functions.

The R&S FSW AM/FM/PM Modulation Analysis application features:

- AM, FM, and PM demodulation, with various result displays:
  - Modulation signal versus time
  - Spectrum of the modulation signal (FFT)
  - RF signal power versus time
  - Spectrum of the RF signal
- Determining maximum, minimum and average or current values in parallel over a selected number of measurements
- Maximum accuracy and temperature stability due to sampling (digitization) already at the IF and digital down-conversion to the baseband (I/Q)
- Error-free AM to FM conversion and vice versa, without deviation errors, frequency response or frequency drift at DC coupling
- Relative demodulation, in relation to a user-defined or measured reference value

This user manual contains a description of the functionality that the application provides, including remote control operation.

All functions not discussed in this manual are the same as in the base unit and are described in the FSW User Manual. The latest version is available for download at the product homepage <http://www.rohde-schwarz.com/product/FSW>.

### 2.1 Starting AM/FM/PM Modulation Analysis

AM/FM/PM Modulation Analysis is a separate application on the FSW.

#### To activate AM/FM/PM Modulation Analysis

1. Select [MODE].

A dialog box opens that contains all operating modes and applications currently available on your FSW.
2. Select the "AM FM PM Analog Demod" item.



The FSW opens a new channel for the application for analog modulation analysis.

The measurement is started immediately with the default settings. It can be configured in the analog modulation analysis "Overview" dialog box, which is displayed when you select "Overview" from any menu (see [Chapter 5.1, "Configuration overview"](#), on page 37).

### Multiple Channels and Sequencer Function

When you activate an application, a new channel is created which determines the measurement settings for that application ("Channel"). The same application can be activated with different measurement settings by creating several "Channel"s for the same application.

The number of channels that can be configured at the same time depends on the available memory on the instrument.

Only one measurement can be performed at any time, namely the one in the currently active channel. However, to perform the configured measurements consecutively, a Sequencer function is provided.

If activated, the measurements configured in the currently defined "Channel"s are performed one after the other in the order of the tabs. The currently active measurement is indicated by a  symbol in the tab label.

The result displays of the individual channels are updated in the tabs (as well as the "MultiView") as the measurements are performed. Sequential operation itself is independent of the currently *displayed* tab.

For details on the Sequencer function, see the FSW User Manual.

## 2.2 Understanding the display information

The following figure shows a measurement diagram during analog modulation analysis. All different information areas are labeled. They are explained in more detail in the following sections.



- 1 = Channel bar for firmware and measurement settings
- 2 = Window title bar with diagram-specific (trace) information
- 3 = Diagram area
- 4 = Diagram footer with diagram-specific information, depending on result display
- 5 = Instrument status bar with error messages and date/time display



### MSRA/MSRT operating mode

In MSRA/MSRT operating mode, additional tabs and elements are available. A colored background of the screen behind the channel tabs indicates that you are in MSRA/MSRT operating mode.

For details on the MSRA operating mode, see the FSW MSRA User Manual. For details on the MSRT operating mode, see the FSW Realtime Spectrum Application and MSRT Operating Mode User Manual.

### Channel bar information

In the Analog Modulation Analysis application, the FSW shows the following settings:

**Table 2-1: Information displayed in the channel bar in the application for analog modulation analysis**

Ref Level	Reference level
m.+el.Att	Mechanical and electronic RF attenuation
Offset	Reference level offset
AQT	Measurement time for data acquisition.
RBW	Resolution bandwidth
DBW	Demodulation bandwidth
Freq	Center frequency for the RF signal

### Window title bar information

For each diagram, the header provides the following information:



**Figure 2-1: Window title bar information in the application for analog modulation analysis**

- 1 = Window number
- 2 = Window type
- 3 = Trace color
- 4 = Trace number
- 5 = Detector
- 6 = Trace mode
- 7 = Reference value (at the defined reference position)
- 8 = AF coupling (AC/DC), only in AF time domains, if applicable
- 9 = Results are selected for demodulation output

### Diagram footer information

The diagram footer (beneath the diagram) contains the following information, depending on the evaluation:

"RF Spectrum"		
CF: Center frequency of input signal	Sweep points	Span: measured span

RF Time domain		
CF: Center frequency of input signal	Sweep points	Time per division

AF Spectrum		
AF CF: center frequency of demodulated signal	Sweep points	AF Span: evaluated span

AF Time domain		
CF: Center frequency of input signal	Sweep points	Time per division

For most modes, the number of sweep points shown in the display are indicated in the diagram footer. In zoom mode, the (rounded) number of currently displayed points are indicated.

**Status bar information**

Global instrument settings, the instrument status and any irregularities are indicated in the status bar beneath the diagram.

Furthermore, the progress of the current operation is displayed in the status bar.

## 3 Measurements and result displays

**Access:** "Overview" > "Display Config"

**Or:** [MEAS] > "Display Config"

The data that was measured by the FSW can be evaluated using various different methods. In the Analog Modulation Analysis application, up to six evaluation methods can be displayed simultaneously in separate windows. The results can be displayed as absolute deviations or relative to a reference value or level.



The abbreviation "AF" (for Audio Frequency) refers to the demodulated AM, FM or PM signal.

### Basis for evaluation

All evaluations are based on the I/Q data set acquired during the measurement. The spectrum of the modulated signal to be evaluated is determined by the demodulation bandwidth. However, it can be restricted to a limited span ("AF Span") if only part of the signal is of interest. Furthermore, the time base for evaluations in the time domain can be restricted to analyze a smaller extract in more detail, see [Chapter 4.6, "Time domain zoom"](#), on page 32.

<a href="#">AM Time Domain</a> .....	15
<a href="#">FM Time Domain</a> .....	16
<a href="#">PM Time Domain</a> .....	17
<a href="#">AM Spectrum</a> .....	18
<a href="#">FM Spectrum</a> .....	19
<a href="#">PM Spectrum</a> .....	20
<a href="#">RF Time Domain</a> .....	21
<a href="#">RF Spectrum</a> .....	22
<a href="#">Result Summary</a> .....	23
<a href="#">Marker Table</a> .....	25
<a href="#">Marker Peak List</a> .....	25

### AM Time Domain

Displays the modulation depth of the demodulated AM signal (in %) versus time.

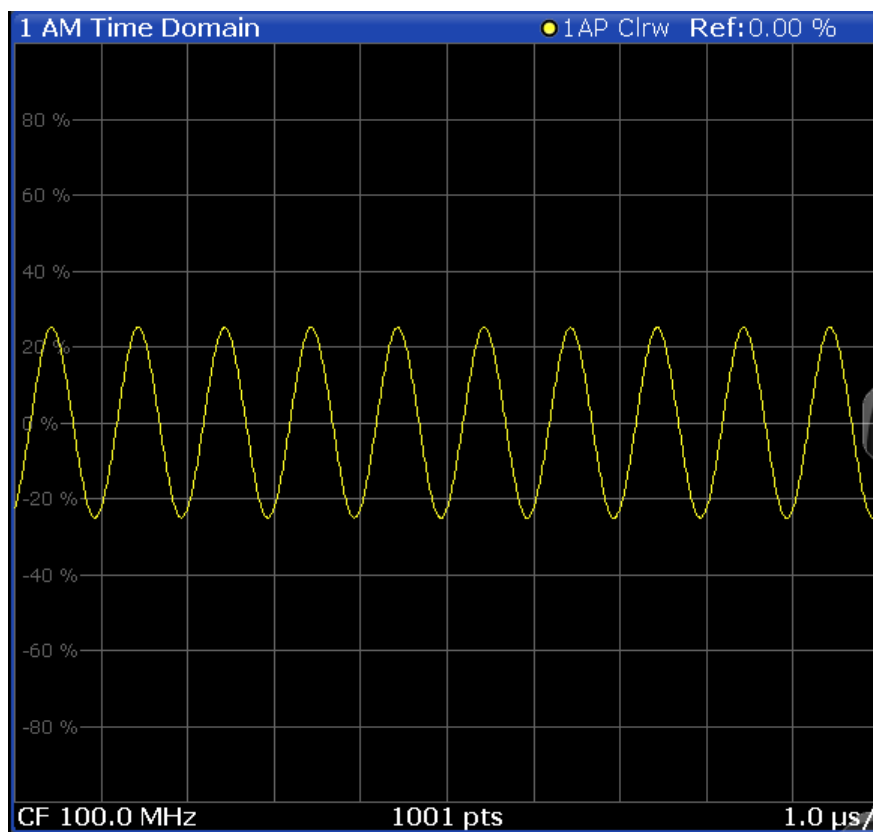

Optionally, the settling time can be evaluated and displayed, see [Chapter 5.7.7, "Settling time"](#), on page 85.

Remote command:

```
LAY:ADD? '1',RIGHT,'XTIM:AM:REL'
```

(See [LAYout:ADD\[:WINDow\]?](#) on page 270)

### FM Time Domain

Displays the frequency spectrum of the demodulated FM signal versus time.



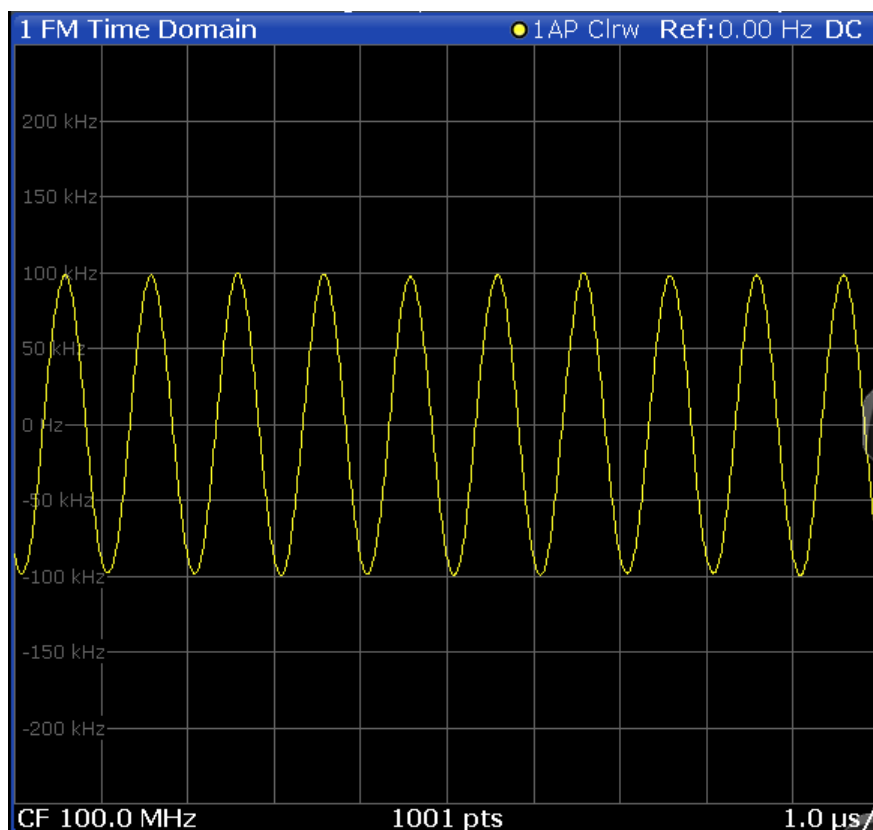

Optionally, the settling time can be evaluated and displayed, see [Chapter 5.7.7, "Settling time"](#), on page 85.

Remote command:

```
LAY:ADD? '1',RIGH,'XTIM:FM'
```

(See [LAYout:ADD\[:WINDow\]?](#) on page 270)

### PM Time Domain

Displays the phase deviations of the demodulated PM signal (in rad or °) versus time.

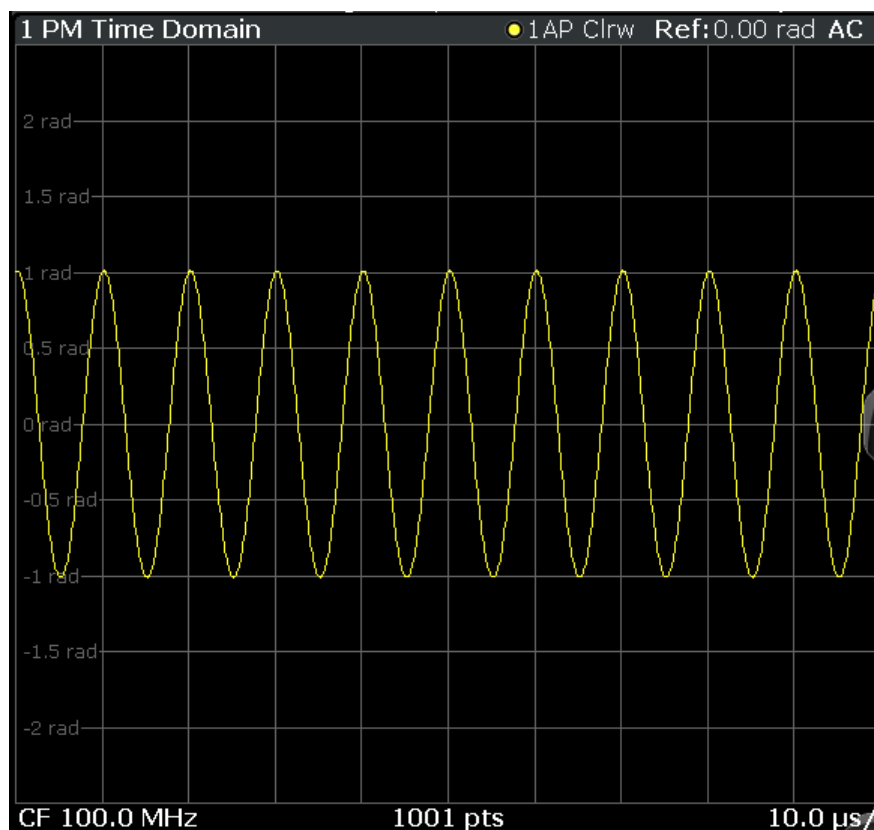

Optionally, the settling time can be evaluated and displayed, see [Chapter 5.7.7, "Settling time"](#), on page 85.

Remote command:

```
LAY:ADD? '1', RIGH, 'XTIM:PM'
```

(See [LAYout:ADD\[:WINDow\]?](#) on page 270)

### AM Spectrum

Displays the modulation depth of the demodulated AM signal (in % or dB) versus AF span. The spectrum is calculated from the demodulated AM signal in the time domain via FFT.

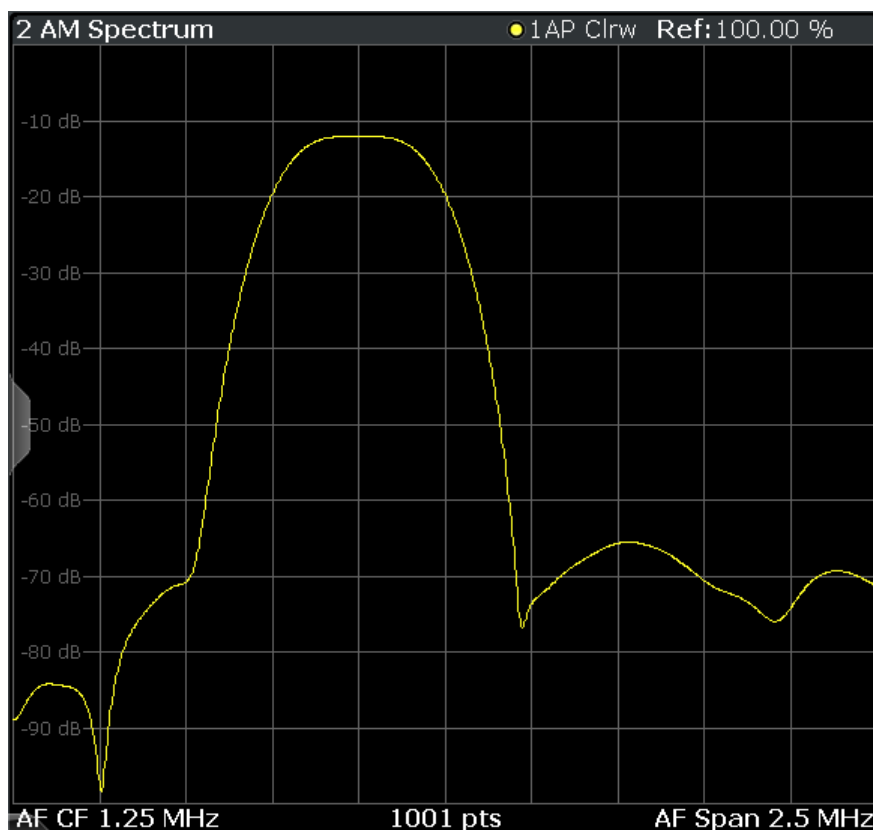

**Note:** If a high pass or low pass AF filter is defined, the filter is indicated by a vertical red line in the spectrum display.

Remote command:

```
LAY:ADD? '1',RIGH,'XTIME:AM:REL:AFSpectrum1'
```

(see [LAYout:ADD\[:WINDow\]?](#) on page 270)

### FM Spectrum

Displays the frequency deviations of the demodulated FM signal (in Hz or dB) versus AF span. The spectrum is calculated from the demodulated AM signal in the time domain via FFT.

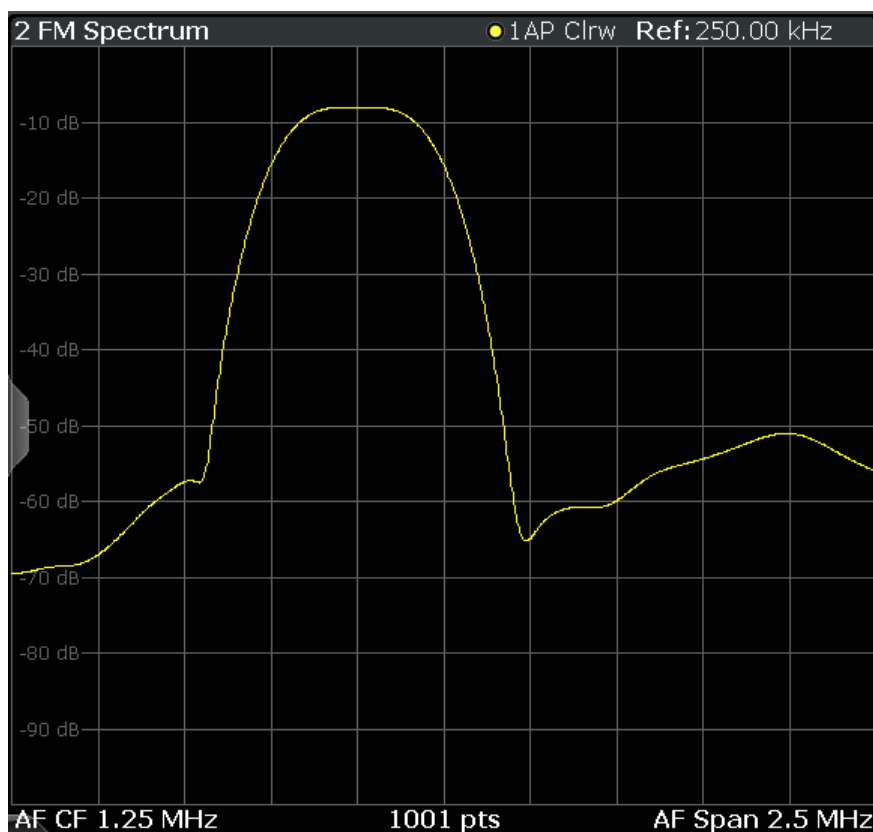

**Note:** If a high pass or low pass AF filter is defined, the filter is indicated by a vertical red line in the spectrum display.

Remote command:

```
LAY:ADD? '1',RIGH,'XTIME:FM:AFSPpectrum1'
```

(see [LAYout:ADD\[:WINDow\]?](#) on page 270)

### PM Spectrum

Displays the phase deviations of the demodulated PM signal (in rad, ° or dB) versus AF span. The spectrum is calculated from the demodulated AM signal in the time domain via FFT.

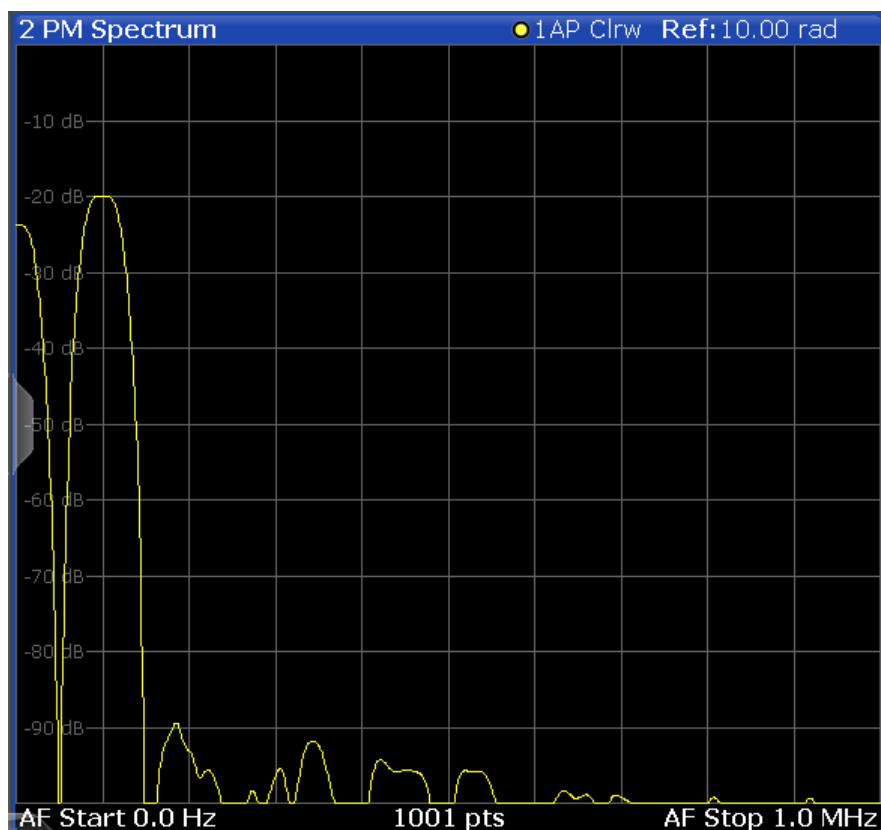

**Note:** If a high pass or low pass AF filter is defined, the filter is indicated by a vertical red line in the spectrum display.

Remote command:

```
LAY:ADD? '1',RIGH,'XTIME:PM:AFSPpectrum1'
```

(see [LAYout:ADD\[:WINDow\]?](#) on page 270)

### RF Time Domain

Displays the RF power of the input signal versus time. The level values represent the magnitude of the I/Q data set.

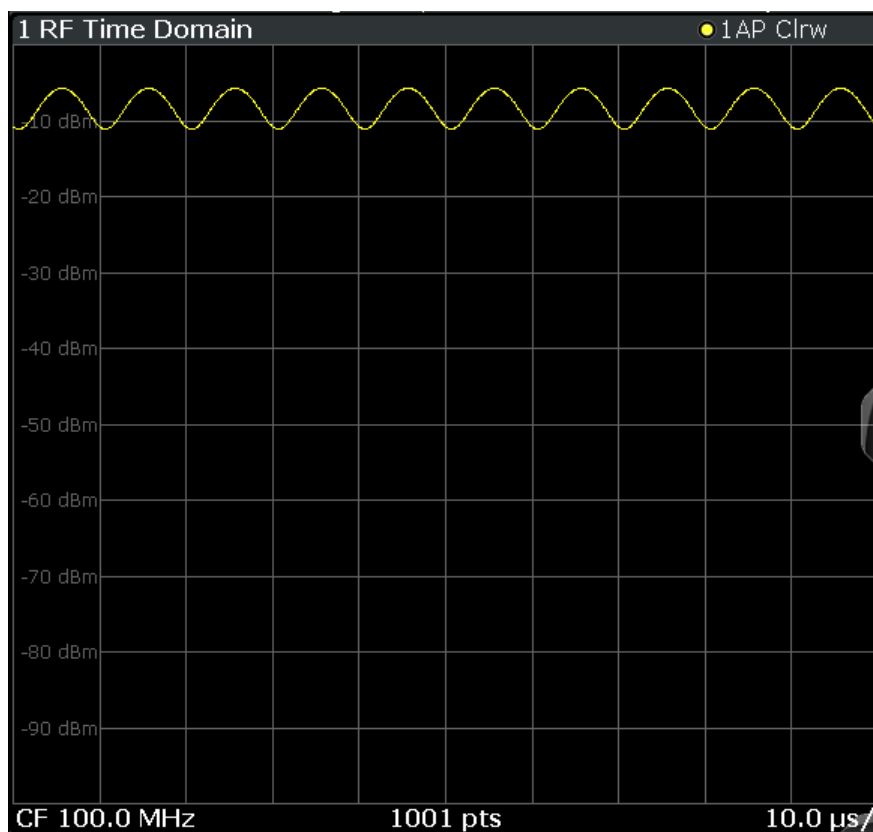

Optionally, the settling time can be evaluated and displayed, see [Chapter 5.7.7, "Settling time"](#), on page 85.

Remote command:

```
LAY:ADD? '1',RIGH,'XTIM:AM'
```

(see [LAYout:ADD\[:WINDow\]?](#) on page 270)

### RF Spectrum

Displays the spectrum of the input signal. In contrast to the Spectrum application, the frequency values are determined using FFT from the recorded I/Q data set.

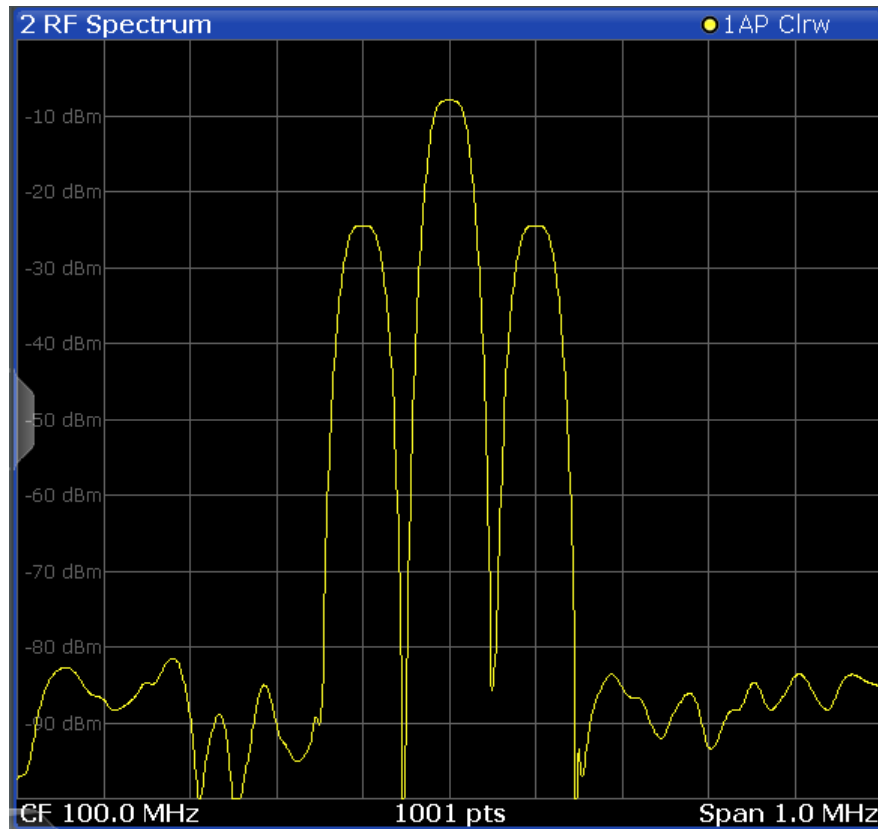

Remote command:

```
LAY:ADD? '1',RIGH,'XTIM:SPECTRUM'
```

(see [LAYout:ADD\[:WINDow\]?](#) on page 270)

### Result Summary

The "result summary" displays the results of the demodulation functions for all windows in a table.

4 Result Summary									
	Carrier Power -20.69 dBm				Carrier Offset 390.56 Hz				
	Settling Time	+Peak	-Peak	±Peak/2	RMS	Mod. Freq.	SINAD	DISTORT	THD
FM	1.022 µs	4.8423 MHz	-1.8343 MHz	3.3383 MHz	1.1283 MHz	---	---	---	---

The following general results are provided:

For each demodulation, the following results are provided:

Label	Description
"Carr Power"	Measured carrier power
"Carr Offset"	Carrier offset to nominal center frequency
"Mod. Depth"	Modulation depth

Table 3-1: Result summary description

Label	Description
"Settling Time"	Time after which signal remains in a specified value range. Only evaluated and displayed if enabled, see <a href="#">Chapter 5.7.7, "Settling time"</a> , on page 85.
"Peak"	Positive peak (maximum)
"-Peak"	Negative peak (minimum)
"Peak/2"	Average of positive and negative peaks
"RMS"	Root Mean Square value
"Mod Freq"	Modulation frequency
"SINAD"	Signal-to-noise-and-distortion (Calculated only if AF Spectrum is displayed) Measures the ratio of the total power to the power of noise and harmonic distortions. The noise and harmonic power is calculated inside the AF spectrum span. The DC offset is removed before the calculation. $SINAD[dB] = 20 \cdot \log \left[ \frac{P_{total}}{P_{Noise} + P_{distortion}} \right]$
"DISTORT"	Modulation distortion in % (Calculated only if "SINAD" is also calculated) Measures the distortion of the modulation in relation to the total power of the signal inside the AF spectrum span. Indicates the quality of the modulation. $Modulation\ distortion = \frac{\sqrt{P_{total} - P_{signal}}}{\sqrt{P_{total}}} * 100\%$
"THD"	Total harmonic distortion The ratio of the harmonics to the fundamental and harmonics. All harmonics inside the AF spectrum span are considered up to the tenth harmonic. (Calculated only if AF Spectrum is displayed) $THD[dB] = 20 \cdot \log \left[ \frac{\sqrt{\sum_{i=2}^{\infty} U_i^2}}{\sqrt{\sum_{i=1}^{\infty} U_i^2}} \right]$

**Note:** Relative demodulation results. Optionally, the demodulation results in relation to user-defined or measured reference values are determined. See [Chapter 5.7.6, "Result table settings"](#), on page 82.

In addition, the following general information for the input signal is provided:

- "Carrier Power": the power of the carrier without modulation
- "Carrier Offset": the deviation of the calculated carrier frequency to the ideal carrier frequency
- "Modulation Depth" (AM or "RF Time Domain" only): the difference in amplitude the carrier signal is modulated with



Remote command:

LAY:ADD? '1', RIGH, RSUM, see [LAYout:ADD\[:WINDow\]?](#) on page 270

Results:

[Chapter 11.7.3, "Retrieving result summary values"](#), on page 284

### Marker Table

Displays a table with the current marker values for the active markers.

This table is displayed automatically if configured accordingly.

(See ["Marker Table Display"](#) on page 113).

1 Marker Table						
Wnd	Type	Ref	Trc	X-Value	Y-Value	Function
2	M1		1	2.1725 ms	-6.80 dBm	
2	D2	M1	1	13.859 ms	-0.00 dB	
2	D3	M1	1	4.6259 ms	-0.00 dB	
2	D4	M1	1	9.2331 ms	-0.00 dB	

**Tip:** To navigate within long marker tables, simply scroll through the entries with your finger on the touchscreen.

Remote command:

LAY:ADD? '1', RIGH, MTAB, see [LAYout:ADD\[:WINDow\]?](#) on page 270

Results:

[CALCulate<n>:MARKer<m>:X](#) on page 308

[CALCulate<n>:MARKer<m>:Y?](#) on page 308

### Marker Peak List

The marker peak list determines the frequencies and levels of peaks in the spectrum or time domain. How many peaks are displayed can be defined, as well as the sort order. In addition, the detected peaks can be indicated in the diagram. The peak list can also be exported to a file for analysis in an external application.

You can define search and sort criteria to influence the results of the analysis (see [Chapter 6.4.2.1, "Marker search settings"](#), on page 115).

3 Marker Peak List				
Wnd	No	X-Value	Y-Value	
2	1	1.086245 ms	-75.810 dBm	
2	2	2.172490 ms	-6.797 dBm	
2	3	3.258736 ms	-76.448 dBm	
2	4	4.831918 ms	-76.676 dBm	
2	5	6.255274 ms	-76.482 dBm	
2	6	6.798397 ms	-6.800 dBm	
2	7	9.233084 ms	-76.519 dBm	
2	8	10.075861 ms	-76.172 dBm	
2	9	11.405574 ms	-6.801 dBm	

**Tip:** To navigate within long marker peak lists, simply scroll through the entries with your finger on the touchscreen.

Remote command:

LAY:ADD? '1', RIGH, PEAK, see [LAYout:ADD\[:WINDow\]?](#) on page 270

Results:

[CALCulate<n>:MARKer<m>:X](#) on page 308

[CALCulate<n>:MARKer<m>:Y?](#) on page 308

## 4 Measurement basics

Some background knowledge on basic terms and principles used in Analog Modulation Analysis measurements is provided here for a better understanding of the required configuration settings.

• <a href="#">Demodulation process</a> .....	27
• <a href="#">Demodulation bandwidth</a> .....	29
• <a href="#">Sample rate and demodulation bandwidth</a> .....	30
• <a href="#">AF triggers</a> .....	32
• <a href="#">AF filters</a> .....	32
• <a href="#">Time domain zoom</a> .....	32
• <a href="#">I/Q data import and export</a> .....	34
• <a href="#">Analog modulation analysis in MSRA/MSRT operating mode</a> .....	34

### 4.1 Demodulation process

The demodulation process is shown in [Figure 4-1](#). All calculations are performed simultaneously with the same I/Q data set. Magnitude (= amplitude) and phase of the complex I/Q pairs are determined. The frequency result is obtained from the differential phase.

For details on general I/Q data processing in the FSW, refer to the reference part of the I/Q Analysis remote control description in the FSW User Manual.

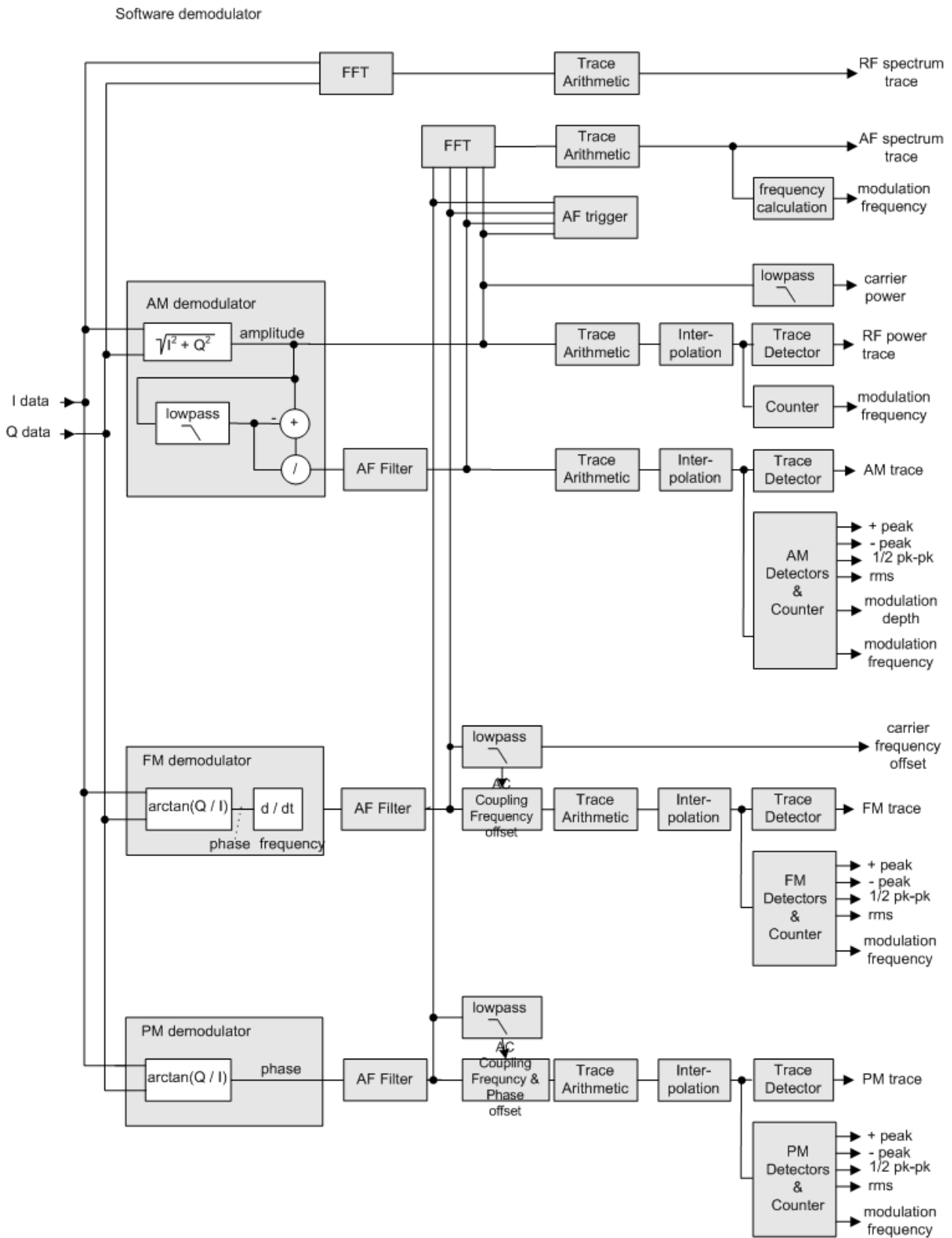

Figure 4-1: Block diagram of software demodulator

The AM DC, FM DC and PM DC raw data of the demodulators is fed into the "Trace Arithmetic" block that combines consecutive data sets. Possible trace modes are: Clear Write, Max Hold, Min Hold and Average. The output data of the "Trace Arithmetic" block can be read via remote control ([SENS:]ADEM:<evaluation>:RES?, see [SENSe:]ADEMod:AM[:ABSolute] [:TDOMain]:RESult? on page 278.

The collected measured values are evaluated by the selected detector. The result is displayed on the screen and can be read out via remote control.

In addition, important parameters are calculated:

- A counter determines the modulation frequency for AM, FM, and PM.
- average power = carrier power (RF power)
- average frequency = carrier frequency offset (FM)
- The modulation depth or the frequency or phase deviation; the deviations are determined from the trace data

AC coupling is possible with FM and PM display.

## 4.2 Demodulation bandwidth

The demodulation bandwidth determines the span of the signal that is demodulated. It is not the 3-dB bandwidth of the filter, but the useful bandwidth which is distortion-free regarding phase and amplitude.

Therefore the following formulas apply:

- AM: demodulation bandwidth  $\geq 2 \times$  modulation frequency
- FM: demodulation bandwidth  $\geq 2 \times$  (frequency deviation + modulation frequency)
- PM: demodulation bandwidth  $\geq 2 \times$  modulation frequency  $\times$  (1 + phase deviation)



If the center frequency of the analyzer is not set exactly to the signal frequency, the demodulation bandwidth must be increased by the carrier offset, in addition to the requirement described above. The bandwidth must also be increased if FM or PM AC coupling is selected.

In general, select the demodulation bandwidth as narrow as possible to improve the S/N ratio. The residual FM caused by noise floor and phase noise increases dramatically with the bandwidth, especially with FM.

For help on determining the adequate demodulation bandwidth, see "[Determining the demodulation bandwidth](#)" on page 143.

A practical example is described in [Chapter 9, "Measurement example: demodulating an FM signal"](#), on page 138.

### 4.3 Sample rate and demodulation bandwidth

The maximum demodulation bandwidths that can be obtained during the measurement, depending on the sample rate, are listed in the tables below for different demodulation filter types. The allowed value range of the measurement time and trigger offset depends on the selected demodulation bandwidth and demodulation filter. If the AF filter or the AF trigger are not active, the measurement time increases by 20 %.



A maximum of 24 million samples can be captured, assuming sufficient memory is available; thus the maximum measurement time can be determined according to the following formula:

$$\text{Meas.time}_{\text{max}} = \text{Sample count}_{\text{max}} / \text{sample rate}$$

The minimum trigger offset is  $(-\text{Meas.time}_{\text{max}})$

**Table 4-1: Available demodulation bandwidths and corresponding sample rates**

Demodulation BW	Sample Rate (Flat Top)	Sample Rate (Gaussian Top)
100 Hz	122.0703125 Hz	400 Hz
200 Hz	244.140625 Hz	800 Hz
400 Hz	488.28125 Hz	1.6 kHz
800 Hz	976.5625 Hz	3.2 kHz
1.6 kHz	1.953125 kHz	6.4 kHz
3.2 kHz	3.90625 kHz	12.8 kHz
6.4 kHz	7.8125 kHz	25.6 kHz
12.5 kHz	15.625 kHz	50 kHz
25 kHz	31.25 kHz	100 kHz
50 kHz	62.5 kHz	200 kHz
100 kHz	125 kHz	400 kHz
200 kHz	250 kHz	800 kHz
400 kHz	500 kHz	1.6 MHz
800 kHz	1 MHz	3.2 MHz
1.6 MHz	2 MHz	6.4 MHz
3 MHz	4 MHz	12 MHz
5 MHz	8 MHz	20 MHz
8 MHz	16 MHz	32 MHz
10 MHz	32 MHz	40 MHz
18 MHz	32 MHz	72 MHz
28 MHz	64 MHz	112 MHz
40 MHz	64 MHz	160 MHz

Demodulation BW	Sample Rate (Flat Top)	Sample Rate (Gaussian Top)
80 MHz	128 MHz	320 MHz
160 MHz	200 MHz	640 MHz
320 MHz	400 MHz	1280 MHz
500 MHz	600 MHz	2000 MHz
1000 MHz	1250 MHz	4000 MHz
2000 MHz	2500 MHz	8000 MHz
3000 MHz	3750 MHz	12 GHz
4000 MHz	5000 MHz	16 GHz
5000 MHz	6250 MHz	20 GHz



Flat top filters require an I/Q bandwidth at least the size of the demodulation bandwidth on the FSW. Gauss filters require at least twice the size of the demodulation bandwidth on the FSW. If necessary, install optional bandwidth extensions on the FSW to use the required demodulation filter.

#### Example:

For example, a 500 MHz flat top filter requires a bandwidth extension of 500 MHz or larger (e.g. B512). A 500 MHz Gauss filter requires a bandwidth extension of 1000 MHz or larger (e.g. B1200).

#### Large numbers of samples

Principally, the FSW can handle up to 24 million samples. However, when 480001 samples are exceeded, all traces that are not currently being displayed in a window are deactivated to improve performance. The traces can only be activated again when the samples are reduced.



#### Effects of measurement time on the stability of measurement results

Despite amplitude and frequency modulation, the display of carrier power and carrier frequency offset is stable.

Stability is achieved by a digital filter which sufficiently suppresses the modulation. As a prerequisite, the measurement time must be  $\geq 3 \times 1 / \text{modulation frequency}$ , i.e. at least three periods of the AF signal are recorded.

The mean carrier power for calculating the AM is also calculated with a digital filter. The filter returns stable results after a measurement time of  $\geq 3 \times 1 / \text{modulation frequency}$ , i.e. at least three cycles of the AF signal must be recorded before a stable AM can be shown.

## 4.4 AF triggers

The Analog Modulation Analysis application allows triggering to the demodulated signal. The display is stable if a minimum of five modulation periods are within the recording time.

Triggering is always DC-coupled. Therefore triggering is possible directly to the point where a specific carrier level, phase or frequency is exceeded or not attained.

## 4.5 AF filters

Additional filters applied after demodulation help filter out unwanted signals, or correct pre-emphasized input signals. A CCITT filter allows you to evaluate the signal by simulating the characteristics of human hearing.

## 4.6 Time domain zoom

For evaluations in the time domain, the demodulated data for a particular time span can be extracted and displayed in more detail using the "Time Domain Zoom" function. Zooming is useful if the measurement time is very large and thus each sweep point represents a large time span. The time domain zoom function distributes the available sweep points only among the time span defined by the zoom area length. The time span displayed per division of the diagram is decreased. Thus, the display of the extracted time span becomes more precise.

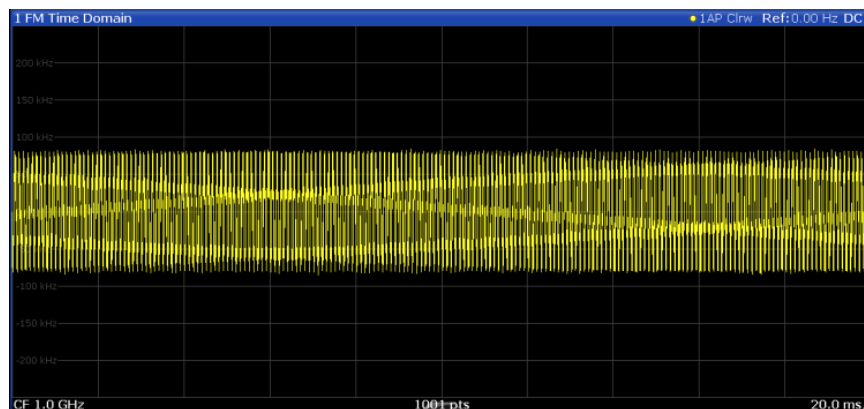

Figure 4-2: FM time domain measurement with a very long measurement time (200 ms)

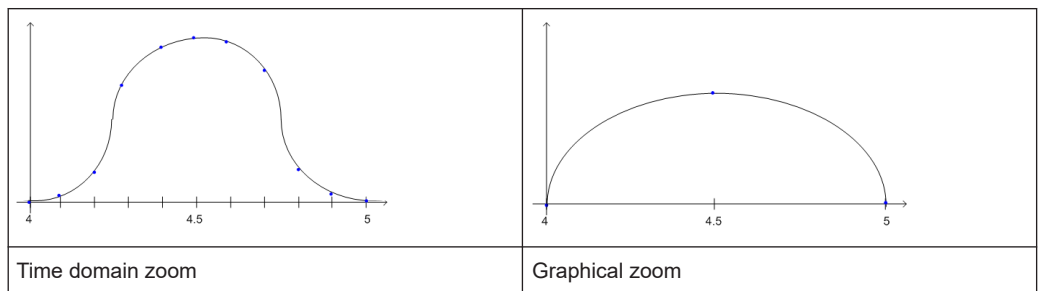
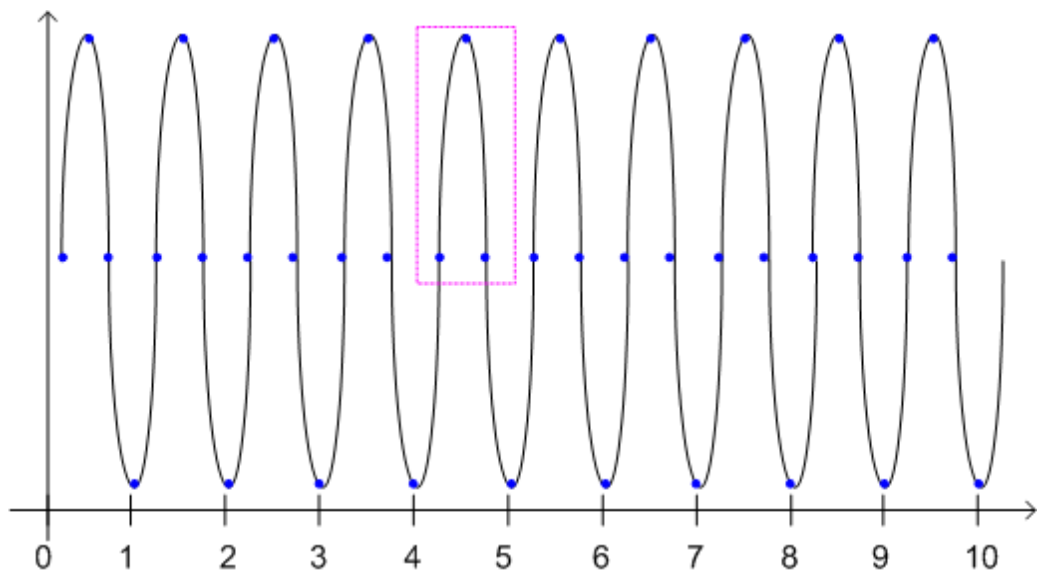



Figure 4-3: FM time domain measurement with time domain zoom (2.0 ms per division)

The time domain zoom area affects not only the diagram display, but the entire evaluation for the current window.

In contrast to the time domain zoom, the graphical zoom is available for all diagram evaluations. However, the graphical zoom is useful only if more measured values than trace points are available. The (time) span represented by each measurement point remains the same.



## 4.7 I/Q data import and export

Baseband signals mostly occur as so-called complex baseband signals, i.e. a signal representation that consists of two channels; the inphase (I) and the quadrature (Q) channel. Such signals are referred to as I/Q signals. The complete modulation information and even distortion that originates from the RF, IF or baseband domains can be analyzed in the I/Q baseband.

Importing and exporting I/Q signals is useful for various applications:



- Generating and saving I/Q signals in an RF or baseband signal generator or in external software tools to analyze them with the FSW later.  
The FSW supports various I/Q data formats for import.  
For details on formats, see the FSW I/Q Analyzer and I/Q Input user manual.
- Capturing and saving I/Q signals with the FSW to analyze them with the FSW or an external software tool later  
As opposed to storing trace data, which can be averaged or restricted to peak values, I/Q data is stored as it was captured, without further processing. Multi-channel data is not supported.  
The data is stored as complex values in 32-bit floating-point format.  
The file type is determined by the file extension. If no file extension is provided, the file type is assumed to be `.iq.tar`. For `.mat` files, Matlab® v4 is assumed.  
For a detailed description, see the FSW I/Q Analyzer and I/Q Input User Manual.

For example, you can capture I/Q data using the I/Q Analyzer application, if available, and then analyze that data later using the R&S FSW AM/FM/PM Modulation Analysis application.



An application note on converting Rohde & Schwarz I/Q data files is available from the Rohde & Schwarz website:

[1EF85: Converting R&S I/Q data files](#)

The import and export functions are available in the "Save/Recall" menu which is displayed when you select the  "Save" or  "Open" icon in the toolbar.

See the FSW I/Q Analyzer and I/Q Input User Manual.



### Export only in MSRA mode

In MSRA mode, I/Q data can only be exported to other applications; I/Q data cannot be imported to the MSRA primary or any MSRA secondary applications.

## 4.8 Analog modulation analysis in MSRA/MSRT operating mode

The R&S FSW AM/FM/PM Modulation Analysis application can also be used to analyze data in MSRA or MSRT operating mode. The main difference between the two

## Analog modulation analysis in MSRA/MSRT operating mode

modes is that in MSRA mode, an I/Q analyzer performs data acquisition, while in MSRT mode, a real-time measurement is performed to capture data.

In MSRA/MSRT operating mode, only the MSRA/MSRT primary actually captures data. The data acquisition settings for an AM/FM/PM Modulation Analysis application channel in MSRA/MSRT mode configure the **analysis interval**, not an actual data capture from the input signal.

In addition, a capture offset can be defined, i.e. an offset from the start of the captured data to the start of the analysis interval for AM/FM/PM Modulation Analysis.

The currently used analysis interval (in seconds, related to measurement start) is indicated in the window header for each result display.

### Analysis line

A frequent question when analyzing multi-standard signals is how each data channel is correlated (in time) to others. Thus, an analysis line has been introduced. The analysis line is a common time marker for all MSRA secondary applications. It can be positioned in any MSRA secondary application or the MSRA primary and is then adjusted in all other secondary applications. Thus, you can easily analyze the results at a specific time in the measurement in all secondary applications and determine correlations.

If the analysis interval of the secondary application contains the marked point in time, the line is indicated in all time-based result displays, such as time, symbol, slot or bit diagrams. By default, the analysis line is displayed. However, you can hide it from view manually. In all result displays, the "AL" label in the window title bar indicates whether the analysis line lies within the analysis interval or not:

- **orange "AL"**: the line lies within the interval
- **white "AL"**: the line lies within the interval, but is not displayed (hidden)
- **no "AL"**: the line lies outside the interval



For details on the MSRA operating mode, see the FSW MSRA User Manual. For details on the MSRT operating mode, see the FSW Real-Time Spectrum Application and MSRT Operating Mode User Manual.

## 5 Configuration

**Access:** [MODE] > "AM FM PM Analog Demod"

Analog Modulation Analysis requires a special application on the FSW.

When you activate an R&S FSW AM/FM/PM Modulation Analysis application the first time, a set of parameters is passed on from the currently active application. After initial setup, the parameters for the channel are stored upon exiting and restored upon re-entering the channel. Thus, you can switch between applications quickly and easily.

When you activate the R&S FSW AM/FM/PM Modulation Analysis application, Analog Modulation Analysis for the input signal is started automatically with the default configuration. The "AM FM PM Analog Demod" menu is displayed and provides access to the most important configuration functions.

The remote commands required to perform these tasks are described in [Chapter 11, "Remote commands for AM/FM/PM Modulation Analysis"](#), on page 144.

### Predefined settings

For commonly performed measurements, standard setup files are provided for quick and easy configuration. Simply load an existing standard settings file and, if necessary, adapt the measurement settings to your specific requirements.

For an overview of predefined standards and settings see [Chapter A, "Predefined standards and settings"](#), on page 379.

• <a href="#">Configuration overview</a> .....	37
• <a href="#">Configuration according to standards</a> .....	39
• <a href="#">Input and frontend settings</a> .....	41
• <a href="#">Trigger configuration</a> .....	51
• <a href="#">Data acquisition</a> .....	61
• <a href="#">Demodulation display</a> .....	66
• <a href="#">Demodulation</a> .....	67
• <a href="#">Output settings</a> .....	87
• <a href="#">Adjusting settings automatically</a> .....	92

### 5.1 Configuration overview



**Access:** "Meas Config" > "Overview"

Using the R&S FSW AM/FM/PM Modulation Analysis application you can perform Analog Modulation Analysis using predefined standard setting files, or independently of standards using user-defined measurement settings. Such settings can be stored for recurrent use.

Thus, configuring AM/FM/PM Modulation Analysis measurements requires one of the following tasks:

- Selecting an existing standard settings file and, if necessary, adapting the measurement settings to your specific requirements.

- Configuring the measurement settings and, if necessary, storing the settings in a file.

### "Overview" window

Throughout the channel configuration, an overview of the most important currently defined settings is provided in the "Overview".

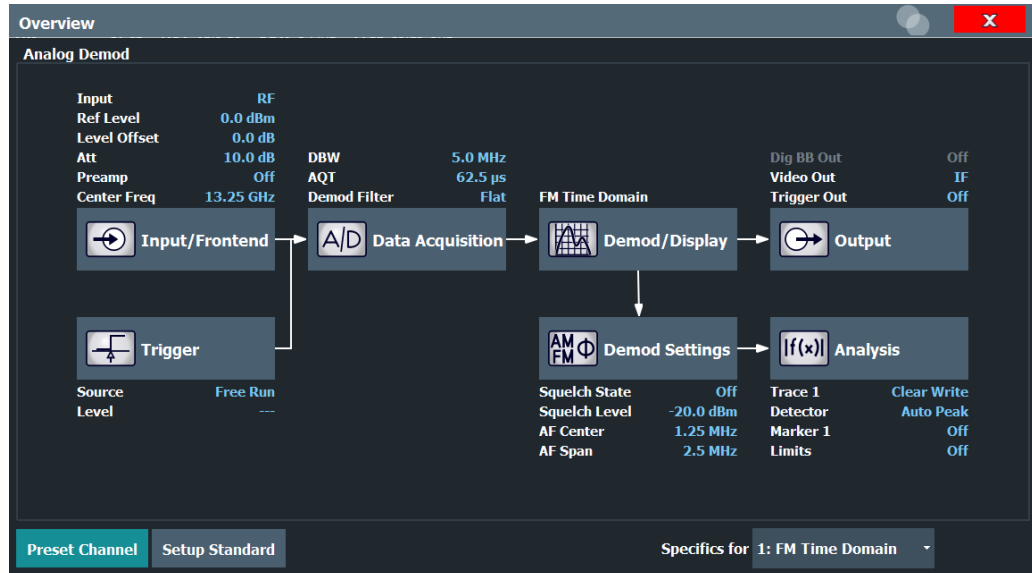

In addition to the main measurement settings, the "Overview" provides quick access to the main settings dialog boxes. The individual configuration steps are displayed in the order of the data flow. In particular, the "Overview" provides quick access to the following configuration dialog boxes (listed in the recommended order of processing):

1. Input/Frontend  
See [Chapter 5.3, "Input and frontend settings"](#), on page 41
2. Trigger  
See [Chapter 5.4, "Trigger configuration"](#), on page 51
3. Data Acquisition  
See [Chapter 5.5, "Data acquisition"](#), on page 61
4. Demod/Display  
See [Chapter 5.6, "Demodulation display"](#), on page 66
5. Demodulation Settings  
See [Chapter 5.7, "Demodulation"](#), on page 67
6. Analysis  
See [Chapter 6, "Analysis"](#), on page 96
7. (Optionally:) Outputs  
See [Chapter 5.8.1, "Output settings"](#), on page 87

**To configure settings**

- ▶ Select any button in the "Overview" to open the corresponding dialog box.  
Select a setting in the channel bar (at the top of the channel tab) to change a specific setting.

**Preset Channel**

Select "Preset Channel" in the lower left-hand corner of the "Overview" to restore all measurement settings *in the current channel* to their default values.

**Note:** Do not confuse "Preset Channel" with the [Preset] key, which restores the entire instrument to its default values and thus closes *all channels* on the FSW (except for the default channel)!

Remote command:

`SYSTem:PRESet:CHANnel [:EXEC]` on page 154

**Setup Standard**

Opens a file selection dialog box to select a predefined setup file. See "[Setup Standard](#)" on page 40.

**Specific Settings for**

The channel can contain several windows for different results. Thus, the settings indicated in the "Overview" and configured in the dialog boxes vary depending on the selected window.

Select an active window from the "Specific Settings for" selection list that is displayed in the "Overview" and in all window-specific configuration dialog boxes.

The "Overview" and dialog boxes are updated to indicate the settings for the selected window.

## 5.2 Configuration according to standards

**Access:** "Overview" > "Setup Standard"

Various predefined settings files for common standards are provided for use with the R&S FSW AM/FM/PM Modulation Analysis application. In addition, you can create your own settings files for user-specific measurements.

For details on which settings are defined and an overview of predefined standards see [Chapter A, "Predefined standards and settings"](#), on page 379.

Setup Standard.....	40
L <a href="#">Selecting Storage Location - Drive/ Path/ Files</a> .....	40
L <a href="#">File Name</a> .....	40
L <a href="#">Load Standard</a> .....	40
L <a href="#">Save Standard</a> .....	40
L <a href="#">Delete Standard</a> .....	40
L <a href="#">Restore Standard Files</a> .....	40

**Setup Standard**

Opens a file selection dialog box to select a predefined setup file. The predefined settings are configured in the R&S FSW AM/FM/PM Modulation Analysis application, which allows for quick and easy configuration for commonly performed measurements.

**Selecting Storage Location - Drive/ Path/ Files ← Setup Standard**

Select the storage location of the file on the instrument or an external drive.

The default storage location for the settings files is:

C:\R\_S\INSTR\USER\predefined\AdemodPredefined.

**Note:** Saving instrument settings in secure user mode.

In secure user mode, settings that are stored on the instrument are stored to volatile memory, which is restricted to 256 MB. Thus, a "memory limit reached" error can occur although the hard disk indicates that storage space is still available.

To store data permanently, select an external storage location such as a USB memory device.

For details, see "Protecting Data Using the Secure User Mode" in the "Data Management" section of the FSW base unit user manual.

**File Name ← Setup Standard**

Contains the name of the data file without the path or extension.

File names must be compatible with the Windows conventions for file names. In particular, they must not contain special characters such as ":", "\*", "?".

For details on the filename and location, see the "Data Management" topic in the FSW User Manual.

**Load Standard ← Setup Standard**

Loads the selected measurement settings file.

Remote command:

[SENSe:]ADEMod:PRESet[:STANdard] on page 155

**Save Standard ← Setup Standard**

Saves the current measurement settings for a specific standard as a file with the defined name.

Remote command:

[SENSe:]ADEMod:PRESet:STORe on page 156

**Delete Standard ← Setup Standard**

Deletes the selected standard. Standards predefined by Rohde & Schwarz can also be deleted. A confirmation query is displayed to avoid unintentional deletion of the standard.

**Note:** Restoring predefined standard files. The standards predefined by Rohde & Schwarz available at the time of delivery can be restored using the "Restore Standard Files" function (see "Restore Standard Files" on page 40).

**Restore Standard Files ← Setup Standard**

Restores the standards predefined by Rohde & Schwarz available at the time of delivery.



Note that this function overwrites customized standards that have the same name as predefined standards.

Remote command:

[\[SENSe:\]ADEMod:PRESet:REStore](#) on page 156

## 5.3 Input and frontend settings

**Access:** "Overview" > "Input/Frontend"

The source and characteristics of the input signal to be demodulated are configured in the "Input/Frontend Settings" dialog box.



### Amplitude settings for analog baseband input

Amplitude settings for analog baseband input are described in the FSW I/Q Analyzer and I/Q Input User Manual

- [Input source settings](#).....41
- [Amplitude settings](#).....45
- [Frequency](#)..... 50

### 5.3.1 Input source settings

**Access:** "Overview" > "Input/Frontend" > "Input Source"

The input source determines which data the FSW analyzes.

The default input source for the FSW is "Radio Frequency", i.e. the signal at the "RF Input" connector of the FSW. If no additional options are installed, this is the only available input source.



### Input from other sources

The R&S FSW AM/FM/PM Modulation Analysis application application can also process input from the following optional sources:

- I/Q Input files
- External mixer
- "Digital Baseband" interface
- "Analog Baseband" interface
- Baseband oscilloscope input
- Probes
- Power sensors

For details, see the FSW I/Q Analyzer and I/Q Input User Manual.

Since the Digital I/Q input and the Analog Baseband input use the same digital signal path, both cannot be used simultaneously. When one is activated, established connec-

tions for the other are disconnected. When the second input is deactivated, connections to the first are re-established. Reconnecting can cause a short delay in data transfer after switching the input source.

External mixers are not supported in MSRA / MSRT mode.

- [Radio frequency input](#)..... 42

### 5.3.1.1 Radio frequency input

**Access:** "Overview" > "Input/Frontend" > "Input Source" > "Radio Frequency"

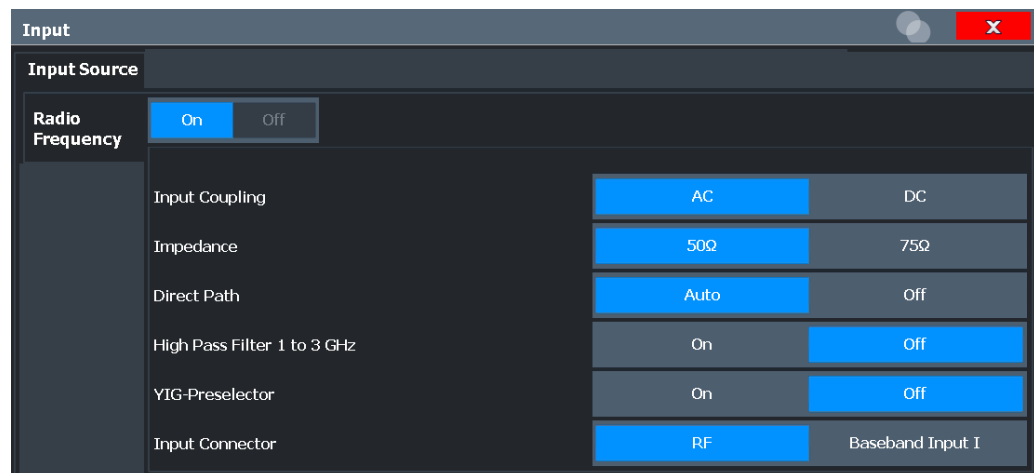

#### RF Input Protection

The RF input connector of the FSW must be protected against signal levels that exceed the ranges specified in the specifications document. Therefore, the FSW is equipped with an overload protection mechanism for DC and signal frequencies up to 30 MHz. This mechanism becomes active as soon as the power at the input mixer exceeds the specified limit. It ensures that the connection between RF input and input mixer is cut off.

When the overload protection is activated, an error message is displayed in the status bar ("INPUT OVLD"), and a message box informs you that the RF input was disconnected. Furthermore, a status bit (bit 3) in the `STAT:QUES:POW` status register is set. In this case, you must decrease the level at the RF input connector and then close the message box. Then measurement is possible again. Reactivating the RF input is also possible via the remote command `INPut:ATTenuation:PROtection:RESet`.

<a href="#">Radio Frequency State</a> .....	43
<a href="#">Input Coupling</a> .....	43
<a href="#">Impedance</a> .....	43
<a href="#">Direct Path</a> .....	43
<a href="#">High Pass Filter 1 to 3 GHz</a> .....	44
<a href="#">YIG-Preselector</a> .....	44
<a href="#">Input Connector</a> .....	44

### Radio Frequency State

Activates input from the "RF Input" connector.

For FSW85 models with two input connectors, you must define which input source is used for each measurement channel.

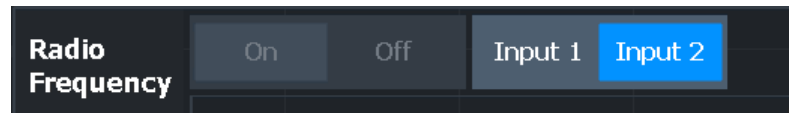

"Input 1" 1.00 mm RF input connector for frequencies up to 85 GHz (90 GHz with option R&S FSW-B90G)

"Input 2" 1.85 mm RF input connector for frequencies up to 67 GHz

Remote command:

[INPut:SElect](#) on page 159

[INPut:TYPE](#) on page 160

### Input Coupling

The RF input of the FSW can be coupled by alternating current (AC) or direct current (DC).

Not available for input from the optional "Analog Baseband" interface.

Not available for input from the optional "Digital Baseband" interface.

AC coupling blocks any DC voltage from the input signal. AC coupling is activated by default to prevent damage to the instrument. Very low frequencies in the input signal can be distorted.

However, some specifications require DC coupling. In this case, you must protect the instrument from damaging DC input voltages manually. For details, refer to the specifications document.

Remote command:

[INPut:COUPling](#) on page 157

### Impedance

For some measurements, the reference impedance for the measured levels of the FSW can be set to 50  $\Omega$  or 75  $\Omega$ .

Select 75  $\Omega$  if the 50  $\Omega$  input impedance is transformed to a higher impedance using a 75  $\Omega$  adapter of the RAZ type. (That corresponds to 25 $\Omega$  in series to the input impedance of the instrument.) The correction value in this case is 1.76 dB = 10 log (75 $\Omega$ /50 $\Omega$ ).

This value also affects the unit conversion (see "[Reference Level](#)" on page 46).

Not available for input from the optional "Digital Baseband" interface.

Not available for input from the optional "Analog Baseband" interface. For analog baseband input, an impedance of 50  $\Omega$  is always used.

Remote command:

[INPut:IMPedance](#) on page 159

### Direct Path

Enables or disables the use of the direct path for small frequencies.

In spectrum analyzers, passive analog mixers are used for the first conversion of the input signal. In such mixers, the LO signal is coupled into the IF path due to its limited isolation. The coupled LO signal becomes visible at the RF frequency 0 Hz. This effect is referred to as LO feedthrough.

To avoid the LO feedthrough the spectrum analyzer provides an alternative signal path to the A/D converter, referred to as the *direct path*. By default, the direct path is selected automatically for RF frequencies close to zero. However, this behavior can be disabled. If "Direct Path" is set to "Off", the spectrum analyzer always uses the analog mixer path.

"Auto" (Default) The direct path is used automatically for frequencies close to zero.

"Off" The analog mixer path is always used.

Remote command:

[INPut:DPATH](#) on page 158

### High Pass Filter 1 to 3 GHz

Activates an additional internal highpass filter for RF input signals from 1 GHz to 3 GHz. This filter is used to remove the harmonics of the analyzer to measure the harmonics for a DUT, for example.

This function requires an additional hardware option.

**Note:** For RF input signals outside the specified range, the high-pass filter has no effect. For signals with a frequency of approximately 4 GHz upwards, the harmonics are suppressed sufficiently by the YIG-preselector, if available.)

Remote command:

[INPut:FILTer:HPASs\[:STATe\]](#) on page 158

### YIG-Preselector

Enables or disables the YIG-preselector.

This setting requires an additional option on the FSW.

An internal YIG-preselector at the input of the FSW ensures that image frequencies are rejected. However, image rejection is only possible for a restricted bandwidth. To use the maximum bandwidth for signal analysis you can disable the YIG-preselector at the input of the FSW, which can lead to image-frequency display.

**Note:** Note that the YIG-preselector is active only on frequencies greater than 8 GHz. Therefore, switching the YIG-preselector on or off has no effect if the frequency is below that value.

To use the optional 90 GHz frequency extension (R&S FSW-B90G), the YIG-preselector must be disabled.

The YIG-"Preselector" is off by default.

Remote command:

[INPut:FILTer:YIG\[:STATe\]](#) on page 158

### Input Connector

Determines which connector the input data for the measurement is taken from.

For more information on the optional "Analog Baseband" interface, see the FSW I/Q Analyzer and I/Q Input user manual.

"RF"	(Default:) The "RF Input" connector
"RF Probe"	The "RF Input" connector with an adapter for a modular probe This setting is only available if a probe is connected to the "RF Input" connector.
"Baseband Input I"	The optional "Baseband Input I" connector This setting is only available if the optional "Analog Baseband" interface is installed and active for input. It is not available for the FSW67. For FSW85 models with two input connectors, this setting is only available for "Input 1".

Remote command:

[INPut:CONNector](#) on page 157

### 5.3.2 Amplitude settings

**Access:** "Overview" > "Input/Frontend" > "Amplitude"

Amplitude settings determine how the FSW must process or display the expected input power levels.

Configuring amplitude settings allows you to:

- Adapt the instrument hardware to the expected maximum signal level by setting the [Reference Level](#) to this maximum
- Consider an external attenuator or preamplifier (using the "Offset").
- Optimize the SNR of the measurement for low signal levels by configuring the [Reference Level](#) as high as possible without introducing compression, clipping or overload. Use early amplification by the preamplifier and a low attenuation.
- Optimize the SNR for high signal levels and ensure that the instrument hardware is not damaged, using high attenuation and AC coupling (for DC input voltage).
- Adapt the reference impedance for power results when measuring in a 75-Ohm system by connecting an external matching pad to the RF input.

Amplitude settings for input from the optional "Analog Baseband" interface are described in the FSW I/Q Analyzer and I/Q Input User Manual.

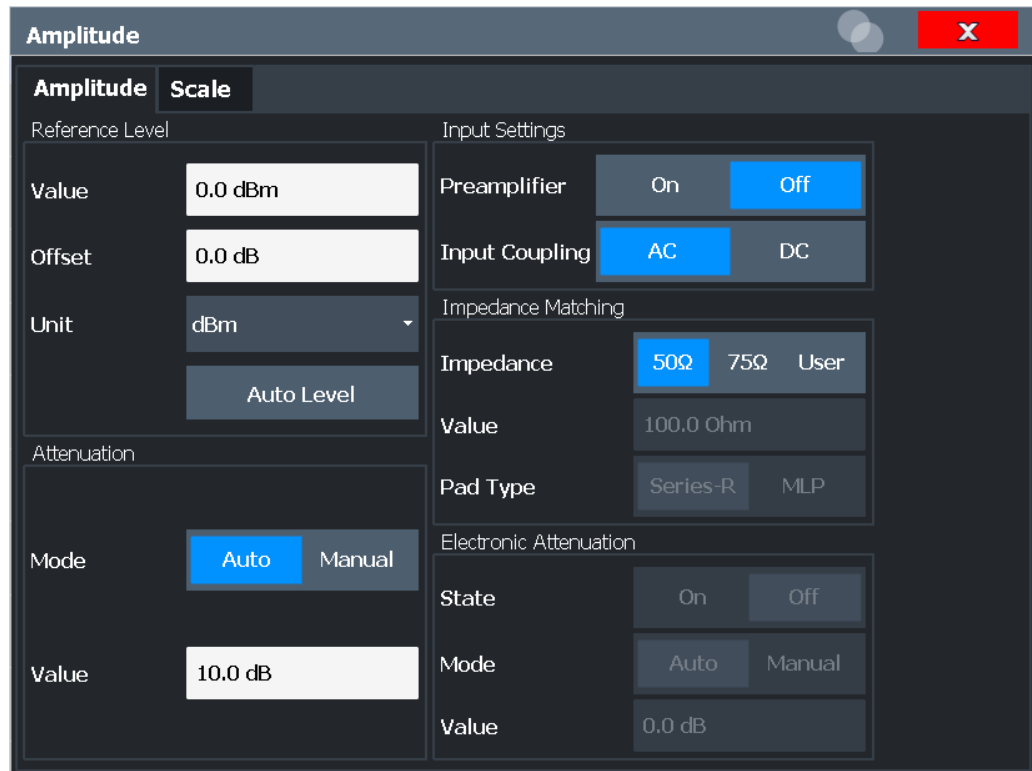

Reference Level.....	46
L Shifting the Display (Offset).....	47
L Unit.....	47
L Setting the Reference Level Automatically (Auto Level).....	47
Attenuation Mode / Value.....	48
Using Electronic Attenuation.....	48
Input Settings.....	49
L Preamplifier.....	49
L Ext. PA Correction.....	49

### Reference Level

The reference level can also be used to scale power diagrams; the reference level is then used for the calculation of the maximum on the y-axis.

Since the hardware of the FSW is adapted according to this value, it is recommended that you set the reference level close above the expected maximum signal level. Thus you ensure an optimal measurement (no compression, good signal-to-noise ratio).

Note that for input from the External Mixer (R&S FSW-B21) the maximum reference level also depends on the conversion loss; see the FSW base unit user manual for details.

Remote command:

```
DISPlay[:WINDow<n>][:SUBWindow<w>]:TRACe<t>:Y[:SCALE]:RLEVEL
```

on page 217

**Shifting the Display (Offset) ← Reference Level**

Defines an arithmetic level offset. This offset is added to the measured level. In some result displays, the scaling of the y-axis is changed accordingly.

Define an offset if the signal is attenuated or amplified before it is fed into the FSW so the application shows correct power results. All displayed power level results are shifted by this value.

The setting range is  $\pm 200$  dB in 0.01 dB steps.

Note, however, that the *internal* reference level (used to adjust the hardware settings to the expected signal) ignores any "Reference Level Offset". Thus, it is important to keep in mind the actual power level the FSW must handle. Do not rely on the displayed reference level (internal reference level = displayed reference level - offset).

Remote command:

`DISPlay[:WINDow<n>][:SUBWindow<w>]:TRACe<t>:Y[:SCALe]:RLEVel:OFFSet` on page 218

**Unit ← Reference Level**

The FSW measures the signal voltage at the RF input.

In the default state, the level is displayed at a power level of 1 mW (= dBm). Via the known input impedance (50  $\Omega$  or 75  $\Omega$ , see "[Impedance](#)" on page 43), conversion to other units is possible.

The following units are available and directly convertible:

- dBm
- dBmV
- dB $\mu$ V
- dB $\mu$ A
- dBpW
- Volt
- Ampere
- Watt

Remote command:

`INPut:IMPedance` on page 159  
`CALCulate<n>:UNIT:POWer` on page 217

**Setting the Reference Level Automatically (Auto Level) ← Reference Level**

Automatically determines a reference level which ensures that no overload occurs at the FSW for the current input data. At the same time, the internal attenuators and the preamplifier (for analog baseband input: the full-scale level) are adjusted. As a result, the signal-to-noise ratio is optimized, while signal compression and clipping are minimized.

To determine the required reference level, a level measurement is performed on the FSW.

If necessary, you can optimize the reference level further. Decrease the attenuation level manually to the lowest possible value before an overload occurs, then decrease the reference level in the same way.

When using the optional 2 GHz / 5 GHz bandwidth extension (B2000/B5000) or the optional Oscilloscope Baseband Input, the level measurement is performed on the connected oscilloscope. For B2000/B5000, y-axis scaling on the oscilloscope is limited to a minimum of 5 mV per division.

You can change the measurement time for the level measurement if necessary (see "Changing the Automatic Measurement Time (Meas Time Manual)" on page 94).

Remote command:

[SENSe:]ADJust:LEVel on page 263

### Attenuation Mode / Value

Defines the attenuation applied to the RF input of the FSW.

This function is not available for input from the optional "Digital Baseband" interface.

The RF attenuation can be set automatically as a function of the selected reference level (Auto mode). Automatic attenuation ensures that no overload occurs at the RF Input connector for the current reference level. It is the default setting.

By default and when no (optional) [electronic attenuation](#) is available, mechanical attenuation is applied.

This function is not available for input from the optional "**Digital Baseband**" interface.

In "Manual" mode, you can set the RF attenuation in 1 dB steps (down to 0 dB). Other entries are rounded to the next integer value. The range is specified in the specifications document. If the defined reference level cannot be set for the defined RF attenuation, the reference level is adjusted accordingly and the warning "limit reached" is displayed.

**NOTICE!** Risk of hardware damage due to high power levels. When decreasing the attenuation manually, ensure that the power level does not exceed the maximum level allowed at the RF input, as an overload can lead to hardware damage.

Remote command:

INPut:ATTenuation on page 218

INPut:ATTenuation:AUTO on page 219

### Using Electronic Attenuation

If the (optional) Electronic Attenuation hardware is installed on the FSW, you can also activate an electronic attenuator.

In "Auto" mode, the settings are defined automatically; in "Manual" mode, you can define the mechanical and electronic attenuation separately.

This function is not available for input from the optional "Digital Baseband" interface.

**Note:** Electronic attenuation is not available for stop frequencies (or center frequencies in zero span) above 15 GHz.

In "Auto" mode, RF attenuation is provided by the electronic attenuator as much as possible to reduce the amount of mechanical switching required. Mechanical attenuation can provide a better signal-to-noise ratio, however.

When you switch off electronic attenuation, the RF attenuation is automatically set to the same mode (auto/manual) as the electronic attenuation was set to. Thus, the RF attenuation can be set to automatic mode, and the full attenuation is provided by the mechanical attenuator, if possible.



The electronic attenuation can be varied in 1 dB steps. If the electronic attenuation is on, the mechanical attenuation can be varied in 5 dB steps. Other entries are rounded to the next lower integer value.

For the FSW85, the mechanical attenuation can be varied only in 10 dB steps.

If the defined reference level cannot be set for the given attenuation, the reference level is adjusted accordingly and the warning "limit reached" is displayed in the status bar.

Remote command:

[INPut:EATT:STATe](#) on page 220

[INPut:EATT:AUTO](#) on page 220

[INPut:EATT](#) on page 220

### Input Settings

Some input settings affect the measured amplitude of the signal, as well.

The parameters "Input Coupling" and "Impedance" are identical to those in the "Input" settings.

### Preamplifier ← Input Settings

If the (optional) internal preamplifier hardware is installed on the FSW, a preamplifier can be activated for the RF input signal.

You can use a preamplifier to analyze signals from DUTs with low output power.

**Note:** If an optional external preamplifier is activated, the internal preamplifier is automatically disabled, and vice versa.

This function is not available for input from the (optional) "Digital Baseband" interface.

For all FSW models except for FSW85, the following settings are available:

"Off"	Deactivates the preamplifier.
"15 dB"	The RF input signal is amplified by about 15 dB.
"30 dB"	The RF input signal is amplified by about 30 dB.

For FSW85 models, the input signal is amplified by 30 dB if the preamplifier is activated.

Remote command:

[INPut:GAIN:STATe](#) on page 222

[INPut:GAIN\[:VALue\]](#) on page 222

### Ext. PA Correction ← Input Settings

This function is only available if an external preamplifier is connected to the FSW, and only for frequencies above 1 GHz. For details on connection, see the preamplifier's documentation.

Using an external preamplifier, you can measure signals from devices under test with low output power, using measurement devices which feature a low sensitivity and do not have a built-in RF preamplifier.

When you connect the external preamplifier, the FSW reads out the touchdown (.S2P) file from the EEPROM of the preamplifier. This file contains the s-parameters of the preamplifier. As soon as you connect the preamplifier to the FSW, the preamplifier is permanently on and ready to use. However, you must enable data correction based on the stored data explicitly on the FSW using this setting.

When enabled, the FSW automatically compensates the magnitude and phase characteristics of the external preamplifier in the measurement results. Any internal preamplifier, if available, is disabled.

For FSW85 models with two RF inputs, you can enable correction from the external preamplifier for each input individually, but not for both at the same time.

When disabled, no compensation is performed even if an external preamplifier remains connected.

Remote command:

[INPut:EGain\[:STATe\]](#) on page 221

### 5.3.3 Frequency

**Access:** "Overview" > "Input/Frontend" > "Frequency" tab

Input			
Power Sensor	Amplitude	Frequency	Auto Settings
Frequency			
Center	3.75 GHz		
Center Frequency Stepsize			
Stepsize	0.1 * Demod BW		X-Factor
			10.0 %

<a href="#">Center Frequency</a> .....	50
<a href="#">Center Frequency Stepsize</a> .....	51

#### Center Frequency

Defines the center frequency of the signal in Hertz.

The allowed range of values for the center frequency depends on the frequency span.

$$\text{span} > 0: \text{span}_{\min}/2 \leq f_{\text{center}} \leq f_{\text{max}} - \text{span}_{\min}/2$$

$f_{\text{max}}$  and  $\text{span}_{\min}$  depend on the instrument and are specified in the specifications document.

Remote command:

[\[SENSe:\] FREQuency:CENTer](#) on page 215

**Center Frequency Stepsize**

Defines the step size of the center frequency. The step size can be coupled to the demodulation bandwidth, or you can set it to a fixed value manually.

"0.1 * Demod BW"	(default:) Sets the step size for the center frequency to 10 % of the demodulation bandwidth.
"0.5 * Demod BW"	Sets the step size for the center frequency to 50 % of the demodulation bandwidth.
"X * Demod BW"	Sets the step size for the center frequency to a manually defined factor of the demodulation bandwidth. The "X-Factor" defines the percentage of the demodulation bandwidth. Values between 1 % and 100 % in steps of 1 % are allowed. The default setting is 10 %.
"= Center"	Sets the step size to the value of the center frequency and removes the coupling of the step size to the demodulation bandwidth. The used value is indicated in the "Value" field.
"Manual"	Defines a fixed step size for the center frequency. Enter the step size in the "Value" field.

Remote command:

[\[SENSe:\] FREQuency:CENTer:STEP:LINK](#) on page 215

[\[SENSe:\] FREQuency:CENTer:STEP:LINK:FACTor](#) on page 216

[\[SENSe:\] FREQuency:CENTer:STEP](#) on page 215

## 5.4 Trigger configuration

**Access:** "Overview" > "Trigger"

Triggering means to capture the interesting part of the signal. Choosing the right trigger type and configuring all trigger settings correctly allows you to detect various incidents in your demodulated signals.

Optionally, the trigger signal used by the FSW can be output to a connected device, and an external trigger signal from a connected device can be used by the FSW.

Trigger settings are identical to the base unit, except for the available trigger sources. Gating is not available for Analog Modulation Analysis.

For background information on trigger settings, trigger output and working with external triggers, see the FSW User Manual.

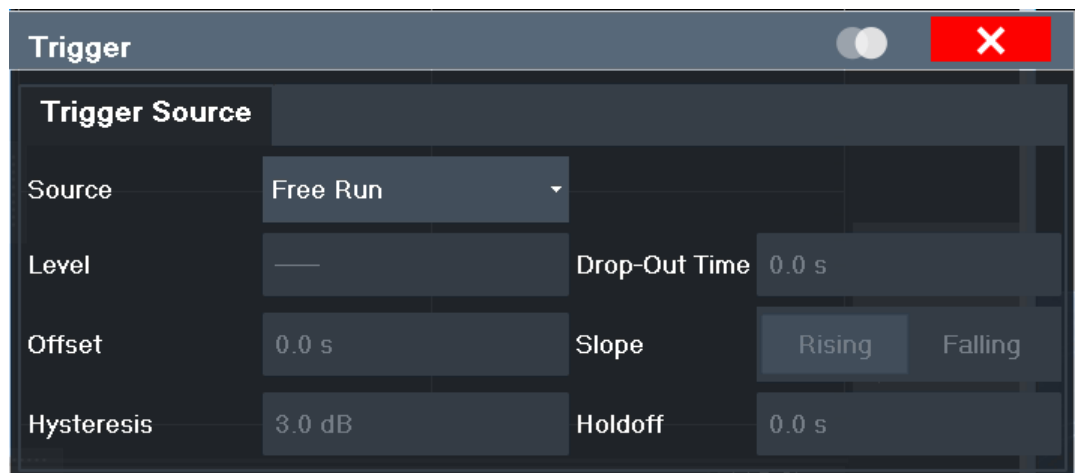

- [Trigger source settings](#).....52
- [Trigger input and output settings](#).....59

### 5.4.1 Trigger source settings

**Access:** "Overview" > "Trigger" > "Trigger Source" tab

Trigger Source.....	52
L Free Run.....	53
L External Trigger 1/2/3.....	53
L External Channel 3.....	53
L External Analog.....	54
L I/Q Power.....	54
L IF Power.....	54
L Baseband Power.....	55
L Digital I/Q.....	55
L FM (Offline) / AM (Offline) / PM (Offline) / RF (Offline).....	56
L Time.....	56
L RF Power.....	56
L Power Sensor.....	56
Trigger Level.....	56
Repetition Interval.....	57
Trigger Offset.....	57
Hysteresis.....	57
Drop-Out Time.....	58
Coupling.....	58
Slope.....	58
Trigger Holdoff.....	58

#### Trigger Source

In the R&S FSW AM/FM/PM Modulation Analysis application, the next measurement can be triggered if the selected input signal exceeds the threshold specified using the "Trigger Level" setting (see "Trigger Level" on page 56). Thus, a periodic signal modulated onto the carrier frequency can be displayed. It is recommended that the measurement time covers at least five periods of the audio signal.

Remote command:

[TRIGger \[ :SEQuence \] :SOURce](#) on page 235

### Free Run ← Trigger Source

No trigger source is considered. Data acquisition is started manually or automatically and continues until stopped explicitly.

Remote command:

TRIG:SOUR IMM, see [TRIGger \[ :SEQuence \] :SOURce](#) on page 235

### External Trigger 1/2/3 ← Trigger Source

Data acquisition starts when the TTL signal fed into the specified input connector meets or exceeds the specified trigger level.

(See "[Trigger Level](#)" on page 56).

**Note:** "External Trigger 1" automatically selects the trigger signal from the "TRIGGER 1 INPUT" connector on the front panel.

If the optional 2 GHz / 5 GHz bandwidth extension (B2000/B5000) is active, only [External Channel 3](#) is supported.

If the optional 2 GHz / 5 GHz bandwidth extension (B2000/B5000) *and the power splitter mode* is active, only "[External Analog](#)" on page 54 is supported.

If the optional Oscilloscope Baseband Input is active, only "[External Analog](#)" on page 54 is supported.

For details, see the "Instrument Tour" chapter in the FSW Getting Started manual.

"External Trigger 1"

Trigger signal from the "TRIGGER 1 INPUT" connector.

"External Trigger 2"

Trigger signal from the "TRIGGER 2 INPUT / OUTPUT" connector.

Note: Connector must be configured for "Input" in the "Output" configuration

For FSW85 models, "Trigger 2" is not available due to the second RF input connector on the front panel.

(See the FSW user manual).

"External Trigger 3"

Trigger signal from the "TRIGGER 3 INPUT / OUTPUT" connector on the rear panel.

Note: Connector must be configured for "Input" in the "Output" configuration.

(See FSW user manual).

Remote command:

TRIG:SOUR EXT, TRIG:SOUR EXT2

TRIG:SOUR EXT3

See [TRIGger \[ :SEQuence \] :SOURce](#) on page 235

### External Channel 3 ← Trigger Source

Data acquisition starts when the signal fed into the "Ch3" input connector on the oscilloscope meets or exceeds the specified trigger level.

**Note:** In previous firmware versions, the external trigger was connected to the "Ch2" input on the oscilloscope. As of firmware version FSW 2.30, the "Ch3" input on the oscilloscope must be used!

This trigger source is only available if the optional 2 GHz / 5 GHz bandwidth extension (FSW-B2000/B5000) is active (see FSW I/Q Analyzer and I/Q Input User Manual).

**Note:** Since the external trigger uses a second channel on the oscilloscope, the maximum memory size, and thus record length, available for the input channel 1 may be reduced by half. For details, see the oscilloscope's specifications document and documentation.

Remote command:

TRIG:SOUR EXT, see TRIGger[:SEquence]:SOURce on page 235

#### External Analog ← Trigger Source

Data acquisition starts when the signal fed into the EXT TRIGGER INPUT connector on the oscilloscope meets or exceeds the specified trigger level.

For details, see the FSW I/Q Analyzer and I/Q Input User Manual.

Remote command:

TRIG:SOUR EXT, see TRIGger[:SEquence]:SOURce on page 235

#### I/Q Power ← Trigger Source

Not available for the optional "Digital Baseband" interface.

Triggers the measurement when the magnitude of the sampled I/Q data exceeds the trigger threshold.

The trigger bandwidth corresponds to the resolution bandwidth setting for data acquisition (see "Resolution Bandwidth" on page 62).

Remote command:

TRIG:SOUR IQP, see TRIGger[:SEquence]:SOURce on page 235

#### IF Power ← Trigger Source

The FSW starts capturing data as soon as the trigger level is exceeded around the third intermediate frequency.

For frequency sweeps, the third IF represents the start frequency. The trigger threshold depends on the defined trigger level, as well as on the RF attenuation and preamplification. A reference level offset, if defined, is also considered. The trigger bandwidth at the intermediate frequency depends on the RBW and sweep type. For details on available trigger levels and trigger bandwidths, see the instrument specifications document.

For measurements on a fixed frequency (e.g. zero span or I/Q measurements), the third IF represents the center frequency.

This trigger source is only available for RF input.

Available for input from the optional "Analog Baseband" interface.

Available for input from the optional "Digital Baseband" interface.

The available trigger levels depend on the RF attenuation and preamplification. A reference level offset, if defined, is also considered.

When using the optional 2 GHz / 5 GHz bandwidth extension (R&S FSW-B2000/B5000) with an IF power trigger, the IF power trigger corresponds to a "width" trigger

on the oscilloscope, with a negative polarity and the range "longer". Thus, data acquisition starts when both of the following conditions apply to the signal fed into the CH1 input connector on the oscilloscope:

- The power level has remained below the specified trigger level for a duration longer than the drop-out time.
- The power level then rises above the specified trigger level.

For details, see "Basics on the 2 GHz / 5 GHz Bandwidth Extension" in the FSW I/Q Analyzer and I/Q Input User Manual.

For details on available trigger levels and trigger bandwidths, see the specifications document.

Remote command:

TRIG:SOUR IFP, see TRIGger[:SEquence]:SOURce on page 235

### Baseband Power ← Trigger Source

Defines triggering on the baseband power for baseband input.

Available for input from the optional "Analog Baseband" interface.

Available for input from the optional "Digital Baseband" interface.

Remote command:

TRIG:SOUR BBP, see TRIGger[:SEquence]:SOURce on page 235

### Digital I/Q ← Trigger Source

For applications that process I/Q data, such as the I/Q Analyzer or optional applications, and only if the optional "Digital Baseband" interface is available:

Defines triggering of the measurement directly via the "LVDS" connector. In the selection list, specify which general-purpose bit ("GP0" to "GP5") provides the trigger data.

**Note:** If the Digital I/Q enhanced mode is used, i.e. the connected device supports transfer rates up to 200 Msps, only the general-purpose bits "GP0" and "GP1" are available as a Digital I/Q trigger source.

The following table describes the assignment of the general-purpose bits to the LVDS connector pins.

(For details on the LVDS connector, see the FSW I/Q Analyzer User Manual.)

**Table 5-1: Assignment of general-purpose bits to LVDS connector pins**

Bit	LVDS pin
GP0	SDATA4_P - Trigger1
GP1	SDATA4_P - Trigger2
GP2 *)	SDATA0_P - Reserve1
GP3 *)	SDATA4_P - Reserve2
GP4 *)	SDATA0_P - Marker1
GP5 *)	SDATA4_P - Marker2
*): not available for Digital I/Q enhanced mode	

Remote command:

TRIG:SOUR GP0, see TRIGger[:SEquence]:SOURce on page 235

**FM (Offline) / AM (Offline) / PM (Offline) / RF (Offline) ← Trigger Source**

Triggers when the demodulated input signal exceeds the trigger level.

Remote command:

TRIGger [ : SEquence ] : SOURce on page 235

**Time ← Trigger Source**

Triggers in a specified repetition interval.

See "[Repetition Interval](#)" on page 57.

Remote command:

TRIG: SOUR TIME, see TRIGger [ : SEquence ] : SOURce on page 235

**RF Power ← Trigger Source**

Defines triggering of the measurement via signals which are outside the displayed measurement range.

For this purpose, the instrument uses a level detector at the first intermediate frequency.

The resulting trigger level at the RF input depends on the RF attenuation and preamplification. For details on available trigger levels, see the instrument's specifications document.

**Note:** If the input signal contains frequencies outside of this range (e.g. for fullspan measurements), the sweep can be aborted. A message indicating the allowed input frequencies is displayed in the status bar.

A "Trigger Offset", "Trigger Polarity" and "Trigger Holdoff" (to improve the trigger stability) can be defined for the RF trigger, but no "Hysteresis".

Not available for input from the optional "Analog Baseband" interface.

Not available for input from the optional "Digital Baseband" interface.

If the trigger source "RF Power" is selected and you enable baseband input, the trigger source is automatically switched to "Free Run".

Remote command:

TRIG: SOUR RFP, see TRIGger [ : SEquence ] : SOURce on page 235

**Power Sensor ← Trigger Source**

Uses an external power sensor as a trigger source. This option is only available if a power sensor is connected and configured.

**Note:** For Rohde & Schwarz power sensors, the "Gate Mode" *Lvl* is not supported. The signal sent by these sensors merely reflects the instant the level is first exceeded, rather than a time period. However, only time periods can be used for gating in level mode. Thus, the trigger impulse from the sensors is not long enough for a fully gated measurement; the measurement cannot be completed.

Remote command:

TRIG: SOUR PSE, see TRIGger [ : SEquence ] : SOURce on page 235

**Trigger Level**

Defines the trigger level for the specified trigger source.

For details on supported trigger levels, see the instrument specifications document.



Remote command:

[TRIGger\[:SEquence\]:LEVel:IFPower](#) on page 233

[TRIGger\[:SEquence\]:LEVel:IQPower](#) on page 233

[TRIGger\[:SEquence\]:LEVel\[:EXTErnal<port>\]](#) on page 232

[TRIGger\[:SEquence\]:LEVel:RFPower](#) on page 233

For baseband input only:

[TRIGger\[:SEquence\]:LEVel:BBPower](#) on page 232

[TRIGger\[:SEquence\]:LEVel:AM:RELative](#) on page 234

[TRIGger\[:SEquence\]:LEVel:AM\[:ABSolute\]](#) on page 234

[TRIGger\[:SEquence\]:LEVel:FM](#) on page 234

[TRIGger\[:SEquence\]:LEVel:PM](#) on page 235

### Repetition Interval

Defines the repetition interval for a time trigger.

The shortest interval is 2 ms.

Set the repetition interval to the exact pulse period, burst length, frame length or other repetitive signal characteristic. If the required interval cannot be set with the available granularity, configure a multiple of the interval that can be set. Thus, the trigger remains synchronized to the signal.

Remote command:

[TRIGger\[:SEquence\]:TIME:RINTerval](#) on page 238

### Trigger Offset

Defines the time offset between the trigger event and the start of the sweep.

Offset > 0:	Start of the sweep is delayed
Offset < 0:	Sweep starts earlier (pretrigger)

For the "Time" trigger source in swept measurements, this function is not available.

Remote command:

[TRIGger\[:SEquence\]:HOLDoff\[:TIME\]](#) on page 231

### Hysteresis

Defines the distance in dB to the trigger level that the trigger source must exceed before a trigger event occurs. Setting a hysteresis avoids unwanted trigger events caused by noise oscillation around the trigger level.

This setting is only available for "IF Power" trigger sources. The range of the value is between 3 dB and 50 dB with a step width of 1 dB.

When using the optional 2 GHz / 5 GHz bandwidth extension (R&S FSW-B2000/B5000) with an IF power trigger, the hysteresis refers to the robust width trigger.

(For details see the FSW I/Q Analyzer and I/Q Input User Manual.)

Remote command:

[TRIGger\[:SEquence\]:IFPower:HYSteresis](#) on page 232

### Drop-Out Time

Defines the time that the input signal must stay below the trigger level before triggering again.

**Note:** For input from the optional "Analog Baseband" interface using the baseband power trigger (BBP), the default drop out time is set to 100 ns. This avoids unintentional trigger events (as no hysteresis can be configured in this case).

When using the optional 2 GHz / 5 GHz bandwidth extension (R&S FSW-B2000/B5000) with an IF power trigger, the drop-out time defines the width of the robust width trigger. By default it is set to 1  $\mu$ s. For external triggers, no drop-out time is available when using the B2000/B5000 option.

(For details, see the FSW I/Q Analyzer and I/Q Input User Manual.)

Remote command:

[TRIGger\[:SEquence\]:DTIME](#) on page 231

### Coupling

If the selected trigger source is "IF Power" or "External Channel 3", you can configure the coupling of the external trigger to the oscilloscope.

This setting is only available if the optional 2 GHz bandwidth extension is active.

"DC 50 $\Omega$ "      Direct connection with 50  $\Omega$  termination, passes both DC and AC components of the trigger signal.

"DC 1 M $\Omega$ "      Direct connection with 1 M $\Omega$  termination, passes both DC and AC components of the trigger signal.

"AC"              Connection through capacitor, removes unwanted DC and very low-frequency components.

Remote command:

[TRIGger\[:SEquence\]:OSCilloscope:COUpling](#) on page 182

### Slope

For all trigger sources except time, you can define whether triggering occurs when the signal rises to the trigger level or falls down to it.

When using the optional 2 GHz / 5 GHz bandwidth extension (R&S FSW-B2000/B5000) with an IF power trigger, only rising slopes can be detected.

(For details see the FSW I/Q Analyzer and I/Q Input User Manual.)

Remote command:

[TRIGger\[:SEquence\]:SLOPe](#) on page 235

### Trigger Holdoff

Defines the minimum time (in seconds) that must pass between two trigger events. Trigger events that occur during the holdoff time are ignored.

Remote command:

[TRIGger\[:SEquence\]:IFPower:HOLDoFF](#) on page 231

## 5.4.2 Trigger input and output settings

**Access:** "Overview" > "Trigger" > "Trigger In/Out" tab

Trigger 2/3.....	59
L Output Type.....	60
L Level.....	60
L Pulse Length.....	60
L Send Trigger.....	60

### Trigger 2/3

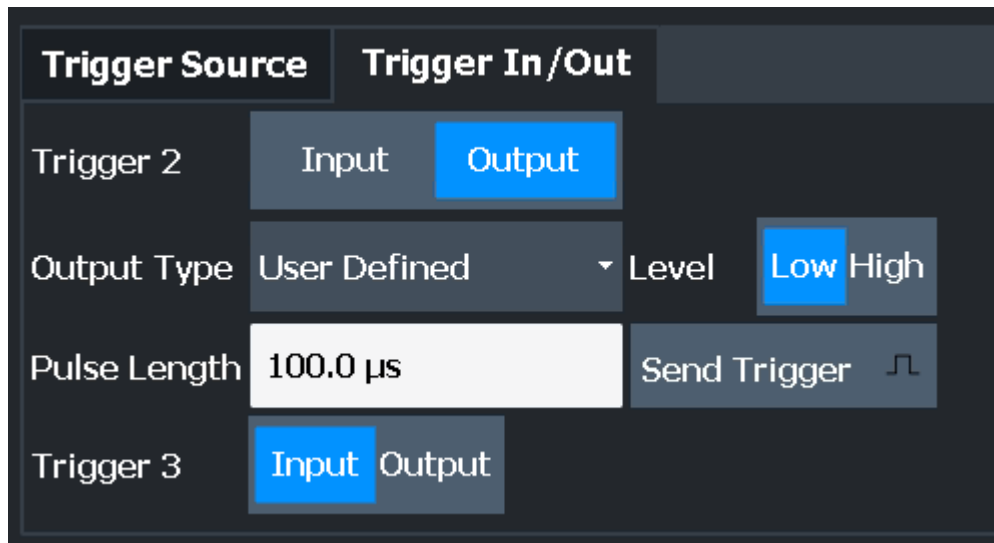

The trigger input and output functionality depends on how the variable "Trigger Input/Output" connectors are used.

**Note:** Providing trigger signals as output is described in detail in the FSW User Manual.

"Trigger 1"	"Trigger 1" is input only.
"Trigger 2"	Defines the usage of the variable "Trigger Input/Output" connector on the front panel (not available for FSW85 models with 2 RF input connectors)
"Trigger 3"	Defines the usage of the variable "Trigger 3 Input/Output" connector on the rear panel
"Input"	The signal at the connector is used as an external trigger source by the FSW. Trigger input parameters are available in the "Trigger" dialog box.
"Output"	The FSW sends a trigger signal to the output connector to be used by connected devices. Further trigger parameters are available for the connector.

**Note:** For offline AF or RF triggers, no output signal is provided.

Remote command:

`OUTPut:TRIGger<tp>:DIRection` on page 238

**Output Type ← Trigger 2/3**

Type of signal to be sent to the output

- "Device Triggered" (Default) Sends a trigger when the FSW triggers.
- "Trigger Armed" Sends a (high level) trigger when the FSW is in "Ready for trigger" state.  
This state is indicated by a status bit in the `STATUS:OPERation` register (bit 5), as well as by a low-level signal at the "AUX" port (pin 9). For details, see the description of the `STATUS:OPERation` register in the FSW User Manual and the description of the "AUX" port in the FSW Getting Started manual.
- "User Defined" Sends a trigger when you select "Send Trigger".  
In this case, further parameters are available for the output signal.

Remote command:

`OUTPut:TRIGger<tp>:OTYPe` on page 239

**Level ← Output Type ← Trigger 2/3**

Defines whether a high (1) or low (0) constant signal is sent to the trigger output connector (for "Output Type": "User Defined").

The trigger pulse level is always opposite to the constant signal level defined here. For example, for "Level" = "High", a constant high signal is output to the connector until you select the [Send Trigger](#) function. Then, a low pulse is provided.

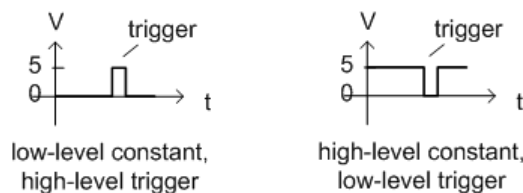

Remote command:

`OUTPut:TRIGger<tp>:LEVel` on page 239

**Pulse Length ← Output Type ← Trigger 2/3**

Defines the duration of the pulse (pulse width) sent as a trigger to the output connector.

Remote command:

`OUTPut:TRIGger<tp>:PULSe:LENGth` on page 240

**Send Trigger ← Output Type ← Trigger 2/3**

Sends a user-defined trigger to the output connector immediately.

Note that the trigger pulse level is always opposite to the constant signal level defined by the output [Level](#) setting. For example, for "Level" = "High", a constant high signal is output to the connector until you select the "Send Trigger" function. Then, a low pulse is sent.

Which pulse level is sent is indicated by a graphic on the button.

Remote command:

`OUTPut:TRIGger<tp>:PULSe:IMMediate` on page 240

## 5.5 Data acquisition

**Access:** "Overview" > "Data Acquisition"

You configure how data is acquired and then demodulated in the "Data Acquisition" dialog box.



### MSRA/MSRT operating mode

In MSRA/MSRT operating mode, only the MSRA/MSRT primary channel actually captures data from the input signal. The data acquisition settings for the R&S FSW AM/FM/PM Modulation Analysis application in MSRA/MSRT mode define the analysis interval.

For details on the MSRA operating mode, see the FSW MSRA User Manual. For details on the MSRT operating mode, see the FSW Real-Time Spectrum Application and MSRT Operating Mode User Manual.

- [Bandwidth settings](#).....61
- [Sweep settings](#).....63

### 5.5.1 Bandwidth settings

**Access:** "Overview" > "Data Acquisition" > "Bandwidth" tab

The bandwidth settings define which parts of the input signal are acquired and then demodulated.

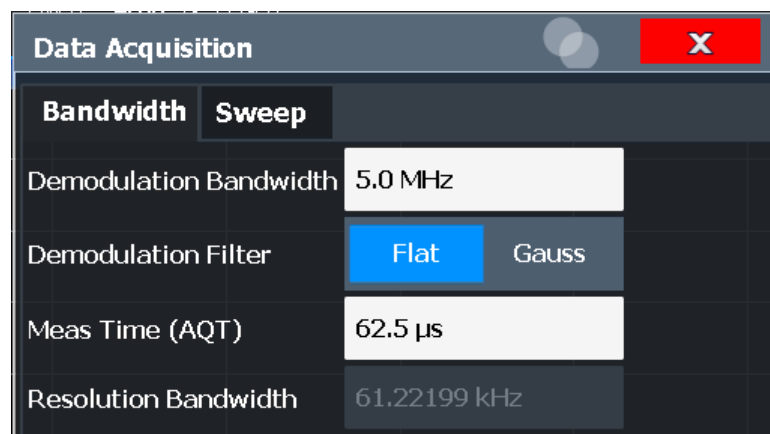

- [Demodulation Bandwidth](#)..... 61
- [Demodulation Filter](#)..... 62
- [Measurement Time \(AQT\)](#).....62
- [Capture Offset](#)..... 62
- [Resolution Bandwidth](#)..... 62

#### Demodulation Bandwidth

Defines the demodulation bandwidth of the measurement. The demodulation bandwidth determines the sample rate with which the input signal is captured and analyzed.

For recommendations on finding the correct demodulation bandwidth, see [Chapter 4.2, "Demodulation bandwidth"](#), on page 29.

For details on the relation between demodulation bandwidth and sample rate, refer to [Chapter 4.3, "Sample rate and demodulation bandwidth"](#), on page 30.

Remote command:

`[SENSe:] BWIDth:DEMod` on page 228

### Demodulation Filter

Defines the filter to be used for demodulation.

For details on sample rates, measurement times and trigger offsets for various demodulation bandwidths when using a Gaussian filter, see [Chapter 4.3, "Sample rate and demodulation bandwidth"](#), on page 30.

"Flat"                      Default

"Gauss"                    Optimizes the settling behavior of the filter

Remote command:

`[SENSe:] BWIDth:DEMod:TYPE` on page 228

### Measurement Time (AQT)

Defines how long data is acquired for demodulation.

Remote command:

`[SENSe:] ADEMod:MTIME` on page 226

### Capture Offset

This setting is only available for secondary applications in **MSRA / MSRT operating mode**. It has a similar effect as the trigger offset in other measurements: it defines the time offset between the capture buffer start and the start of the extracted secondary application data.

In MSRA mode, the offset must be a positive value, as the capture buffer starts at the trigger time = 0.

In MSRT mode, the offset can be negative if a pretrigger time is defined.

For details on the MSRA operating mode, see the FSW MSRA User Manual.

For details on the MSRT operating mode, see the FSW Real-Time Spectrum Application and MSRT Operating Mode User Manual.

Remote command:

`[SENSe:] MSRA:CAPTure:OFFSet` on page 371

MSRT mode:

`[SENSe:] RTMS:CAPTure:OFFSet` on page 373

### Resolution Bandwidth

Defines the resolution bandwidth for data acquisition. The available range is defined in the specifications document.

Remote command:

`[SENSe:] BANDwidth[:RESolution]` on page 229

## 5.5.2 Sweep settings

**Access:** "Overview" > "Data Acquisition" > "Sweep" tab

The sweep settings define how often data from the input signal is acquired and then demodulated.

The screenshot shows the 'Data Acquisition' configuration window with the 'Sweep' tab selected. The settings are as follows:

- Meas Time (AQT): 62.5 µs
- Sweep Points: 1001
- Sweep Count: 0
- Select Frame: 0
- Continue Frame: Off (highlighted in blue)
- Frame Count: 1
- Spectrogram Clear button
- Specifics for: 1: FM Time Domain

Continuous Sweep / Run Cont.....	63
Single Sweep / Run Single.....	64
Continue Single Sweep.....	64
Refresh (MSRA / MSRT only).....	65
Measurement Time (AQT).....	65
Sweep Points.....	65
Sweep/Average Count.....	65
Select Frame.....	65
Continue Frame.....	66
Frame Count.....	66
Clear Spectrogram.....	66

### Continuous Sweep / Run Cont

After triggering, starts the sweep and repeats it continuously until stopped. This is the default setting.

While the measurement is running, "Continuous Sweep" and [RUN CONT] are highlighted. The running measurement can be aborted by selecting the highlighted softkey or key again. The results are not deleted until a new measurement is started.

**Note:** Sequencer. If the Sequencer is active, "Continuous Sweep" only controls the sweep mode for the currently selected channel. However, the sweep mode only takes effect the next time the Sequencer activates that channel, and only for a channel-defined sequence. In this case, a channel in continuous sweep mode is swept repeatedly.

If the Sequencer is active in MSRT mode, the "Continuous Sweep" function does not start data capturing. It merely affects trace averaging over multiple sequences. In this case, trace averaging is performed.

Furthermore, [RUN CONT] controls the Sequencer, not individual sweeps. [RUN CONT] starts the Sequencer in continuous mode.

For details on the Sequencer, see the FSW User Manual.

Remote command:

`INITiate<n>:CONTinuous` on page 266

### Single Sweep / Run Single

After triggering, starts the number of sweeps set in "Sweep Count". The measurement stops after the defined number of sweeps has been performed.

While the measurement is running, "Single Sweep" and [RUN SINGLE] are highlighted. The running measurement can be aborted by selecting the highlighted softkey or key again.

**Note:** Sequencer. If the Sequencer is active, "Single Sweep" only controls the sweep mode for the currently selected channel. However, the sweep mode only takes effect the next time the Sequencer activates that channel, and only for a channel-defined sequence. In this case, the Sequencer sweeps a channel in single sweep mode only once.

If the Sequencer is active in MSRT mode, the "Single Sweep" function does not start data capturing. It merely affects trace averaging over multiple sequences. In this case, no trace averaging is performed.

Furthermore, [RUN SINGLE] controls the Sequencer, not individual sweeps. [RUN SINGLE] starts the Sequencer in single mode.

If the Sequencer is off, only the evaluation for the currently displayed channel is updated.

For details on the Sequencer, see the FSW User Manual.

Remote command:

`INITiate<n>[:IMMEDIATE]` on page 266

### Continue Single Sweep

After triggering, repeats the number of sweeps set in "Sweep Count", without deleting the trace of the last measurement.

While the measurement is running, "Continue Single Sweep" and [RUN SINGLE] are highlighted. The running measurement can be aborted by selecting the highlighted softkey or key again.

Remote command:

`INITiate<n>:CONMeas` on page 265



**Refresh (MSRA / MSRT only)**

This function is only available if the Sequencer is deactivated and only for **MSRA / MSRT secondary applications**.

The data in the capture buffer is re-evaluated by the currently active secondary application only. The results for any other secondary applications remain unchanged.

This is useful, for example, after evaluation changes have been made or if a new sweep was performed from another secondary application. In this case, only that secondary application is updated automatically after data acquisition.

**Note:** To update all active secondary applications at once, use the "Refresh All" function in the "Sequencer" menu.

Remote command:

`INITiate<n>:REFresh` on page 267

**Measurement Time (AQT)**

Defines how long data is acquired for demodulation.

Remote command:

`[SENSe:]ADEMod:MTIME` on page 226

**Sweep Points**

Defines the number of measured values to be collected during one sweep.

All values from 101 to 100001 can be set. The default value is 1001 sweep points.

Remote command:

`[SENSe:]SWEep[:WINDow<n>]:POINTs` on page 230

**Sweep/Average Count**

Defines the number of sweeps to be performed in the single sweep mode. Values from 0 to 200000 are allowed. If the values 0 or 1 are set, one sweep is performed.

The sweep count is applied to all the traces in all diagrams.

If the trace modes "Average", "Max Hold" or "Min Hold" are set, this value also determines the number of averaging or maximum search procedures.

In continuous sweep mode, if "Sweep Count" = 0 (default), averaging is performed over 10 sweeps. For "Sweep Count" = 1, no averaging, maxhold or minhold operations are performed.

Remote command:

`[SENSe:]SWEep:COUNT` on page 229

`[SENSe:]AVERAge<n>:COUNT` on page 304

**Select Frame**

Selects a specific frame, loads the corresponding trace from the memory, and displays it in the Spectrum window.

Note that activating a marker or changing the position of the active marker automatically selects the frame that belongs to that marker.

This function is only available in single sweep mode or if the sweep is stopped, and only if a spectrogram is selected.

The most recent frame is number 0, all previous frames have a negative number.

For more details, see the FSW User Manual.

Remote command:

[CALCulate<n>:SPECTrogram:FRAMe:SElect](#) on page 294

### Continue Frame

Determines whether the results of the previous sweeps are included in the analysis of the next sweeps for trace modes "Max Hold", "Min Hold", and "Average".

This function is available in single sweep mode only.

- **On**  
When the average or peak values are determined for the new sweep, the results of the previous sweeps in the spectrogram are also considered.
- **Off**  
The average or peak values are determined from the results of the newly swept frames only.

Remote command:

[CALCulate<n>:SPECTrogram:CONTinuous](#) on page 293

### Frame Count

Determines how many frames are plotted during a single sweep (as opposed to a continuous sweep). The maximum number of possible frames depends on the history depth (see "[History Depth](#)" on page 102).

Remote command:

[CALCulate<n>:SPECTrogram:FRAMe:COUNT](#) on page 293

### Clear Spectrogram

Resets the spectrogram result display and clears the history buffer.

This function is only available if a spectrogram is selected.

Remote command:

[CALCulate<n>:SPECTrogram:CLEar\[:IMMediate\]](#) on page 292

## 5.6 Demodulation display



**Access:** "Overview" > "Demod/Display"

The demodulated signal can be displayed using various evaluation methods. All evaluation methods available for the Analog Modulation Analysis application are displayed in the evaluation bar in SmartGrid mode when you do one of the following:

Up to six evaluation methods can be displayed simultaneously in separate windows. The Analog Modulation Analysis evaluation methods are described in [Chapter 3, "Measurements and result displays"](#), on page 15.



For details on working with the SmartGrid, see the FSW Getting Started manual.

## 5.7 Demodulation

**Access:** "Overview" > "Demod Settings"

**Or:** "Meas Setup" > "Demod"

- [Basic demodulation measurement parameters \(Demod\)](#).....67
- [Demodulation spectrum](#)..... 70
- [AF filter](#).....73
- [Scaling](#)..... 77
- [Units](#)..... 81
- [Result table settings](#).....82
- [Settling time](#)..... 85

### 5.7.1 Basic demodulation measurement parameters (Demod)

**Access:** "Overview" > "Demod Settings" > "Demod"

**Or:** "Meas Setup" > "Demod" > "Demod" tab

The basic demodulation measurement parameters define how the measurement is performed.

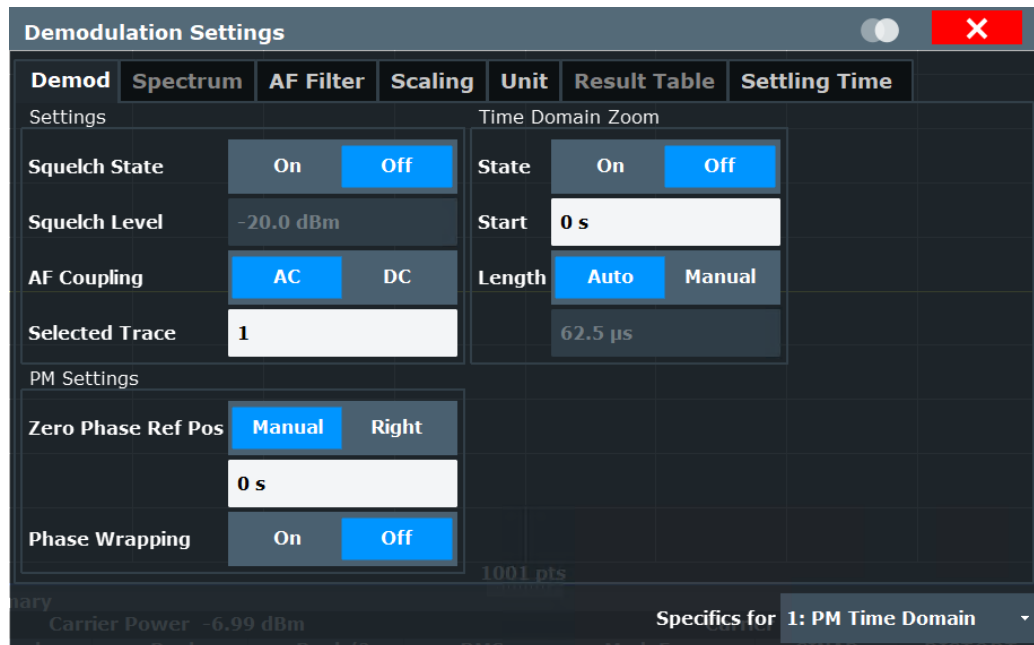

- [Squelch State](#).....68
- [Squelch Level](#).....68
- [AF Coupling](#)..... 68
- [Selected Trace](#)..... 68
- [Time Domain Zoom](#).....68
  - └ [State](#).....69
  - └ [Start](#)..... 69
  - └ [Length](#).....69

L Time per Division.....	69
Zero Phase Reference Position (PM Time Domain only).....	69
Phase Wrap On/Off (PM Time Domain only).....	70

### Squelch State

Activates the squelch function, that is: if the signal falls below a defined threshold, the demodulated data is automatically set to 0. This is useful, for example, to avoid demodulation noise during transmission breaks.

This function is only available for FM demodulation.

Remote command:

[\[SENSe:\]ADEMod:SQUelch\[:STATe\]](#) on page 242

### Squelch Level

Defines the level threshold below which the demodulated data is set to 0 if squelching is enabled. The squelch level is an absolute value.

Remote command:

[\[SENSe:\]ADEMod:SQUelch:LEVel](#) on page 243

### AF Coupling

Controls the automatic correction of the frequency offset and phase offset of the input signal:

This function is only available for FM or PM time domain evaluations.

- FM time evaluation
  - If DC is selected, the absolute frequency is displayed. That means, an input signal with an offset relative to the center frequency is not displayed symmetrically to the zero line.
  - If AC is selected, the frequency offset is automatically corrected, i.e. the trace is always symmetric to the zero line.
- PM time evaluation
  - If DC is selected, the phase runs according to the existing frequency offset. In addition, the DC signal contains a phase offset of  $\pm \pi$ .
  - If AC is selected, the frequency offset and phase offset are automatically corrected, i.e. the trace is always symmetric to the zero line.

Remote command:

[\[SENSe:\]ADEMod<n>:AF:COUPling](#) on page 241

### Selected Trace

Defines the trace used to determine the results in the "Result Summary".

### Time Domain Zoom

Using the time domain zoom, the demodulated data for a particular time span is extracted and displayed in more detail. Time domain zoom is useful if the measurement time is very large and thus each sweep point represents a large time span. The time domain zoom function distributes the available sweep points only among the time span defined by the zoom area length. The time span displayed per division of the diagram is decreased. Thus, the display of the extracted time span becomes more precise. Note that the time domain zoom area affects not only the diagram display, but the entire evaluation for the current window.

This function is only available for evaluations in the time domain.

**Tip:** In addition to the Time Domain Zoom, a graphical zoom is available for all diagram evaluations. However, the graphical zoom is useful only if more measured values than trace points are available. The (time) span represented by each measurement point remains the same.

For details see the FSW User Manual.

#### State ← Time Domain Zoom

Activates or deactivates the time domain zoom mode.

"On"	Activates the time domain zoom.
"Off"	Deactivates the time domain zoom and restores the original display. If more measured values than measurement points are available, several measured values are combined in one measurement point according to the method of the selected trace detector.

Remote command:

[\[SENSe:\]ADEMod<n>:ZOOM\[:STATe\]](#) on page 245

#### Start ← Time Domain Zoom

Defines the start time for the time domain zoom area. For spectrum evaluations, the start time is always 0.

Remote command:

[\[SENSe:\]ADEMod<n>:ZOOM:START](#) on page 245

#### Length ← Time Domain Zoom

Defines the length of the time domain zoom area. Enter the length as a time value manually, or use the "Auto" setting to set the length to the current number of sweep points automatically.

Remote command:

[\[SENSe:\]ADEMod<n>:ZOOM:LENGTH](#) on page 244

[\[SENSe:\]ADEMod<n>:ZOOM:LENGTH:MODE](#) on page 244

#### Time per Division ← Time Domain Zoom

Enables the "Time Domain Zoom" function and defines the zoom area length in one step. The width of the zoom display is divided into 10 divisions; thus, by entering the time that is displayed in each division, you indirectly define the zoom area length ("Time per Division" \* 10). The starting point of the zoom area is determined automatically. To specify the starting point manually, use the [Start](#) setting.

"Time per Division" is available from the main "AM FM PM Analog Demod" menu.

#### Zero Phase Reference Position (PM Time Domain only)

Defines the position in time at which the phase of the PM-demodulated signal is set to 0 rad.

In the default setting, the time of the first measured value is set to 0 rad. You can define a different position manually, or select the time of the last measured value (i.e. the furthest to the right in the diagram) as the reference position. The time of the last measured value corresponds to the total acquisition time, considering the trigger event and trigger offset, if applicable. If the acquisition time or the trigger values are changed, the reference position is automatically adapted.

This setting is only available for PM time domain displays with DC coupling.

Remote command:

[SENSe:]ADEMod:PM:RPoint[:X] on page 242

[SENSe:]ADEMod:PM:RPoint[:X]:MODE on page 242

### Phase Wrap On/Off (PM Time Domain only)

Activates/deactivates the phase wrap.

On	The phase is displayed in the range $\pm 180^\circ$ ( $\pm \Pi$ ). For example, if the phase exceeds $+180^\circ$ , $360^\circ$ is subtracted from the phase value, with the display thus showing $>-180^\circ$ .
Off	The phase is not wrapped.

This setting is only available for PM time domain displays with DC coupling.

Remote command:

CALC:FORM PHAS/CALC:FORM UPH, see [CALCulate<n>:FORMat](#) on page 243

## 5.7.2 Demodulation spectrum

**Access:** "Overview" > "Demod Settings" > "Spectrum"

**Or:** "Meas Setup" > "Demod" > "Spectrum" tab

The demodulation spectrum defines which span of the demodulated data is evaluated.

Depending on the evaluation (AF or RF display), the settings vary.

- [AF evaluation](#)..... 70
- [RF evaluation](#)..... 72

### 5.7.2.1 AF evaluation

**Access:** "Overview" > "Demod Settings" > "Spectrum"

**Or:** "Meas Setup" > "Demod" > "Spectrum" tab

These settings are only available for AF Spectrum evaluations, not in the time domain.

AF Center.....	71
AF Start.....	71
AF Stop.....	71
AF Span.....	71
AF Full Span.....	72

### AF Center

Defines the center frequency of the demodulated data to evaluate.

Remote command:

[\[SENSe:\]ADEMod:AF:CENTer](#) on page 246

### AF Start

Defines the start frequency of the demodulated data to evaluate.

Remote command:

[\[SENSe:\]ADEMod:AF:START](#) on page 247

### AF Stop

Defines the stop frequency of the demodulated data to evaluate.

The maximum AF stop frequency corresponds to half the demodulation bandwidth.

Remote command:

[\[SENSe:\]ADEMod:AF:STOP](#) on page 247

### AF Span

Defines the span (around the center frequency) of the demodulated data to evaluate. The maximum span is DBW/2.

Remote command:

[\[SENSe:\]ADEMod:AF:SPAN](#) on page 246

**AF Full Span**

Sets the span (around the center frequency) of the demodulated data to the maximum of DBW/2.

Remote command:

[SENSe:]ADEMod:AF:SPAN:FULL on page 246

**5.7.2.2 RF evaluation**

**Access:** "Overview" > "Demod Settings" > "Spectrum"

**Or:** "Meas Setup" > "Demod" > "Spectrum" tab

These settings are only available for RF evaluation, both in time and frequency domain. Note that for RF data the center frequency and demodulation bandwidth correspond to the settings defined in the "Input" and "Data Acquisition" configuration.

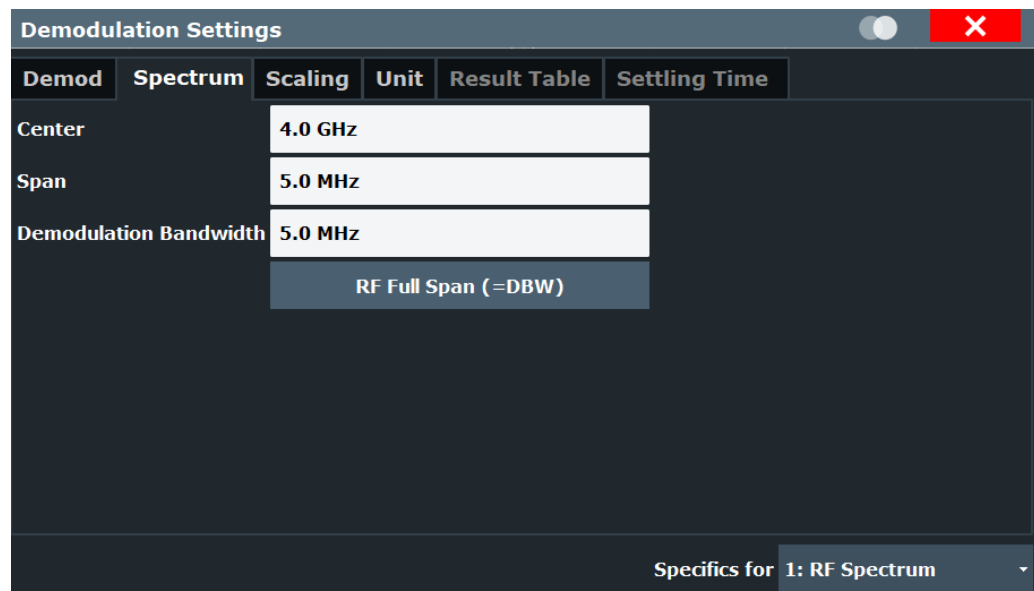

Center Frequency.....	72
Span.....	73
Demodulation Bandwidth.....	73
RF Full Span.....	73

**Center Frequency**

Defines the center frequency of the signal in Hertz.

The allowed range of values for the center frequency depends on the frequency span.

$$\text{span} > 0: \text{span}_{\min}/2 \leq f_{\text{center}} \leq f_{\text{max}} - \text{span}_{\min}/2$$

$f_{\text{max}}$  and  $\text{span}_{\min}$  depend on the instrument and are specified in the specifications document.

Remote command:

[SENSe:]FREQuency:CENTer on page 215



**Span**

Defines the frequency span. The center frequency is kept constant. The following range is allowed:

span = 0: 0 Hz

span >0:

$\text{span}_{\min} \leq f_{\text{span}} \leq f_{\max}$

and  $f_{\max} = \text{DBW}/2$

$f_{\max}$  and  $\text{span}_{\min}$  are specified in the specifications document.

Remote command:

[\[SENSe:\]ADEMod:SPECTrum:SPAN\[:MAXimum\]](#) on page 248

[\[SENSe:\]ADEMod:SPECTrum:SPAN:ZOOM](#) on page 247

**Demodulation Bandwidth**

Defines the demodulation bandwidth of the measurement. The demodulation bandwidth determines the sample rate with which the input signal is captured and analyzed.

For recommendations on finding the correct demodulation bandwidth, see [Chapter 4.2, "Demodulation bandwidth"](#), on page 29.

For details on the relation between demodulation bandwidth and sample rate, refer to [Chapter 4.3, "Sample rate and demodulation bandwidth"](#), on page 30.

Remote command:

[\[SENSe:\]BWIDth:DEMod](#) on page 228

**RF Full Span**

Sets the span (around the center frequency) of the RF data to be evaluated to the demodulation bandwidth.

Remote command:

[\[SENSe:\]ADEMod:SPECTrum:SPAN\[:MAXimum\]](#) on page 248

**5.7.3 AF filter**

**Access:** "Overview" > "Demod Settings" > "AF Filter"

**Or:** "Meas Setup" > "Demod" > "AF Filter" tab

The AF filter reduces the evaluated bandwidth of the demodulated signal and can define a weighting function.



AF filters are only available for AF evaluations, not for RF evaluation.

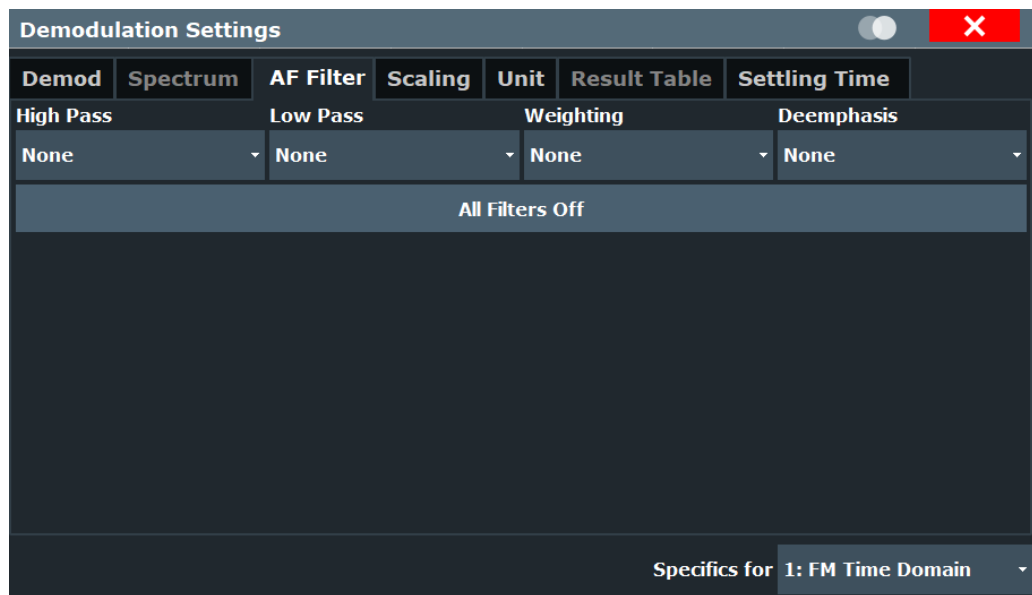

If a high pass or low pass AF filter is defined, the filter is indicated by a vertical red line in the spectrum display.

High Pass.....	74
Low Pass.....	75
Weighting.....	75
Deemphasis.....	76
Deactivating all AF Filters.....	76

### High Pass

Defines a high pass filter with the given limit to separate the DC component. The filters are indicated by the 3 dB cutoff frequency. The 50 Hz and 300 Hz filters are designed as 2nd-order Butterworth filter (12 dB/octave). The 20 Hz filter is designed as 3rd-order Butterworth filter (18 dB/octave).

The high pass filters are active in the following demodulation bandwidth range:

None	No AF Filter used (default)
20 Hz	100 Hz ≤ demodulation bandwidth ≤ 1.6 MHz
50 Hz:	200 Hz ≤ demodulation bandwidth ≤ 3 MHz
300 Hz:	800 Hz ≤ demodulation bandwidth ≤ 8 MHz
Manual:	A high pass filter with the manually defined frequency is used.

**Note:** If online demodulation output is active, the predefined (fixed) filters are not available. In this case, you must define the frequency for the high pass filter manually. (See also [Chapter 5.8.2, "Analog demod output settings"](#), on page 88).

If a filter was already configured when online demodulation output is activated, it is replaced by a manual filter that provides corresponding results, if possible.

Remote command:

[SENSe:] FILTer<n>:HPASs[:STATe] on page 251

[SENSe:] FILTer<n>:HPASs:FREQuency[:ABSolute] on page 251

[SENSe:] FILTer<n>:HPASs:FREQuency:MANual on page 251

### Low Pass

Defines a low pass filter type. Relative and absolute low pass filter are available.

- Absolute low pass filters:  
Absolute filters are indicated by the 3 dB cutoff frequency. The 3 kHz, 15 kHz and 23 kHz filters are designed as 5th-order Butterworth filters (30 dB/octave). The 150 kHz filter is designed as 8th-order Butterworth filter (48 dB/octave).  
The absolute low pass filters are active in the following demodulation bandwidth range:

Filter type	Demodulation bandwidth
3 kHz:	6.4 kHz ≤ demodulation bandwidth ≤ 3 MHz
15 kHz:	50 kHz ≤ demodulation bandwidth ≤ 8 MHz
23 kHz	50 kHz ≤ demodulation bandwidth ≤ 18 MHz
150 kHz:	400 kHz ≤ demodulation bandwidth ≤ 8 MHz
Manual:	A low pass filter with the manually defined frequency is used.

**Note:** If online demodulation output is active, the predefined (fixed) filters are not available. In this case, you must define the frequency for the low pass filter manually (see also "AC Cutoff Frequency" on page 89).

If a filter was already configured when online demodulation output is activated, it is replaced by a manual filter that provides corresponding results, if possible.

- Relative low pass filters:  
Relative filters (3 dB) can be selected in % of the demodulation bandwidth. The filters are designed as 5th-order Butterworth filter (30 dB/octave) and active for all demodulation bandwidths.
- "NONE" deactivates the AF low pass filter (default).

Remote command:

[SENSe:] FILTer<n>:LPASs[:STATe] on page 253

[SENSe:] FILTer<n>:LPASs:FREQuency[:ABSolute] on page 252

[SENSe:] FILTer<n>:LPASs:FREQuency:RELative on page 252

[SENSe:] FILTer<n>:LPASs:FREQuency:MANual on page 252

### Weighting

Selects a weighting AF filter. By default, no weighting filter is active.

- "A weighted" Switches on the A weighted filter. The weighting filter is active in the following demodulation bandwidth range:  
100 kHz ≤ demodulation bandwidth ≤ 800 kHz
- "CCITT" Switches on a CCITT P.53 weighting filter. The weighting filter is active in the following demodulation bandwidth range:  
20 kHz ≤ demodulation bandwidth ≤ 3 MHz

"CCIR weighed" Switches on the CCIR weighted filter. The weighting filter is active in the following demodulation bandwidth range:  
 $100 \text{ kHz} \leq \text{demodulation bandwidth} \leq 3.0 \text{ MHz}$

"CCIR unweighted" Switches on the CCIR unweighted filter, which is the combination of the 20 Hz highpass and 23 kHz low pass filter. The weighting filter is active in the following demodulation bandwidth range:  
 $50 \text{ kHz} \leq \text{demodulation bandwidth} \leq 1.6 \text{ MHz}$

Remote command:

[SENSe:] FILTer<n>:CCITt[:STATe] on page 250

[SENSe:] FILTer<n>:CCIR[:UNWeighted][:STATe] on page 249

[SENSe:] FILTer<n>:CCIR:WEIGhted[:STATe] on page 249

[SENSe:] FILTer<n>:AWEighteD[:STATe] on page 248

### Deemphasis

Activates a deemphasis filter with the given time constant.

Sometimes a modulated signal is extorted by a pre-emphasis filter before transmission, for example to eliminate frequencies that are more prone to interferences. In this case, the emphasis function must be reversed after demodulation, which is done by the deemphasis filter.

The deemphasis filter is active in the following demodulation bandwidth range:

25 $\mu\text{s}$ :	$25 \text{ kHz} \leq \text{demodulation bandwidth} \leq 40 \text{ MHz}$
50 $\mu\text{s}$ :	$6.4 \text{ kHz} \leq \text{demodulation bandwidth} \leq 18 \text{ MHz}$
75 $\mu\text{s}$ :	$6.4 \text{ kHz} \leq \text{demodulation bandwidth} \leq 18 \text{ MHz}$
750 $\mu\text{s}$ :	$800 \text{ Hz} \leq \text{demodulation bandwidth} \leq 3 \text{ MHz}$

Depending on the deemphasis filter, a minimum demodulation bandwidth is required for an error less than 0.5 dB, up to a maximum AF frequency. The following table shows the dependencies.

Deemphasis [us]	25 $\mu\text{s}$	50 $\mu\text{s}$	75 $\mu\text{s}$	750 $\mu\text{s}$
Max. AF frequency	25 kHz	12 kHz	8 kHz	800 Hz
Required demodulation bandwidth	$\geq 200 \text{ kHz}$	$\geq 100 \text{ kHz}$	$\geq 50 \text{ kHz}$	$\geq 6.4 \text{ kHz}$

For higher AF frequencies, you must increase the demodulation bandwidth.

Remote command:

[SENSe:] FILTer<n>:DEMPhasis[:STATe] on page 250

[SENSe:] FILTer<n>:DEMPhasis:TCONstant on page 250

### Deactivating all AF Filters

"All Filter Off" deactivates all AF filters for the selected evaluation.

Remote command:

[SENSe:] FILTer<n>:AOFF on page 249

### 5.7.4 Scaling

**Access:** "Overview" > "Demod Settings" > "Scaling"

**Or:** "Meas Setup" > "Demod" > "Scaling" tab

The scaling parameters define the range of the demodulated data to be displayed.

- [AF evaluation](#)..... 77
- [RF evaluation](#)..... 79

#### 5.7.4.1 AF evaluation

**Access:** "Overview" > "Demod Settings" > "Scaling"

**Or:** "Meas Setup" > "Demod" > "Scaling" tab

These settings are only available for AF evaluations.

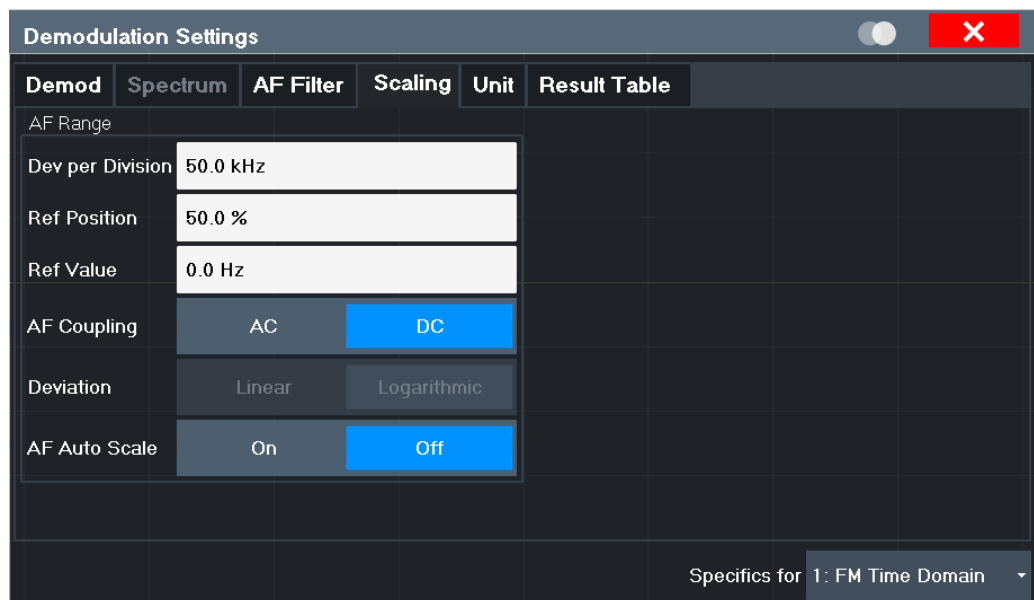

[Dev per Division/ dB per Division](#)..... 77

[Reference Value Position](#)..... 78

[Reference Value](#)..... 78

[AF Coupling](#)..... 78

[Deviation](#)..... 79

[AF Auto Scale](#)..... 79

#### Dev per Division/ dB per Division

Defines the modulation depth or the phase deviation or frequency deviation per division (logarithmic: 0.1 dB to 20 dB):

AM display:	0.0001 % to 1000 %
FM display:	10 mHz/div to 500 MHz/div
PM display:	0.0001 rad/div to 1000 rad/div

**Note:** The value defined per division refers to the default display of 10 divisions on the y-axis. If fewer divisions are displayed (e.g. because the window is reduced in height), the range per division is increased. Thus, the same result range is displayed in the smaller window. In this case, the per division value does not correspond to the actual display.

Remote command:

`DISPlay[:WINDow<n>][:SUBWindow<w>]:TRACe<t>:Y[:SCALe]:PDIVision`  
on page 224

### Reference Value Position

Determines the position of the reference value for the modulation depth or the phase deviation or frequency deviation on the y-axis of the diagram.

The position is entered as a percentage of the diagram height with 100 % corresponding to the upper diagram border. The default setting is 50 % (diagram center) for the AF time evaluations and 100 % (upper diagram border) for the AF spectrum evaluations.

Remote command:

`DISPlay[:WINDow<n>][:SUBWindow<w>]:TRACe<t>:Y[:SCALe]:RPOSition`  
on page 224

### Reference Value

Determines the modulation depth or the phase deviation or the frequency deviation at the reference line of the y-axis. The reference value can be set specifically for each evaluation.

- AF time display  
The trace display takes individual frequency/phase offsets into account (in contrast, the **AF Coupling** setting permits automatic correction by the average frequency/phase offset of the signal, and therefore cannot be activated simultaneously).
- AF spectrum display  
In the default setting, the reference value defines the modulation depth or the FM/PM deviation at the upper diagram border.

Possible values:

- AM: 0 and  $\pm 10000$  %
- FM: 0 and  $\pm 10$  MHz
- PM: 0 and  $\pm 10000$  rad

**Note:** The reference value for the AF range in the **window title bar** is displayed with respect to the defined reference *position*. The position can vary for different windows. For time domain and frequency domain windows, for example, a different reference value can be displayed, although the same reference is actually used (but the positions vary).

Remote command:

`DISPlay[:WINDow<n>][:SUBWindow<w>]:TRACe<t>:Y[:SCALe]:RVALue`  
on page 254

### AF Coupling

Controls the automatic correction of the frequency offset and phase offset of the input signal:

This function is only available for FM or PM time domain evaluations.

- FM time evaluation  
If DC is selected, the absolute frequency is displayed. That means, an input signal with an offset relative to the center frequency is not displayed symmetrically to the zero line.  
If AC is selected, the frequency offset is automatically corrected, i.e. the trace is always symmetric to the zero line.
- PM time evaluation  
If DC is selected, the phase runs according to the existing frequency offset. In addition, the DC signal contains a phase offset of  $\pm \pi$ .  
If AC is selected, the frequency offset and phase offset are automatically corrected, i.e. the trace is always symmetric to the zero line.

Remote command:

[\[SENSe:\]ADEMod<n>:AF:COUPLing](#) on page 241

### Deviation

Switches between logarithmic and linear display of the modulation depth or the phase deviation or the frequency deviation.

Remote command:

[DISPlay\[:WINDow<n>\]\[:SUBWindow<w>\]:TRACe<t>:Y:SPACing](#) on page 225

### AF Auto Scale

Activates automatic scaling of the y-axis for AF measurements. RF power and RF spectrum measurements are not affected by the auto-scaling.

Remote command:

[\[SENSe:\]ADJust:SCALE\[:Y\]:AUTO\[:CONTinuous\]](#) on page 264

#### 5.7.4.2 RF evaluation

**Access:** "Overview" > "Demod Settings" > "Scaling"

**Or:** "Meas Setup" > "Demod" > "Scaling" tab

These settings are only available for RF evaluations and the "result summary".

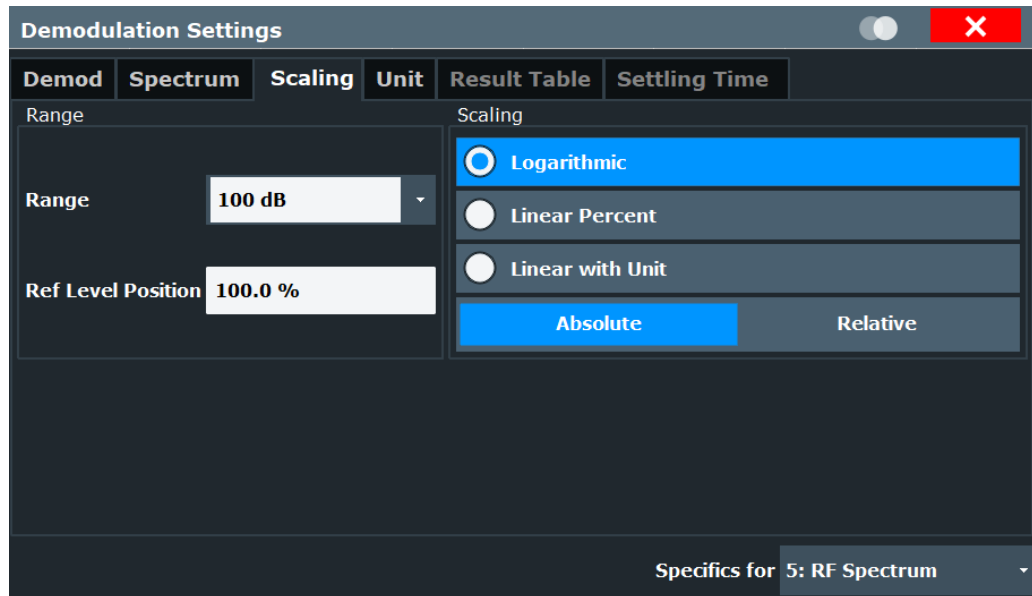

Range.....	80
Ref Level Position.....	80
Auto Scale Once.....	80
Scaling.....	81

### Range

Defines the displayed y-axis range in dB.

The default value is 100 dB.

For Analog Modulation Analysis measurements, time domain scaling is defined in Hz (default: 500 kHz).

Remote command:

`DISPlay[:WINDow<n>][:SUBWindow<w>]:TRACe<t>:Y[:SCALE]` on page 223

### Ref Level Position

Defines the reference level position, i.e. the position of the maximum AD converter value on the level axis in %.

0 % corresponds to the lower and 100 % to the upper limit of the diagram.

Values from -120 % to +280 % are available.

Larger values are useful for small scales, such as a power range of 10 dB or 20 dB, and low signal levels, for example 60 dB below the reference level. In this case, large reference level position values allow you to see the trace again.

Only available for RF measurements.

Remote command:

`DISPlay[:WINDow<n>][:SUBWindow<w>]:TRACe<t>:Y[:SCALE]:RPOsition` on page 224

### Auto Scale Once

Automatically determines the optimal range and reference level position to be displayed for the current measurement settings.



The display is only set once; it is not adapted further if the measurement settings are changed again.

Remote command:

`DISPlay[:WINDow<n>][:SUBWindow<w>]:TRACe<t>:Y[:SCALe]:AUTO ONCE`  
on page 223

### Scaling

Defines the scaling method for the y-axis.

"Logarithmic"	Logarithmic scaling (only available for logarithmic units - dB..., and A, V, Watt)
"Linear with Unit"	Linear scaling in the unit of the measured signal
"Linear Percent"	Linear scaling in percentages from 0 to 100
"Absolute"	The labeling of the level lines refers to the absolute value of the reference level (not available for "Linear Percent")
"Relative"	The scaling is in dB, relative to the reference level (only available for logarithmic units - dB...). The upper line of the grid (reference level) is always at 0 dB.

Remote command:

`DISPlay[:WINDow<n>][:SUBWindow<w>]:TRACe<t>:Y:SPACing` on page 225  
`DISPlay[:WINDow<n>][:SUBWindow<w>]:TRACe<t>:Y[:SCALe]:MODE`  
on page 223

## 5.7.5 Units

**Access:** "Overview" > "Demod Settings" > "Unit"

**Or:** "Meas Setup" > "Demod" > "Unit" tab

The units define how the demodulated data is displayed.

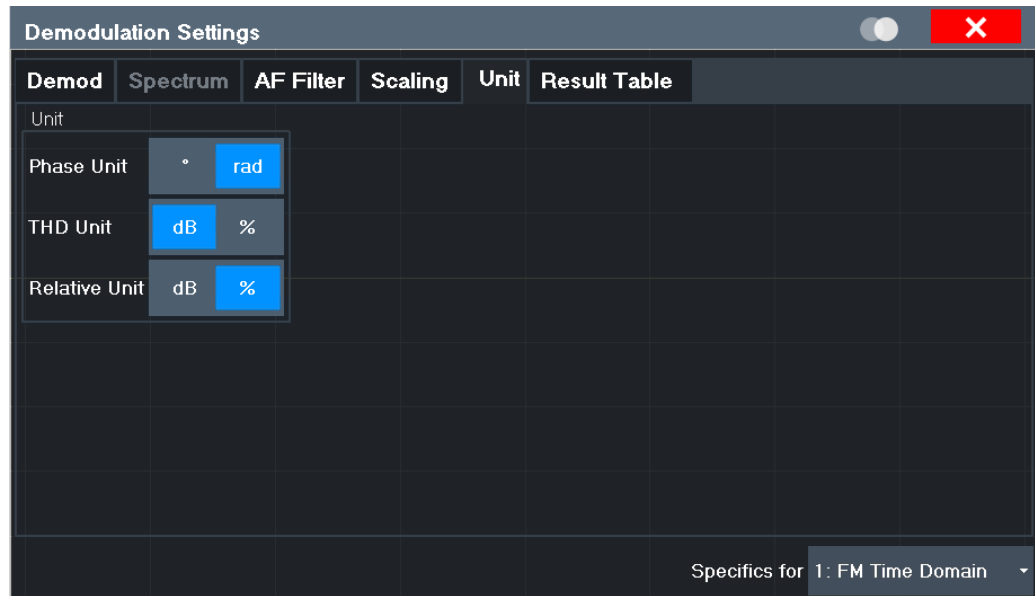

<a href="#">Phase Unit (Rad/Deg)</a> .....	82
<a href="#">THD Unit (%/ DB)</a> .....	82
<a href="#">Relative Unit</a> .....	82

#### Phase Unit (Rad/Deg)

Sets the phase unit to rad or deg for displaying PM signals.

Remote command:

`UNIT<n>:ANGLE` on page 255

#### THD Unit (%/ DB)

Sets the unit to percent or DB for the calculation of the THD (in the "Result Summary").

Remote command:

`UNIT<n>:THD` on page 255

#### Relative Unit

Defines the unit for relative demodulation results (see [Chapter 5.7.6, "Result table settings"](#), on page 82).

Remote command:

`CONFigure:ADEMod:RESults:UNIT` on page 258

### 5.7.6 Result table settings

**Access:** "Overview" > "Demod Settings" > "Result Table"

**Or:** "Meas Setup" > "Demod" > "Result Table" tab

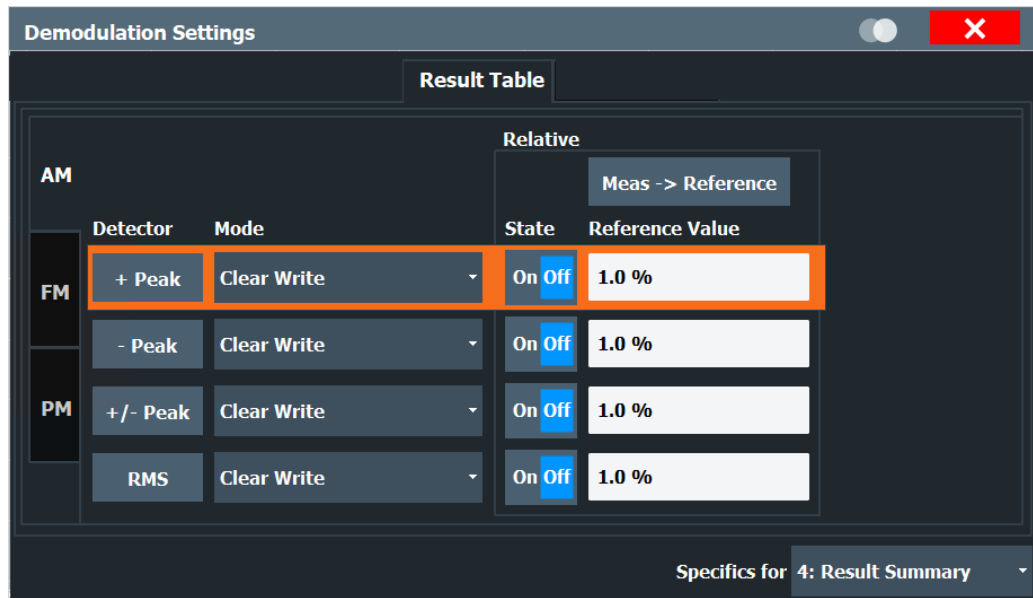

The demodulation results are displayed in the "Result Summary" table (see also "Result Summary" on page 23). The detectors used to determine the results can be configured.

In addition to common absolute demodulation, the R&S FSW AM/FM/PM Modulation Analysis application also provides demodulation results relative to user-defined or measured reference values in the "Result Summary".

The settings for the "Result Summary" can be defined individually for the different modulation types (FM, AM, PM). For each modulation type, a separate tab is provided in the dialog box.

Detector.....	83
Mode.....	83
State.....	84
Reference Value.....	84
Meas -> Reference.....	84

**Detector**

Detector type for demodulation results

- "+ Peak"      Positive peak
- "- Peak"      Negative peak
- "+/- Peak"    Autopeak
- "RMS"        Root mean square

Remote command:

The detector is specified by the DETector<det> suffix in CONFIGure:RELative:AM|FM|PM:DETector<det>... commands.

**Mode**

Defines the mode with which the demodulation result is determined.

The modes are similar to those for the entire trace (see "Trace Mode" on page 97).

- "Clear Write"      Overwrite mode: the detector value is overwritten by each sweep. This is the default setting.
- "Max Hold"        The maximum value is determined over several sweeps and displayed. The FSW saves each result only if the new value is greater than the previous one.
- "Average"         The average result is determined over all sweeps.

Remote command:

[CONFigure:ADEMod:RESults:AM:DETEctor<det>:MODE](#) on page 257

[CONFigure:ADEMod:RESults:FM:DETEctor<det>:MODE](#) on page 257

[CONFigure:ADEMod:RESults:PM:DETEctor<det>:MODE](#) on page 257

### State

Activates relative demodulation for the selected detector. If activated, the demodulated result is set in relation to the [Reference Value](#).

Remote command:

[CONFigure:ADEMod:RESults:AM:DETEctor<det>:STATE](#) on page 256

[CONFigure:ADEMod:RESults:FM:DETEctor<det>:STATE](#) on page 256

[CONFigure:ADEMod:RESults:PM:DETEctor<det>:STATE](#) on page 256

### Reference Value

Defines the reference value to be used for relative demodulation results and recalculates the results. If necessary, the detector is activated.

**Note:** A reference value 0 would provide infinite results and is thus automatically corrected to 0.1.

Remote command:

[CONFigure:ADEMod:RESults:AM:DETEctor<det>:REFerence](#) on page 256

[CONFigure:ADEMod:RESults:FM:DETEctor<det>:REFerence](#) on page 256

[CONFigure:ADEMod:RESults:PM:DETEctor<det>:REFerence](#) on page 256

### Meas -> Reference

Sets the [Reference Value](#) to be used for relative demodulation results to the currently measured value *for all relative detectors*.

**Note:** A reference value 0 would provide infinite results and is thus automatically corrected to 0.1.

If necessary, the detectors are activated.

Remote command:

[CONFigure:ADEMod:RESults:AM:DETEctor<det>:REFerence:MEAStoref<t>](#)  
on page 257

[CONFigure:ADEMod:RESults:FM:DETEctor<det>:REFerence:MEAStoref<t>](#)  
on page 257

[CONFigure:ADEMod:RESults:PM:DETEctor<det>:REFerence:MEAStoref<t>](#)  
on page 257

### 5.7.7 Settling time

**Access:** "Overview" > "Demod Settings" > "Settling Time"

**Or:** "Meas Setup" > "Demod" > "Settling Time" tab

The settling time defines when the signal remains within a specified target corridor. The corridor is defined by the upper and lower settling limit. The function is available for all time domain displays.

The screenshot shows the "Demodulation Settings" window with a toggle switch in the top right corner. Below the title bar are several tabs: "Demod", "Spectrum", "AF Filter", "Scaling", "Unit", "Result Table", and "Settling Time". The "Settling Time" tab is active. Underneath, there is a "Settings" section with three rows:

State	<input checked="" type="radio"/> On	<input type="radio"/> Off
Upper Settling Limit	10.0 rad	
Lower Settling Limit	-10.0 rad	

At the bottom right, there is a dropdown menu labeled "Specifics for" with the value "2: PM Time Domain" selected.

If enabled, the time is determined by evaluating the signal values from the end of the measurement. The last position at which the signal exceeds the corridor is the settling time. The settling time is defined with reference to the start of the data acquisition or the trigger event. A possible trigger offset is not considered.

The settling time is indicated by a temporary marker in the time domain diagram. The result is also indicated in the "result summary". The settling time is evaluated for each time domain window for the selected trace (see "[Selected Trace](#)" on page 68).

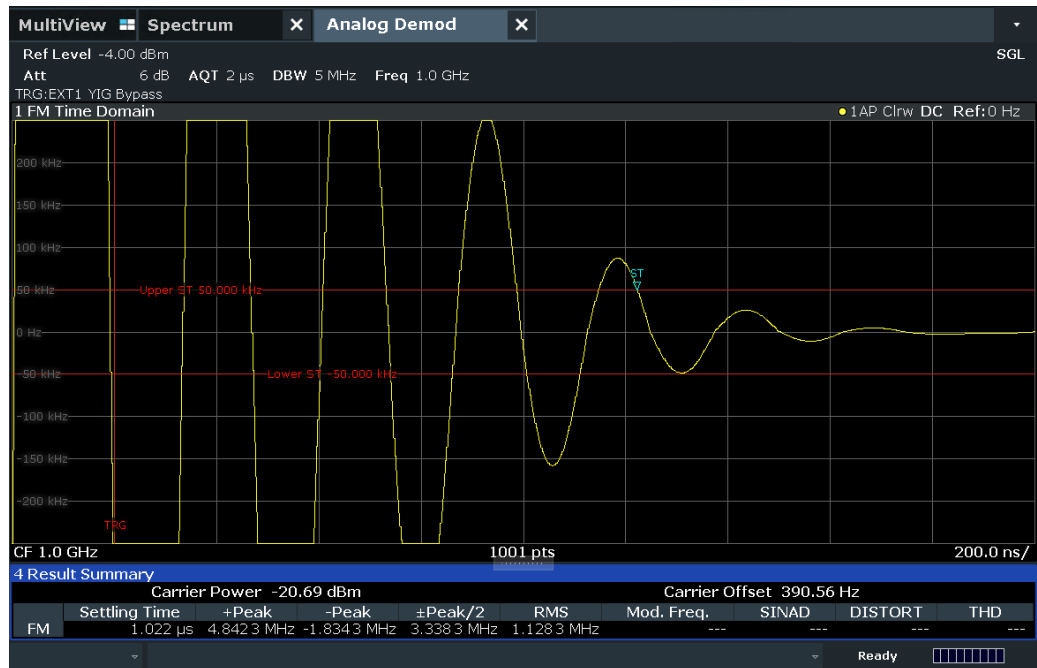

State.....86  
 Upper Settling Limit.....86  
 Lower Settling Limit.....86

**State**

Enables or disables the calculation and display of the settling time.

Remote command:

[SENSe:]ADEMod:SETTling:TIME:STATE on page 259

Result: [SENSe:]ADEMod:SETTling:TIME:RESult<t>? on page 288

**Upper Settling Limit**

Defines the upper limit of the settling time corridor. The value is defined with reference to the reference value, see also "Reference Value" on page 78 and "Zero Phase Reference Position (PM Time Domain only)" on page 69.

Remote command:

[SENSe:]ADEMod:SETTling:TIME:LIMit:UPPer on page 259

**Lower Settling Limit**

Defines the lower limit of the settling time corridor. The value is defined with reference to the reference value, see also "Reference Value" on page 78 and "Zero Phase Reference Position (PM Time Domain only)" on page 69.

Remote command:

[SENSe:]ADEMod:SETTling:TIME:LIMit:LOWer on page 258

## 5.8 Output settings

- [Output settings](#).....87
- [Analog demod output settings](#).....88
- [Digital I/Q 40G output settings](#).....90

### 5.8.1 Output settings

**Access:** [Input/Output] > "Output"

The FSW can provide output to special connectors for other devices.

For details on connectors, refer to the FSW Getting Started manual, "Front / Rear Panel View" chapters.



How to provide trigger signals as output is described in detail in the FSW User Manual. Digital I/Q output is not available for Analog Modulation Analysis.

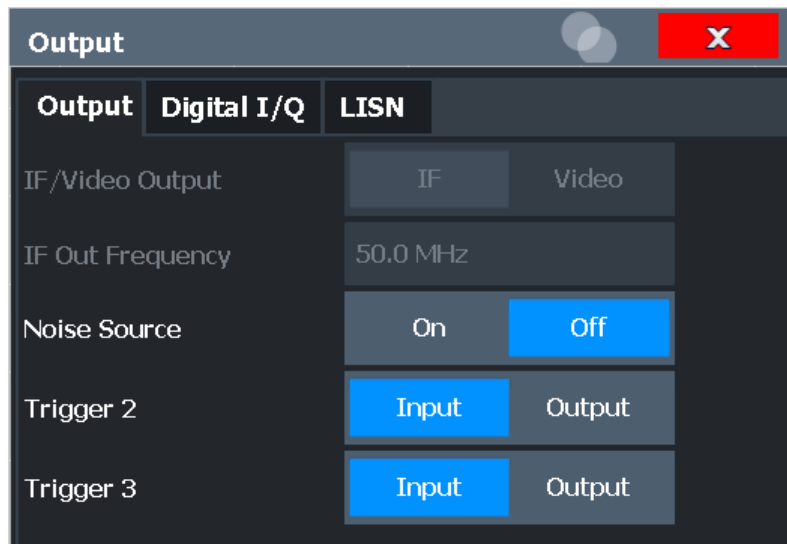

- [Noise Source Control](#).....87

#### Noise Source Control

Enables or disables the 28 V voltage supply for an external noise source connected to the "Noise source control / Power sensor") connector. By switching the supply voltage for an external noise source on or off in the firmware, you can enable or disable the device as required.

External noise sources are useful when you are measuring power levels that fall below the noise floor of the FSW itself, for example when measuring the noise level of an amplifier.

In this case, you can first connect an external noise source (whose noise power level is known in advance) to the FSW and measure the total noise power. From this value, you can determine the noise power of the FSW. Then when you measure the power level of the actual DUT, you can deduct the known noise level from the total power to obtain the power level of the DUT.

Remote command:

`DIAGnostic:SERVice:NSource` on page 211

## 5.8.2 Analog demod output settings

**Access:** "Overview" ≥ "Output" > "Analog Demod"

The demodulated signal in time domain results can be output to the IF/VIDEO/DEMODO output connector on the FSW.



Output is not possible if the optional "Digital Baseband" interface is active.

The following settings and functions are available to configure the output in the R&S FSW AM/FM/PM Modulation Analysis application.

Note that the audio frequency (AF) filter settings used for demodulation also apply to the online output. However, a maximum of two high pass, low pass or deemphasis filters can be active at the same time if "Analog Demod" output is active.

(See [Chapter 5.7.3, "AF filter"](#), on page 73)

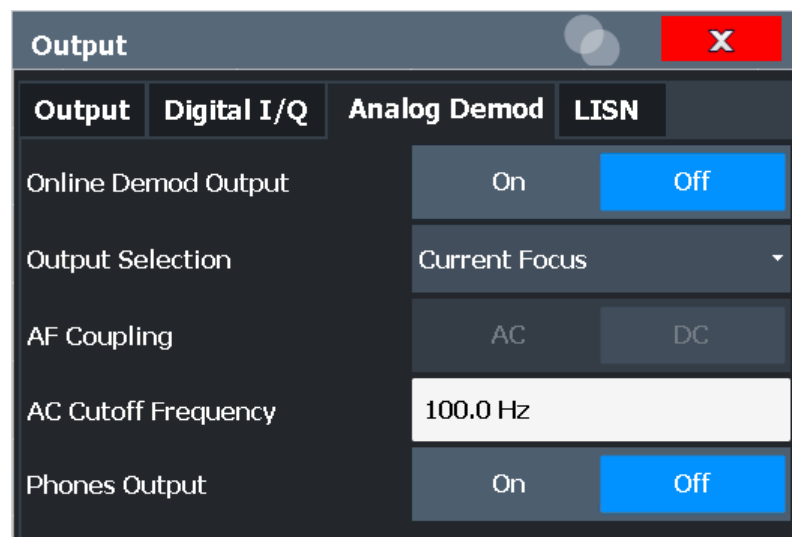

<a href="#">Online Demodulation Output State</a> .....	89
<a href="#">Output Selection</a> .....	89
<a href="#">AF Coupling</a> .....	89
<a href="#">AC Cutoff Frequency</a> .....	89
<a href="#">Phones Output</a> .....	90



**Online Demodulation Output State**

Enables or disables online demodulation output. If enabled, the demodulated audio frequencies are output to the IF/VIDEO/DEMODO output connector on the FSW.

Optionally, you can output the demodulated signal to the internal loudspeaker or the headphone connector on the FSW (see ["Phones Output"](#) on page 90).

Remote command:

[OUTPut:ADEMod\[:ONLine\] \[:STATe\]](#) on page 211

[SYSTem:SPEaker:VOLume](#) on page 213

**Output Selection**

Selects the result display whose results are output. Only time domain results can be selected. All currently active time domain result displays are listed.

"Current Focus" dynamically switches to the currently selected window. Thus you can easily change the output signal simply by selecting the windows in the display. If a window is selected that does not contain a time-domain result display, the selection is ignored and the previous setting is maintained.

The result display currently used for output is indicated by a "Demod Out" label in the window title bar.

Remote command:

[OUTPut:ADEMod\[:ONLine\]:SOURce](#) on page 212

**AF Coupling**

Controls the automatic correction of the frequency offset and phase offset of the input signal:

This function is only available for FM or PM time domain evaluations.

- FM time evaluation
  - If DC is selected, the absolute frequency is displayed. That means, an input signal with an offset relative to the center frequency is not displayed symmetrically to the zero line.
  - If AC is selected, the frequency offset is automatically corrected, i.e. the trace is always symmetric to the zero line.
- PM time evaluation
  - If DC is selected, the phase runs according to the existing frequency offset. In addition, the DC signal contains a phase offset of  $\pm \pi$ .
  - If AC is selected, the frequency offset and phase offset are automatically corrected, i.e. the trace is always symmetric to the zero line.

Remote command:

[\[SENSe:\]ADEMod<n>:AF:COUPling](#) on page 241

**AC Cutoff Frequency**

Defines the cutoff frequency for the AC highpass filter (for AC coupling only, see [AF Coupling](#)).

Note that the audio frequency (AF) filter settings used for demodulation also apply to the online output.

(See [Chapter 5.7.3, "AF filter"](#), on page 73)

Remote command:

`OUTPut:ADEMod[:ONLine]:AF[:CFrequency]` on page 212

### Phones Output

If enabled, the demodulated audio signal is output to the IF/VIDEO/DEMODO connector (on the rear panel of the FSW), as well as to headphones connected on the front panel ([Phones] connector), if available.

**CAUTION!** Risk of hearing damage. Before putting on the headphones, make sure that the volume setting is not too high to protect your hearing.

**Note:** If you do not hear output on the connected headphones despite having enabled both general online demodulation output (see "[Online Demodulation Output State](#)" on page 89) and the "Phones Output", adjust the volume setting using the volume control.

Remote command:

`OUTPut:ADEMod[:ONLine]:PHONes` on page 212

## 5.8.3 Digital I/Q 40G output settings

**Access:** "Overview" > "Output" > "Digital I/Q 40G" tab

The optional Digital I/Q 40G Streaming Output interface (FSW-B517/-B1017) allows you to output I/Q data to an external device at very high sample rates.

These settings are only available if one of the Digital I/Q 40G Streaming Output options is installed on the FSW.

For details see the FSW I/Q Analyzer and I/Q Input User Manual.

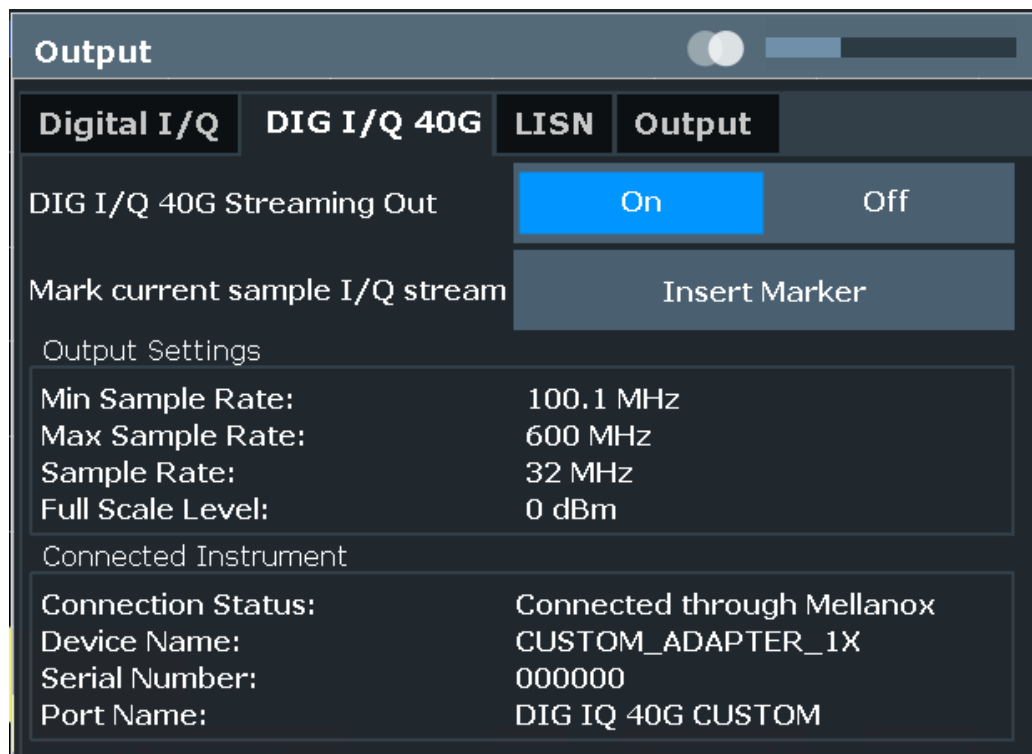

Digital I/Q 40G Streaming Out.....	91
Insert Marker.....	91
Output Settings Information.....	91
Connected Instrument.....	92

### Digital I/Q 40G Streaming Out

Enables or disables a digital output stream to the optional Digital I/Q 40G Streaming Output connector, if available.

Remote command:

[OUTPut: IQHS\[:STATe\]](#) on page 214

### Insert Marker

Inserts marker information to the data stream during a running I/Q data output recording. Useful to mark a specific event during the measurement that you detect in the result window, for example. Then you can search for the marker information in the output data to analyze the effects at that time.

Tip: The "I/Q 40G Recording" window also provides an "Insert Marker" button that remains visible throughout the measurement, without having to open a dialog box. Thus, you can insert a marker at any time during the measurement.

For more information, see the FSW I/Q Analyzer and I/Q Input User Manual.

Remote command:

[OUTPut: IQHS:MARKer](#) on page 214

### Output Settings Information

Displays information on the settings for output via the Digital I/Q 40G Streaming Output option (FSW-B517/-B1017).

The following information is displayed:

- Minimum sample rate that can be used to transfer data via the Digital I/Q 40G Streaming Output interface
- Maximum sample rate that can be used to transfer data via the Digital I/Q 40G Streaming Output interface (i.e. the maximum input sample rate that can be processed by the connected instrument)
- Sample rate currently used to transfer data via the Digital I/Q 40G Streaming Output interface
- Level and unit that corresponds to an I/Q sample with the magnitude "1" (Full scale level)

Remote command:

`OUTPut: IQHS:SRATe?` on page 214

#### Connected Instrument

Displays information on the instrument connected to the Digital I/Q 40G Streaming Output connector, if available.

If an instrument is connected, the following information is displayed:

- Name and serial number of the instrument connected to the QSFP+ connector
- Used port

Remote command:

`OUTPut: IQHS:CDEvice?` on page 214

## 5.9 Adjusting settings automatically

**Access:** [AUTO SET]

Some settings can be adjusted by the FSW automatically according to the current measurement settings. To do so, a measurement is performed. You can configure this measurement.



#### MSRA/MSRT operating mode

In MSRA and MSRT operating mode, settings related to data acquisition can only be adjusted automatically for the MSRA/MSRT primary, not the secondary applications.



### Adjusting settings automatically during triggered measurements

When you select an auto adjust function, a measurement is performed to determine the optimal settings. If you select an auto adjust function for a triggered measurement, you are asked how the FSW should behave:

- (Default:) The measurement for adjustment waits for the next trigger
- The measurement for adjustment is performed without waiting for a trigger. The trigger source is temporarily set to "Free Run". After the measurement is completed, the original trigger source is restored. The trigger level is adjusted as follows for "IF Power" and "RF Power" triggers:  
Trigger level = Reference level - 15 dB

#### Remote command:

[SENSe:]ADJust:CONFigure:TRIGger on page 263

Adjusting all Determinable Settings Automatically (Auto All).....	93
Adjusting the Center Frequency Automatically (Auto Frequency).....	93
AF Auto Scale.....	93
Setting the Reference Level Automatically (Auto Level).....	94
Resetting the Automatic Measurement Time (Meas Time Auto).....	94
Changing the Automatic Measurement Time (Meas Time Manual).....	94
Upper Level Hysteresis.....	94
Lower Level Hysteresis.....	95

### Adjusting all Determinable Settings Automatically (Auto All)

Activates all automatic adjustment functions for the current measurement settings, including:

- Auto Frequency
- Auto Level
- "AF Auto Scale" on page 79

**Note:** MSRA / MSRT operating modes. In MSRA / MSRT operating mode, this function is only available for the MSRA / MSRT primary, not the secondary applications.

Remote command:

[SENSe:]ADJust:ALL on page 260

### Adjusting the Center Frequency Automatically (Auto Frequency)

The FSW adjusts the center frequency automatically.

The optimum center frequency is the frequency with the highest S/N ratio in the frequency span. As this function uses the signal counter, it is intended for use with sinusoidal signals.

This function is not available for input from the optional "Digital Baseband" interface.

Remote command:

[SENSe:]ADJust:FREQuency on page 263

### AF Auto Scale

Activates automatic scaling of the y-axis for AF measurements. RF power and RF spectrum measurements are not affected by the auto-scaling.

Remote command:

[\[SENSe:\]ADJust:SCALe\[:Y\]:AUTO\[:CONTinuous\]](#) on page 264

### Setting the Reference Level Automatically (Auto Level)

Automatically determines a reference level which ensures that no overload occurs at the FSW for the current input data. At the same time, the internal attenuators and the preamplifier (for analog baseband input: the full-scale level) are adjusted. As a result, the signal-to-noise ratio is optimized, while signal compression and clipping are minimized.

To determine the required reference level, a level measurement is performed on the FSW.

If necessary, you can optimize the reference level further. Decrease the attenuation level manually to the lowest possible value before an overload occurs, then decrease the reference level in the same way.

When using the optional 2 GHz / 5 GHz bandwidth extension (B2000/B5000) or the optional Oscilloscope Baseband Input, the level measurement is performed on the connected oscilloscope. For B2000/B5000, y-axis scaling on the oscilloscope is limited to a minimum of 5 mV per division.

You can change the measurement time for the level measurement if necessary (see ["Changing the Automatic Measurement Time \(Meas Time Manual\)"](#) on page 94).

Remote command:

[\[SENSe:\]ADJust:LEVel](#) on page 263

### Resetting the Automatic Measurement Time (Meas Time Auto)

Resets the measurement duration for automatic settings to the default value.

(Spectrum and AM/FM/PM modulation analysis application: 1 ms)

Remote command:

[\[SENSe:\]ADJust:CONFigure:LEVel:DURation:MODE](#) on page 261

### Changing the Automatic Measurement Time (Meas Time Manual)

This function allows you to change the measurement duration for automatic setting adjustments. Enter the value in seconds.

**Note:** The maximum measurement duration depends on the currently selected measurement and the installed (optional) hardware. Thus, the measurement duration actually used to determine the automatic settings can be shorter than the value you define here.

Remote command:

[\[SENSe:\]ADJust:CONFigure:LEVel:DURation:MODE](#) on page 261

[\[SENSe:\]ADJust:CONFigure:LEVel:DURation](#) on page 261

### Upper Level Hysteresis

When the reference level is adjusted automatically using the [Auto Level](#) function, the internal attenuators and the preamplifier are also adjusted. To avoid frequent adaptation due to small changes in the input signal, you can define a hysteresis. This setting defines an upper threshold that the signal must exceed (compared to the last measurement) before the reference level is adapted automatically.

Remote command:

`[SENSe:]ADJust:CONFigure:HYSTeresis:UPPer` on page 262

#### **Lower Level Hysteresis**

When the reference level is adjusted automatically using the [Auto Level](#) function, the internal attenuators and the preamplifier are also adjusted. To avoid frequent adaptation due to small changes in the input signal, you can define a hysteresis. This setting defines a lower threshold that the signal must fall below (compared to the last measurement) before the reference level is adapted automatically.

Remote command:

`[SENSe:]ADJust:CONFigure:HYSTeresis:LOWer` on page 262

## 6 Analysis

**Access:** "Overview" > "Analysis"

General result analysis settings concerning the trace, markers, lines etc. are identical to the analysis functions in the base unit except for the special marker functions.

For a description of the lines functionality, see the FSW User Manual.

The remote commands required to perform these tasks are described in [Chapter 11, "Remote commands for AM/FM/PM Modulation Analysis"](#), on page 144.

- [Trace settings](#).....96
- [Spectrogram settings](#)..... 100
- [Trace / data export configuration](#)..... 105
- [Working with markers in the R&S FSW AM/FM/PM Modulation Analysis application](#)  
..... 109
- [Analysis in MSRA/MSRT mode](#)..... 133

### 6.1 Trace settings

**Access:** "Overview" > "Analysis" > "Traces"

Or: [TRACE] > "Trace Config"

You can configure the settings for up to 6 individual traces in the same result display. Each trace is displayed in a different color, indicated in the window title bar and the trace settings.



In the R&S FSW AM/FM/PM Modulation Analysis application, when you configure the traces for a window with a specific evaluation (e.g. AM time domain), the traces in all windows with the same evaluation are configured identically.



Trace data can also be exported to an ASCII file for further analysis. For details see [Chapter 6.3, "Trace / data export configuration"](#), on page 105.



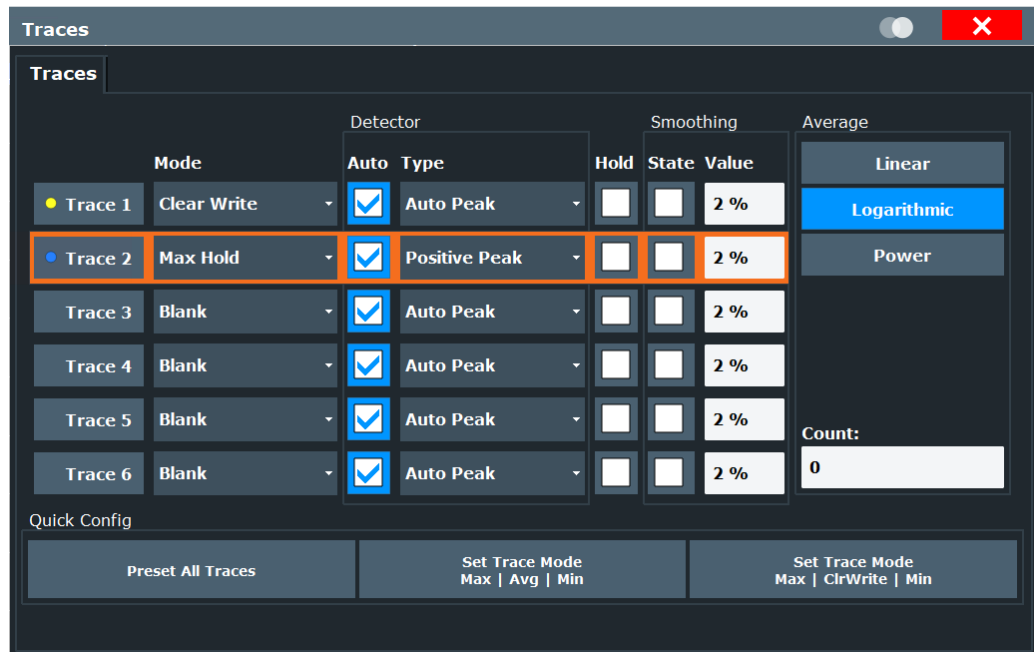

Trace 1/Trace 2/Trace 3/Trace 4/Trace 5/Trace 6.....97

Trace Mode..... 97

Detector.....98

Hold.....98

Average Mode.....99

Average Count..... 99

Predefined Trace Settings - Quick Config.....99

Trace 1/ Trace 2/ Trace 3/ Trace 4 (Softkeys)..... 100

**Trace 1/Trace 2/Trace 3/Trace 4/Trace 5/Trace 6**

Selects the corresponding trace for configuration. The currently selected trace is highlighted.

Remote command:

Selected via numeric suffix of:TRACe<1...6> commands

DISPlay[:WINDow<n>][:SUBWindow<w>]:TRACe<t>[:STATe] on page 302

**Trace Mode**

Defines the update mode for subsequent traces.

"Clear/ Write" Overwrite mode (default): the trace is overwritten by each sweep. All available detectors can be selected.

"Max Hold" The maximum value is determined over several measurements and displayed. The FSW saves the sweep result in the trace memory only if the new value is greater than the previous one. This mode is especially useful with modulated or pulsed signals. The signal spectrum is filled up upon each sweep until all signal components are detected in a kind of envelope. This mode is not available for statistics measurements.

"Min Hold"	<p>The minimum value is determined from several measurements and displayed. The FSW saves the sweep result in the trace memory only if the new value is lower than the previous one.</p> <p>This mode is useful for example for making an unmodulated carrier in a composite signal visible. Noise, interference signals or modulated signals are suppressed, whereas a CW signal is recognized by its constant level.</p> <p>This mode is not available for statistics measurements.</p>
"Average"	<p>The average is formed over several sweeps.</p> <p>The <a href="#">Sweep/Average Count</a> determines the number of averaging procedures.</p> <p>This mode is not available for statistics measurements.</p>
"View"	<p>The current contents of the trace memory are frozen and displayed.</p> <p><b>Note:</b> If a trace is frozen, you can change the measurement settings, apart from scaling settings, without impact on the displayed trace. The fact that the displayed trace no longer matches the current measurement settings is indicated by a yellow asterisk  on the tab label. If you change any parameters that affect the scaling of the diagram axes, the FSW automatically adapts the trace data to the changed display range. Thus, you can zoom into the diagram after the measurement to show details of the trace.</p>
"Blank"	Removes the selected trace from the display.

Remote command:

[DISPlay\[:WINDow<n>\]\[:SUBWindow<w>\]:TRACe<t>:MODE](#) on page 300

### Detector

Defines the trace detector to be used for trace analysis.

"Auto"	(default:) Selects the optimum detector for the selected trace and filter mode
"Type"	<p>Defines the selected detector type.</p> <p><b>Note:</b> If the EMI (R&amp;S FSW-K54) measurement option is installed, additional detectors are available, even if EMI measurement is not active. If you select a CISPR trace detector, the RBW filter type is automatically also set to CISPR.</p> <p>CISPR detectors are only available under the following conditions:</p> <ul style="list-style-type: none"> <li>• Time domain measurements and frequency measurements in sweep mode (not FFT mode, not power measurements, emission measurements, or statistics measurements)</li> </ul>

Remote command:

[\[SENSe:\] \[WINDow<n>:\] DETector<t> \[:FUNction\]](#) on page 305

[\[SENSe:\] \[WINDow<n>:\] DETector<t> \[:FUNction\]:AUTO](#) on page 305

### Hold

If activated, traces in "Min Hold", "Max Hold" and "Average" mode are not reset after specific parameter changes have been made.

Normally, the measurement is started again after parameter changes, before the measurement results are analyzed (e.g. using a marker). In all cases that require a new measurement after parameter changes, the trace is reset automatically to avoid false results (e.g. with span changes). For applications that require no reset after parameter changes, the automatic reset can be switched off.

The default setting is off.

Remote command:

`DISPlay[:WINDow<n>][:SUBWindow<w>]:TRACe<t>:MODE:HCONTinuous`  
on page 301

### Average Mode

Defines the mode with which the trace is averaged over several sweeps.

This setting is generally applicable if trace mode "Average" is selected.

For FFT sweeps, the setting also affects the VBW (regardless of whether the trace is averaged).

(See the chapter on ACLR power measurements in the FSW User Manual.)

How many sweeps are averaged is defined by the "Average Count" on page 99.

"Linear"	The power level values are converted into linear units before averaging. After the averaging, the data is converted back into its original unit.
"Logarithmic"	For logarithmic scaling, the values are averaged in dBm. For linear scaling, the behavior is the same as with linear averaging.
"Power"	Activates linear power averaging. The power level values are converted into unit Watt before averaging. After the averaging, the data is converted back into its original unit. Use this mode to average power values in Volts or Amperes correctly. In particular, for small VBW values (smaller than the RBW), use power averaging mode for correct power measurements in FFT sweep mode.

Remote command:

`[SENSe:]AVERAge<n>:TYPE` on page 304

### Average Count

Determines the number of averaging or maximum search procedures if the trace modes "Average", "Max Hold" or "Min Hold" are set.

In continuous sweep mode, if sweep count = 0 (default), averaging is performed over 10 sweeps. For sweep count = 1, no averaging, Max Hold or Min Hold operations are performed.

Remote command:

`[SENSe:]AVERAge<n>:COUNT` on page 304

### Predefined Trace Settings - Quick Config

Commonly required trace settings have been predefined and can be applied very quickly by selecting the appropriate button.

Function	Trace Settings	
Preset All Traces	Trace 1:	Clear Write
	Traces 2-6:	Blank
Set Trace Mode Max   Avg   Min	Trace 1:	Max Hold
	Trace 2:	Average
	Trace 3:	Min Hold
	Traces 4-6:	Blank
Set Trace Mode Max   ClrWrite   Min	Trace 1:	Max Hold
	Trace 2:	Clear Write
	Trace 3:	Min Hold
	Traces 4-6:	Blank

### Trace 1/ Trace 2/ Trace 3/ Trace 4 (Softkeys)

Displays the "Traces" settings and focuses the "Mode" list for the selected trace.

Remote command:

`DISPlay[:WINDow<n>] [:SUBWindow<w>]:TRACe<t>[:STATe]` on page 302

## 6.2 Spectrogram settings

**Access:** [TRACE] > "Spectrogram Config"

The individual settings available for spectrogram display are described here. For settings on color mapping, see [Chapter 6.2.2, "Color map settings"](#), on page 104.

Settings concerning the frames and how they are handled during a sweep are provided as additional sweep settings for spectrogram display.

See [Chapter 5.5, "Data acquisition"](#), on page 61.

Search functions for spectrogram markers are described in [Chapter 6.4.3, "Marker search settings for spectrograms"](#), on page 117.

- [General spectrogram settings](#)..... 100
- [Color map settings](#)..... 104

### 6.2.1 General spectrogram settings

**Access:** [TRACE] > "Spectrogram Config"

This section describes general settings for spectrogram display.

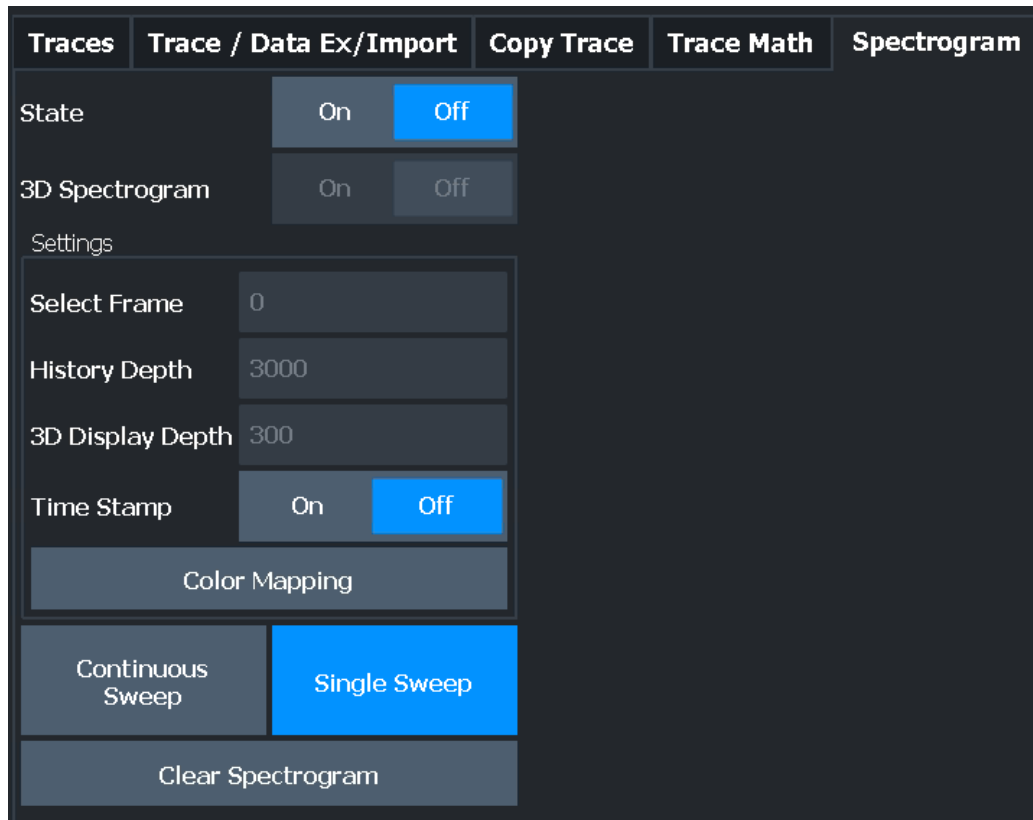

State..... 101

3D Spectrogram State..... 102

Select Frame..... 102

History Depth..... 102

3-D Display Depth..... 102

Trace..... 102

Time Stamp..... 102

Color Mapping..... 103

Continuous Sweep / Run Cont..... 103

Single Sweep / Run Single..... 103

Clear Spectrogram..... 104

**State**

Activates and deactivates a Spectrogram subwindow.

"Split"            Displays the Spectrogram as a subwindow in the original result display.

"Full"             Displays the Spectrogram in a subwindow in the full size of the original result display.

"Off"              Closes the Spectrogram subwindow.

Remote command:

[CALCulate<n>:SPECTrogram:LAYout](#) on page 294

### 3D Spectrogram State

Activates and deactivates a 3-dimensional spectrogram. As opposed to the common 2-dimensional spectrogram, the power is not only indicated by a color mapping, but also in a third dimension, the z-axis.

For details see the FSW User Manual.

Remote command:

[CALCulate<n>:SPECTrogram:THReedim\[:STATe\]](#) on page 295

### Select Frame

Selects a specific frame, loads the corresponding trace from the memory, and displays it in the Spectrum window.

Note that activating a marker or changing the position of the active marker automatically selects the frame that belongs to that marker.

This function is only available in single sweep mode or if the sweep is stopped, and only if a spectrogram is selected.

The most recent frame is number 0, all previous frames have a negative number.

For more details, see the FSW User Manual.

Remote command:

[CALCulate<n>:SPECTrogram:FRAMe:SElect](#) on page 294

### History Depth

Sets the number of frames that the FSW stores in its memory.

The maximum number of frames depends on the [Sweep Points](#).

For an overview of the maximum number of frames depending on the number of sweep points, see the FSW User Manual.

If the memory is full, the FSW deletes the oldest frames stored in the memory and replaces them with the new data.

Remote command:

[CALCulate<n>:SPECTrogram:HDEPth](#) on page 294

### 3-D Display Depth

Defines the number of frames displayed in a 3-dimensional spectrogram.

For details see the FSW User Manual.

### Trace

Selects the diagram trace on which the spectrogram is based.

Remote command:

[CALCulate<n>:SGRam:TRACe](#) on page 296

### Time Stamp

Activates and deactivates the timestamp. The timestamp shows the system time while the measurement is running. In single sweep mode or if the sweep is stopped, the timestamp shows the time and date of the end of the sweep.

When active, the timestamp replaces the display of the frame number.

Remote command:

[CALCulate<n>:SPECTrogram:TSTamp\[:STATe\]](#) on page 297

[CALCulate<n>:SPECTrogram:TSTamp:DATA?](#) on page 296

### Color Mapping

Opens the "Color Mapping" dialog.

For details see the FSW User Manual.

### Continuous Sweep / Run Cont

After triggering, starts the sweep and repeats it continuously until stopped. This is the default setting.

While the measurement is running, "Continuous Sweep" and [RUN CONT] are highlighted. The running measurement can be aborted by selecting the highlighted softkey or key again. The results are not deleted until a new measurement is started.

**Note:** Sequencer. If the Sequencer is active, "Continuous Sweep" only controls the sweep mode for the currently selected channel. However, the sweep mode only takes effect the next time the Sequencer activates that channel, and only for a channel-defined sequence. In this case, a channel in continuous sweep mode is swept repeatedly.

If the Sequencer is active in MSRT mode, the "Continuous Sweep" function does not start data capturing. It merely affects trace averaging over multiple sequences. In this case, trace averaging is performed.

Furthermore, [RUN CONT] controls the Sequencer, not individual sweeps. [RUN CONT] starts the Sequencer in continuous mode.

For details on the Sequencer, see the FSW User Manual.

Remote command:

[INITiate<n>:CONTinuous](#) on page 266

### Single Sweep / Run Single

After triggering, starts the number of sweeps set in "Sweep Count". The measurement stops after the defined number of sweeps has been performed.

While the measurement is running, "Single Sweep" and [RUN SINGLE] are highlighted. The running measurement can be aborted by selecting the highlighted softkey or key again.

**Note:** Sequencer. If the Sequencer is active, "Single Sweep" only controls the sweep mode for the currently selected channel. However, the sweep mode only takes effect the next time the Sequencer activates that channel, and only for a channel-defined sequence. In this case, the Sequencer sweeps a channel in single sweep mode only once.

If the Sequencer is active in MSRT mode, the "Single Sweep" function does not start data capturing. It merely affects trace averaging over multiple sequences. In this case, no trace averaging is performed.

Furthermore, [RUN SINGLE] controls the Sequencer, not individual sweeps. [RUN SINGLE] starts the Sequencer in single mode.

If the Sequencer is off, only the evaluation for the currently displayed channel is updated.

For details on the Sequencer, see the FSW User Manual.

Remote command:

`INITiate<n>[:IMMediate]` on page 266

### Clear Spectrogram

Resets the spectrogram result display and clears the history buffer.

This function is only available if a spectrogram is selected.

Remote command:

`CALCulate<n>:SPECTrogram:CLEar[:IMMediate]` on page 292

## 6.2.2 Color map settings

**Access:** "Overview" > "Analysis" > "Traces" > "Spectrogram" > "Color Mapping"

**or:** [TRACE] > "Spectrogram Config" > "Color Mapping"

In addition to the available color settings, the dialog box displays the current color map and provides a preview of the display with the current settings.

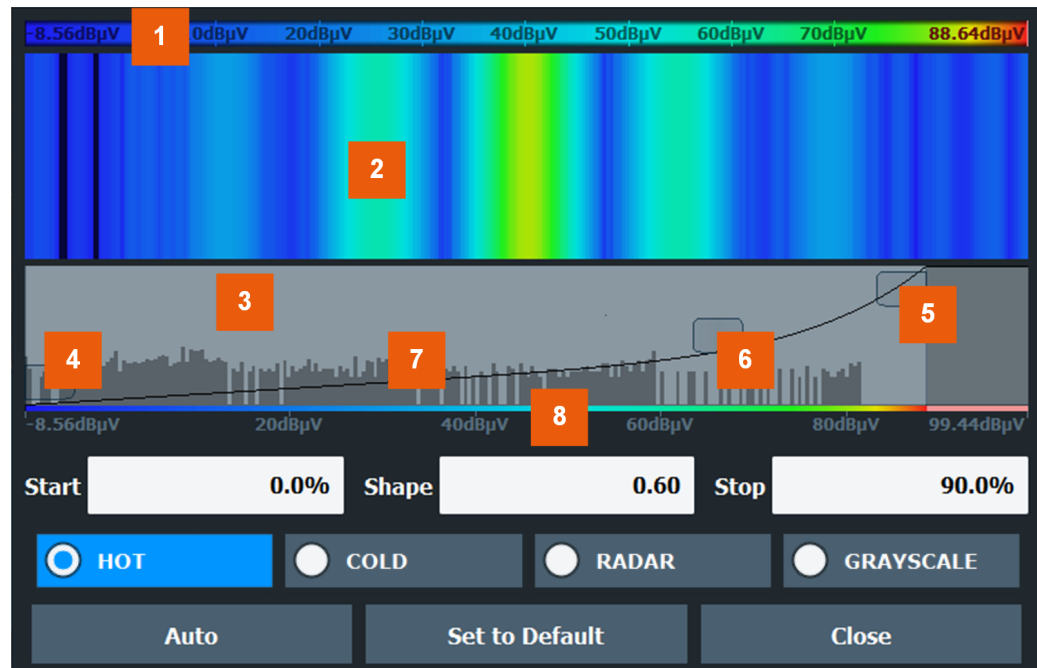

**Figure 6-1: Color Mapping dialog box**

- 1 = Color map: shows the current color distribution
- 2 = Preview pane: shows a preview of the spectrogram with any changes that you make to the color scheme
- 3 = Color curve pane: graphical representation of all settings available to customize the color scheme
- 4/5 = Color range start and stop sliders: define the range of the color map or amplitudes for the spectrogram
- 6 = Color curve slider: adjusts the focus of the color curve
- 7 = Histogram: shows the distribution of measured values
- 8 = Scale of the horizontal axis (value range)



Start / Stop.....	105
Shape.....	105
Hot/Cold/Radar/Grayscale.....	105
Auto.....	105
Set to Default.....	105
Close.....	105

**Start / Stop**

Defines the lower and upper boundaries of the value range of the spectrogram.

Remote command:

`DISPlay[:WINDow<n>]:SPECTrogram:COLor:LOWer` on page 298

`DISPlay[:WINDow<n>]:SPECTrogram:COLor:UPPer` on page 298

**Shape**

Defines the shape and focus of the color curve for the spectrogram result display.

"-1 to <0"      More colors are distributed among the lower values

"0"              Colors are distributed linearly among the values

">0 to 1"      More colors are distributed among the higher values

Remote command:

`DISPlay[:WINDow<n>]:SPECTrogram:COLor:SHApe` on page 298

**Hot/Cold/Radar/Grayscale**

Sets the color scheme for the spectrogram.

Remote command:

`DISPlay[:WINDow<n>]:SPECTrogram:COLor[:STYLE]` on page 299

**Auto**

Defines the color range automatically according to the existing measured values for optimized display.

**Set to Default**

Sets the color mapping to the default settings.

Remote command:

`DISPlay[:WINDow<n>]:SPECTrogram:COLor:DEFault` on page 297

**Close**

Saves the changes and closes the dialog box.

## 6.3 Trace / data export configuration



**Access:** "Save" > "Export" > "Export Configuration"

**Or:** [TRACE] > "Trace Config" > "Trace / Data Export"



The standard data management functions (e.g. saving or loading instrument settings) that are available for all FSW applications are not described here.

See the FSW base unit user manual for a description of the standard functions.

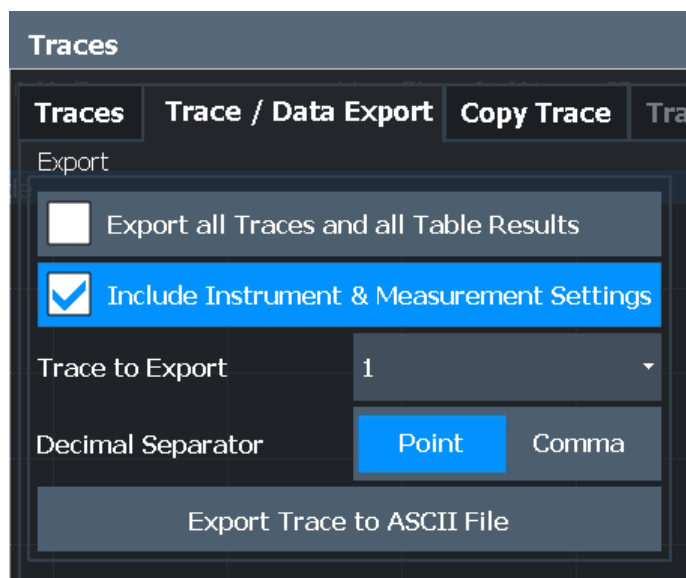

Export all Traces and all Table Results.....	106
Include Instrument & Measurement Settings.....	106
Trace to Export.....	107
Decimal Separator.....	107
Export Trace to ASCII File.....	107
L File Type.....	108
L Decimal Separator.....	108
L Column Separator.....	108
L File Explorer.....	108
Export Spectrogram to ASCII File.....	109

#### Export all Traces and all Table Results

Selects all displayed traces and result tables (e.g. "Result Summary", marker table etc.) in the current application for export to an ASCII file.

Alternatively, you can select one specific trace only for export (see [Trace to Export](#)).

The results are output in the same order as they are displayed on the screen: window by window, trace by trace, and table row by table row.

Remote command:

`FORMat:DEXPort:TRACes` on page 282

#### Include Instrument & Measurement Settings

Includes additional instrument and measurement settings in the header of the export file for result data.

See the FSW base unit user manual for details.

Remote command:

[FORMat:DEXPort:HEADer](#) on page 282

### Trace to Export

Defines an individual trace to be exported to a file.

This setting is not available if [Export all Traces and all Table Results](#) is selected.

### Decimal Separator

Defines the decimal separator for floating-point numerals for the data export/import files. Evaluation programs require different separators in different languages.

Remote command:

[FORMat:DEXPort:DSEParator](#) on page 282

### Export Trace to ASCII File

Saves the selected trace or all traces in the currently active result display to the specified file and directory in the selected ASCII format.

"File Explorer": Instead of using the file manager of the FSW firmware, you can also use the Microsoft Windows File Explorer to manage files.

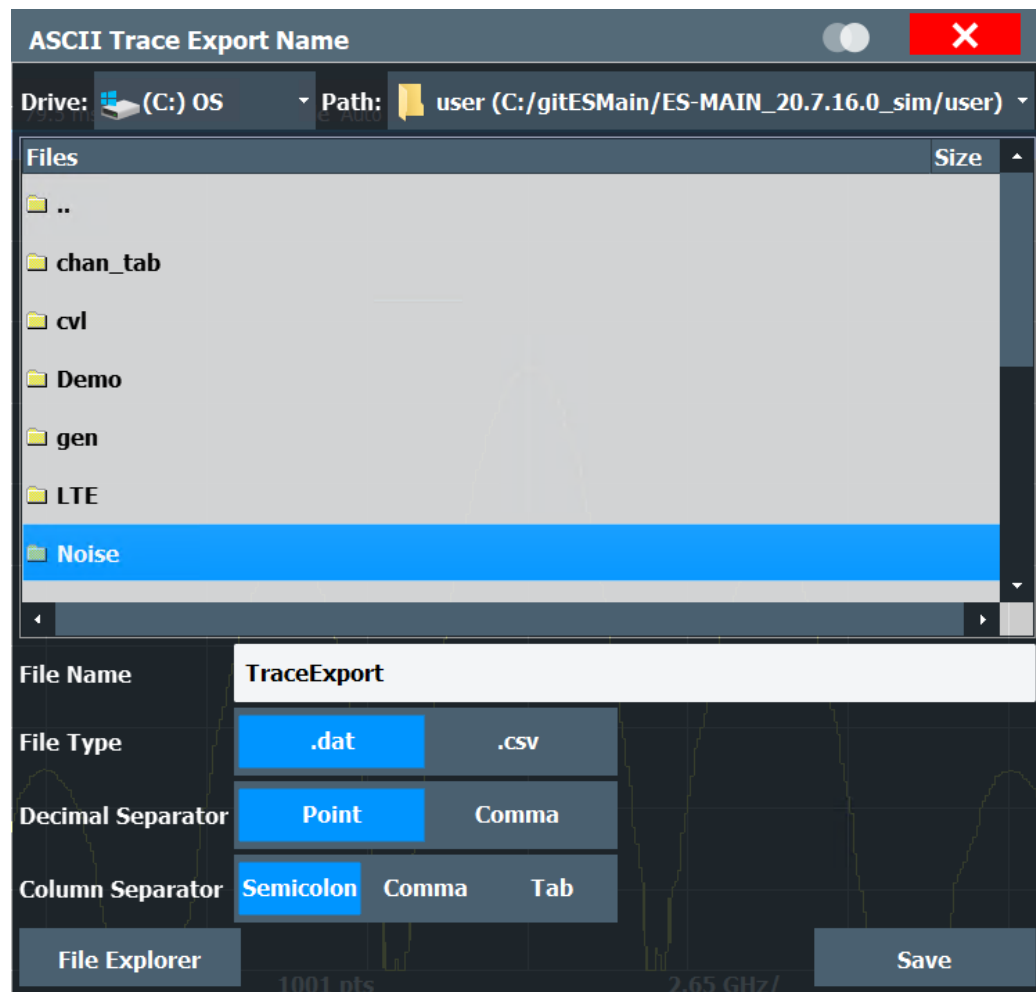

**Note:** Secure user mode.

In secure user mode, settings that are stored on the instrument are stored to volatile memory, which is restricted to 256 MB. Thus, a "memory limit reached" error can occur although the hard disk indicates that storage space is still available.

To store data permanently, select an external storage location such as a USB memory device.

For details, see "Protecting Data Using the Secure User Mode" in the "Data Management" section of the FSW base unit user manual.

Remote command:

[MMEMory:STORe<n>:TRACe](#) on page 283

#### **File Type ← Export Trace to ASCII File**

Determines the format of the ASCII file to be imported or exported.

Depending on the external program in which the data file was created or is evaluated, a comma-separated list (CSV) or a plain data format (DAT) file is required.

Remote command:

[FORMat:DEXPort:FORMat](#) on page 280

#### **Decimal Separator ← Export Trace to ASCII File**

Defines the decimal separator for floating-point numerals for the data export/import files. Evaluation programs require different separators in different languages.

Remote command:

[FORMat:DEXPort:DSEParator](#) on page 282

#### **Column Separator ← Export Trace to ASCII File**

Selects the character that separates columns in the exported ASCII file. The character can be either a semicolon, a comma or a tabulator (tab).

Example for semicolon:

```
Type;FSW13;Version;1.00;Date;01.Jan 3000;
```

Example for comma:

```
Type,FSW13,  
Version,1.00,  
Date,01.Jan 3000,
```

Example for tabulator (tab after the last column is not visible):

```
Type      FSW13  
Version   1.00  
Date      01.Jan 3000
```

The selected column separator setting remains the same, even after a preset.

Remote command:

[FORMat:DEXPort:CSEParator](#) on page 281

#### **File Explorer ← Export Trace to ASCII File**

Opens the Microsoft Windows File Explorer.

Remote command:

not supported

Working with markers in the R&S FSW AM/FM/PM Modulation Analysis application

### Export Spectrogram to ASCII File

Opens a file selection dialog box and saves the selected spectrogram in ASCII format (.dat) to the specified file and directory.

For details on the file format, see the FSW base unit user manual.

**Note:** Secure user mode.

In secure user mode, settings that are stored on the instrument are stored to volatile memory, which is restricted to 256 MB. Thus, a "memory limit reached" error can occur although the hard disk indicates that storage space is still available.

To store data permanently, select an external storage location such as a USB memory device.

For details, see "Protecting Data Using the Secure User Mode" in the "Data Management" section of the FSW base unit user manual.

Remote command:

[MMEMory:STORe<n>:SPECTrogram](#) on page 283

## 6.4 Working with markers in the R&S FSW AM/FM/PM Modulation Analysis application

**Access:** "Overview" > "Analysis"

Basically, markers in the R&S FSW AM/FM/PM Modulation Analysis application are very similar to those in the Spectrum application. However, some additional functions are available.

- [Marker settings](#)..... 109
- [Marker search settings and positioning functions](#)..... 114
- [Marker search settings for spectrograms](#)..... 117
- [Marker function configuration](#)..... 120

### 6.4.1 Marker settings

**Access:** "Overview" > "Analysis" > "Marker" > "Markers"

**Or:** "Marker" > "Markers"

The remote commands required to define these settings are described in [Chapter 11.8.3, "Working with markers remotely"](#), on page 306.

- [Individual marker setup](#)..... 109
- [General marker settings](#)..... 112

#### 6.4.1.1 Individual marker setup

**Access:** "Overview" > "Analysis" > "Marker" > "Markers"

**Or:** "Marker" > "Markers" tab

Working with markers in the R&S FSW AM/FM/PM Modulation Analysis application

In the R&S FSW AM/FM/PM Modulation Analysis application, up to 17 markers or delta markers can be activated for each window simultaneously.

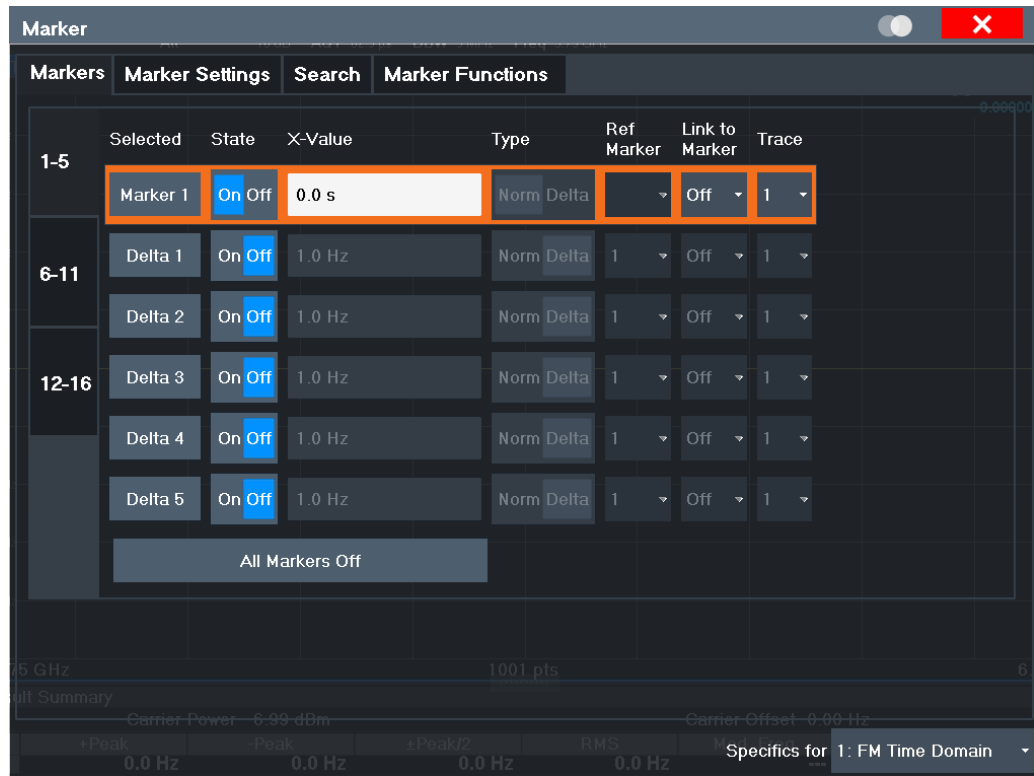

The markers are distributed among 3 tabs for a better overview. By default, the first marker is defined as a normal marker, whereas all others are defined as delta markers with reference to the first marker. All markers are assigned to trace 1, but only the first marker is active.

Selected Marker..... 110  
 Marker State..... 110  
 Marker Position X-value..... 111  
 Marker Type..... 111  
 Reference Marker..... 111  
 Linking to Another Marker..... 111  
 Assigning the Marker to a Trace..... 112  
 All Markers Off..... 112

**Selected Marker**

Marker name. The marker which is currently selected for editing is highlighted orange.

Remote command:

Marker selected via suffix <m> in remote commands.

**Marker State**

Activates or deactivates the marker in the diagram.

Remote command:

CALCulate<n>:MARKer<m>[:STATe] on page 307

CALCulate<n>:DELTAmarker<m>[:STATe] on page 311

**Marker Position X-value**

Defines the position (x-value) of the marker in the diagram. For normal markers, the absolute position is indicated. For delta markers, the position relative to the reference marker is provided.

Remote command:

[CALCulate<n>:MARKer<m>:X](#) on page 308

[CALCulate<n>:DELTAmarker<m>:X](#) on page 311

**Marker Type**

Toggles the marker type.

The type for marker 1 is always "Normal", the type for delta marker 1 is always "Delta". These types cannot be changed.

**Note:** If normal marker 1 is the active marker, switching the "Mkr Type" activates an additional delta marker 1. For any other marker, switching the marker type does not activate an additional marker, it only switches the type of the selected marker.

"Normal"	A normal marker indicates the absolute value at the defined position in the diagram.
"Delta"	A delta marker defines the value of the marker relative to the specified reference marker (marker 1 by default).

Remote command:

[CALCulate<n>:MARKer<m>\[:STATe\]](#) on page 307

[CALCulate<n>:DELTAmarker<m>\[:STATe\]](#) on page 311

**Reference Marker**

Defines a marker as the reference marker which is used to determine relative analysis results (delta marker values).

If the reference marker is deactivated, the delta marker referring to it is also deactivated.

If a fixed reference point is configured (see ["Defining a Fixed Reference"](#) on page 114), the reference point ("FXD") can also be selected instead of another marker.

Remote command:

[CALCulate<n>:DELTAmarker<m>:MREFerence](#) on page 310

**Linking to Another Marker**

Links the current marker to the marker selected from the list of active markers. If the x-axis value of the initial marker is changed, the linked marker follows to the same position on the x-axis. Linking is off by default.

Using this function you can set two markers on different traces to measure the difference (e.g. between a max hold trace and a min hold trace or between a measurement and a reference trace).

For linked delta markers, the x-value of the delta marker is 0 Hz by default. To create a delta marker in a fixed distance to another marker, define the distance as the x-value for the linked delta marker.

Working with markers in the R&S FSW AM/FM/PM Modulation Analysis application

Remote command:

`CALCulate<n>:MARKer<ms>:LINK:TO:MARKer<md>` on page 307

`CALCulate<n>:DELTamarker<ms>:LINK:TO:MARKer<md>` on page 309

`CALCulate<n>:DELTamarker<m>:LINK` on page 309

### Assigning the Marker to a Trace

The "Trace" setting assigns the selected marker to an active trace. The trace determines which value the marker shows at the marker position. If the marker was previously assigned to a different trace, the marker remains on the previous frequency or time, but indicates the value of the new trace.

If a trace is turned off, the assigned markers and marker functions are also deactivated.

Remote command:

`CALCulate<n>:MARKer<m>:TRACe` on page 308

### All Markers Off

Deactivates all markers in one step.

Remote command:

`CALCulate<n>:MARKer<m>:AOFF` on page 306

## 6.4.1.2 General marker settings

**Access:** "Overview" > "Analysis" > "Marker" > "Marker Settings"

**Or:** "Marker" > "Marker Settings" tab

Some general marker settings allow you to influence the marker behavior for all markers.

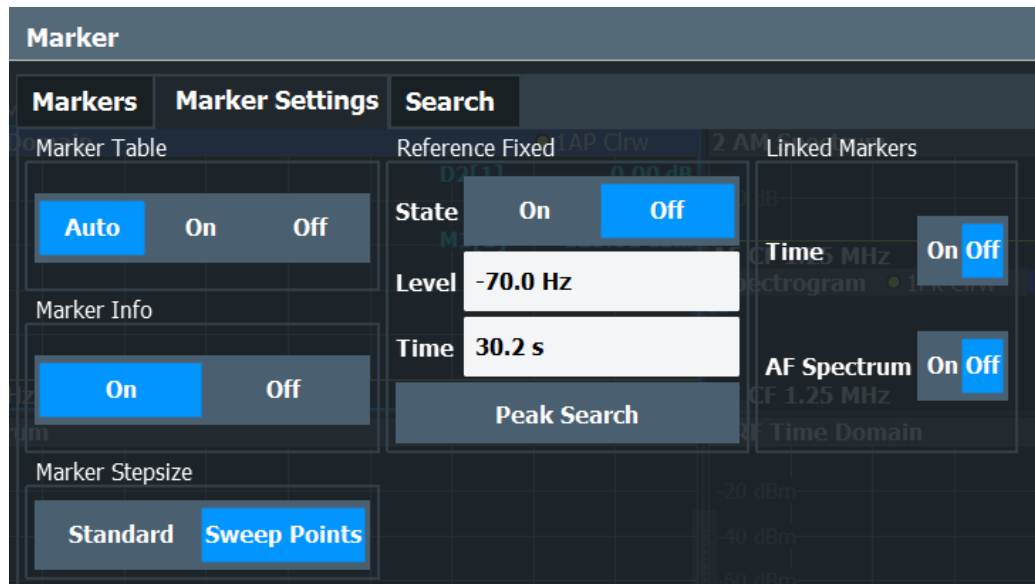



Working with markers in the R&amp;S FSW AM/FM/PM Modulation Analysis application

Marker Table Display.....	113
Marker Info.....	113
Marker Stepsize.....	113
Defining a Fixed Reference.....	114
Link Time Marker.....	114
Link AF Spectrum Marker.....	114

### Marker Table Display

Defines how the marker information is displayed.

"On"	Displays the marker information in a table in a separate area beneath the diagram.
"Off"	No separate marker table is displayed. If <a href="#">Marker Info</a> is active, the marker information is displayed within the diagram area.
"Auto"	(Default) If more than two markers are active, the marker table is displayed automatically. If <a href="#">Marker Info</a> is active, the marker information for up to two markers is displayed in the diagram area.

Remote command:

`DISPlay[:WINDow<n>]:MTABLE` on page 314

### Marker Info

Turns the marker information displayed in the diagram on and off.

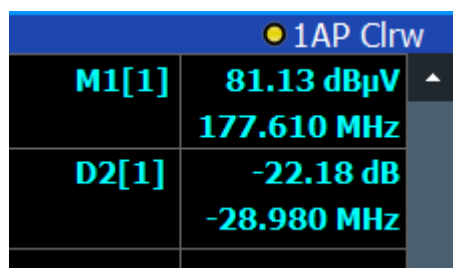

1AP Clrw	
M1[1]	81.13 dBµV 177.610 MHz
D2[1]	-22.18 dB -28.980 MHz

Remote command:

`DISPlay[:WINDow<n>]:MINFo[:STATe]` on page 314

### Marker Stepsize

Defines the size of the steps that the marker position is moved using the rotary knob.

"Standard"	The marker position is moved in steps of (Span/1000), which corresponds approximately to the number of pixels for the default display of 1001 sweep points. This setting is most suitable to move the marker over a larger distance.
"Sweep Points"	The marker position is moved from one sweep point to the next. This setting is required for a very precise positioning if more sweep points are collected than the number of pixels that can be displayed on the screen. It is the default mode.

Remote command:

`CALCulate<n>:MARKer<m>:X:SSIZE` on page 313

**Defining a Fixed Reference**

Instead of using a reference marker whose position can vary depending on the measurement results, you can define a fixed reference marker for trace analysis.

Note that this function is not available in all result displays.

For "State" = "On", a vertical and a horizontal red display line are displayed, marked as "FXD". The normal marker 1 is activated and set to the peak value of the trace assigned to marker 1, and a delta marker to the next peak. The fixed reference marker is set to the position of marker 1 at the peak value. The delta marker refers to the fixed reference marker.

The "Level" and "Frequency" or "Time" settings define the position and value of the reference marker. To move the fixed reference, move the red display lines marked "FXD" in the diagram, or change the position settings in the "Marker Settings" tab of the "Marker" dialog box.

**Peak Search** sets the fixed reference marker to the current maximum value of the trace assigned to marker 1.

If activated, the fixed reference marker ("FXD") can also be selected as a [Reference Marker](#) instead of another marker.

Remote command:

`CALCulate<n>:DELTAmarker<m>:FUNCTION:FIXed[:STATe]` on page 330

`CALCulate<n>:DELTAmarker<m>:FUNCTION:FIXed:RPOint:Y` on page 330

`CALCulate<n>:DELTAmarker<m>:FUNCTION:FIXed:RPOint:X` on page 329

`CALCulate<n>:DELTAmarker<m>:FUNCTION:FIXed:RPOint:MAXimum[:PEAK]` on page 329

**Link Time Marker**

Links the markers in all time domain diagrams.

Remote command:

`CALCulate<n>:MARKer<m>:LINK` on page 313

**Link AF Spectrum Marker**

Links the markers in all AF spectrum displays.

Remote command:

`CALCulate<n>:MARKer<m>:LINK` on page 313

**6.4.2 Marker search settings and positioning functions**

**Access:** "Overview" > "Analysis" > "Marker" > "Search"

**or:** "Marker" > "Search"

Several functions are available to set the marker to a specific position very quickly and easily, or to use the current marker position to define another characteristic value. To determine the required marker position, searches are performed. You can influence the search results using special settings.

Working with markers in the R&S FSW AM/FM/PM Modulation Analysis application

The remote commands required to define these settings are described in [Chapter 11.8.3, "Working with markers remotely"](#), on page 306.

- [Marker search settings](#)..... 115
- [Positioning functions](#)..... 115

#### 6.4.2.1 Marker search settings

**Access:** "Overview" > "Analysis" > "Marker" > "Search"

**or:** "Marker" > "Search"

Markers are commonly used to determine peak values, i.e. maximum or minimum values, in the measured signal. Configuration settings allow you to influence the peak search results.

- [Search Mode for Next Peak](#)..... 115
- [Peak Excursion](#)..... 115

##### Search Mode for Next Peak

Selects the search mode for the next peak search.

- |            |   |
|------------|---|
| "Left"     | Determines the next maximum/minimum to the left of the current peak.    |
| "Absolute" | Determines the next maximum/minimum to either side of the current peak. |
| "Right"    | Determines the next maximum/minimum to the right of the current peak.   |

Remote command:

[Chapter 11.8.3.5, "Positioning the marker"](#), on page 324

##### Peak Excursion

Defines the minimum level value by which a signal must rise or fall so that it is identified as a maximum or a minimum by the search functions.

Entries from 0 dB to 80 dB are allowed; the resolution is 0.1 dB. The default setting for the peak excursion is 6 dB.

For Analog Modulation Analysis, the unit and value range depend on the selected result display type.

Remote command:

[CALCulate<n>:MARKer<m>:PEXCursion](#) on page 324

#### 6.4.2.2 Positioning functions

**Access:** [MKR ->]

The following functions set the currently selected marker to the result of a peak search or set other characteristic values to the current marker value.

Working with markers in the R&S FSW AM/FM/PM Modulation Analysis application

Select Marker.....	116
Peak Search.....	116
Search Next Peak.....	116
Search Minimum.....	117
Search Next Minimum.....	117

### Select Marker

The "Select Marker" function opens a dialog box to select and activate or deactivate one or more markers quickly.



Remote command:

`CALCulate<n>:MARKer<m>[:STATe]` on page 307

`CALCulate<n>:DELTamarker<m>[:STATe]` on page 311

### Peak Search

Sets the selected marker/delta marker to the maximum of the trace. If no marker is active, marker 1 is activated.

Remote command:

`CALCulate<n>:MARKer<m>:MAXimum[:PEAK]` on page 325

`CALCulate<n>:DELTamarker<m>:MAXimum[:PEAK]` on page 327

### Search Next Peak

Sets the selected marker/delta marker to the next (lower) maximum of the assigned trace. If no marker is active, marker 1 is activated.

Remote command:

`CALCulate<n>:MARKer<m>:MAXimum:NEXT` on page 325

`CALCulate<n>:MARKer<m>:MAXimum:RIGHT` on page 325

`CALCulate<n>:MARKer<m>:MAXimum:LEFT` on page 325

`CALCulate<n>:DELTamarker<m>:MAXimum:NEXT` on page 327

`CALCulate<n>:DELTamarker<m>:MAXimum:RIGHT` on page 327

`CALCulate<n>:DELTamarker<m>:MAXimum:LEFT` on page 327

**Search Minimum**

Sets the selected marker/delta marker to the minimum of the trace. If no marker is active, marker 1 is activated.

Remote command:

[CALCulate<n>:MARKer<m>:MINimum\[:PEAK\]](#) on page 326

[CALCulate<n>:DELTamarker<m>:MINimum\[:PEAK\]](#) on page 328

**Search Next Minimum**

Sets the selected marker/delta marker to the next (higher) minimum of the selected trace. If no marker is active, marker 1 is activated.

Remote command:

[CALCulate<n>:MARKer<m>:MINimum:NEXT](#) on page 326

[CALCulate<n>:MARKer<m>:MINimum:LEFT](#) on page 326

[CALCulate<n>:MARKer<m>:MINimum:RIGHT](#) on page 326

[CALCulate<n>:DELTamarker<m>:MINimum:NEXT](#) on page 328

[CALCulate<n>:DELTamarker<m>:MINimum:LEFT](#) on page 328

[CALCulate<n>:DELTamarker<m>:MINimum:RIGHT](#) on page 328

### 6.4.3 Marker search settings for spectrograms

**Access:** "Overview" > "Analysis" > "Markers" > "Search"

**or:** [MKR TO] > "Search Config"

Spectrograms show not only the current sweep results, but also the sweep history. Thus, when searching for peaks, you must define the search settings within a single time frame (x-direction) and within several time frames (y-direction).

These settings are only available for spectrogram displays.

Working with markers in the R&S FSW AM/FM/PM Modulation Analysis application

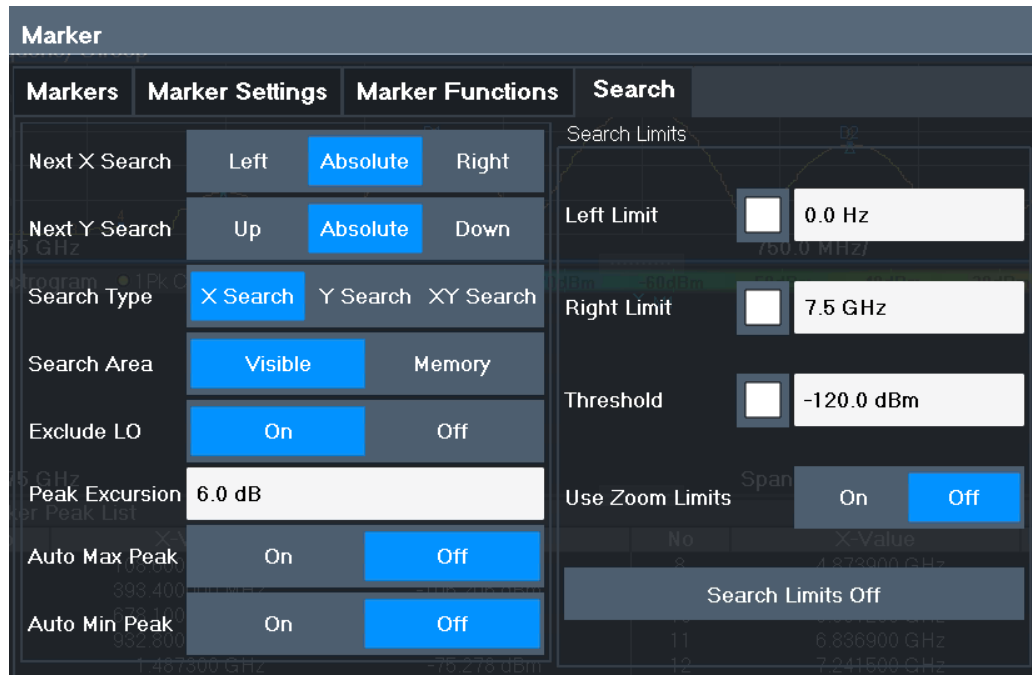

Search Mode for Next Peak in X-Direction.....	118
Search Mode for Next Peak in Y-Direction.....	118
Marker Search Type.....	119
Marker Search Area.....	119
Peak Excursion.....	119

#### Search Mode for Next Peak in X-Direction

Selects the search mode for the next peak search within the currently selected frame.

"Left"	Determines the next maximum/minimum to the left of the current peak.
"Absolute"	Determines the next maximum/minimum to either side of the current peak.
"Right"	Determines the next maximum/minimum to the right of the current peak.

Remote command:

[Chapter 11.8.3.5, "Positioning the marker"](#), on page 324

#### Search Mode for Next Peak in Y-Direction

Selects the search mode for the next peak search within all frames at the current marker position.

"Up"	Determines the next maximum/minimum above the current peak (in more recent frames).
"Absolute"	Determines the next maximum/minimum above or below the current peak (in all frames).
"Down"	Determines the next maximum/minimum below the current peak (in older frames).

## Working with markers in the R&amp;S FSW AM/FM/PM Modulation Analysis application

Remote command:

`CALCulate<n>:MARKer<m>:SPECTrogram:Y:MAXimum:ABOVE` on page 317

`CALCulate<n>:DELTamarker<m>:SPECTrogram:Y:MAXimum:ABOVE`

on page 321

`CALCulate<n>:MARKer<m>:SPECTrogram:Y:MAXimum:BELOW` on page 317

`CALCulate<n>:DELTamarker<m>:SPECTrogram:Y:MAXimum:BELOW`

on page 322

`CALCulate<n>:MARKer<m>:SPECTrogram:Y:MAXimum:NEXT` on page 317

`CALCulate<n>:DELTamarker<m>:SPECTrogram:Y:MAXimum:NEXT` on page 322

`CALCulate<n>:MARKer<m>:SPECTrogram:Y:MINimum:ABOVE` on page 318

`CALCulate<n>:DELTamarker<m>:SPECTrogram:Y:MINimum:ABOVE`

on page 322

`CALCulate<n>:MARKer<m>:SPECTrogram:Y:MINimum:BELOW` on page 318

`CALCulate<n>:DELTamarker<m>:SPECTrogram:Y:MINimum:BELOW`

on page 323

`CALCulate<n>:MARKer<m>:SPECTrogram:Y:MINimum:NEXT` on page 319

`CALCulate<n>:DELTamarker<m>:SPECTrogram:Y:MINimum:NEXT` on page 323

### Marker Search Type

Defines the type of search to be performed in the spectrogram.

"X-Search" Searches only within the currently selected frame.

"Y-Search" Searches within all frames but only at the current frequency position.

"XY-Search" Searches in all frames at all positions.

Remote command:

Defined by the search function, see [Chapter 11.8.3.3, "Marker search \(spectrograms\)"](#), on page 315

### Marker Search Area

Defines which frames the search is performed in.

"Visible" Only the visible frames are searched.

"Memory" All frames stored in the memory are searched.

Remote command:

`CALCulate<n>:MARKer<m>:SPECTrogram:SARea` on page 316

`CALCulate<n>:DELTamarker<m>:SPECTrogram:SARea` on page 321

### Peak Excursion

Defines the minimum level value by which a signal must rise or fall so that it is identified as a maximum or a minimum by the search functions.

Entries from 0 dB to 80 dB are allowed; the resolution is 0.1 dB. The default setting for the peak excursion is 6 dB.

For Analog Modulation Analysis, the unit and value range depend on the selected result display type.

Remote command:

`CALCulate<n>:MARKer<m>:PEXCursion` on page 324

#### 6.4.4 Marker function configuration

**Access:** "Overview" > "Analysis" > "Marker Functions" > "Phase Noise"

**Or:** [MKR FUNC] > "Select Marker Function"

Special marker functions can be selected via the "Marker Function" dialog box.



The fixed reference marker is described under ["Defining a Fixed Reference"](#) on page 114.

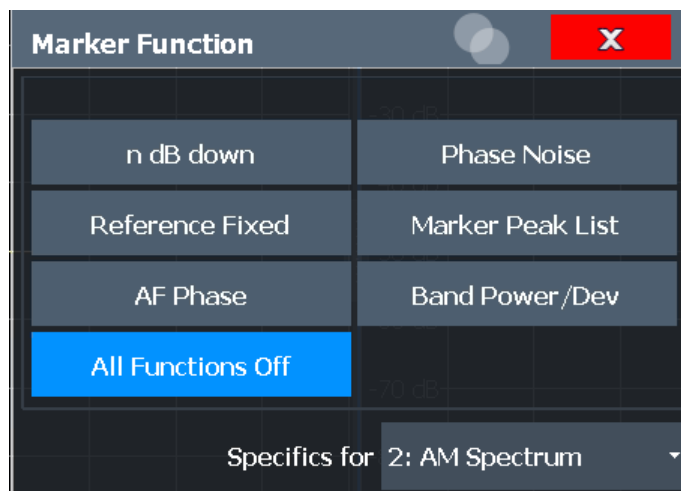

Not all marker functions are available for all evaluations. The following table indicates which functions are available for which evaluations.

Evaluation	n dB down	Phase Noise	Reference Fixed	"Marker Peak List"	AF Phase	Band Power / Dev
AM/FM/PM time	-	-	X	X	-	-
AF/FM/PM spectrum	X	X	X	X	X	X
RF time	X	-	X	X	-	-
RF spectrum	X	X	X	X	-	X

For details on the special marker functions, see the FSW User Manual.

The remote commands required to define these settings are described in [Chapter 11.8.3.6, "Configuring special marker functions"](#), on page 329.



The Fixed Reference Marker settings are described in ["Defining a Fixed Reference"](#) on page 114.

- [Measuring characteristic bandwidths \(n db down marker\)](#)..... 121
- [Phase noise measurement marker](#)..... 122
- [Marker peak list](#)..... 125



## Working with markers in the R&amp;S FSW AM/FM/PM Modulation Analysis application

- [Measuring the power in a channel \(band power marker\)](#)..... 129
- [AF phase marker](#)..... 132
- [Deactivating all marker functions](#)..... 132

#### 6.4.4.1 Measuring characteristic bandwidths (n dB down marker)

**Access:** "Overview" > "Analysis" > "Marker Functions" > "n dB down" > "n dB Down Config"

**Or:** [MKR FUNC] > "Select Marker Function" > "n dB down" > "n dB Down Config"

When characterizing the shape of a signal, the bandwidth at a specified offset from its peak level is often of interest. The offset is specified as a relative decrease in amplitude of n dB. To measure this bandwidth, you could use several markers and delta markers and determine the bandwidth manually. However, using the n dB down marker function makes the task very simple and quick.

The n dB down marker function uses the current value of marker 1 as the reference point. It activates two temporary markers T1 and T2 located on the signal, whose level is n dB below the level of the reference point. Marker T1 is placed to the left and marker T2 to the right of the reference marker. The default setting for n is 3 dB, but it can be changed.

If a positive offset is entered, the markers T1 and T2 are placed below the active reference point. If a negative value is entered (for example for notch filter measurements), the markers T1 and T2 are placed above the active reference point.

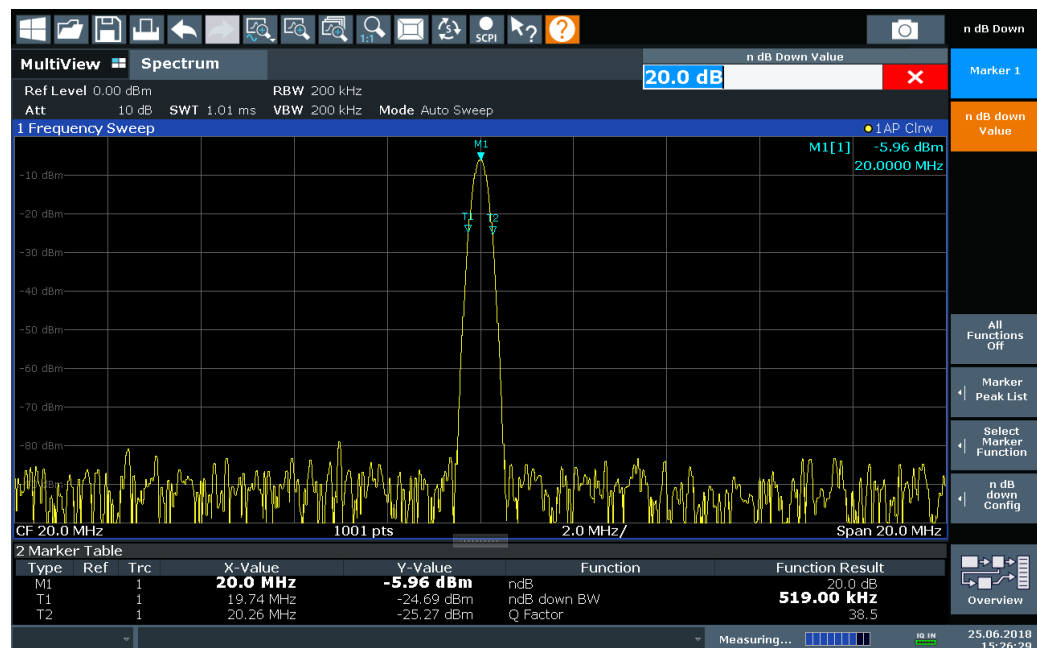

Figure 6-2: n dB down marker function

The following marker function results are displayed:

**Table 6-1: n dB down marker function results**

Label	Description
M1	Current position and level of marker 1
ndB	Offset value (n dB down)
ndB down Bw / PWid	Determined bandwidth or pulse width (zero span) at the offset
Q-factor	Center frequency / n-dB-down-bandwidth Quality factor of the determined bandwidth (characteristic of damping or resonance)
T1, T2	Current position and level of the temporary markers

If the required position for the temporary markers cannot be determined uniquely, for example due to noise, dashes are displayed as a result.

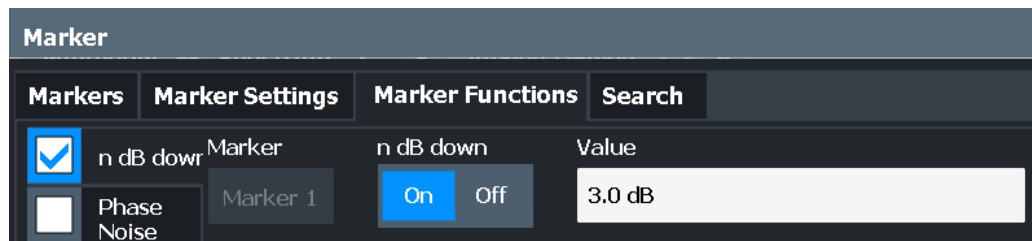
**Remote commands:**

[CALCulate<n>:MARKer<m>:FUNCTION:NDBDown:STATe](#) on page 338

[CALCulate<n>:MARKer<m>:FUNCTION:NDBDown:RESult?](#) on page 337

[n dB down Marker State](#)..... 122

[n dB down Value](#)..... 122

**n dB down Marker State**

Activates or deactivates the special n dB down marker function.

Remote command:

[CALCulate<n>:MARKer<m>:FUNCTION:NDBDown:STATe](#) on page 338

[CALCulate<n>:MARKer<m>:FUNCTION:NDBDown:RESult?](#) on page 337

**n dB down Value**

Defines the delta level from the reference marker 1 used to determine the bandwidth or time span.

Remote command:

[CALCulate<n>:MARKer<m>:FUNCTION:NDBDown:FREquency?](#) on page 336

[CALCulate<n>:MARKer<m>:FUNCTION:NDBDown:TIME?](#) on page 338

**6.4.4.2 Phase noise measurement marker**

**Access:** "Overview" > "Analysis" > "Marker Functions" > "Phase Noise" > "Phase Noise Config"

**Or:** [MKR FUNC] > "Select Marker Function" > "Phase Noise" > "Phase Noise Config"

For each of the 16 markers, you can activate a phase noise measurement.

Note that phase noise markers are available:

- for spectrum results
- for normal markers
- not for time domain results

Phase noise is unintentional modulation of a carrier; it creates frequencies next to the carrier frequency. A phase noise measurement consists of noise density measurements at defined offsets from the carrier; the results are given in relation to the carrier level (dBc). The phase noise marker function measures the noise power at the delta markers referred to 1 Hz bandwidth. Marker 1 is used as the reference for the phase noise measurement. By default, the current frequency and level of marker 1 are used as the fixed reference marker. However, you can start a peak search to use the current signal peak as the reference point, or you can define a reference point manually.

The reference point for the phase noise measurement is fixed. After phase noise measurement is started, you can set the reference level or the center frequency so that the carrier is outside the displayed frequency range. You can also activate a notch filter to suppress the carrier.

Alternatively, the reference point can be determined automatically by a peak search after each sweep. Use this function to track a drifting source during a phase noise measurement. The delta marker 2, which shows the phase noise measurement result, keeps the delta frequency value. Thus, the phase noise measurement leads to reliable results in a certain offset although the source is drifting. Only if the marker 2 reaches the border of the span, the delta marker value is adjusted to be within the span. In these cases, select a larger span.

The result of the phase noise measurement is the difference in level between the reference point and the noise power density. It is indicated as the function result of the phase noise marker in the "marker table".

The sample detector is automatically used and the video bandwidth set to 0.1 times the resolution bandwidth (RBW). The two settings are considered in the correction values used for the noise power measurement. To obtain stable results, two pixels on the right and the left of the delta marker position are taken for the measurement.

The individual marker settings correspond to those defined in the "Marker" dialog box. Any settings to the marker state or type changed in the "Marker Function" dialog box are also changed in the "Marker" dialog box and vice versa.

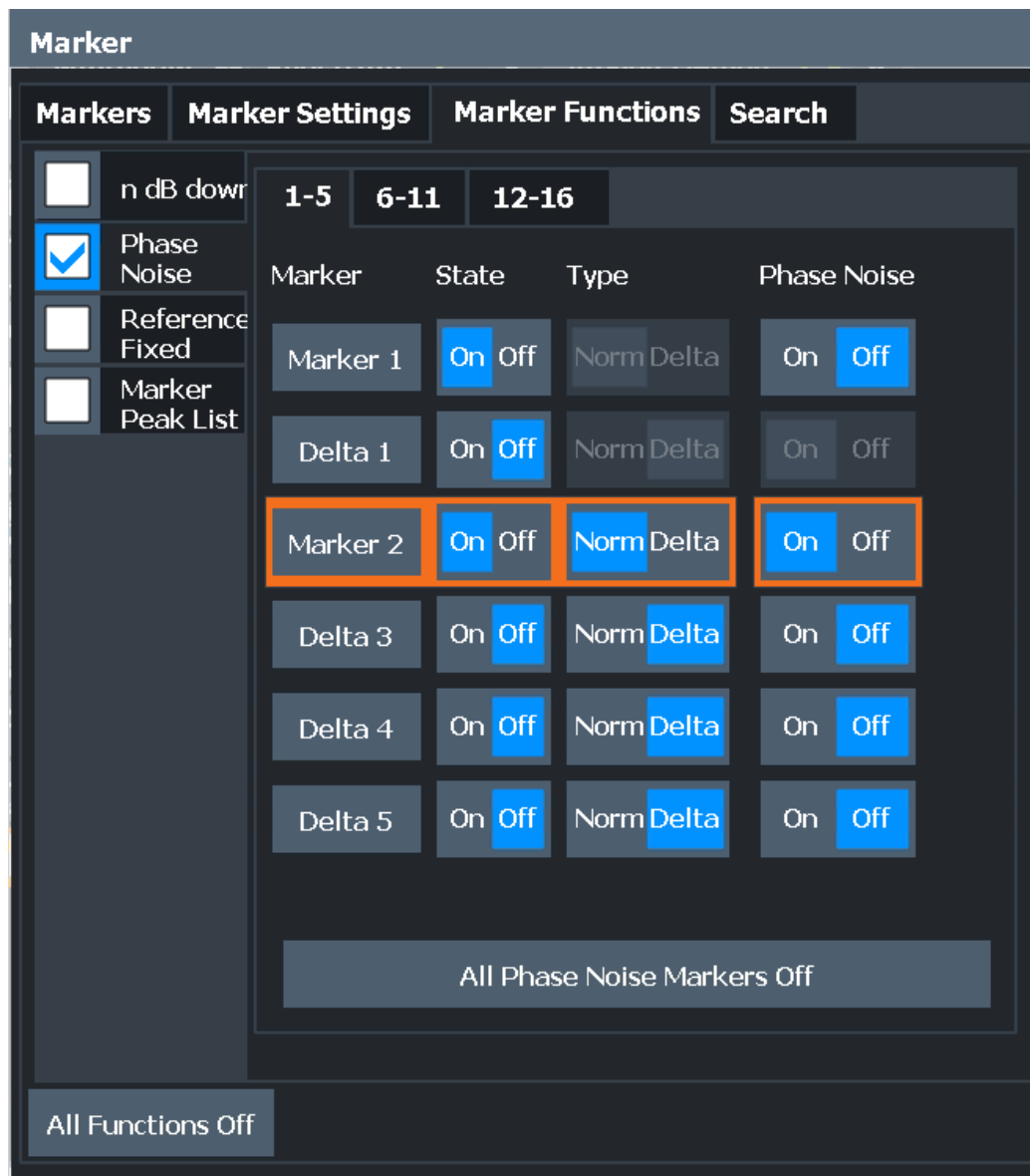
**Remote commands:**

[CALCulate<n>:MARKer<m>:FUNCTION:PNOise\[:STATE\]](#) on page 339

[CALCulate<n>:MARKer<m>:FUNCTION:PNOise:RESULT?](#) on page 340

[Phase Noise Measurement State](#)..... 124

[Switching All Phase Noise Measurements Off](#)..... 125

**Phase Noise Measurement State**

Activates or deactivates phase noise measurement at the marker position in the diagram.

In the R&S FSW AM/FM/PM Modulation Analysis application, this function is only available for normal markers.

If activated, the normal markers display the phase noise measured at their current position in the "marker table".

For details see [Chapter 6.4.4.2, "Phase noise measurement marker"](#), on page 122.

Remote command:

`CALCulate<n>:MARKer<m>:FUNction:PNOise[:STATe]` on page 339

`CALCulate<n>:MARKer<m>:FUNction:PNOise:RESult?` on page 340

### Switching All Phase Noise Measurements Off

Deactivates phase noise measurement for all markers.

Remote command:

`CALCulate<n>:MARKer<m>:FUNction:PNOise[:STATe]` on page 339

### 6.4.4.3 Marker peak list

**Access:** "Overview" > "Analysis" > "Marker Functions" > "Marker Peak List"

**Or:** [MKR FUNC] > "Marker Peak List"

A common measurement task is to determine peak values, i.e. maximum or minimum signal levels. The FSW provides various peak search functions and applications:

- Setting a marker to a peak value once (Peak Search)
- Searching for a peak value within a restricted search area (Search Limits)
- Creating a "marker table" with all or a defined number of peak values for one sweep ("Marker Peak List")
- Updating the marker position to the current peak value automatically after each sweep (Auto Peak Search)
- Creating a fixed reference marker at the current peak value of a trace (Fixed Reference)

#### Peak search limits

The peak search can be restricted to a search area. The search area is defined by limit lines which are also indicated in the diagram. In addition, a minimum value (threshold) can be defined as a further search condition.

#### When is a peak a peak? - Peak excursion

During a peak search, noise values are detected as a peak if the signal is very flat or does not contain many peaks. Therefore, you can define a relative threshold ("Peak Excursion"). The signal level must increase by the threshold value before falling again before a peak is detected. To avoid identifying noise peaks as maxima or minima, enter a peak excursion value that is higher than the difference between the highest and the lowest value measured for the displayed inherent noise.

#### Effect of peak excursion settings (example)

The following figure shows a trace to be analyzed.

## Working with markers in the R&amp;S FSW AM/FM/PM Modulation Analysis application

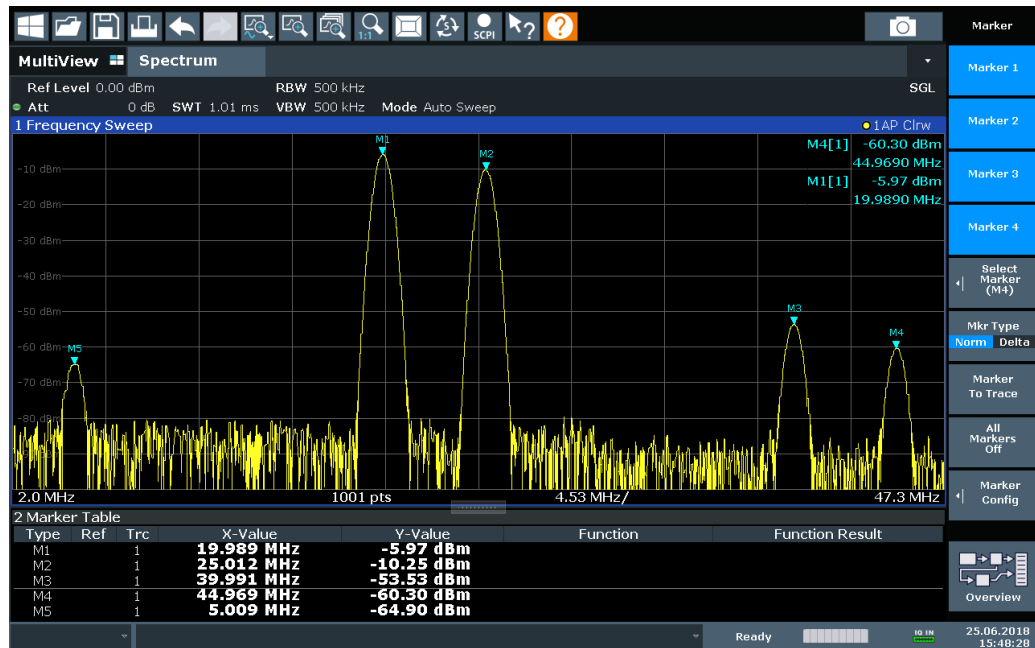

Figure 6-3: Trace example

The following table lists the peaks as indicated by the marker numbers in the diagram above, as well as the minimum decrease in amplitude to either side of the peak:

Marker #	Min. amplitude decrease to either side of the signal
1	80 dB
2	80 dB
3	55 dB
4	39 dB
5	32 dB

To eliminate the smaller peaks M3, M4 and M5 in the example above, a peak excursion of at least 60 dB is required. In this case, the amplitude must rise at least 60 dB before falling again before a peak is detected.

### Marker peak list

The marker peak list determines the frequencies and levels of peaks in the spectrum. It is updated automatically after each sweep. How many peaks are displayed can be defined, as well as the sort order. In addition, the detected peaks can be indicated in the diagram. The peak list can also be exported to a file for analysis in an external application.

### Automatic peak search

A peak search can be repeated automatically after each sweep to keep the maximum value as the reference point for a phase noise measurement. Automatic peak search is useful to track a drifting source. The delta marker 2, which shows the phase noise

## Working with markers in the R&amp;S FSW AM/FM/PM Modulation Analysis application

measurement result, keeps the delta frequency value. Therefore, the phase noise measurement leads to reliable results in a certain offset although the source is drifting.

**Using a peak as a fixed reference marker**

Some results are analyzed in relation to a peak value, for example a carrier frequency level. In this case, the maximum level can be determined by an initial peak search and then be used as a reference point for further measurement results.

In the R&S FSW AM/FM/PM Modulation Analysis application, the search limits are not available.

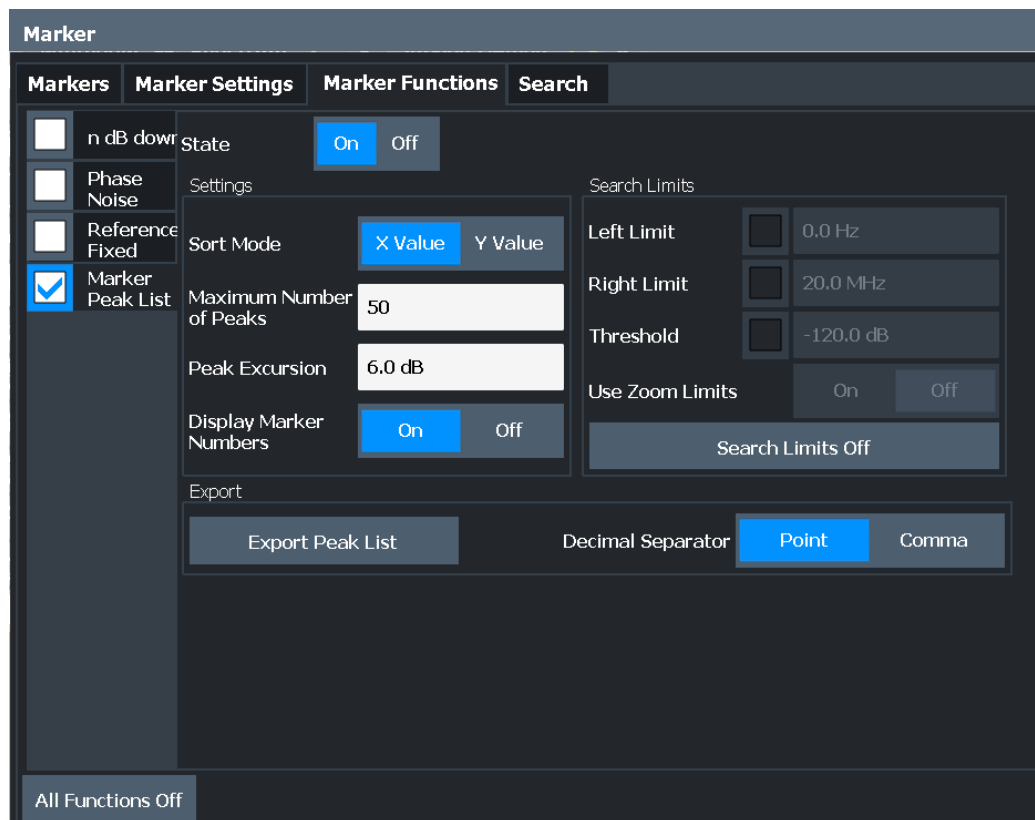
**Remote commands:**

[CALCulate<n>:MARKer<m>:FUNCTION:FPEaks:STATE](#) on page 334

TRAC? LIST,

<a href="#">Peak List State</a> .....	128
<a href="#">Sort Mode</a> .....	128
<a href="#">Maximum Number of Peaks</a> .....	128
<a href="#">Peak Excursion</a> .....	128
<a href="#">Display Marker Numbers</a> .....	128
<a href="#">Export Peak List</a> .....	128

**Peak List State**

Activates/deactivates the marker peak list. If activated, the peak list is displayed and the peaks are indicated in the trace display.

For each listed peak, the frequency/time ("X-value") and level ("Y-Value") values are given.

Remote command:

[CALCulate<n>:MARKer<m>:FUNCTION:FPEaks:STATE](#) on page 334

**Sort Mode**

Defines whether the peak list is sorted according to the x-values or y-values. In either case, the values are sorted in ascending order.

Remote command:

[CALCulate<n>:MARKer<m>:FUNCTION:FPEaks:SORT](#) on page 333

**Maximum Number of Peaks**

Defines the maximum number of peaks to be determined and displayed.

Remote command:

[CALCulate<n>:MARKer<m>:FUNCTION:FPEaks:LIST:SIZE](#) on page 333

**Peak Excursion**

Defines the minimum level value by which a signal must rise or fall so that it is identified as a maximum or a minimum by the search functions.

Entries from 0 dB to 80 dB are allowed; the resolution is 0.1 dB. The default setting for the peak excursion is 6 dB.

For Analog Modulation Analysis, the unit and value range depend on the selected result display type.

Remote command:

[CALCulate<n>:MARKer<m>:PEXCursion](#) on page 324

**Display Marker Numbers**

By default, the marker numbers are indicated in the diagram so you can find the peaks from the list. However, for large numbers of peaks, the marker numbers can decrease readability; in this case, deactivate the marker number display.

Remote command:

[CALCulate<n>:MARKer<m>:FUNCTION:FPEaks:ANnotation:LABel\[:STATE\]](#) on page 332

**Export Peak List**

The peak list can be exported to an ASCII file (.DAT) for analysis in an external application.

Remote command:

[MMEMory:STORe<n>:PEAK](#) on page 335

[FORMat:DEXPort:DSEParator](#) on page 282



#### 6.4.4.4 Measuring the power in a channel (band power marker)

**Access:** "Overview" > "Analysis" > "Marker Functions" > "Band Power" > "Band Power Config"

**or:** [MKR FUNC] > "Select Marker Function" > "Band Power"

To determine the noise power in a transmission channel, you can use a noise marker and multiply the result with the channel bandwidth. However, the results are only accurate for flat noise.

Band power markers allow you to measure the integrated power for a defined span (band) around a marker (similar to ACP measurements). By default, 5 % of the current span is used. The span is indicated by limit lines in the diagram. You can easily change the span by moving the limit lines in the diagram. They are automatically aligned symmetrically to the marker frequency. They are also moved automatically if you move the marker on the screen.

The results can be displayed either as a power (dBm) or density (dBm/Hz) value and are indicated in the "marker table" for each band power marker.



#### Relative band power markers

The results for band power markers which are defined as *delta* markers and thus have a reference value can also be calculated as reference power values (in dB).

For Analog Modulation Analysis, relative band power markers are not available.

In this case, the result of the band power delta marker is the difference between the absolute power in the band around the delta marker and the absolute power for the reference marker. The powers are subtracted logarithmically, so the result is a dB value.

*[Relative band power (Delta2) in dB] = [absolute band power (Delta2) in dBm] - [absolute (band) power of reference marker in dBm]*

The measured power for the reference marker may be an absolute power at a single point (if the reference marker is not a band power marker), or the power in a band (if the reference marker is a band power marker itself).

If the reference marker for the band power marker is also a delta marker, the absolute power level for the reference marker is used for calculation.



Band power markers are only available for standard frequency measurements (not zero span) in the Spectrum and R&S FSW AM/FM/PM Modulation Analysis application. In Analog Modulation Analysis with AM, FM, or PM spectrum results, this marker function does not determine a power value, but rather the deviation within the specified span.

The entire band must lie within the display. If it is moved out of the display, the result cannot be calculated (indicated by "- -" as the "Function Result"). However, the width of the band is maintained so that the band power can be calculated again when it returns to the display.

Working with markers in the R&S FSW AM/FM/PM Modulation Analysis application

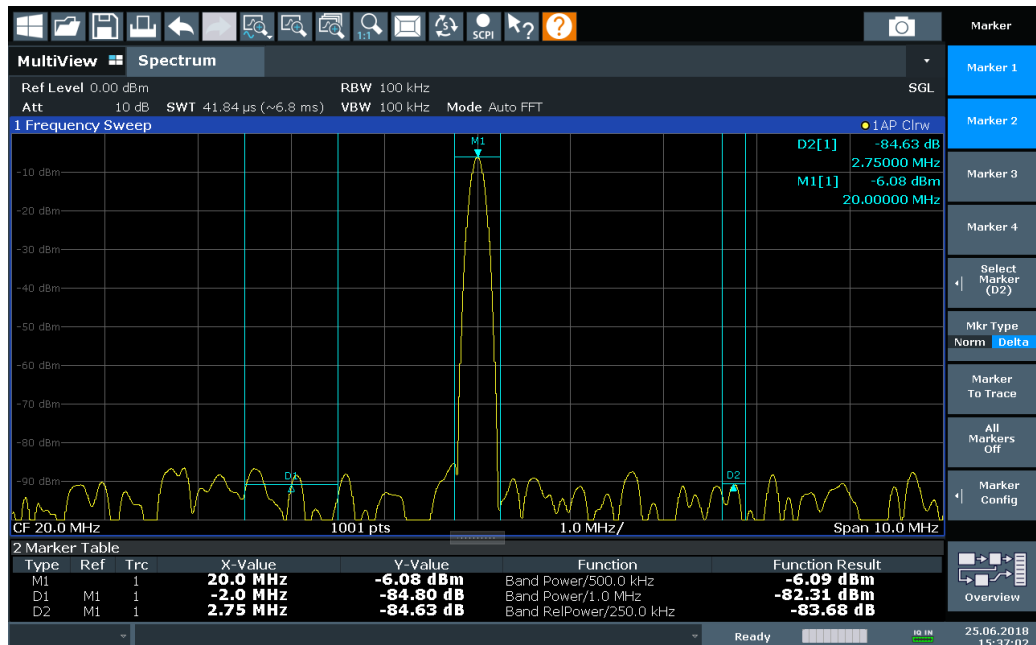

All markers can be defined as band power markers, each with a different span. When a band power marker is activated, if no marker is active yet, marker 1 is activated. Otherwise, the currently active marker is used as a band power marker (all other marker functions for this marker are deactivated).

If the detector mode for the marker trace is set to "Auto", the RMS detector is used.

The individual marker settings correspond to those defined in the "Marker" dialog box (see Chapter 6.4.1.1, "Individual marker setup", on page 109). Any settings to the marker state or type changed in the "Marker Function" dialog box are also changed in the "Marker" dialog box and vice versa.

	1-5		6-11		12-16				
	Marker	State	Type	Band Power	Span	Power Mode			
<input checked="" type="checkbox"/> Band Power	Marker 1	On Off	Norm Delta	On Off	375.0 MHz	Power	Density		
<input type="checkbox"/> Phase Noise	Delta 1	On Off	Norm Delta	On Off	375.0 MHz	Power	RelPower	Density	
<input type="checkbox"/> Marker Demod	Delta 2	On Off	Norm Delta	On Off	375.0 MHz	Power	RelPower	Density	
<input type="checkbox"/> Reference Fixed	Delta 3	On Off	Norm Delta	On Off	375.0 MHz	Power	RelPower	Density	
<input type="checkbox"/> Marker Peak List	Delta 4	On Off	Norm Delta	On Off	375.0 MHz	Power	RelPower	Density	
	Delta 5	On Off	Norm Delta	On Off	375.0 MHz	Power	RelPower	Density	

All Bandpower Markers Off

**Remote commands:**

`CALCulate<n>:MARKer<m>:FUNCTION:BPOWer[:STATe]` on page 342

`CALCulate<n>:MARKer<m>:FUNCTION:BPOWer:RESult?` on page 341

<a href="#">Band Power Measurement State</a> .....	131
<a href="#">Span</a> .....	131
<a href="#">Power Mode</a> .....	131
<a href="#">Switching All Band Power Measurements Off</a> .....	132

**Band Power Measurement State**

Activates or deactivates band power measurement for the marker in the diagram.

Band power markers are only available for standard frequency measurements (not zero span) in the Spectrum application.

If activated, the markers display the power or density measured in the band around the current marker position.

For details see [Chapter 6.4.4.4, "Measuring the power in a channel \(band power marker\)"](#), on page 129.

Remote command:

`CALCulate<n>:MARKer<m>:FUNCTION:BPOWer[:STATe]` on page 342

`CALCulate<n>:DELTaMarker<m>:FUNCTION:BPOWer[:STATe]` on page 343

**Span**

Defines the span (band) around the marker for which the power is measured.

The span is indicated by lines in the diagram. You can easily change the span by moving the limit lines in the diagram. They are automatically aligned symmetrically to the marker frequency. They are also moved automatically if you move the marker on the screen.

Remote command:

`CALCulate<n>:MARKer<m>:FUNCTION:BPOWer:SPAN` on page 341

`CALCulate<n>:DELTaMarker<m>:FUNCTION:BPOWer:SPAN` on page 343

**Power Mode**

Defines the mode of the power measurement result.

For Analog Modulation Analysis, the power mode is not editable for AM, FM, or PM spectrum results. In this case, the marker function does not determine a power value, but rather the deviation within the specified span.

"Power"	The result is an absolute power level. The power unit depends on the <a href="#">Units</a> setting.
"Relative Power"	This setting is only available for a delta band power marker. The result is the difference between the absolute power in the band around the delta marker and the absolute power for the reference marker (see <a href="#">"Reference Marker"</a> on page 111). The powers are subtracted logarithmically, so the result is a dB value. <i>[Relative band power (Delta2) in dB] = [absolute band power (Delta2) in dBm] - [absolute (band) power of reference marker in dBm]</i> For details see <a href="#">"Relative band power markers"</a> on page 129

Working with markers in the R&S FSW AM/FM/PM Modulation Analysis application

"Density" The result is a power level in relation to the bandwidth, displayed in dBm/Hz.

Remote command:

`CALCulate<n>:MARKer<m>:FUNCTION:BPOwer:MODE` on page 340

`CALCulate<n>:DELTamarker<m>:FUNCTION:BPOwer:MODE` on page 342

#### Switching All Band Power Measurements Off

Deactivates band power measurement for all markers.

Remote command:

`CALCulate<n>:MARKer<m>:FUNCTION:BPOwer[:STATe]` on page 342

`CALCulate<n>:DELTamarker<m>:FUNCTION:BPOwer[:STATe]` on page 343

#### 6.4.4.5 AF phase marker

**Access:** "Overview" > "Analysis" > "Marker Functions" > "AF Phase"

**or:** [MKR FUNC] > "Select Marker Function" > "AF Phase"

This marker function is only available for AF spectrum result displays. If enabled, the phase value at each marker position is included in the "marker table". The function is always enabled for all active markers in the selected display, it cannot be disabled for individual markers. Note that the phase value is always wrapped, and always absolute, also for delta markers. The unit depends on the phase unit setting (see "Phase Unit (Rad/Deg)" on page 82.

4 Marker Table							
Wnd	Type	Ref	Trc	X-Value	Y-Value	Function	Function Result
1	M1		1	96.2 kHz	30.00 %	Phase-Value	660.99 mrad
1	D1	M1	1	354.67 kHz	-54.93 dB	Phase-Value	1.87 rad
2	M1		1	96.2 kHz	440.08 µrad	Phase-Value	2.83 rad
2	D1	M1	1	354.7 kHz	-8.22 dB	Phase-Value	-2.91 rad

Remote commands:

`CALCulate<n>:MARKer<m>:FUNCTION:AFPHase[:STATe]` on page 345

`CALCulate<n>:MARKer<m>:FUNCTION:AFPHase:RESult?` on page 345

`CALCulate<n>:DELTamarker<m>:FUNCTION:AFPHase[:STATe]` on page 344

`CALCulate<n>:DELTamarker<m>:FUNCTION:AFPHase:RESult?` on page 344

#### 6.4.4.6 Deactivating all marker functions

**Access:** "Overview" > "Analysis" > "Marker Functions" > "All Functions Off"

**Or:** [MKR FUNC] > "All Functions Off"

All special marker functions can be deactivated in one step.

Remote command:

`CALCulate<n>:MARKer<m>:FUNCTION:BPOwer:AOFF` on page 340

`CALCulate<n>:MARKer<m>:FUNCTION:PNOise:AOFF` on page 339

## 6.5 Analysis in MSRA/MSRT mode

The data that was captured by the MSRA/MSRT primary can be analyzed in the R&S FSW AM/FM/PM Modulation Analysis application.

The analysis settings and functions available in MSRA/MSRT mode are those described for common Signal and Spectrum Analyzer mode.

### Analysis line settings

In addition, an analysis line can be positioned. The analysis line is a common time marker for all MSRA/MSRT applications.

**AL** 10.0 ms

To hide or show and position the analysis line, a dialog box is available. To display the "Analysis Line" dialog box, tap the "AL" icon in the toolbar (only available in MSRA/MSRT mode). The current position of the analysis line is indicated on the icon.

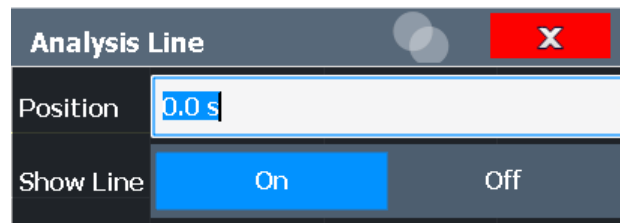

Position.....	133
Show Line.....	133

### Position

Defines the position of the analysis line in the time domain. The position must lie within the measurement time of the multistandard measurement.

Remote command:

[CALCulate<n>:MSRA:ALINE\[:VALue\]](#) on page 371

[CALCulate<n>:RTMS:ALINE\[:VALue\]](#) on page 372

### Show Line

Hides or displays the analysis line in the time-based windows. By default, the line is displayed.

**Note:** The window title bar always shows whether the currently defined line position lies within the analysis interval of the active secondary application, even if the analysis line display is disabled.

Remote command:

[CALCulate<n>:MSRA:ALINE:SHOW](#) on page 370

[CALCulate<n>:RTMS:ALINE:SHOW](#) on page 372

## 7 I/Q data import and export

Baseband signals mostly occur as so-called complex baseband signals, i.e. a signal representation that consists of two channels; the inphase (I) and the quadrature (Q) channel. Such signals are referred to as I/Q signals. The complete modulation information and even distortion that originates from the RF, IF or baseband domains can be analyzed in the I/Q baseband.

Importing and exporting I/Q signals is useful for various applications:



- Generating and saving I/Q signals in an RF or baseband signal generator or in external software tools to analyze them with the FSW later.  
The FSW supports various I/Q data formats for import.  
For details on formats, see the FSW I/Q Analyzer and I/Q Input user manual.
- Capturing and saving I/Q signals with the FSW to analyze them with the FSW or an external software tool later  
As opposed to storing trace data, which can be averaged or restricted to peak values, I/Q data is stored as it was captured, without further processing. Multi-channel data is not supported.  
The data is stored as complex values in 32-bit floating-point format.  
The file type is determined by the file extension. If no file extension is provided, the file type is assumed to be `.iq.tar`. For `.mat` files, Matlab® v4 is assumed.  
For a detailed description, see the FSW I/Q Analyzer and I/Q Input User Manual.

For example, you can capture I/Q data using the I/Q Analyzer application, if available, and then analyze that data later using the R&S FSW AM/FM/PM Modulation Analysis application.



An application note on converting Rohde & Schwarz I/Q data files is available from the Rohde & Schwarz website:

[1EF85: Converting R&S I/Q data files](#)

The import and export functions are available in the "Save/Recall" menu which is displayed when you select the  "Save" or  "Open" icon in the toolbar.

See the FSW I/Q Analyzer and I/Q Input User Manual.



### Export only in MSRA mode

In MSRA mode, I/Q data can only be exported to other applications; I/Q data cannot be imported to the MSRA primary or any MSRA secondary applications.

## 8 How to perform measurements in the R&S FSW AM/FM/PM Modulation Analysis application

The following step-by-step instructions demonstrate how to perform AM/FM/PM Modulation Analysis with the optional R&S FSW AM/FM/PM Modulation Analysis application.

1. Press [MODE].
2. Select the "AM/FM/PM Modulation Analysis" application.
3. Select "Overview" to display the "Overview" for AM/FM/PM Modulation Analysis.
4. Select "Input/Frontend" > "Frequency" tab to define the input signal's center frequency.
5. Select "Data Acquisition" and define the bandwidth parameters for the input signal: (Note: in MSRA/MSRT mode, define the analysis interval using the same settings.)
  - "Demodulation Bandwidth": the span of the input signal to demodulate
  - "Measurement Time": how long the input signal is measured
  - "Resolution Bandwidth": how precise the signal is demodulated
  - "Capture Offset" (multistandard mode only): the offset of the analysis interval from the start of the capture buffer
6. Optionally, select "Trigger" and define a trigger for data acquisition, for example an offline demodulation trigger to start capturing data only when a useful signal is transmitted.
7. Select "Demod/Display" and select the demodulation displays that are of interest to you (up to 6).  
Arrange them on the display to suit your preferences.
8. Exit the SmartGrid mode and select "Overview" to display the "Overview" again.
9. Select "Demodulation Settings" to define demodulation parameters for each evaluation:
  - Configure the "Squelch" function (on the "Demod" tab) to suppress noise during demodulation.
  - For time domain evaluations, zoom into the areas of interest by defining a zoom area (on the "Demod" tab).
  - For AF evaluations, use special filters to eliminate certain effects of demodulation or to correct pre-emphasized modulated signals (on the "AF Filters" tab).
  - Adapt the diagram scaling to the displayed data (on the "Scaling" tab).
10. Select "Overview" > "Analysis" to use the advanced analysis functions in the demodulation displays.

- Configure a trace to display the average over a series of sweeps (on the "Trace" tab. If necessary, increase the "Sweep Count" in the "Data Acquisition" settings).
  - Configure markers and delta markers to determine deviations and offsets within the demodulated signal (on the "Marker" tab).
  - Use special marker functions to calculate phase noise or an n-dB-down bandwidth (on the "Marker Config" tab).
  - Configure a limit check to detect excessive deviations (on the "Lines" tab).
11. Start a new sweep with the defined settings.  
In multistandard mode, to stop the continuous measurement mode by the Sequencer and perform a single data acquisition:
    - a) Select the Sequencer (🔴) from the toolbar.
    - b) Set the Sequencer state to "Off".
    - c) Press [RUN SINGLE].
  12. Optionally, export the trace data of the demodulated signal to a file.
    - a) In the "Traces" tab of the "Analysis" dialog box, switch to the "Trace Export" tab.
    - b) Select "Export Trace to ASCII File".
    - c) Define a file name and storage location and select "OK".

## 8.1 How to export trace data and numerical results

The measured trace data and numerical measurement results in tables can be exported to an ASCII file. For each sweep point, the measured trace position and value are output.

The file is stored with a `.DAT` or `.CSV` extension. For details on the storage format, see [Chapter 11.7.5, "Reference: ASCII file export format"](#), on page 289.

### To export trace data and table results

1. Select [TRACE] > "Trace Config" > "Trace / Data Export" tab.
2. Select "Export all Traces and all Table Results" to export all available measurement result data for the current application, or select a specific "Trace to Export".
3. Optionally, select "Include Instrument & Measurement Settings" to insert additional information in the export file header.
4. Select "Export Trace to ASCII File".
5. In the file selection dialog box, select the storage location and file name for the export file.
6. If necessary, change the decimal separator for the ASCII export file.
7. Select the data format of the ASCII file.



8. Select "Save" to close the dialog box and export the data to the file.

## 9 Measurement example: demodulating an FM signal

A practical example for a basic Analog Modulation Analysis measurement is provided here. It demonstrates how operating and measurement errors can be avoided using correct configuration settings.

The measurement is performed using the following devices:

- An FSW with application firmware R&S FSW-K7: Analog Modulation Analysis
- A vector signal generator, e.g. R&S SMW



Figure 9-1: Test setup

### Signal generator settings (e.g. R&S SMW):

Frequency:	500 MHz
Level:	-10 dBm
Modulation:	FM
Modulation frequency:	10 kHz
Frequency deviation:	50 kHz

### Procedure:

1. Preset the FSW.
2. Set the center frequency to *500 MHz*.
3. Set the reference level to *0 dBm*.
4. Select [MODE] and then "AM FM PM Analog Demod".

By default, the "FM Time Domain" result display and a "Result Summary" are shown.

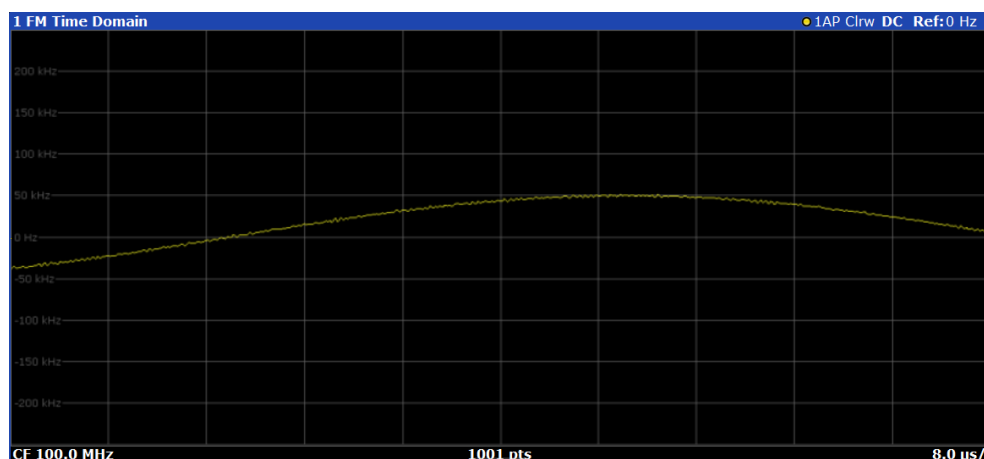

Figure 9-2: Default Analog Modulation Analysis measurement result display

5. Set the measurement time (AQT) to 1 ms to measure 10 periods of the signal.
6. Adjust the y-axis scaling to the measured frequency deviation automatically by selecting "Scale Config" > "Scaling" tab > "AF Auto Scale": "On".

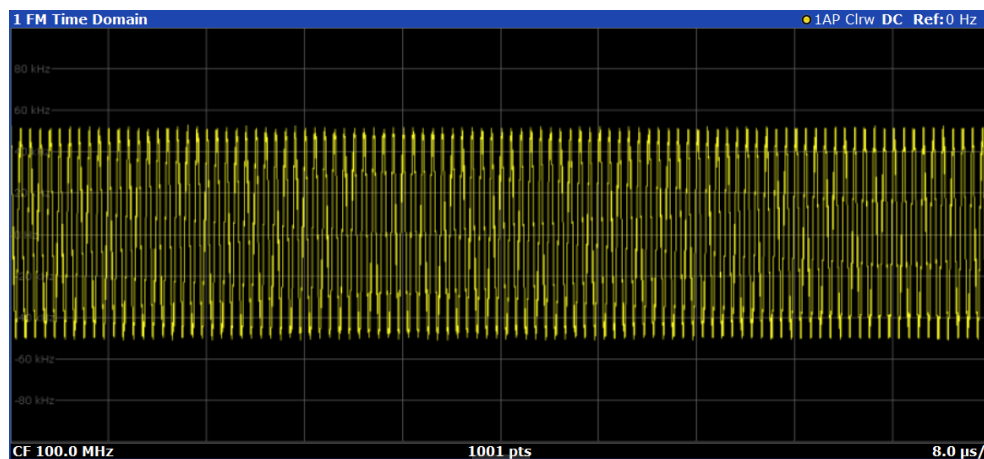

Figure 9-3: Auto-scaled measurement of 10 signal periods (continuous)

7. Display the RF spectrum of the measured signal to determine the required demodulation bandwidth. Select "Display Config" and add an "RF Spectrum" window to the display.

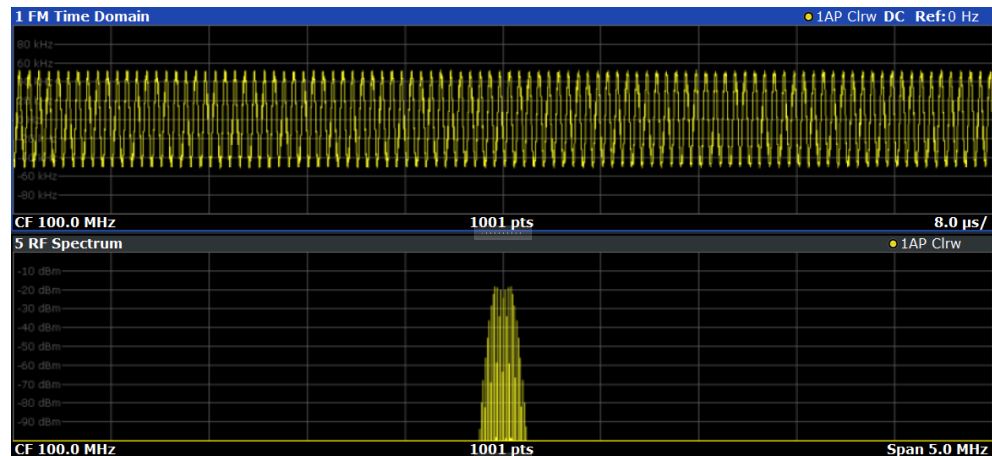

Figure 9-4: RF spectrum of FM signal with default demodulation bandwidth = 5 MHz

8. As you can see in Figure 9-4, the default demodulation bandwidth of 5 MHz is much too large - the actual signal takes up only a small part of the displayed range. That means that any noise or additional signals apart from the FM signal of interest may be included in the measured results. Select "Demod BW" and reduce the value to 200 kHz.

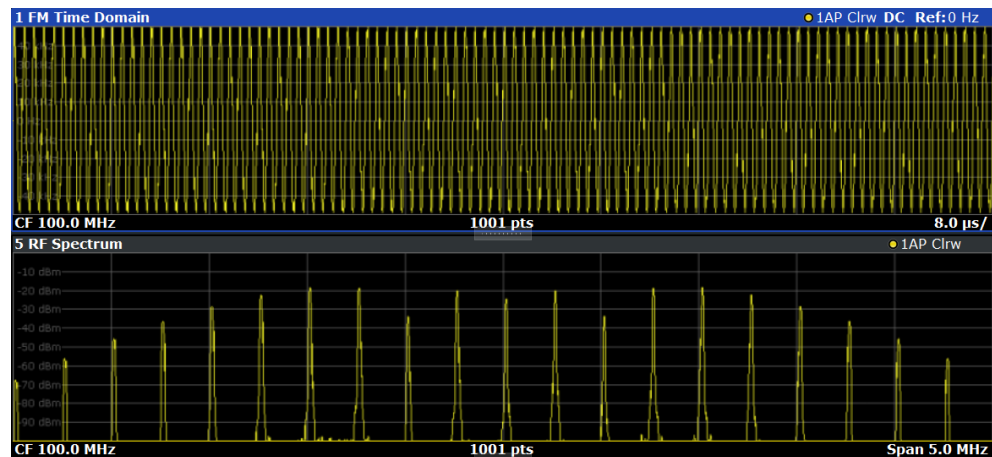

Figure 9-5: RF spectrum with demodulation bandwidth = 200 kHz

The span is automatically reduced to 200 kHz as well, as only the demodulated range can be displayed.

9. Now the RF spectrum shows that part of the FM signal is cut off. The missing signal parts are not included in the calculated results. Increase the demodulation bandwidth to 400 kHz to include the entire signal, but no interfering frequencies.

The span is not automatically increased for the wider DBW since it may be useful to display only a small range from the demodulated bandwidth. However, this means the RF spectrum will still not show the entire signal.

10. Increase the span manually to show the entire demodulated bandwidth:
- Select the "RF Spectrum" window.

- b) Press [SPAN].
- c) Select "Full Span".

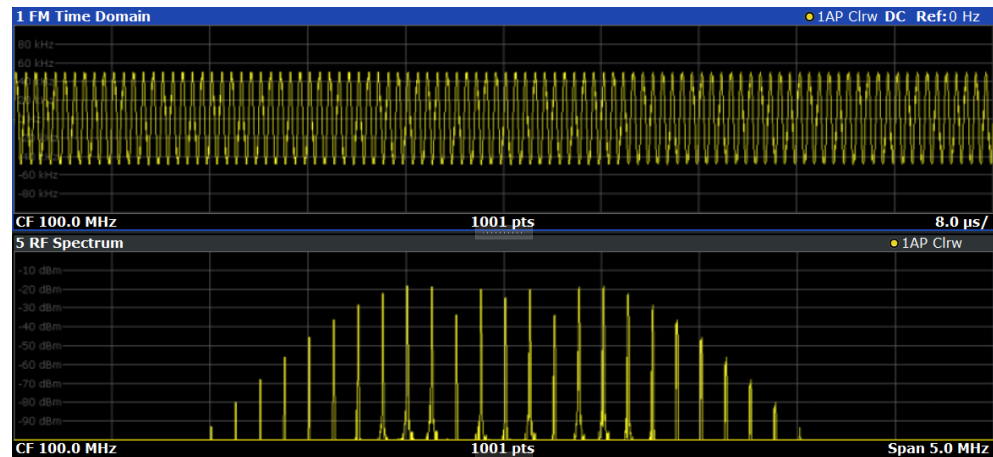

Figure 9-6: RF spectrum with demodulation bandwidth = 400 kHz

11. Once the correct DBW has been determined, you can replace the RF spectrum by the FM spectrum result display to analyze the spectrum of the FM signal. Select "Display Config" and move an "FM Spectrum" window over the "RF Spectrum" window in the display.

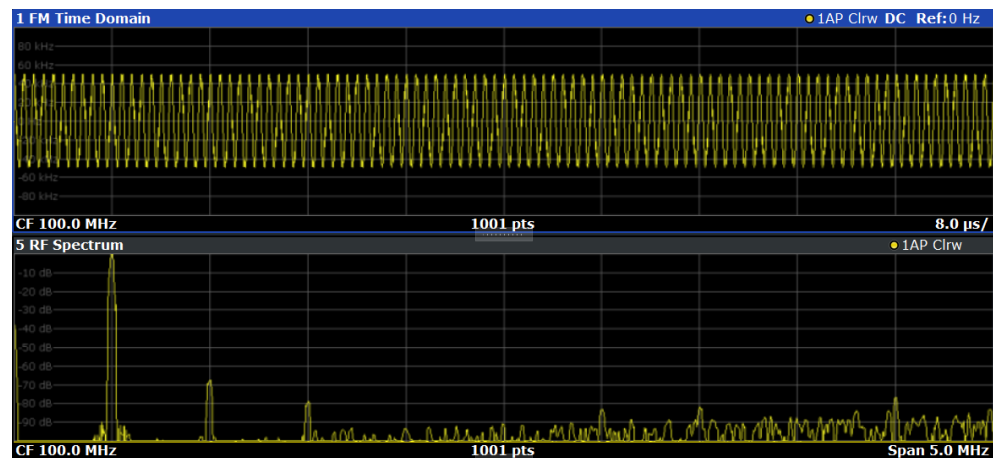
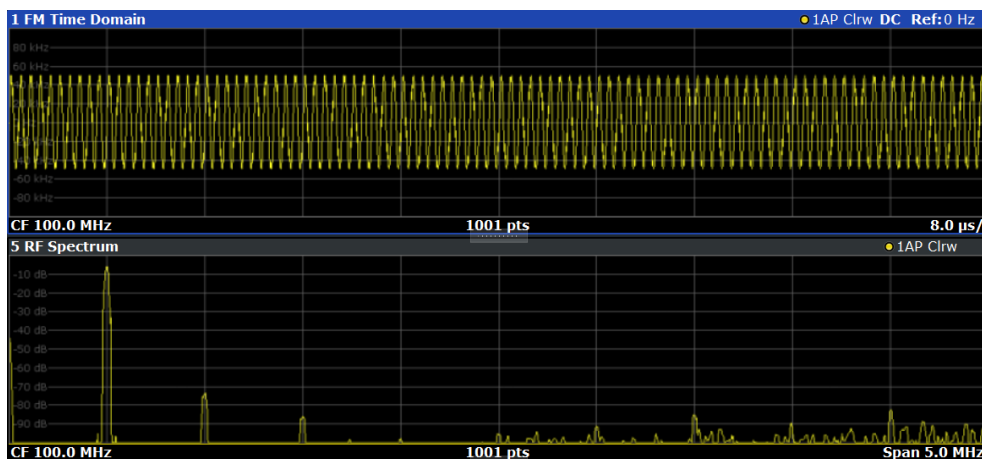

Figure 9-7: FM spectrum and Result Summary including SINAD and THD values

From the FM spectrum, the SINAD and THD are also calculated and displayed in the "Result Summary".

12. Since the "AF Auto Scale" function is enabled, the "FM Spectrum" diagram is scaled according to the current measurement automatically. Each diagram is scaled individually, so that the reference values at the top of the two diagrams can differ (100 kHz in the "FM Time Domain" versus 50 kHz in the "FM Spectrum". However, you can adjust the values manually.
  - a) Select the "FM Spectrum" window to set the focus in it.
  - b) Press [AMPT].

- c) Select "Scale Config".
- d) Disable the "AF Auto Scale" function.
- e) Define the new reference value (at 100% = top of the diagram) as *100 kHz*.



Note that while the reference values at the top of both y-axes are now identical, the reference values indicated in the window title bars are not. This is due to the fact that, by default, in AF time domain displays the reference value is defined at the reference position 50 % (=center of diagram), while in AF frequency domains it is defined at the position 100 % (= top of diagram).

# 10 Optimizing and troubleshooting the measurement

If the results do not meet your expectations, consider the following notes and tips to optimize the measurement.

## Determining the demodulation bandwidth

A frequent cause for measurement errors and false results is an **incorrectly defined demodulation bandwidth (DBW)**.

If the DBW is too large, the actual signal takes up only a small part of the demodulated range. That means that any noise or additional signal parts can be included in the measured results, which are then false.

On the other hand, if the DBW is too small, part of the signal is cut off and thus not included in the calculation of the results.

An easy way to determine the required DBW is to display the RF spectrum of the input signal. If the entire signal is displayed there and takes up most of the diagram width, the DBW is probably appropriate.

This procedure is demonstrated in the measurement example described in [Chapter 9, "Measurement example: demodulating an FM signal"](#), on page 138.

For further recommendations on finding the correct demodulation bandwidth, see [Chapter 4.2, "Demodulation bandwidth"](#), on page 29.

## Adjusting the displayed span

Be aware that the span of the "RF Spectrum" display is not automatically increased for a wider DBW. Sometimes, it can be useful to display only a small range from the demodulated bandwidth. Thus, if the RF spectrum does not show the entire demodulated bandwidth, you must increase the span manually to show the entire signal.

## Determining the SINAD and THD

The signal-to-noise-and-distortion ratio (SINAD) and the total harmonic distortion (THD) of the demodulated signal are a good indicator of the signal quality sent by the DUT. Both values are calculated inside the AF spectrum span and thus only if an AF spectrum window is displayed. If either value deviates strongly from the expected result, make sure that the demodulation bandwidth is defined correctly (see [Determining the demodulation bandwidth](#)).

# 11 Remote commands for AM/FM/PM Modulation Analysis

The commands required to perform measurements in the R&S FSW AM/FM/PM Modulation Analysis application in a remote environment are described here.

It is assumed that the FSW has already been set up for remote control in a network as described in the FSW User Manual.



A programming example at the end of the remote commands description demonstrates the most important commands in a typical application scenario, see [Chapter 11.11, "Programming example"](#), on page 376.



Note that basic tasks that are also performed in the base unit in the same way are not described here. For a description of such tasks, see the FSW User Manual.

In particular:

- Basic instrument configuration, e.g. checking the system configuration, customizing the screen layout, or configuring networks and remote operation
- Using the common status registers



## Status registers

The R&S FSW-K7 option uses the status registers of the base unit (except for the `STATus:QUEStionable:ACPLimit` register).

For a description, see the FSW User Manual.

## General FSW Remote Commands

The application-independent remote commands for general tasks on the FSW are also available for AM/FM/PM Modulation Analysis and are described in the FSW User Manual. In particular:

- Managing settings and results
- Setting up the instrument
- Using the status register

## Commands for emulated PXA models

The FSW supports a subset of the GPIB commands of PXA instruments for Analog Modulation Analysis.

See the FSW User Manual, "Emulating Other Instruments' Commands".





### SCPI Recorder - automating tasks with remote command scripts

The R&S FSW AM/FM/PM Modulation Analysis application also supports the SCPI Recorder functionality.

Using the SCPI Recorder functions, you can create a SCPI script directly on the instrument and then export the script for use on the controller. You can also edit or write a script manually, using a suitable editor on the controller. For manual creation, the instrument supports you by showing the corresponding command syntax for the current setting value.

For details see the "Network and Remote Operation" chapter in the FSW User Manual.

### Channel-specific commands

Apart from a few general commands on the FSW, most commands refer to the currently active channel. Thus, always remember to activate an Analog Modulation Analysis channel before starting a remote program for an Analog Modulation Analysis.

• <a href="#">Introduction</a> .....	145
• <a href="#">Common suffixes</a> .....	150
• <a href="#">Activating analog modulation analysis</a> .....	150
• <a href="#">Configuring the measurement</a> .....	155
• <a href="#">Capturing data and performing sweeps</a> .....	264
• <a href="#">Configuring the result display</a> .....	269
• <a href="#">Retrieving results</a> .....	277
• <a href="#">Analyzing results</a> .....	291
• <a href="#">Importing and exporting I/Q data and results</a> .....	373
• <a href="#">Deprecated commands</a> .....	375
• <a href="#">Programming example</a> .....	376

## 11.1 Introduction

Commands are program messages that a controller (e.g. a PC) sends to the instrument or software. They operate its functions ('setting commands' or 'events') and request information ('query commands'). Some commands can only be used in one way, others work in two ways (setting and query). If not indicated otherwise, the commands can be used for settings and queries.

The syntax of a SCPI command consists of a header and, usually, one or more parameters. To use a command as a query, you have to append a question mark after the last header element, even if the command contains a parameter.

A header contains one or more keywords, separated by a colon. Header and parameters are separated by a "white space" (ASCII code 0 to 9, 11 to 32 decimal, e.g. blank). If there is more than one parameter for a command, they are separated by a comma from one another.

Only the most important characteristics that you need to know when working with SCPI commands are described here. For a more complete description, refer to the user manual of the FSW.



### Remote command examples

Note that some remote command examples mentioned in this general introduction are possibly not supported by this particular application.

## 11.1.1 Conventions used in descriptions

The following conventions are used in the remote command descriptions:

- **Command usage**  
If not specified otherwise, commands can be used both for setting and for querying parameters.  
If a command can be used for setting or querying only, or if it initiates an event, the usage is stated explicitly.
- **Parameter usage**  
If not specified otherwise, a parameter can be used to set a value, and it is the result of a query.  
Parameters required only for setting are indicated as **Setting parameters**.  
Parameters required only to refine a query are indicated as **Query parameters**.  
Parameters that are only returned as the result of a query are indicated as **Return values**.
- **Conformity**  
Commands that are taken from the SCPI standard are indicated as **SCPI confirmed**. All commands used by the FSW follow the SCPI syntax rules.
- **Asynchronous commands**  
A command which does not automatically finish executing before the next command starts executing (overlapping command) is indicated as an **Asynchronous command**.
- **Reset values (\*RST)**  
Default parameter values that are used directly after resetting the instrument (\*RST command) are indicated as **\*RST** values, if available.
- **Default unit**  
The default unit is used for numeric values if no other unit is provided with the parameter.
- **Manual operation**  
If the result of a remote command can also be achieved in manual operation, a link to the description is inserted.

## 11.1.2 Long and short form

The keywords have a long and a short form. You can use either the long or the short form, but no other abbreviations of the keywords.

The short form is emphasized in uppercase letters. Note however, that this emphasis only serves the purpose to distinguish the short from the long form in the manual. For the instrument, the case does not matter.

**Example:**

SENSe:FREQuency:CENTer is the same as SENS:FREQ:CENT.

**11.1.3 Numeric suffixes**

Some keywords have a numeric suffix if the command can be applied to multiple instances of an object. In that case, the suffix selects a particular instance (e.g. a measurement window).

Numeric suffixes are indicated by angular brackets (<n>) next to the keyword.

If you do not quote a suffix for keywords that support one, a 1 is assumed.

**Example:**

DISPlay[:WINDow<1...4>]:ZOOM:STATe enables the zoom in a particular measurement window, selected by the suffix at WINDow.

DISPlay:WINDow4:ZOOM:STATe ON refers to window 4.

**11.1.4 Optional keywords**

Some keywords are optional and are only part of the syntax because of SCPI compliance. You can include them in the header or not.



If an optional keyword has a numeric suffix and you need to use the suffix, you have to include the optional keyword. Otherwise, the suffix of the missing keyword is assumed to be the value 1.

Optional keywords are emphasized with square brackets.

**Example:**

Without a numeric suffix in the optional keyword:

[SENSe:]FREQuency:CENTer is the same as FREQuency:CENTer

With a numeric suffix in the optional keyword:

DISPlay[:WINDow<1...4>]:ZOOM:STATe

DISPlay:ZOOM:STATe ON enables the zoom in window 1 (no suffix).

DISPlay:WINDow4:ZOOM:STATe ON enables the zoom in window 4.

**11.1.5 Alternative keywords**

A vertical stroke indicates alternatives for a specific keyword. You can use both keywords to the same effect.

**Example:**

```
[SENSe:]BANDwidth|BWIDth[:RESolution]
```

In the short form without optional keywords, `BAND 1MHZ` would have the same effect as `BWID 1MHZ`.

## 11.1.6 SCPI parameters

Many commands feature one or more parameters.

If a command supports more than one parameter, they are separated by a comma.

**Example:**

```
LAYout:ADD:WINDow Spectrum,LEFT,MTABLE
```

Parameters can have different forms of values.

- [Numeric values](#)..... 148
- [Boolean](#)..... 149
- [Character data](#)..... 149
- [Character strings](#)..... 150
- [Block data](#)..... 150

### 11.1.6.1 Numeric values

Numeric values can be entered in any form, i.e. with sign, decimal point or exponent. For physical quantities, you can also add the unit. If the unit is missing, the command uses the basic unit.

**Example:**

With unit: `SENSe:FREQuency:CENTer 1GHZ`

Without unit: `SENSe:FREQuency:CENTer 1E9` would also set a frequency of 1 GHz.

Values exceeding the resolution of the instrument are rounded up or down.

If the number you have entered is not supported (e.g. for discrete steps), the command returns an error.

Instead of a number, you can also set numeric values with a text parameter in special cases.

- **MIN/MAX**  
Defines the minimum or maximum numeric value that is supported.
- **DEF**  
Defines the default value.
- **UP/DOWN**  
Increases or decreases the numeric value by one step. The step size depends on the setting. Sometimes, you can customize the step size with a corresponding command.

### Querying numeric values

When you query numeric values, the system returns a number. For physical quantities, it applies the basic unit (e.g. Hz for frequencies). The number of digits after the decimal point depends on the type of numeric value.

#### Example:

Setting: `SENSe:FREQuency:CENTer 1GHZ`

Query: `SENSe:FREQuency:CENTer?` would return `1E9`

Sometimes, numeric values are returned as text.

- `INF/NINF`  
Infinity or negative infinity. Represents the numeric values `9.9E37` or `-9.9E37`.
- `NAN`  
Not a number. Represents the numeric value `9.91E37`. `NAN` is returned if errors occur.

### 11.1.6.2 Boolean

Boolean parameters represent two states. The "on" state (logically true) is represented by `"ON"` or the numeric value `1`. The "off" state (logically untrue) is represented by `"OFF"` or the numeric value `0`.

#### Querying Boolean parameters

When you query Boolean parameters, the system returns either the value `1` (`"ON"`) or the value `0` (`"OFF"`).

#### Example:

Setting: `DISPlay:WINDow:ZOOM:STATe ON`

Query: `DISPlay:WINDow:ZOOM:STATe?` would return `1`

### 11.1.6.3 Character data

Character data follows the syntactic rules of keywords. You can enter text using a short or a long form. For more information, see [Chapter 11.1.2, "Long and short form"](#), on page 146.

#### Querying text parameters

When you query text parameters, the system returns its short form.

#### Example:

Setting: `SENSe:BANDwidth:RESolution:TYPE NORMAl`

Query: `SENSe:BANDwidth:RESolution:TYPE?` would return `NORM`

#### 11.1.6.4 Character strings

Strings are alphanumeric characters. They have to be in straight quotation marks. You can use a single quotation mark ( ' ) or a double quotation mark ( " ).

**Example:**

```
INSTRument:DELeTe 'Spectrum'
```

#### 11.1.6.5 Block data

Block data is a format which is suitable for the transmission of large amounts of data.

The ASCII character # introduces the data block. The next number indicates how many of the following digits describe the length of the data block. The data bytes follow. During the transmission of these data bytes, all end or other control signs are ignored until all bytes are transmitted. #0 specifies a data block of indefinite length. The use of the indefinite format requires an NL^END message to terminate the data block. This format is useful when the length of the transmission is not known or if speed or other considerations prevent segmentation of the data into blocks of definite length.

## 11.2 Common suffixes

In the R&S FSW AM/FM/PM Modulation Analysis application, the following common suffixes are used in remote commands:

*Table 11-1: Common suffixes used in remote commands in the R&S FSW AM/FM/PM Modulation Analysis application*

Suffix	Value range	Description
<m>	1 to 16	Marker
<n>	1 to 6	Window (in the currently selected channel)
<t>	1 to 6	Trace
<li>	1 to 8	Limit line

## 11.3 Activating analog modulation analysis

Analog Modulation Analysis require a special application on the FSW. The measurement is started immediately with the default settings.

INSTRument:CREate:DUPLicate.....	151
INSTRument:CREate:NEWJ.....	151
INSTRument:CREate:REPLace.....	151
INSTRument:DELeTe.....	152
INSTRument:LIST?.....	152

<a href="#">INSTrument:REName</a> .....	154
<a href="#">INSTrument[:SElect]</a> .....	154
<a href="#">SYSTem:PRESet:CHANnel[:EXEC]</a> .....	154

---

### **INSTrument:CREate:DUPLicate**

Duplicates the currently selected channel, i.e creates a new channel of the same type and with the identical measurement settings. The name of the new channel is the same as the copied channel, extended by a consecutive number (e.g. "IQAnalyzer" -> "IQAnalyzer 2").

The channel to be duplicated must be selected first using the `INST:SEL` command.

Is not available if the MSRA / MSRT primary channel is selected.

**Example:**

```
INST:SEL 'IQAnalyzer'
```

```
INST:CRE:DUPL
```

Duplicates the channel named 'IQAnalyzer' and creates a new channel named 'IQAnalyzer2'.

**Usage:** Event

---

### **INSTrument:CREate[:NEW] <ChannelType>, <ChannelName>**

Adds a measurement channel. You can configure up to 10 measurement channels at the same time (depending on available memory).

#### **Parameters:**

<ChannelType> Channel type of the new channel.  
For a list of available channel types, see [INSTrument:LIST?](#) on page 152.

<ChannelName> String containing the name of the channel.  
Note that you cannot assign an existing channel name to a new channel. If you do, an error occurs.

**Example:**

```
INST:CRE SAN, 'Spectrum 2'
```

Adds a spectrum display named "Spectrum 2".

---

### **INSTrument:CREate:REPLace <ChannelName1>, <ChannelType>, <ChannelName2>**

Replaces a channel with another one.

#### **Setting parameters:**

<ChannelName1> String containing the name of the channel you want to replace.

<ChannelType> Channel type of the new channel.  
For a list of available channel types, see [INSTrument:LIST?](#) on page 152.

<ChannelName2> String containing the name of the new channel.  
**Note:** If the specified name for a new channel already exists, the default name, extended by a sequential number, is used for the new channel (see [INSTrument:LIST?](#) on page 152).  
 Channel names can have a maximum of 31 characters, and must be compatible with the Windows conventions for file names. In particular, they must not contain special characters such as ":", "\*", "?".

**Example:** `INST:CRE:REPL 'IQAnalyzer2', IQ, 'IQAnalyzer'`  
 Replaces the channel named "IQAnalyzer2" by a new channel of type "IQ Analyzer" named "IQAnalyzer".

**Usage:** Setting only

### INSTrument:DELeTe <ChannelName>

Deletes a channel.

If you delete the last channel, the default "Spectrum" channel is activated.

#### Setting parameters:

<ChannelName> String containing the name of the channel you want to delete.  
 A channel must exist to delete it.

**Example:** `INST:DEL 'IQAnalyzer4'`  
 Deletes the channel with the name 'IQAnalyzer4'.

**Usage:** Setting only

### INSTrument:LIST?

Queries all active channels. The query is useful to obtain the names of the existing channels, which are required to replace or delete the channels.

#### Return values:

<ChannelType>, <ChannelName> For each channel, the command returns the channel type and channel name (see tables below).  
 Tip: to change the channel name, use the [INSTrument:REName](#) command.

**Example:** `INST:LIST?`  
 Result for 3 channels:  
 'ADEM', 'Analog Demod', 'IQ', 'IQ Analyzer', 'IQ', 'IQ Analyzer2'

**Usage:** Query only



**Table 11-2: Available channel types and default channel names in Signal and Spectrum Analyzer mode**

Application	<ChannelType> parameter	Default Channel name*)
Spectrum	SANALYZER	Spectrum
1xEV-DO BTS (FSW-K84)	BDO	1xEV-DO BTS
1xEV-DO MS (FSW-K85)	MDO	1xEV-DO MS
3GPP FDD BTS (FSW-K72)	BWCD	3G FDD BTS
3GPP FDD UE (FSW-K73)	MWCD	3G FDD UE
802.11ad (FSW-K95)	WIGIG	802.11ad
802.11ay (FSW-K97)	EDMG	802.11ay EDMG
Amplifier Measurements (FSW-K18)	AMPLifier	Amplifier
AM/FM/PM Modulation Analysis (FSW-K7)	ADEM	Analog Demod
Avionics (FSW-K15)	AVIonics	Avionics
Bluetooth (FSW-K8)	BTO	Bluetooth
cdma2000 BTS (FSW-K82)	BC2K	CDMA2000 BTS
cdma2000 MS (FSW-K83)	MC2K	CDMA2000 MS
DOCSIS 3.1 (FSW-K192/193)	DOCSis	DOCSIS 3.1
Fast Spur Search (FSW-K50)	SPUR	Spurious
GSM (FSW-K10)	GSM	GSM
HRP UWB (FSW-K149)	UWB	HRP UWB
I/Q Analyzer	IQ	I/Q Analyzer
LTE (FSW-K10x)	LTE	LTE
Multi-Carrier "Group Delay" (FSW-K17)	MCGD	MC "Group Delay"
NB-IoT (FSW-K106)	NIOT	NB-IoT
Noise (FSW-K30)	NOISE	Noise
5G NR (FSW-K144)	NR5G	5G NR
OFDM VSA (FSW-K96)	OFDMVSA	OFDM VSA
OneWeb (FSW-K201)	OWEB	OneWeb
Phase Noise (FSW-K40)	PNOISE	Phase Noise
Pulse (FSW-K6)	PULSE	Pulse
"Real-Time Spectrum"	RTIM	"Real-Time Spectrum"
TD-SCDMA BTS (FSW-K76)	BTDS	TD-SCDMA BTS
TD-SCDMA UE (FSW-K77)	MTDS	TD-SCDMA UE
*) If the specified name for a new channel already exists, the default name, extended by a sequential number, is used for the new channel.		

Application	<ChannelType> parameter	Default Channel name*)
Transient Analysis (FSW-K60)	TA	Transient Analysis
Verizon 5GTF Measurement Application (V5GTF, FSW-K118)	V5GT	V5GT
VSA (FSW-K70)	DDEM	VSA
WLAN (FSW-K91)	WLAN	WLAN
*) If the specified name for a new channel already exists, the default name, extended by a sequential number, is used for the new channel.		

---

**INSTrument:REName** <ChannelName1>, <ChannelName2>

Renames a channel.

**Setting parameters:**

<ChannelName1> String containing the name of the channel you want to rename.

<ChannelName2> String containing the new channel name.  
 Note that you cannot assign an existing channel name to a new channel. If you do, an error occurs.  
 Channel names can have a maximum of 31 characters, and must be compatible with the Windows conventions for file names. In particular, they must not contain special characters such as ":", "\*", "?".

**Example:** `INST:REN 'IQAnalyzer2', 'IQAnalyzer3'`  
 Renames the channel with the name 'IQAnalyzer2' to 'IQAnalyzer3'.

**Usage:** Setting only

---

**INSTrument[:SElect]** <ChannelType>

Selects the channel type for the current channel.

See also [INSTrument:CREate\[:NEW\]](#) on page 151.

For a list of available channel types, see [INSTrument:LIST?](#) on page 152.

**Parameters:**

<ChannelType> **ADEMod**  
 Optional Analog Modulation Analysis application.

---

**SYSTem:PRESet:CHANnel[:EXEC]**

Restores the default instrument settings in the current channel.

Use `INST:SEL` to select the channel.

<b>Example:</b>	<pre>INST:SEL 'Spectrum2'</pre> Selects the channel for "Spectrum2". <pre>SYST:PRES:CHAN:EXEC</pre> Restores the factory default settings to the "Spectrum2" channel.
<b>Usage:</b>	Event
<b>Manual operation:</b>	See <a href="#">"Preset Channel"</a> on page 39

## 11.4 Configuring the measurement

The following remote commands are required to configure an Analog Modulation Analysis.

### Specific commands:

• <a href="#">Managing standard settings</a> .....	155
• <a href="#">Configuring the input</a> .....	156
• <a href="#">Configuring the output</a> .....	211
• <a href="#">Digital I/Q 40G streaming output commands</a> .....	213
• <a href="#">Frequency settings</a> .....	215
• <a href="#">Configuring the vertical axis (amplitude, scaling)</a> .....	216
• <a href="#">Configuring data acquisition</a> .....	225
• <a href="#">Triggering</a> .....	230
• <a href="#">Configuring demodulation</a> .....	241
• <a href="#">Adjusting settings automatically</a> .....	260

### 11.4.1 Managing standard settings

You can configure the R&S FSW AM/FM/PM Modulation Analysis application using predefined standard settings, allowing for quick and easy configuration for commonly performed measurements.

For details, see [Chapter 5.2, "Configuration according to standards"](#), on page 39.

For an overview of predefined standards and settings, see [Chapter A, "Predefined standards and settings"](#), on page 379.

<a href="#">[SENSe:]ADEMod:PRESet[:STANdard]</a> .....	155
<a href="#">[SENSe:]ADEMod:PRESet:RESTore</a> .....	156
<a href="#">[SENSe:]ADEMod:PRESet:STORe</a> .....	156

---

#### **[SENSe:]ADEMod:PRESet[:STANdard]** <Standard>

Loads a measurement configuration.

Standard definitions are stored in an xml file. The default directory for Analog Modulation Analysis standards is C:

```
\R_S\INSTR\USER\predefined\AdemodPredefined.
```

**Parameters:**

<Standard> String containing the file name.  
If you have stored the file in a subdirectory of the directory mentioned above, you have to include the relative path to the file.

**Manual operation:** See "[Load Standard](#)" on page 40

**[SENSe:]ADEMod:PRESet:REStore**

**Manual operation:** See "[Restore Standard Files](#)" on page 40

**[SENSe:]ADEMod:PRESet:StORe** <Standard>

Saves the current Analog Modulation Analysis measurement configuration.

Standard definitions are stored in an XML file. The default directory for Analog Modulation Analysis standards is C :

\R\_S\INSTR\USER\predefined\AdemodPredefined.

**Parameters:**

<Standard> String containing the file name.  
You can save the file in a subdirectory of the directory mentioned above. In that case, you have to include the relative path to the file.

**Manual operation:** See "[Save Standard](#)" on page 40

## 11.4.2 Configuring the input

- [RF input](#)..... 156
- [Configuring file input](#)..... 160
- [Using external mixers](#)..... 162
- [Configuring the 2 GHz / 5 GHz bandwidth extension \(FSW-B2000/B5000\)](#)..... 177
- [Configuring input via the optional Analog Baseband interface](#)..... 182
- [Configuring digital I/Q input and output](#)..... 185
- [Setting up probes](#)..... 187
- [Working with power sensors](#)..... 192
- [External generator control](#)..... 202

### 11.4.2.1 RF input

- [INPut:ATTenuation:PROTection:RESet](#)..... 157
- [INPut:CONNector](#)..... 157
- [INPut:COUPLing](#)..... 157
- [INPut:DPATH](#)..... 158
- [INPut:FILTer:HPASs\[:STATe\]](#)..... 158
- [INPut:FILTer:YIG\[:STATe\]](#)..... 158

INPut:IMPedance.....	159
INPut:SElect.....	159
INPut:TYPE.....	160

---

### INPut:ATTenuation:PROTection:RESet

Resets the attenuator and reconnects the RF input with the input mixer for the FSW after an overload condition occurred and the protection mechanism intervened. The error status bit (bit 3 in the `STAT:QUES:POW` status register) and the `INPUT OVLD` message in the status bar are cleared.

(For details on the status register see the FSW base unit user manual).

The command works only if the overload condition has been eliminated first.

**Example:** `INP:ATT:PROT:RES`

---

### INPut:CONNector <ConnType>

Determines which connector the input for the measurement is taken from.

#### Parameters:

<ConnType>

#### RF

RF input connector

#### AIQI

Analog Baseband I connector

This setting is only available if the "Analog Baseband" interface (FSW-B71) is installed and active for input. It is not available for the FSW67 or FSW85.

For more information on the "Analog Baseband" interface (FSW-B71), see the FSW I/Q Analyzer and I/Q Input User Manual.

#### RFPRobe

Active RF probe

\*RST: RF

**Example:** `INP:CONN RF`  
Selects input from the RF input connector.

**Manual operation:** See "[Input Connector](#)" on page 44

---

### INPut:COUPling <CouplingType>

Selects the coupling type of the RF input.

#### Parameters:

<CouplingType>

AC | DC

#### AC

AC coupling

#### DC

DC coupling

\*RST: AC

**Example:** INP:COUP DC

**Manual operation:** See ["Input Coupling"](#) on page 43

#### INPut:DPATH <DirectPath>

Enables or disables the use of the direct path for frequencies close to 0 Hz.

##### Parameters:

<DirectPath> AUTO | OFF

##### **AUTO | 1**

(Default) the direct path is used automatically for frequencies close to 0 Hz.

##### **OFF | 0**

The analog mixer path is always used.

**Example:** INP:DPAT OFF

**Manual operation:** See ["Direct Path"](#) on page 43

#### INPut:FILTer:HPASs[:STATe] <State>

Activates an additional internal high-pass filter for RF input signals from 1 GHz to 3 GHz. This filter is used to remove the harmonics of the FSW to measure the harmonics for a DUT, for example.

Requires an additional high-pass filter hardware option.

(Note: for RF input signals outside the specified range, the high-pass filter has no effect. For signals with a frequency of approximately 4 GHz upwards, the harmonics are suppressed sufficiently by the YIG-preselector, if available.)

##### Parameters:

<State> ON | OFF | 0 | 1

##### **OFF | 0**

Switches the function off

##### **ON | 1**

Switches the function on

\*RST: 0

**Example:** INP:FILT:HPAS ON

Turns on the filter.

**Manual operation:** See ["High Pass Filter 1 to 3 GHz"](#) on page 44

#### INPut:FILTer:YIG[:STATe] <State>

Enables or disables the YIG filter.

##### Parameters:

<State> ON | OFF | 0 | 1

**Example:** `INP:FILT:YIG OFF`  
Deactivates the YIG-preselector.

**Manual operation:** See "[YIG-Preselector](#)" on page 44

#### **INPut:IMPedance** <Impedance>

Selects the nominal input impedance of the RF input. In some applications, only 50 Ω are supported.

The command is not available for measurements with the optional "Digital Baseband" interface.

#### **Parameters:**

<Impedance>            50 | 75  
\*RST:                    50 Ω  
Default unit: OHM

**Example:** `INP:IMP 75`

**Manual operation:** See "[Impedance](#)" on page 43  
See "[Unit](#)" on page 47

#### **INPut:SElect** <Source>

Selects the signal source for measurements, i.e. it defines which connector is used to input data to the FSW.

If no additional input options are installed, only RF input is supported.

For FSW85 models with two RF input connectors, you must select the input connector to configure first using `INPut:TYPE`.

Tip: The I/Q data to be analyzed for AM/FM/PM Modulation Analysis cannot only be measured by the R&S FSW AM/FM/PM Modulation Analysis application itself, it can also be imported to the application, provided it has the correct format. Furthermore, the analyzed I/Q data from the R&S FSW AM/FM/PM Modulation Analysis application can be exported for further analysis in external applications.

For details, see the FSW I/Q Analyzer and I/Q Input User Manual.

#### **Parameters:**

<Source>                **RF**  
Radio Frequency ("RF INPUT" connector)  
**FIQ**  
I/Q data file  
Not available for Input2.  
**DIQ**  
Digital IQ data (only available with optional "Digital Baseband" interface)  
For details on I/Q input see the FSW I/Q Analyzer User Manual.  
Not available for Input2.

**AIQ**

Analog Baseband signal (only available with optional "Analog Baseband" interface)

Not available for Input2.

\*RST: RF

**Example:**

```
INP:TYPE INP1
```

For FSW85 models with two RF input connectors: selects the 1.00 mm RF input connector for configuration.

```
INP:SEL RF
```

**Manual operation:** See ["Radio Frequency State"](#) on page 43

**INPut:TYPE** <Input>

The command selects the input path.

**Parameters:**

<Input>

**INPUT1**

Selects RF input 1.

1 mm [RF Input] connector

**INPUT2**

Selects RF input 2.

For FSW85 models with two RF input connectors:

1.85 mm [RF2 Input] connector

For all other models: not available

\*RST: INPUT1

**Example:**

```
//Select input path
```

```
INP:TYPE INPUT1
```

**Manual operation:** See ["Radio Frequency State"](#) on page 43

**11.4.2.2 Configuring file input**

The following commands are required to define input from a file.

Useful commands for configuring file input described elsewhere:

- [INPut:SELeCt](#) on page 159

**Remote commands exclusive to configuring input from files:**

<a href="#">INPut:FILE:PATH</a> .....	160
<a href="#">MMEMory:LOAD:IQ:STReam</a> .....	161
<a href="#">MMEMory:LOAD:IQ:STReam:AUTO</a> .....	162
<a href="#">MMEMory:LOAD:IQ:STReam:LIST?</a> .....	162
<a href="#">TRACe:IQ:FILE:REPetition:COUNT</a> .....	162

**INPut:FILE:PATH** <FileName>[, <AnalysisBW>]

Selects the I/Q data file to be used as input for further measurements.



The I/Q data file must be in one of the following supported formats:

- .iq.tar
- .iqw
- .csv
- .mat
- .wv
- .aid

Only a single data stream or channel can be used as input, even if multiple streams or channels are stored in the file.

For some file formats that do not provide the sample rate and measurement time or record length, you must define these parameters manually. Otherwise the traces are not visible in the result displays.

**Parameters:**

<FileName> String containing the path and name of the source file.  
The file type is determined by the file extension. If no file extension is provided, the file type is assumed to be .iq.tar.  
For .mat files, Matlab® v4 is assumed.

<AnalysisBW> Optionally: The analysis bandwidth to be used by the measurement. The bandwidth must be smaller than or equal to the bandwidth of the data that was stored in the file.  
Default unit: HZ

**Example:** INP:FILE:PATH 'C:\R\_S\Instr\user\data.iq.tar'  
Uses I/Q data from the specified file as input.

**Example:**

```
//Load an IQW file
INP:SEL:FIQ
INP:FILE:PATH 'C:\R_S\Instr\user\data.iqw'
//Define the sample rate
TRAC:IQ:SRAT 10MHz
//Define the measurement time
SENSe:SWEp:TIME 0.001001
//Start the measurement
INIT:IMM
```

---

**MMEMory:LOAD:IQ:STReam <Channel>**

Only available for files that contain more than one data stream from multiple channels: selects the data stream to be used as input for the currently selected channel.

Automatic mode ([MMEMory:LOAD:IQ:STReam:AUTO](#)) is set to OFF.

**Parameters:**

<Channel> String containing the channel name.

**Example:**

```
MMEM:LOAD:IQ:STR?
//Result: 'Channel1','Channel2'
MMEM:LOAD:IQ:STR 'Channel2'
```

**MMEMory:LOAD:IQ:STReam:AUTO** <State>

Only available for files that contain more than one data stream from multiple channels: automatically defines which data stream in the file is used as input for the channel.

**Parameters:**

<State> ON | OFF | 0 | 1

**OFF | 0**

The data stream specified by `MMEMory:LOAD:IQ:STReam` is used as input for the channel.

**ON | 1**

The first data stream in the file is used as input for the channel. Applications that support multiple data streams use the first data stream in the file for the first input stream, the second for the second stream etc.

\*RST: 1

**MMEMory:LOAD:IQ:STReam:LIST?**

Returns the available channels in the currently loaded input file.

**Example:** `MMEM:LOAD:IQ:STR?`  
`//Result: 'Channel1', 'Channel2'`

**Usage:** Query only

**TRACe:IQ:FILE:REPetition:COUNT** <RepetitionCount>

Determines how often the data stream is repeatedly copied in the I/Q data memory. If the available memory is not sufficient for the specified number of repetitions, the largest possible number of complete data streams is used.

**Parameters:**

<RepetitionCount> integer

**Example:** `TRAC:IQ:FILE:REP:COUN 3`

**11.4.2.3 Using external mixers**

The commands required to work with external mixers in a remote environment are described here. Note that these commands require the FSW to have an external mixer option installed and an external mixer to be connected to the FSW.

In MSRA / MSRT mode, external mixers are not supported.

For details on working with external mixers see the FSW User Manual.

- [Basic settings](#)..... 163
- [Mixer settings](#)..... 165
- [Conversion loss table settings](#)..... 171
- [Programming example: working with an external mixer](#)..... 175

## Basic settings

The basic settings concern general usage of an external mixer.

[SENSe:]MIXer<x>[:STATe].....	163
[SENSe:]MIXer<x>:BIAS:HIGH.....	163
[SENSe:]MIXer<x>:BIAS[:LOW].....	163
[SENSe:]MIXer<x>:LOPower.....	164
[SENSe:]MIXer<x>:SIGNal.....	164
[SENSe:]MIXer<x>:THReshold.....	164

---

### [SENSe:]MIXer<x>[:STATe] <State>

Activates or deactivates the use of a connected external mixer as input for the measurement. This command is only available if the optional External Mixer is installed and an external mixer is connected.

#### Suffix:

<x>                    1..n  
                         irrelevant

#### Parameters:

<State>                ON | OFF | 1 | 0  
                         \*RST:        0

**Example:**            MIX ON

---

### [SENSe:]MIXer<x>:BIAS:HIGH <BiasSetting>

Defines the bias current for the high (last) range.

Is only available if the external mixer is active (see [SENSe:]MIXer<x>[:STATe] on page 163).

#### Suffix:

<x>                    1..n  
                         irrelevant

#### Parameters:

<BiasSetting>        \*RST:        0.0 A  
                         Default unit: A

---

### [SENSe:]MIXer<x>:BIAS[:LOW] <BiasSetting>

Defines the bias current for the low (first) range.

Is only available if the external mixer is active (see [SENSe:]MIXer<x>[:STATe] on page 163).

#### Suffix:

<x>                    1..n  
                         irrelevant

**Parameters:**

<BiasSetting>            \*RST:        0.0 A  
                                   Default unit: A

**[SENSe:]MIXer<x>:LOPower <Level>**

Specifies the LO level of the external mixer's LO port.

**Suffix:**

<x>                        1..n  
                                   irrelevant

**Parameters:**

<Level>                    Range:        13.0 dBm to 17.0 dBm  
                                   Increment: 0.1 dB  
                                   \*RST:        15.5 dBm  
                                   Default unit: DBM

**Example:**                MIX:LOP 16.0dBm

**[SENSe:]MIXer<x>:SIGNal <State>**

Specifies whether automatic signal detection is active or not.

Note that automatic signal identification is only available for measurements that perform frequency sweeps (not in vector signal analysis or the I/Q Analyzer, for instance).

**Suffix:**

<x>                        1..n  
                                   irrelevant

**Parameters:**

<State>                    OFF | ON | AUTO | ALL  
**OFF | ON | AUTO | ALL**  
**OFF**  
 No automatic signal detection is active.  
**ON**  
 Automatic signal detection (Signal ID) is active.  
**AUTO**  
 Automatic signal detection (Auto ID) is active.  
**ALL**  
 Both automatic signal detection functions (Signal ID+Auto ID) are active.  
                                   \*RST:        OFF

**[SENSe:]MIXer<x>:THReshold <Value>**

Defines the maximum permissible level difference between test sweep and reference sweep to be corrected during automatic comparison (see [\[SENSe:\]MIXer<x>:SIGNal](#) on page 164).

**Suffix:**

<x> 1..n  
irrelevant

**Parameters:**

<Value> <numeric value>  
Range: 0.1 dB to 100 dB  
\*RST: 10 dB  
Default unit: DB

**Example:** MIX:PORT 3

**Mixer settings**

The following commands are required to configure the band and specific mixer settings.

[SENSe:]MIXer<x>:FREQuency:HANdOver.....	165
[SENSe:]MIXer<x>:FREQuency:STARt.....	166
[SENSe:]MIXer<x>:FREQuency:STOP.....	166
[SENSe:]MIXer<x>:HARMonic:BAND:PRESet.....	166
[SENSe:]MIXer<x>:HARMonic:BAND.....	166
[SENSe:]MIXer<x>:HARMonic:HIGH:STATe.....	167
[SENSe:]MIXer<x>:HARMonic:HIGH[:VALue].....	167
[SENSe:]MIXer<x>:HARMonic:TYPE.....	168
[SENSe:]MIXer<x>:HARMonic[:LOW].....	168
[SENSe:]MIXer<x>:IF?.....	168
[SENSe:]MIXer<x>:LOSS:HIGH.....	169
[SENSe:]MIXer<x>:LOSS:TABLE:HIGH.....	169
[SENSe:]MIXer<x>:LOSS:TABLE[:LOW].....	169
[SENSe:]MIXer<x>:LOSS[:LOW].....	170
[SENSe:]MIXer<x>:PORTs.....	170
[SENSe:]MIXer<x>:RFOVerrange[:STATe].....	170

**[SENSe:]MIXer<x>:FREQuency:HANdOver <Frequency>**

Defines the frequency at which the mixer switches from one range to the next (if two different ranges are selected). The handover frequency for each band can be selected freely within the overlapping frequency range.

Is only available if the external mixer is active (see [SENSe:]MIXer<x>[:STATe] on page 163).

**Suffix:**

<x> 1..n  
irrelevant

**Parameters:**

<Frequency> Default unit: HZ

**Example:**           MIX ON  
 Activates the external mixer.  
 MIX:FREQ:HAND 78.0299GHz  
 Sets the handover frequency to 78.0299 GHz.

#### [SENSe:]MIXer<x>:FREQuency:STARt

Sets or queries the frequency at which the external mixer band starts.

**Suffix:**

<x>                   1..n  
 irrelevant

**Example:**           MIX:FREQ:STAR?  
 Queries the start frequency of the band.

#### [SENSe:]MIXer<x>:FREQuency:STOP

Sets or queries the frequency at which the external mixer band stops.

**Suffix:**

<x>                   1..n  
 irrelevant

**Example:**           MIX:FREQ:STOP?  
 Queries the stop frequency of the band.

#### [SENSe:]MIXer<x>:HARMonic:BAND:PRESet

Restores the preset frequency ranges for the selected standard waveguide band.

**Note:** Changes to the band and mixer settings are maintained even after using the [PRESET] function. Use this command to restore the predefined band ranges.

**Suffix:**

<x>                   1..n  
 irrelevant

**Example:**           MIX:HARM:BAND:PRES  
 Presets the selected waveguide band.

#### [SENSe:]MIXer<x>:HARMonic:BAND <Band>

Selects the external mixer band. The query returns the currently selected band.

Is only available if the external mixer is active (see [SENSe:]MIXer<x>[:STATe] on page 163).

**Suffix:**

<x>                   1..n  
 irrelevant

**Parameters:**

<Band> KA | Q | U | V | E | W | F | D | G | Y | J | USER  
 Standard waveguide band or user-defined band.

**Table 11-3: Frequency ranges for pre-defined bands**

Band	Frequency start [GHz]	Frequency stop [GHz]
KA (A) *)	26.5	40.0
Q	33.0	50.0
U	40.0	60.0
V	50.0	75.0
E	60.0	90.0
W	75.0	110.0
F	90.0	140.0
D	110.0	170.0
G	140.0	220.0
J	220.0	325.0
Y	325.0	500.0
USER	32.18 (default)	68.22 (default)

\*) The band formerly referred to as "A" is now named "KA".

**[SENSe:]MIXer<x>:HARMonic:HIGH:STATe <State>**

Specifies whether a second (high) harmonic is to be used to cover the band's frequency range.

**Suffix:**

<x> 1..n

**Parameters:**

<State> ON | OFF  
 \*RST: ON

**Example:** MIX:HARM:HIGH:STAT ON

**[SENSe:]MIXer<x>:HARMonic:HIGH[:VALue] <HarmOrder>**

Specifies the harmonic order to be used for the high (second) range.

**Suffix:**

<x> 1..n  
 irrelevant

**Parameters:**

<HarmOrder>            Range:        2 to 128 (USER band); for other bands: see band definition

**Example:**

```
MIX:HARM:HIGH:STAT ON
MIX:HARM:HIGH 3
```

**[SENSe:]MIXer<x>:HARMonic:TYPE <OddEven>**

Specifies whether the harmonic order to be used should be odd, even, or both.

Which harmonics are supported depends on the mixer type.

**Suffix:**

<x>                        1..n  
                              irrelevant

**Parameters:**

<OddEven>                ODD | EVEN | EODD  
                              **ODD | EVEN | EODD**  
\*RST:                      EVEN

**Example:**

```
MIX:HARM:TYPE ODD
```

**[SENSe:]MIXer<x>:HARMonic[:LOW] <HarmOrder>**

Specifies the harmonic order to be used for the low (first) range.

**Suffix:**

<x>                        1..n  
                              irrelevant

**Parameters:**

<HarmOrder>            Range:        2 to 128 (USER band); for other bands: see band definition  
                              \*RST:        2 (for band F)

**Example:**

```
MIX:HARM 3
```

**[SENSe:]MIXer<x>:IF?**

Queries the intermediate frequency currently used by the external mixer.

**Suffix:**

<x>                        1..n  
                              irrelevant

**Example:**

```
MIX:IF?
```

**Example:**

See "[Programming example: working with an external mixer](#)" on page 175.

**Usage:**

Query only



---

**[SENSe:]MIXer<x>:LOSS:HIGH <Average>**

Defines the average conversion loss to be used for the entire high (second) range.

**Suffix:**

<x>                    1..n  
                         irrelevant

**Parameters:**

<Average>            Range:        0 to 100  
                         \*RST:        24.0 dB  
                         Default unit: dB

**Example:**            MIX:LOSS:HIGH 20dB

---

**[SENSe:]MIXer<x>:LOSS:TABLE:HIGH <FileName>**

Defines the conversion loss table to be used for the high (second) range.

**Suffix:**

<x>                    1..n  
                         irrelevant

**Parameters:**

<FileName>            String containing the path and name of the file, or the serial number of the external mixer whose file is required. The FSW automatically selects the correct cvl file for the current IF. As an alternative, you can also select a user-defined conversion loss table (.acl file).

**Example:**

```
MIX:LOSS:TABL:HIGH '101567'
MIX:LOSS:TABL:HIGH?
//Result for installed B5000, bw<= 4.4 GHz: 101567_B5000_2G8.B5G:
//'101567_MAG_6_B5000_2G8.B5G'
//Result for installed B5000, bw> 4.4 GHz: 101567_B5000_2G8.B5G:
//'101567_MAG_6_B5000_3G5.B5G'
//Result for installed B2001 and bw> 80 MHz:
//'101567_MAG_6_B1200_B2001.B2G'
//Result for installed B2001 and bw<= 80 MHz:
//'101567_MAG_6.ACL'
```

---

**[SENSe:]MIXer<x>:LOSS:TABLE[:LOW] <FileName>**

Defines the file name of the conversion loss table to be used for the low (first) range.

**Suffix:**

<x>                    1..n  
                         irrelevant

**Parameters:**

<FileName> String containing the path and name of the file, or the serial number of the external mixer whose file is required. The FSW automatically selects the correct cvl file for the current IF. As an alternative, you can also select a user-defined conversion loss table (.acl file).

**Example:**

```
MIX:LOSS:TABL '101567'
MIX:LOSS:TABL?
//Result:
'101567_MAG_6_B5000_3G5.B5G'
```

**[SENSe:]MIXer<x>:LOSS[:LOW] <Average>**

Defines the average conversion loss to be used for the entire low (first) range.

**Suffix:**

<x> 1..n  
irrelevant

**Parameters:**

<Average> Range: 0 to 100  
\*RST: 24.0 dB  
Default unit: dB

**Example:**

```
MIX:LOSS 20dB
```

**[SENSe:]MIXer<x>:PORTs <PortType>**

Selects the mixer type.

**Suffix:**

<x> 1..n  
irrelevant

**Parameters:**

<PortType> **2 | 3**  
**2**  
Two-port mixer.  
**3**  
Three-port mixer.  
\*RST: 2

**Example:**

```
MIX:PORT 3
```

**[SENSe:]MIXer<x>:RFOVerrange[:STATe] <State>**

If enabled, the band limits are extended beyond "RF Start" and "RF Stop" due to the capabilities of the used harmonics.

**Suffix:**

<x> 1..n  
irrelevant

**Parameters:**

<State> ON | OFF | 1 | 0  
\*RST: 0

**Conversion loss table settings**

The following settings are required to configure and manage conversion loss tables.

[SENSe:]CORRection:CVL:BAND.....	171
[SENSe:]CORRection:CVL:BIAS.....	171
[SENSe:]CORRection:CVL:CATalog?.....	172
[SENSe:]CORRection:CVL:CLEar.....	172
[SENSe:]CORRection:CVL:COMMeNt.....	172
[SENSe:]CORRection:CVL:DATA.....	173
[SENSe:]CORRection:CVL:HARMonic.....	173
[SENSe:]CORRection:CVL:MIXer.....	173
[SENSe:]CORRection:CVL:PORTs.....	174
[SENSe:]CORRection:CVL:SElect.....	174
[SENSe:]CORRection:CVL:SNUMber.....	174

**[SENSe:]CORRection:CVL:BAND <Band>**

Defines the waveguide band for which the conversion loss table is to be used. This setting is checked against the current mixer setting before the table can be assigned to the range.

Before this command can be performed, the conversion loss table must be selected (see [SENSe:]CORRection:CVL:SElect on page 174).

Is only available with option B21 (External Mixer) installed.

**Parameters:**

<Band> K | KA | Q | U | V | E | W | F | D | G | Y | J | USER  
Standard waveguide band or user-defined band.  
For a definition of the frequency range for the pre-defined bands, see [Table 11-3](#).  
\*RST: F (90 GHz - 140 GHz)

**Example:**

```
CORR:CVL:SEL 'LOSS_TAB_4'
Selects the conversion loss table.
CORR:CVL:BAND KA
Sets the band to KA (26.5 GHz - 40 GHz).
```

**[SENSe:]CORRection:CVL:BIAS <BiasSetting>**

Defines the bias setting to be used with the conversion loss table.



**Example:**           CORR:CVL:SEL 'LOSS\_TAB\_4'  
                           Selects the conversion loss table.  
                           CORR:CVL:COMM 'Conversion loss table for  
                           FS\_Z60'

---

#### [SENSe:]CORRection:CVL:DATA {<Freq>, <Level>}...

Defines the reference values of the selected conversion loss tables. The values are entered as a set of frequency/level pairs. You can define a maximum of 500 frequency/level pairs. Before this command can be performed, you must select the conversion loss table (see [SENSe:]CORRection:CVL:SELEct on page 174).

Is only available with option B21 (External Mixer) installed.

#### Parameters:

<Freq>                The frequencies have to be sent in ascending order.  
                           Default unit: HZ

<Level>               Default unit: DB

**Example:**           CORR:CVL:SEL 'LOSS\_TAB\_4'  
                           Selects the conversion loss table.  
                           CORR:CVL:DATA 1MHZ, -30DB, 2MHZ, -40DB

---

#### [SENSe:]CORRection:CVL:HARMonic <HarmOrder>

Defines the harmonic order for which the conversion loss table is to be used. This setting is checked against the current mixer setting before the table can be assigned to the range.

Before this command can be performed, the conversion loss table must be selected (see [SENSe:]CORRection:CVL:SELEct on page 174).

Is only available with option B21 (External Mixer) installed.

#### Parameters:

<HarmOrder>         Range:     2 to 65

**Example:**           CORR:CVL:SEL 'LOSS\_TAB\_4'  
                           Selects the conversion loss table.  
                           CORR:CVL:HARM 3

---

#### [SENSe:]CORRection:CVL:MIXer <Type>

Defines the mixer name in the conversion loss table. This setting is checked against the current mixer setting before the table can be assigned to the range.

Before this command can be performed, the conversion loss table must be selected (see [SENSe:]CORRection:CVL:SELEct on page 174).

Is only available with option B21 (External Mixer) installed.

**Parameters:**

<Type> string  
Name of mixer with a maximum of 16 characters

**Example:**

```
CORR:CVL:SEL 'LOSS_TAB_4'
Selects the conversion loss table.
CORR:CVL:MIX 'FS_Z60'
```

**[SENSe:]CORRection:CVL:PORTs <PortType>**

Defines the mixer type in the conversion loss table. This setting is checked against the current mixer setting before the table can be assigned to the range.

Before this command can be performed, the conversion loss table must be selected (see [\[SENSe:\]CORRection:CVL:SElect](#) on page 174).

Is only available with option B21 (External Mixer) installed.

**Parameters:**

<PortType> 2 | 3  
\*RST: 2

**Example:**

```
CORR:CVL:SEL 'LOSS_TAB_4'
Selects the conversion loss table.
CORR:CVL:PORT 3
```

**[SENSe:]CORRection:CVL:SElect <FileName>**

Selects the conversion loss table with the specified file name. If <file\_name> is not available, a new conversion loss table is created.

Is only available with option B21 (External Mixer) installed.

**Parameters:**

<FileName> String containing the path and name of the file.

**Example:**

```
CORR:CVL:SEL 'LOSS_TAB_4'
```

**[SENSe:]CORRection:CVL:SNUMber <SerialNo>**

Defines the serial number of the mixer for which the conversion loss table is to be used. This setting is checked against the current mixer setting before the table can be assigned to the range.

Before this command can be performed, the conversion loss table must be selected (see [\[SENSe:\]CORRection:CVL:SElect](#) on page 174).

Is only available with option B21 (External Mixer) installed.

**Parameters:**

<SerialNo> Serial number with a maximum of 16 characters

**Example:**           CORR:CVL:SEL 'LOSS\_TAB\_4'  
                           Selects the conversion loss table.  
                           CORR:CVL:MIX '123.4567'

### Programming example: working with an external mixer

This example demonstrates how to work with an external mixer in a remote environment. It is performed in the Spectrum application in the default layout configuration. Note that without a real input signal and connected mixer, this measurement will not return useful results.

```
//-----Preparing the instrument -----
//Reset the instrument
*RST
//Activate the use of the connected external mixer.
SENS:MIX ON
//----- Configuring basic mixer behavior -----
//Set the LO level of the mixer's LO port to 15 dBm.
SENS:MIX:LOP 15dBm
//Set the bias current to -1 mA .
SENS:MIX:BIAS:LOW -1mA
//----- Configuring the mixer and band settings -----
//Use band "V" to full possible range extent for assigned harmonic (6).
SENS:MIX:HARM:BAND V
SENS:MIX:RFOV ON
//Query the possible range
SENS:MIX:FREQ:STAR?
//Result: 4748000000 (47.48 GHz)
SENS:MIX:FREQ:STOP?
//Result: 13802000000 (138.02 GHz)
//Use a 3-port mixer type
SENS:MIX:PORT 3
//Split the frequency range into two ranges;
//range 1 covers 47.48 GHz GHz to 80 GHz; harmonic 6, average conv. loss of 20 dB
//range 2 covers 80 GHz to 138.02 GHz; harmonic 8, average conv.loss of 30 dB
SENS:MIX:HARM:TYPE EVEN
SENS:MIX:HARM:HIGH:STAT ON
SENS:MIX:FREQ:HAND 80GHz
SENS:MIX:HARM:LOW 6
SENS:MIX:LOSS:LOW 20dB
SENS:MIX:HARM:HIGH 8
SENS:MIX:LOSS:HIGH 30dB
//----- Activating automatic signal identification functions -----
//Activate both automatic signal identification functions.
SENS:MIX:SIGN ALL
//Use auto ID threshold of 8 dB.
SENS:MIX:THR 8dB

//-----Performing the Measurement-----
//Select single sweep mode.
```

```

INIT:CONT OFF
//Initiate a basic frequency sweep and wait until the sweep has finished.
INIT;*WAI
//-----Retrieving Results-----
//Return the trace data for the input signal without distortions
//(default screen configuration)
TRAC:DATA? TRACE3

```

### Configuring a conversion loss table for a user-defined band

```

//-----Preparing the instrument -----
//Reset the instrument
*RST
//Activate the use of the connected external mixer.
SENS:MIX ON
//-----Configuring a new conversion loss table -----
//Define cvl table for range 1 of band as described in previous example
// (extended V band)
SENS:CORR:CVL:SEL 'UserTable'
SENS:CORR:CVL:COMM 'User-defined conversion loss table for USER band'
SENS:CORR:CVL:BAND USER
SENS:CORR:CVL:HARM 6
SENS:CORR:CVL:BIAS -1mA
SENS:CORR:CVL:MIX 'FS_Z60'
SENS:CORR:CVL:SNUM '123.4567'
SENS:CORR:CVL:PORT 3
//Conversion loss is linear from 55 GHz to 75 GHz
SENS:CORR:CVL:DATA 55GHZ,-20DB,75GHZ,-30DB
//----- Configuring the mixer and band settings -----
//Use user-defined band and assign new cvl table.
SENS:MIX:HARM:BAND USER
//Define band by two ranges;
//range 1 covers 47.48 GHz to 80 GHz; harmonic 6, cvl table 'UserTable'
//range 2 covers 80 GHz to 138.02 GHz; harmonic 8, average conv.loss of 30 dB
SENS:MIX:HARM:TYPE EVEN
SENS:MIX:HARM:HIGH:STAT ON
SENS:MIX:FREQ:HAND 80GHz
SENS:MIX:HARM:LOW 6
SENS:MIX:LOSS:TABL:LOW 'UserTable'
SENS:MIX:HARM:HIGH 8

SENS:MIX:LOSS:HIGH 30dB
//Query the possible range
SENS:MIX:FREQ:STAR?
//Result: 47480000000 (47.48 GHz)
SENS:MIX:FREQ:STOP?
//Result: 138020000000 (138.02 GHz)

//-----Performing the Measurement-----

```



```
//Select single sweep mode.
INIT:CONT OFF
//Initiate a basic frequency sweep and wait until the sweep has finished.
INIT;*WAI
//-----Retrieving Results-----
//Return the trace data (default screen configuration)
TRAC:DATA? TRACel
```

#### 11.4.2.4 Configuring the 2 GHz / 5 GHz bandwidth extension (FSW-B2000/B5000)

The following commands are required to use the optional 2 GHz / 5 GHz bandwidth extension (FSW-B2000/B5000).

##### Remote commands exclusive to configuring the 2 GHz / 5 GHz bandwidth extensions:

EXPort:WAVeform:DISPlayoff.....	177
SYSTem:COMMunicate:RDEVice:OSCilloscope[:STATe].....	178
SYSTem:COMMunicate:RDEVice:OSCilloscope:ALIGNment:STEP<st>[:STATe].....	178
SYSTem:COMMunicate:RDEVice:OSCilloscope:ALIGNment:DATE.....	179
SYSTem:COMMunicate:RDEVice:OSCilloscope:ALIGNment:FALIGNment.....	179
SYSTem:COMMunicate:RDEVice:OSCilloscope:IDN.....	179
SYSTem:COMMunicate:RDEVice:OSCilloscope:LEDState.....	179
SYSTem:COMMunicate:RDEVice:OSCilloscope:PSMode[:STATe].....	180
SYSTem:COMMunicate:RDEVice:OSCilloscope:SRATe.....	180
SYSTem:COMMunicate:RDEVice:OSCilloscope:TCPip.....	181
SYSTem:COMMunicate:RDEVice:OSCilloscope:VDEVice?.....	181
SYSTem:COMMunicate:RDEVice:OSCilloscope:VFIRmware?.....	181
TRIGger[:SEQuence]:OSCilloscope:COUPLing.....	182

---

##### EXPort:WAVeform:DISPlayoff <FastExport>

Enables or disables the display update on the oscilloscope during data acquisition with the optional 2 GHz / 5 GHz bandwidth extension (FSW-B2000/B5000).

Note that this command is **only executable by the oscilloscope**, not by the FSW.

As soon as the FSW-B2000/B5000 is activated, the display on the oscilloscope is turned off to improve performance during data export. As soon as the FSW closes the connection to the oscilloscope, the display is reactivated and the oscilloscope can be operated as usual. However, if the LAN connection is lost for any reason, the display of the oscilloscope remains deactivated. Use this command to re-activate it.

For details on the optional 2 GHz / 5 GHz bandwidth extension (FSW-B2000/B5000), see FSW I/Q Analyzer and I/Q Input User Manual.

##### Parameters:

<FastExport>            ON | OFF | 1 | 0

ON | 1: Disables the display update for maximum export speed.

OFF | 0: Enables the display update. The export is slower.

\*RST:                    1

**SYSTem:COMMunicate:RDEvice:OSCilloscope[:STATe] <State>**

Activates the optional 2 GHz / 5 GHz bandwidth extension (R&S FSW-B2000/B5000).

**Note:** Manual operation on the connected oscilloscope, or remote operation other than by the FSW, is not possible while the B2000/B5000 option is active.

**Parameters:**

<State>                    ON | OFF | 0 | 1  
                               **OFF | 0**  
                               Switches the function off  
                               **ON | 1**  
                               Switches the function on

**Example:**                SYST:COMM:RDEV:OSC ON

**SYSTem:COMMunicate:RDEvice:OSCilloscope:ALIGNment:STEP<st>[:STATe] <State>**

Performs the alignment of the oscilloscope itself and the oscilloscope ADC for the optional 2 GHz / 5 GHz bandwidth extension (FSW-B2000/B5000). The correction data for the oscilloscope (including the connection cable between the FSW and the oscilloscope) is recorded. As a result, the state of the alignment is returned.

Alignment is required only once after setup. If alignment was performed successfully, the alignment data is stored on the oscilloscope.

Thus, alignment need only be repeated if one of the following applies:

- A new oscilloscope is connected to the "IF OUT 2 GHz/ IF OUT 5 GHz" connector of the FSW
- A new cable is used between the "IF OUT 2 GHz/ IF OUT 5 GHz" connector of the FSW and the oscilloscope
- A power splitter is inserted between the "IF OUT 2 GHz/ IF OUT 5 GHz" connector of the FSW and the oscilloscope
- New firmware is installed on the oscilloscope or the FSW

**Suffix:**

<st>                        1..n

**Parameters:**

<State>                    Returns the state of the second alignment step.  
                               **ON | 1**  
                               Alignment was successful.  
                               **OFF | 0**  
                               Alignment was not yet performed (successfully).

**Example:**                SYST:COMM:RDEV:OSC:ALIG:STEP?  
                               //Result: 1

---

**SYSTem:COMMunicate:RDEvice:OSCilloscope:ALIGNment:DATE** <Date>

Returns the date of alignment of the "IF OUT 2 GHz/ IF OUT 5 GHz" to the oscilloscope for the optional 2 GHz / 5 GHz bandwidth extension (FSW-B2000/B5000).

**Parameters:**

<Date> Returns the date of alignment.

**Example:**

```
SYST:COMM:RDEV:OSC:ALIG:DATE?
//Result: 2014-02-28
```

---

**SYSTem:COMMunicate:RDEvice:OSCilloscope:ALIGNment:FALignment** <State>

Performs a self-alignment on the oscilloscope before the B2000/B5000 alignment on the FSW.

**Parameters:**

<State> ON | OFF | 0 | 1  
**OFF | 0**  
 Switches the function off  
**ON | 1**  
 Switches the function on  
 \*RST: 0

**Example:**

```
SYST:COMM:RDEV:OSC:ALIG:FAL ON
```

---

**SYSTem:COMMunicate:RDEvice:OSCilloscope:IDN** <IDString>

Returns the identification string of the oscilloscope connected to the FSW.

**Parameters:**

<IDString>

**Example:**

```
SYST:COMM:RDEV:OSC:IDN?
//Result: Rohde&Schwarz,RTO,
1316.1000k14/200153,2.45.1.1
```

---

**SYSTem:COMMunicate:RDEvice:OSCilloscope:LEDState** <Color>

Returns the state of the LAN connection to the oscilloscope for the optional 2 GHz / 5 GHz bandwidth extension (FSW-B2000/B5000).

**Parameters:**

<Color> OFF | SUCCEssful | ERRor  
**SUCCEssful**  
 Connection to the instrument has been established successfully.  
**OFF**  
 No instrument configured.

**ERRor**

Connection to the instrument could not be established. Check the connection between the FSW and the oscilloscope, and make sure the IP address of the oscilloscope has been defined (see [SYSTem:COMMunicate:RDEvice:OSCilloscope:TCPIP](#) on page 181).

**Example:** `SYST:COMM:RDEV:OSC:LEDS?  
//Result: 'SUCC'`

**SYSTem:COMMunicate:RDEvice:OSCilloscope:PSMode[:STATE] <State>**

Activates the use of the power splitter inserted between the "IF 2 GHZ OUT" connector of the FSW and the "CH1" and "CH3" input connectors of the oscilloscope. Note that this mode requires an additional alignment with the power splitter.

For details see the FSW I/Q Analyzer and I/Q Input User Manual.

**Parameters:**

<State>            ON | OFF | 0 | 1  
**OFF | 0**  
 Switches the function off  
**ON | 1**  
 Switches the function on

**Example:** `SYST:COMM:RDEV:OSC:PSM ON`

**SYSTem:COMMunicate:RDEvice:OSCilloscope:SRATE <Rate>**

Determines whether the 10 GHz mode (default) or 20 GHz mode of the connected oscilloscope is used. The 20 GHz mode achieves a higher decimation gain, but reduces the record length by half.

**Parameters:**

<Rate>            10 GHz | 20 GHz  
 No other sample rate values are allowed.  
 \*RST:            10 GHz  
 Default unit: HZ

**Example:** `TRAC:IQ:SRAT?  
//Result: 100000000  
TRAC:IQ:RLEN?  
//Result: 3128  
SYST:COMM:RDEV:OSC:SRAT 20GHZ  
TRAC:IQ:SRAT?  
//Result: 200000000  
TRAC:IQ:RLEN?  
//Result: 1564`

---

**SYSTem:COMMunicate:RDEvice:OSCilloscope:TCPIp <Address>**

Defines the TCPIP address or computer name of the oscilloscope connected to the FSW via LAN.

**Note:** The IP address is maintained after a [PRESET], and is transferred between applications.

**Parameters:**

<Address>                    computer name or IP address

**Example:**                    `SYST:COMM:RDEV:OSC:TCP '192.0.2.0'`

**Example:**                    `SYST:COMM:RDEV:OSC:TCP 'FSW43-12345'`

---

**SYSTem:COMMunicate:RDEvice:OSCilloscope:VDEvice?**

Queries whether the connected instrument is supported by the 2 GHz / 5 GHz bandwidth extension option(B2000/B5000).

For details see the 2 GHz bandwidth extension basics chapter in the FSW I/Q Analyzer and I/Q Input User Manual.

**Return values:**

<State>                    ON | OFF | 0 | 1

**OFF | 0**

Switches the function off

**ON | 1**

Switches the function on

**Example:**                    `SYST:COMM:RDEV:OSC:VDEV?`

**Usage:**                    Query only

---

**SYSTem:COMMunicate:RDEvice:OSCilloscope:VFIRmware?**

Queries whether the firmware on the connected oscilloscope is supported by the 2 GHz / 5 GHz bandwidth extension (B2000/B5000) option.

**Return values:**

<State>                    ON | OFF | 0 | 1

**OFF | 0**

Switches the function off

**ON | 1**

Switches the function on

**Example:**                    `SYST:COMM:RDEV:OSC:VFIR?`

**Usage:**                    Query only

**TRIGger[:SEQuence]:OSCilloscope:COUPLing <CoupType>**

Configures the coupling of the external trigger to the oscilloscope.

**Parameters:**

<CoupType>	Coupling type
	<b>DC</b>
	Direct connection with 50 $\Omega$ termination, passes both DC and AC components of the trigger signal.
	<b>CDLimit</b>
	Direct connection with 1 M $\Omega$ termination, passes both DC and AC components of the trigger signal.
	<b>AC</b>
	Connection through capacitor, removes unwanted DC and very low-frequency components.
*RST:	DC

**Manual operation:** See "Coupling" on page 58

#### 11.4.2.5 Configuring input via the optional Analog Baseband interface

The following commands are required to control the optional "Analog Baseband" interface in a remote environment. They are only available if this option is installed.

For more information on the "Analog Baseband" interface, see the FSW I/Q Analyzer User Manual.

Useful commands for Analog Baseband data described elsewhere:

- `INP:SEL AIQ` (see `INPut:SELeCt` on page 159)
- `[SENSe:]FREQuency:CENTer` on page 215

Commands for the Analog Baseband calibration signal are described in the FSW User Manual.

#### Remote commands exclusive to Analog Baseband data input and output

<code>INPut:IQ:BAALanced[:STATe]</code> .....	182
<code>INPut:IQ:FULLscale:AUTO</code> .....	183
<code>INPut:IQ:FULLscale[:LEVel]</code> .....	183
<code>INPut:IQ:IMPedance</code> .....	183
<code>INPut:IQ:TYPE</code> .....	184
<code>CALibration:AIQ:HATiming[:STATe]</code> .....	184

**INPut:IQ:BAALanced[:STATe] <State>**

Defines whether the input is provided as a differential signal via all 4 Analog Baseband connectors or as a plain I/Q signal via 2 single-ended lines.

**Parameters:**

<State>	ON   OFF   1   0
---------	------------------

**ON | 1**  
Differential

**OFF | 0**  
Single ended

\*RST: 1

**Example:** INP:IQ:BAL OFF

#### INPut:IQ:FULLscale:AUTO <State>

Defines whether the full scale level (i.e. the maximum input power on the Baseband Input connector) is defined automatically according to the reference level, or manually.

##### Parameters:

<State>

**ON | 1**  
Automatic definition

**OFF | 0**  
Manual definition according to [INPut:IQ:FULLscale\[:LEVel\]](#) on page 183

\*RST: 1

**Example:** INP:IQ:FULL:AUTO OFF

#### INPut:IQ:FULLscale[:LEVel] <PeakVoltage>

Defines the peak voltage at the Baseband Input connector if the full scale level is set to manual mode (see [INPut:IQ:FULLscale:AUTO](#) on page 183).

##### Parameters:

<PeakVoltage> 0.25 V | 0.5 V | 1 V | 2 V

Peak voltage level at the connector.  
For probes, the possible full scale values are adapted according to the probe's attenuation and maximum allowed power.

\*RST: 1V  
Default unit: V

**Example:** INP:IQ:FULL 0.5V

#### INPut:IQ:IMPedance <Impedance>

Selects the nominal input impedance of the analog baseband input.

Not available for input from the optional "Digital Baseband" interface.

For input from the RF input, use the [INPut:IMPedance](#) command.

**Parameters:**

<Impedance> 50 | 75

**numeric value**  
 User-defined impedance from 50 Ohm to 100000000 Ohm (=100 MOhm)  
 User-defined values are only available for:  
 Spectrum application  
 I/Q Analyzer

\*RST: 50  
 Default unit: OHM

**Example:** INP:IQ:IMP 75

**INPut:IQ:TYPE** <DataType>

Defines the format of the input signal.

**Parameters:**

<DataType> IQ | I | Q

**IQ**  
 The input signal is filtered and resampled to the sample rate of the application.  
 Two input channels are required for each input signal, one for the in-phase component, and one for the quadrature component.

**I**  
 The in-phase component of the input signal is filtered and resampled to the sample rate of the application. If the center frequency is not 0, the in-phase component of the input signal is down-converted first (Low IF I).

**Q**  
 The quadrature component of the input signal is filtered and resampled to the sample rate of the application. If the center frequency is not 0, the quadrature component of the input signal is down-converted first (Low IF Q).

\*RST: IQ

**Example:** INP:IQ:TYPE Q

**CALibration:AIQ:HATiming[:STATE]** <State>

Activates a mode with enhanced timing accuracy between analog baseband, RF and external trigger signals.

For more information, see the FSW I/Q Analyzer and I/Q Input User Manual.

**Parameters:**

<State> ON | OFF | 0 | 1

**OFF | 0**  
 Switches the function off



**ON | 1**

Switches the function on

**Example:** CAL:AIQ:HAT:STAT ON**11.4.2.6 Configuring digital I/Q input and output**

Useful commands for digital I/Q data described elsewhere:

- INP:SEL DIQ (see INPut:SElect on page 159)
- TRIGger[:SEquence]:LEVel:BBPower on page 232

**Remote commands exclusive to digital I/Q data input and output**

INPut:DIQ:CDEvice.....	185
INPut:DIQ:RANGe:COUPling.....	185
INPut:DIQ:RANGe[:UPPer].....	186
INPut:DIQ:RANGe[:UPPer]:AUTO.....	186
INPut:DIQ:RANGe[:UPPer]:UNIT.....	186
INPut:DIQ:SRATe.....	186
INPut:DIQ:SRATe:AUTO.....	186

**INPut:DIQ:CDEvice**

Queries the current configuration and the status of the digital I/Q input from the optional "Digital Baseband" interface.

For details see the section "Interface Status Information" for the optional "Digital Baseband" interface in the FSW I/Q Analyzer User Manual.

**Return values:**

&lt;Value&gt;

**Example:** INP:DIQ:CDEV?  
**Result:**  
 1, SMW200A, 101190, BBMM 1 OUT,  
 100000000, 200000000, Passed, Passed, 1, 1. #QNAN

**INPut:DIQ:RANGe:COUPling <State>**

If enabled, the reference level for digital input is adjusted to the full scale level automatically if the full scale level changes.

Is only available if the optional "Digital Baseband" interface is installed.

**Parameters:**

<State> ON | OFF | 1 | 0  
 \*RST: 0

**INPut:DIQ:RANGe[:UPPer] <Level>**

Defines or queries the "Full Scale Level", i.e. the level that corresponds to an I/Q sample with the magnitude "1".

Is only available if the optional "Digital Baseband" interface is installed.

**Parameters:**

<Level>                    Range:        1  $\mu$ V to 7.071 V  
                               \*RST:        1 V  
                               Default unit: DBM

**INPut:DIQ:RANGe[:UPPer]:AUTO <State>**

If enabled, the digital input full scale level is automatically set to the value provided by the connected device (if available).

Is only available if the optional "Digital Baseband" interface is installed.

**Parameters:**

<State>                    ON | OFF | 1 | 0  
                               \*RST:        0

**INPut:DIQ:RANGe[:UPPer]:UNIT <Level>**

Defines the unit of the full scale level. The availability of units depends on the measurement application you are using.

Is only available if the optional "Digital Baseband" interface is installed.

**Parameters:**

<Level>                    DBM | DBPW | WATT | DBUV | DBMV | VOLT | DBUA | AMPere  
                               \*RST:        Volt

**INPut:DIQ:SRATe <SampleRate>**

Specifies or queries the sample rate of the input signal from the optional "Digital Baseband" interface.

**Parameters:**

<SampleRate>            Range:        1 Hz to 20 GHz  
                               \*RST:        32 MHz  
                               Default unit: HZ

**Example:**                INP:DIQ:SRAT 200 MHz

**INPut:DIQ:SRATe:AUTO <State>**

If enabled, the sample rate of the digital I/Q input signal is set automatically by the connected device.

Is only available if the optional "Digital Baseband" interface is installed.

**Parameters:**

<State> ON | OFF | 1 | 0  
 \*RST: 0

**11.4.2.7 Setting up probes**

Modular probes can be connected to the RF input connector of the FSW.

For details see the FSW User Manual.

Probes can also be connected to the optional "Baseband Input" connectors, if the "Analog Baseband" interface ( option FSW-B71) is installed.

[SENSe:]PROBe<pb>:ID:PARTnumber?	187
[SENSe:]PROBe<pb>:ID:SRNumber?	187
[SENSe:]PROBe<pb>:SETup:ATTRatio	188
[SENSe:]PROBe<pb>:SETup:CMOFfset	188
[SENSe:]PROBe<pb>:SETup:DMOFfset	189
[SENSe:]PROBe<pb>:SETup:MODE	189
[SENSe:]PROBe<pb>:SETup:NAME?	189
[SENSe:]PROBe<pb>:SETup:NMOFfset	190
[SENSe:]PROBe<pb>:SETup:PMODE	190
[SENSe:]PROBe<pb>:SETup:PMOFfset	191
[SENSe:]PROBe<pb>:SETup:STATe?	191
[SENSe:]PROBe<pb>:SETup:TYPE?	192

**[SENSe:]PROBe<pb>:ID:PARTnumber?**

Queries the R&S part number of the probe.

**Suffix:**

<pb> 1..n  
 Selects the connector:  
 1 = Baseband Input I  
 2 = Baseband Input Q  
 3 = RF

**Return values:**

<PartNumber>

**Example:** //Query part number  
 PROB3:ID:PART?

**Usage:** Query only

**[SENSe:]PROBe<pb>:ID:SRNumber?**

Queries the serial number of the probe.

**Suffix:**

<pb> 1..n  
 Selects the connector:  
 1 = Baseband Input I  
 2 = Baseband Input Q  
 3 = RF

**Return values:**

<SerialNo>

**Example:** //Query serial number  
 PROB3:ID:SRN?

**Usage:** Query only

**[SENSe:]PROBe<pb>:SETup:ATTRatio <AttenuationRatio>**

Defines the attenuation applied to the input at the probe. This setting is only available for modular probes.

**Suffix:**

<pb> 1..n  
 Selects the connector:  
 1 = Baseband Input I  
 2 = Baseband Input Q  
 3 = RF

**Parameters:**

<AttenuationRatio> **10**  
 Attenuation by 20 dB (ratio= 10:1)  
**2**  
 Attenuation by 6 dB (ratio= 2:1)  
 \*RST: 10  
 Default unit: DB

**[SENSe:]PROBe<pb>:SETup:CMOffset <CMOffset>**

Sets the common mode offset. The setting is only available if a differential probe in CM-mode is connected to the FSW.

If the probe is disconnected, the common mode offset of the probe is reset to 0.0 V.

Note that if the offset for DM-mode or CM-mode is changed, the offsets for the P-mode and N-mode are adapted accordingly, and vice versa.

For details see the FSW User Manual.

**Suffix:**

<pb> 1..n  
 Selects the connector:  
 1 = Baseband Input I  
 2 = Baseband Input Q  
 3 = RF

**Parameters:**

<CMOffset> Offset of the mean voltage between the positive and negative input terminal vs. ground  
 Range: -16 V to +16 V  
 Default unit: V

**[SENSe:]PROBE<pb>:SETup:DMOffset <DMOffset>**

Sets the DM-mode offset. The setting is only available if a modular probe in DM-mode is connected to the FSW.

If the probe is disconnected, the DM-mode offset of the probe is reset to 0.0 V.

Note that if the offset for DM-mode or CM-mode is changed, the offsets for the P-mode and N-mode are adapted accordingly, and vice versa.

For details see the FSW User Manual.

**Suffix:**

<pb> 1..n  
 Selects the connector:  
 1 = Baseband Input I  
 2 = Baseband Input Q  
 3 = RF

**Parameters:**

<DMOffset> Voltage offset between the positive and negative input terminal  
 Default unit: V

**[SENSe:]PROBE<pb>:SETup:MODE <Mode>****Suffix:**

<pb> 1..n  
 Selects the connector:  
 1 = Baseband Input I  
 2 = Baseband Input Q  
 3 = RF

**Parameters:**

<Mode> RSINgle | NOAction  
**RSINgle**  
 Run single: starts one data acquisition.  
**NOAction**  
 Nothing is started on pressing the micro button.

**[SENSe:]PROBE<pb>:SETup:NAME?**

Queries the name of the probe.

**Suffix:**

<pb> 1..n  
 Selects the connector:  
 1 = Baseband Input I  
 2 = Baseband Input Q  
 3 = RF

**Return values:**

<Name> String containing the name of the probe.

**Example:**

```
//Query name of the probe
PROB3:SET:NAME?
```

**Usage:**

Query only

**[SENSe:]PROBe<pb>:SETup:NMOffset <NMOffset>**

Sets the N-mode offset. The setting is only available if a modular probe in N-mode is connected to the FSW. The maximum voltage difference between the positive and negative input terminals is 16 V.

If the probe is disconnected, the N-mode offset of the probe is reset to 0.0 V.

Note that if the offset for DM-mode or CM-mode is changed, the offsets for the P-mode and N-mode are adapted accordingly, and vice versa.

For details see the FSW User Manual.

**Suffix:**

<pb> 1..n  
 Selects the connector:  
 1 = Baseband Input I  
 2 = Baseband Input Q  
 3 = RF

**Parameters:**

<NMOffset> The voltage offset between the negative input terminal and ground.  
 Default unit: V

**[SENSe:]PROBe<pb>:SETup:PMODE <Mode>**

Determines the mode of a multi-mode modular probe.

For details see the FSW User Manual.

**Suffix:**

<pb> 1..n  
 Selects the connector:  
 1 = Baseband Input I  
 2 = Baseband Input Q  
 3 = RF

**Parameters:**

<Mode> CM | DM | PM | NM  
**DM**  
 Voltage between the positive and negative input terminal  
**CM**  
 Mean voltage between the positive and negative input terminal vs. ground  
**PM**  
 Voltage between the positive input terminal and ground  
**NM**  
 Voltage between the negative input terminal and ground

**Example:**

```
SENS:PROB:SETU:PMOD PM
Sets the probe to P-mode.
```

**[SENSe:]PROBe<pb>:SETup:PMOffset <PMOffset>**

Sets the P-mode offset. The setting is only available if a modular probe in P-mode is connected to the FSW. The maximum voltage difference between the positive and negative input terminals is 16 V.

If the probe is disconnected, the P-mode offset of the probe is reset to 0.0 V.

Note that if the offset for DM-mode or CM-mode is changed, the offsets for the P-mode and N-mode are adapted accordingly, and vice versa.

For details see the FSW User Manual.

**Suffix:**

<pb> 1..n  
 Selects the connector:  
 1 = Baseband Input I  
 2 = Baseband Input Q  
 3 = RF

**Parameters:**

<PMOffset> The voltage offset between the positive input terminal and ground.  
 Default unit: V

**[SENSe:]PROBe<pb>:SETup:STAtE?**

Queries if the probe at the specified connector is active (detected) or not active (not detected).

To switch the probe on, i.e. activate input from the connector, use `INP:SEL:AIQ` (see [INPut:SElect](#) on page 159).

**Suffix:**

<pb> 1..n  
 Selects the connector:  
 1 = Baseband Input I  
 2 = Baseband Input Q  
 3 = RF

**Return values:**

<State> DETected | NDETECTED

**Example:**

```
//Query connector state
PROB3:SET:STAT?
```

**Usage:**

Query only

**[SENSe:]PROBE<pb>:SETup:TYPE?**

Queries the type of the probe.

**Suffix:**

<pb> 1..n  
 Selects the connector:  
 1 = Baseband Input I  
 2 = Baseband Input Q  
 3 = RF

**Return values:**

<Type> String containing one of the following values:  
 -"None" (no probe detected)  
 -"active differential"  
 -"active single-ended"  
 -"active modular"

**Example:**

```
//Query probe type
PROB3:SET:TYPE?
```

**Usage:**

Query only

**11.4.2.8 Working with power sensors**

The following commands describe how to work with power sensors.

These commands require the use of a Rohde & Schwarz power sensor. For a list of supported sensors, see the specifications document.

- [Configuring power sensors](#)..... 193
- [Configuring power sensor measurements](#)..... 194
- [Triggering with power sensors](#)..... 200



**Configuring power sensors**

SYSTem:COMMunicate:RDEvice:PMETer<p>:CONFigure:AUTO[:STATe].....	193
SYSTem:COMMunicate:RDEvice:PMETer<p>:COUNt?.....	193
SYSTem:COMMunicate:RDEvice:PMETer<p>:DEFine.....	193

**SYSTem:COMMunicate:RDEvice:PMETer<p>:CONFigure:AUTO[:STATe] <State>**

Turns automatic assignment of a power sensor to the power sensor index on and off.

**Suffix:**

<p> Power sensor index

**Parameters:**

<State> ON | OFF | 0 | 1  
\*RST: 1

**Example:** SYST:COMM:RDEV:PMET:CONF:AUTO OFF

**SYSTem:COMMunicate:RDEvice:PMETer<p>:COUNt?**

Queries the number of power sensors currently connected to the FSW.

**Suffix:**

<p> Power sensor index

**Return values:**

<NumberSensors> Number of connected power sensors.

**Example:** SYST:COMM:RDEV:PMET:COUN?

**Usage:** Query only

**SYSTem:COMMunicate:RDEvice:PMETer<p>:DEFine <Placeholder>, <Type>, <Interface>, <SerialNo>**

Assigns the power sensor with the specified serial number to the selected power sensor index (configuration).

The query returns the power sensor type and serial number of the sensor assigned to the specified index.

**Suffix:**

<p> Power sensor index

**Parameters:**

<Placeholder> Currently not used  
<Type> Detected power sensor type, e.g. "NRP-Z81".  
<Interface> Interface the power sensor is connected to; always "USB"  
<SerialNo> Serial number of the power sensor assigned to the specified index

**Example:**

```
SYST:COMM:RDEV:PMET2:DEF '', 'NRP-Z81', '',
'123456'
```

Assigns the power sensor with the serial number '123456' to the configuration "Power Sensor 2".

```
SYST:COMM:RDEV:PMET2:DEF?
```

Queries the sensor assigned to "Power Sensor 2".

**Result:**

```
'', 'NRP-Z81', 'USB', '123456'
```

The NRP-Z81 power sensor with the serial number '123456' is assigned to the "Power Sensor 2".

### Configuring power sensor measurements

CALibration:PMETer<p>:ZERO:AUTO ONCE.....	194
CALCulate<n>:PMETer<p>:RELative[:MAGNitude].....	195
CALCulate<n>:PMETer<p>:RELative[:MAGNitude]:AUTO ONCE.....	195
CALCulate<n>:PMETer<p>:RELative:STATe.....	195
FETCh:PMETer<p>?.....	196
READ:PMETer<p>?.....	196
[SENSe:]PMETer<p>:DCYCLe[:STATe].....	196
[SENSe:]PMETer<p>:DCYCLe:VALue.....	196
[SENSe:]PMETer<p>:FREQuency.....	197
[SENSe:]PMETer<p>:FREQuency:LINK.....	197
[SENSe:]PMETer<p>:MTIME.....	197
[SENSe:]PMETer<p>:MTIME:AVERAge:COUNT.....	198
[SENSe:]PMETer<p>:MTIME:AVERAge[:STATe].....	198
[SENSe:]PMETer<p>:ROFFset[:STATe].....	198
[SENSe:]PMETer<p>:SOFFset.....	199
[SENSe:]PMETer<p>[:STATe].....	199
[SENSe:]PMETer<p>:UPDate[:STATe].....	199
UNIT<n>:PMETer<p>:POWer.....	200
UNIT<n>:PMETer<p>:POWer:RATio.....	200

---

### CALibration:PMETer<p>:ZERO:AUTO ONCE

Zeroes the power sensor.

Note that you have to disconnect the signals from the power sensor input before you start to zero the power sensor. Otherwise, results are invalid.

#### Suffix:

<p> Power sensor index

#### Example:

```
CAL:PMET2:ZERO:AUTO ONCE;*WAI
```

Starts zeroing the power sensor 2 and delays the execution of further commands until zeroing is concluded.

#### Usage:

Event

**CALCulate<n>:PMETer<p>:RELative[:MAGNitude] <RefValue>**

Defines the reference value for relative measurements.

**Suffix:**

<n> [Window](#)

<p> Power sensor index

**Parameters:**

<RefValue> Range: -200 dBm to 200 dBm  
\*RST: 0  
Default unit: DBM

**Example:**

`CALC:PMET2:REL -30`

Sets the reference value for relative measurements to -30 dBm for power sensor 2.

**CALCulate<n>:PMETer<p>:RELative[:MAGNitude]:AUTO ONCE**

Sets the current measurement result as the reference level for relative measurements.

**Suffix:**

<n> [Window](#)

<p> Power sensor index

**Example:**

`CALC:PMET2:REL:AUTO ONCE`

Takes the current measurement value as reference value for relative measurements for power sensor 2.

**Usage:**

Event

**CALCulate<n>:PMETer<p>:RELative:STATE <State>**

Turns relative power sensor measurements on and off.

**Suffix:**

<n> [Window](#)

<p> Power sensor index

**Parameters:**

<State> ON | OFF | 0 | 1  
**OFF | 0**  
Switches the function off  
**ON | 1**  
Switches the function on

**Example:**

`CALC:PMET2:REL:STAT ON`

Activates the relative display of the measured value for power sensor 2.

---

**FETCH:PMETer<p>?**

Queries the results of power sensor measurements.

**Suffix:**

<p> Power sensor index

**Usage:** Query only

---

**READ:PMETer<p>?**

Initiates a power sensor measurement and queries the results.

**Suffix:**

<p> Power sensor index

**Usage:** Query only

---

**[SENSe:]PMETer<p>:DCYClE[:STATe] <State>**

Turns the duty cycle correction on and off.

**Suffix:**

<p> Power sensor index

**Parameters:**

<State> ON | OFF | 0 | 1

**OFF | 0**

Switches the function off

**ON | 1**

Switches the function on

**Example:** PMET2:DCYC:STAT ON

---

**[SENSe:]PMETer<p>:DCYClE:VALue <Percentage>**

Defines the duty cycle for the correction of pulse signals.

The power sensor uses the duty cycle in combination with the mean power to calculate the power of the pulse.

**Suffix:**

<p> Power sensor

**Parameters:**

<Percentage> Range: 0.001 to 99.999

\*RST: 99.999

Default unit: %

**Example:** PMET2:DCYC:STAT ON  
Activates the duty cycle correction.  
PMET2:DCYC:VAL 0.5  
Sets the correction value to 0.5%.

---

**[SENSe:]PMETer<p>:FREQUency <Frequency>**

Defines the frequency of the power sensor.

**Suffix:**

<p> Power sensor index

**Parameters:**

<Frequency> The available value range is specified in the specifications document of the power sensor in use.

\*RST: 50 MHz

Default unit: HZ

**Example:**

PMET2:FREQ 1GHZ

Sets the frequency of the power sensor to 1 GHz.

---

**[SENSe:]PMETer<p>:FREQUency:LINK <Coupling>**

Selects the frequency coupling for power sensor measurements.

**Suffix:**

<p> Power sensor index

**Parameters:**

<Coupling>

**CENTER**

Couples the frequency to the center frequency of the analyzer

**MARKer1**

Couples the frequency to the position of marker 1

**OFF**

Switches the frequency coupling off

\*RST: CENTER

**Example:**

PMET2:FREQ:LINK CENT

Couples the frequency to the center frequency of the analyzer

---

**[SENSe:]PMETer<p>:MTIME <Duration>**

Selects the duration of power sensor measurements.

**Suffix:**

<p> Power sensor index

**Parameters:**

<Duration>

SHORT | NORMAl | LONG

\*RST: NORMAl

**Example:**

PMET2:MTIM SHOR

Sets a short measurement duration for measurements of stationary high power signals for the selected power sensor.

---

**[SENSe:]PMETer<p>:MTIMe:AVERAge:COUNT <NumberReadings>**

Sets the number of power readings included in the averaging process of power sensor measurements.

Extended averaging yields more stable results for power sensor measurements, especially for measurements on signals with a low power, because it minimizes the effects of noise.

**Suffix:**

<p> Power sensor index

**Parameters:**

<NumberReadings> An average count of 0 or 1 performs one power reading.

Range: 0 to 256

Increment: binary steps (1, 2, 4, 8, ...)

**Example:**

PMET2:MTIM:AVER ON

Activates manual averaging.

PMET2:MTIM:AVER:COUN 8

Sets the number of readings to 8.

---

**[SENSe:]PMETer<p>:MTIMe:AVERAge[:STATe] <State>**

Turns averaging for power sensor measurements on and off.

**Suffix:**

<p> Power sensor index

**Parameters:**

<State> ON | OFF | 0 | 1

**OFF | 0**

Switches the function off

**ON | 1**

Switches the function on

**Example:**

PMET2:MTIM:AVER ON

Activates manual averaging.

---

**[SENSe:]PMETer<p>:ROFFset[:STATe] <State>**

Includes or excludes the reference level offset of the analyzer for power sensor measurements.

**Suffix:**

<p> Power sensor index

**Parameters:**

<State> ON | OFF | 0 | 1

**OFF | 0**

Switches the function off

**ON | 1**

Switches the function on

**Example:**

PMET2:ROFF OFF

Takes no offset into account for the measured power.

**[SENSe:]PMETer<p>:SOFFset <SensorOffset>**

Takes the specified offset into account for the measured power. Only available if [SENSe:]PMETer<p>:ROFFset [:STATe] is disabled.

**Suffix:**

&lt;p&gt; Power sensor index

**Parameters:**

&lt;SensorOffset&gt; Default unit: DB

**Example:**

PMET2:SOFF 0.001

**[SENSe:]PMETer<p>[:STATe] <State>**

Turns a power sensor on and off.

**Suffix:**

&lt;p&gt; Power sensor index

**Parameters:**

&lt;State&gt; ON | OFF | 0 | 1

**OFF | 0**

Switches the function off

**ON | 1**

Switches the function on

**Example:**

PMET1 ON

Switches the power sensor measurements on.

**[SENSe:]PMETer<p>:UPDate[:STATe] <State>**

Turns continuous update of power sensor measurements on and off.

If on, the results are updated even if a single sweep is complete.

**Suffix:**

&lt;p&gt; Power sensor index

**Parameters:**

&lt;State&gt; ON | OFF | 0 | 1

**OFF | 0**

Switches the function off

**ON | 1**

Switches the function on

**Example:** `PMET1:UPD ON`  
The data from power sensor 1 is updated continuously.

---

#### **UNIT<n>:PMETer<p>:POWer <Unit>**

Selects the unit for absolute power sensor measurements.

**Suffix:**

<n> irrelevant

<p> Power sensor index

**Parameters:**

<Unit> DBM | WATT | W | DB | PCT

\*RST: DBM

**Example:** `UNIT:PMET:POW DBM`

---

#### **UNIT<n>:PMETer<p>:POWer:RATio <Unit>**

Selects the unit for relative power sensor measurements.

**Suffix:**

<n> irrelevant

<p> Power sensor index

**Parameters:**

<Unit> DB | PCT

\*RST: DB

**Example:** `UNIT:PMET:POW:RAT DB`

### Triggering with power sensors

<a href="#">[SENSe:]PMETer&lt;p&gt;:TRIGger:DTIME</a> .....	200
<a href="#">[SENSe:]PMETer&lt;p&gt;:TRIGger:HOLDoff</a> .....	201
<a href="#">[SENSe:]PMETer&lt;p&gt;:TRIGger:HYSTeresis</a> .....	201
<a href="#">[SENSe:]PMETer&lt;p&gt;:TRIGger:LEVel</a> .....	201
<a href="#">[SENSe:]PMETer&lt;p&gt;:TRIGger:SLOPe</a> .....	202
<a href="#">[SENSe:]PMETer&lt;p&gt;:TRIGger[:STATe]</a> .....	202

---

#### **[SENSe:]PMETer<p>:TRIGger:DTIME <Time>**

Defines the time period that the input signal has to stay below the IF power trigger level before the measurement starts.

**Suffix:**

<p> Power sensor index



**Parameters:**

<Time>                   Range:     0 s to 1 s  
                           Increment:  100 ns  
                           \*RST:      100 µs  
                           Default unit: S

**Example:**               PMET2:TRIG:DTIME 0.001

**[SENSe:]PMETer<p>:TRIGger:HOLDoff <Holdoff>**

Defines the trigger holdoff for external power triggers.

**Suffix:**

<p>                       Power sensor index

**Parameters:**

<Holdoff>               Time period that has to pass between the trigger event and the start of the measurement, in case another trigger event occurs.  
                           Range:     0 s to 1 s  
                           Increment:  100 ns  
                           \*RST:      0 s  
                           Default unit: S

**Example:**               PMET2:TRIG:HOLD 0.1  
                           Sets the holdoff time of the trigger to 100 ms

**[SENSe:]PMETer<p>:TRIGger:HYSteresis <Hysteresis>**

Defines the trigger hysteresis for external power triggers.

The hysteresis in dB is the value the input signal must stay below the IF power trigger level to allow a trigger to start the measurement.

**Suffix:**

<p>                       Power sensor index

**Parameters:**

<Hysteresis>           Range:     3 dB to 50 dB  
                           Increment:  1 dB  
                           \*RST:      0 dB  
                           Default unit: DB

**Example:**               PMET2:TRIG:HYST 10  
                           Sets the hysteresis of the trigger to 10 dB.

**[SENSe:]PMETer<p>:TRIGger:LEVel <Level>**

Defines the trigger level for external power triggers.

**Suffix:**

<p>                       Power sensor index

**Parameters:**

<Level> -20 to +20 dBm  
 Range: -20 dBm to 20 dBm  
 \*RST: -10 dBm  
 Default unit: DBM

**Example:**

PMET2:TRIG:LEV -10 dBm  
 Sets the level of the trigger

**[SENSe:]PMETer<p>:TRIGger:SLOPe <Edge>**

Selects the trigger condition for external power triggers.

**Suffix:**

<p> Power sensor index

**Parameters:**

<Edge> **POSitive**  
 The measurement starts in case the trigger signal shows a positive edge.  
**NEGative**  
 The measurement starts in case the trigger signal shows a negative edge.  
 \*RST: POSitive

**Example:**

PMET2:TRIG:SLOP NEG

**[SENSe:]PMETer<p>:TRIGger[:STATe] <State>**

Turns the external power trigger on and off.

**Suffix:**

<p> Power sensor index

**Parameters:**

<State> ON | OFF | 0 | 1  
**OFF | 0**  
 Switches the function off  
**ON | 1**  
 Switches the function on

**Example:**

PMET2:TRIG ON  
 Switches the external power trigger on

#### 11.4.2.9 External generator control

External generator control commands are available if the FSW External Generator Control option (R&S FSW-B10) is installed.

For each measurement channel, you can configure one external generator. To switch between different configurations, define multiple measurement channels.

For more information on external generator control, see the FSW User Manual.

- [Measurement configuration](#).....203
- [Interface configuration](#).....206
- [Source calibration](#).....208

### Measurement configuration

The following commands are required to activate external generator control and to configure a calibration measurement with an external tracking generator.

<a href="#">SOURce&lt;si&gt;:EXTernal&lt;gen&gt;:FREQuency</a> .....	203
<a href="#">SOURce&lt;si&gt;:EXTernal&lt;gen&gt;:FREQuency:COUPling[:STATe]</a> .....	203
<a href="#">SOURce&lt;si&gt;:EXTernal&lt;gen&gt;:FREQuency[:FACTor]:DENominator</a> .....	204
<a href="#">SOURce&lt;si&gt;:EXTernal&lt;gen&gt;:FREQuency[:FACTor]:NUMerator</a> .....	204
<a href="#">SOURce&lt;si&gt;:EXTernal&lt;gen&gt;:FREQuency:OFFSet</a> .....	205
<a href="#">SOURce&lt;si&gt;:EXTernal&lt;gen&gt;:POWer[:LEVel]</a> .....	205
<a href="#">SOURce&lt;si&gt;:EXTernal&lt;gen&gt;[:STATe]</a> .....	206
<a href="#">SOURce&lt;si&gt;:POWer[:LEVel][:IMMEdiate]:OFFSet</a> .....	206

---

#### **SOURce<si>:EXTernal<gen>:FREQuency** <Frequency>

Defines a fixed source frequency for the external generator.

##### **Suffix:**

<si>                      irrelevant

<gen>

##### **Parameters:**

<Frequency>              Source frequency of the external generator.  
                                  \*RST:        1100050000  
                                  Default unit: HZ

##### **Example:**

```
//Define frequency of the generator
SOUR:EXT:FREQ 10MHz
```

---

#### **SOURce<si>:EXTernal<gen>:FREQuency:COUPling[:STATe]** <State>

Couples the frequency of the external generator output to the FSW.

##### **Suffix:**

<si>                      irrelevant

<gen>

##### **Parameters:**

<State>                    ON | OFF | 0 | 1

##### **ON | 1**

Default setting: a series of frequencies is defined (one for each sweep point), based on the current frequency at the RF input of the FSW. The RF frequency range covers the currently defined span of the FSW (unless limited by the range of the signal generator).

**OFF | 0**

The generator uses a single fixed frequency, defined by `SOURce<si>:EXTernal<gen>:FREQuency`.

\*RST: 1

**Example:** `SOUR:EXT:FREQ:COUP ON`

**SOURce<si>:EXTernal<gen>:FREQuency[:FACTor]:DENominator <Value>**

Defines the denominator of the factor with which the analyzer frequency is multiplied to obtain the transmit frequency of the selected generator.

Select the multiplication factor such that the frequency range of the generator is not exceeded if the following formula is applied to the start and stop frequency of the analyzer:

$$F_{Generator} = \left| F_{Analyzer} * \frac{Numerator}{Denominator} + F_{Offset} \right|$$

**Suffix:**

<si> irrelevant

<gen>

**Parameters:**

<Value> <numeric value>

\*RST: 1

**Example:** //Define multiplication factor of 4/3; the transmit frequency of the generator is 4/3 times the analyzer frequency

`SOUR:EXT:FREQ:NUM 4`

`SOUR:EXT:FREQ:DEN 3`

**SOURce<si>:EXTernal<gen>:FREQuency[:FACTor]:NUMerator <Value>**

Defines the numerator of the factor with which the analyzer frequency is multiplied to obtain the transmit frequency of the selected generator.

Select the multiplication factor such that the frequency range of the generator is not exceeded if the following formula is applied to the start and stop frequency of the analyzer:

$$F_{Generator} = \left| F_{Analyzer} * \frac{Numerator}{Denominator} + F_{Offset} \right|$$

**Suffix:**

<si> irrelevant

<gen>

**Parameters:**

<Value> <numeric value>  
 \*RST: 1

**Example:**

//Define multiplication factor of 4/3; the transmit frequency of the generator is 4/3 times the analyzer frequency  
 SOUR:EXT:FREQ:NUM 4  
 SOUR:EXT:FREQ:DEN 3

**SOURce<si>:EXTernal<gen>:FREQuency:OFFSet <Offset>**

Defines the frequency offset of the generator with reference to the analyzer frequency.

Select the offset such that the frequency range of the generator is not exceeded if the following formula is applied to the start and stop frequency of the analyzer:

$$F_{\text{Generator}} = \left| F_{\text{Analyzer}} * \frac{\text{Numerator}}{\text{Denominator}} + F_{\text{Offset}} \right|$$

**Suffix:**

<si> irrelevant

<gen>

**Parameters:**

<Offset> <numeric value>, specified in Hz, kHz, MHz or GHz, rounded to the nearest Hz  
 \*RST: 0 Hz  
 Default unit: HZ

**Example:**

//Define an offset between generator output frequency and analyzer frequency  
 SOUR:EXT:FREQ:OFFS 10HZ

**SOURce<si>:EXTernal<gen>:POWer[:LEVel] <Level>**

Sets the output power of the selected generator.

**Suffix:**

<si> irrelevant

<gen>

**Parameters:**

<Level> <numeric value>  
 \*RST: -20 dBm  
 Default unit: DBM

**Example:**

//Define generator output level  
 SOUR:EXT:POW -30dBm

**SOURce<si>:EXTeRnal<gen>[:STATe] <State>**

Activates or deactivates the connected external generator.

**Suffix:**

<si> irrelevant

<gen>

**Parameters:**

<State> ON | OFF | 0 | 1

**OFF | 0**

Switches the function off

**ON | 1**

Switches the function on

**SOURce<si>:POWer[:LEVeL][:IMMediate]:OFFSet <Offset>****Suffix:**

<si> irrelevant

**Parameters:**

<Offset> Range: -200 dB to +200 dB  
\*RST: 0dB  
Default unit: DB

**Example:** SOUR:POW:OFFS -10dB

**Interface configuration**

The following commands are required to configure the interface for the connection to the external generator.

SOURce<si>:EXTeRnal<gen>:ROSCillator[:SOURce].....	206
SYSTem:COMMunicate:GPIB:RDEVice:GENerator<gen>:ADDRes.....	207
SYSTem:COMMunicate:RDEVice:GENerator<gen>:INTerface.....	207
SYSTem:COMMunicate:RDEVice:GENerator<gen>:LINK.....	207
SYSTem:COMMunicate:RDEVice:GENerator<gen>:TYPE.....	208
SYSTem:COMMunicate:TCPip:RDEVice:GENerator<gen>:ADDRes.....	208

**SOURce<si>:EXTeRnal<gen>:ROSCillator[:SOURce] <Source>**

Controls selection of the reference oscillator for the external generator.

If the external reference oscillator is selected, the reference signal must be connected to the rear panel of the instrument.

**Suffix:**

<si> irrelevant

<gen> irrelevant

**Parameters:**

<Source>

**INTernal**

Uses the internal reference.

**EXTernal**

Uses the external reference; if none is available, an error flag is displayed in the status bar.

\*RST: INT

**Example:**

```
//Select an external reference oscillator
SOUR:EXT:ROSC EXT
```

**SYSTem:COMMunicate:GPIB:RDEvice:GENerator<gen>:ADDRess <Number>**

Changes the IEC/IEEE-bus address of the external generator.

**Suffix:**

<gen> 1..n

**Parameters:**

<Number>

Range: 0 to 30

\*RST: 28

**Example:**

```
SYST:COMM:GPIB:RDEV:GEN:ADDR 15
```

**SYSTem:COMMunicate:RDEvice:GENerator<gen>:INTerface <Type>**

Defines the interface used for the connection to the external generator.

Is only available if external generator control is active (see [SOURCE<si>:EXTernal<gen>\[:STATe\]](#) on page 206).

**Suffix:**

<gen>

**Parameters:**

<Type>

**GPIB**

**TCPip**

**Example:**

```
SYST:COMM:RDEV:GEN:INT TCP
```

**SYSTem:COMMunicate:RDEvice:GENerator<gen>:LINK <Type>**

Selects the link type of the external generator if the GPIB interface is used.

The difference between the two GPIB operating modes is the execution speed. During GPIB operation, each frequency to be set is transmitted to the generator separately. If the TTL interface is also used, a whole frequency list can be programmed in one go. Frequencies can then be switched per TTL handshake, which speeds up the process considerably.

Is only available if external generator control is active (see [SOURce<si>:EXTernal<gen>\[:STATe\]](#) on page 206).

**Suffix:**

&lt;gen&gt;

**Parameters:**

&lt;Type&gt;

GPIB | TTL

**GPIB**

GPIB connection without TTL synchronization (for all generators of other manufacturers and some Rohde & Schwarz devices)

**TTL**

GPIB connection with TTL synchronization (if available; for most Rohde&Schwarz devices)

\*RST: GPIB

**Example:**

SYST:COMM:RDEV:GEN:LINK TTL

Selects GPIB + TTL interface for generator operation.

**SYSTem:COMMunicate:RDEvice:GENerator<gen>:TYPE <Type>**

Selects the type of external generator.

For a list of the available generator types, see the specifications document.

**Suffix:**

&lt;gen&gt;

**Parameters:**

&lt;Name&gt;

&lt;Generator name as string value&gt;

\*RST: SMU02

**Example:**

//Select an external generator

SYST:COMM:RDEV:GEN:TYPE 'SMW06'

**SYSTem:COMMunicate:TCPIP:RDEvice:GENerator<gen>:ADDRess <Address>**

Configures the TCP/IP address for the external generator.

**Suffix:**

&lt;gen&gt;

**Parameters:**

&lt;Address&gt;

TCP/IP address between 0.0.0.0 and 0.255.255.255

\*RST: 0.0.0.0

**Example:**

SYST:COMM:TCP:RDEV:GEN:ADDR 130.094.122.195

**Source calibration**

The following commands are required to activate the calibration functions of the external tracking generator. However, they are only available if external generator control is active (see [SOURce<si>:EXTernal<gen>\[:STATe\]](#) on page 206).



Useful commands for source calibration described elsewhere:

- `DISPlay[:WINDow<n>][:SUBWindow<w>]:TRACe<t>:Y[:SCALe]:RPOSition` on page 224
- `DISPlay[:WINDow<n>][:SUBWindow<w>]:TRACe<t>:Y[:SCALe]:RVALue` on page 254

#### Remote commands exclusive to source calibration:

<code>[SENSe:]CORRection:COLLect[:ACQuire]</code> .....	209
<code>[SENSe:]CORRection:METHod</code> .....	209
<code>[SENSe:]CORRection:RECall</code> .....	210
<code>[SENSe:]CORRection[:STATe]</code> .....	210
<code>[SENSe:]CORRection:TRANsducer:GENerate</code> .....	210

---

#### `[SENSe:]CORRection:COLLect[:ACQuire] <MeasType>`

Initiates a reference measurement (calibration). The reference measurement is the basis for the measurement normalization. The result depends on whether a reflection measurement or transmission measurement is performed (see `[SENSe:]CORRection:METHod` on page 209).

To obtain a correct reference measurement, a complete sweep with synchronization to the end of the sweep must have been carried out. This is only possible in the single sweep mode.

Is only available if external generator control is active (see `SOURce<si>:EXTernal<gen>[:STATe]` on page 206).

#### Setting parameters:

`<MeasType>`            `THRough | OPEN`

##### **THRough**

"TRANsmission" mode: calibration with direct connection between generator and device input

"REFLection" mode: calibration with short circuit at the input

##### **OPEN**

only allowed in "REFLection" mode: calibration with open input

#### Example:

```
INIT:CONT OFF
```

Selects single sweep operation

```
CORR:METH TRAN
```

Selects a transmission measurement.

```
CORR:COLL THR; *WAI
```

Starts the measurement of reference data using direct connection between generator and device input and waits for the sweep end.

**Usage:**                    Setting only

---

#### `[SENSe:]CORRection:METHod <Type>`

Selects the type of measurement to be performed with the generator.

Is only available if external generator control is active (see [SOURCE<si>:EXTERNAL<gen>\[:STATe\]](#) on page 206).

**Parameters:**

&lt;Type&gt;

**REFlection**

Selects reflection measurements.

**TRANsmission**

Selects transmission measurements.

\*RST: TRANsmission

**Example:**

CORR:METH TRAN

Sets the type of measurement to "transmission".

**[SENSe:]CORRection:RECall**

Restores the measurement configuration used for calibration.

Is only available if external generator control is active (see [SOURCE<si>:EXTERNAL<gen>\[:STATe\]](#) on page 206).

**Example:**

CORR:REC

**[SENSe:]CORRection[:STATe] <State>**

Turns correction of measurement results (normalization) on and off.

The command is available after you have created a reference trace for the selected measurement type with [\[SENSe:\]CORRection:COLLect\[:ACQuire\]](#) on page 209.

Is only available if external generator control is active (see [SOURCE<si>:EXTERNAL<gen>\[:STATe\]](#) on page 206).

**Parameters:**

&lt;State&gt;

ON | OFF | 0 | 1

**OFF | 0**

Switches the function off

**ON | 1**

Switches the function on

\*RST: 1

**Example:**

CORR ON

Activates normalization.

**[SENSe:]CORRection:TRANsducer:GENerate <Name>**

Uses the normalized measurement data to generate a transducer factor with up to 1001 points. The trace data is converted to a transducer with unit dB and stored in a file with the specified name and the suffix .trd under

C:\Program Files (x86)\Rohde-Schwarz\FSW\<version>\trd. The frequency points are allocated in equidistant steps between start and stop frequency.

The generated transducer factor can be further adapted using the commands described in the "Remote Commands > Configuring the FSW > Working with Transducers" section in the FSW User Manual.

**Parameters:**

<Name>                    '<name>'

**Example:**

```
CORR:TRAN:GEN 'MyGenerator'
Creates the transducer file
C:\r_s\instr\trd\MyGenerator.trd.
```

### 11.4.3 Configuring the output

The following commands configure signal output.



Configuring trigger output is described in [Chapter 11.4.8.2, "Configuring the trigger output"](#), on page 238.

DIAGnostic:SERvice:NSource.....	211
OUTPut:ADEMod[:ONLine][:STATe].....	211
OUTPut:ADEMod[:ONLine]:SOURce.....	212
OUTPut:ADEMod[:ONLine]:AF[:CFRequency].....	212
OUTPut:ADEMod[:ONLine]:PHONes.....	212
SYSTem:SPEaker:VOLume.....	213

---

#### DIAGnostic:SERvice:NSource <State>

Turns the 28 V supply of the BNC connector labeled [noise source control] on the FSW on and off.

**Parameters:**

<State>                    ON | OFF | 0 | 1  
**OFF | 0**  
 Switches the function off  
**ON | 1**  
 Switches the function on

**Example:**                    DIAG:SERV:NSO ON

**Manual operation:**    See "[Noise Source Control](#)" on page 87

---

#### OUTPut:ADEMod[:ONLine][:STATe] <State>

Enables or disables online demodulation output to the IF/VIDEO/DEMODO output connector on the rear panel of the FSW.

**Parameters:**

<State>                    ON | OFF | 0 | 1  
**OFF | 0**  
 Switches the function off

**ON | 1**

Switches the function on

**Example:** `OUTP:ADEM ON`**Manual operation:** See "[Online Demodulation Output State](#)" on page 89**OUTPut:ADEMod[:ONLine]:SOURce <WindowName>**

Selects the result display whose results are output. Only active time domain results can be selected.

**Parameters:**

&lt;WindowName&gt;

**<string>**

String containing the name of the window.

By default, the name of a window is the same as its index. To determine the name and index of all active windows, use the [LAYout:CATalog\[:WINDow\]?](#) query.**FOCUS**

Dynamically switches to the currently selected window. If a window is selected that does not contain a time-domain result display, the selection is ignored and the previous setting is maintained.

**Example:**  
`OUTP:ADEM:ONL:SOUR 'AnalogDemod'`  
**OR:**  
`DISP:WIND1:SEL`  
`OUTP:ADEM:SOUR FOC`**Manual operation:** See "[Output Selection](#)" on page 89**OUTPut:ADEMod[:ONLine]:AF[:CFRequency] <Frequency>**Defines the cutoff frequency for the AC highpass filter (for AC coupling only, see [\[SENSe:\]ADEMod<n>:AF:COUPLing](#) on page 241).**Parameters:**

&lt;Frequency&gt;

numeric value

Range: 10 Hz to DemodBW/10 (= 300 kHz for active demodulation output)

\*RST: 100 Hz

Default unit: HZ

**Example:** `OUTP:ADEM:ONL:AF:CFR 100Hz`**Manual operation:** See "[AC Cutoff Frequency](#)" on page 89**OUTPut:ADEMod[:ONLine]:PHONes <State>**

In addition to sending the output to the IF/VIDEO/DEMODO output connector (on the rear panel of the FSW), it can also be output to headphones connected on the front panel ([Phones] connector).

**CAUTION:** To protect your hearing, make sure that the volume setting is not too high before putting on the headphones.

If you do not hear output on the connected headphones despite having enabled both general online demod output `OUTPut:ADEMod[:ONLine][:STATe]` on page 211 and this command, adjust the volume setting.

(Using `SYSTem:SPEaker:VOLume` on page 213.

**Parameters:**

<State>                    ON | OFF | 0 | 1  
                               **OFF | 0**  
                               Switches the function off  
                               **ON | 1**  
                               Switches the function on

**Example:**                `OUTP:ADEM:PHON ON`

**Manual operation:**    See "Phones Output" on page 90

**SYSTem:SPEaker:VOLume <Volume>**

Defines the volume of the built-in loudspeaker for demodulated signals. This setting is maintained for all applications.

The command is available in the time domain in Spectrum mode and in Analog Modulation Analysis mode.

**Parameters:**

<Volume>                Percentage of the maximum possible volume.  
                               Range:        0 to 1  
                               \*RST:        0.5

**Example:**                `SYST:SPE:VOL 0`  
                               Switches the loudspeaker to mute.

**Manual operation:**    See "Online Demodulation Output State" on page 89

#### 11.4.4 Digital I/Q 40G streaming output commands

The following commands are only available if the Digital I/Q 40G Streaming Output option (FSW-B517/-B1017) is installed.

For details see the FSW I/Q Analyzer and I/Q Input User Manual.

<code>OUTPut:IQHS:CDEvice?</code> .....	214
<code>OUTPut:IQHS:MARKer</code> .....	214
<code>OUTPut:IQHS:SRATe?</code> .....	214
<code>OUTPut:IQHS[:STATe]</code> .....	214

**OUTPut:IQHS:CDEvice?**

Returns a comma-separated list of information on the instrument connected to the QSFP+ connector, if available.

**Example:**           OUTP:IQHS:CDEV?  
**Result:**  
 1,IQW,1525.7551k05,900987,DIG IQ 40G A,tcpip::  
 computername::hislip0,1.9,1.1,1,1

**Usage:**            Query only

**Manual operation:** See "[Connected Instrument](#)" on page 92

**OUTPut:IQHS:MARKer**

Inserts marker information to the data stream during a running I/Q data output recording. Useful to mark a specific event during the measurement that you detect in the result window, for example. Then you can search for the marker information in the output data to analyze the effects at that time.

**Usage:**            Event

**Manual operation:** See "[Insert Marker](#)" on page 91

**OUTPut:IQHS:SRATe?**

Returns the currently used sample rate to transfer data via the Digital I/Q 40G Streaming Output interface.

**Usage:**            Query only

**Manual operation:** See "[Output Settings Information](#)" on page 91

**OUTPut:IQHS[:STATe] <State>**

Enables or disables a digital output stream to the optional QSFP+ connector, if available.

**Parameters:**

<State>            ON | OFF | 0 | 1  
**OFF | 0**  
 Switches the function off  
**ON | 1**  
 Switches the function on  
 \*RST:            0

**Manual operation:** See "[Digital I/Q 40G Streaming Out](#)" on page 91

## 11.4.5 Frequency settings

[SENSe:]FREQUENCY:CENTer.....	215
[SENSe:]FREQUENCY:CENTer:STEP.....	215
[SENSe:]FREQUENCY:CENTer:STEP:LINK.....	215
[SENSe:]FREQUENCY:CENTer:STEP:LINK:FACTOR.....	216

---

### [SENSe:]FREQUENCY:CENTer <Frequency>

Defines the center frequency.

**Parameters:**

<Frequency> For the allowed range and  $f_{max}$ , refer to the specifications document.  
 \*RST:  $f_{max}/2$   
 Default unit: Hz

**Example:**

```
FREQ:CENT 100 MHz
FREQ:CENT:STEP 10 MHz
FREQ:CENT UP
Sets the center frequency to 110 MHz.
```

**Manual operation:** See "[Center Frequency](#)" on page 50

---

### [SENSe:]FREQUENCY:CENTer:STEP <StepSize>

Defines the center frequency step size.

You can increase or decrease the center frequency quickly in fixed steps using the SENS:FREQ UP AND SENS:FREQ DOWN commands, see [SENSe:]FREQUENCY:CENTer on page 215.

**Parameters:**

<StepSize> For  $f_{max}$ , refer to the specifications document.  
 Range: 1 to  $f_{MAX}$   
 \*RST: 0.1 x span  
 Default unit: Hz

**Example:**

```
//Set the center frequency to 110 MHz.
FREQ:CENT 100 MHz
FREQ:CENT:STEP 10 MHz
FREQ:CENT UP
```

**Manual operation:** See "[Center Frequency Stepsize](#)" on page 51

---

### [SENSe:]FREQUENCY:CENTer:STEP:LINK <CouplingType>

Couples and decouples the center frequency step size to the span or the resolution bandwidth.

**Parameters:**

<CouplingType> SPAN | RBW | OFF

**SPAN**

Couples the step size to the span. Available for measurements in the frequency domain.  
(for RF spectrum result display)

**RBW**

Couples the step size to the resolution bandwidth. Available for measurements in the time domain.  
(for all result displays except RF spectrum)

**OFF**

Decouples the step size.

\*RST: SPAN

**Example:** //Couple step size to span  
FREQ:CENT:STEP:LINK SPAN

**Manual operation:** See "[Center Frequency Stepsize](#)" on page 51

**[SENSe:]FREQuency:CENTer:STEP:LINK:FACTor <Factor>**

Defines a step size factor if the center frequency step size is coupled to the span or the resolution bandwidth.

**Parameters:**

<Factor> 1 to 100 PCT  
\*RST: 10  
Default unit: PCT

**Example:** //Couple frequency step size to span and define a step size factor  
FREQ:CENT:STEP:LINK SPAN  
FREQ:CENT:STEP:LINK:FACT 20PCT

**Manual operation:** See "[Center Frequency Stepsize](#)" on page 51

## 11.4.6 Configuring the vertical axis (amplitude, scaling)

The following commands are required to configure the amplitude and vertical axis settings in a remote environment.

- [Amplitude settings](#).....216
- [Configuring the attenuation](#).....218
- [Configuring a preamplifier](#).....221
- [Scaling the Y-axis](#).....223

### 11.4.6.1 Amplitude settings

Useful commands for amplitude configuration described elsewhere:

- [\[SENSe:\]ADJust:LEVel](#) on page 263



**Remote commands exclusive to amplitude configuration:**

CALCulate<n>:MARKer<m>:FUNction:REFerence.....	217
UNIT<n>:POWER.....	217
CALCulate<n>:UNIT:POWER.....	217
DISPlay[:WINDow<n>][:SUBWindow<w>]:TRACe<t>:Y[:SCALe]:RLEVel.....	217
DISPlay[:WINDow<n>][:SUBWindow<w>]:TRACe<t>:Y[:SCALe]:RLEVel:OFFSet.....	218

**CALCulate<n>:MARKer<m>:FUNction:REFerence**

Matches the reference level to the power level of a marker.

If you use the command in combination with a delta marker, that delta marker is turned into a normal marker.

**Suffix:**

<n>                      Window

<m>                      Marker

**Example:**

CALC:MARK2:FUNC:REF

Sets the reference level to the level of marker 2.

**UNIT<n>:POWER <Unit>****CALCulate<n>:UNIT:POWER <Unit>**

Selects the unit of the y-axis.

The unit applies to all power-based measurement windows with absolute values.

**Suffix:**

<n>                      irrelevant

**Parameters:**

<Unit>                      DBM | V | A | W | DBPW | WATT | DBUV | DBMV | VOLT |  
DBUA | AMPere | DBM\_mhz | DBM\_hz | DBUa\_mhz |  
DBUV\_mhz | DBmV\_mhz | DBpW\_mhz

(Units based on 1 MHz require installed R&S FSW-K54 (EMI measurements) option.)

\*RST:                      dBm

**Example:**

CALC:UNIT:POW DBM

Sets the power unit to dBm.

**Manual operation:** See "Unit" on page 47

**DISPlay[:WINDow<n>][:SUBWindow<w>]:TRACe<t>:Y[:SCALe]:RLEVel  
<ReferenceLevel>**

Defines the reference level (for all traces in all windows).

With a reference level offset ≠ 0, the value range of the reference level is modified by the offset.

**Suffix:**

<n>	irrelevant
<w>	subwindow Not supported by all applications
<t>	irrelevant

**Parameters:**

<ReferenceLevel>	The unit is variable. Range: see specifications document *RST: 0 dBm Default unit: DBM
------------------	---

**Example:** `DISP:TRAC:Y:RLEV -60dBm`

**Manual operation:** See "[Reference Level](#)" on page 46

**DISPlay[:WINDow<n>][:SUBWindow<w>]:TRACe<t>:Y[:SCALe]:RLEVel:OFFSet**  
<Offset>

Defines a reference level offset (for all traces in all windows).

**Suffix:**

<n>	irrelevant
<w>	subwindow Not supported by all applications
<t>	irrelevant

**Parameters:**

<Offset>	Range: -200 dB to 200 dB *RST: 0dB Default unit: DB
----------	---

**Example:** `DISP:TRAC:Y:RLEV:OFFS -10dB`

**Manual operation:** See "[Shifting the Display \(Offset\)](#)" on page 47

#### 11.4.6.2 Configuring the attenuation

<a href="#">INPut:ATTenuation</a> .....	218
<a href="#">INPut:ATTenuation:AUTO</a> .....	219
<a href="#">INPut:ATTenuation:AUTO:MODE</a> .....	219
<a href="#">INPut:EATT</a> .....	220
<a href="#">INPut:EATT:AUTO</a> .....	220
<a href="#">INPut:EATT:STATe</a> .....	220

**INPut:ATTenuation** <Attenuation>

Defines the total attenuation for RF input.

If an electronic attenuator is available and active, the command defines a mechanical attenuation (see [INPut:EATT:STATe](#) on page 220).

If you set the attenuation manually, it is no longer coupled to the reference level, but the reference level is coupled to the attenuation. Thus, if the current reference level is not compatible with an attenuation that has been set manually, the command also adjusts the reference level.

Is not available if the optional "Digital Baseband" interface is active.

**Parameters:**

<Attenuation>      Range:      see specifications document  
 Increment:    5 dB (with optional electr. attenuator: 1 dB)  
 \*RST:          10 dB (AUTO is set to ON)  
 Default unit: DB

**Example:**

INP:ATT 30dB  
 Defines a 30 dB attenuation and decouples the attenuation from the reference level.

**Manual operation:** See "[Attenuation Mode / Value](#)" on page 48

**INPut:ATTenuation:AUTO <State>**

Couples or decouples the attenuation to the reference level. Thus, when the reference level is changed, the FSW determines the signal level for optimal internal data processing and sets the required attenuation accordingly.

Is not available if the optional "Digital Baseband" interface is active.

**Parameters:**

<State>              ON | OFF | 0 | 1  
 \*RST:                1

**Example:**

INP:ATT:AUTO ON  
 Couples the attenuation to the reference level.

**Manual operation:** See "[Attenuation Mode / Value](#)" on page 48

**INPut:ATTenuation:AUTO:MODE <OptMode>**

Selects the priority for signal processing *after* the RF attenuation has been applied.

**Parameters:**

<OptMode>            LNOise | LDISTortion  
**LNOise**  
 Optimized for high sensitivity and low noise levels  
**LDISTortion**  
 Optimized for low distortion by avoiding intermodulation  
 \*RST:                LDISTortion (WLAN application: LNOise)

**Example:**

INP:ATT:AUTO:MODE LNO

**INPut:EATT** <Attenuation>

Defines an electronic attenuation manually. Automatic mode must be switched off (INP:EATT:AUTO OFF, see INPut:EATT:AUTO on page 220).

If the current reference level is not compatible with an attenuation that has been set manually, the command also adjusts the reference level.

Requires the electronic attenuation hardware option.

It is not available if the optional "Digital Baseband" interface is active.

**Parameters:**

<Attenuation>           attenuation in dB  
 Range:            see specifications document  
 Increment:        1 dB  
 \*RST:             0 dB (OFF)  
 Default unit:     DB

**Example:**            INP:EATT:AUTO OFF  
                           INP:EATT 10 dB

**Manual operation:** See ["Using Electronic Attenuation"](#) on page 48

**INPut:EATT:AUTO** <State>

Turns automatic selection of the electronic attenuation on and off.

If on, electronic attenuation reduces the mechanical attenuation whenever possible.

Requires the electronic attenuation hardware option.

It is not available if the optional "Digital Baseband" interface is active.

**Parameters:**

<State>                ON | OFF | 0 | 1  
                           **OFF | 0**  
                           Switches the function off  
                           **ON | 1**  
                           Switches the function on  
                           \*RST:        1

**Example:**            INP:EATT:AUTO OFF

**Manual operation:** See ["Using Electronic Attenuation"](#) on page 48

**INPut:EATT:STATe** <State>

Turns the electronic attenuator on and off.

Requires the electronic attenuation hardware option.

It is not available if the optional "Digital Baseband" interface is active.

**Parameters:**

<State> ON | OFF | 0 | 1  
**OFF | 0**  
 Switches the function off  
**ON | 1**  
 Switches the function on  
 \*RST: 0

**Example:**

INP:EATT:STAT ON  
 Switches the electronic attenuator into the signal path.

**Manual operation:** See ["Using Electronic Attenuation"](#) on page 48

### 11.4.6.3 Configuring a preamplifier

INPut:EGain[:STATe].....	221
INPut:GAIN:STATe.....	222
INPut:GAIN[:VALue].....	222

---

**INPut:EGain[:STATe] <State>**

Before this command can be used, the external preamplifier must be connected to the FSW. See the preamplifier's documentation for details.

When activated, the FSW automatically compensates the magnitude and phase characteristics of the external preamplifier in the measurement results.

Note that when an optional external preamplifier is activated, the internal preamplifier is automatically disabled, and vice versa.

For FSW85 models with two RF inputs, you must enable correction from the external preamplifier for each input individually. Correction cannot be enabled for both inputs at the same time.

When deactivated, no compensation is performed even if an external preamplifier remains connected.

**Parameters:**

<State> ON | OFF | 0 | 1  
**OFF | 0**  
 No data correction is performed based on the external preamplifier  
**ON | 1**  
 Performs data corrections based on the external preamplifier  
 \*RST: 0

**Example:**

INP:EGA ON

**Manual operation:** See ["Ext. PA Correction"](#) on page 49

**INPut:GAIN:STATe** <State>

Turns the internal preamplifier on and off. It requires the optional preamplifier hardware.

Note that if an optional external preamplifier is activated, the internal preamplifier is automatically disabled, and vice versa.

Is not available for input from the optional "Digital Baseband" interface.

For FSW 8 or 13 models, the preamplification is defined by `INPut:GAIN[:VALue]`.

For FSW 26 or higher models, the input signal is amplified by 30 dB if the preamplifier is activated.

If option R&S FSW-B22 is installed, the preamplifier is only active below 7 GHz.

If option R&S FSW-B24 is installed, the preamplifier is active for all frequencies.

**Parameters:**

<State>                    ON | OFF | 0 | 1  
                               **OFF | 0**  
                               Switches the function off  
                               **ON | 1**  
                               Switches the function on  
                               \*RST:        0

**Example:**

```
INP:GAIN:STAT ON
INP:GAIN:VAL 15
Switches on 15 dB preamplification.
```

**Manual operation:** See "[Preamplifier](#)" on page 49

**INPut:GAIN[:VALue]** <Gain>

Selects the "gain" if the preamplifier is activated (`INP:GAIN:STAT ON`, see [INPut:GAIN:STATe](#) on page 222).

The command requires the additional preamplifier hardware option.

**Parameters:**

<Gain>                    For all FSW models except for FSW85, the following settings are available:  
                               15 dB and 30 dB  
                               All other values are rounded to the nearest of these two.  
                               For FSW85 models:  
                               FSW43 or higher:  
                               30 dB  
                               Default unit: DB

**Example:**

```
INP:GAIN:STAT ON
INP:GAIN:VAL 30
Switches on 30 dB preamplification.
```

**Manual operation:** See "[Preamplifier](#)" on page 49

#### 11.4.6.4 Scaling the Y-axis

DISPlay[:WINDow<n>][:SUBWindow<w>]:TRACe<t>:Y[:SCALe].....	223
DISPlay[:WINDow<n>][:SUBWindow<w>]:TRACe<t>:Y[:SCALe]:AUTO ONCE.....	223
DISPlay[:WINDow<n>][:SUBWindow<w>]:TRACe<t>:Y[:SCALe]:MODE.....	223
DISPlay[:WINDow<n>][:SUBWindow<w>]:TRACe<t>:Y[:SCALe]:PDIVision.....	224
DISPlay[:WINDow<n>][:SUBWindow<w>]:TRACe<t>:Y[:SCALe]:RPOStion.....	224
DISPlay[:WINDow<n>][:SUBWindow<w>]:TRACe<t>:Y:SPACing.....	225

---

#### DISPlay[:WINDow<n>][:SUBWindow<w>]:TRACe<t>:Y[:SCALe] <Range>

Defines the display range of the y-axis (for all traces).

##### Suffix:

<n>	Window
<w>	subwindow Not supported by all applications
<t>	irrelevant

##### Parameters:

<Range>	If the y-axis shows the power, the unit is dB with a range from 10 dB to 200 dB. If the y-axis shows the frequency, the unit is Hz with a variable range. *RST: 100 dB (frequency domain), 500 kHz (time domain)
---------	--

**Example:** DISP:TRAC:Y 110dB

**Manual operation:** See "Range" on page 80

---

#### DISPlay[:WINDow<n>][:SUBWindow<w>]:TRACe<t>:Y[:SCALe]:AUTO ONCE

Automatic scaling of the y-axis is performed once, then switched off again (for all traces).

##### Suffix:

<n>	Window
<t>	irrelevant

**Manual operation:** See "Auto Scale Once" on page 80

---

#### DISPlay[:WINDow<n>][:SUBWindow<w>]:TRACe<t>:Y[:SCALe]:MODE <Mode>

Selects the type of scaling of the y-axis (for all traces).

When the display update during remote control is off, this command has no immediate effect.

##### Suffix:

<n>	Window
<w>	subwindow

<t> irrelevant

**Parameters:**

<Mode>           **ABSolute**  
absolute scaling of the y-axis

**RELative**  
relative scaling of the y-axis

\*RST:           ABSolute

**Example:**           DISP:TRAC:Y:MODE REL

**Manual operation:** See "[Scaling](#)" on page 81

**DISPlay[:WINDow<n>][:SUBWindow<w>]:TRACe<t>:Y[:SCALe]:PDIVision**  
<Value>

This remote command determines the grid spacing on the Y-axis for all diagrams, where possible.

In spectrum displays, for example, this command is not available.

**Suffix:**

<n>                    [Window](#)

<w>                    subwindow  
Not supported by all applications

<t>                    irrelevant

**Parameters:**

<Value>              numeric value WITHOUT UNIT (unit according to the result display)  
Defines the range per division (total range = 10\*[Value](#))

\*RST:                depends on the result display  
Default unit: DBM

**Example:**           DISP:TRAC:Y:PDIV 10  
Sets the grid spacing to 10 units (e.g. dB) per division

**Manual operation:** See "[Dev per Division/ dB per Division](#)" on page 77

**DISPlay[:WINDow<n>][:SUBWindow<w>]:TRACe<t>:Y[:SCALe]:RPOSITION**  
<Position>

Defines the vertical position of the reference level on the display grid (for all traces).

The FSW adjusts the scaling of the y-axis accordingly.

For measurements with the optional external generator control, the command defines the position of the reference value.

**Suffix:**

<n>                    [Window](#)



<w>	subwindow Not supported by all applications
<t>	irrelevant
<b>Parameters:</b>	
<Position>	*RST: 100 PCT = AF spectrum display; 50 PCT = time display
<b>Example:</b>	DISP:TRAC:Y:RPOS 50PCT
<b>Manual operation:</b>	See "Reference Value Position" on page 78 See "Ref Level Position" on page 80

---

**DISPlay[:WINDow<n>][:SUBWIndow<w>]:TRACe<t>:Y:SPACing <ScalingType>**

Selects the scaling of the y-axis (for all traces, <t> is irrelevant).

For AF spectrum displays, only the parameters "LINear" and "LOGarithmic" are permitted.

**Suffix:**

<n> [Window](#)

<w> subwindow

<t> [Trace](#)

**Parameters:**

<ScalingType> **LOGarithmic**  
Logarithmic scaling.

**LINear**  
Linear scaling in %.

**LDB**  
Linear scaling in the specified unit.

**PERCent**  
Linear scaling in %.

\*RST: LOGarithmic

**Example:** DISP:TRAC:Y:SPAC LIN  
Selects linear scaling in %.

**Manual operation:** See "Deviation" on page 79  
See "Scaling" on page 81

### 11.4.7 Configuring data acquisition

The following remote commands are required to configure which data is to be acquired and then demodulated in a remote environment.



**Parameters:**

<b>&lt;SampleRate&gt;</b>	<p><b>numeric value</b></p> <p>The frequency at which measurement values are taken from the A/D-converter and stored in I/Q memory.</p> <p>Allowed range: refer to <a href="#">Chapter 4.3, "Sample rate and demodulation bandwidth"</a>, on page 30.</p> <p>*RST: 8 MHz</p> <p>Default unit: HZ</p>
<b>&lt;RecordLength&gt;</b>	<p>Number of samples to be stored in I/Q memory.</p> <p>Range: 1 to 400001 with AF filter or AF trigger active, 1 to 480001 with both AF filter and AF trigger deactive</p> <p>*RST: 501)</p>
<b>&lt;TriggerSource&gt;</b>	<p>Selection of the trigger source to use for the demodulator. For details on trigger sources see <a href="#">"Trigger Source"</a> on page 52.</p> <p><b>Note:</b> After selecting IF Power, the trigger threshold can be set with the <code>TRIGger[:SEquence]:LEVel:IFPower</code> command.</p> <p>*RST: IMMEDIATE</p>
<b>&lt;TriggerSlope&gt;</b>	<p>POSitive   NEGative</p> <p>Used slope of the trigger signal.</p> <p>The value indicated here will be ignored for &lt;trigger source&gt; = IMMEDIATE.</p> <p>*RST: POSitive</p>
<b>&lt;OffsetSamples&gt;</b>	<p>Number of samples to be used as an offset to the trigger signal. For details refer to <a href="#">Chapter 4.3, "Sample rate and demodulation bandwidth"</a>, on page 30.</p> <p>The value indicated here is ignored for &lt;trigger source&gt; = "IMMEDIATE".</p> <p>*RST: 0</p>
<b>&lt;NoOfMeas&gt;</b>	<p>Number of repetitions of the measurement to be executed. The value indicated here is especially necessary for the average/maxhold/minhold function.</p> <p>Range: 0 to 32767</p> <p>*RST: 0</p>
<b>Example:</b>	<pre>ADEM:SET 8MHz,32000,EXT,POS,-500,30</pre> <p>Performs a measurement at:</p> <ul style="list-style-type: none"> <li>sample rate = 8 MHz</li> <li>record length = 32000</li> <li>trigger source = EXTERNAL</li> <li>trigger slope = POSitive</li> <li>offset samples = -500 (500 samples before trigger occurred)</li> <li># of meas = 30</li> </ul>

---

**[SENSe:]ADEMod<n>:SPECtrum:Bandwidth[:RESolution] <Bandwidth>**  
**[SENSe:]ADEMod:SPECtrum:BWIDth[:RESolution] <Bandwidth>**

Defines the resolution bandwidth for data acquisition.

From the specified RBW and the demodulation span set by [\[SENSe:\]ADEMod:SPECtrum:SPAN\[:MAXimum\]](#) on page 248 or [\[SENSe:\]BWIDth:DEMod](#) on page 228, the required measurement time is calculated. If the available measurement time is not sufficient for the given bandwidth, the measurement time is set to its maximum and the resolution bandwidth is increased to the resulting bandwidth.

Is identical to `SENS:BAND:RES`, see the FSW User Manual.

**Parameters:**

<Bandwidth> Refer to specifications document.  
 \*RST: 61.2 kHz  
 Default unit: HZ

**Example:**

ADEM:SPEC:BAND 61.2kHz  
 Sets the resolution bandwidth to 61.2 kHz.

---

**[SENSe:]ADEMod:SRATe**

---

**[SENSe:]BANDwidth:DEMod <Bandwidth>**  
**[SENSe:]BWIDth:DEMod <Bandwidth>**

Sets the bandwidth for Analog Modulation Analysis. Depending on the selected demodulation bandwidth, the instrument selects the required sample rate.

For details on the correlation between demodulation bandwidth and sample rate refer to [Chapter 4.3, "Sample rate and demodulation bandwidth"](#), on page 30.

Is identical to `SENS:ADEM:BAND:DEM`.

**Parameters:**

<Bandwidth> \*RST: 5 MHz  
 Default unit: HZ

**Example:**

BAND:DEM 1MHz  
 Sets demodulation bandwidth to 1 MHz

**Manual operation:** See ["Demodulation Bandwidth"](#) on page 61

---

**[SENSe:]BANDwidth:DEMod:TYPE <FilterType>**  
**[SENSe:]BWIDth:DEMod:TYPE <FilterType>**

Defines the type of demodulation filter to be used.

Is identical to `SENS:ADEM:BAND:DEM:TYPE`.

**Parameters:**

<FilterType> **FLAT**  
 Standard flat demodulation filter

**GAUSS**

Gaussian filter for optimized settling behavior

\*RST: FLAT

**Manual operation:** See "[Demodulation Filter](#)" on page 62

**[SENSe:]BANDwidth[:RESolution] <Bandwidth>**

Defines the resolution bandwidth and decouples the resolution bandwidth from the span.

For statistics measurements, this command defines the **demodulation** bandwidth.

The 6 MHz Gaussian filter is provided for special measurements, such as 5G NR spurious emissions measurements. It is only available if you enter the value manually, not using the `BAND:RES MAX` command. It is not supported by all applications.

**Parameters:**

<Bandwidth> refer to specifications document

\*RST: RBW: AUTO is set to ON; DBW: 3MHz

Default unit: Hz

**Example:**

`BAND 1 MHz`

Sets the resolution bandwidth to 1 MHz

**Manual operation:** See "[Resolution Bandwidth](#)" on page 62

**[SENSe:]SWEep:COUNT <SweepCount>**

Defines the number of sweeps that the application uses to average traces.

In continuous sweep mode, the application calculates the moving average over the average count.

In single sweep mode, the application stops the measurement and calculates the average after the average count has been reached.

**Parameters:**

<SweepCount> When you set a sweep count of 0 or 1, the FSW performs one single sweep in single sweep mode.

In continuous sweep mode, if the sweep count is set to 0, a moving average over 10 sweeps is performed.

Range: 0 to 200000

\*RST: 0

**Example:**

`SWE:COUN 64`

Sets the number of sweeps to 64.

`INIT:CONT OFF`

Switches to single sweep mode.

`INIT;*WAI`

Starts a sweep and waits for its end.

**Manual operation:** See "[Sweep/Average Count](#)" on page 65

**[SENSe:]SWEep[:WINDow<n>]:POINts <SweepPoints>**

This command defines the number of sweep points to analyze after a sweep.

**Suffix:**

<n>

**Parameters:**

<SweepPoints>      Range:      101 to 100001  
                          \*RST:      1001

**Example:**              SWE:POIN 251

**Manual operation:**    See "[Sweep Points](#)" on page 65

## 11.4.8 Triggering

The following remote commands are required to configure a triggered measurement in a remote environment.



\*OPC should be used after requesting data. This will hold off any subsequent changes to the selected trigger source, until after the sweep is completed and the data is returned.

- [Configuring the triggering conditions](#).....230
- [Configuring the trigger output](#).....238

### 11.4.8.1 Configuring the triggering conditions

The following commands are required to configure a triggered measurement.

Useful commands for configuring triggers described elsewhere:

- [TRIGger\[:SEquence\]:OSCilloscope:COUpling](#) on page 182

**Remote commands exclusive to configuring triggers:**

<a href="#">TRIGger[:SEquence]:DTIME</a> .....	231
<a href="#">TRIGger[:SEquence]:HOLDoff[:TIME]</a> .....	231
<a href="#">TRIGger[:SEquence]:IFPower:HOLDoff</a> .....	231
<a href="#">TRIGger[:SEquence]:IFPower:HYSteresis</a> .....	232
<a href="#">TRIGger[:SEquence]:LEVel:BBPower</a> .....	232
<a href="#">TRIGger[:SEquence]:LEVel[:EXternal&lt;port&gt;]</a> .....	232
<a href="#">TRIGger[:SEquence]:LEVel:IFPower</a> .....	233
<a href="#">TRIGger[:SEquence]:LEVel:IQPower</a> .....	233
<a href="#">TRIGger[:SEquence]:LEVel:RFPower</a> .....	233
<a href="#">TRIGger[:SEquence]:LEVel:AM:RELative</a> .....	234
<a href="#">TRIGger[:SEquence]:LEVel:AM[:ABSolute]</a> .....	234
<a href="#">TRIGger[:SEquence]:LEVel:FM</a> .....	234
<a href="#">TRIGger[:SEquence]:LEVel:PM</a> .....	235

TRIGger[:SEQuence]:SLOPe.....	235
TRIGger[:SEQuence]:SOURce.....	235
TRIGger[:SEQuence]:TIME:RINTerval.....	238

---

### TRIGger[:SEQuence]:DTIME <DropoutTime>

Defines the time the input signal must stay below the trigger level before a trigger is detected again.

For input from the "Analog Baseband" interface using the baseband power trigger (BBP), the default drop out time is set to 100 ns to avoid unintentional trigger events (as no hysteresis can be configured in this case).

#### Parameters:

<DropoutTime> Dropout time of the trigger.  
 Range: 0 s to 10.0 s  
 \*RST: 0 s  
 Default unit: S

**Manual operation:** See "[Drop-Out Time](#)" on page 58

---

### TRIGger[:SEQuence]:HOLDoff[:TIME] <Offset>

Defines the time offset between the trigger event and the start of the sweep.

#### Parameters:

<Offset> \*RST: 0 s  
 Default unit: S

**Example:** TRIG:HOLD 500us

**Manual operation:** See "[Trigger Offset](#)" on page 57

---

### TRIGger[:SEQuence]:IFPower:HOLDoff <Period>

Defines the holding time before the next trigger event.

Note that this command can be used for **any trigger source**, not just IF Power (despite the legacy keyword).

**Note:** If you perform gated measurements in combination with the IF Power trigger, the FSW ignores the holding time for frequency sweep, FFT sweep, zero span and I/Q data measurements.

#### Parameters:

<Period> Range: 0 s to 10 s  
 \*RST: 0 s  
 Default unit: S

**Example:** TRIG:SOUR EXT  
 Sets an external trigger source.  
 TRIG:IFP:HOLD 200 ns  
 Sets the holding time to 200 ns.

**Manual operation:** See ["Trigger Holdoff"](#) on page 58

### TRIGger[:SEQuence]:IFPower:HYSteresis <Hysteresis>

Defines the trigger hysteresis, which is only available for "IF Power" trigger sources.

**Parameters:**

<Hysteresis>            Range:        3 dB to 50 dB  
                              \*RST:        3 dB  
                              Default unit: DB

**Example:**

```
TRIG:SOUR IFP
Sets the IF power trigger source.
TRIG:IFP:HYST 10DB
Sets the hysteresis limit value.
```

**Manual operation:** See ["Hysteresis"](#) on page 57

### TRIGger[:SEQuence]:LEVel:BBPower <Level>

Sets the level of the baseband power trigger.

Is available for the optional "Digital Baseband" interface.

Is available for the optional "Analog Baseband" interface.

**Parameters:**

<Level>                Range:        -50 dBm to +20 dBm  
                              \*RST:        -20 dBm  
                              Default unit: DBM

**Example:**

```
TRIG:LEV:BBP -30DBM
```

**Manual operation:** See ["Trigger Level"](#) on page 56

### TRIGger[:SEQuence]:LEVel[:EXTERNAL<port>] <TriggerLevel>

Defines the level the external signal must exceed to cause a trigger event.

Note that the variable "Input/Output" connectors (ports 2+3) must be set for use as input using the [OUTPut:TRIGger<tp>:DIRection](#) command.

**Suffix:**

<port>                Selects the trigger port.  
                              1 = trigger port 1 (TRIGGER INPUT connector on front panel)  
                              2 = trigger port 2 (TRIGGER INPUT/OUTPUT connector on front panel)  
                              (Not available for FSW85 models with two RF input connectors.)  
                              3 = trigger port 3 (TRIGGER3 INPUT/OUTPUT connector on rear panel)



**Parameters:**

<TriggerLevel>      Range:      0.5 V to 3.5 V  
                          \*RST:      1.4 V  
                          Default unit: V

**Example:**            TRIG:LEV 2V

**Manual operation:** See ["Trigger Level"](#) on page 56

**TRIGger[:SEQuence]:LEVel:IFPower** <TriggerLevel>

Defines the power level at the third intermediate frequency that must be exceeded to cause a trigger event.

Note that any RF attenuation or preamplification is considered when the trigger level is analyzed. If defined, a reference level offset is also considered.

For compatibility reasons, this command is also available for the "Baseband Power" trigger source when using the "Analog Baseband" interface.

**Parameters:**

<TriggerLevel>      For details on available trigger levels and trigger bandwidths, see the specifications document.  
                          \*RST:      -20 dBm  
                          Default unit: DBM

**Example:**            TRIG:LEV:IFP -30DBM

**Manual operation:** See ["Trigger Level"](#) on page 56

**TRIGger[:SEQuence]:LEVel:IQPower** <TriggerLevel>

Defines the magnitude the I/Q data must exceed to cause a trigger event.

Note that any RF attenuation or preamplification is considered when the trigger level is analyzed. If defined, a reference level offset is also considered.

**Parameters:**

<TriggerLevel>      Range:      -130 dBm to 30 dBm  
                          \*RST:      -20 dBm  
                          Default unit: DBM

**Example:**            TRIG:LEV:IQP -30DBM

**Manual operation:** See ["Trigger Level"](#) on page 56

**TRIGger[:SEQuence]:LEVel:RFPower** <TriggerLevel>

Defines the power level the RF input must exceed to cause a trigger event. Note that any RF attenuation or preamplification is considered when the trigger level is analyzed. If defined, a reference level offset is also considered.

The input signal must be between 500 MHz and 8 GHz.

**Parameters:**

<TriggerLevel> For details on available trigger levels and trigger bandwidths, see the specifications document.

\*RST: -20 dBm

Default unit: DBM

**Example:**

TRIG:LEV:RFP -30dBm

**Manual operation:** See "[Trigger Level](#)" on page 56

**TRIGger[:SEQuence]:LEVel:AM:RELative <Level>**

The command sets the level when AM-modulated signals are used as trigger source.

For triggering to be successful, the measurement time must cover at least 5 periods of the audio signal.

**Parameters:**

<Level> Range: -100 to +100

\*RST: 0 %

Default unit: %

**Example:**

TRIG:LEV:AM:REL -20 %

Sets the AM trigger threshold to -20 %

**Manual operation:** See "[Trigger Level](#)" on page 56

**TRIGger[:SEQuence]:LEVel:AM[:ABSolute] <Level>**

The command sets the level when RF power signals are used as trigger source.

For triggering to be successful, the measurement time must cover at least 5 periods of the audio signal.

**Parameters:**

<Level> Range: -100 to +30

\*RST: -20 dBm

Default unit: dBm

**Example:**

TRIG:LEV:AM -30 dBm

Sets the RF power signal trigger threshold to -30 dBm

**Manual operation:** See "[Trigger Level](#)" on page 56

**TRIGger[:SEQuence]:LEVel:FM <Level>**

The command sets the level when FM-modulated signals are used as trigger source.

For triggering to be successful, the measurement time must cover at least 5 periods of the audio signal.

**Parameters:**

<Level>                    Range:        -10 to +10  
                               \*RST:        0 Hz  
                               Default unit: MHz

**Example:**

TRIG:LEV:FM 10 kHz  
 Sets the FM trigger threshold to 10 kHz

**Manual operation:** See ["Trigger Level"](#) on page 56

**TRIGger[:SEQuence]:LEVel:PM <Level>**

The command sets the level when PM-modulated signals are used as trigger source.

For triggering to be successful, the measurement time must cover at least 5 periods of the audio signal.

**Parameters:**

<Level>                    Range:        -1000 to +1000  
                               \*RST:        0 RAD  
                               Default unit: RAD | DEG

**Example:**

TRIG:LEV:PM 1.2 RAD  
 Sets the PM trigger threshold to 1.2 rad

**Manual operation:** See ["Trigger Level"](#) on page 56

**TRIGger[:SEQuence]:SLOPe <Type>**

For all trigger sources except time, you can define whether triggering occurs when the signal rises to the trigger level or falls down to it.

**Parameters:**

<Type>                    POSitive | NEGative  
                               **POSitive**  
                               Triggers when the signal rises to the trigger level (rising edge).  
                               **NEGative**  
                               Triggers when the signal drops to the trigger level (falling edge).  
                               \*RST:        POSitive

**Example:**

TRIG:SLOP NEG

**Manual operation:** See ["Slope"](#) on page 58

**TRIGger[:SEQuence]:SOURce <Source>**

Selects the trigger source.

For triggering with AF, AM, AMRelative, FM, and PM trigger sources to be successful, the measurement time must cover at least 5 periods of the audio signal. For details on trigger sources, see ["Trigger Source"](#) on page 52.

**Note on external triggers:**

If a measurement is configured to wait for an external trigger signal in a remote control program, remote control is blocked until the trigger is received and the program can continue. Make sure that this situation is avoided in your remote control programs.

**Parameters:**

<Source>

**IMMediate**

Free Run

**EXTernal**

Trigger signal from the "Trigger Input" connector.

If the optional 2 GHz bandwidth extension (B2000/B5000) is installed and active, this parameter activates the "Ch3" input connector on the oscilloscope. Then the FSW triggers when the signal fed into the "Ch3" input connector on the oscilloscope meets or exceeds the specified trigger level.

**Note:** In previous firmware versions, the external trigger was connected to the "Ch2" input on the oscilloscope. As of firmware version FSW 2.30, the "**Ch3**" input on the oscilloscope must be used!

If power splitter mode is active, this parameter activates the "EXT TRIGGER INPUT" connector on the oscilloscope. Then the FSW triggers when the signal fed into the "EXT TRIGGER INPUT" connector on the oscilloscope meets or exceeds the specified trigger level.

**EXT2**

Trigger signal from the "Trigger Input/Output" connector.

For FSW85 models, Trigger 2 is not available due to the second RF input connector on the front panel. The trigger signal is taken from the "Trigger Input/Output" connector on the rear panel.

Note: Connector must be configured for "Input".

**EXT3**

Trigger signal from the "TRIGGER 3 INPUT/ OUTPUT" connector.

Note: Connector must be configured for "Input".

**RFPower**

First intermediate frequency

(Frequency and time domain measurements only.)

Not available for input from the optional "Analog Baseband" interface.

Not available for input from the optional "Digital Baseband" interface.

**IFPower**

Second intermediate frequency

Not available for input from the optional "Digital Baseband" interface.

For input from the optional "Analog Baseband" interface, this parameter is interpreted as `BBPower` for compatibility reasons.

**IQPower**

Magnitude of sampled I/Q data

For applications that process I/Q data, such as the I/Q Analyzer or optional applications.

Not available for input from the optional "Digital Baseband" interface.

**TIME**

Time interval

**BBPower**

Baseband power

For input from the optional "Analog Baseband" interface.

For input from the optional "Digital Baseband" interface.

**PSEN**

External power sensor

**AF**

AF power signal

**FM**

FM power signal

**AM**

corresponds to the RF power signal

**AMRelative**

corresponds to the AM signal

**PM**

PM power signal

**GP0 | GP1 | GP2 | GP3 | GP4 | GP5**

For applications that process I/Q data, such as the I/Q Analyzer or optional applications, and only if the optional "Digital Baseband" interface is available.

Defines triggering of the measurement directly via the LVDS connector. The parameter specifies which general-purpose bit (0 to 5) provides the trigger data.

The assignment of the general-purpose bits used by the Digital IQ trigger to the LVDS connector pins is provided in "[Digital I/Q](#)" on page 55.

\*RST: IMMEDIATE

**Example:**

```
TRIG:SOUR EXT
```

Selects the external trigger input as source of the trigger signal

**Manual operation:** See ["Trigger Source"](#) on page 52  
 See ["Free Run"](#) on page 53  
 See ["External Trigger 1/2/3"](#) on page 53  
 See ["External Channel 3"](#) on page 53  
 See ["External Analog"](#) on page 54  
 See ["I/Q Power"](#) on page 54  
 See ["IF Power"](#) on page 54  
 See ["Baseband Power"](#) on page 55  
 See ["Digital I/Q"](#) on page 55  
 See ["FM \(Offline\) / AM \(Offline\) / PM \(Offline\) / RF \(Offline\)"](#)  
 on page 56  
 See ["Time"](#) on page 56  
 See ["RF Power"](#) on page 56  
 See ["Power Sensor"](#) on page 56

---

#### TRIGger[:SEQuence]:TIME:RINterval <Interval>

Defines the repetition interval for the time trigger.

##### Parameters:

<Interval>                    numeric value  
 Range:                    2 ms to 5000 s  
 \*RST:                    1.0 s  
 Default unit: S

##### Example:

```
TRIG:SOUR TIME
Selects the time trigger input for triggering.
TRIG:TIME:RINT 5
The sweep starts every 5 s.
```

**Manual operation:** See ["Repetition Interval"](#) on page 57

### 11.4.8.2 Configuring the trigger output

The following commands are required to send the trigger signal to one of the variable "TRIGGER INPUT/OUTPUT" connectors on the FSW.

<a href="#">OUTPut:TRIGger&lt;tp&gt;:DIRection</a> .....	238
<a href="#">OUTPut:TRIGger&lt;tp&gt;:LEVel</a> .....	239
<a href="#">OUTPut:TRIGger&lt;tp&gt;:OTYPe</a> .....	239
<a href="#">OUTPut:TRIGger&lt;tp&gt;:PULSe:IMMediate</a> .....	240
<a href="#">OUTPut:TRIGger&lt;tp&gt;:PULSe:LENGth</a> .....	240

---

#### OUTPut:TRIGger<tp>:DIRection <Direction>

Selects the trigger direction for trigger ports that serve as an input as well as an output.

**Suffix:**

<tp> Selects the used trigger port.  
 2 = trigger port 2 (front)  
 (Not available for FSW85 models with two RF input connectors.)  
 3 = trigger port 3 (rear panel)

**Parameters:**

<Direction> INPut | OUTPut  
**INPut**  
 Port works as an input.  
**OUTPut**  
 Port works as an output.  
 \*RST: INPut

**Manual operation:** See "[Trigger 2/3](#)" on page 59

**OUTPut:TRIGger<tp>:LEVel <Level>**

Defines the level of the (TTL compatible) signal generated at the trigger output.

Works only if you have selected a user-defined output with [OUTPut:TRIGger<tp>:OTYPe](#).

**Suffix:**

<tp> 1..n  
 Selects the trigger port to which the output is sent.  
 2 = trigger port 2 (front)  
 (Not available for FSW85 models with two RF input connectors.)  
 3 = trigger port 3 (rear)

**Parameters:**

<Level> **HIGH**  
 5 V  
**LOW**  
 0 V  
 \*RST: LOW

**Example:** `OUTP:TRIG2:LEV HIGH`

**Manual operation:** See "[Level](#)" on page 60

**OUTPut:TRIGger<tp>:OTYPe <OutputType>**

Selects the type of signal generated at the trigger output.

**Note:** For offline AF or RF triggers, no output signal is provided.

**Suffix:**

<tp> 1..n  
 Selects the trigger port to which the output is sent.  
 2 = trigger port 2 (front)  
 (Not available for FSW85 models with two RF input connectors.)  
 3 = trigger port 3 (rear)

**Parameters:**

&lt;OutputType&gt;

**DEvice**

Sends a trigger signal when the FSW has triggered internally.

**TARMed**

Sends a trigger signal when the trigger is armed and ready for an external trigger event.

**UDEfined**Sends a user-defined trigger signal. For more information, see [OUTPut:TRIGger<tp>:LEVel](#).

\*RST: DEvice

**Manual operation:** See "[Output Type](#)" on page 60**OUTPut:TRIGger<tp>:PULSe:IMMediate**

Generates a pulse at the trigger output.

**Suffix:**

<tp> 1..n  
 Selects the trigger port to which the output is sent.  
 2 = trigger port 2 (front)  
 (Not available for FSW85 models with two RF input connectors.)  
 3 = trigger port 3 (rear)

**Manual operation:** See "[Send Trigger](#)" on page 60**OUTPut:TRIGger<tp>:PULSe:LENGth <Length>**

Defines the length of the pulse generated at the trigger output.

**Suffix:**

<tp> Selects the trigger port to which the output is sent.  
 2 = trigger port 2 (front)  
 (Not available for FSW85 models with two RF input connectors.)  
 3 = trigger port 3 (rear)

**Parameters:**

&lt;Length&gt;

Pulse length in seconds.

Default unit: S

**Example:**

OUTP:TRIG2:PULS:LENG 0.02

**Manual operation:** See "[Pulse Length](#)" on page 60



## 11.4.9 Configuring demodulation

The following remote commands are required to configure the demodulation parameters in a remote environment. The tasks for manual operation are described in [Chapter 5.7, "Demodulation"](#), on page 67.

• <a href="#">Basic demodulation settings</a> .....	241
• <a href="#">Time domain zoom settings</a> .....	244
• <a href="#">Configuring the demodulation spectrum</a> .....	246
• <a href="#">(Post-processing) AF filters</a> .....	248
• <a href="#">Defining the scaling and units</a> .....	253
• <a href="#">Scaling for AF evaluation</a> .....	253
• <a href="#">Scaling for RF evaluation</a> .....	254
• <a href="#">Units</a> .....	254
• <a href="#">Relative demodulation results</a> .....	255
• <a href="#">Settling time</a> .....	258

### 11.4.9.1 Basic demodulation settings

The basic demodulation measurement parameters define how the measurement is performed.

Useful commands described elsewhere:

- [Chapter 11.4.9.2, "Time domain zoom settings"](#), on page 244

#### Basic demodulation commands:

<a href="#">[SENSe:]ADEMod&lt;n&gt;:AF:COUPling</a> .....	241
<a href="#">[SENSe:]ADEMod:PM:RPOint[:X]</a> .....	242
<a href="#">[SENSe:]ADEMod:PM:RPOint[:X]:MODE</a> .....	242
<a href="#">[SENSe:]ADEMod:SQUelch[:STATe]</a> .....	242
<a href="#">[SENSe:]ADEMod:SQUelch:LEVel</a> .....	243
<a href="#">CALCulate&lt;n&gt;:FORMat</a> .....	243

---

#### **[SENSe:]ADEMod<n>:AF:COUPling <Coupling>**

Selects the coupling of the AF path of the analyzer in the specified window.

##### Suffix:

<n>                      irrelevant

##### Parameters:

<Coupling>            AC | DC  
 \*RST:                AC (PM); DC (FM)

##### Example:

ADEM:AF:COUP DC  
 Switches on DC coupling.

**Manual operation:** See ["AF Coupling"](#) on page 68

---

**[SENSe:]ADEMod:PM:RPOint[:X] <Time>**

Determines the position where the phase of the PM-demodulated signal is set to 0 rad. The maximum value depends on the measurement time selected in the instrument; this value is output in response to the query `ADEMod:PM:RPO:X? MAX`.

**Parameters:**

<Time> 0 s to measurement time  
 \*RST: 0 s  
 Default unit: S

**Example:**

`ADEMod:PM:RPO 500us`  
 Sets the position where the phase to 0 rad setting to 500 µs.

**Manual operation:** See "[Zero Phase Reference Position \(PM Time Domain only\)](#)" on page 69

---

**[SENSe:]ADEMod:PM:RPOint[:X]:MODE <Mode>**

Defines how the reference position in time for 0 rad is determined.

**Parameters:**

<Mode> MANual | RIGHT

**MANual**

The time is defined using `[SENSe:]ADEMod:PM:RPOint[:X]` on page 242.

**RIGHT**

The time of the last measured value is used as the reference position. The time of the last measured value corresponds to the acquisition time, regarding the trigger event and trigger offset, if applicable. If the acquisition time or the trigger values are changed, the reference position is automatically adapted.

\*RST: MANual

**Example:**

`ADEMod:MTIM 500us`  
`ADEMod:PM:RPO:MODE RIGHT`  
 Sets the position of the 0 rad phase setting to 500 µs.

**Manual operation:** See "[Zero Phase Reference Position \(PM Time Domain only\)](#)" on page 69

---

**[SENSe:]ADEMod:SQUelch[:STATe] <State>**

Activates the squelch function, i.e. if the signal falls below a defined threshold (see `[SENSe:]ADEMod:SQUelch:LEVel` on page 243), the demodulated data is automatically set to 0.

**Parameters:**

<State> ON | OFF | 0 | 1  
**OFF | 0**  
 Switches the function off

**ON | 1**

Switches the function on

**Example:** DEM:SQU ON  
Signals below the level threshold are squelched.

**Manual operation:** See "[Squelch State](#)" on page 68

**[SENSe:]ADEMod:SQUelch:LEVel <Threshold>**

Defines the level threshold below which the demodulated data is set to 0 if squelching is enabled (see [\[SENSe:\]ADEMod:SQUelch\[:STATe\]](#) on page 242).

**Parameters:**

<Threshold> numeric value  
The absolute threshold level  
Range: -150 dBm to 30 dBm  
\*RST: -40 dBm

**Example:** DEM:SQU:LEV -80  
If the signal drops below -80 dBm, the demodulated data is set to 0.

**Manual operation:** See "[Squelch Level](#)" on page 68

**CALCulate<n>:FORMat <Evaluation>**

This command activates/deactivates the phase wrap for the specified PM time domain display with DC coupling.

**Suffix:**

<n> 1..n

**Parameters:**

<Evaluation> **PHAS**  
The phase is wrapped.  
**UPH**  
The phase is not wrapped.  
\*RST: UPH

**Example:** LAY:ADD? '1',BEL,'XTIM:PM'  
Activates PM time domain display. Result: window '2'  
INP:COUP DC  
Selects DC coupling.  
CALC2:FORM PHAS  
Selects a wrapped phase display in the PM time domain window.

**Manual operation:** See "[Phase Wrap On/Off \(PM Time Domain only\)](#)" on page 70

### 11.4.9.2 Time domain zoom settings

Using the time domain zoom, the demodulated data for a particular time span is extracted and displayed in more detail.

[SENSe:]ADEMod<n>:ZOOM:LENGth.....	244
[SENSe:]ADEMod<n>:ZOOM:LENGth:MODE.....	244
[SENSe:]ADEMod<n>:ZOOM:START.....	245
[SENSe:]ADEMod<n>:ZOOM[:STATe].....	245

---

#### [SENSe:]ADEMod<n>:ZOOM:LENGth <Length>

The command allows you to define the length of the time domain zoom area for the analog-demodulated measurement data in the specified window manually. If the length is defined manually using this command, the zoom mode is also set to manual.

**Suffix:**

<n> [Window](#)

**Parameters:**

<Length> \*RST: sweep time  
 Default unit: S  
 Length of the zoom area in seconds.

**Example:**

ADEM:ZOOM:LENG 2s  
 Zoom mode is set to manual and the zoom length to 2 seconds.

**Manual operation:** See "[Length](#)" on page 69

---

#### [SENSe:]ADEMod<n>:ZOOM:LENGth:MODE <Mode>

The command defines whether the length of the zoom area for the analog-demodulated measurement data is defined automatically or manually in the specified window.

**Suffix:**

<n> [Window](#)

**Parameters:**

<Mode> AUTO | MAN  
**AUTO**  
 (Default:) The number of sweep points is used as the zoom length.  
**MAN**  
 The zoom length is defined manually using [SENSe:]ADEMod<n>:ZOOM:LENGth.  
 \*RST: AUTO

**Example:**

ADEM:ZOOM:LENG:MODE MAN  
 Zoom function uses the length defined manually.

**Manual operation:** See "[Length](#)" on page 69

**[SENSe:]ADEMod<n>:ZOOM:STARt <Time>**

The command selects the start time for the zoomed display of analog-demodulated measurements in the specified window. The maximum value depends on the measurement time, which is set and can be queried with the [\[SENSe:\]ADEMod:MTIME](#) command.

If the zoom function is enabled, the defined number of sweep points are displayed from the start time specified with this command.

**Suffix:**

<n> [Window](#)

**Parameters:**

<Time> Range: 0 s to (measurement time – zoom length)  
 \*RST: 0 s  
 Default unit: S

**Example:**

```
ADEM:ZOOM:STAT ON
Switches on the zoom function
ADEM:ZOOM:STAR 500us
Sets the starting point of the display to 500 µs.
```

**Manual operation:** See "[Start](#)" on page 69

**[SENSe:]ADEMod<n>:ZOOM[:STATe] <State>**

The command enables or disables the time domain zoom function for the analog-demodulated measurement data in the specified window.

If the zoom function is enabled, the defined number of sweep points are displayed from the start time specified with [\[SENSe:\]ADEMod<n>:ZOOM:STARt](#) on page 245.

If the zoom function is disabled, data reduction is used to adapt the measurement points to the number of points available on the display.

**Suffix:**

<n> [Window](#)

**Parameters:**

<State> ON | OFF | 0 | 1  
**OFF | 0**  
 Switches the function off  
**ON | 1**  
 Switches the function on

**Example:**

```
ADEM:ZOOM ON
Switches on the zoom function
```

**Manual operation:** See "[State](#)" on page 69





**Example:** ADEM:SPEC:SPAN:ZOOM 200 kHz  
Sets the rF span to 200 kHz

**Manual operation:** See "[Span](#)" on page 73

**[SENSe:]ADEMod:SPECTrum:SPAN[:MAXimum] <FreqRange>**

Sets the DBW to the specified value and the span (around the center frequency) of the RF data to be evaluated to its new maximum (the demodulation bandwidth).

**Parameters:**

<FreqRange> \*RST: 5 MHz  
Default unit: Hz

**Manual operation:** See "[Span](#)" on page 73  
See "[RF Full Span](#)" on page 73

#### 11.4.9.4 (Post-processing) AF filters

The AF filter reduces the evaluated bandwidth of the demodulated signal and can define a weighting function. AF filters are only available for AM or FM time domain evaluations.

[SENSe:]FILTer<n>:AWEighted[:STATe].....	248
[SENSe:]FILTer<n>:AOFF.....	249
[SENSe:]FILTer<n>:CCIR:WEIGhted[:STATe].....	249
[SENSe:]FILTer<n>:CCIR[:UNWeighted][:STATe].....	249
[SENSe:]FILTer<n>:CCIT[:STATe].....	250
[SENSe:]FILTer<n>:DEMPHasis:TCONstant.....	250
[SENSe:]FILTer<n>:DEMPHasis[:STATe].....	250
[SENSe:]FILTer<n>:HPASs:FREQuency[:ABSolute].....	251
[SENSe:]FILTer<n>:HPASs:FREQuency:MANual.....	251
[SENSe:]FILTer<n>:HPASs[:STATe].....	251
[SENSe:]FILTer<n>:LPASs:FREQuency[:ABSolute].....	252
[SENSe:]FILTer<n>:LPASs:FREQuency:MANual.....	252
[SENSe:]FILTer<n>:LPASs:FREQuency:RELative.....	252
[SENSe:]FILTer<n>:LPASs[:STATe].....	253

**[SENSe:]FILTer<n>:AWEighted[:STATe] <State>**

Activates/deactivates the "A" weighting filter for the specified evaluation.

For details on weighting filters, see "[Weighting](#)" on page 75.

**Suffix:**

<n> [Window](#)

**Parameters:**

<State> ON | OFF | 0 | 1  
**OFF | 0**  
Switches the function off



**ON | 1**

Switches the function on

**Example:**

FILT:AWE ON

Activates the A weighting filter.

**Manual operation:** See "[Weighting](#)" on page 75**[SENSe:]FILTer<n>:AOFF****Suffix:**

&lt;n&gt; 1..n

**Manual operation:** See "[Deactivating all AF Filters](#)" on page 76**[SENSe:]FILTer<n>:CCIR:WEIGhted[:STATE] <State>**

Activates/deactivates the weighted CCIR filter for the specified evaluation.

For details on weighting filters, see "[Weighting](#)" on page 75.**Suffix:**<n> [Window](#)**Parameters:**

&lt;State&gt; ON | OFF | 0 | 1

**OFF | 0**

Switches the function off

**ON | 1**

Switches the function on

**Example:**

FILT:CCIR:WEIG ON

Activates the weighted CCIR filter.

**Manual operation:** See "[Weighting](#)" on page 75**[SENSe:]FILTer<n>:CCIR[:UNWeighted][:STATE] <State>**

Activates/deactivates the unweighted CCIR filter in the specified window.

For details on weighting filters, see "[Weighting](#)" on page 75.**Suffix:**<n> [Window](#)**Parameters:**

&lt;State&gt; ON | OFF | 0 | 1

**OFF | 0**

Switches the function off

**ON | 1**

Switches the function on

**Example:** `FILT:CCIR:UNW ON`  
Activates the unweighted CCIR filter.

**Manual operation:** See ["Weighting"](#) on page 75

**[SENSe:]FILTer<n>:CCITt[:STATe] <State>**

**Suffix:**  
<n> 1..n

**Parameters:**  
<State>

**Manual operation:** See ["Weighting"](#) on page 75

**[SENSe:]FILTer<n>:DEMPHasis:TCONstant <Value>**

Selects the deemphasis for the specified evaluation.

For details on deemphasis refer to ["Deemphasis"](#) on page 76.

**Suffix:**  
<n> [Window](#)

**Parameters:**  
<Value> 25 us | 50 us | 75 us | 750 us  
\*RST: 50 us  
Default unit: S

**Example:** `FILT:DEMP:TCON 750us`  
Selects the deemphasis for the demodulation bandwidth range from 800 Hz to 4 MHz with a time constant of 750 µs.

**Manual operation:** See ["Deemphasis"](#) on page 76

**[SENSe:]FILTer<n>:DEMPHasis[:STATe] <State>**

Activates/deactivates the selected deemphasis for the specified evaluation.

For details about deemphasis refer to ["Deemphasis"](#) on page 76.

**Suffix:**  
<n> [Window](#)

**Parameters:**  
<State> ON | OFF | 0 | 1  
**OFF | 0**  
Switches the function off  
**ON | 1**  
Switches the function on

**Example:** `FILT:DEMP ON`  
Activates the selected deemphasis.

**Manual operation:** See ["Deemphasis"](#) on page 76

**[SENSe:]FILTeR<n>:HPASs:FREQuency[:ABSolute]** <Frequency>

Selects the high pass filter type for the specified evaluation.

For details on the high pass filters, refer to ["High Pass"](#) on page 74.

**Suffix:**

<n> [Window](#)

**Parameters:**

<Frequency> 20 Hz | 50 Hz | 300 Hz

\*RST: 300Hz

Default unit: Hz

**Example:**

FILT:HPAS:FREQ 300Hz

Selects the high pass filter for the demodulation bandwidth range from 800 Hz to 8 MHz.

**Manual operation:** See ["High Pass"](#) on page 74

**[SENSe:]FILTeR<n>:HPASs:FREQuency:MANual** <Frequency>

Selects the cutoff frequency of the high pass filter for the specified evaluation.

For details on the high pass filters, refer to ["High Pass"](#) on page 74.

**Suffix:**

<n> [Window](#)

**Parameters:**

<Frequency> numeric value

Range: 0 to 3 MHz

\*RST: 15kHz

Default unit: HZ

**Example:**

FILT:HPAS:FREQ:MAN 3MHz

The AF results are restricted to frequencies lower than 3 MHz.

**Manual operation:** See ["High Pass"](#) on page 74

**[SENSe:]FILTeR<n>:HPASs[:STATe]** <State>

Activates/deactivates the selected high pass filter for the specified evaluation.

For details on the high pass filter, refer to ["High Pass"](#) on page 74.

**Suffix:**

<n> [Window](#)

**Parameters:**

<State> ON | OFF | 0 | 1

**OFF | 0**

Switches the function off

**ON | 1**

Switches the function on

**Example:** `FILT:HPAS ON`  
Activates the selected high pass filter.

**Manual operation:** See "[High Pass](#)" on page 74

**[SENSe:]FILTer<n>:LPASs:FREQUency[:ABSolute] <Frequency>**

Selects the absolute low pass filter type for the specified evaluation

For details on the low pass filter, refer to "[Low Pass](#)" on page 75.**Suffix:**<n> [Window](#)**Parameters:**

<Frequency> 3kHz | 15kHz | 150kHz  
\*RST: 15kHz  
Default unit: HZ

**Example:** `FILT:LPAS:FREQ 150kHz`  
Selects the low pass filter for the demodulation bandwidth range from 400 kHz to 16 MHz.

**Manual operation:** See "[Low Pass](#)" on page 75

**[SENSe:]FILTer<n>:LPASs:FREQUency:MANual <Frequency>**

Selects the cutoff frequency of the low pass filter for the specified evaluation.

For details on the low pass filter, refer to "[Low Pass](#)" on page 75.**Suffix:**<n> [Window](#)**Parameters:**

<Frequency> numeric value  
Range: 0 to 3 MHz  
\*RST: 15kHz  
Default unit: HZ

**Example:** `FILT:LPAS:FREQ:MAN 150kHz`  
The AF results are restricted to frequencies lower than 150 kHz.

**Manual operation:** See "[Low Pass](#)" on page 75

**[SENSe:]FILTer<n>:LPASs:FREQUency:RELative <Frequency>**

Selects the relative low pass filter type for the specified evaluation

For details on the low pass filter, refer to "Low Pass" on page 75.

**Suffix:**

<n> [Window](#)

**Parameters:**

<Frequency> 5PCT | 10PCT | 25PCT  
 \*RST: 25PCT  
 Default unit: PCT

**Example:**

```
FILT:LPAS:FREQ:REL 25PCT
```

Selects the low pass filter as 25 % of the demodulation bandwidth.

**Manual operation:** See "Low Pass" on page 75

**[SENSe:]FILTER<n>:LPASs[:STATe] <State>**

Activates/deactivates the selected low pass filter for the specified evaluation.

For details on the low pass filter, refer to "Low Pass" on page 75.

**Suffix:**

<n> [Window](#)

**Parameters:**

<State> ON | OFF | 0 | 1  
**OFF | 0**  
 Switches the function off  
**ON | 1**  
 Switches the function on

**Example:**

```
FILT:LPAS ON
```

Activates the selected low pass filter.

**Manual operation:** See "Low Pass" on page 75

#### 11.4.9.5 Defining the scaling and units

The scaling parameters define the range of the demodulated data to be displayed.

#### 11.4.9.6 Scaling for AF evaluation

These settings are only available for AF evaluations.

Useful commands described elsewhere:

- [\[SENSe:\]ADJust:SCALE\[:Y\]:AUTO\[:CONTinuous\]](#) on page 264
- [\[SENSe:\]ADEMod<n>:AF:COUPling](#) on page 241
- [DISPlay\[:WINDow<n>\]\[:SUBWindow<w>\]:TRACe<t>:Y\[:SCALE\]:RPOStion](#) on page 224

- `DISPlay[:WINDow<n>][:SUBWindow<w>]:TRACe<t>:Y:SPACing`  
on page 225

#### Specific commands:

`DISPlay[:WINDow<n>][:SUBWindow<w>]:TRACe<t>:Y[:SCALe]:RVALue.....254`

---

**DISPlay[:WINDow<n>][:SUBWindow<w>]:TRACe<t>:Y[:SCALe]:RVALue <Value>**

Defines the reference value assigned to the reference position in the specified window. Separate reference values are maintained for the various displays.

#### Suffix:

<n>	Window
<w>	subwindow
<t>	irrelevant

#### Parameters:

<Value> Default unit: DB

#### Example:

`DISP:TRAC:Y:RVAL 0`

Sets the value assigned to the reference position to 0 Hz

**Manual operation:** See "Reference Value" on page 78

### 11.4.9.7 Scaling for RF evaluation

These commands are required for RF evaluations and the "result summary".

- `DISPlay[:WINDow<n>][:SUBWindow<w>]:TRACe<t>:Y[:SCALe]:RPOSition` on page 224
- `DISPlay[:WINDow<n>][:SUBWindow<w>]:TRACe<t>:Y:SPACing`  
on page 225
- `DISPlay[:WINDow<n>][:SUBWindow<w>]:TRACe<t>:Y[:SCALe]`  
on page 223
- `DISPlay[:WINDow<n>][:SUBWindow<w>]:TRACe<t>:Y[:SCALe]:MODE`  
on page 223

### 11.4.9.8 Units

The units define how the demodulated data is displayed.

<code>CALCulate&lt;n&gt;:UNIT:ANGLE.....</code>	255
<code>UNIT&lt;n&gt;:ANGLE.....</code>	255
<code>CALCulate&lt;n&gt;:UNIT:THD.....</code>	255
<code>UNIT&lt;n&gt;:THD.....</code>	255

---

**CALCulate**<n>:UNIT:ANGLE <Unit>

**UNIT**<n>:ANGLE <Unit>

Selects the unit for angles (for PM display, <n> is irrelevant).

Is identical to CALC:UNIT:ANGL

**Suffix:**

<n> [Window](#)

**Parameters:**

<Unit> DEG | RAD

\*RST: RAD

**Example:** UNIT:ANGL DEG

**Manual operation:** See ["Phase Unit \(Rad/Deg\)"](#) on page 82

---

**CALCulate**<n>:UNIT:THD <Unit>

**UNIT**<n>:THD <Mode>

Selects the unit for THD measurements (<n> is irrelevant).

Is identical to CALC:UNIT:THD

**Suffix:**

<n> [Window](#)

**Parameters:**

<Mode> DB | PCT

\*RST: DB

**Example:** UNIT:THD PCT

**Manual operation:** See ["THD Unit \(%/ DB\)"](#) on page 82

#### 11.4.9.9 Relative demodulation results

The following commands are required to obtain relative demodulation results.

<a href="#">CONFigure:ADEMod:RESults:AM:DETEctor&lt;det&gt;:REFerence</a> .....	256
<a href="#">CONFigure:ADEMod:RESults:FM:DETEctor&lt;det&gt;:REFerence</a> .....	256
<a href="#">CONFigure:ADEMod:RESults:PM:DETEctor&lt;det&gt;:REFerence</a> .....	256
<a href="#">CONFigure:ADEMod:RESults:AM:DETEctor&lt;det&gt;:STATE</a> .....	256
<a href="#">CONFigure:ADEMod:RESults:FM:DETEctor&lt;det&gt;:STATE</a> .....	256
<a href="#">CONFigure:ADEMod:RESults:PM:DETEctor&lt;det&gt;:STATE</a> .....	256
<a href="#">CONFigure:ADEMod:RESults:AM:DETEctor&lt;det&gt;:REFerence:MEASStoref&lt;t&gt;</a> .....	257
<a href="#">CONFigure:ADEMod:RESults:FM:DETEctor&lt;det&gt;:REFerence:MEASStoref&lt;t&gt;</a> .....	257
<a href="#">CONFigure:ADEMod:RESults:PM:DETEctor&lt;det&gt;:REFerence:MEASStoref&lt;t&gt;</a> .....	257
<a href="#">CONFigure:ADEMod:RESults:AM:DETEctor&lt;det&gt;:MODE</a> .....	257
<a href="#">CONFigure:ADEMod:RESults:FM:DETEctor&lt;det&gt;:MODE</a> .....	257
<a href="#">CONFigure:ADEMod:RESults:PM:DETEctor&lt;det&gt;:MODE</a> .....	257
<a href="#">CONFigure:ADEMod:RESults:UNIT</a> .....	258

---

**CONFigure:ADEMod:RESults:AM:DETEctor<det>:REFerence** <RefValue>

**CONFigure:ADEMod:RESults:FM:DETEctor<det>:REFerence** <RefValue>

**CONFigure:ADEMod:RESults:PM:DETEctor<det>:REFerence** <RefValue>

Defines the reference value to be used for relative demodulation results and recalculates the results. If necessary, the detector is activated.

A reference value 0 would provide infinite results and is thus automatically corrected to 0.1.

**Suffix:**

<det> Detector function used for relative demodulation

**Parameters:**

<RefValue> double value  
 The unit depends on the demodulation type:  
 ACV: V  
 AM: %  
 FM: Hz  
 PM: depends on [UNIT<n>:ANGLE](#) setting  
 \*RST: 1.0  
 Default unit: RAD

**Example:** See [CONFigure:ADEMod:RESults:PM:DETEctor<det>:STATE](#) on page 256

**Manual operation:** See "[Reference Value](#)" on page 84

---

**CONFigure:ADEMod:RESults:AM:DETEctor<det>:STATE** <State>

**CONFigure:ADEMod:RESults:FM:DETEctor<det>:STATE** <State>

**CONFigure:ADEMod:RESults:PM:DETEctor<det>:STATE** <State>

Activates relative demodulation for the selected detector. If activated, the demodulated result is set in relation to the reference value defined by [CONFigure:ADEMod:RESults:PM:DETEctor<det>:REFerence](#).

**Suffix:**

<det> Detector function used for relative demodulation

**Parameters:**

<State> ON | OFF | 0 | 1  
**OFF | 0**  
 Switches the function off  
**ON | 1**  
 Switches the function on



**Example:**

```
CONF:ADEM:RES:PM:DET2:STAT ON
```

Activates relative demodulation for the negative peak detector.

```
CONF:ADEM:RES:UNIT PCT
```

Defines the unit for relative values as percent.

```
CONF:ADEM:RES:PM:DET2:REF 1.415%
```

Sets the reference value for the negative peak detector to 1.415 %.

```
CONF:ADEM:RES:PM:DET2:MODE AVER
```

Sets the negative peak detector to average mode.

```
CONF:ADEM:RES:PM:DET2:REF:MEAS2
```

Sets the reference value for the negative peak detector to the average of the currently calculated value and the previous reference value on trace 2.

**Manual operation:** See ["State"](#) on page 84

**CONFigure:ADEMod:RESults:AM:DETEctor<det>:REFerence:MEASStoref<t>**

**CONFigure:ADEMod:RESults:FM:DETEctor<det>:REFerence:MEASStoref<t>**

**CONFigure:ADEMod:RESults:PM:DETEctor<det>:REFerence:MEASStoref<t>**

Sets the reference value to be used for relative demodulation results to the currently measured value on the specified trace *for all relative detectors*.

If necessary, the detectors are activated.

A reference value 0 would provide infinite results and is thus automatically corrected to 0.1.

**Suffix:**

<det> irrelevant

<t> 1..n  
[Trace](#)

**Example:** See [CONFigure:ADEMod:RESults:PM:DETEctor<det>:STATE](#) on page 256

**Manual operation:** See ["Meas -> Reference"](#) on page 84

**CONFigure:ADEMod:RESults:AM:DETEctor<det>:MODE <Mode>**

**CONFigure:ADEMod:RESults:FM:DETEctor<det>:MODE <Mode>**

**CONFigure:ADEMod:RESults:PM:DETEctor<det>:MODE <Mode>**

Defines the mode with which the demodulation result is determined.

**Suffix:**

<det> Detector function used for relative demodulation

**Parameters:**

<Mode> **WRITE**

Overwrite mode: the detector value is overwritten by each sweep. This is the default setting.

**AVERage**

The average result is determined over all sweeps.

**MAXHold**

The maximum value is determined over several sweeps and displayed. The FSW saves each result only if the new value is greater than the previous one.

\*RST: WRITe

**Example:** See [CONFigure:ADEMod:RESults:PM:DETEctor<det>:STATe](#) on page 256

**Manual operation:** See ["Mode"](#) on page 83

**CONFigure:ADEMod:RESults:UNIT <Unit>**

Selects the unit for relative demodulation results.

**Parameters:**

<Unit> PCT | DB  
\*RST: PCT

**Example:** CONF:ADEM:RES:AM:DET2:STAT ON  
Activates relative demodulation for the negative peak detector.  
CONF:ADEM:RES:AM:DET2:MODE AVER  
Sets the negative peak detector to average mode.  
CONF:ADEM:RES:UNIT PCT  
Defines the unit for relative values as percent.  
CONF:ADEM:RES:AM:DET2:REF 1.415%  
Sets the reference value for relative results to 1.415 %.

**Manual operation:** See ["Relative Unit"](#) on page 82

**11.4.9.10 Settling time**

Optionally, the settling time can be evaluated for time domain measurements.

Useful commands for the settling time described elsewhere:

- [\[SENSe:\]ADEMod:SETTling:TIME:RESult<t>?](#) on page 288

**Remote commands exclusive to configuring the settling time:**

[\[SENSe:\]ADEMod:SETTling:TIME:LIMit:LOWer](#)..... 258  
[\[SENSe:\]ADEMod:SETTling:TIME:LIMit:UPPer](#)..... 259  
[\[SENSe:\]ADEMod:SETTling:TIME:STATe](#)..... 259

**[SENSe:]ADEMod:SETTling:TIME:LIMit:LOWer <Position>**

Defines the upper limit of the settling time corridor. The value is defined with reference to the reference value, see also [DISPlay\[:WINDow<n>\]\[:SUBWindow<w>\]:TRACe<t>:Y\[:SCALE\]:RVALue](#) on page 254 and [\[SENSe:\]ADEMod:PM:RPOint\[:X\]](#) on page 242.

For details, see [Chapter 5.7.7, "Settling time"](#), on page 85.

**Parameters:**

<Position> Default unit: depends on result type

**Example:**

ADEM:SETT:TIME:LIM:LOW -10 RAD

**Manual operation:** See "[Lower Settling Limit](#)" on page 86

**[SENSe:]ADEMod:SETTling:TIME:LIMit:UPPer <Position>**

Defines the upper limit of the settling time corridor. The value is defined with reference to the reference value, see also [DISPlay\[:WINDow<n>\]\[:SUBWindow<w>\]:TRACe<t>:Y\[:SCALE\]:RVALue](#) on page 254 and [\[SENSe:\]ADEMod:PM:RPOint\[:X\]](#) on page 242.

For details, see [Chapter 5.7.7, "Settling time"](#), on page 85.

**Parameters:**

<Position> Default unit: depends on result type

**Example:**

ADEM:SETT:TIME:LIM:UPP 10 RAD

**Manual operation:** See "[Upper Settling Limit](#)" on page 86

**[SENSe:]ADEMod:SETTling:TIME:STATe <State>**

Enables or disables the calculation and display of the settling time. The function is available for all time domain displays.

For details, see [Chapter 5.7.7, "Settling time"](#), on page 85.

**Parameters:**

<State> ON | OFF | 0 | 1

**OFF | 0**

Switches the function off

**ON | 1**

Switches the function on

\*RST: 0

**Example:**

```
//Define a PM time domain result display
LAY:ADD? '1',RIGH,'XTIM:PM'
//Define a second maxhold trace
DISP:WIND2:TRAC2:MODE MAXH
//Enable settling time calculation
ADEM:SETT:TIME:STAT ON
//Define the settling limit corridor as +/-10 RAD
ADEM:SETT:TIME:LIM:UPP 10 RAD
ADEM:SETT:TIME:LIM:LOW -10 RAD
//Set the zero RAD reference to the last measurement value
ADEM:PM:RPO:MODE LAST
//Perform the measurement
INIT;*WAI
//Query the settling time
ADEM:SETT:TIME:RES2?
//Result: 29.950000us
//After 29.95 us the signal is settled.
```

**Manual operation:** See ["State"](#) on page 86

### 11.4.10 Adjusting settings automatically

The following remote commands are required to adjust settings automatically in a remote environment. The tasks for manual operation are described in [Chapter 5.9, "Adjusting settings automatically"](#), on page 92.



#### MSRA/MSRT operating mode

In MSRA/MSRT operating mode, settings related to data acquisition cannot be adjusted for R&S FSW AM/FM/PM Modulation Analysis application.

[SENSe:]ADJust:ALL.....	260
[SENSe:]ADJust:CONFigure:LEVel:DURation.....	261
[SENSe:]ADJust:CONFigure:LEVel:DURation:MODE.....	261
[SENSe:]ADJust:CONFigure:HYSteresis:LOWer.....	262
[SENSe:]ADJust:CONFigure:HYSteresis:UPPer.....	262
[SENSe:]ADJust:CONFigure:SMODE.....	262
[SENSe:]ADJust:CONFigure:TRIGger.....	263
[SENSe:]ADJust:FREQuency.....	263
[SENSe:]ADJust:LEVel.....	263
[SENSe:]ADJust:SCALE[:Y]:AUTO[:CONTInuous].....	264

---

#### [SENSe:]ADJust:ALL

Initiates a measurement to determine and set the ideal settings for the current task automatically (only once for the current measurement).

This includes:

- Center frequency

- Reference level
- Scaling

**Example:** ADJ:ALL

**Manual operation:** See ["Adjusting all Determinable Settings Automatically \(Auto All\)"](#) on page 93

#### [SENSe:]ADJust:CONFigure:LEVel:DURation <Duration>

To determine the ideal reference level, the FSW performs a measurement on the current input data. This command defines the length of the measurement if [SENSe:]ADJust:CONFigure:LEVel:DURation:MODE is set to MANual.

##### Parameters:

<Duration> Numeric value in seconds  
 Range: 0.001 to 16000.0  
 \*RST: 0.001  
 Default unit: s

##### Example:

ADJ:CONF:DUR:MODE MAN  
 Selects manual definition of the measurement length.  
 ADJ:CONF:LEV:DUR 5ms  
 Length of the measurement is 5 ms.

**Manual operation:** See ["Changing the Automatic Measurement Time \(Meas Time Manual\)"](#) on page 94

#### [SENSe:]ADJust:CONFigure:LEVel:DURation:MODE <Mode>

To determine the ideal reference level, the FSW performs a measurement on the current input data. This command selects the way the FSW determines the length of the measurement .

##### Parameters:

<Mode> **AUTO**  
 The FSW determines the measurement length automatically according to the current input data.

**MANual**  
 The FSW uses the measurement length defined by [SENSe:]ADJust:CONFigure:LEVel:DURation on page 261.  
 \*RST: AUTO

**Manual operation:** See ["Resetting the Automatic Measurement Time \(Meas Time Auto\)"](#) on page 94  
 See ["Changing the Automatic Measurement Time \(Meas Time Manual\)"](#) on page 94

**[SENSe:]ADJust:CONFigure:HYSTerisis:LOWer** <Threshold>

When the reference level is adjusted automatically using the [\[SENSe:\]ADJust:LEVel](#) on page 263 command, the internal attenuators and the preamplifier are also adjusted. To avoid frequent adaptation due to small changes in the input signal, you can define a hysteresis. This setting defines a lower threshold the signal must fall below (compared to the last measurement) before the reference level is adapted automatically.

**Parameters:**

<Threshold>                    Range:        0 dB to 200 dB  
                                      \*RST:        +1 dB  
                                      Default unit: dB

**Example:**

SENS:ADJ:CONF:HYST:LOW 2

For an input signal level of currently 20 dBm, the reference level is only adjusted when the signal level falls below 18 dBm.

**Manual operation:** See "[Lower Level Hysteresis](#)" on page 95

**[SENSe:]ADJust:CONFigure:HYSTerisis:UPPer** <Threshold>

When the reference level is adjusted automatically using the [\[SENSe:\]ADJust:LEVel](#) on page 263 command, the internal attenuators and the preamplifier are also adjusted. To avoid frequent adaptation due to small changes in the input signal, you can define a hysteresis. This setting defines an upper threshold the signal must exceed (compared to the last measurement) before the reference level is adapted automatically.

**Parameters:**

<Threshold>                    Range:        0 dB to 200 dB  
                                      \*RST:        +1 dB  
                                      Default unit: dB

**Example:**

SENS:ADJ:CONF:HYST:UPP 2

**Example:**

For an input signal level of currently 20 dBm, the reference level is only adjusted when the signal level rises above 22 dBm.

**Manual operation:** See "[Upper Level Hysteresis](#)" on page 94

**[SENSe:]ADJust:CONFigure:SMODE** <Search Mode>

Determines the search mode for the automatic measurement performed to determine the optimal measurement configuration.

**Parameters:**

<Search Mode>                FAST | POPTimized

**FAST**

The measurement is optimized for speed.

**POPTimized**

The measurement is optimized to analyze pulse signals adequately.

**Example:** `ADJ:CONF:SMOD POPT`

**[SENSe:]ADJust:CONFigure:TRIGger <State>**

Defines the behavior of a triggered measurement when adjusting a setting automatically (using `SENS:ADJ:LEV ON`, for example).

See "[Adjusting settings automatically during triggered measurements](#)" on page 93.

**Parameters:**

<State> `ON | OFF | 0 | 1`

**ON | 1**

(default:) The measurement for adjustment waits for the next trigger.

**OFF | 0**

The measurement for adjustment is performed without waiting for a trigger (corresponds to "Continue" in manual operation).

\*RST: `0`

**Example:**

```
//Use default ref level at 0.00 dBm.
//Define an RF power trigger at -20 dBm
:TRIG:SEQ:SOUR RFP
:TRIG:SEQ:LEV:RFP -20
//Perform adjustment measurement without waiting for trigger
SENS:ADJ:CONF:TRIG OFF
//Perform auto level adjustment
:SENS:ADJ:LEV;*WAI
```

**[SENSe:]ADJust:FREQuency**

Sets the center frequency to the frequency with the highest signal level in the current frequency range.

**Example:** `ADJ:FREQ`

**Manual operation:** See "[Adjusting the Center Frequency Automatically \(Auto Frequency\)](#)" on page 93

**[SENSe:]ADJust:LEVel**

Initiates a single (internal) measurement that evaluates and sets the ideal reference level for the current input data and measurement settings. Thus, the settings of the RF attenuation and the reference level are optimized for the signal level. The FSW is not overloaded and the dynamic range is not limited by an S/N ratio that is too small.

**Example:** `ADJ:LEV`

**Manual operation:** See "Setting the Reference Level Automatically (Auto Level)" on page 47

---

**[SENSe:]ADJJust:SCALe[:Y]:AUTO[:CONTinuous] <State>**

Activates automatic scaling of the y-axis in all diagrams according to the current measurement results. Currently auto-scaling is only available for AF measurements. RF power and RF spectrum measurements are not affected by the auto-scaling.

**Parameters:**

<State>                    ON | OFF | 0 | 1  
                               **OFF | 0**  
                               Switches the function off  
                               **ON | 1**  
                               Switches the function on

**Example:**                    SENS:ADJ:SCAL:Y:AUTO ON

**Manual operation:** See "AF Auto Scale" on page 79

## 11.5 Capturing data and performing sweeps

The following commands are required to capture data.



### MSRA/MSRT operating mode

Note that in MSRA/MSRT operating mode, capturing data is only possible for the MSRA/MSRT primary channel. In Analog Modulation Analysis channels, the sweep configuration commands define the **analysis interval**. Be sure to select the correct channel before using these commands.

ABORt.....	264
INITiate<n>:CONMeas.....	265
INITiate<n>:CONTinuous.....	266
INITiate<n>[:IMMEDIATE].....	266
INITiate<n>:REFresh.....	267
INITiate:SEQuencer:ABORt.....	267
INITiate:SEQuencer:IMMEDIATE.....	267
INITiate:SEQuencer:MODE.....	267
INITiate:SEQuencer:REFresh[:ALL].....	268
SYSTem:SEQuencer.....	268

---

### ABORt

Aborts the measurement in the current channel and resets the trigger system.

To prevent overlapping execution of the subsequent command before the measurement has been aborted successfully, use the \*OPC? or \*WAI command after ABOR and before the next command.



For details on overlapping execution see [Remote control via SCPI](#).

To abort a sequence of measurements by the Sequencer, use the `INITiate:SEQuencer:ABORt` command.

**Note on blocked remote control programs:**

If a sequential command cannot be completed, for example because a triggered sweep never receives a trigger, the remote control program will never finish and the remote channel to the FSW is blocked for further commands. In this case, you must interrupt processing on the remote channel first in order to abort the measurement.

To do so, send a "Device Clear" command from the control instrument to the FSW on a parallel channel to clear all currently active remote channels. Depending on the used interface and protocol, send the following commands:

- **Visa:** `viClear()`
- **GPIB:** `ibclr()`
- **RSIB:** `RSDLLibclr()`

Now you can send the `ABORt` command on the remote channel performing the measurement.

**Example:** `ABOR; :INIT:IMM`  
Aborts the current measurement and immediately starts a new one.

**Example:** `ABOR; *WAI`  
`INIT:IMM`  
Aborts the current measurement and starts a new one once abortion has been completed.

**Usage:** Event

**INITiate<n>:CONMeas**

Restarts a (single) measurement that has been stopped (using `ABORt`) or finished in single sweep mode.

The measurement is restarted at the beginning, not where the previous measurement was stopped.

As opposed to `INITiate<n>[:IMMEDIATE]`, this command does not reset traces in maxhold, minhold or average mode. Therefore it can be used to continue measurements using maxhold or averaging functions.

**Suffix:**  
<n> irrelevant

**Usage:** Asynchronous command

**Manual operation:** See "[Continue Single Sweep](#)" on page 64

**INITiate<n>:CONTInuous <State>**

Controls the sweep mode for an individual channel.

Note that in single sweep mode, you can synchronize to the end of the measurement with \*OPC, \*OPC? or \*WAI. In continuous sweep mode, synchronization to the end of the measurement is not possible. Thus, it is not recommended that you use continuous sweep mode in remote control, as results like trace data or markers are only valid after a single sweep end synchronization.

For details on synchronization see [Remote control via SCPI](#).

If the sweep mode is changed for a channel while the Sequencer is active (see [INITiate:SEQuencer:IMMediate](#) on page 267), the mode is only considered the next time the measurement in that channel is activated by the Sequencer.

**Suffix:**

<n> irrelevant

**Parameters:**

<State> ON | OFF | 0 | 1

**ON | 1**

Continuous sweep

**OFF | 0**

Single sweep

\*RST: 1 (some applications can differ)

**Example:**

```
INIT:CONT OFF
```

Switches the sweep mode to single sweep.

```
INIT:CONT ON
```

Switches the sweep mode to continuous sweep.

**Manual operation:** See "[Continuous Sweep / Run Cont](#)" on page 63

**INITiate<n>:[IMMediate]**

Starts a (single) new measurement.

With sweep count or average count > 0, this means a restart of the corresponding number of measurements. With trace mode MAXHold, MINHold and AVERage, the previous results are reset on restarting the measurement.

You can synchronize to the end of the measurement with \*OPC, \*OPC? or \*WAI.

For details on synchronization see [Remote control via SCPI](#).

**Suffix:**

<n> irrelevant

**Usage:**

Asynchronous command

**Manual operation:** See "[Single Sweep / Run Single](#)" on page 64

---

**INITiate<n>:REFResh**

Updates the current measurement results to reflect the current measurement settings.

No new I/Q data is captured. Thus, measurement settings apply to the I/Q data currently in the capture buffer.

The command applies exclusively to I/Q measurements. It requires I/Q data.

**Suffix:**

<n> irrelevant

**Example:**

INIT:REFR

Updates the IQ measurement results.

**Usage:**

Asynchronous command

**Manual operation:** See "[Refresh \(MSRA / MSRT only\)](#)" on page 65

---

**INITiate:SEQuencer:ABORt**

Stops the currently active sequence of measurements.

You can start a new sequence any time using [INITiate:SEQuencer:IMMediate](#) on page 267.

**Usage:**

Event

---

**INITiate:SEQuencer:IMMediate**

Starts a new sequence of measurements by the Sequencer.

Its effect is similar to the [INITiate<n>\[:IMMediate\]](#) command used for a single measurement.

Before this command can be executed, the Sequencer must be activated (see [SYSTem:SEQuencer](#) on page 268).

**Example:**

SYST:SEQ ON

Activates the Sequencer.

INIT:SEQ:MODE SING

Sets single sequence mode so each active measurement is performed once.

INIT:SEQ:IMM

Starts the sequential measurements.

---

**INITiate:SEQuencer:MODE <Mode>**

Defines the capture mode for the entire measurement sequence and all measurement groups and channels it contains.

**Note:** To synchronize to the end of a measurement sequence using `*OPC`, `*OPC?` or `*WAI`, use `SINGLE` Sequencer mode.

**Parameters:**

<Mode>

**SINGLE**

Each measurement group is started one after the other in the order of definition. All measurement channels in a group are started simultaneously and performed once. After *all* measurements are completed, the next group is started. After the last group, the measurement sequence is finished.

**CONTInuous**

Each measurement group is started one after the other in the order of definition. All measurement channels in a group are started simultaneously and performed once. After *all* measurements are completed, the next group is started. After the last group, the measurement sequence restarts with the first one and continues until it is stopped explicitly.

\*RST:       CONTInuous

**INITiate:SEQuencer:REFResh[:ALL]**

Is only available if the Sequencer is deactivated (`SYSTem:SEQuencer` `SYST:SEQ:OFF`) and only in MSRA / MSRT mode.

The data in the capture buffer is re-evaluated by all active MSRA / MSRT secondary applications.

**Example:**

`SYST:SEQ:OFF`

Deactivates the scheduler

`INIT:CONT OFF`

Switches to single sweep mode.

`INIT;*WAI`

Starts a new data measurement and waits for the end of the sweep.

`INIT:SEQ:REFR`

Refreshes the display for all channels.

**SYSTem:SEQuencer <State>**

Turns the Sequencer on and off. The Sequencer must be active before any other Sequencer commands (`INIT:SEQ. . .`) are executed, otherwise an error occurs.

A detailed programming example is provided in the "Operating Modes" chapter in the FSW User Manual.

**Parameters:**

<State>

ON | OFF | 0 | 1

**ON | 1**

The Sequencer is activated and a sequential measurement is started immediately.

**OFF | 0**

The Sequencer is deactivated. Any running sequential measurements are stopped. Further Sequencer commands (INIT:SEQ...) are not available.

\*RST: 0

**Example:**

SYST:SEQ ON

Activates the Sequencer.

INIT:SEQ:MODE SING

Sets single Sequencer mode so each active measurement is performed once.

INIT:SEQ:IMM

Starts the sequential measurements.

SYST:SEQ OFF

## 11.6 Configuring the result display

The following remote commands are required to configure the screen display in a remote environment.

- [General window commands](#).....269
- [Working with windows in the display](#).....270

### 11.6.1 General window commands

The following commands are required to configure general window layout, independent of the application.

Note that the suffix <n> always refers to the window *in the currently selected channel* (see [INSTrument\[:SElect\]](#) on page 154).

<a href="#">DISPlay:FORMat</a> .....	269
<a href="#">DISPlay[:WINDow&lt;n&gt;]:SIZE</a> .....	270

---

#### **DISPlay:FORMat** <Format>

Determines which tab is displayed.

**Parameters:**

<Format>

**SPLit**

Displays the MultiView tab with an overview of all active channels

**SINGle**

Displays the measurement channel that was previously focused.

\*RST: SING

**Example:**

DISP:FORM SPL

**DISPlay[:WINDow<n>]:SIZE <Size>**

Maximizes the size of the selected result display window *temporarily*. To change the size of several windows on the screen permanently, use the `LAY:SPL` command (see [LAYout:SPLitter](#) on page 274).

**Suffix:**

<n> [Window](#)

**Parameters:**

<Size>

**LARGE**

Maximizes the selected window to full screen.  
Other windows are still active in the background.

**SMALI**

Reduces the size of the selected window to its original size.  
If more than one measurement window was displayed originally, these are visible again.

\*RST: SMALI

**Example:**

DISP:WIND2:SIZE LARG

## 11.6.2 Working with windows in the display

The following commands are required to change the evaluation type and rearrange the screen layout for a channel as you do using the SmartGrid in manual operation. Since the available evaluation types depend on the selected application, some parameters for the following commands also depend on the selected channel.

Note that the suffix <n> always refers to the window *in the currently selected channel*.

(See [INSTrument\[:SElect\]](#) on page 154).

<a href="#">LAYout:ADD[:WINDow]?</a> .....	270
<a href="#">LAYout:CATalog[:WINDow]?</a> .....	272
<a href="#">LAYout:IDENtify[:WINDow]?</a> .....	272
<a href="#">LAYout:MOVE[:WINDow]</a> .....	273
<a href="#">LAYout:REMove[:WINDow]</a> .....	273
<a href="#">LAYout:REPLace[:WINDow]</a> .....	273
<a href="#">LAYout:SPLitter</a> .....	274
<a href="#">LAYout:WINDow&lt;n&gt;:ADD?</a> .....	275
<a href="#">LAYout:WINDow&lt;n&gt;:IDENtify?</a> .....	276
<a href="#">LAYout:WINDow&lt;n&gt;:REMove</a> .....	276
<a href="#">LAYout:WINDow&lt;n&gt;:REPLace</a> .....	276
<a href="#">LAYout:WINDow&lt;n&gt;:TYPE</a> .....	277

**LAYout:ADD[:WINDow]?** <WindowName>, <Direction>, <WindowType>

Adds a window to the display in the active channel.

Is always used as a query so that you immediately obtain the name of the new window as a result.

To replace an existing window, use the `LAYout:REPLace[:WINDow]` command.

**Query parameters:**

<WindowName>	String containing the name of the existing window the new window is inserted next to. By default, the name of a window is the same as its index. To determine the name and index of all active windows, use the <code>LAYout:CATalog[:WINDow]?</code> query.
<Direction>	LEFT   RIGHT   ABOVE   BELOW Direction the new window is added relative to the existing window.
<WindowType>	text value Type of result display (evaluation method) you want to add. See the table below for available parameter values.

**Return values:**

<NewWindowName> When adding a new window, the command returns its name (by default the same as its number) as a result.

**Example:** `LAY:ADD? '1',BEL,'XTIM:AM:RELative[:TDOMain]'`  
Adds an "AM Time Domain" display below window 1.

**Usage:** Query only

**Manual operation:** See "AM Time Domain" on page 15  
See "FM Time Domain" on page 16  
See "PM Time Domain" on page 17  
See "AM Spectrum" on page 18  
See "FM Spectrum" on page 19  
See "PM Spectrum" on page 20  
See "RF Time Domain" on page 21  
See "RF Spectrum" on page 22  
See "Result Summary" on page 23  
See "Marker Table" on page 25  
See "Marker Peak List" on page 25

*Table 11-4: <WindowType> parameter values for AnalogDemod application*

Parameter value	Window type
MTABLE	"Marker table"
PEAKlist	"Marker peak list"
RECORDing	"I/Q 40G Recording" window providing "Insert Marker" function
RSUMmary	"Result summary"
'XTIM:AM'	"RF Time Domain" (= RF power)
'XTIM:AM:RELative'	"AM Time Domain"
'XTIM:AM:RELative:AFSPec-trum'	"AM Spectrum"

Parameter value	Window type
'XTIM:FM'	"FM Time Domain"
'XTIM:FM:AFSPpectrum'	"FM Spectrum"
'XTIM:PM'	"PM Time Domain"
'XTIM:PM:AFSPpectrum'	"PM Spectrum"
'XTIM:SPECTrum'	"RF Spectrum"

---

### LAYout:CATalog[:WINDow]?

Queries the name and index of all active windows in the active channel from top left to bottom right. The result is a comma-separated list of values for each window, with the syntax:

<WindowName\_1>,<WindowIndex\_1>..<WindowName\_n>,<WindowIndex\_n>

#### Return values:

<WindowName>      string  
Name of the window.  
In the default state, the name of the window is its index.

<WindowIndex>    **numeric value**  
Index of the window.

#### Example:

LAY:CAT?

Result:

'2',2,'1',1

Two windows are displayed, named '2' (at the top or left), and '1' (at the bottom or right).

**Usage:**            Query only

---

### LAYout:IDENTify[:WINDow]? <WindowName>

Queries the **index** of a particular display window in the active channel.

**Note:** to query the **name** of a particular window, use the [LAYout:WINDow<n>:IDENTify?](#) query.

#### Query parameters:

<WindowName>      String containing the name of a window.

#### Return values:

<WindowIndex>    Index number of the window.

#### Example:

LAY:IDEN:WIND? '2'

Queries the index of the result display named '2'.

Response:

2

**Usage:**            Query only



---

**LAYout:MOVE[:WINDow]** <WindowName>, <WindowName>, <Direction>

**Setting parameters:**

<WindowName> String containing the name of an existing window that is to be moved.  
By default, the name of a window is the same as its index. To determine the name and index of all active windows in the active channel, use the [LAYout:CATalog\[:WINDow\]?](#) query.

<WindowName> String containing the name of an existing window the selected window is placed next to or replaces.  
By default, the name of a window is the same as its index. To determine the name and index of all active windows in the active channel, use the [LAYout:CATalog\[:WINDow\]?](#) query.

<Direction> LEFT | RIGHT | ABOVE | BELOW | REPLACE  
Destination the selected window is moved to, relative to the reference window.

**Example:** `LAY:MOVE '4', '1', LEFT`  
Moves the window named '4' to the left of window 1.

**Example:** `LAY:MOVE '1', '3', REPL`  
Replaces the window named '3' by window 1. Window 3 is deleted.

**Usage:** Setting only

---

**LAYout:REMOve[:WINDow]** <WindowName>

Removes a window from the display in the active channel.

**Setting parameters:**

<WindowName> String containing the name of the window. In the default state, the name of the window is its index.

**Example:** `LAY:REM '2'`  
Removes the result display in the window named '2'.

**Usage:** Setting only

---

**LAYout:REPLace[:WINDow]** <WindowName>, <WindowType>

Replaces the window type (for example from "Diagram" to "Result Summary") of an already existing window in the active channel while keeping its position, index and window name.

To add a new window, use the [LAYout:ADD\[:WINDow\]?](#) command.

**Setting parameters:**

<WindowName> String containing the name of the existing window.  
By default, the name of a window is the same as its index. To determine the name and index of all active windows in the active channel, use the [LAYout:CATalog\[:WINDow\]?](#) query.

<WindowType> Type of result display you want to use in the existing window. See [LAYout:ADD\[:WINDow\]?](#) on page 270 for a list of available window types.

**Example:** LAY:REPL:WIND '1',MTAB  
Replaces the result display in window 1 with a marker table.

**Usage:** Setting only

### LAYout:SPLitter <Index1>, <Index2>, <Position>

Changes the position of a splitter and thus controls the size of the windows on each side of the splitter.

Compared to the [DISPlay\[:WINDow<n>\]:SIZE](#) on page 270 command, the [LAYout:SPLitter](#) changes the size of all windows to either side of the splitter permanently, it does not just maximize a single window temporarily.

Note that windows must have a certain minimum size. If the position you define conflicts with the minimum size of any of the affected windows, the command does not work, but does not return an error.

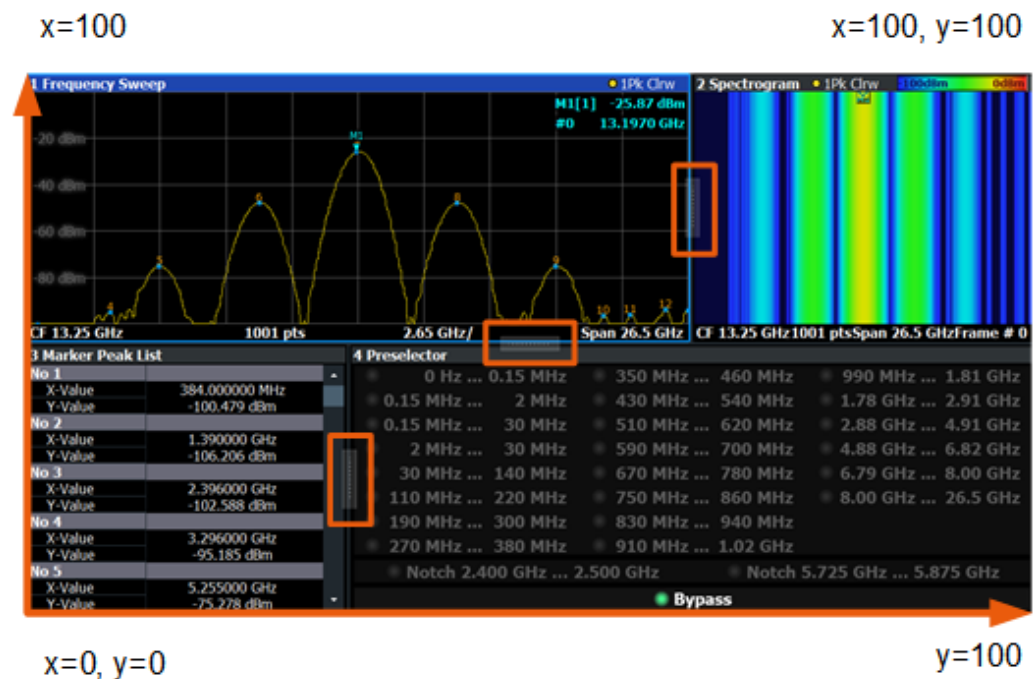

Figure 11-1: SmartGrid coordinates for remote control of the splitters

#### Setting parameters:

<Index1> The index of one window the splitter controls.  
<Index2> The index of a window on the other side of the splitter.

<b>&lt;Position&gt;</b>	<p>New vertical or horizontal position of the splitter as a fraction of the screen area (without channel and status bar and softkey menu).</p> <p>The point of origin (x = 0, y = 0) is in the lower left corner of the screen. The end point (x = 100, y = 100) is in the upper right corner of the screen. (See <a href="#">Figure 11-1</a>.)</p> <p>The direction in which the splitter is moved depends on the screen layout. If the windows are positioned horizontally, the splitter also moves horizontally. If the windows are positioned vertically, the splitter also moves vertically.</p> <p>Range: 0 to 100</p>
<b>Example:</b>	<pre>LAY:SPL 1,3,50</pre> <p>Moves the splitter between window 1 ('Frequency Sweep') and 3 ('Marker Table') to the center (50%) of the screen, i.e. in the figure above, to the left.</p>
<b>Example:</b>	<pre>LAY:SPL 1,4,70</pre> <p>Moves the splitter between window 1 ('Frequency Sweep') and 3 ('Marker Peak List') towards the top (70%) of the screen. The following commands have the exact same effect, as any combination of windows above and below the splitter moves the splitter vertically.</p> <pre>LAY:SPL 3,2,70 LAY:SPL 4,1,70 LAY:SPL 2,1,70</pre>
<b>Usage:</b>	Setting only

---

#### **LAYout:WINDow<n>:ADD? <Direction>,<WindowType>**

Adds a measurement window to the display. Note that with this command, the suffix <n> determines the existing window next to which the new window is added. Unlike [LAYout:ADD\[:WINDow\]?](#), for which the existing window is defined by a parameter.

To replace an existing window, use the [LAYout:WINDow<n>:REPLace](#) command.

Is always used as a query so that you immediately obtain the name of the new window as a result.

**Suffix:**

<n> [Window](#)

**Query parameters:**

<Direction> LEFT | RIGHT | ABOVE | BELOW

<WindowType> Type of measurement window you want to add.  
See [LAYout:ADD\[:WINDow\]?](#) on page 270 for a list of available window types.

**Return values:**

<NewWindowName> When adding a new window, the command returns its name (by default the same as its number) as a result.

**Example:** LAY:WIND1:ADD? LEFT,MTAB  
 Result:  
 '2'  
 Adds a new window named '2' with a marker table to the left of window 1.

**Usage:** Query only

#### LAYout:WINDow<n>:IDENtify?

Queries the **name** of a particular display window (indicated by the <n> suffix) in the active channel.

**Note:** to query the **index** of a particular window, use the [LAYout:IDENtify\[:WINDow\]?](#) command.

**Suffix:**  
 <n> [Window](#)

**Return values:**  
 <WindowName> String containing the name of a window.  
 In the default state, the name of the window is its index.

**Example:** LAY:WIND2:IDEN?  
 Queries the name of the result display in window 2.  
 Response:  
 '2'

**Usage:** Query only

#### LAYout:WINDow<n>:REMOve

Removes the window specified by the suffix <n> from the display in the active channel.

The result of this command is identical to the [LAYout:REMOve\[:WINDow\]](#) command.

**Suffix:**  
 <n> [Window](#)

**Example:** LAY:WIND2:REM  
 Removes the result display in window 2.

**Usage:** Event

#### LAYout:WINDow<n>:REPLace <WindowType>

Changes the window type of an existing window (specified by the suffix <n>) in the active channel.

The effect of this command is identical to the [LAYout:REPLace\[:WINDow\]](#) command.

To add a new window, use the [LAYout:WINDow<n>:ADD?](#) command.

**Suffix:**<n> [Window](#)**Setting parameters:**

<WindowType> Type of measurement window you want to replace another one with.  
See [LAYout:ADD\[:WINDow\]?](#) on page 270 for a list of available window types.

**Example:**

LAY:WIND2:REPL MTAB

Replaces the result display in window 2 with a marker table.

**Usage:**

Setting only

**LAYout:WINDow<n>:TYPE <WindowType>**

Queries or defines the window type of the window specified by the index <n>. The window type determines which results are displayed. For a list of possible window types, see [LAYout:ADD\[:WINDow\]?](#) on page 270.

Note that this command is not available in all applications and measurements.

**Suffix:**<n> 1..n  
[Window](#)**Parameters:**

&lt;WindowType&gt;

**Example:**

LAY:WIND2:TYPE?

## 11.7 Retrieving results

The following remote commands are required to retrieve the results from an Analog Modulation Analysis in a remote environment.



In the Analog Modulation Analysis when you configure the traces for a window with a specific evaluation (e.g. AM time domain), the traces in all windows with the same evaluation are configured identically.

**Specific commands:**

- [Retrieving trace results](#)..... 278
- [Exporting trace results](#)..... 281
- [Retrieving result summary values](#)..... 284
- [Formats for returned values: ASCII format and binary format](#)..... 288
- [Reference: ASCII file export format](#)..... 289

### 11.7.1 Retrieving trace results

The following remote commands are required to retrieve the trace results in a remote environment.

[SENSe:]ADEMod:ACV:AFSPepectrum:RESult?	278
[SENSe:]ADEMod:ACV[:TDOMain]:RESult?	278
[SENSe:]ADEMod:AM[:ABSolute]:AFSPepectrum:RESult?	278
[SENSe:]ADEMod:AM[:ABSolute][:TDOMain]:RESult?	278
[SENSe:]ADEMod:AM:RELative:AFSPepectrum:RESult?	278
[SENSe:]ADEMod:AM:RELative[:TDOMain]:RESult?	278
[SENSe:]ADEMod:FM:AFSPepectrum:RESult?	278
[SENSe:]ADEMod:FM[:TDOMain]:RESult?	278
[SENSe:]ADEMod:PM:AFSPepectrum:RESult?	278
[SENSe:]ADEMod:PM[:TDOMain]:RESult?	278
[SENSe:]ADEMod:SPEctrum:RESult?	278
FORMat[:DATA]	279
FORMat:DEXPort:FORMat	280
TRACe<n>[:DATA]	280

---

```
[SENSe:]ADEMod:ACV:AFSPepectrum:RESult? <TraceMode>
[SENSe:]ADEMod:ACV[:TDOMain]:RESult? <TraceMode>
[SENSe:]ADEMod:AM[:ABSolute]:AFSPepectrum:RESult? <TraceMode>
[SENSe:]ADEMod:AM[:ABSolute][:TDOMain]:RESult? <TraceMode>
[SENSe:]ADEMod:AM:RELative:AFSPepectrum:RESult? <TraceMode>
[SENSe:]ADEMod:AM:RELative[:TDOMain]:RESult? <TraceMode>
[SENSe:]ADEMod:FM:AFSPepectrum:RESult? <TraceMode>
[SENSe:]ADEMod:FM[:TDOMain]:RESult? <TraceMode>
[SENSe:]ADEMod:PM:AFSPepectrum:RESult? <TraceMode>
[SENSe:]ADEMod:PM[:TDOMain]:RESult? <TraceMode>
[SENSe:]ADEMod:SPEctrum:RESult? <TraceMode>
```

Reads the result data of the evaluated signal in the specified trace mode. The data format of the output data block is defined by the FORMat command (see FORMat [ : DATA ] on page 279).

The trace results are configured for a specific evaluation. The following table indicates which command syntax refers to which evaluation method, as well as the output unit of the results.

Command syntax	Evaluation method	Output unit
ACV[:TDOMain]	AC-Video time domain	V
ACV:AFSPepectrum	AC-Video spectrum	V
AM[:ABSolute][:TDOMain]	RF time domain	dBm
AM:RELative[:TDOMain]	AM time domain	%
AM:RELative:AFSPepectrum	AM spectrum	%
FM[:TDOMain]	FM time domain	kHz
FM:AFSPepectrum	FM spectrum	kHz

Command syntax	Evaluation method	Output unit
PM[:TDOMain]	PM time domain	rad or °
PM:AFSPepectrum	PM spectrum	rad or °
SPEctrum	RF spectrum	dBm (logarithmic display) or V (linear display).

**Query parameters:**

<TraceMode> WRITE | AVERage | MAXHold | MINHold

**Return values:**

<TraceModeResult> The specified trace mode must be one of those configured by SENS:ADEM:<Evaluation>:TYPE, see [SENSe:]ADEMod:SPEctrum[:TYPE] on page 302. Otherwise a query error is generated.

**Example:**

```

ADEM:AM AVER,MAXH,MINH
Sets up RF time domain results to be measured
INIT; *WAI
Starts measurement and waits for sync
FORM ASC
Selects output format
ADEM:AM:RES? AVER
Reads RF time domain average results
ADEM:AM:RES? MAXH
Reads RF time domain max hold results
ADEM:AM:RES? MINH
Reads RF time domain min hold results

```

**Usage:** Query only

**FORMat[:DATA] <Format>[, <BitLength>]**

Selects the data format that is used for transmission of trace data from the FSW to the controlling computer.

Note that the command has no effect for data that you send to the FSW. The FSW automatically recognizes the data it receives, regardless of the format.

**Parameters:**

<Format> **AScii**  
 Ascii format, separated by commas.  
 This format is almost always suitable, regardless of the actual data format. However, the data is not as compact as other formats can be.

**REAL**

Floating-point numbers (according to IEEE 754) in the "definite length block format".

In the Spectrum application, the format setting `REAL` is used for the binary transmission of trace data.

<BitLength>

Length in bits for floating-point results

**16**

16-bit floating-point numbers.

Compared to `REAL, 32` format, half as many numbers are returned.

**32**

32-bit floating-point numbers

For I/Q data, 8 bytes per sample are returned for this format setting.

**64**

64-bit floating-point numbers

Compared to `REAL, 32` format, twice as many numbers are returned.

**Example:**

```
FORM REAL, 32
```

**FORMat:DEXPort:FORMat** <FileFormat>

Determines the format of the ASCII file to be imported or exported. Depending on the external program that creates the data file or evaluates it, a comma-separated list (CSV) or a plain data format (DAT) file is required.

**Parameters:**

<FileFormat> CSV | DAT

\*RST: DAT

**Example:**

```
FORM:DEXP:FORM CSV
```

**Manual operation:** See "[File Type](#)" on page 108

**TRACe<n>[:DATA]**

This command queries current trace data and measurement results.

The data format depends on [FORMat \[:DATA\]](#) on page 279.

**Suffix:**

<n> [Window](#)



**Query parameters:**

<ResultType> Selects the type of result to be returned.

**TRACE1 | ... | TRACE6**  
Returns the trace data for the corresponding trace. The trace data consists of a list of measured power levels. The number of power levels in the list depends on the currently selected number of sweep points. The unit depends on the measurement and on the configured unit. For the auto peak detector, the command returns positive peak values only. (To retrieve negative peak values, define a second trace with a negative peak detector.)

**Example:**

```
TRAC? TRACE3
Queries the data of trace 3.
```

## 11.7.2 Exporting trace results

Trace results can be exported to a file.

For more commands concerning data and results storage, see the FSW User Manual.

FORMat:DEXPort:CSEPARATOR.....	281
FORMat:DEXPort:DSEPARATOR.....	282
FORMat:DEXPort:HEADer.....	282
FORMat:DEXPort:TRACes.....	282
MMEMory:STORe<n>:SPECtrogram.....	283
MMEMory:STORe<n>:TRACe.....	283

**FORMat:DEXPort:CSEPARATOR <Separator>**

Selects the column separator for exported trace data.

The selected value is not affected by a preset. The command therefore has no reset value.

**Parameters:**

<Separator>

**COMMa**  
Selects a comma as a separator.

**SEMicolon**  
Selects a semicolon as a separator.

**TAB**  
Selects a tabulator as a separator.

\*RST: n/a

**Example:**

```
//Select column separator
FORM:DEXP:CSEP TAB
```

**Manual operation:** See "[Column Separator](#)" on page 108

**FORMat:DEXPort:DSEParator** <Separator>

Selects the decimal separator for data exported in ASCII format.

**Parameters:**

<Separator>            POINT | COMMa

**COMMa**

Uses a comma as decimal separator, e.g. 4,05.

**POINT**

Uses a point as decimal separator, e.g. 4.05.

\*RST:            \*RST has no effect on the decimal separator.  
Default is POINT.

**Example:**

FORM:DEXP:DSEP POIN

Sets the decimal point as separator.

**Manual operation:** See "[Decimal Separator](#)" on page 107  
See "[Export Peak List](#)" on page 128

**FORMat:DEXPort:HEADer** <State>

If enabled, additional instrument and measurement settings are included in the header of the export file for result data. If disabled, only the pure result data from the selected traces and tables is exported.

See [Chapter 11.7.5, "Reference: ASCII file export format"](#), on page 289 for details.

**Parameters:**

<State>                ON | OFF | 0 | 1

\*RST:                1

**Manual operation:** See "[Include Instrument & Measurement Settings](#)" on page 106

**FORMat:DEXPort:TRACes** <Selection>

Selects the data to be included in a data export file (see [MMEMory:STORe<n>:TRACe](#) on page 283).

**Parameters:**

<Selection>            SINGle | ALL

**SINGle**

Only a single trace is selected for export, namely the one specified by the [MMEMory:STORe<n>:TRACe](#) command.

**ALL**

Selects all active traces and result tables (e.g. "Result Summary", marker peak list etc.) in the current application for export to an ASCII file.

The <trace> parameter for the [MMEMory:STORe<n>:TRACe](#) command is ignored.

\*RST:                SINGle

**Manual operation:** See ["Export all Traces and all Table Results"](#) on page 106

---

### **MMEMory:STORe<n>:SPECTrogram <FileName>**

Exports spectrogram data to an ASCII file.

The file contains the data for every frame in the history buffer. The data corresponding to a particular frame begins with information about the frame number and the time that frame was recorded.

Note that, depending on the size of the history buffer, the process of exporting the data can take a while.

#### **Secure User Mode**

In secure user mode, settings that are stored on the instrument are stored to volatile memory, which is restricted to 256 MB. Thus, a "memory limit reached" error can occur although the hard disk indicates that storage space is still available.

To store data permanently, select an external storage location such as a USB memory device.

For details, see "Protecting Data Using the Secure User Mode" in the "Data Management" section of the FSW base unit user manual.

#### **Suffix:**

<n> [Window](#)

#### **Parameters:**

<FileName> String containing the path and name of the target file.

#### **Example:**

MMEM:STOR:SGR 'Spectrogram'  
Copies the spectrogram data to a file.

**Manual operation:** See ["Export Spectrogram to ASCII File"](#) on page 109

---

### **MMEMory:STORe<n>:TRACe <Trace>, <FileName>**

Exports trace data from the specified window to an ASCII file.

#### **Secure User Mode**

In secure user mode, settings that are stored on the instrument are stored to volatile memory, which is restricted to 256 MB. Thus, a "memory limit reached" error can occur although the hard disk indicates that storage space is still available.

To store data permanently, select an external storage location such as a USB memory device.

For details, see "Protecting Data Using the Secure User Mode" in the "Data Management" section of the FSW base unit user manual.

#### **Suffix:**

<n> [Window](#)

**Parameters:**

<Trace>                   Number of the trace to be stored  
(This parameter is ignored if the option "Export all Traces and all Table Results" is activated in the Export configuration settings, see [FORMat:DEXPort:TRACes](#) on page 282).

<FileName>               String containing the path and name of the target file.

**Example:**

MMEM:STOR1:TRAC 1, 'C:\TEST.ASC'  
Stores trace 1 from window 1 in the file TEST.ASC.

**Manual operation:**    See "[Export Trace to ASCII File](#)" on page 107

### 11.7.3 Retrieving result summary values

The result summary contains measurement values that are calculated from the trace data.

For details see "[Result Summary](#)" on page 23.

<a href="#">CALCulate&lt;n&gt;:MARKer&lt;m&gt;:FUNction:ADEMod:AFRequency[:RESult&lt;t&gt;]?</a> .....	284
<a href="#">CALCulate&lt;n&gt;:MARKer&lt;m&gt;:FUNction:ADEMod:AM[:RESult&lt;t&gt;]?</a> .....	285
<a href="#">CALCulate&lt;n&gt;:MARKer&lt;m&gt;:FUNction:ADEMod:FM[:RESult&lt;t&gt;]?</a> .....	285
<a href="#">CALCulate&lt;n&gt;:MARKer&lt;m&gt;:FUNction:ADEMod:PM[:RESult&lt;t&gt;]?</a> .....	285
<a href="#">CALCulate&lt;n&gt;:MARKer&lt;m&gt;:FUNction:ADEMod:AM[:RESult&lt;t&gt;]:RELative?</a> .....	285
<a href="#">CALCulate&lt;n&gt;:MARKer&lt;m&gt;:FUNction:ADEMod:FM[:RESult&lt;t&gt;]:RELative?</a> .....	285
<a href="#">CALCulate&lt;n&gt;:MARKer&lt;m&gt;:FUNction:ADEMod:PM[:RESult&lt;t&gt;]:RELative?</a> .....	285
<a href="#">CALCulate&lt;n&gt;:MARKer&lt;m&gt;:FUNction:ADEMod:CARRier[:RESult&lt;t&gt;]?</a> .....	286
<a href="#">CALCulate&lt;n&gt;:MARKer&lt;m&gt;:FUNction:ADEMod:DISTortion[:WRITe]:RESult&lt;t&gt;?</a> .....	286
<a href="#">CALCulate&lt;n&gt;:MARKer&lt;m&gt;:FUNction:ADEMod:FERRor[:RESult&lt;t&gt;]?</a> .....	287
<a href="#">CALCulate&lt;n&gt;:MARKer&lt;m&gt;:FUNction:ADEMod:SINad:RESult&lt;t&gt;?</a> .....	287
<a href="#">CALCulate&lt;n&gt;:MARKer&lt;m&gt;:FUNction:ADEMod:THD:RESult&lt;t&gt;?</a> .....	287
<a href="#">[SENSe:]ADEMod:SETTling:TIME:RESult&lt;t&gt;?</a> .....	288

---

#### **CALCulate<n>:MARKer<m>:FUNction:ADEMod:AFRequency[:RESult<t>]?**

Queries the modulation (audio) frequency for the demodulation method in the specified window.

**Suffix:**

<n>                        [Window](#)  
<m>                        irrelevant  
<t>                        [Trace](#)

**Return values:**

<ModFreq>               Modulation frequency in Hz.

**Usage:**                Query only

---

**CALCulate<n>:MARKer<m>:FUNCTION:ADEMod:AM[:RESult<t>]? <MeasType>**  
**CALCulate<n>:MARKer<m>:FUNCTION:ADEMod:FM[:RESult<t>]? <MeasType>**  
**CALCulate<n>:MARKer<m>:FUNCTION:ADEMod:PM[:RESult<t>]? <MeasType>**

Queries the current value of the demodulated signal for the specified trace (as displayed in the "Result Summary" in manual operation).

Note that all windows with the same evaluation method have the same traces, thus the window is irrelevant.

**Suffix:**

<n>                      [Window](#)  
 <m>                      irrelevant  
 <t>                      [Trace](#)

**Query parameters:**

<MeasType>            PPEak | MPEak | MIDDLE | RMS

**PPEak**

Positive peak (+PK)

**MPEak | NPEak**

Negative peak (-PK)

**MIDDLE**

Average of positive and negative peaks  $\pm PK/2$

**RMS**

Root mean square value

**Return values:**

<MeasTypeResult>

**Example:**

`CALC:FEED 'XTIM:PM:TDOM'`

Switches on the PM time domain result display.

`DISP:TRAC ON`

Switches on the trace.

`CALC:MARK:FUNC:ADEM:PM? PPE`

Queries the peak value of the demodulated PM trace.

**Usage:**

Query only

---

**CALCulate<n>:MARKer<m>:FUNCTION:ADEMod:AM[:RESult<t>]:RELative?**  
 <MeasType>

**CALCulate<n>:MARKer<m>:FUNCTION:ADEMod:FM[:RESult<t>]:RELative?**  
 <MeasType>

**CALCulate<n>:MARKer<m>:FUNCTION:ADEMod:PM[:RESult<t>]:RELative?**  
 <MeasType>

Queries the current *relative* value of the demodulated signal for the specified trace (as displayed in the "Result Summary" in manual operation).

Note that all windows with the same evaluation method have the same traces.

The unit of the results depends on the [CONFIGure:ADEMod:RESults:UNIT](#) setting.

**Suffix:**

<n>	irrelevant
<m>	irrelevant
<t>	<a href="#">Trace</a>

**Query parameters:**

<MeasType>	<b>PPEak</b> Positive peak (+PK)
	<b>MPEak   NPEak</b> Negative peak (-PK)
	<b>MIDDLE</b> Average of positive and negative peaks $\pm$ PK/2
	<b>RMS</b> Root mean square value

**Return values:**

&lt;MeasTypeResult&gt;

**Example:**

```
CALC:FEED 'XTIM:PM:TDOM'
Switches on the PM time domain result display.
DISP:TRAC ON
Switches on the trace.
CALC:MARK:FUNC:ADEM:PM? PPE
Queries the peak value of the demodulated PM trace.
```

**Usage:** Query only**CALCulate<n>:MARKer<m>:FUNCTION:ADEMod:CARRIER[:RESult<t>]?**

Queries the carrier power, which is determined from the Clr/Write data.

**Suffix:**

<n>	<a href="#">Window</a>
<m>	irrelevant
<t>	<a href="#">Trace</a>

**Return values:**

&lt;CPower&gt; Power of the carrier without modulation in dBm.

**Usage:** Query only**CALCulate<n>:MARKer<m>:FUNCTION:ADEMod:DISTortion[:WRITe]:RESult<t>?**

Queries the result of the modulation distortion measurement in the specified window for the specified trace.

Note that this value is only calculated if an AF Spectrum window is displayed.

**Suffix:**

<n>	<a href="#">Window</a>
-----	------------------------

<m> irrelevant

<t> [Trace](#)

**Return values:**

<DISTORT> numeric value  
Modulation distortion in percent.  
Default unit: %

**Usage:** Query only

**CALCulate<n>:MARKer<m>:FUNction:ADEMod:FERRor[:RESult<t>]?**

Queries the carrier offset (= frequency error) for FM and PM demodulation. The carrier offset is determined from the current measurement data (CLR/WRITE). The modulation is removed using low pass filtering.

**Suffix:**

<n> [Window](#)

<m> irrelevant

<t> [Trace](#)

**Return values:**

<CarrOffset> The deviation of the calculated carrier frequency to the ideal carrier frequency in Hz.

**Usage:** Query only

**CALCulate<n>:MARKer<m>:FUNction:ADEMod:SINad:RESult<t>?**

Queries the result of the signal-to-noise-and-distortion (SINAD) measurement in the specified window for the specified trace.

Note that this value is only calculated if an AF Spectrum window is displayed.

**Suffix:**

<n> [Window](#)

<m> irrelevant

<t> [Trace](#)

**Return values:**

<SINAD> The signal-to-noise-and-distortion ratio in dB.

**Usage:** Query only

**CALCulate<n>:MARKer<m>:FUNction:ADEMod:THD:RESult<t>?**

Queries the result of the total harmonic distortion (THD) measurement in the specified window.

Note that this value is only calculated if an AF Spectrum window is displayed.

<b>Suffix:</b>	
<n>	Window
<m>	irrelevant
<t>	Trace
<b>Return values:</b>	
<THD>	Total harmonic distortion of the demodulated signal in dB.
<b>Usage:</b>	Query only

#### [SENSe:]ADEMod:SETTling:TIME:RESult<t>?

Returns the settling time after which the signal remains within a specified target corridor. The settling time is evaluated for the selected trace in each time domain window. The value is only determined for [SENSe:]ADEMod:SETTling:TIME:STATeON.

For details, see [Chapter 5.7.7, "Settling time"](#), on page 85.

<b>Suffix:</b>	
<t>	1..n Trace
<b>Return values:</b>	
<Time>	Default unit: s
<b>Example:</b>	ADEMod:SETT:TIME:RES2? //Result: 29.950000us After 29.95 us, the signal is settled.
<b>Usage:</b>	Query only
<b>Manual operation:</b>	See <a href="#">"State"</a> on page 86

### 11.7.4 Formats for returned values: ASCII format and binary format

When trace data is retrieved using the TRAC:DATA or TRAC:IQ:DATA command, the data is returned in the format defined using the FORMat[:DATA] on page 279. The possible formats are described here.

- ASCII Format (FORMat ASCII):  
The data is stored as a list of comma-separated values (CSV) of the measured values in floating point format.
- Binary Format (FORMat REAL,16/32/64):  
The data is stored as binary data (definite length block data according to IEEE 488.2), each measurement value being formatted in 16-bit/32-bit/64-bit IEEE 754 floating-point-format.  
The schema of the result string is as follows:  
#<Length of length><Length of data><value1><value2>...<value n>  
with:



<Length of length>	Number of digits of the following number of data bytes
<Length of data>	Number of following data bytes
<Value>	2-byte/4-byte/8-byte floating point value

**Example:** #41024<Data>... contains 1024 data bytes

### Data blocks larger than 999,999,999 bytes

According to SCPI, the header of the block data format allows for a maximum of 9 characters to describe the data length. Thus, the maximum REAL 32 data that can be represented is 999,999,999 bytes. However, the FSW is able to send larger data blocks. In this case, the length of the data block is placed in brackets, e.g.

# (1234567890) <value1><value2>...



Reading out data in binary format is quicker than in ASCII format. Thus, binary format is recommended for large amounts of data.

## 11.7.5 Reference: ASCII file export format

Trace data can be exported to a file in ASCII format for further evaluation in other applications. This reference describes in detail the format of the export files for result data.

The file consists of the header containing important scaling parameters and a data section containing the trace data. Optionally, the header can be excluded from the file (see ["Include Instrument & Measurement Settings"](#) on page 106).

The data of the file header consist of three columns, each separated by a semicolon: parameter name; numeric value; basic unit. The data section starts with the keyword "Trace <n>" (<n> = number of stored trace). The measured data follows in one or several columns (depending on the measurement), which are also separated by a semicolon.

The results are output in the same order as they are displayed on the screen: window by window, trace by trace, and table row by table row.

Generally, the format of this ASCII file can be processed by spreadsheet calculation programs, e.g. MS-Excel. Different language versions of evaluation programs can require a different handling of the decimal point. Thus, you can define the decimal separator to use (decimal point or comma, see ["Decimal Separator"](#) on page 107).

**Table 11-5: ASCII file format for trace export in the Spectrum application**

File contents	Description
<b>Header data</b>	
Type;FSW;	Instrument model
Version;1.00;	Firmware version
Date;01.Oct 2006;	Date of data set storage
Mode;ANALYZER;	Operating mode

File contents	Description
Preamplifier;OFF	Preamplifier status
Transducer; OFF	Transducer status
Center Freq;55000;Hz	Center frequency
Freq Offset;0;Hz	Frequency offset
Start;10000;Hz Stop;100000;Hz	Start/stop of the display range. Unit: Hz for span > 0, s for span = 0, dBm/dB for statistics measurements
Span;90000;Hz	Frequency range (0 Hz in zero span and statistics measurements)
Ref Level;-30;dBm	Reference level
Level Offset;0;dB	Level offset
Rf Att;20;dB	Input attenuation
EI Att;2.0;dB	Electrical attenuation
RBW;100000;Hz	Resolution bandwidth
VBW;30000;Hz	Video bandwidth
SWT;0.005;s	Sweep time
Sweep Count;20;	Number of sweeps set
Ref Position;75;%	Position of reference level referred to diagram limits (0 % = lower edge)
Level Range;100;dB	Display range in y direction. Unit: dB with x-axis LOG, % with x-axis LIN
x-Axis;LIN;	Scaling of x-axis linear (LIN) or logarithmic (LOG)
y-Axis;LOG;	Scaling of y-axis linear (LIN) or logarithmic (LOG)
x-Unit;Hz;	Unit of x values: Hz with span > 0; s with span = 0; dBm/dB with statistics measurements
y-Unit;dBm;	Unit of y values: dB*/V/A/W depending on the selected unit with y-axis LOG or % with y-axis LIN
<b>Data section for individual window</b>	
Window;1;Frequency Sweep	Window number and name
Trace 1;;	Selected trace
Trace Mode;AVERAGE;	Display mode of trace: CLR/WRITE,AVERAGE,MAXHOLD,MINHOLD
Detector;AUTOPEAK;	Selected detector
Values; 1001;	Number of measurement points

File contents	Description
10000;-10.3;-15.7 10130;-11.5;-16.9 10360;-12.0;-17.4 ...;...;	Measured values: <x value>, <y1>, <y2>; <y2> being available only with detector AUTOPEAK and containing in this case the smallest of the two measured values for a measurement point.
<b>Data section for individual trace</b>	
Trace 2;;	Next trace in same window
...	
<b>Data section for individual window</b>	
Window;2 ..;	Name of next window
<b>Data section for individual trace</b>	
Trace 1;;	First trace
...	

## 11.8 Analyzing results

The following remote commands are required to configure general result analysis settings concerning the trace, markers, lines etc. in a remote environment. They are identical to the analysis functions in the base unit except for some special marker functions and spectrograms, which are not available in the R&S FSW AM/FM/PM Modulation Analysis application.

More details are described for manual operation in [Chapter 6, "Analysis"](#), on page 96.

- [Configuring spectrograms](#)..... 291
- [Configuring standard traces](#)..... 299
- [Working with markers remotely](#)..... 306
- [Marker search \(spectrograms\)](#)..... 346
- [Defining limit checks](#)..... 354
- [Configuring an analysis interval and line \(MSRA mode only\)](#)..... 370
- [Configuring an analysis interval and line \(MSRT mode only\)](#)..... 372

### 11.8.1 Configuring spectrograms

In addition to the standard "level versus frequency" or "level versus time" spectrum traces, the FSW also provides a spectrogram display of the measured data. A spectrogram shows how the spectral density of a signal varies over time. The x-axis shows the frequency, the y-axis shows the time. The commands required to configure spectrograms in a remote environment are described here. For details and manual operation see [Chapter 6.2, "Spectrogram settings"](#), on page 100.



When configuring spectrograms, the window suffix is irrelevant. The settings are always applied to the spectrogram window, or to all spectrogram windows, if several are active for the same channel.

For commands to set markers in spectrograms, see [Chapter 11.8.3.3, "Marker search \(spectrograms\)"](#), on page 315.

11.8.1.1	Configuring a spectrogram measurement.....	292
11.8.1.2	Configuring the color map.....	297

### 11.8.1.1 Configuring a spectrogram measurement

CALCulate<n>:SGRam:CLEar[:IMMediate]	.....	292
CALCulate<n>:SPEctrogram:CLEar[:IMMediate]	.....	292
CALCulate<n>:SGRam:CONTinuous	.....	293
CALCulate<n>:SPEctrogram:CONTinuous	.....	293
CALCulate<n>:SGRam:FRAMe:COUNT	.....	293
CALCulate<n>:SPEctrogram:FRAMe:COUNT	.....	293
CALCulate<n>:SGRam:FRAMe:SElect	.....	294
CALCulate<n>:SPEctrogram:FRAMe:SElect	.....	294
CALCulate<n>:SGRam:HDEPth	.....	294
CALCulate<n>:SPEctrogram:HDEPth	.....	294
CALCulate<n>:SGRam:LAYout	.....	294
CALCulate<n>:SPEctrogram:LAYout	.....	294
CALCulate<n>:SGRam[:STATe]	.....	295
CALCulate<n>:SPEctrogram[:STATe]	.....	295
CALCulate<n>:SGRam:THReedim[:STATe]	.....	295
CALCulate<n>:SPEctrogram:THReedim[:STATe]	.....	295
CALCulate<n>:SGRam:TRACe	.....	296
CALCulate<n>:SPEctrogram:TRACe	.....	296
CALCulate<n>:SGRam:TSTamp:DATA?	.....	296
CALCulate<n>:SPEctrogram:TSTamp:DATA?	.....	296
CALCulate<n>:SGRam:TSTamp[:STATe]	.....	297
CALCulate<n>:SPEctrogram:TSTamp[:STATe]	.....	297

---

**CALCulate<n>:SGRam:CLEar[:IMMediate]**

**CALCulate<n>:SPEctrogram:CLEar[:IMMediate]**

Resets the spectrogram and clears the history buffer.

**Suffix:**

<n>                      [Window](#)

**Example:**            //Reset the result display and clear the memory

CALC:SGR:CLE

**Manual operation:** See "[Clear Spectrogram](#)" on page 66

---

**CALCulate<n>:SGRam:CONTInuous <State>**

**CALCulate<n>:SPECtrogram:CONTInuous <State>**

Determines whether the results of the last measurement are deleted before starting a new measurement in single sweep mode.

This setting applies to all spectrograms in the channel.

**Suffix:**

<n> [Window](#)

**Parameters:**

<State> ON | OFF | 0 | 1

**OFF | 0**

Switches the function off

**ON | 1**

Switches the function on

**Example:**

INIT:CONT OFF

Selects single sweep mode.

INIT;\*WAI

Starts the sweep and waits for the end of the sweep.

CALC:SGR:CONT ON

Repeats the single sweep measurement without deleting the results of the last measurement.

**Manual operation:** See ["Continue Frame"](#) on page 66

---

**CALCulate<n>:SGRam:FRAMe:COUNT <Frames>**

**CALCulate<n>:SPECtrogram:FRAMe:COUNT <Frames>**

Defines the number of frames to be recorded in a single sweep.

This value applies to all spectrograms in the channel.

**Suffix:**

<n> [Window](#)

**Parameters:**

<Frames> The maximum number of frames depends on the history depth.

Range: 1 to history depth

Increment: 1

\*RST: 1

**Example:**

//Select single sweep mode

INIT:CONT OFF

//Set the number of frames to 200

CALC:SGR:FRAM:COUN 200

**Manual operation:** See ["Frame Count"](#) on page 66

---

**CALCulate<n>:SGRam:FRAMe:SElect <Frame> | <Time>**  
**CALCulate<n>:SPECtrogram:FRAMe:SElect <Frame> | <Time>**

Selects a specific frame for further analysis.

The command is available if no measurement is running or after a single sweep has ended.

**Suffix:**

<n> [Window](#)

**Parameters:**

<Frame> Selects a frame directly by the frame number. Valid if the time stamp is off.  
 The range depends on the history depth.  
 Default unit: S

<Time> Selects a frame via its time stamp. Valid if the time stamp is on.  
 The number is the distance to frame 0 in seconds. The range depends on the history depth.

**Example:**

```
INIT:CONT OFF
Stop the continuous sweep.
CALC:SGR:FRAM:SEL -25
Selects frame number -25.
```

**Manual operation:** See ["Select Frame"](#) on page 65

---

**CALCulate<n>:SGRam:HDEPth <History>**  
**CALCulate<n>:SPECtrogram:HDEPth <History>**

Defines the number of frames to be stored in the FSW memory.

**Suffix:**

<n> [Window](#)

**Parameters:**

<History> The maximum number of frames depends on the number of sweep points.

Range: 781 to 20000

Increment: 1

\*RST: 3000

**Example:**

```
//Set the history depth to 1500
CALC:SGR:SPEC 1500
```

**Manual operation:** See ["History Depth"](#) on page 102

---

**CALCulate<n>:SGRam:LAYout <State>**  
**CALCulate<n>:SPECtrogram:LAYout <State>**

This command selects the state and size of spectrograms.

The command is available for result displays that support spectrograms.

**Suffix:**<n> [Window](#)**Parameters:**

<State> **FULL**  
Only the spectrogram is displayed, the trace diagram is not.

**SPLIT**  
Spectrogram and trace diagram share a window.

**OFF**  
Only the trace diagram is displayed, the spectrogram is not.

\*RST: OFF

**Example:**

CALC4:SPEC:LAY FULL

Shows the spectrogram in window 4. The corresponding trace diagram is hidden.

**Manual operation:** See "[State](#)" on page 101**CALCulate<n>:SGRam[:STATe]** <State>**CALCulate<n>:SPECtrogram[:STATe]** <State>

Turns the spectrogram on and off.

**Suffix:**

&lt;n&gt; irrelevant

**Parameters:**

<State> ON | OFF | 0 | 1

**OFF | 0**  
Switches the function off

**ON | 1**  
Switches the function on

**Example:**

CALC:SGR ON

Activates the Spectrogram result display.

**CALCulate<n>:SGRam:THReedim[:STATe]** <State>**CALCulate<n>:SPECtrogram:THReedim[:STATe]** <State>

Activates or deactivates a 3-dimensional spectrogram for the selected result display.

**Suffix:**<n> [Window](#)**Parameters:**

<State> ON | OFF | 0 | 1

**OFF | 0**  
Switches the function off

**ON | 1**  
Switches the function on

\*RST: 0

**Example:** `CALC:SPEC:THR:STAT ON`

**Manual operation:** See "[3D Spectrogram State](#)" on page 102

**CALCulate<n>:SGRam:TRACe <Trace>**

**CALCulate<n>:SPECtrogram:TRACe <Trace>**

This command determines the trace in the result display the Spectrogram is based on.

**Suffix:**

<n> [Window](#)

**Parameters:**

<Trace> TRACE1 | TRACE2 | TRACE3 | TRACE4 | TRACE5 | TRACE6

How many traces are available depends on the selected result display.

**Example:** `CALC2:SPEC:TRAC TRACE3`

**CALCulate<n>:SGRam:TSTamp:DATA? <Frames>**

**CALCulate<n>:SPECtrogram:TSTamp:DATA? <Frames>**

Queries the starting time of the frames.

The return values consist of four values for each frame. If the "Spectrogram" is empty, the command returns '0,0,0,0'. The times are given as delta values, which simplifies evaluating relative results; however, you can also calculate the absolute date and time as displayed on the screen.

The frame results themselves are returned with `TRAC:DATA? SGR`

**Suffix:**

<n> [Window](#)

**Query parameters:**

<Frames> **CURRENT**

Returns the starting time of the current frame.

**ALL**

Returns the starting time for all frames. The results are sorted in descending order, beginning with the current frame.

**Return values:**

<Seconds> Number of seconds that have passed since 01.01.1970 until the frame start

<Nanoseconds> Number of nanoseconds that have passed *in addition to the* <Seconds> since 01.01.1970 until the frame start.

<Reserved> The third value is reserved for future uses.

<Reserved> The fourth value is reserved for future uses.

**Example:** `CALC:SGR:TST:DATA? ALL`

Returns the starting times of all frames sorted in a descending order.



**Usage:** Query only  
**Manual operation:** See "Time Stamp" on page 102

---

**CALCulate<n>:SGRam:TSTamp[:STATE] <State>**  
**CALCulate<n>:SPECTrogram:TSTamp[:STATE] <State>**

Activates and deactivates the time stamp.

If the time stamp is active, some commands do not address frames as numbers, but as (relative) time values:

- [CALCulate<n>:DELTamarker<m>:SPECTrogram:FRAMe](#) on page 320
- [CALCulate<n>:MARKer<m>:SPECTrogram:FRAMe](#) on page 316
- [CALCulate<n>:SPECTrogram:FRAMe:SElect](#) on page 294

**Suffix:**

<n> 1..n  
[Window](#)

**Parameters:**

<State> ON | OFF | 0 | 1  
**OFF | 0**  
 Switches the function off  
**ON | 1**  
 Switches the function on

**Example:** //Activates the time stamp  
 CALC:SGR:TST ON

**Manual operation:** See "Time Stamp" on page 102

### 11.8.1.2 Configuring the color map

<a href="#">DISPlay[:WINDow&lt;n&gt;]:SGRam:COLor:DEFault</a> .....	297
<a href="#">DISPlay[:WINDow&lt;n&gt;]:SPECTrogram:COLor:DEFault</a> .....	297
<a href="#">DISPlay[:WINDow&lt;n&gt;]:SGRam:COLor:LOWer</a> .....	298
<a href="#">DISPlay[:WINDow&lt;n&gt;]:SPECTrogram:COLor:LOWer</a> .....	298
<a href="#">DISPlay[:WINDow&lt;n&gt;]:SGRam:COLor:SHAPE</a> .....	298
<a href="#">DISPlay[:WINDow&lt;n&gt;]:SPECTrogram:COLor:SHAPE</a> .....	298
<a href="#">DISPlay[:WINDow&lt;n&gt;]:SGRam:COLor:UPPer</a> .....	298
<a href="#">DISPlay[:WINDow&lt;n&gt;]:SPECTrogram:COLor:UPPer</a> .....	298
<a href="#">DISPlay[:WINDow&lt;n&gt;]:SGRam:COLor[:STYLe]</a> .....	299
<a href="#">DISPlay[:WINDow&lt;n&gt;]:SPECTrogram:COLor[:STYLe]</a> .....	299

---

**DISPlay[:WINDow<n>]:SGRam:COLor:DEFault**  
**DISPlay[:WINDow<n>]:SPECTrogram:COLor:DEFault**

Restores the original color map.

**Suffix:**

<n> [Window](#)

**Manual operation:** See ["Set to Default"](#) on page 105

---

**DISPlay[:WINDow<n>]:SGRam:COLor:LOWer** <Percentage>

**DISPlay[:WINDow<n>]:SPECTrogram:COLor:LOWer** <Percentage>

Defines the starting point of the color map.

**Suffix:**

<n> [Window](#)

**Parameters:**

<Percentage> Statistical frequency percentage.

Range: 0 to 66

\*RST: 0

Default unit: %

**Example:**

DISP:WIND:SGR:COL:LOW 10

Sets the start of the color map to 10%.

**Manual operation:** See ["Start / Stop"](#) on page 105

---

**DISPlay[:WINDow<n>]:SGRam:COLor:SHAPE** <Shape>

**DISPlay[:WINDow<n>]:SPECTrogram:COLor:SHAPE** <Shape>

Defines the shape and focus of the color curve for the spectrogram result display.

**Suffix:**

<n> [Window](#)

**Parameters:**

<Shape> Shape of the color curve.

Range: -1 to 1

\*RST: 0

**Manual operation:** See ["Shape"](#) on page 105

---

**DISPlay[:WINDow<n>]:SGRam:COLor:UPPer** <Percentage>

**DISPlay[:WINDow<n>]:SPECTrogram:COLor:UPPer** <Percentage>

Defines the end point of the color map.

**Suffix:**

<n> [Window](#)

**Parameters:**

<Percentage> Statistical frequency percentage.

Range: 0 to 66

\*RST: 0

Default unit: %

**Example:**

DISP:WIND:SGR:COL:UPP 95

Sets the start of the color map to 95%.

**Manual operation:** See ["Start / Stop"](#) on page 105

**DISPlay[:WINDow<n>]:SGRam:COLor[:STYLE] <ColorScheme>**  
**DISPlay[:WINDow<n>]:SPECtrogram:COLor[:STYLE] <ColorScheme>**

Selects the color scheme.

**Parameters:**

<ColorScheme>

**HOT**

Uses a color range from blue to red. Blue colors indicate low levels, red colors indicate high ones.

**COLD**

Uses a color range from red to blue. Red colors indicate low levels, blue colors indicate high ones.

**RADar**

Uses a color range from black over green to light turquoise with shades of green in between.

**GRAYscale**

Shows the results in shades of gray.

\*RST: HOT

**Example:**

DISP:WIND:SPEC:COL GRAY

Changes the color scheme of the spectrogram to black and white.

**Manual operation:** See "[Hot/Cold/Radar/Grayscale](#)" on page 105

## 11.8.2 Configuring standard traces

### Useful commands for trace configuration described elsewhere

- [DISPlay\[:WINDow<n>\]\[:SUBWindow<w>\]:TRACe<t>:Y:SPACing](#) on page 225
- [DISPlay\[:WINDow<n>\]\[:SUBWindow<w>\]:TRACe<t>:Y\[:SCALE\]](#) on page 223

### Remote commands exclusive to trace configuration

<a href="#">DISPlay[:WINDow&lt;n&gt;][:SUBWindow&lt;w&gt;]:TRACe&lt;t&gt;:MODE</a> .....	300
<a href="#">DISPlay[:WINDow&lt;n&gt;][:SUBWindow&lt;w&gt;]:TRACe&lt;t&gt;:MODE:HCONTinuous</a> .....	301
<a href="#">DISPlay[:WINDow&lt;n&gt;][:SUBWindow&lt;w&gt;]:TRACe&lt;t&gt;:SELEct</a> .....	301
<a href="#">DISPlay[:WINDow&lt;n&gt;][:SUBWindow&lt;w&gt;]:TRACe&lt;t&gt;[:STATE]</a> .....	302
<a href="#">[SENSe:]ADEMod:AM:RELative:AFSPectrum[:TYPE]</a> .....	302
<a href="#">[SENSe:]ADEMod:AM:RELative[:TDOMain][:TYPE]</a> .....	302
<a href="#">[SENSe:]ADEMod:AM[:ABSolute]:AFSPectrum[:TYPE]</a> .....	302
<a href="#">[SENSe:]ADEMod:AM[:ABSolute][:TDOMain][:TYPE]</a> .....	302
<a href="#">[SENSe:]ADEMod:FM:AFSPectrum[:TYPE]</a> .....	302
<a href="#">[SENSe:]ADEMod:FM[:TDOMain][:TYPE]</a> .....	302
<a href="#">[SENSe:]ADEMod:PM:AFSPectrum[:TYPE]</a> .....	302
<a href="#">[SENSe:]ADEMod:PM[:TDOMain][:TYPE]</a> .....	302
<a href="#">[SENSe:]ADEMod:SPECtrum[:TYPE]</a> .....	302

[SENSe:]AVERAge<n>:COUNT.....	304
[SENSe:]AVERAge<n>[:STATe<t>].....	304
[SENSe:]AVERAge<n>:TYPE.....	304
[SENSe:][WINDow<n>:]DETEctor<t>[:FUNction].....	305
[SENSe:][WINDow<n>:]DETEctor<t>[:FUNction]:AUTO.....	305

---

### DISPlay[:WINDow<n>][:SUBWindow<w>]:TRACe<t>:MODE <Mode>

Selects the trace mode. If necessary, the selected trace is also activated.

For max hold, min hold or average trace mode, you can set the number of single measurements with [SENSe:]SWEep:COUNT. Note that synchronization to the end of the measurement is possible only in single sweep mode.

In the R&S FSW AM/FM/PM Modulation Analysis application, when you configure the traces for a window with a specific evaluation (e.g. AM time domain), the traces in all windows with the same evaluation are configured identically.

#### Suffix:

<n>	Window
<w>	subwindow Not supported by all applications
<t>	Trace

#### Parameters:

<Mode>

#### WRITE

(default:) Overwrite mode: the trace is overwritten by each sweep.

#### AVERAge

The average is formed over several sweeps. The "Sweep/Average Count" determines the number of averaging procedures.

#### MAXHold

The maximum value is determined over several sweeps and displayed. The FSW saves the sweep result in the trace memory only if the new value is greater than the previous one.

#### MINHold

The minimum value is determined from several measurements and displayed. The FSW saves the sweep result in the trace memory only if the new value is lower than the previous one.

#### VIEW

The current contents of the trace memory are frozen and displayed.

#### BLANK

Hides the selected trace.

\*RST: Trace 1: WRITE, Trace 2-6: BLANK

**Example:**

```
INIT:CONT OFF
Switching to single sweep mode.
SWE:COUN 16
Sets the number of measurements to 16.
DISP:TRAC3:MODE WRIT
Selects clear/write mode for trace 3.
INIT;*WAI
Starts the measurement and waits for the end of the measurement.
```

**Manual operation:** See "[Trace Mode](#)" on page 97

### DISPlay[:WINDow<n>][:SUBWindow<w>]:TRACe<t>:MODE:HCONtinuous <State>

Turns an automatic reset of a trace on and off after a parameter has changed.

The reset works for trace modes min hold, max hold and average.

Note that the command has no effect if critical parameters like the span have been changed to avoid invalid measurement results

**Suffix:**

<n> [Window](#)

<w> subwindow

<t> [Trace](#)

**Parameters:**

<State> ON | OFF | 0 | 1

**OFF | 0**

Switches the function off

**ON | 1**

Switches the function on

**Example:**

```
DISP:WIND:TRAC3:MODE:HCON ON
Switches off the reset function.
```

**Manual operation:** See "[Hold](#)" on page 98

### DISPlay[:WINDow<n>][:SUBWindow<w>]:TRACe<t>:SELEct

Selects the trace specified by the index <t> in the window specified by the index <n>. Only traces that are active in the specified result display can be selected. The selected trace is used to determine the "Result Summary" for the corresponding result display.

The query returns the number of the currently selected trace in the window specified by the index <n> (trace index is ignored). Traces can only be queried for graphical result displays (not "Result Summary", "Marker Table" or Peak Marker List).

**Suffix:**

<n> [Window](#)

<w> subwindow  
 <t> irrelevant  
**Example:** DISP:TRAC3:SEL

---

**DISPlay[:WINDow<n>][:SUBWindow<w>]:TRACe<t>[:STATE] <State>**

Turns a trace on and off.

The measurement continues in the background.

**Suffix:**

<n> [Window](#)  
 <w> subwindow  
 Not supported by all applications  
 <t> [Trace](#)

**Parameters:**

<State> ON | OFF | 0 | 1  
**OFF | 0**  
 Switches the function off  
**ON | 1**  
 Switches the function on

**Example:** DISP:TRAC3 ON

**Manual operation:** See ["Trace 1/Trace 2/Trace 3/Trace 4/Trace 5/Trace 6"](#) on page 97  
 See ["Trace 1/ Trace 2/ Trace 3/ Trace 4 \(Softkeys\)"](#) on page 100

---

**[SENSe:]ADEMod:AM:RELative:AFSPectrum[:TYPE] <TraceMode>...**  
**[SENSe:]ADEMod:AM:RELative[:TDOMain][:TYPE] <TraceMode>...**  
**[SENSe:]ADEMod:AM[:ABSolute]:AFSPectrum[:TYPE] <TraceMode>...**  
**[SENSe:]ADEMod:AM[:ABSolute][:TDOMain][:TYPE] <TraceMode>...**  
**[SENSe:]ADEMod:FM:AFSPectrum[:TYPE] <TraceMode>...**  
**[SENSe:]ADEMod:FM[:TDOMain][:TYPE] <TraceMode>...**  
**[SENSe:]ADEMod:PM:AFSPectrum[:TYPE] <TraceMode>...**  
**[SENSe:]ADEMod:PM[:TDOMain][:TYPE] <TraceMode>...**  
**[SENSe:]ADEMod:SPECTrum[:TYPE] <TraceMode>...**

Selects the trace modes of the evaluated signal to be measured simultaneously. For each of the six available traces a mode can be defined.

The trace modes are configured identically for all windows with a specific evaluation. The following table indicates which command syntax refers to which evaluation method.

Command syntax	Evaluation method
AM[:ABSolute][:TDOMain]	RF time domain
AM:RELative[:TDOMain]	AM time domain

Command syntax	Evaluation method
AM:RElative:AFSPepectrum	AM spectrum (relative)
FM[:TDOMain]	FM time domain
FM:AFSPepectrum	FM spectrum
PM[:TDOMain]	PM time domain
PM:AFSPepectrum	PM spectrum
SPeCtrum	RF spectrum

**Note:** The trace modes for each trace and each window can also be configured individually using the `DISP:TRAC:MODE` command, see `DISP:LAY[:WINDow<n>][:SUBWindow<w>]:TRACe<t>:MODE` on page 300.

**Parameters:**

<TraceMode>

WRITE | AVERage | MAXHold | MINHold | VIEW | OFF

**WRITE**

Overwrite mode: the trace is overwritten by each sweep. This is the default setting.

**AVERage**

The average is formed over several sweeps.

The [Sweep/Average Count](#) determines the number of averaging procedures.

**MAXHold**

The maximum value is determined over several sweeps and displayed. The FSW saves the sweep result in the trace memory only if the new value is greater than the previous one.

**MINHold**

The minimum value is determined from several measurements and displayed. The FSW saves the sweep result in the trace memory only if the new value is lower than the previous one.

**VIEW**

The current contents of the trace memory are frozen and displayed.

**OFF**

Hides the selected trace.

\*RST: WRITE,OFF,OFF,OFF,OFF,OFF

**Example:**

ADEM:AM AVER,MAXH,MINH,OFF,OFF,OFF

Determines average, max hold and min hold values simultaneously for the traces 1-3 of the RF time domain evaluation.

ADEM:AM WRIT,OFF,OFF,OFF,OFF,OFF

Determines only the current measurement values for trace 1.

ADEM:AM OFF,OFF,OFF,OFF,OFF,OFF

Switches AM demodulation off.

---

**[SENSe:]AVERAge<n>:COUNT <AverageCount>**

Defines the number of sweeps that the application uses to average traces.

In case of continuous sweep mode, the application calculates the moving average over the average count.

In case of single sweep mode, the application stops the measurement and calculates the average after the average count has been reached.

**Suffix:**

<n>                      irrelevant

**Parameters:**

<AverageCount>      If you set an average count of 0 or 1, the application performs one single sweep in single sweep mode.  
In continuous sweep mode, if the average count is set to 0, a moving average over 10 sweeps is performed.

Range:                0 to 200000

\*RST:                 0

**Manual operation:**    See "[Sweep/Average Count](#)" on page 65  
See "[Average Count](#)" on page 99

---

**[SENSe:]AVERAge<n>[:STATe<t>] <State>**

Turns averaging for a particular trace in a particular window on and off.

**Suffix:**

<n>                      [Window](#)

<t>                      [Trace](#)

**Parameters:**

<State>                ON | OFF | 1 | 0

---

**[SENSe:]AVERAge<n>:TYPE <Mode>**

Selects the trace averaging mode.

**Suffix:**

<n>                      1..n  
[Window](#)

**Parameters:**

<Mode>                **LOGarithmic**  
The logarithmic power values are averaged.

**LINear**

The power values are averaged before they are converted to logarithmic values.



**POWer**

The power level values are converted into unit Watt prior to averaging. After the averaging, the data is converted back into its original unit.

**Example:** `AVER:TYPE LIN`  
Switches to linear average calculation.

**Manual operation:** See "[Average Mode](#)" on page 99

**[SENSe:][WINDow<n>:]DETEctor<t>[:FUNCTion] <Detector>**

Defines the trace detector to be used for trace analysis.

**Suffix:**

<n> [Window](#)

<t> [Trace](#)

**Parameters:**

<Detector> **APEak**  
Autopeak

**NEGative**  
Negative peak

**POSitive**  
Positive peak

**SAMPLE**  
First value detected per trace point

**RMS**  
RMS value

**AVERage**  
Average

\*RST: `APEak`

**Example:** `DET POS`  
Sets the detector to "positive peak".

**Manual operation:** See "[Detector](#)" on page 98

**[SENSe:][WINDow<n>:]DETEctor<t>[:FUNCTion]:AUTO <State>**

Couples and decouples the detector to the trace mode.

**Suffix:**

<n> [Window](#)

<t> [Trace](#)

**Parameters:**

<State> `ON | OFF | 0 | 1`

\*RST: `1`

**Example:** `DET:AUTO OFF`  
The selection of the detector is not coupled to the trace mode.

**Manual operation:** See "[Detector](#)" on page 98

### 11.8.3 Working with markers remotely

In the R&S FSW AM/FM/PM Modulation Analysis application, up to 16 markers or delta markers can be activated for each window simultaneously.

More details are described for manual operation in [Chapter 6.4.4, "Marker function configuration"](#), on page 120.

- [Setting up individual markers](#)..... 306
- [General marker settings](#)..... 313
- [Marker search \(spectrograms\)](#)..... 315
- [Marker search settings](#)..... 323
- [Positioning the marker](#)..... 324
- [Configuring special marker functions](#)..... 329

#### 11.8.3.1 Setting up individual markers

The following commands define the position of markers in the diagram.

<code>CALCulate&lt;n&gt;:MARKer&lt;m&gt;:AOFF</code> .....	306
<code>CALCulate&lt;n&gt;:MARKer&lt;ms&gt;:LINK:TO:MARKer&lt;md&gt;</code> .....	307
<code>CALCulate&lt;n&gt;:MARKer&lt;m&gt;[:STATE]</code> .....	307
<code>CALCulate&lt;n&gt;:MARKer&lt;m&gt;:TRACe</code> .....	308
<code>CALCulate&lt;n&gt;:MARKer&lt;m&gt;:X</code> .....	308
<code>CALCulate&lt;n&gt;:MARKer&lt;m&gt;:Y?</code> .....	308
<code>CALCulate&lt;n&gt;:DELTaMarker&lt;m&gt;:AOFF</code> .....	309
<code>CALCulate&lt;n&gt;:DELTaMarker&lt;m&gt;:LINK</code> .....	309
<code>CALCulate&lt;n&gt;:DELTaMarker&lt;ms&gt;:LINK:TO:MARKer&lt;md&gt;</code> .....	309
<code>CALCulate&lt;n&gt;:DELTaMarker&lt;m&gt;:MODE</code> .....	310
<code>CALCulate&lt;n&gt;:DELTaMarker&lt;m&gt;:MREFerence</code> .....	310
<code>CALCulate&lt;n&gt;:DELTaMarker&lt;m&gt;[:STATE]</code> .....	311
<code>CALCulate&lt;n&gt;:DELTaMarker&lt;m&gt;:TRACe</code> .....	311
<code>CALCulate&lt;n&gt;:DELTaMarker&lt;m&gt;:X</code> .....	311
<code>CALCulate&lt;n&gt;:DELTaMarker&lt;m&gt;:X:RELative?</code> .....	312
<code>CALCulate&lt;n&gt;:DELTaMarker&lt;m&gt;:Y?</code> .....	312

---

#### `CALCulate<n>:MARKer<m>:AOFF`

Turns off all markers.

**Suffix:**

<n> [Window](#)

<m> [Marker](#)

**Example:** `CALC:MARK:AOFF`  
Switches off all markers.

**Manual operation:** See ["All Markers Off"](#) on page 112

---

### CALCulate<n>:MARKer<ms>:LINK:TO:MARKer<md> <State>

Links the normal source marker <ms> to any active destination marker <md> (normal or delta marker).

If you change the horizontal position of marker <md>, marker <ms> changes its horizontal position to the same value.

**Suffix:**

<n>	<a href="#">Window</a>
<ms>	source marker, see <a href="#">Marker</a>
<md>	destination marker, see <a href="#">Marker</a>

**Parameters:**

<State>	ON   OFF   0   1
	<b>OFF   0</b>
	Switches the function off
	<b>ON   1</b>
	Switches the function on

**Example:** `CALC:MARK4:LINK:TO:MARK2 ON`  
Links marker 4 to marker 2.

**Manual operation:** See ["Linking to Another Marker"](#) on page 111

---

### CALCulate<n>:MARKer<m>[:STATe] <State>

Turns markers on and off. If the corresponding marker number is currently active as a delta marker, it is turned into a normal marker.

**Suffix:**

<n>	<a href="#">Window</a>
<m>	<a href="#">Marker</a>

**Parameters:**

<State>	ON   OFF   0   1
	<b>OFF   0</b>
	Switches the function off
	<b>ON   1</b>
	Switches the function on

**Example:** `CALC:MARK3 ON`  
Switches on marker 3.

**Manual operation:** See ["Marker State"](#) on page 110  
See ["Marker Type"](#) on page 111  
See ["Select Marker"](#) on page 116

---

**CALCulate<n>:MARKer<m>:TRACe <Trace>**

Selects the trace the marker is positioned on.

Note that the corresponding trace must have a trace mode other than "Blank".

If necessary, the command activates the marker first.

**Suffix:**

<n> [Window](#)

<m> [Marker](#)

**Parameters:**

<Trace> **1 to 6**  
Trace number the marker is assigned to.

**Example:** //Assign marker to trace 1  
CALC:MARK3:TRAC 2

**Manual operation:** See ["Assigning the Marker to a Trace"](#) on page 112

---

**CALCulate<n>:MARKer<m>:X <Position>**

Moves a marker to a specific coordinate on the x-axis.

If necessary, the command activates the marker.

If the marker has been used as a delta marker, the command turns it into a normal marker.

**Suffix:**

<n> [Window](#)

<m> [Marker](#)

**Parameters:**

<Position> Numeric value that defines the marker position on the x-axis.  
The unit depends on the result display.  
Range: The range depends on the current x-axis range.  
Default unit: Hz

**Example:** CALC:MARK2:X 1.7MHz  
Positions marker 2 to frequency 1.7 MHz.

**Manual operation:** See ["Marker Table"](#) on page 25  
See ["Marker Peak List"](#) on page 25  
See ["Marker Position X-value"](#) on page 111

---

**CALCulate<n>:MARKer<m>:Y?**

Queries the result at the position of the specified marker.

**Suffix:**

<n> 1..n

<m> 1..n

**Return values:**

<Result> Default unit: DBM

**Usage:** Query only

**Manual operation:** See "[Marker Table](#)" on page 25  
See "[Marker Peak List](#)" on page 25

**CALCulate<n>:DELTamarker<m>:AOFF**

Turns off *all* delta markers.

**Suffix:**

<n> [Window](#)

<m> irrelevant

**Example:** CALC:DELT:AOFF  
Turns off all delta markers.

**CALCulate<n>:DELTamarker<m>:LINK <State>**

Links delta marker <m> to marker 1.

If you change the horizontal position (x-value) of marker 1, delta marker <m> changes its horizontal position to the same value.

**Suffix:**

<n> [Window](#)

<m> [Marker](#)

**Parameters:**

<State> ON | OFF | 0 | 1  
**OFF | 0**  
Switches the function off  
**ON | 1**  
Switches the function on

**Example:** CALC:DELT2:LINK ON

**Manual operation:** See "[Linking to Another Marker](#)" on page 111

**CALCulate<n>:DELTamarker<ms>:LINK:TO:MARKer<md> <State>**

Links the delta source marker <ms> to any active destination marker <md> (normal or delta marker).

**Suffix:**

<n> [Window](#)

<ms> source marker, see [Marker](#)

<md> destination marker, see [Marker](#)

**Parameters:**

<State> ON | OFF | 0 | 1  
**OFF | 0**  
 Switches the function off  
**ON | 1**  
 Switches the function on

**Example:** CALC:DELTA4:LINK:TO:MARK2 ON  
 Links the delta marker 4 to the marker 2.

**Manual operation:** See "[Linking to Another Marker](#)" on page 111

**CALCulate<n>:DELTamarker<m>:MODE <Mode>**

Defines whether the position of a delta marker is provided as an absolute value or relative to a reference marker. Note that this setting applies to *all* windows.

Note that when the position of a delta marker is *queried*, the result is always an absolute value (see [CALCulate<n>:DELTamarker<m>:X](#) on page 311)!

**Suffix:**

<n> irrelevant  
 <m> irrelevant

**Parameters:**

<Mode> **ABSolute**  
 Delta marker position in absolute terms.  
**RELative**  
 Delta marker position in relation to a reference marker.  
 \*RST: RELative

**Example:** CALC:DELTA:MODE ABS  
 Absolute delta marker position.

**CALCulate<n>:DELTamarker<m>:MREFerence <Reference>**

Selects a reference marker for a delta marker other than marker 1.

The reference may be another marker or the fixed reference.

**Suffix:**

<n> [Window](#)  
 <m> [Marker](#)

**Parameters:**

<Reference> **1 to 16**  
 Selects markers 1 to 16 as the reference.  
**FIXed**  
 Selects the fixed reference as the reference.

**Example:** `CALC:DELT3:MREF 2`  
Specifies that the values of delta marker 3 are relative to marker 2.

**Manual operation:** See ["Reference Marker"](#) on page 111

### **CALCulate<n>:DELTamarker<m>[:STATe] <State>**

Turns delta markers on and off.

If necessary, the command activates the delta marker first.

No suffix at DELTmarker turns on delta marker 1.

**Suffix:**

<n> [Window](#)

<m> [Marker](#)

**Parameters:**

<State> ON | OFF | 0 | 1

**OFF | 0**

Switches the function off

**ON | 1**

Switches the function on

**Example:** `CALC:DELT2 ON`  
Turns on delta marker 2.

**Manual operation:** See ["Marker State"](#) on page 110  
See ["Marker Type"](#) on page 111  
See ["Select Marker"](#) on page 116

### **CALCulate<n>:DELTamarker<m>:TRACe <Trace>**

Selects the trace a delta marker is positioned on.

Note that the corresponding trace must have a trace mode other than "Blank".

If necessary, the command activates the marker first.

**Suffix:**

<n> [Window](#)

<m> [Marker](#)

**Parameters:**

<Trace> Trace number the marker is assigned to.

**Example:** `CALC:DELT2:TRAC 2`  
Positions delta marker 2 on trace 2.

### **CALCulate<n>:DELTamarker<m>:X <Position>**

Moves a delta marker to a particular coordinate on the x-axis.

If necessary, the command activates the delta marker and positions a reference marker to the peak power.

**Suffix:**

<n> [Window](#)

<m> [Marker](#)

**Parameters:**

<Position> Numeric value that defines the marker position on the x-axis. The position is relative to the reference marker. To select an absolute position you have to change the delta marker mode with [CALCulate<n>:DELTaMarker<m>:MODE](#) on page 310. A query returns the absolute position of the delta marker.  
 Range: The value range and unit depend on the measurement and scale of the x-axis.  
 Default unit: HZ

**Example:**

`CALC:DELT:1:X?`

Outputs the absolute x-value of delta marker 1.

**Manual operation:** See "[Marker Position X-value](#)" on page 111

**CALCulate<n>:DELTaMarker<m>:X:RELative?**

Queries the relative position of a delta marker on the x-axis.

If necessary, the command activates the delta marker first.

**Suffix:**

<n> [Window](#)

<m> [Marker](#)

**Return values:**

<Position> Position of the delta marker in relation to the reference marker.

**Example:**

`CALC:DELT3:X:REL?`

Outputs the frequency of delta marker 3 relative to marker 1 or relative to the reference position.

**Usage:**

Query only

**CALCulate<n>:DELTaMarker<m>:Y?**

Queries the result at the position of the specified delta marker.

**Suffix:**

<n> 1..n

<m> 1..n



**Return values:**

<Result> Result at the position of the delta marker.  
The unit is variable and depends on the one you have currently set.  
Default unit: DBM

**Usage:** Query only

**11.8.3.2 General marker settings**

The following commands control general marker functionality.

See also "[Fixed reference marker settings](#)" on page 329

<a href="#">CALCulate&lt;n&gt;:MARKer&lt;m&gt;:X:SSIZe</a> .....	313
<a href="#">CALCulate&lt;n&gt;:MARKer&lt;m&gt;:LINK</a> .....	313
<a href="#">DISPlay[:WINDow&lt;n&gt;]:MINFo[:STATe]</a> .....	314
<a href="#">DISPlay[:WINDow&lt;n&gt;]:MTABLE</a> .....	314

**CALCulate<n>:MARKer<m>:X:SSIZe <StepSize>**

Selects the marker step size mode for *all* markers in *all* windows.

The step size defines the distance the marker moves when you move it with the rotary knob.

It therefore takes effect in manual operation only.

**Suffix:**

<n> irrelevant  
<m> irrelevant

**Parameters:**

<StepSize> **STANDARD**  
the marker moves from one pixel to the next  
**POINTS**  
the marker moves from one sweep point to the next  
\*RST: POINTs

**Example:** CALC:MARK:X:SSIZ STAN  
Sets the marker step size to one pixel.

**Manual operation:** See "[Marker Stepsize](#)" on page 113

**CALCulate<n>:MARKer<m>:LINK <DisplayType>**

Links the specified marker in all displays of the specified type.

**Suffix:**

<n> irrelevant

<m> [Marker](#)

**Parameters:**

<DisplayType> TIME | SPECTrum | BOTH | NONE

**TIME**

Links the markers in all time domain diagrams

**SPECTrum**

Links the markers in all AF Spectrum displays

**BOTH**

Links the markers both in the time domain diagrams and in the AF Spectrum displays

**NONE**

Markers are not linked.

\*RST: NONE

**Manual operation:** See "[Link Time Marker](#)" on page 114  
See "[Link AF Spectrum Marker](#)" on page 114

**DISPlay[:WINDow<n>]:MINFo[:STATe] <State>**

Turns the marker information in all diagrams on and off.

**Suffix:**

<n> irrelevant

**Parameters:**

<State> **ON | 1**  
Displays the marker information in the diagrams.

**OFF | 0**

Hides the marker information in the diagrams.

\*RST: 1

**Example:** DISP:MINF OFF  
Hides the marker information.

**Manual operation:** See "[Marker Info](#)" on page 113

**DISPlay[:WINDow<n>]:MTABLE <DisplayMode>**

Turns the marker table on and off.

**Suffix:**

<n> irrelevant

**Parameters:**

<DisplayMode> **ON | 1**  
Turns on the marker table.

**OFF | 0**

Turns off the marker table.

**AUTO**

Turns on the marker table if 3 or more markers are active.

\*RST: AUTO

**Example:** DISP:MTAB ON  
Activates the marker table.

**Manual operation:** See "[Marker Table Display](#)" on page 113

### 11.8.3.3 Marker search (spectrograms)

The following commands automatically define the marker and delta marker position in the spectrogram.

#### Using markers

The following commands control spectrogram markers.

#### Useful commands for spectrogram markers described elsewhere

The following commands define the horizontal position of the markers.

- [CALCulate<n>:MARKer<m>:MAXimum:LEFT](#) on page 325
- [CALCulate<n>:MARKer<m>:MAXimum:NEXT](#) on page 325
- [CALCulate<n>:MARKer<m>:MAXimum\[:PEAK\]](#) on page 325
- [CALCulate<n>:MARKer<m>:MAXimum:RIGHT](#) on page 325
- [CALCulate<n>:MARKer<m>:MINimum:LEFT](#) on page 326
- [CALCulate<n>:MARKer<m>:MINimum:NEXT](#) on page 326
- [CALCulate<n>:MARKer<m>:MINimum\[:PEAK\]](#) on page 326
- [CALCulate<n>:MARKer<m>:MINimum:RIGHT](#) on page 326

#### Remote commands exclusive to spectrogram markers

<a href="#">CALCulate&lt;n&gt;:MARKer&lt;m&gt;:SGRam:FRAME</a> .....	316
<a href="#">CALCulate&lt;n&gt;:MARKer&lt;m&gt;:SPEctrogram:FRAME</a> .....	316
<a href="#">CALCulate&lt;n&gt;:MARKer&lt;m&gt;:SGRam:SARea</a> .....	316
<a href="#">CALCulate&lt;n&gt;:MARKer&lt;m&gt;:SPEctrogram:SARea</a> .....	316
<a href="#">CALCulate&lt;n&gt;:MARKer&lt;m&gt;:SGRam:XY:MAXimum[:PEAK]</a> .....	317
<a href="#">CALCulate&lt;n&gt;:MARKer&lt;m&gt;:SPEctrogram:XY:MAXimum[:PEAK]</a> .....	317
<a href="#">CALCulate&lt;n&gt;:MARKer&lt;m&gt;:SGRam:XY:MINimum[:PEAK]</a> .....	317
<a href="#">CALCulate&lt;n&gt;:MARKer&lt;m&gt;:SPEctrogram:XY:MINimum[:PEAK]</a> .....	317
<a href="#">CALCulate&lt;n&gt;:MARKer&lt;m&gt;:SGRam:Y:MAXimum:ABOVE</a> .....	317
<a href="#">CALCulate&lt;n&gt;:MARKer&lt;m&gt;:SPEctrogram:Y:MAXimum:ABOVE</a> .....	317
<a href="#">CALCulate&lt;n&gt;:MARKer&lt;m&gt;:SGRam:Y:MAXimum:BELOW</a> .....	317
<a href="#">CALCulate&lt;n&gt;:MARKer&lt;m&gt;:SPEctrogram:Y:MAXimum:BELOW</a> .....	317
<a href="#">CALCulate&lt;n&gt;:MARKer&lt;m&gt;:SGRam:Y:MAXimum:NEXT</a> .....	317
<a href="#">CALCulate&lt;n&gt;:MARKer&lt;m&gt;:SPEctrogram:Y:MAXimum:NEXT</a> .....	317
<a href="#">CALCulate&lt;n&gt;:MARKer&lt;m&gt;:SGRam:Y:MAXimum[:PEAK]</a> .....	318
<a href="#">CALCulate&lt;n&gt;:MARKer&lt;m&gt;:SPEctrogram:Y:MAXimum[:PEAK]</a> .....	318
<a href="#">CALCulate&lt;n&gt;:MARKer&lt;m&gt;:SGRam:Y:MINimum:ABOVE</a> .....	318
<a href="#">CALCulate&lt;n&gt;:MARKer&lt;m&gt;:SPEctrogram:Y:MINimum:ABOVE</a> .....	318
<a href="#">CALCulate&lt;n&gt;:MARKer&lt;m&gt;:SGRam:Y:MINimum:BELOW</a> .....	318

CALCulate<n>:MARKer<m>:SPECtrogram:Y:MINimum:BELOW.....	318
CALCulate<n>:MARKer<m>:SGRam:Y:MINimum:NEXT.....	319
CALCulate<n>:MARKer<m>:SPECtrogram:Y:MINimum:NEXT.....	319
CALCulate<n>:MARKer<m>:SGRam:Y:MINimum[:PEAK].....	319
CALCulate<n>:MARKer<m>:SPECtrogram:Y:MINimum[:PEAK].....	319

---

**CALCulate<n>:MARKer<m>:SGRam:FRAME <Frame>**

**CALCulate<n>:MARKer<m>:SPECtrogram:FRAME <Frame> | <Time>**

Positions a marker on a particular frame.

**Suffix:**

<n>                      Window

<m>                      Marker

**Parameters:**

<Frame>                      Selects a frame directly by the frame number. Valid if the time stamp is off.

The range depends on the history depth.

Default unit: S

<Time>                      Selects a frame via its time stamp. Valid if the time stamp is on.

The number is the (negative) distance to frame 0 in seconds.

The range depends on the history depth.

**Example:**

`CALC:MARK:SGR:FRAM -20`

Sets the marker on the 20th frame before the present.

`CALC:MARK2:SGR:FRAM -2s`

Sets second marker on the frame 2 seconds ago.

---

**CALCulate<n>:MARKer<m>:SGRam:SARea <SearchArea>**

**CALCulate<n>:MARKer<m>:SPECtrogram:SARea <SearchArea>**

Defines the marker search area for all spectrogram markers in the channel.

**Suffix:**

<n>                      irrelevant

<m>                      irrelevant

**Parameters:**

<SearchArea>                      **VISible**

Performs a search within the visible frames.

Note that the command does not work if the spectrogram is not visible for any reason (e.g. if the display update is off).

**MEMory**

Performs a search within all frames in the memory.

\*RST:                      VISible

**Manual operation:** See "[Marker Search Area](#)" on page 119

---

**CALCulate<n>:MARKer<m>:SGRam:XY:MAXimum[:PEAK]**  
**CALCulate<n>:MARKer<m>:SPECTrogram:XY:MAXimum[:PEAK]**

Moves a marker to the highest level of the spectrogram.

**Suffix:**

<n> [Window](#)

<m> [Marker](#)

---

**CALCulate<n>:MARKer<m>:SGRam:XY:MINimum[:PEAK]**  
**CALCulate<n>:MARKer<m>:SPECTrogram:XY:MINimum[:PEAK]**

Moves a marker to the minimum level of the spectrogram.

**Suffix:**

<n> [Window](#)

<m> [Marker](#)

---

**CALCulate<n>:MARKer<m>:SGRam:Y:MAXimum:ABOVE**  
**CALCulate<n>:MARKer<m>:SPECTrogram:Y:MAXimum:ABOVE**

Moves a marker vertically to the next lower peak level for the current frequency.

The search includes only frames above the current marker position. It does not change the horizontal position of the marker.

**Suffix:**

<n> [Window](#)

<m> [Marker](#)

**Manual operation:** See "[Search Mode for Next Peak in Y-Direction](#)" on page 118

---

**CALCulate<n>:MARKer<m>:SGRam:Y:MAXimum:BELOW**  
**CALCulate<n>:MARKer<m>:SPECTrogram:Y:MAXimum:BELOW**

Moves a marker vertically to the next lower peak level for the current frequency.

The search includes only frames below the current marker position. It does not change the horizontal position of the marker.

**Suffix:**

<n> [Window](#)

<m> [Marker](#)

**Manual operation:** See "[Search Mode for Next Peak in Y-Direction](#)" on page 118

---

**CALCulate<n>:MARKer<m>:SGRam:Y:MAXimum:NEXT**  
**CALCulate<n>:MARKer<m>:SPECTrogram:Y:MAXimum:NEXT**

Moves a marker vertically to the next lower peak level for the current frequency.

The search includes all frames. It does not change the horizontal position of the marker.

**Suffix:**

<n> [Window](#)

<m> [Marker](#)

**Manual operation:** See "[Search Mode for Next Peak in Y-Direction](#)" on page 118

**CALCulate<n>:MARKer<m>:SGRam:Y:MAXimum[:PEAK]**

**CALCulate<n>:MARKer<m>:SPECTrogram:Y:MAXimum[:PEAK]**

Moves a marker vertically to the highest level for the current frequency.

The search includes all frames. It does not change the horizontal position of the marker.

If the marker hasn't been active yet, the command looks for the peak level in the whole spectrogram.

**Suffix:**

<n> [Window](#)

<m> [Marker](#)

**CALCulate<n>:MARKer<m>:SGRam:Y:MINimum:ABOVE**

**CALCulate<n>:MARKer<m>:SPECTrogram:Y:MINimum:ABOVE**

Moves a marker vertically to the next higher minimum level for the current frequency.

The search includes only frames above the current marker position. It does not change the horizontal position of the marker.

**Suffix:**

<n> [Window](#)

<m> [Marker](#)

**Manual operation:** See "[Search Mode for Next Peak in Y-Direction](#)" on page 118

**CALCulate<n>:MARKer<m>:SGRam:Y:MINimum:BELOW**

**CALCulate<n>:MARKer<m>:SPECTrogram:Y:MINimum:BELOW**

Moves a marker vertically to the next higher minimum level for the current frequency.

The search includes only frames below the current marker position. It does not change the horizontal position of the marker.

**Suffix:**

<n> [Window](#)

<m> [Marker](#)

**Manual operation:** See "[Search Mode for Next Peak in Y-Direction](#)" on page 118

**CALCulate<n>:MARKer<m>:SGRam:Y:MINimum:NEXT****CALCulate<n>:MARKer<m>:SPECTrogram:Y:MINimum:NEXT**

Moves a marker vertically to the next higher minimum level for the current frequency.

The search includes all frames. It does not change the horizontal position of the marker.

**Suffix:**

<n> [Window](#)

<m> [Marker](#)

**Manual operation:** See "[Search Mode for Next Peak in Y-Direction](#)" on page 118

**CALCulate<n>:MARKer<m>:SGRam:Y:MINimum[:PEAK]****CALCulate<n>:MARKer<m>:SPECTrogram:Y:MINimum[:PEAK]**

Moves a marker vertically to the minimum level for the current frequency.

The search includes all frames. It does not change the horizontal position of the marker.

If the marker hasn't been active yet, the command first looks for the peak level for all frequencies and moves the marker vertically to the minimum level.

**Suffix:**

<n> [Window](#)

<m> [Marker](#)

**Using delta markers**

The following commands control spectrogram delta markers.

**Useful commands for spectrogram markers described elsewhere**

The following commands define the horizontal position of the delta markers.

- [CALCulate<n>:DELTamarker<m>:MAXimum:LEFT](#) on page 327
- [CALCulate<n>:DELTamarker<m>:MAXimum:NEXT](#) on page 327
- [CALCulate<n>:DELTamarker<m>:MAXimum\[:PEAK\]](#) on page 327
- [CALCulate<n>:DELTamarker<m>:MAXimum:RIGHT](#) on page 327
- [CALCulate<n>:DELTamarker<m>:MINimum:LEFT](#) on page 328
- [CALCulate<n>:DELTamarker<m>:MINimum:NEXT](#) on page 328
- [CALCulate<n>:DELTamarker<m>:MINimum\[:PEAK\]](#) on page 328
- [CALCulate<n>:DELTamarker<m>:MINimum:RIGHT](#) on page 328

**Remote commands exclusive to spectrogram markers**

<a href="#">CALCulate&lt;n&gt;:DELTamarker&lt;m&gt;:SGRam:FRAMe</a> .....	320
<a href="#">CALCulate&lt;n&gt;:DELTamarker&lt;m&gt;:SPECTrogram:FRAMe</a> .....	320
<a href="#">CALCulate&lt;n&gt;:DELTamarker&lt;m&gt;:SGRam:SARea</a> .....	321

CALCulate<n>:DELTamarker<m>:SPECTrogram:SARea.....	321
CALCulate<n>:DELTamarker<m>:SGRam:XY:MAXimum[:PEAK].....	321
CALCulate<n>:DELTamarker<m>:SPECTrogram:XY:MAXimum[:PEAK].....	321
CALCulate<n>:DELTamarker<m>:SGRam:XY:MINimum[:PEAK].....	321
CALCulate<n>:DELTamarker<m>:SPECTrogram:XY:MINimum[:PEAK].....	321
CALCulate<n>:DELTamarker<m>:SGRam:Y:MAXimum:ABOVE.....	321
CALCulate<n>:DELTamarker<m>:SPECTrogram:Y:MAXimum:ABOVE.....	321
CALCulate<n>:DELTamarker<m>:SGRam:Y:MAXimum:BELOW.....	322
CALCulate<n>:DELTamarker<m>:SPECTrogram:Y:MAXimum:BELOW.....	322
CALCulate<n>:DELTamarker<m>:SGRam:Y:MAXimum:NEXT.....	322
CALCulate<n>:DELTamarker<m>:SPECTrogram:Y:MAXimum:NEXT.....	322
CALCulate<n>:DELTamarker<m>:SGRam:Y:MAXimum[:PEAK].....	322
CALCulate<n>:DELTamarker<m>:SPECTrogram:Y:MAXimum[:PEAK].....	322
CALCulate<n>:DELTamarker<m>:SGRam:Y:MINimum:ABOVE.....	322
CALCulate<n>:DELTamarker<m>:SPECTrogram:Y:MINimum:ABOVE.....	322
CALCulate<n>:DELTamarker<m>:SGRam:Y:MINimum:BELOW.....	323
CALCulate<n>:DELTamarker<m>:SPECTrogram:Y:MINimum:BELOW.....	323
CALCulate<n>:DELTamarker<m>:SGRam:Y:MINimum:NEXT.....	323
CALCulate<n>:DELTamarker<m>:SPECTrogram:Y:MINimum:NEXT.....	323
CALCulate<n>:DELTamarker<m>:SGRam:Y:MINimum[:PEAK].....	323
CALCulate<n>:DELTamarker<m>:SPECTrogram:Y:MINimum[:PEAK].....	323

---

**CALCulate<n>:DELTamarker<m>:SGRam:FRAME <Frame>**

**CALCulate<n>:DELTamarker<m>:SPECTrogram:FRAME <Frame>**

Positions a delta marker on a particular frame. The frame is relative to the position of marker 1.

The command is available for the spectrogram.

**Suffix:**

<n>                      Window

<m>                      Marker

**Parameters:**

<Frame>                Selects a frame either by its frame number or time stamp. The frame number is available if the time stamp is off. The range depends on the history depth. The time stamp is available if the time stamp is on. The number is the distance to frame 0 in seconds. The range depends on the history depth. Default unit: S

**Example:**

`CALC:DELT4:SGR:FRAM -20`

Sets fourth deltamarker 20 frames below marker 1.

`CALC:DELT4:SGR:FRAM 2 s`

Sets fourth deltamarker 2 seconds above the position of marker 1.



---

**CALCulate<n>:DELTamarker<m>:SGRam:SARea <SearchArea>**

**CALCulate<n>:DELTamarker<m>:SPECTrogram:SARea <SearchArea>**

Defines the marker search area for *all* spectrogram markers in the channel.

**Suffix:**

<n> irrelevant

<m> irrelevant

**Parameters:**

<SearchArea>

**VISible**

Performs a search within the visible frames.

Note that the command does not work if the spectrogram is not visible for any reason (e.g. if the display update is off).

**MEMory**

Performs a search within all frames in the memory.

\*RST: VISible

**Manual operation:** See "[Marker Search Area](#)" on page 119

---

**CALCulate<n>:DELTamarker<m>:SGRam:XY:MAXimum[:PEAK]**

**CALCulate<n>:DELTamarker<m>:SPECTrogram:XY:MAXimum[:PEAK]**

Moves a marker to the highest level of the spectrogram over all frequencies.

**Suffix:**

<n> [Window](#)

<m> [Marker](#)

---

**CALCulate<n>:DELTamarker<m>:SGRam:XY:MINimum[:PEAK]**

**CALCulate<n>:DELTamarker<m>:SPECTrogram:XY:MINimum[:PEAK]**

Moves a delta marker to the minimum level of the spectrogram over all frequencies.

**Suffix:**

<n> [Window](#)

<m> [Marker](#)

---

**CALCulate<n>:DELTamarker<m>:SGRam:Y:MAXimum:ABOVe**

**CALCulate<n>:DELTamarker<m>:SPECTrogram:Y:MAXimum:ABOVe**

Moves a marker vertically to the next higher level for the current frequency.

The search includes only frames above the current marker position. It does not change the horizontal position of the marker.

**Suffix:**

<n> [Window](#)

<m> [Marker](#)

**Manual operation:** See "[Search Mode for Next Peak in Y-Direction](#)" on page 118

---

**CALCulate<n>:DELTaMarker<m>:SGRam:Y:MAXimum:BELOW**  
**CALCulate<n>:DELTaMarker<m>:SPECTrogram:Y:MAXimum:BELOW**

Moves a marker vertically to the next higher level for the current frequency.

The search includes only frames below the current marker position. It does not change the horizontal position of the marker.

**Suffix:**

<n> [Window](#)

<m> [Marker](#)

**Manual operation:** See "[Search Mode for Next Peak in Y-Direction](#)" on page 118

---

**CALCulate<n>:DELTaMarker<m>:SGRam:Y:MAXimum:NEXT**  
**CALCulate<n>:DELTaMarker<m>:SPECTrogram:Y:MAXimum:NEXT**

Moves a delta marker vertically to the next higher level for the current frequency.

The search includes all frames. It does not change the horizontal position of the marker.

**Suffix:**

<n> [Window](#)

<m> [Marker](#)

**Manual operation:** See "[Search Mode for Next Peak in Y-Direction](#)" on page 118

---

**CALCulate<n>:DELTaMarker<m>:SGRam:Y:MAXimum[:PEAK]**  
**CALCulate<n>:DELTaMarker<m>:SPECTrogram:Y:MAXimum[:PEAK]**

Moves a delta marker vertically to the highest level for the current frequency.

The search includes all frames. It does not change the horizontal position of the marker.

If the marker hasn't been active yet, the command looks for the peak level in the whole spectrogram.

**Suffix:**

<n> [Window](#)

<m> [Marker](#)

---

**CALCulate<n>:DELTaMarker<m>:SGRam:Y:MINimum:ABOVE**  
**CALCulate<n>:DELTaMarker<m>:SPECTrogram:Y:MINimum:ABOVE**

Moves a delta marker vertically to the next minimum level for the current frequency.

The search includes only frames above the current marker position. It does not change the horizontal position of the marker.

**Suffix:**

<n> [Window](#)

<m> [Marker](#)

**Manual operation:** See "[Search Mode for Next Peak in Y-Direction](#)" on page 118

**CALCulate<n>:DELTaMarker<m>:SGRam:Y:MINimum:BELOW**

**CALCulate<n>:DELTaMarker<m>:SPECTrogram:Y:MINimum:BELOW**

Moves a delta marker vertically to the next minimum level for the current frequency.

The search includes only frames below the current marker position. It does not change the horizontal position of the marker.

**Suffix:**

<n> [Window](#)

<m> [Marker](#)

**Manual operation:** See "[Search Mode for Next Peak in Y-Direction](#)" on page 118

**CALCulate<n>:DELTaMarker<m>:SGRam:Y:MINimum:NEXT**

**CALCulate<n>:DELTaMarker<m>:SPECTrogram:Y:MINimum:NEXT**

Moves a delta marker vertically to the next minimum level for the current frequency.

The search includes all frames. It does not change the horizontal position of the marker.

**Suffix:**

<n> [Window](#)

<m> [Marker](#)

**Manual operation:** See "[Search Mode for Next Peak in Y-Direction](#)" on page 118

**CALCulate<n>:DELTaMarker<m>:SGRam:Y:MINimum[:PEAK]**

**CALCulate<n>:DELTaMarker<m>:SPECTrogram:Y:MINimum[:PEAK]**

Moves a delta marker vertically to the minimum level for the current frequency.

The search includes all frames. It does not change the horizontal position of the marker.

If the marker hasn't been active yet, the command first looks for the peak level in the whole spectrogram and moves the marker vertically to the minimum level.

**Suffix:**

<n> [Window](#)

<m> [Marker](#)

#### 11.8.3.4 Marker search settings

The following commands define criteria for searches.

[CALCulate<n>:MARKer<m>:PEXCursion](#)..... 324

**CALCulate<n>:MARKer<m>:PEXCursion <Excursion>**

Defines the peak excursion (for *all* markers in *all* windows).

The peak excursion sets the requirements for a peak to be detected during a peak search.

The unit depends on the measurement.

Application/Result display	Unit
Spectrum	dB
ADEMOD, RF	dB
ADEMOD, AM	PCT
ADEMOD, FM	kHz
ADEMOD, PM	RAD

**Suffix:**

<n> irrelevant

<m> irrelevant

**Parameters:**

<Excursion>

The excursion is the distance to a trace maximum that must be attained before a new maximum is recognized, or the distance to a trace minimum that must be attained before a new minimum is recognized

\*RST: 5 PCT in AM displays, 50 kHz in FM displays, (0.5 RAD in PM displays)

**Example:**

CALC:MARK:PEXC 10dB

Defines peak excursion as 10 dB.

**Manual operation:** See "[Peak Excursion](#)" on page 115

**11.8.3.5 Positioning the marker**

This chapter contains remote commands necessary to position the marker on a trace.

- [Positioning normal markers](#).....324
- [Positioning delta markers](#).....326

**Positioning normal markers**

The following commands position markers on the trace.

<a href="#">CALCulate&lt;n&gt;:MARKer&lt;m&gt;:MAXimum:LEFT</a> .....	325
<a href="#">CALCulate&lt;n&gt;:MARKer&lt;m&gt;:MAXimum:NEXT</a> .....	325
<a href="#">CALCulate&lt;n&gt;:MARKer&lt;m&gt;:MAXimum[:PEAK]</a> .....	325
<a href="#">CALCulate&lt;n&gt;:MARKer&lt;m&gt;:MAXimum:RIGHT</a> .....	325
<a href="#">CALCulate&lt;n&gt;:MARKer&lt;m&gt;:MINimum:LEFT</a> .....	326

CALCulate<n>:MARKer<m>:MINimum:NEXT.....	326
CALCulate<n>:MARKer<m>:MINimum[:PEAK].....	326
CALCulate<n>:MARKer<m>:MINimum:RIGHT.....	326

---

#### CALCulate<n>:MARKer<m>:MAXimum:LEFT

Moves a marker to the next positive peak.

The search includes only measurement values to the left of the current marker position.

##### Suffix:

<n>                      Window

<m>                      Marker

**Manual operation:**    See "Search Next Peak" on page 116

---

#### CALCulate<n>:MARKer<m>:MAXimum:NEXT

Moves a marker to the next positive peak.

##### Suffix:

<n>                      Window

<m>                      Marker

**Manual operation:**    See "Search Next Peak" on page 116

---

#### CALCulate<n>:MARKer<m>:MAXimum[:PEAK]

Moves a marker to the highest level.

If the marker is not yet active, the command first activates the marker.

##### Suffix:

<n>                      Window

<m>                      Marker

**Manual operation:**    See "Peak Search" on page 116

---

#### CALCulate<n>:MARKer<m>:MAXimum:RIGHT

Moves a marker to the next positive peak.

The search includes only measurement values to the right of the current marker position.

##### Suffix:

<n>                      Window

<m>                      Marker

**Manual operation:**    See "Search Next Peak" on page 116

---

**CALCulate<n>:MARKer<m>:MINimum:LEFT**

Moves a marker to the next minimum peak value.

The search includes only measurement values to the right of the current marker position.

**Suffix:**

<n> [Window](#)

<m> [Marker](#)

**Manual operation:** See "[Search Next Minimum](#)" on page 117

---

**CALCulate<n>:MARKer<m>:MINimum:NEXT**

Moves a marker to the next minimum peak value.

**Suffix:**

<n> [Window](#)

<m> [Marker](#)

**Manual operation:** See "[Search Next Minimum](#)" on page 117

---

**CALCulate<n>:MARKer<m>:MINimum[:PEAK]**

Moves a marker to the minimum level.

If the marker is not yet active, the command first activates the marker.

**Suffix:**

<n> [Window](#)

<m> [Marker](#)

**Manual operation:** See "[Search Minimum](#)" on page 117

---

**CALCulate<n>:MARKer<m>:MINimum:RIGHT**

Moves a marker to the next minimum peak value.

The search includes only measurement values to the right of the current marker position.

**Suffix:**

<n> [Window](#)

<m> [Marker](#)

**Manual operation:** See "[Search Next Minimum](#)" on page 117

---

**Positioning delta markers**

The following commands position delta markers on the trace.

CALCulate<n>:DELTamarker<m>:MAXimum:LEFT.....	327
CALCulate<n>:DELTamarker<m>:MAXimum:NEXT.....	327
CALCulate<n>:DELTamarker<m>:MAXimum[:PEAK].....	327
CALCulate<n>:DELTamarker<m>:MAXimum:RIGHT.....	327
CALCulate<n>:DELTamarker<m>:MINimum:LEFT.....	328
CALCulate<n>:DELTamarker<m>:MINimum:NEXT.....	328
CALCulate<n>:DELTamarker<m>:MINimum[:PEAK].....	328
CALCulate<n>:DELTamarker<m>:MINimum:RIGHT.....	328

---

#### **CALCulate<n>:DELTamarker<m>:MAXimum:LEFT**

Moves a delta marker to the next positive peak value.

The search includes only measurement values to the left of the current marker position.

##### **Suffix:**

<n>                      Window

<m>                      Marker

**Manual operation:**    See "[Search Next Peak](#)" on page 116

---

#### **CALCulate<n>:DELTamarker<m>:MAXimum:NEXT**

Moves a marker to the next positive peak value.

##### **Suffix:**

<n>                      1..n  
                            Window

<m>                      1..n  
                            Marker

**Manual operation:**    See "[Search Next Peak](#)" on page 116

---

#### **CALCulate<n>:DELTamarker<m>:MAXimum[:PEAK]**

Moves a delta marker to the highest level.

If the marker is not yet active, the command first activates the marker.

##### **Suffix:**

<n>                      Window

<m>                      Marker

**Manual operation:**    See "[Peak Search](#)" on page 116

---

#### **CALCulate<n>:DELTamarker<m>:MAXimum:RIGHT**

Moves a delta marker to the next positive peak value on the trace.

The search includes only measurement values to the right of the current marker position.

**Suffix:**<n> [Window](#)<m> [Marker](#)**Manual operation:** See "[Search Next Peak](#)" on page 116

---

**CALCulate<n>:DELTamarker<m>:MINimum:LEFT**

Moves a delta marker to the next minimum peak value.

The search includes only measurement values to the right of the current marker position.

**Suffix:**<n> [Window](#)<m> [Marker](#)**Manual operation:** See "[Search Next Minimum](#)" on page 117

---

**CALCulate<n>:DELTamarker<m>:MINimum:NEXT**

Moves a marker to the next minimum peak value.

**Suffix:**<n> [Window](#)<m> [Marker](#)**Manual operation:** See "[Search Next Minimum](#)" on page 117

---

**CALCulate<n>:DELTamarker<m>:MINimum[:PEAK]**

Moves a delta marker to the minimum level.

If the marker is not yet active, the command first activates the marker.

**Suffix:**<n> [Window](#)<m> [Marker](#)**Manual operation:** See "[Search Minimum](#)" on page 117

---

**CALCulate<n>:DELTamarker<m>:MINimum:RIGHT**

Moves a delta marker to the next minimum peak value.

The search includes only measurement values to the right of the current marker position.

**Suffix:**<n> [Window](#)<m> [Marker](#)



**Manual operation:** See ["Search Next Minimum"](#) on page 117

### 11.8.3.6 Configuring special marker functions

The following commands are required to configure the special marker functions that are available in the R&S FSW AM/FM/PM Modulation Analysis application.

- [Fixed reference marker settings](#).....329
- [Marker peak lists](#).....331
- [N db down marker](#).....335
- [Phase noise measurement marker](#).....339
- [Band power marker](#).....340
- [Configuring and retrieving AF phase marker values](#).....344

#### Fixed reference marker settings

The following commands configure a fixed reference marker.

<a href="#">CALCulate&lt;n&gt;:DELTamarker&lt;m&gt;:FUNction:FIXed:RPOint:MAXimum[:PEAK]</a> .....	329
<a href="#">CALCulate&lt;n&gt;:DELTamarker&lt;m&gt;:FUNction:FIXed:RPOint:X</a> .....	329
<a href="#">CALCulate&lt;n&gt;:DELTamarker&lt;m&gt;:FUNction:FIXed:RPOint:Y</a> .....	330
<a href="#">CALCulate&lt;n&gt;:DELTamarker&lt;m&gt;:FUNction:FIXed:RPOint:Y:OFFSet</a> .....	330
<a href="#">CALCulate&lt;n&gt;:DELTamarker&lt;m&gt;:FUNction:FIXed[:STATe]</a> .....	330

---

#### **CALCulate<n>:DELTamarker<m>:FUNction:FIXed:RPOint:MAXimum[:PEAK]**

Moves the fixed reference marker to the peak power.

##### Suffix:

<n> [Window](#)

<m> [Marker](#)

##### Example:

`CALC:DELT:FUNC:FIX:RPO:MAX`

Sets the reference point level for delta markers to the peak of the selected trace.

**Manual operation:** See ["Defining a Fixed Reference"](#) on page 114

---

#### **CALCulate<n>:DELTamarker<m>:FUNction:FIXed:RPOint:X <RefPoint>**

Defines the horizontal position of the fixed delta marker reference point. The coordinates of the reference may be anywhere in the diagram.

##### Suffix:

<n> [Window](#)

<m> [Marker](#)

**Parameters:**

<RefPoint> Numeric value that defines the horizontal position of the reference.  
 For frequency domain measurements, it is a frequency in Hz.  
 For time domain measurements, it is a point in time in s.  
 \*RST: Fixed Reference: OFF  
 Default unit: HZ

**Example:**

CALC:DELT:FUNC:FIX:RPO:X 128 MHz  
 Sets the frequency reference to 128 MHz.

**Manual operation:** See ["Defining a Fixed Reference"](#) on page 114

**CALCulate<n>:DELTaMarker<m>:FUNctioN:FIXed:RPOint:Y <RefPointLevel>**

Defines the vertical position of the fixed delta marker reference point. The coordinates of the reference may be anywhere in the diagram.

**Suffix:**

<n> [Window](#)

<m> [Marker](#)

**Parameters:**

<RefPoint> Numeric value that defines the vertical position of the reference.  
 The unit and value range is variable.  
 \*RST: Fixed Reference: OFF  
 Default unit: DBM

**Example:**

CALC:DELT:FUNC:FIX:RPO:Y -10dBm  
 Sets the reference point level for delta markers to -10 dBm.

**Manual operation:** See ["Defining a Fixed Reference"](#) on page 114

**CALCulate<n>:DELTaMarker<m>:FUNctioN:FIXed:RPOint:Y:OFFSet <Offset>**

Defines a level offset for the fixed delta marker reference point.

**Suffix:**

<n> [Window](#)

<m> [Marker](#)

**Parameters:**

<Offset> Numeric value  
 \*RST: 0  
 Default unit: dB

**CALCulate<n>:DELTaMarker<m>:FUNctioN:FIXed[:STATe] <State>**

Activates or deactivates a marker that defines a fixed reference point for relative marker analysis.

If necessary, the command activates a marker and positions it on the peak power.

Subsequently, you can change the coordinates of the fixed reference independent of the marker. The fixed reference is independent of the trace and is applied to all active delta markers.

**Suffix:**

<n> [Window](#)

<m> [Marker](#)

**Parameters:**

<State> ON | OFF | 0 | 1  
**OFF | 0**  
 Switches the function off  
**ON | 1**  
 Switches the function on

**Example:**

`CALC:DELT:FUNC:FIX ON`

Switches on the measurement with fixed reference value for all delta markers.

`CALC:DELT:FUNC:FIX:RPO:X 128 MHZ`

Sets the frequency reference to 128 MHz.

`CALC:DELT:FUNC:FIX:RPO:Y 30 DBM`

Sets the reference level to +30 dBm.

**Manual operation:** See ["Defining a Fixed Reference"](#) on page 114

## Marker peak lists

### Useful commands for peak lists described elsewhere

- [CALCulate<n>:MARKer<m>:PEXCursion](#) on page 324
- [MMEMy:STORe<n>:PEAK](#) on page 335
- [Chapter 11.8.3.4, "Marker search settings"](#), on page 323

### Remote commands exclusive to peak lists

<a href="#">CALCulate&lt;n&gt;:MARKer&lt;m&gt;:FUNCTION:FPEaks:ANNotation:LABel[:STATe]</a> .....	332
<a href="#">CALCulate&lt;n&gt;:MARKer&lt;m&gt;:FUNCTION:FPEaks:COUNT?</a> .....	332
<a href="#">CALCulate&lt;n&gt;:MARKer&lt;m&gt;:FUNCTION:FPEaks[:IMMmediate]</a> .....	332
<a href="#">CALCulate&lt;n&gt;:MARKer&lt;m&gt;:FUNCTION:FPEaks:LIST:SIZE</a> .....	333
<a href="#">CALCulate&lt;n&gt;:MARKer&lt;m&gt;:FUNCTION:FPEaks:SORT</a> .....	333
<a href="#">CALCulate&lt;n&gt;:MARKer&lt;m&gt;:FUNCTION:FPEaks:STATe</a> .....	334
<a href="#">CALCulate&lt;n&gt;:MARKer&lt;m&gt;:FUNCTION:FPEaks:X?</a> .....	334
<a href="#">CALCulate&lt;n&gt;:MARKer&lt;m&gt;:FUNCTION:FPEaks:Y?</a> .....	334
<a href="#">MMEMy:STORe&lt;n&gt;:LIST</a> .....	335
<a href="#">MMEMy:STORe&lt;n&gt;:PEAK</a> .....	335

---

**CALCulate<n>:MARKer<m>:FUNction:FPEaks:ANNotation:LABel[:STATe]**  
 <State>

Turns labels for peaks found during a peak search on and off.

The labels correspond to the marker number in the marker peak list.

**Suffix:**

<n> [Window](#)

<m> [Marker](#)

**Parameters:**

<State> ON | OFF | 0 | 1

\*RST: 1

**Example:**

CALC:MARK:FUNC:FPE:ANN:LAB:STAT OFF

Removes the peak labels from the diagram

**Manual operation:** See "[Display Marker Numbers](#)" on page 128

---

**CALCulate<n>:MARKer<m>:FUNction:FPEaks:COUNT?**

Queries the number of peaks that have been found during a peak search.

The actual number of peaks that have been found may differ from the number of peaks you have set to be found because of the peak excursion.

**Suffix:**

<n> irrelevant

<m> irrelevant

**Return values:**

<NumberOfPeaks>

**Example:**

CALC:MARK:FUNC:FPE:COUN?

Queries the number of peaks.

**Usage:**

Query only

---

**CALCulate<n>:MARKer<m>:FUNction:FPEaks[:IMMEDIATE] <Peaks>**

Initiates a peak search.

**Suffix:**

<n> [Window](#)

<m> [Marker](#)

**Parameters:**

&lt;Peaks&gt;

This parameter defines the number of peaks to find during the search.

Note that the actual number of peaks found during the search also depends on the peak excursion you have set with [CALCulate<n>:MARKer<m>:PEXCursion](#).

Range: 1 to 200

**Example:**

```
CALC:MARK:PEXC 5
```

Defines a peak excursion of 5 dB, i.e. peaks must be at least 5 dB apart to be detected as a peak.

```
CALC:MARK:FUNC:FPE 10
```

Initiates a search for 10 peaks on the current trace.

**CALCulate<n>:MARKer<m>:FUNCTION:FPEaks:LIST:SIZE <MaxNoPeaks>**

Defines the maximum number of peaks that the FSW looks for during a peak search.

**Suffix:**

<n> [Window](#)

<m> [Marker](#)

**Parameters:**

&lt;MaxNoPeaks&gt;

Maximum number of peaks to be determined.

Range: 1 to 500

\*RST: 50

**Example:**

```
CALC:MARK:FUNC:FPE:LIST:SIZE 10
```

The marker peak list will contain a maximum of 10 peaks.

**Manual operation:** See ["Maximum Number of Peaks"](#) on page 128

**CALCulate<n>:MARKer<m>:FUNCTION:FPEaks:SORT <SortMode>**

Selects the order in which the results of a peak search are returned.

**Suffix:**

<n> [Window](#)

<m> [Marker](#)

**Parameters:**

&lt;SortMode&gt;

**X**

Sorts the peaks according to increasing position on the x-axis.

**Y**

Sorts the peaks according to decreasing position on the y-axis.

\*RST: X

**Example:**

```
CALC:MARK:FUNC:FPE:SORT Y
```

Sets the sort mode to decreasing y values

**Manual operation:** See ["Sort Mode"](#) on page 128

**CALCulate<n>:MARKer<m>:FUNction:FPEaks:STATe <State>**

Turns a peak search on and off.

**Suffix:**

<n> [Window](#)

<m> [Marker](#)

**Parameters:**

<State> ON | OFF | 0 | 1

**OFF | 0**

Switches the function off

**ON | 1**

Switches the function on

**Example:**

CALC:MARK:FUNC:FPE:STAT ON

Activates marker peak search

**Manual operation:** See "[Peak List State](#)" on page 128

**CALCulate<n>:MARKer<m>:FUNction:FPEaks:X?**

Queries the position of the peaks on the x-axis.

The order depends on the sort order that has been set with [CALCulate<n>:MARKer<m>:FUNction:FPEaks:SORT](#).

**Suffix:**

<n> irrelevant

<m> irrelevant

**Return values:**

<PeakPosition> Position of the peaks on the x-axis. The unit depends on the measurement.

**Usage:** Query only

**CALCulate<n>:MARKer<m>:FUNction:FPEaks:Y?**

Queries the position of the peaks on the y-axis.

The order depends on the sort order that has been set with [CALCulate<n>:MARKer<m>:FUNction:FPEaks:SORT](#).

**Suffix:**

<n> irrelevant

<m> irrelevant

**Return values:**

<PeakPosition> Position of the peaks on the y-axis. The unit depends on the measurement.

**Usage:** Query only

---

**MMEMory:STORe<n>:LIST <FileName>**

Exports the SEM and spurious emission list evaluation to a file.

The file format is \*.dat.

**Secure User Mode**

In secure user mode, settings that are stored on the instrument are stored to volatile memory, which is restricted to 256 MB. Thus, a "memory limit reached" error can occur although the hard disk indicates that storage space is still available.

To store data permanently, select an external storage location such as a USB memory device.

For details, see "Protecting Data Using the Secure User Mode" in the "Data Management" section of the FSW base unit user manual.

**Suffix:**

<n> [Window](#)

**Parameters:**

<FileName> String containing the path and name of the target file.

**Example:**

```
MMEM:STOR:LIST 'test'
```

Stores the current list evaluation results in the test.dat file.

---

**MMEMory:STORe<n>:PEAK <FileName>**

Exports the marker peak list to a file.

**Secure User Mode**

In secure user mode, settings that are stored on the instrument are stored to volatile memory, which is restricted to 256 MB. Thus, a "memory limit reached" error can occur although the hard disk indicates that storage space is still available.

To store data permanently, select an external storage location such as a USB memory device.

For details, see "Protecting Data Using the Secure User Mode" in the "Data Management" section of the FSW base unit user manual.

**Suffix:**

<n> [Window](#)

**Parameters:**

<FileName> String containing the path,name and extension of the target file.

**Example:**

```
MMEM:STOR:PEAK 'test.dat'
```

Saves the current marker peak list in the file test.dat.

**Manual operation:** See ["Export Peak List"](#) on page 128

**N db down marker**

The following commands control the n dB down markers.

CALCulate<n>:MARKer<m>:FUNction:NDBDown.....	336
CALCulate<n>:MARKer<m>:FUNction:NDBDown:FREQuency?.....	336
CALCulate<n>:MARKer<m>:FUNction:NDBDown:QFACtor?.....	337
CALCulate<n>:MARKer<m>:FUNction:NDBDown:RESult?.....	337
CALCulate<n>:MARKer<m>:FUNction:NDBDown:STATe.....	338
CALCulate<n>:MARKer<m>:FUNction:NDBDown:TIME?.....	338

---

### CALCulate<n>:MARKer<m>:FUNction:NDBDown <Distance>

Defines the distance of the n dB down markers to the reference marker.

#### Suffix:

<n>                    Window

<m>                    Marker

#### Parameters:

<Distance>            Distance of the temporary markers to the reference marker in dB.  
 For a positive offset, the markers T1 and T2 are placed *below* the active reference point.  
 For a negative offset (for example for notch filter measurements), the markers T1 and T2 are placed *above* the active reference point.

\*RST:            6dB

Default unit: DB

#### Example:

CALC:MARK:FUNC:NDBD 3dB

Sets the distance to the reference marker to 3 dB.

---

### CALCulate<n>:MARKer<m>:FUNction:NDBDown:FREQuency?

Queries the position of the n dB down markers on the x-axis when measuring in the frequency domain.

To get a valid result, you have to perform a complete measurement with synchronization to the end of the measurement before reading out the result. This is only possible for single sweep mode.

See also [INITiate<n>:CONTinuous](#) on page 266.

#### Suffix:

<n>                    irrelevant

<m>                    irrelevant

#### Return values:

<Frequency>            **<frequency 1>**  
 absolute frequency of the n dB marker to the left of the reference marker in Hz

**<frequency 2>**

absolute frequency of the n dB marker to the right of the reference marker in Hz.



**Example:**

```
INIT:CONT OFF
Switches to single sweep mode.
CALC:MARK:FUNC:NDBD ON
Switches on the n dB down function.
INIT;*WAI
Starts a sweep and waits for the end.
CALC:MARK:FUNC:NDBD:FREQ?
This command would return, for example, 100000000,
200000000, meaning that the first marker position is at 100
MHz, the second marker position is at 200 MHz
```

**Usage:** Query only

**Manual operation:** See "[n dB down Value](#)" on page 122

---

#### CALCulate<n>:MARKer<m>:FUNction:NDBDown:QFActor?

Queries the Q factor of n dB down measurements.

**Suffix:**

<n> irrelevant

<m> irrelevant

**Return values:**

<QFactor>

**Usage:** Query only

---

#### CALCulate<n>:MARKer<m>:FUNction:NDBDown:RESult?

Queries the distance of the n dB down markers from each other.

To get a valid result, you have to perform a complete measurement with synchronization to the end of the measurement before reading out the result. This is only possible for single sweep mode.

See also [INITiate<n>:CONTinuous](#) on page 266.

**Suffix:**

<n> irrelevant

<m> irrelevant

**Return values:**

<Distance>

The result depends on the span.

In case of frequency domain measurements, the command returns the bandwidth between the two n dB down markers in Hz.

In case of time domain measurements, the command returns the pulse width between the two n dB down markers in seconds.

**Example:**

```
INIT:CONT OFF
Switches to single sweep mode.
CALC:MARK:FUNC:NDBD ON
Switches on the n dB down function.
INIT;*WAI
Starts a sweep and waits for the end.
CALC:MARK:FUNC:NDBD:RES?
Outputs the measured value.
```

**Usage:** Query only

**Manual operation:** See "[n dB down Marker State](#)" on page 122

### **CALCulate<n>:MARKer<m>:FUNCTION:NDBDown:STATe <State>**

Turns the n dB Down marker function on and off.

**Suffix:**

<n> irrelevant

<m> irrelevant

**Parameters:**

<State> ON | OFF | 0 | 1

**OFF | 0**

Switches the function off

**ON | 1**

Switches the function on

**Example:**

```
CALC:MARK:FUNC:NDBD:STAT ON
Turns the n dB Down marker on.
```

**Manual operation:** See "[n dB down Marker State](#)" on page 122

### **CALCulate<n>:MARKer<m>:FUNCTION:NDBDown:TIME?**

Queries the position of the n dB down markers on the x-axis when measuring in the time domain.

To get a valid result, you have to perform a complete measurement with synchronization to the end of the measurement before reading out the result. This is only possible for single sweep mode.

See also [INITiate<n>:CONTinuous](#) on page 266.

**Suffix:**

<n> irrelevant

<m> irrelevant

**Return values:**

<TimeX1> absolute position in time of the n dB marker to the left of the reference marker in seconds

<TimeX2> absolute position in time of the n dB marker to the right of the reference marker in seconds

**Example:** INIT:CONT OFF  
Switches to single sweep mode  
CALC:MARK:FUNC:NDBD ON  
Switches on the n dB down function.  
INIT;\*WAI  
Starts a sweep and waits for the end.  
CALC:MARK:FUNC:NDBD:TIME?  
Outputs the time values of the temporary markers.

**Usage:** Query only

**Manual operation:** See "n dB down Value" on page 122

### Phase noise measurement marker

The following commands control the phase noise measurement marker function.

CALCulate<n>:MARKer<m>:FUNCtion:PNOise:AOff	339
CALCulate<n>:MARKer<m>:FUNCtion:PNOise[:STATe]	339
CALCulate<n>:MARKer<m>:FUNCtion:PNOise:RESult?	340

---

#### CALCulate<n>:MARKer<m>:FUNCtion:PNOise:AOff

Removes all phase noise markers in the specified window.

**Suffix:**

<n> Window  
<m> irrelevant

**Example:** CALC:MARK:FUNC:PNO:AOff

---

#### CALCulate<n>:MARKer<m>:FUNCtion:PNOise[:STATe] <State>

Turns the phase noise measurement at the marker position on and off.

**Suffix:**

<n> Window  
<m> Marker

**Parameters:**

<State> ON | OFF | 0 | 1  
**OFF | 0**  
Switches the function off  
**ON | 1**  
Switches the function on

**Example:** CALC:MARK2:FUNC:PNO ON  
Switches on the phase-noise measurement for the marker 2.

**Manual operation:** See ["Phase Noise Measurement State"](#) on page 124  
See ["Switching All Phase Noise Measurements Off"](#)  
on page 125

---

### CALCulate<n>:MARKer<m>:FUNcTion:PNOise:RESult?

Queries the result of a phase noise measurement.

If necessary, the command activates the measurement first.

**Suffix:**

<n> [Window](#)

<m> [Marker](#)

**Return values:**

<PhaseNoise> numeric value

The difference between the measured carrier power and the noise power at the position of the specified (normal) marker.

**Example:**

CALC:MARK2:FUNC:PNO:RES?

Outputs the result of phase-noise measurement of the marker 2.

**Usage:**

Query only

**Manual operation:** See ["Phase Noise Measurement State"](#) on page 124

### Band power marker

The following commands control the marker for band power measurements.

#### Using markers

<a href="#">CALCulate&lt;n&gt;:MARKer&lt;m&gt;:FUNcTion:BPOWer:AOff</a> .....	340
<a href="#">CALCulate&lt;n&gt;:MARKer&lt;m&gt;:FUNcTion:BPOWer:MODE</a> .....	340
<a href="#">CALCulate&lt;n&gt;:MARKer&lt;m&gt;:FUNcTion:BPOWer:RESult?</a> .....	341
<a href="#">CALCulate&lt;n&gt;:MARKer&lt;m&gt;:FUNcTion:BPOWer:SPAN</a> .....	341
<a href="#">CALCulate&lt;n&gt;:MARKer&lt;m&gt;:FUNcTion:BPOWer[:STATe]</a> .....	342

---

### CALCulate<n>:MARKer<m>:FUNcTion:BPOWer:AOff

Removes all band power markers in the specified window.

**Suffix:**

<n> [Window](#)

<m> irrelevant

**Example:**

CALC:MARK:FUNC:BPOW:AOff

---

### CALCulate<n>:MARKer<m>:FUNcTion:BPOWer:MODE <Mode>

Selects the way the results for a band power marker are displayed.

(Note: relative power results are only available for delta markers, see `.CALCulate<n>:DELTAmarker<m>:FUNCTION:BPOWer:MODE` on page 342)

**Suffix:**

<n> [Window](#)

<m> [Marker](#)

**Parameters:**

<Mode>

**POWER**

Result is displayed as an absolute power. The power unit depends on the `CALCulate<n>:UNIT:POWER` setting.

**DENSITY**

Result is displayed as a density in dBm/Hz.

\*RST: POWER

**Example:**

```
CALC:MARK4:FUNC:BPOW:MODE DENS
```

Configures marker 4 to show the measurement results in dBm/Hz.

**Manual operation:** See "[Power Mode](#)" on page 131

**CALCulate<n>:MARKer<m>:FUNCTION:BPOWer:RESult?**

Queries the results of the band power measurement.

**Suffix:**

<n> [Window](#)

<m> [Marker](#)

**Return values:**

<Power> Signal power over the marker bandwidth.

**Example:**

Activate the band power marker:

```
CALC:MARK:FUNC:BPOW:STAT ON
```

Select the density mode for the result:

```
CALC:MARK:FUNC:BPOW:MODE DENS
```

Query the result:

```
CALC:MARK:FUNC:BPOW:RES?
```

Response:

```
20dBm/Hz
```

**Usage:** Query only

**CALCulate<n>:MARKer<m>:FUNCTION:BPOWer:SPAN <Span>**

Defines the bandwidth around the marker position.

**Suffix:**

<n> [Window](#)

<m> [Marker](#)

**Parameters:**

<Span> Frequency. The maximum span depends on the marker position and FSW model.

\*RST: 5% of current span

Default unit: Hz

**Example:**

CALC:MARK:FUNC:BPOW:SPAN 2MHz

Measures the band power over 2 MHz around the marker.

**Manual operation:** See ["Span"](#) on page 131

**CALCulate<n>:MARKer<m>:FUNCTION:BPOWER[:STATe] <State>**

Turns markers for band power measurements on and off.

**Suffix:**

<n> [Window](#)

<m> [Marker](#)

**Parameters:**

<State> ON | OFF | 0 | 1

**OFF | 0**

Switches the function off

**ON | 1**

Switches the function on

**Example:**

CALC:MARK4:FUNC:BPOW:STAT ON

Activates or turns marker 4 into a band power marker.

**Manual operation:** See ["Band Power Measurement State"](#) on page 131  
See ["Switching All Band Power Measurements Off"](#) on page 132

**Using delta markers**

<a href="#">CALCulate&lt;n&gt;:DELTamarker&lt;m&gt;:FUNCTION:BPOWER:MODE</a> .....	342
<a href="#">CALCulate&lt;n&gt;:DELTamarker&lt;m&gt;:FUNCTION:BPOWER:RESult?</a> .....	343
<a href="#">CALCulate&lt;n&gt;:DELTamarker&lt;m&gt;:FUNCTION:BPOWER:SPAN</a> .....	343
<a href="#">CALCulate&lt;n&gt;:DELTamarker&lt;m&gt;:FUNCTION:BPOWER[:STATe]</a> .....	343

**CALCulate<n>:DELTamarker<m>:FUNCTION:BPOWER:MODE <Mode>**

Selects the way the results for a band power delta marker are displayed.

**Suffix:**

<n> [Window](#)

<m> [Marker](#)

**Parameters:**

<Mode> **POWER**

Result is displayed as an absolute power. The power unit depends on the [CALCulate<n>:UNIT:POWER](#) setting.

**DENSity**

Result is displayed as a density in dBm/Hz.

**RPOWer**

This setting is only available for a delta band power marker. The result is the difference between the absolute power in the band around the delta marker and the absolute power for the reference marker. The powers are subtracted logarithmically, so the result is a dB value.

*[Relative band power (Delta2) in dB] = [absolute band power (Delta2) in dBm] - [absolute (band) power of reference marker in dBm]*

For details see "[Relative band power markers](#)" on page 129.

\*RST:       POWer

**Manual operation:** See "[Power Mode](#)" on page 131

**CALCulate<n>:DELTamarker<m>:FUNCTion:BPOWer:RESult?**

Queries the results of the band power measurement.

**Suffix:**

<n>               [Window](#)

<m>               [Marker](#)

**Return values:**

<Power>               Signal power over the delta marker bandwidth.

**Usage:**               Query only

**CALCulate<n>:DELTamarker<m>:FUNCTion:BPOWer:SPAN <Span>**

Defines the bandwidth around the delta marker position.

**Suffix:**

<n>               [Window](#)

<m>               [Marker](#)

**Parameters:**

<Span>               Frequency. The maximum span depends on the marker position and FSW model.

\*RST:           5% of current span

Default unit: Hz

**Manual operation:** See "[Span](#)" on page 131

**CALCulate<n>:DELTamarker<m>:FUNCTion:BPOWer[:STATe] <State>**

Turns delta markers for band power measurements on and off.

If necessary, the command also turns on a reference marker.

**Suffix:**<n> [Window](#)<m> [Marker](#)**Parameters:**

&lt;State&gt; ON | OFF | 0 | 1

**OFF | 0**

Switches the function off

**ON | 1**

Switches the function on

**Manual operation:** See ["Band Power Measurement State"](#) on page 131  
 See ["Switching All Band Power Measurements Off"](#) on page 132

**Configuring and retrieving AF phase marker values**

<a href="#">CALCulate&lt;n&gt;:DELTaMarker&lt;m&gt;:FUNction:AFPHase:RESult?</a> .....	344
<a href="#">CALCulate&lt;n&gt;:DELTaMarker&lt;m&gt;:FUNction:AFPHase[:STATe]</a> .....	344
<a href="#">CALCulate&lt;n&gt;:MARKer&lt;m&gt;:FUNction:AFPHase:RESult?</a> .....	345
<a href="#">CALCulate&lt;n&gt;:MARKer&lt;m&gt;:FUNction:AFPHase[:STATe]</a> .....	345

**CALCulate<n>:DELTaMarker<m>:FUNction:AFPHase:RESult?**

Returns the phase value at the selected marker position. If necessary, the function is activated for the selected window first.

**Suffix:**<n> 1..n  
[Window](#)<m> 1..n  
[Marker](#)**Return values:**

&lt;AfPhase&gt;

**Example:**

CALC3:DELT2:FUNC:AFPH:RES?

Enables the phase marker for deltamarker 2 in window 3 and returns the phase value for that marker.

**Usage:** Query only**CALCulate<n>:DELTaMarker<m>:FUNction:AFPHase[:STATe] <State>**

Is only available for AF spectrum result displays. If enabled, the phase value at each marker position is included in the marker table. The function is always enabled for all active markers in the selected display, it cannot be disabled for individual markers.

**Suffix:**<n> 1..n  
[Window](#)



<m> 1..n  
irrelevant

**Parameters:**

<State> ON | OFF | 0 | 1  
**OFF | 0**  
Switches the function off  
**ON | 1**  
Switches the function on  
\*RST: 0

**Example:** CALC:DELT:FUNC:AFPH:STAT ON

**CALCulate<n>:MARKer<m>:FUNctio:n:AFPHase:RESult?**

Returns the phase value at the selected marker position. If necessary, the function is activated for the selected window first.

**Suffix:**

<n> 1..n  
Window  
<m> 1..n  
Marker

**Return values:**

<AfPhase>

**Example:** CALC3:MARK2:FUNC:AFPH:RES?  
Enables the phase marker for marker 2 in window 3 and returns the phase value for that marker.

**Usage:** Query only

**CALCulate<n>:MARKer<m>:FUNctio:n:AFPHase[:STATe] <State>**

Is only available for AF spectrum result displays. If enabled, the phase value at each marker position is included in the marker table. The function is always enabled for all active markers in the selected display, it cannot be disabled for individual markers.

**Suffix:**

<n> 1..n  
Window  
<m> 1..n  
irrelevant

**Parameters:**

<State> ON | OFF | 0 | 1  
**OFF | 0**  
Switches the function off  
**ON | 1**  
Switches the function on

\*RST: 0

**Example:** CALC3:MARK:FUNC:AFPH:STAT ON

## 11.8.4 Marker search (spectrograms)

The following commands automatically define the marker and delta marker position in the spectrogram.

### 11.8.4.1 Using markers

The following commands control spectrogram markers.

#### Useful commands for spectrogram markers described elsewhere

The following commands define the horizontal position of the markers.

- [CALCulate<n>:MARKer<m>:MAXimum:LEFT](#) on page 325
- [CALCulate<n>:MARKer<m>:MAXimum:NEXT](#) on page 325
- [CALCulate<n>:MARKer<m>:MAXimum\[:PEAK\]](#) on page 325
- [CALCulate<n>:MARKer<m>:MAXimum:RIGHT](#) on page 325
- [CALCulate<n>:MARKer<m>:MINimum:LEFT](#) on page 326
- [CALCulate<n>:MARKer<m>:MINimum:NEXT](#) on page 326
- [CALCulate<n>:MARKer<m>:MINimum\[:PEAK\]](#) on page 326
- [CALCulate<n>:MARKer<m>:MINimum:RIGHT](#) on page 326

#### Remote commands exclusive to spectrogram markers

<a href="#">CALCulate&lt;n&gt;:MARKer&lt;m&gt;:SGRam:FRAME</a> .....	347
<a href="#">CALCulate&lt;n&gt;:MARKer&lt;m&gt;:SPEctrogram:FRAME</a> .....	347
<a href="#">CALCulate&lt;n&gt;:MARKer&lt;m&gt;:SGRam:SARea</a> .....	347
<a href="#">CALCulate&lt;n&gt;:MARKer&lt;m&gt;:SPEctrogram:SARea</a> .....	347
<a href="#">CALCulate&lt;n&gt;:MARKer&lt;m&gt;:SGRam:XY:MAXimum[:PEAK]</a> .....	348
<a href="#">CALCulate&lt;n&gt;:MARKer&lt;m&gt;:SPEctrogram:XY:MAXimum[:PEAK]</a> .....	348
<a href="#">CALCulate&lt;n&gt;:MARKer&lt;m&gt;:SGRam:XY:MINimum[:PEAK]</a> .....	348
<a href="#">CALCulate&lt;n&gt;:MARKer&lt;m&gt;:SPEctrogram:XY:MINimum[:PEAK]</a> .....	348
<a href="#">CALCulate&lt;n&gt;:MARKer&lt;m&gt;:SGRam:Y:MAXimum:ABOVE</a> .....	348
<a href="#">CALCulate&lt;n&gt;:MARKer&lt;m&gt;:SPEctrogram:Y:MAXimum:ABOVE</a> .....	348
<a href="#">CALCulate&lt;n&gt;:MARKer&lt;m&gt;:SGRam:Y:MAXimum:BELOW</a> .....	348
<a href="#">CALCulate&lt;n&gt;:MARKer&lt;m&gt;:SPEctrogram:Y:MAXimum:BELOW</a> .....	348
<a href="#">CALCulate&lt;n&gt;:MARKer&lt;m&gt;:SGRam:Y:MAXimum:NEXT</a> .....	348
<a href="#">CALCulate&lt;n&gt;:MARKer&lt;m&gt;:SPEctrogram:Y:MAXimum:NEXT</a> .....	348
<a href="#">CALCulate&lt;n&gt;:MARKer&lt;m&gt;:SGRam:Y:MAXimum[:PEAK]</a> .....	349
<a href="#">CALCulate&lt;n&gt;:MARKer&lt;m&gt;:SPEctrogram:Y:MAXimum[:PEAK]</a> .....	349
<a href="#">CALCulate&lt;n&gt;:MARKer&lt;m&gt;:SGRam:Y:MINimum:ABOVE</a> .....	349
<a href="#">CALCulate&lt;n&gt;:MARKer&lt;m&gt;:SPEctrogram:Y:MINimum:ABOVE</a> .....	349
<a href="#">CALCulate&lt;n&gt;:MARKer&lt;m&gt;:SGRam:Y:MINimum:BELOW</a> .....	349
<a href="#">CALCulate&lt;n&gt;:MARKer&lt;m&gt;:SPEctrogram:Y:MINimum:BELOW</a> .....	349

CALCulate<n>:MARKer<m>:SGRam:Y:MINimum:NEXT.....	350
CALCulate<n>:MARKer<m>:SPECTrogram:Y:MINimum:NEXT.....	350
CALCulate<n>:MARKer<m>:SGRam:Y:MINimum[:PEAK].....	350
CALCulate<n>:MARKer<m>:SPECTrogram:Y:MINimum[:PEAK].....	350

---

**CALCulate<n>:MARKer<m>:SGRam:FRAME <Frame>**

**CALCulate<n>:MARKer<m>:SPECTrogram:FRAME <Frame> | <Time>**

Positions a marker on a particular frame.

**Suffix:**

<n>                      [Window](#)

<m>                      [Marker](#)

**Parameters:**

<Frame>                Selects a frame directly by the frame number. Valid if the time stamp is off.

The range depends on the history depth.

Default unit: S

<Time>                Selects a frame via its time stamp. Valid if the time stamp is on. The number is the (negative) distance to frame 0 in seconds. The range depends on the history depth.

**Example:**

`CALC:MARK:SGR:FRAM -20`

Sets the marker on the 20th frame before the present.

`CALC:MARK2:SGR:FRAM -2s`

Sets second marker on the frame 2 seconds ago.

---

**CALCulate<n>:MARKer<m>:SGRam:SARea <SearchArea>**

**CALCulate<n>:MARKer<m>:SPECTrogram:SARea <SearchArea>**

Defines the marker search area for all spectrogram markers in the channel.

**Suffix:**

<n>                      irrelevant

<m>                      irrelevant

**Parameters:**

<SearchArea>        **VISible**

Performs a search within the visible frames.

Note that the command does not work if the spectrogram is not visible for any reason (e.g. if the display update is off).

**MEMory**

Performs a search within all frames in the memory.

\*RST:                VISible

**Manual operation:** See "[Marker Search Area](#)" on page 119

---

**CALCulate<n>:MARKer<m>:SGRam:XY:MAXimum[:PEAK]**  
**CALCulate<n>:MARKer<m>:SPECTrogram:XY:MAXimum[:PEAK]**

Moves a marker to the highest level of the spectrogram.

**Suffix:**

<n> [Window](#)

<m> [Marker](#)

---

**CALCulate<n>:MARKer<m>:SGRam:XY:MINimum[:PEAK]**  
**CALCulate<n>:MARKer<m>:SPECTrogram:XY:MINimum[:PEAK]**

Moves a marker to the minimum level of the spectrogram.

**Suffix:**

<n> [Window](#)

<m> [Marker](#)

---

**CALCulate<n>:MARKer<m>:SGRam:Y:MAXimum:ABOVE**  
**CALCulate<n>:MARKer<m>:SPECTrogram:Y:MAXimum:ABOVE**

Moves a marker vertically to the next lower peak level for the current frequency.

The search includes only frames above the current marker position. It does not change the horizontal position of the marker.

**Suffix:**

<n> [Window](#)

<m> [Marker](#)

**Manual operation:** See "[Search Mode for Next Peak in Y-Direction](#)" on page 118

---

**CALCulate<n>:MARKer<m>:SGRam:Y:MAXimum:BELOW**  
**CALCulate<n>:MARKer<m>:SPECTrogram:Y:MAXimum:BELOW**

Moves a marker vertically to the next lower peak level for the current frequency.

The search includes only frames below the current marker position. It does not change the horizontal position of the marker.

**Suffix:**

<n> [Window](#)

<m> [Marker](#)

**Manual operation:** See "[Search Mode for Next Peak in Y-Direction](#)" on page 118

---

**CALCulate<n>:MARKer<m>:SGRam:Y:MAXimum:NEXT**  
**CALCulate<n>:MARKer<m>:SPECTrogram:Y:MAXimum:NEXT**

Moves a marker vertically to the next lower peak level for the current frequency.

The search includes all frames. It does not change the horizontal position of the marker.

**Suffix:**

<n> [Window](#)

<m> [Marker](#)

**Manual operation:** See "[Search Mode for Next Peak in Y-Direction](#)" on page 118

**CALCulate<n>:MARKer<m>:SGRam:Y:MAXimum[:PEAK]**

**CALCulate<n>:MARKer<m>:SPECTrogram:Y:MAXimum[:PEAK]**

Moves a marker vertically to the highest level for the current frequency.

The search includes all frames. It does not change the horizontal position of the marker.

If the marker hasn't been active yet, the command looks for the peak level in the whole spectrogram.

**Suffix:**

<n> [Window](#)

<m> [Marker](#)

**CALCulate<n>:MARKer<m>:SGRam:Y:MINimum:ABOVE**

**CALCulate<n>:MARKer<m>:SPECTrogram:Y:MINimum:ABOVE**

Moves a marker vertically to the next higher minimum level for the current frequency.

The search includes only frames above the current marker position. It does not change the horizontal position of the marker.

**Suffix:**

<n> [Window](#)

<m> [Marker](#)

**Manual operation:** See "[Search Mode for Next Peak in Y-Direction](#)" on page 118

**CALCulate<n>:MARKer<m>:SGRam:Y:MINimum:BELOW**

**CALCulate<n>:MARKer<m>:SPECTrogram:Y:MINimum:BELOW**

Moves a marker vertically to the next higher minimum level for the current frequency.

The search includes only frames below the current marker position. It does not change the horizontal position of the marker.

**Suffix:**

<n> [Window](#)

<m> [Marker](#)

**Manual operation:** See "[Search Mode for Next Peak in Y-Direction](#)" on page 118

---

**CALCulate<n>:MARKer<m>:SGRam:Y:MINimum:NEXT**

**CALCulate<n>:MARKer<m>:SPECTrogram:Y:MINimum:NEXT**

Moves a marker vertically to the next higher minimum level for the current frequency.

The search includes all frames. It does not change the horizontal position of the marker.

**Suffix:**

<n> [Window](#)

<m> [Marker](#)

**Manual operation:** See "[Search Mode for Next Peak in Y-Direction](#)" on page 118

---

**CALCulate<n>:MARKer<m>:SGRam:Y:MINimum[:PEAK]**

**CALCulate<n>:MARKer<m>:SPECTrogram:Y:MINimum[:PEAK]**

Moves a marker vertically to the minimum level for the current frequency.

The search includes all frames. It does not change the horizontal position of the marker.

If the marker hasn't been active yet, the command first looks for the peak level for all frequencies and moves the marker vertically to the minimum level.

**Suffix:**

<n> [Window](#)

<m> [Marker](#)

#### 11.8.4.2 Using delta markers

The following commands control spectrogram delta markers.

##### Useful commands for spectrogram markers described elsewhere

The following commands define the horizontal position of the delta markers.

- [CALCulate<n>:DELTamarker<m>:MAXimum:LEFT](#) on page 327
- [CALCulate<n>:DELTamarker<m>:MAXimum:NEXT](#) on page 327
- [CALCulate<n>:DELTamarker<m>:MAXimum\[:PEAK\]](#) on page 327
- [CALCulate<n>:DELTamarker<m>:MAXimum:RIGHT](#) on page 327
- [CALCulate<n>:DELTamarker<m>:MINimum:LEFT](#) on page 328
- [CALCulate<n>:DELTamarker<m>:MINimum:NEXT](#) on page 328
- [CALCulate<n>:DELTamarker<m>:MINimum\[:PEAK\]](#) on page 328
- [CALCulate<n>:DELTamarker<m>:MINimum:RIGHT](#) on page 328

##### Remote commands exclusive to spectrogram markers

[CALCulate<n>:DELTamarker<m>:SGRam:FRAME](#).....351

[CALCulate<n>:DELTamarker<m>:SPECTrogram:FRAME](#)..... 351

CALCulate<n>:DELTamarker<m>:SGRam:SARea.....	352
CALCulate<n>:DELTamarker<m>:SPECTrogram:SARea.....	352
CALCulate<n>:DELTamarker<m>:SGRam:XY:MAXimum[:PEAK].....	352
CALCulate<n>:DELTamarker<m>:SPECTrogram:XY:MAXimum[:PEAK].....	352
CALCulate<n>:DELTamarker<m>:SGRam:XY:MINimum[:PEAK].....	352
CALCulate<n>:DELTamarker<m>:SPECTrogram:XY:MINimum[:PEAK].....	352
CALCulate<n>:DELTamarker<m>:SGRam:Y:MAXimum:ABOVe.....	352
CALCulate<n>:DELTamarker<m>:SPECTrogram:Y:MAXimum:ABOVe.....	352
CALCulate<n>:DELTamarker<m>:SGRam:Y:MAXimum:BELow.....	353
CALCulate<n>:DELTamarker<m>:SPECTrogram:Y:MAXimum:BELow.....	353
CALCulate<n>:DELTamarker<m>:SGRam:Y:MAXimum:NEXt.....	353
CALCulate<n>:DELTamarker<m>:SPECTrogram:Y:MAXimum:NEXt.....	353
CALCulate<n>:DELTamarker<m>:SGRam:Y:MAXimum[:PEAK].....	353
CALCulate<n>:DELTamarker<m>:SPECTrogram:Y:MAXimum[:PEAK].....	353
CALCulate<n>:DELTamarker<m>:SGRam:Y:MINimum:ABOVe.....	353
CALCulate<n>:DELTamarker<m>:SPECTrogram:Y:MINimum:ABOVe.....	353
CALCulate<n>:DELTamarker<m>:SGRam:Y:MINimum:BELow.....	354
CALCulate<n>:DELTamarker<m>:SPECTrogram:Y:MINimum:BELow.....	354
CALCulate<n>:DELTamarker<m>:SGRam:Y:MINimum:NEXt.....	354
CALCulate<n>:DELTamarker<m>:SPECTrogram:Y:MINimum:NEXt.....	354
CALCulate<n>:DELTamarker<m>:SGRam:Y:MINimum[:PEAK].....	354
CALCulate<n>:DELTamarker<m>:SPECTrogram:Y:MINimum[:PEAK].....	354

**CALCulate<n>:DELTamarker<m>:SGRam:FRAME <Frame>****CALCulate<n>:DELTamarker<m>:SPECTrogram:FRAME <Frame>**

Positions a delta marker on a particular frame. The frame is relative to the position of marker 1.

The command is available for the spectrogram.

**Suffix:**

<n>                      Window

<m>                      Marker

**Parameters:**

<Frame>                      Selects a frame either by its frame number or time stamp. The frame number is available if the time stamp is off. The range depends on the history depth. The time stamp is available if the time stamp is on. The number is the distance to frame 0 in seconds. The range depends on the history depth. Default unit: S

**Example:**

```
CALC:DELT4:SGR:FRAM -20
```

Sets fourth deltamarker 20 frames below marker 1.

```
CALC:DELT4:SGR:FRAM 2 s
```

Sets fourth deltamarker 2 seconds above the position of marker 1.

---

**CALCulate<n>:DELTamarker<m>:SGRam:SARea <SearchArea>**

**CALCulate<n>:DELTamarker<m>:SPECTrogram:SARea <SearchArea>**

Defines the marker search area for *all* spectrogram markers in the channel.

**Suffix:**

<n> irrelevant

<m> irrelevant

**Parameters:**

<SearchArea>

**VISible**

Performs a search within the visible frames.

Note that the command does not work if the spectrogram is not visible for any reason (e.g. if the display update is off).

**MEMory**

Performs a search within all frames in the memory.

\*RST: VISible

**Manual operation:** See "[Marker Search Area](#)" on page 119

---

**CALCulate<n>:DELTamarker<m>:SGRam:XY:MAXimum[:PEAK]**

**CALCulate<n>:DELTamarker<m>:SPECTrogram:XY:MAXimum[:PEAK]**

Moves a marker to the highest level of the spectrogram over all frequencies.

**Suffix:**

<n> [Window](#)

<m> [Marker](#)

---

**CALCulate<n>:DELTamarker<m>:SGRam:XY:MINimum[:PEAK]**

**CALCulate<n>:DELTamarker<m>:SPECTrogram:XY:MINimum[:PEAK]**

Moves a delta marker to the minimum level of the spectrogram over all frequencies.

**Suffix:**

<n> [Window](#)

<m> [Marker](#)

---

**CALCulate<n>:DELTamarker<m>:SGRam:Y:MAXimum:ABOVE**

**CALCulate<n>:DELTamarker<m>:SPECTrogram:Y:MAXimum:ABOVE**

Moves a marker vertically to the next higher level for the current frequency.

The search includes only frames above the current marker position. It does not change the horizontal position of the marker.

**Suffix:**

<n> [Window](#)

<m> [Marker](#)

**Manual operation:** See "[Search Mode for Next Peak in Y-Direction](#)" on page 118



---

**CALCulate<n>:DELTaMarker<m>:SGRam:Y:MAXimum:BELOW**  
**CALCulate<n>:DELTaMarker<m>:SPECTrogram:Y:MAXimum:BELOW**

Moves a marker vertically to the next higher level for the current frequency.

The search includes only frames below the current marker position. It does not change the horizontal position of the marker.

**Suffix:**

<n> [Window](#)

<m> [Marker](#)

**Manual operation:** See "[Search Mode for Next Peak in Y-Direction](#)" on page 118

---

**CALCulate<n>:DELTaMarker<m>:SGRam:Y:MAXimum:NEXT**  
**CALCulate<n>:DELTaMarker<m>:SPECTrogram:Y:MAXimum:NEXT**

Moves a delta marker vertically to the next higher level for the current frequency.

The search includes all frames. It does not change the horizontal position of the marker.

**Suffix:**

<n> [Window](#)

<m> [Marker](#)

**Manual operation:** See "[Search Mode for Next Peak in Y-Direction](#)" on page 118

---

**CALCulate<n>:DELTaMarker<m>:SGRam:Y:MAXimum[:PEAK]**  
**CALCulate<n>:DELTaMarker<m>:SPECTrogram:Y:MAXimum[:PEAK]**

Moves a delta marker vertically to the highest level for the current frequency.

The search includes all frames. It does not change the horizontal position of the marker.

If the marker hasn't been active yet, the command looks for the peak level in the whole spectrogram.

**Suffix:**

<n> [Window](#)

<m> [Marker](#)

---

**CALCulate<n>:DELTaMarker<m>:SGRam:Y:MINimum:ABOVE**  
**CALCulate<n>:DELTaMarker<m>:SPECTrogram:Y:MINimum:ABOVE**

Moves a delta marker vertically to the next minimum level for the current frequency.

The search includes only frames above the current marker position. It does not change the horizontal position of the marker.

**Suffix:**

<n> [Window](#)

<m> [Marker](#)

**Manual operation:** See "[Search Mode for Next Peak in Y-Direction](#)" on page 118

**CALCulate<n>:DELTamarker<m>:SGRam:Y:MINimum:BELOW**

**CALCulate<n>:DELTamarker<m>:SPECTrogram:Y:MINimum:BELOW**

Moves a delta marker vertically to the next minimum level for the current frequency.

The search includes only frames below the current marker position. It does not change the horizontal position of the marker.

**Suffix:**

<n> [Window](#)

<m> [Marker](#)

**Manual operation:** See "[Search Mode for Next Peak in Y-Direction](#)" on page 118

**CALCulate<n>:DELTamarker<m>:SGRam:Y:MINimum:NEXT**

**CALCulate<n>:DELTamarker<m>:SPECTrogram:Y:MINimum:NEXT**

Moves a delta marker vertically to the next minimum level for the current frequency.

The search includes all frames. It does not change the horizontal position of the marker.

**Suffix:**

<n> [Window](#)

<m> [Marker](#)

**Manual operation:** See "[Search Mode for Next Peak in Y-Direction](#)" on page 118

**CALCulate<n>:DELTamarker<m>:SGRam:Y:MINimum[:PEAK]**

**CALCulate<n>:DELTamarker<m>:SPECTrogram:Y:MINimum[:PEAK]**

Moves a delta marker vertically to the minimum level for the current frequency.

The search includes all frames. It does not change the horizontal position of the marker.

If the marker hasn't been active yet, the command first looks for the peak level in the whole spectrogram and moves the marker vertically to the minimum level.

**Suffix:**

<n> [Window](#)

<m> [Marker](#)

### 11.8.5 Defining limit checks

Note that in remote control, upper and lower limit lines are configured using separate commands. Thus, you must decide in advance which you want to configure. The x-val-

ues for both upper and lower limit lines are defined as a common control line. This control line is the reference for the y-values for both upper and lower limit lines.

- [Configuring limit lines](#)..... 355
- [Managing limit lines](#)..... 363
- [Checking the results of a limit check](#)..... 366
- [Programming example: using limit lines](#)..... 367

### 11.8.5.1 Configuring limit lines

<a href="#">CALCulate&lt;n&gt;:LIMit&lt;li&gt;:COMMENT</a> .....	355
<a href="#">CALCulate&lt;n&gt;:LIMit&lt;li&gt;:CONTRol[:DATA]</a> .....	355
<a href="#">CALCulate&lt;n&gt;:LIMit&lt;li&gt;:CONTRol:DOMain</a> .....	356
<a href="#">CALCulate&lt;n&gt;:LIMit&lt;li&gt;:CONTRol:MODE</a> .....	356
<a href="#">CALCulate&lt;n&gt;:LIMit&lt;li&gt;:CONTRol:OFFSet</a> .....	357
<a href="#">CALCulate&lt;n&gt;:LIMit&lt;li&gt;:CONTRol:SHIFt</a> .....	357
<a href="#">CALCulate&lt;n&gt;:LIMit&lt;li&gt;:CONTRol:SPACing</a> .....	357
<a href="#">CALCulate&lt;n&gt;:LIMit&lt;li&gt;:LOWer[:DATA]</a> .....	358
<a href="#">CALCulate&lt;n&gt;:LIMit&lt;li&gt;:LOWer:MARGin</a> .....	358
<a href="#">CALCulate&lt;n&gt;:LIMit&lt;li&gt;:LOWer:MODE</a> .....	358
<a href="#">CALCulate&lt;n&gt;:LIMit&lt;li&gt;:LOWer:OFFSet</a> .....	359
<a href="#">CALCulate&lt;n&gt;:LIMit&lt;li&gt;:LOWer:SHIFt</a> .....	359
<a href="#">CALCulate&lt;n&gt;:LIMit&lt;li&gt;:LOWer:SPACing</a> .....	359
<a href="#">CALCulate&lt;n&gt;:LIMit&lt;li&gt;:LOWer:STATe</a> .....	359
<a href="#">CALCulate&lt;n&gt;:LIMit&lt;li&gt;:LOWer:THReshold</a> .....	360
<a href="#">CALCulate&lt;n&gt;:LIMit&lt;li&gt;:NAME</a> .....	360
<a href="#">CALCulate&lt;n&gt;:LIMit&lt;li&gt;:UNIT</a> .....	360
<a href="#">CALCulate&lt;n&gt;:LIMit&lt;li&gt;:UPPer[:DATA]</a> .....	361
<a href="#">CALCulate&lt;n&gt;:LIMit&lt;li&gt;:UPPer:MARGin</a> .....	361
<a href="#">CALCulate&lt;n&gt;:LIMit&lt;li&gt;:UPPer:MODE</a> .....	361
<a href="#">CALCulate&lt;n&gt;:LIMit&lt;li&gt;:UPPer:OFFSet</a> .....	362
<a href="#">CALCulate&lt;n&gt;:LIMit&lt;li&gt;:UPPer:SHIFt</a> .....	362
<a href="#">CALCulate&lt;n&gt;:LIMit&lt;li&gt;:UPPer:SPACing</a> .....	362
<a href="#">CALCulate&lt;n&gt;:LIMit&lt;li&gt;:UPPer:STATe</a> .....	363
<a href="#">CALCulate&lt;n&gt;:LIMit&lt;li&gt;:UPPer:THReshold</a> .....	363

---

#### **CALCulate<n>:LIMit<li>:COMMENT** <Comment>

Defines a comment for a limit line.

#### **Suffix:**

<n>                      irrelevant

<li>                     [Limit line](#)

#### **Parameters:**

<Comment>             String containing the description of the limit line.

---

#### **CALCulate<n>:LIMit<li>:CONTRol[:DATA]** <LimitLinePoints>...

Defines the horizontal definition points of a limit line.

**Suffix:**

<n> irrelevant

<li> [Limit line](#)

**Parameters:**

<LimitLinePoints> Variable number of x-axis values.  
 Note that the number of horizontal values has to be the same as the number of vertical values set with [CALCulate<n>:LIMit<li>:LOWer\[:DATA\]](#) or [CALCulate<n>:LIMit<li>:UPPer\[:DATA\]](#). If not, the FSW either adds missing values or ignores surplus values.  
 The unit is Hz or s.  
 \*RST: -  
 Default unit: HZ

**CALCulate<n>:LIMit<li>:CONTrol:DOMain <SpanSetting>**

Selects the domain of the limit line.

**Suffix:**

<n> irrelevant

<li> [Limit line](#)

**Parameters:**

<SpanSetting> FREQUENCY | TIME

**FREQUENCY**

For limit lines that apply to a range of frequencies.

**TIME**

For limit lines that apply to a period of time.

\*RST: FREQUENCY

**Example:**

```
CALC:LIM:CONT:DOM FREQ
```

Select a limit line in the frequency domain.

**CALCulate<n>:LIMit<li>:CONTrol:MODE <Mode>**

Selects the horizontal limit line scaling.

**Suffix:**

<n> irrelevant

<li> [Limit line](#)

**Parameters:**

<Mode>

**ABSolute**

Limit line is defined by absolute physical values (Hz or s).

**RELative**

Limit line is defined by relative values related to the center frequency (frequency domain) or the left diagram border (time domain).

\*RST: ABSolute

---

### CALCulate<n>:LIMit<li>:CONTrol:OFFSet <Offset>

Defines an offset for a complete limit line.

Compared to shifting the limit line, an offset does not actually change the limit line definition points.

#### Suffix:

<n> irrelevant

<li> [Limit line](#)

#### Parameters:

<Offset> Numeric value.  
The unit depends on the scale of the x-axis.

\*RST: 0

Default unit: HZ

---

### CALCulate<n>:LIMit<li>:CONTrol:SHIFt <Distance>

Moves a complete limit line horizontally.

Compared to defining an offset, this command actually changes the limit line definition points by the value you define.

#### Suffix:

<n> irrelevant

<li> [Limit line](#)

#### Parameters:

<Distance> Numeric value.  
The unit depends on the scale of the x-axis.

Default unit: HZ

---

### CALCulate<n>:LIMit<li>:CONTrol:SPACing <InterpolMode>

Selects linear or logarithmic interpolation for the calculation of limit lines from one horizontal point to the next.

#### Suffix:

<n> [Window](#)

<li> [Limit line](#)

#### Parameters:

<InterpolMode> LINear | LOGarithmic

\*RST: LIN

**Example:** CALC:LIM:CONT:SPAC LIN

---

**CALCulate<n>:LIMit<li>:LOWer[:DATA] <LimitLinePoints>...**

Defines the vertical definition points of a lower limit line.

**Suffix:**

<n> irrelevant  
<li> [Limit line](#)

**Parameters:**

<LimitLinePoints> Variable number of level values.  
Note that the number of vertical values has to be the same as the number of horizontal values set with [CALCulate<n>:LIMit<li>:CONTRol\[:DATA\]](#). If not, the FSW either adds missing values or ignores surplus values.  
The unit depends on [CALCulate<n>:LIMit<li>:UNIT](#) on page 360.  
\*RST: Limit line state is OFF  
Default unit: DBM

---

**CALCulate<n>:LIMit<li>:LOWer:MARGin <Margin>**

Defines an area around a lower limit line where limit check violations are still tolerated.

**Suffix:**

<n> irrelevant  
<li> [Limit line](#)

**Parameters:**

<Margin> **numeric value**  
\*RST: 0  
Default unit: dB

---

**CALCulate<n>:LIMit<li>:LOWer:MODE <Mode>**

Selects the vertical limit line scaling.

**Suffix:**

<n> [Window](#)  
<li> [Limit line](#)

**Parameters:**

<Mode> **ABSolute**  
Limit line is defined by absolute physical values.  
The unit is variable.  
**RELative**  
Limit line is defined by relative values related to the reference level (dB).  
\*RST: ABSolute

**CALCulate<n>:LIMit<li>:LOWer:OFFSet <Offset>**

Defines an offset for a complete lower limit line.

Compared to shifting the limit line, an offset does not actually change the limit line definition points.

**Suffix:**

<n> [Window](#)

<li> [Limit line](#)

**Parameters:**

<Offset> Numeric value.

\*RST: 0

Default unit: dB

**CALCulate<n>:LIMit<li>:LOWer:SHIFt <Distance>**

Moves a complete lower limit line vertically.

Compared to defining an offset, this command actually changes the limit line definition points by the value you define.

**Suffix:**

<n> [Window](#)

<li> [Limit line](#)

**Parameters:**

<Distance> Defines the distance that the limit line moves.

The unit depends on [CALCulate<n>:LIMit<li>:UNIT](#) on page 360.

Default unit: DB

**CALCulate<n>:LIMit<li>:LOWer:SPACing <InterpolType>**

Selects linear or logarithmic interpolation for the calculation of a lower limit line from one horizontal point to the next.

**Suffix:**

<n> [Window](#)

<li> [Limit line](#)

**Parameters:**

<InterpolType> LINear | LOGarithmic

\*RST: LIN

**CALCulate<n>:LIMit<li>:LOWer:STATe <State>**

Turns a lower limit line on and off.

Before you can use the command, you have to select a limit line with `CALCulate<n>:LIMit<li>:NAME` on page 360.

**Suffix:**

<n> irrelevant

<li> [Limit line](#)

**Parameters:**

<State> ON | OFF | 0 | 1  
**OFF | 0**  
 Switches the function off  
**ON | 1**  
 Switches the function on

**CALCulate<n>:LIMit<li>:LOWer:THReshold <Threshold>**

Defines a threshold for relative limit lines.

The FSW uses the threshold for the limit check, if the limit line violates the threshold.

**Suffix:**

<n> irrelevant

<li> [Limit line](#)

**Parameters:**

<Threshold> Numeric value.  
 The unit depends on `CALCulate<n>:LIMit<li>:UNIT` on page 360.  
 \*RST: -200 dBm  
 Default unit: DBM

**CALCulate<n>:LIMit<li>:NAME <Name>**

Selects a limit line that already exists or defines a name for a new limit line.

**Suffix:**

<n> [Window](#)

<li> [Limit line](#)

**Parameters:**

<Name> String containing the limit line name.  
 \*RST: REM1 to REM8 for lines 1 to 8

**CALCulate<n>:LIMit<li>:UNIT <Unit>**

Defines the unit of a limit line.

**Suffix:**

<n> irrelevant



<li> [Limit line](#)

**Parameters:**

<Unit> If you select a dB-based unit for the limit line, the command automatically turns the limit line into a relative limit line.

\*RST: DBM

**CALCulate<n>:LIMit<li>:UPPer[:DATA] <LimitLinePoints>...**

Defines the vertical definition points of an upper limit line.

**Suffix:**

<n> irrelevant

<li> [Limit line](#)

**Parameters:**

<LimitLinePoints> Variable number of level values.

Note that the number of vertical values has to be the same as the number of horizontal values set with [CALCulate<n>:LIMit<li>:CONTRol\[:DATA\]](#). If not, the FSW either adds missing values or ignores surplus values.

The unit depends on [CALCulate<n>:LIMit<li>:UNIT](#) on page 360.

\*RST: Limit line state is OFF

Default unit: DBM

**CALCulate<n>:LIMit<li>:UPPer:MARGIn <Margin>**

Defines an area around an upper limit line where limit check violations are still tolerated.

**Suffix:**

<n> irrelevant

<li> [Limit line](#)

**Parameters:**

<Margin> **numeric value**

\*RST: 0

Default unit: dB

**CALCulate<n>:LIMit<li>:UPPer:MODE <Mode>**

Selects the vertical limit line scaling.

**Suffix:**

<n> [Window](#)

<li> [Limit line](#)

**Parameters:**

<Mode>

**ABSolute**

Limit line is defined by absolute physical values.

The unit is variable.

**RELative**

Limit line is defined by relative values related to the reference level (dB).

\*RST: ABSolute

**CALCulate<n>:LIMit<li>:UPPer:OFFSet <Offset>**

Defines an offset for a complete upper limit line.

Compared to shifting the limit line, an offset does not actually change the limit line definition points.

**Suffix:**

<n> irrelevant

<li> [Limit line](#)

**Parameters:**

<Offset>

Numeric value.

\*RST: 0

Default unit: dB

**CALCulate<n>:LIMit<li>:UPPer:SHIFt <Distance>**

Moves a complete upper limit line vertically.

Compared to defining an offset, this command actually changes the limit line definition points by the value you define.

**Suffix:**

<n> irrelevant

<li> [Limit line](#)

**Parameters:**

<Distance>

Defines the distance that the limit line moves.

The unit depends on [CALCulate<n>:LIMit<li>:UNIT](#) on page 360.

**CALCulate<n>:LIMit<li>:UPPer:SPACing <InterpolType>**

Selects linear or logarithmic interpolation for the calculation of an upper limit line from one horizontal point to the next.

**Suffix:**

<n> [Window](#)

<li> [Limit line](#)

**Parameters:**

<InterpolType> LINear | LOGarithmic  
\*RST: LIN

**CALCulate<n>:LIMit<li>:UPPer:STATe <State>**

Turns an upper limit line on and off.

Before you can use the command, you have to select a limit line with [CALCulate<n>:LIMit<li>:NAME](#) on page 360.

**Suffix:**

<n> irrelevant

<li> [Limit line](#)

**Parameters:**

<State> ON | OFF | 0 | 1  
**OFF | 0**  
Switches the function off  
**ON | 1**  
Switches the function on

**CALCulate<n>:LIMit<li>:UPPer:THReshold <Limit>**

Defines an absolute limit for limit lines with a relative scale.

The FSW uses the threshold for the limit check, if the limit line violates the threshold.

**Suffix:**

<n> irrelevant

<li> [Limit line](#)

**Parameters:**

<Limit> Numeric value.  
The unit depends on [CALCulate<n>:LIMit<li>:UNIT](#) on page 360.  
\*RST: -200  
Default unit: dBm

### 11.8.5.2 Managing limit lines

Useful commands for managing limit lines described in the FSW User Manual:

- MMEM:SEL [ : ITEM ] : LIN : ALL
- MMEM:STOR:TYPE
- MMEM:LOAD:TYPE

**Remote commands exclusive to managing limit lines:**

CALCulate<n>:LIMit<li>:ACTive?	364
CALCulate<n>:LIMit<li>:COPY	364
CALCulate<n>:LIMit<li>:DELeTe	364
CALCulate<n>:LIMit<li>:STATe	365
CALCulate<n>:LIMit<li>:TRACe<t>:CHECK	365
MMEMory:LOAD<n>:LIMit	366
MMEMory:STORe<n>:LIMit	366

**CALCulate<n>:LIMit<li>:ACTive?**

Queries the names of *all* active limit lines.

**Suffix:**

<n> irrelevant

<li> irrelevant

**Return values:**

<LimitLines> String containing the names of all active limit lines in alphabetical order.

**Example:** CALC:LIM:ACT?  
Queries the names of all active limit lines.

**Usage:** Query only

**CALCulate<n>:LIMit<li>:COPY <Line>**

Copies a limit line.

**Suffix:**

<n> [Window](#)

<li> [Limit line](#)

**Parameters:**

<Line> **1 to 8**  
number of the new limit line

**<name>**  
String containing the name of the limit line.

**Example:** CALC:LIM1:COPY 2  
Copies limit line 1 to line 2.  
CALC:LIM1:COPY 'FM2'  
Copies limit line 1 to a new line named FM2.

**CALCulate<n>:LIMit<li>:DELeTe**

Deletes a limit line.

**Suffix:**

<n> [Window](#)

<li> [Limit line](#)

---

### **CALCulate<n>:LIMit<li>:STATe <State>**

Turns the limit check for a specific limit line on and off.

To query the limit check result, use [CALCulate<n>:LIMit<li>:FAIL?](#).

Note that a new command exists to activate the limit check and define the trace to be checked in one step (see [CALCulate<n>:LIMit<li>:TRACe<t>:CHECK](#) on page 365).

#### **Suffix:**

<n> irrelevant

<li> [Limit line](#)

#### **Parameters:**

<State> ON | OFF | 0 | 1

**OFF | 0**

Switches the function off

**ON | 1**

Switches the function on

#### **Example:**

`CALC:LIM:STAT ON`

Switches on the limit check for limit line 1.

---

### **CALCulate<n>:LIMit<li>:TRACe<t>:CHECK <State>**

Turns the limit check for a specific trace on and off.

To query the limit check result, use [CALCulate<n>:LIMit<li>:FAIL?](#).

Note that this command replaces the two commands from previous signal and spectrum analyzers (which are still supported, however):

- `CALC:LIM:TRAC`; see the description of commands for compatibility in the FSW User Manual
- [CALCulate<n>:LIMit<li>:STATe](#) on page 365

#### **Suffix:**

<n> [Window](#)

<li> [Limit line](#)

<t> [Trace](#)

#### **Parameters:**

<State> ON | OFF | 0 | 1

**OFF | 0**

Switches the function off

**ON | 1**

Switches the function on

**Example:** `CALC:LIM3:TRAC2:CHEC ON`  
Switches on the limit check for limit line 3 on trace 2.

---

**MMEMory:LOAD<n>:LIMit <FileName>**

Loads the limit line from the selected file in .CSV format.

**Suffix:**  
<n> irrelevant

**Parameters:**  
<FileName> String containing the path and name of the CSV import file.

**Example:** `MMEM:LOAD:LIM 'C:\TEST.CSV'`

---

**MMEMory:STORe<n>:LIMit <FileName>, <LimitLineName>**

Exports limit line data to an ASCII (CSV) file.

For details on the file format see the FSW User Manual.

**Suffix:**  
<n> irrelevant

**Parameters:**  
<FileName> String containing the path and name of the target file.

<LimitLineName> Name of the limit line to be exported.

**Example:** `MMEM:STOR:LIM 'C:\TEST', 'UpperLimitLine'`  
Stores the limit line named "UpperLimitLine" in the file TEST.CSV.

### 11.8.5.3 Checking the results of a limit check

<a href="#">CALCulate&lt;n&gt;:LIMit&lt;li&gt;:CLEar[:IMMEDIATE]</a> .....	366
<a href="#">CALCulate&lt;n&gt;:LIMit&lt;li&gt;:FAIL?</a> .....	367

---

**CALCulate<n>:LIMit<li>:CLEar[:IMMEDIATE]**

Deletes the result of the current limit check.

The command works on *all* limit lines in *all* measurement windows at the same time.

**Suffix:**  
<n> [Window](#)  
<li> irrelevant

**Example:** `CALC:LIM:CLE`  
Deletes the result of the limit check.

**CALCulate<n>:LIMit<li>:FAIL?**

Queries the result of a limit check in the specified window.

To get a valid result, you have to perform a complete measurement with synchronization to the end of the measurement before reading out the result. This is only possible for single sweep mode.

See also [INITiate<n>:CONTinuous](#) on page 266.

**Suffix:**

<n> [Window](#)

<li> [Limit line](#)

**Return values:**

<Result>           **0**  
                          PASS  
  
                          **1**  
                          FAIL

**Example:**

```
INIT;*WAI
Starts a new sweep and waits for its end.
CALC2:LIM3:FAIL?
Queries the result of the check for limit line 3 in window 2.
```

**Usage:**

Query only

**11.8.5.4 Programming example: using limit lines**

The following examples demonstrate how to work with limit lines in a remote environment.

- [Example: configuring limit lines](#).....367
- [Example: performing a limit check](#)..... 368

**Example: configuring limit lines**

This example demonstrates how to configure 2 limit lines - an upper and a lower limit - for a measurement in a remote environment.

```
//----- Configuring the limit lines -----
CALC:LIM1:NAME 'FM1'
//Names limit line 1 'FM1'.

CALC:LIM1:CONT:MODE ABS
//Selects absolute scaling for the horizontal axis.
CALC:LIM1:CONT 1 MHz,50MHz,100 MHz,150MHz,200MHz
//Defines 5 horizontal definition points for limit line 1.
CALC:LIM1:UPP:MODE ABS
//Selects an absolute vertical scale for limit line 1.
CALC:LIM1:UNIT DBM
//Selects the unit dBm for limit line 1.
CALC:LIM1:UPP -10,-5,0,-5,-10
```

```

//Defines 5 definition points for limit line 1.

CALC:LIM1:UPP:MARG 5dB
//Defines an area of 5 dB around limit line 1 where limit check violations
//are still tolerated.

CALC:LIM1:UPP:SHIF -10DB
//Shifts the limit line 1 by -10 dB.
CALC:LIM1:UPP:OFFS -3dB
//Defines an additional -3 dB offset for limit line 1.

CALC:LIM3:NAME 'FM3'
//Names limit line 3 'FM3'.

CALC:LIM3:LOW:MODE REL
//Selects a relative vertical scale for limit line 3.
CALC:LIM3:UNIT DB

CALC:LIM3:CONT 1 MHz,50MHz,100 MHz,150MHz,200MHz
//Defines 5 horizontal definition points for limit line 3.
CALC:LIM3:LOW -90,-60,-40,-60,-90
//Defines 5 definition points relative to the reference level for limit line 3.

CALC:LIM3:LOW:SHIF 2
//Shifts the limit line 3 by 2dB.
CALC:LIM3:LOW:OFFS 3
//Defines an additional 3 dB offset for limit line 3.

CALC:LIM3:LOW:THR -200DBM
//Defines a power threshold of -200dBm that must be exceeded for limit to be checked

CALC:LIM3:LOW:MARG 5dB
//Defines an area of 5dB around limit line 3 where limit check violations
//are still tolerated.

//----- Storing the limit lines -----
MMEM:SEL:CHAN:LIN:ALL ON
MMEM:STOR:TYPE CHAN
MMEM:STOR:STAT 1,'LimitLines_FM1_FM3'

```

### Example: performing a limit check

This example demonstrates how to perform a limit check during a basic frequency sweep measurement in a remote environment. The limit lines configured in ["Example: configuring limit lines"](#) on page 367 are assumed to exist and be active.

```

//-----Preparing the instrument -----
*RST
//Resets the instrument
INIT:CONT OFF
//Selects single sweep mode.

```



```

//-----Configuring the measurement -----
FREQ:CENT 100MHz
//Defines the center frequency
FREQ:SPAN 200MHz
//Sets the span to 100 MHz on either side of the center frequency.
SENS:SWE:COUN 10
//Defines 10 sweeps to be performed in each measurement.
DISP:TRAC1:Y:RLEV 0dBm
//Sets the reference level to 0 dBm.
TRIG:SOUR IFP
TRIG:LEV:IFP -10dBm
//Defines triggering when the second intermediate frequency rises to a level
//of -10 dBm.

//-----Configuring the Trace-----
DISP:TRAC2 ON
DISP:TRAC2:MODE AVER
DISP:TRAC3 ON
DISP:TRAC3:MODE MAXH
//Configures 3 traces: 1 (default): clear/write; 2: average; 3: max hold

//----- Configuring the limit check -----
MMEM:LOAD:TYPE REPL
MMEM:LOAD:STAT 1, 'LimitLines_FM1_FM3'
//Loads the limit lines stored in 'LimitLines_FM1_FM3'
CALC:LIM1:NAME 'FM1'
CALC:LIM1:UPP:STAT ON
//Activates upper limit FM1 as line 1.
CALC:LIM3:NAME 'FM3'
CALC:LIM3:LOW:STAT ON
//Activates lower limit line FM3 as line 3.
CALC:LIM:ACT?
//Queries the names of all active limit lines
//Result: 'FM1,FM3'
CALC:LIM1:TRAC3:CHEC ON
//Activates the upper limit to be checked against trace3 (maxhold trace)
CALC:LIM3:TRAC2:CHEC ON
//Activates the upper limit to be checked against trace2 (average trace)
CALC:LIM:CLE
//Clears the previous limit check results

//----- Performing the measurement-----
INIT;*WAI
//Initiates a new measurement and waits until the last sweep has finished.

//----- Retrieving limit check results-----

CALC:LIM1:FAIL?
//Queries the result of the upper limit line check

```

```
CALC:LIM3:FAIL?
//Queries the result of the lower limit line check
```

### 11.8.6 Configuring an analysis interval and line (MSRA mode only)

In MSRA operating mode, only the MSRA primary actually captures data; the MSRA secondary applications define an extract of the captured data for analysis, referred to as the **analysis interval**. The **analysis line** is a common time marker for all MSRA secondary applications.

For the Analog Modulation Analysis secondary application, the commands to define the analysis interval are the same as those used to define the actual data acquisition (see [Chapter 11.4.7, "Configuring data acquisition"](#), on page 225. Be sure to select the correct channel before executing these commands.

In addition, a capture offset can be defined, i.e. an offset from the start of the captured data to the start of the analysis interval for the Analog Modulation Analysis.

Useful commands related to MSRA mode described elsewhere:

- [INITiate<n>:REFresh](#) on page 267
- [INITiate:SEQuencer:REFresh\[:ALL\]](#) on page 268

#### Remote commands exclusive to MSRA secondary applications

The following commands are only available for MSRA secondary application channels:

<a href="#">CALCulate&lt;n&gt;:MSRA:ALINE:SHOW</a> .....	370
<a href="#">CALCulate&lt;n&gt;:MSRA:ALINE[:VALue]</a> .....	371
<a href="#">CALCulate&lt;n&gt;:MSRA:WINDow&lt;n&gt;:IVAL</a> .....	371
<a href="#">[SENSe:]MSRA:CAPTure:OFFSet</a> .....	371

---

#### **CALCulate<n>:MSRA:ALINE:SHOW**

Defines whether or not the analysis line is displayed in all time-based windows in all MSRA secondary applications and the MSRA primary application.

**Note:** even if the analysis line display is off, the indication whether or not the currently defined line position lies within the analysis interval of the active secondary application remains in the window title bars.

#### **Suffix:**

<n>                      irrelevant

#### **Parameters:**

<State>                ON | OFF | 0 | 1  
**OFF | 0**  
 Switches the function off  
**ON | 1**  
 Switches the function on

**Manual operation:** See ["Show Line"](#) on page 133

---

**CALCulate<n>:MSRA:ALINe[:VALue] <Position>**

Defines the position of the analysis line for all time-based windows in all MSRA secondary applications and the MSRA primary application.

**Suffix:**

<n> irrelevant

**Parameters:**

<Position> Position of the analysis line in seconds. The position must lie within the measurement time of the MSRA measurement.  
Default unit: s

**Manual operation:** See "[Position](#)" on page 133

---

**CALCulate<n>:MSRA:WINDow<n>:IVAL**

Returns the current analysis interval for applications in MSRA operating mode.

**Suffix:**

<n> irrelevant

<n> 1..n  
[Window](#)

**Return values:**

<IntStart> Analysis start = Capture offset time  
Default unit: s

<IntStop> Analysis end = capture offset + capture time  
Default unit: s

---

**[SENSe:]MSRA:CAPTure:OFFSet <Offset>**

This setting is only available for secondary applications in MSRA mode, not for the MSRA primary application. It has a similar effect as the trigger offset in other measurements.

**Parameters:**

<Offset> This parameter defines the time offset between the capture buffer start and the start of the extracted secondary application data. The offset must be a positive value, as the secondary application can only analyze data that is contained in the capture buffer.

Range: 0 to <Record length>

\*RST: 0

Default unit: S

**Manual operation:** See "[Capture Offset](#)" on page 62



**Suffix:**

<n> irrelevant

**Parameters:**

<Position> Position of the analysis line in seconds. The position must lie within the measurement time (pretrigger + posttrigger) of the MSRT measurement.

Default unit: s

**Manual operation:** See "[Position](#)" on page 133

**CALCulate<n>:RTMS:WINDow<n>:IVAL**

Returns the current analysis interval for applications in MSRT operating mode.

**Suffix:**

<n> irrelevant

<n> 1..n  
[Window](#)

**Return values:**

<IntStart> Analysis start = Capture offset time  
Default unit: s

<IntStop> Analysis end = capture offset + capture time  
Default unit: s

**[SENSe:]RTMS:CAPTure:OFFSet <Offset>**

This setting is only available for secondary applications in MSRT mode, not for the MSRT primary. It has a similar effect as the trigger offset in other measurements.

**Parameters:**

<Offset> This parameter defines the time offset between the capture buffer start and the start of the extracted secondary application data. The offset must be a positive value, as the secondary application can only analyze data that is contained in the capture buffer.

Range: - [pretrigger time] to min (posttrigger time; sweep time)

\*RST: 0

Default unit: S

**Manual operation:** See "[Capture Offset](#)" on page 62

## 11.9 Importing and exporting I/Q data and results

The I/Q data to be evaluated in the AM/FM/PM Modulation Analysis application can not only be measured by the AM/FM/PM Modulation Analysis application itself, it can also

be imported to the application, provided it has the correct format. Furthermore, the evaluated I/Q data from the AM/FM/PM Modulation Analysis application can be exported for further analysis in external applications.

For details see [Chapter 4.7, "I/Q data import and export"](#), on page 34.

<a href="#">MMEMory:LOAD:IQ:STATe</a> .....	374
<a href="#">MMEMory:STORe&lt;n&gt;:IQ:COMMeNt</a> .....	374
<a href="#">MMEMory:STORe&lt;n&gt;:IQ:FORMat</a> .....	374
<a href="#">MMEMory:STORe&lt;n&gt;:IQ:STATe</a> .....	375

---

### **MMEMory:LOAD:IQ:STATe** 1, <FileName>

Restores I/Q data from a file.

#### **Setting parameters:**

<FileName>                    string  
                                       String containing the path and name of the source file.  
                                       The file type is determined by the file extension. If no file extension is provided, the file type is assumed to be `.iq.tar`.  
                                       For `.mat` files, Matlab® v4 is assumed.

**Example:**                    Loads IQ data from the specified file.

**Usage:**                      Setting only

---

### **MMEMory:STORe<n>:IQ:COMMeNt** <Comment>

Adds a comment to a file that contains I/Q data.

#### **Suffix:**

<n>                              irrelevant

#### **Parameters:**

<Comment>                    String containing the comment.

**Example:**                    `MMEM:STOR:IQ:COMM 'Device test 1b'`  
                                       Creates a description for the export file.  
                                       `MMEM:STOR:IQ:STAT 1, 'C:`  
                                       `\R_S\Instr\user\data.iq.tar'`  
                                       Stores I/Q data and the comment to the specified file.

---

### **MMEMory:STORe<n>:IQ:FORMat** <Format>, <DataFormat>

Sets or queries the format of the I/Q data to be stored.

#### **Suffix:**

<n>                              irrelevant

#### **Parameters:**

<Format>                      **FLOat32**  
                                       32-bit floating point format.

	<b>INT32</b>
	32-bit integer format.
	*RST: FLOat32
<DataFormat>	<b>COMPLex</b>
	Exports complex data.
	<b>REAL</b>
	Exports real data.
	*RST: COMPLex
<b>Example:</b>	MMEM:STOR:IQ:FORM INT32,REAL

---

### MMEMory:STORe<n>:IQ:STATe <1>, <FileName>

Writes the captured I/Q data to a file.

By default, the contents of the file are in 32-bit floating point format.

#### Suffix:

<n> 1..n

#### Parameters:

<1>

<FileName>

String containing the path and name of the target file.  
The file type is determined by the file extension. If no file extension is provided, the file type is assumed to be `.iq.tar`.  
For `.mat` files, Matlab® v4 is assumed.

#### Example:

```
MMEM:STOR:IQ:STAT 1, 'C:\R_S\Instr\user\data.iq.tar'
```

Stores the captured I/Q data to the specified file.

#### Usage:

Asynchronous command

## 11.10 Deprecated commands

The following commands are provided for compatibility to other signal analyzers only. For new remote control programs use the specified alternative commands.

[CALCulate<n>:FEED](#)..... 375

---

### CALCulate<n>:FEED <Evaluation>

Selects the evaluation method of the measured data that is to be displayed in the specified window.

Note that this command is maintained for compatibility reasons only. Use the `LAYout` commands for new remote control programs (see [Chapter 11.6.2, "Working with windows in the display"](#), on page 270).

**Suffix:**<n> [Window](#)**Parameters:**<Evaluation> Type of evaluation you want to display.  
See the table below for available parameter values.**Example:**

```
INST:SEL ADEM
Activates Analog Modulation Analysis.
CALC:FEED 'XTIM:FM'
Selects the display of the FM signal.
```

**Table 11-6: <Evaluation> parameter values for the R&S FSW AM/FM/PM Modulation Analysis application**

Parameter	Evaluation
'XTIM:AM:RELative'	"AM Time Domain"
'XTIM:AM:RELative:AFSPectrum'	"AM Spectrum"
'XTIM:FM'	"FM Time Domain"
'XTIM:FM:AFSPectrum'	"FM Spectrum"
'XTIM:PM'	"PM Time Domain"
'XTIM:PM:AFSPectrum'	"PM Spectrum"
'XTIM:SPECTrum'	"RF Spectrum"
'XTIM:AM' 'XTIM:RFPower'	"RF Time Domain" (= RF power)
'XTIM:AMSummary' 'XTIM:AMSummary:RELative' 'XTIM:FMSummary' 'XTIM:FMSummary:RELative' 'XTIM:PMSummary' 'XTIM:PMSummary:RELative' 'XTIM:SUMMARY'	Result summary

## 11.11 Programming example

In this example we will configure and perform an Analog Modulation Analysis measurement to demonstrate the remote control commands.

**Signal generator settings (e.g. R&S SMW):**

Frequency:	500 MHz
Level:	-10 dBm
Modulation:	FM



Modulation frequency:	10 kHz
Frequency deviation:	50 kHz

```
//-----Preparing the measurement -----
//Reset the instrument
*RST

//Set the center frequency to 500 MHz
FREQ:CENT 500 MHz
//Set the reference level to 0 dBm
DISP:TRAC:Y:SCAL:RLEV 0

//----- Activating an Analog Modulation Analysis measurement channel -----
//Activate an Analog Modulation Analysis measurement channel named "FMDemodulation"
INST:CRE:NEW ADEM, 'FMDemodulation'

//----- Configuring data acquisition -----
//Set the measurement time to 1 ms (=10 periods)
ADEM:MTIM 1ms
//Optimize the scaling of the y-axis for the current measurement (continuously)
SENS:ADJ:SCAL:Y:AUTO ON
//Set the demodulation bandwidth to 400 kHz
BAND:DEM 400 kHz
//Trigger when magnitude of I/Q data reaches -50dBm
TRIG:SOUR IQP
TRIG:LEV:IQP -50

//----- Configuring the result display -----

//Add an FM Spectrum result display below FM Time Domain
LAY:ADD:WIND? '1',BEL, 'XTIM:FM:AFSP'
//Define two traces in the FM Spectrum: 1: Clear/write, 2: average
ADEM:FM:AFSP WRIT,AVER,OFF,OFF,OFF,OFF
//Set analog demodulator to execute 30 sweeps with 32000 samples each
//at a sample rate of 8 MHz; use IQ trigger, trigger on positive slope
//with a pretrigger offset of 500 samples
ADEM:SET 8MHz,32000,IQP,POS,-500,30

//-----Performing the Measurement-----

//Stop continuous sweep
INIT:CONT OFF

//Start a new measurement with 30 sweeps and wait for the end
INIT;*WAI
```

```
//-----Retrieving Results-----  
//Query the carrier power  
CALC:MARK:FUNC:ADEM:CARR?  
//Result: -10.37 [dBm]  
  
//Query the signal-to-noise-and-distortion ratio from the FM Spectrum  
CALC2:MARK:FUNC:ADEM:SIN:RES?  
//Result: 65.026 [dB]  
  
//Query the total harmonic distortion of the demodulated signal  
//from the FM Spectrum  
CALC2:MARK:FUNC:ADEM:THD:RES?  
//Result: -66.413 [dB]  
  
//Query the FM carrier offset (=frequency error) for the most recent  
//measurement (trace 1)  
CALC:MARK:FUNC:ADEM:FERR?  
//Result: 649.07 [Hz]  
  
//Query FM carrier offset averaged over 30 measurements  
ADEM:FM:OFFS? AVER  
//Result: 600 [Hz]  
  
//Retrieve the trace data of the most recent measurement (trace 1)  
TRAC:DATA? TRACE1  
//Result: -1.201362252,-1.173495054,-1.187217355,-1.186594367,-1.171583891,  
//-1.188250422,-1.204138160,-1.181404829,-1.186317205,-1.197872400, [...]  
  
//Retrieve the averaged trace data for all 30 measurements (trace 2)  
TRAC:DATA? TRACE2//Result: -1.201362252,-1.173495054,-1.187217355,-1.186594367,-1.171583891,  
//-1.188250422,-1.204138160,-1.181404829,-1.186317205,-1.197872400, [...]
```

# Annex

## A Predefined standards and settings

You can configure the Analog Modulation Analysis application using predefined standard settings. This allows for quick and easy configuration for commonly performed measurements.

For details see [Chapter 5.2, "Configuration according to standards"](#), on page 39.

### Provided standard files

The instrument comes prepared with the following standard settings:

- AM Broadcast
- FM Narrowband
- FM Broadcast
- Frequency Settling
- None (default settings)

The default storage location for the settings files is:

C:\R\_S\INSTR\USER\predefined\AdemodPredefined.

### Predefined settings

The following parameters can be stored in a standard settings file. Any parameters that are not included in the xml file are set to their default values when the standard is loaded.

#### Measurement settings:

- DBW
- AQT
- Demod Filter
- Sweep Points
- Squelch (State, Level)
- Units (Phase, THD)
- RF Span
- Settling Time (Time domain only)

#### Window display settings:

- Position
- State
- Window number
- Window type (all evaluation methods supported by the Analog Modulation Analysis application; see [Chapter 3, "Measurements and result displays"](#), on page 15)
- Scaling (Ref Position, Dev per Division)
- Time Domain Zoom (State, Start, Length)

**AF specific settings:**

- AF Center
- AF Span
- AF Filters (Lowpass, Highpass, Deemphasis, Weighting)
- Scaling for Spectrum (Ref Value, Deviation)
- Scaling for Time Domain (Ref Value, AF Coupling (FM/PM only))

**Table A-1: List of predefined standards and settings**

Setting	AM Broadcast	FM Narrowband	FM Broadcast	Frequency Settling *)	None (Default)
<b>Demod. bandwidth</b>	100 kHz	100 kHz	400 kHz	5 MHz	5 MHz
<b>Aquisition time</b>	100 ms	100 ms	100 ms	10 ms	62.5 µs
<b>Input coupling</b>	AC	AC	AC		AC
<b>Squelch level</b>				-30 dBm	-20 dBm
<b>Windows</b>	"RF Spectrum" "AM Time Domain" "AM Spectrum" "Result Summary"	"RF Spectrum" "FM Time Domain" "FM Spectrum" "Result Summary"	"RF Spectrum" "FM Time Domain" "FM Spectrum" "Result Summary"	"FM Time Domain" "RF Time Domain" "Result Summary"	"FM Time Domain" "Result Summary"
<b>AF filter - High-pass</b>	20 kHz	50 Hz			-
<b>AF filter - Low-pass</b>	15 kHz	3 kHz	150 kHz		-
<b>RF Spectrum</b>					
<b>Span</b>	50 kHz	25 kHz	400 kHz		
<b>AM/FM Time Domain</b>					
<b>Time domain zoom</b>	10 ms	10 ms	10 ms		-
<b>Dev per division</b>		1 kHz	20 kHz	100 kHz	50 kHz
<b>Time domain</b>					
<b>Settling Time State</b>				ON	
<b>AM/FM Spectrum</b>					
<b>Start freq.</b>	0 Hz	0 Hz	0 Hz		
<b>Stop freq.</b>	15 kHz	5 kHz	63.33 kHz		
<b>Ref. value</b>		5 kHz	75 kHz		
*) The Frequency Settling scenario requires a manually defined trigger					

# List of Commands (Analog Modulation Analysis)

[SENSe:][WINDow<n>:]DETEctor<t>[:FUNction].....	305
[SENSe:][WINDow<n>:]DETEctor<t>[:FUNction]:AUTO.....	305
[SENSe:]ADEMod:ACV:AFSPectrum:RESult?.....	278
[SENSe:]ADEMod:ACV[:TDOMain]:RESult?.....	278
[SENSe:]ADEMod:AF:CENter.....	246
[SENSe:]ADEMod:AF:SPAN.....	246
[SENSe:]ADEMod:AF:SPAN:FULL.....	246
[SENSe:]ADEMod:AF:STARt.....	247
[SENSe:]ADEMod:AF:STOP.....	247
[SENSe:]ADEMod:AM:RELative:AFSPectrum:RESult?.....	278
[SENSe:]ADEMod:AM:RELative:AFSPectrum[:TYPE].....	302
[SENSe:]ADEMod:AM:RELative[:TDOMain]:RESult?.....	278
[SENSe:]ADEMod:AM:RELative[:TDOMain][:TYPE].....	302
[SENSe:]ADEMod:AM[:ABSolute]:AFSPectrum:RESult?.....	278
[SENSe:]ADEMod:AM[:ABSolute]:AFSPectrum[:TYPE].....	302
[SENSe:]ADEMod:AM[:ABSolute][:TDOMain]:RESult?.....	278
[SENSe:]ADEMod:AM[:ABSolute][:TDOMain][:TYPE].....	302
[SENSe:]ADEMod:FM:AFSPectrum:RESult?.....	278
[SENSe:]ADEMod:FM:AFSPectrum[:TYPE].....	302
[SENSe:]ADEMod:FM[:TDOMain]:RESult?.....	278
[SENSe:]ADEMod:FM[:TDOMain][:TYPE].....	302
[SENSe:]ADEMod:MTIME.....	226
[SENSe:]ADEMod:PM:AFSPectrum:RESult?.....	278
[SENSe:]ADEMod:PM:AFSPectrum[:TYPE].....	302
[SENSe:]ADEMod:PM:RPOint[:X].....	242
[SENSe:]ADEMod:PM:RPOint[:X]:MODE.....	242
[SENSe:]ADEMod:PM[:TDOMain]:RESult?.....	278
[SENSe:]ADEMod:PM[:TDOMain][:TYPE].....	302
[SENSe:]ADEMod:PRESet:RESTore.....	156
[SENSe:]ADEMod:PRESet:STORe.....	156
[SENSe:]ADEMod:PRESet[:STANdard].....	155
[SENSe:]ADEMod:RLENgth.....	226
[SENSe:]ADEMod:SET.....	226
[SENSe:]ADEMod:SETTling:TIME:LIMit:LOWer.....	258
[SENSe:]ADEMod:SETTling:TIME:LIMit:UPPer.....	259
[SENSe:]ADEMod:SETTling:TIME:RESult<t>?.....	288
[SENSe:]ADEMod:SETTling:TIME:STATe.....	259
[SENSe:]ADEMod:SPEctrum:BWIDth[:RESolution].....	228
[SENSe:]ADEMod:SPEctrum:RESult?.....	278
[SENSe:]ADEMod:SPEctrum:SPAN:ZOOM.....	247
[SENSe:]ADEMod:SPEctrum:SPAN[:MAXimum].....	248
[SENSe:]ADEMod:SPEctrum[:TYPE].....	302
[SENSe:]ADEMod:SQUelch:LEVel.....	243
[SENSe:]ADEMod:SQUelch[:STATe].....	242
[SENSe:]ADEMod:SRATE.....	228

[SENSe:]ADEMod<n>:AF:COUPling.....	241
[SENSe:]ADEMod<n>:SPEctrum:BANDwidth[:RESolution].....	228
[SENSe:]ADEMod<n>:ZOOM:LENGth.....	244
[SENSe:]ADEMod<n>:ZOOM:LENGth:MODE.....	244
[SENSe:]ADEMod<n>:ZOOM:STARt.....	245
[SENSe:]ADEMod<n>:ZOOM[:STATe].....	245
[SENSe:]ADJusT:ALL.....	260
[SENSe:]ADJusT:CONFigure:HYSteresis:LOWer.....	262
[SENSe:]ADJusT:CONFigure:HYSteresis:UPPer.....	262
[SENSe:]ADJusT:CONFigure:LEVel:DURation.....	261
[SENSe:]ADJusT:CONFigure:LEVel:DURation:MODE.....	261
[SENSe:]ADJusT:CONFigure:SMODE.....	262
[SENSe:]ADJusT:CONFigure:TRIGger.....	263
[SENSe:]ADJusT:FREQuency.....	263
[SENSe:]ADJusT:LEVel.....	263
[SENSe:]ADJusT:SCALE[:Y]:AUTO[:CONTinuous].....	264
[SENSe:]AVERAge<n>:COUNT.....	304
[SENSe:]AVERAge<n>:TYPE.....	304
[SENSe:]AVERAge<n>[:STATe<t>].....	304
[SENSe:]BANDwidth:DEMod.....	228
[SENSe:]BANDwidth:DEMod:TYPE.....	228
[SENSe:]BANDwidth[:RESolution].....	229
[SENSe:]BWIDth:DEMod.....	228
[SENSe:]BWIDth:DEMod:TYPE.....	228
[SENSe:]CORRection:COLLect[:ACQuire].....	209
[SENSe:]CORRection:CVL:BAND.....	171
[SENSe:]CORRection:CVL:BIAS.....	171
[SENSe:]CORRection:CVL:CATalog?.....	172
[SENSe:]CORRection:CVL:CLEar.....	172
[SENSe:]CORRection:CVL:COMMeNt.....	172
[SENSe:]CORRection:CVL:DATA.....	173
[SENSe:]CORRection:CVL:HARMonic.....	173
[SENSe:]CORRection:CVL:MIXer.....	173
[SENSe:]CORRection:CVL:PORTs.....	174
[SENSe:]CORRection:CVL:SElect.....	174
[SENSe:]CORRection:CVL:SNUMber.....	174
[SENSe:]CORRection:METhod.....	209
[SENSe:]CORRection:RECall.....	210
[SENSe:]CORRection:TRANsdUcer:GENerate.....	210
[SENSe:]CORRection[:STATe].....	210
[SENSe:]FILTer<n>:AOFF.....	249
[SENSe:]FILTer<n>:AWEighted[:STATe].....	248
[SENSe:]FILTer<n>:CCIR:WEIGhted[:STATe].....	249
[SENSe:]FILTer<n>:CCIR[:UNWeighted][:STATe].....	249
[SENSe:]FILTer<n>:CCIT[:STATe].....	250
[SENSe:]FILTer<n>:DEMPHasis:TCONstant.....	250
[SENSe:]FILTer<n>:DEMPHasis[:STATe].....	250
[SENSe:]FILTer<n>:HPASs:FREQuency:MANual.....	251
[SENSe:]FILTer<n>:HPASs:FREQuency[:ABSolute].....	251
[SENSe:]FILTer<n>:HPASs[:STATe].....	251

[SENSe:]FILTer<n>:LPASs:FREQuency:MANual.....	252
[SENSe:]FILTer<n>:LPASs:FREQuency:RELative.....	252
[SENSe:]FILTer<n>:LPASs:FREQuency[:ABSolute].....	252
[SENSe:]FILTer<n>:LPASs[:STATe].....	253
[SENSe:]FREQuency:CENTer.....	215
[SENSe:]FREQuency:CENTer:STEP.....	215
[SENSe:]FREQuency:CENTer:STEP:LINK.....	215
[SENSe:]FREQuency:CENTer:STEP:LINK:FACTor.....	216
[SENSe:]MIXer<x>:BIAS:HIGH.....	163
[SENSe:]MIXer<x>:BIAS[:LOW].....	163
[SENSe:]MIXer<x>:FREQuency:HANDover.....	165
[SENSe:]MIXer<x>:FREQuency:STARt.....	166
[SENSe:]MIXer<x>:FREQuency:STOP.....	166
[SENSe:]MIXer<x>:HARMonic:BAND.....	166
[SENSe:]MIXer<x>:HARMonic:BAND:PRESet.....	166
[SENSe:]MIXer<x>:HARMonic:HIGH:STATe.....	167
[SENSe:]MIXer<x>:HARMonic:HIGH[:VALue].....	167
[SENSe:]MIXer<x>:HARMonic:TYPE.....	168
[SENSe:]MIXer<x>:HARMonic[:LOW].....	168
[SENSe:]MIXer<x>:IF?.....	168
[SENSe:]MIXer<x>:LOPower.....	164
[SENSe:]MIXer<x>:LOSS:HIGH.....	169
[SENSe:]MIXer<x>:LOSS:TABLE:HIGH.....	169
[SENSe:]MIXer<x>:LOSS:TABLE[:LOW].....	169
[SENSe:]MIXer<x>:LOSS[:LOW].....	170
[SENSe:]MIXer<x>:PORTs.....	170
[SENSe:]MIXer<x>:RFOVerrange[:STATe].....	170
[SENSe:]MIXer<x>:SIGNal.....	164
[SENSe:]MIXer<x>:THReshold.....	164
[SENSe:]MIXer<x>[:STATe].....	163
[SENSe:]MSRA:CAPTure:OFFSet.....	371
[SENSe:]PMETer<p>:DCYCLe:VALue.....	196
[SENSe:]PMETer<p>:DCYCLe[:STATe].....	196
[SENSe:]PMETer<p>:FREQuency.....	197
[SENSe:]PMETer<p>:FREQuency:LINK.....	197
[SENSe:]PMETer<p>:MTIME.....	197
[SENSe:]PMETer<p>:MTIME:AVERAge:COUNT.....	198
[SENSe:]PMETer<p>:MTIME:AVERAge[:STATe].....	198
[SENSe:]PMETer<p>:ROFFSet[:STATe].....	198
[SENSe:]PMETer<p>:SOFFSet.....	199
[SENSe:]PMETer<p>:TRIGger:DTIME.....	200
[SENSe:]PMETer<p>:TRIGger:HOLDoff.....	201
[SENSe:]PMETer<p>:TRIGger:HYSTeresis.....	201
[SENSe:]PMETer<p>:TRIGger:LEVel.....	201
[SENSe:]PMETer<p>:TRIGger:SLOPe.....	202
[SENSe:]PMETer<p>:TRIGger[:STATe].....	202
[SENSe:]PMETer<p>:UPDate[:STATe].....	199
[SENSe:]PMETer<p>[:STATe].....	199
[SENSe:]PROBe<pb>:ID:PARTnumber?.....	187
[SENSe:]PROBe<pb>:ID:SRNumber?.....	187

[SENSe:]PROBe<pb>:SETup:ATTRatio.....	188
[SENSe:]PROBe<pb>:SETup:CMOffset.....	188
[SENSe:]PROBe<pb>:SETup:DMOffset.....	189
[SENSe:]PROBe<pb>:SETup:MODE.....	189
[SENSe:]PROBe<pb>:SETup:NAME?.....	189
[SENSe:]PROBe<pb>:SETup:NMOFFset.....	190
[SENSe:]PROBe<pb>:SETup:PMODE.....	190
[SENSe:]PROBe<pb>:SETup:PMOffset.....	191
[SENSe:]PROBe<pb>:SETup:STATE?.....	191
[SENSe:]PROBe<pb>:SETup:TYPE?.....	192
[SENSe:]RTMS:CAPTure:OFFSet.....	373
[SENSe:]SWEep:COUNT.....	229
[SENSe:]SWEep[:WINDow<n>]:POINts.....	230
ABORT.....	264
CALCulate<n>:DELTAmarker<m>:AOFF.....	309
CALCulate<n>:DELTAmarker<m>:FUNCTion:AFPHase:RESult?.....	344
CALCulate<n>:DELTAmarker<m>:FUNCTion:AFPHase[:STATE].....	344
CALCulate<n>:DELTAmarker<m>:FUNCTion:BPOwer:MODE.....	342
CALCulate<n>:DELTAmarker<m>:FUNCTion:BPOwer:RESult?.....	343
CALCulate<n>:DELTAmarker<m>:FUNCTion:BPOwer:SPAN.....	343
CALCulate<n>:DELTAmarker<m>:FUNCTion:BPOwer[:STATE].....	343
CALCulate<n>:DELTAmarker<m>:FUNCTion:FIXed:RPOint:MAXimum[:PEAK].....	329
CALCulate<n>:DELTAmarker<m>:FUNCTion:FIXed:RPOint:X.....	329
CALCulate<n>:DELTAmarker<m>:FUNCTion:FIXed:RPOint:Y.....	330
CALCulate<n>:DELTAmarker<m>:FUNCTion:FIXed:RPOint:Y:OFFSet.....	330
CALCulate<n>:DELTAmarker<m>:FUNCTion:FIXed[:STATE].....	330
CALCulate<n>:DELTAmarker<m>:LINK.....	309
CALCulate<n>:DELTAmarker<m>:MAXimum:LEFT.....	327
CALCulate<n>:DELTAmarker<m>:MAXimum:NEXT.....	327
CALCulate<n>:DELTAmarker<m>:MAXimum:RIGHT.....	327
CALCulate<n>:DELTAmarker<m>:MAXimum[:PEAK].....	327
CALCulate<n>:DELTAmarker<m>:MINimum:LEFT.....	328
CALCulate<n>:DELTAmarker<m>:MINimum:NEXT.....	328
CALCulate<n>:DELTAmarker<m>:MINimum:RIGHT.....	328
CALCulate<n>:DELTAmarker<m>:MINimum[:PEAK].....	328
CALCulate<n>:DELTAmarker<m>:MODE.....	310
CALCulate<n>:DELTAmarker<m>:MREFerence.....	310
CALCulate<n>:DELTAmarker<m>:SGRam:FRAMe.....	320
CALCulate<n>:DELTAmarker<m>:SGRam:FRAMe.....	351
CALCulate<n>:DELTAmarker<m>:SGRam:SARea.....	321
CALCulate<n>:DELTAmarker<m>:SGRam:SARea.....	352
CALCulate<n>:DELTAmarker<m>:SGRam:XY:MAXimum[:PEAK].....	321
CALCulate<n>:DELTAmarker<m>:SGRam:XY:MAXimum[:PEAK].....	352
CALCulate<n>:DELTAmarker<m>:SGRam:XY:MINimum[:PEAK].....	321
CALCulate<n>:DELTAmarker<m>:SGRam:XY:MINimum[:PEAK].....	352
CALCulate<n>:DELTAmarker<m>:SGRam:Y:MAXimum:ABOVe.....	321
CALCulate<n>:DELTAmarker<m>:SGRam:Y:MAXimum:ABOVe.....	352
CALCulate<n>:DELTAmarker<m>:SGRam:Y:MAXimum:BELOW.....	322
CALCulate<n>:DELTAmarker<m>:SGRam:Y:MAXimum:BELOW.....	353
CALCulate<n>:DELTAmarker<m>:SGRam:Y:MAXimum:NEXT.....	322



CALCulate<n>:DELTamarker<m>:SGRam:Y:MAXimum:NEXT.....	353
CALCulate<n>:DELTamarker<m>:SGRam:Y:MAXimum[:PEAK].....	322
CALCulate<n>:DELTamarker<m>:SGRam:Y:MAXimum[:PEAK].....	353
CALCulate<n>:DELTamarker<m>:SGRam:Y:MINimum:ABOVe.....	322
CALCulate<n>:DELTamarker<m>:SGRam:Y:MINimum:ABOVe.....	353
CALCulate<n>:DELTamarker<m>:SGRam:Y:MINimum:BELOW.....	323
CALCulate<n>:DELTamarker<m>:SGRam:Y:MINimum:BELOW.....	354
CALCulate<n>:DELTamarker<m>:SGRam:Y:MINimum:NEXT.....	323
CALCulate<n>:DELTamarker<m>:SGRam:Y:MINimum:NEXT.....	354
CALCulate<n>:DELTamarker<m>:SGRam:Y:MINimum[:PEAK].....	323
CALCulate<n>:DELTamarker<m>:SGRam:Y:MINimum[:PEAK].....	354
CALCulate<n>:DELTamarker<m>:SPECTrogram:FRAMe.....	320
CALCulate<n>:DELTamarker<m>:SPECTrogram:FRAMe.....	351
CALCulate<n>:DELTamarker<m>:SPECTrogram:SARea.....	321
CALCulate<n>:DELTamarker<m>:SPECTrogram:SARea.....	352
CALCulate<n>:DELTamarker<m>:SPECTrogram:XY:MAXimum[:PEAK].....	321
CALCulate<n>:DELTamarker<m>:SPECTrogram:XY:MAXimum[:PEAK].....	352
CALCulate<n>:DELTamarker<m>:SPECTrogram:XY:MINimum[:PEAK].....	321
CALCulate<n>:DELTamarker<m>:SPECTrogram:XY:MINimum[:PEAK].....	352
CALCulate<n>:DELTamarker<m>:SPECTrogram:Y:MAXimum:ABOVe.....	321
CALCulate<n>:DELTamarker<m>:SPECTrogram:Y:MAXimum:ABOVe.....	352
CALCulate<n>:DELTamarker<m>:SPECTrogram:Y:MAXimum:BELOW.....	322
CALCulate<n>:DELTamarker<m>:SPECTrogram:Y:MAXimum:BELOW.....	353
CALCulate<n>:DELTamarker<m>:SPECTrogram:Y:MAXimum:NEXT.....	322
CALCulate<n>:DELTamarker<m>:SPECTrogram:Y:MAXimum:NEXT.....	353
CALCulate<n>:DELTamarker<m>:SPECTrogram:Y:MAXimum[:PEAK].....	322
CALCulate<n>:DELTamarker<m>:SPECTrogram:Y:MAXimum[:PEAK].....	353
CALCulate<n>:DELTamarker<m>:SPECTrogram:Y:MINimum:ABOVe.....	322
CALCulate<n>:DELTamarker<m>:SPECTrogram:Y:MINimum:ABOVe.....	353
CALCulate<n>:DELTamarker<m>:SPECTrogram:Y:MINimum:BELOW.....	323
CALCulate<n>:DELTamarker<m>:SPECTrogram:Y:MINimum:BELOW.....	354
CALCulate<n>:DELTamarker<m>:SPECTrogram:Y:MINimum:NEXT.....	323
CALCulate<n>:DELTamarker<m>:SPECTrogram:Y:MINimum:NEXT.....	354
CALCulate<n>:DELTamarker<m>:SPECTrogram:Y:MINimum[:PEAK].....	323
CALCulate<n>:DELTamarker<m>:SPECTrogram:Y:MINimum[:PEAK].....	354
CALCulate<n>:DELTamarker<m>:TRACe.....	311
CALCulate<n>:DELTamarker<m>:X.....	311
CALCulate<n>:DELTamarker<m>:X:RELative?.....	312
CALCulate<n>:DELTamarker<m>:Y?.....	312
CALCulate<n>:DELTamarker<m>[:STATe].....	311
CALCulate<n>:DELTamarker<ms>:LINK:TO:MARKer<md>.....	309
CALCulate<n>:FEED.....	375
CALCulate<n>:FORMat.....	243
CALCulate<n>:LIMit<li>:ACTive?.....	364
CALCulate<n>:LIMit<li>:CLEar[:IMMediate].....	366
CALCulate<n>:LIMit<li>:COMMeNt.....	355
CALCulate<n>:LIMit<li>:CONTRol:DOMain.....	356
CALCulate<n>:LIMit<li>:CONTRol:MODE.....	356
CALCulate<n>:LIMit<li>:CONTRol:OFFSet.....	357
CALCulate<n>:LIMit<li>:CONTRol:SHIFt.....	357

CALCulate<n>:LIMit<li>:CONTRol:SPACing.....	357
CALCulate<n>:LIMit<li>:CONTRol[:DATA].....	355
CALCulate<n>:LIMit<li>:COPY.....	364
CALCulate<n>:LIMit<li>:DELEte.....	364
CALCulate<n>:LIMit<li>:FAIL?.....	367
CALCulate<n>:LIMit<li>:LOWer:MARGin.....	358
CALCulate<n>:LIMit<li>:LOWer:MODE.....	358
CALCulate<n>:LIMit<li>:LOWer:OFFSet.....	359
CALCulate<n>:LIMit<li>:LOWer:SHIFt.....	359
CALCulate<n>:LIMit<li>:LOWer:SPACing.....	359
CALCulate<n>:LIMit<li>:LOWer:STATe.....	359
CALCulate<n>:LIMit<li>:LOWer:THReshold.....	360
CALCulate<n>:LIMit<li>:LOWer[:DATA].....	358
CALCulate<n>:LIMit<li>:NAME.....	360
CALCulate<n>:LIMit<li>:STATe.....	365
CALCulate<n>:LIMit<li>:TRACe<t>:CHECK.....	365
CALCulate<n>:LIMit<li>:UNIT.....	360
CALCulate<n>:LIMit<li>:UPPer:MARGin.....	361
CALCulate<n>:LIMit<li>:UPPer:MODE.....	361
CALCulate<n>:LIMit<li>:UPPer:OFFSet.....	362
CALCulate<n>:LIMit<li>:UPPer:SHIFt.....	362
CALCulate<n>:LIMit<li>:UPPer:SPACing.....	362
CALCulate<n>:LIMit<li>:UPPer:STATe.....	363
CALCulate<n>:LIMit<li>:UPPer:THReshold.....	363
CALCulate<n>:LIMit<li>:UPPer[:DATA].....	361
CALCulate<n>:MARKer<m>:AOFF.....	306
CALCulate<n>:MARKer<m>:FUNCTion:ADEMod:AFRequency[:RESult<t>]?.....	284
CALCulate<n>:MARKer<m>:FUNCTion:ADEMod:AM[:RESult<t>]:RELative?.....	285
CALCulate<n>:MARKer<m>:FUNCTion:ADEMod:AM[:RESult<t>]?.....	285
CALCulate<n>:MARKer<m>:FUNCTion:ADEMod:CARRier[:RESult<t>]?.....	286
CALCulate<n>:MARKer<m>:FUNCTion:ADEMod:DISTortion[:WRITe]:RESult<t>?.....	286
CALCulate<n>:MARKer<m>:FUNCTion:ADEMod:FERRor[:RESult<t>]?.....	287
CALCulate<n>:MARKer<m>:FUNCTion:ADEMod:FM[:RESult<t>]:RELative?.....	285
CALCulate<n>:MARKer<m>:FUNCTion:ADEMod:FM[:RESult<t>]?.....	285
CALCulate<n>:MARKer<m>:FUNCTion:ADEMod:PM[:RESult<t>]:RELative?.....	285
CALCulate<n>:MARKer<m>:FUNCTion:ADEMod:PM[:RESult<t>]?.....	285
CALCulate<n>:MARKer<m>:FUNCTion:ADEMod:SINad:RESult<t>?.....	287
CALCulate<n>:MARKer<m>:FUNCTion:ADEMod:THD:RESult<t>?.....	287
CALCulate<n>:MARKer<m>:FUNCTion:AFPHase:RESult?.....	345
CALCulate<n>:MARKer<m>:FUNCTion:AFPHase[:STATe].....	345
CALCulate<n>:MARKer<m>:FUNCTion:BPOWER:AOFF.....	340
CALCulate<n>:MARKer<m>:FUNCTion:BPOWER:MODE.....	340
CALCulate<n>:MARKer<m>:FUNCTion:BPOWER:RESult?.....	341
CALCulate<n>:MARKer<m>:FUNCTion:BPOWER:SPAN.....	341
CALCulate<n>:MARKer<m>:FUNCTion:BPOWER[:STATe].....	342
CALCulate<n>:MARKer<m>:FUNCTion:FPEaks:ANNotation:LABel[:STATe].....	332
CALCulate<n>:MARKer<m>:FUNCTion:FPEaks:COUNt?.....	332
CALCulate<n>:MARKer<m>:FUNCTion:FPEaks:LIST:SIZE.....	333
CALCulate<n>:MARKer<m>:FUNCTion:FPEaks:SORT.....	333
CALCulate<n>:MARKer<m>:FUNCTion:FPEaks:STATe.....	334

CALCulate<n>:MARKer<m>:FUNction:FPEaks:X?.....	334
CALCulate<n>:MARKer<m>:FUNction:FPEaks:Y?.....	334
CALCulate<n>:MARKer<m>:FUNction:FPEaks[:IMMediate].....	332
CALCulate<n>:MARKer<m>:FUNction:NDBDown.....	336
CALCulate<n>:MARKer<m>:FUNction:NDBDown:FREquency?.....	336
CALCulate<n>:MARKer<m>:FUNction:NDBDown:QFACtor?.....	337
CALCulate<n>:MARKer<m>:FUNction:NDBDown:RESult?.....	337
CALCulate<n>:MARKer<m>:FUNction:NDBDown:STATe.....	338
CALCulate<n>:MARKer<m>:FUNction:NDBDown:TIME?.....	338
CALCulate<n>:MARKer<m>:FUNction:PNOise:AOff.....	339
CALCulate<n>:MARKer<m>:FUNction:PNOise:RESult?.....	340
CALCulate<n>:MARKer<m>:FUNction:PNOise[:STATe].....	339
CALCulate<n>:MARKer<m>:FUNction:REFerence.....	217
CALCulate<n>:MARKer<m>:LINK.....	313
CALCulate<n>:MARKer<m>:MAXimum:LEFT.....	325
CALCulate<n>:MARKer<m>:MAXimum:NEXT.....	325
CALCulate<n>:MARKer<m>:MAXimum:RIGHT.....	325
CALCulate<n>:MARKer<m>:MAXimum[:PEAK].....	325
CALCulate<n>:MARKer<m>:MINimum:LEFT.....	326
CALCulate<n>:MARKer<m>:MINimum:NEXT.....	326
CALCulate<n>:MARKer<m>:MINimum:RIGHT.....	326
CALCulate<n>:MARKer<m>:MINimum[:PEAK].....	326
CALCulate<n>:MARKer<m>:PEXCursion.....	324
CALCulate<n>:MARKer<m>:SGRam:FRAMe.....	316
CALCulate<n>:MARKer<m>:SGRam:FRAMe.....	347
CALCulate<n>:MARKer<m>:SGRam:SARea.....	316
CALCulate<n>:MARKer<m>:SGRam:SARea.....	347
CALCulate<n>:MARKer<m>:SGRam:XY:MAXimum[:PEAK].....	317
CALCulate<n>:MARKer<m>:SGRam:XY:MAXimum[:PEAK].....	348
CALCulate<n>:MARKer<m>:SGRam:XY:MINimum[:PEAK].....	317
CALCulate<n>:MARKer<m>:SGRam:XY:MINimum[:PEAK].....	348
CALCulate<n>:MARKer<m>:SGRam:Y:MAXimum:ABOVe.....	317
CALCulate<n>:MARKer<m>:SGRam:Y:MAXimum:ABOVe.....	348
CALCulate<n>:MARKer<m>:SGRam:Y:MAXimum:BELow.....	317
CALCulate<n>:MARKer<m>:SGRam:Y:MAXimum:BELow.....	348
CALCulate<n>:MARKer<m>:SGRam:Y:MAXimum:NEXT.....	317
CALCulate<n>:MARKer<m>:SGRam:Y:MAXimum:NEXT.....	348
CALCulate<n>:MARKer<m>:SGRam:Y:MAXimum[:PEAK].....	318
CALCulate<n>:MARKer<m>:SGRam:Y:MAXimum[:PEAK].....	349
CALCulate<n>:MARKer<m>:SGRam:Y:MINimum:ABOVe.....	318
CALCulate<n>:MARKer<m>:SGRam:Y:MINimum:ABOVe.....	349
CALCulate<n>:MARKer<m>:SGRam:Y:MINimum:BELow.....	318
CALCulate<n>:MARKer<m>:SGRam:Y:MINimum:BELow.....	349
CALCulate<n>:MARKer<m>:SGRam:Y:MINimum:NEXT.....	319
CALCulate<n>:MARKer<m>:SGRam:Y:MINimum:NEXT.....	350
CALCulate<n>:MARKer<m>:SGRam:Y:MINimum[:PEAK].....	319
CALCulate<n>:MARKer<m>:SGRam:Y:MINimum[:PEAK].....	350
CALCulate<n>:MARKer<m>:SPECTrogram:FRAMe.....	316
CALCulate<n>:MARKer<m>:SPECTrogram:FRAMe.....	347
CALCulate<n>:MARKer<m>:SPECTrogram:SARea.....	316

CALCulate<n>:MARKer<m>:SPECTrogram:SARea.....	347
CALCulate<n>:MARKer<m>:SPECTrogram:XY:MAXimum[:PEAK].....	317
CALCulate<n>:MARKer<m>:SPECTrogram:XY:MAXimum[:PEAK].....	348
CALCulate<n>:MARKer<m>:SPECTrogram:XY:MINimum[:PEAK].....	317
CALCulate<n>:MARKer<m>:SPECTrogram:XY:MINimum[:PEAK].....	348
CALCulate<n>:MARKer<m>:SPECTrogram:Y:MAXimum:ABOVE.....	317
CALCulate<n>:MARKer<m>:SPECTrogram:Y:MAXimum:ABOVE.....	348
CALCulate<n>:MARKer<m>:SPECTrogram:Y:MAXimum:BELOW.....	317
CALCulate<n>:MARKer<m>:SPECTrogram:Y:MAXimum:BELOW.....	348
CALCulate<n>:MARKer<m>:SPECTrogram:Y:MAXimum:NEXT.....	317
CALCulate<n>:MARKer<m>:SPECTrogram:Y:MAXimum:NEXT.....	348
CALCulate<n>:MARKer<m>:SPECTrogram:Y:MAXimum[:PEAK].....	318
CALCulate<n>:MARKer<m>:SPECTrogram:Y:MAXimum[:PEAK].....	349
CALCulate<n>:MARKer<m>:SPECTrogram:Y:MINimum:ABOVE.....	318
CALCulate<n>:MARKer<m>:SPECTrogram:Y:MINimum:ABOVE.....	349
CALCulate<n>:MARKer<m>:SPECTrogram:Y:MINimum:BELOW.....	318
CALCulate<n>:MARKer<m>:SPECTrogram:Y:MINimum:BELOW.....	349
CALCulate<n>:MARKer<m>:SPECTrogram:Y:MINimum:NEXT.....	319
CALCulate<n>:MARKer<m>:SPECTrogram:Y:MINimum:NEXT.....	350
CALCulate<n>:MARKer<m>:SPECTrogram:Y:MINimum[:PEAK].....	319
CALCulate<n>:MARKer<m>:SPECTrogram:Y:MINimum[:PEAK].....	350
CALCulate<n>:MARKer<m>:TRACe.....	308
CALCulate<n>:MARKer<m>:X.....	308
CALCulate<n>:MARKer<m>:X:SSIZe.....	313
CALCulate<n>:MARKer<m>:Y?.....	308
CALCulate<n>:MARKer<m>[:STATe].....	307
CALCulate<n>:MARKer<ms>:LINK:TO:MARKer<md>.....	307
CALCulate<n>:MSRA:ALINe:SHOW.....	370
CALCulate<n>:MSRA:ALINe[:VALue].....	371
CALCulate<n>:MSRA:WINDow<n>:IVAL.....	371
CALCulate<n>:PMETer<p>:RELative:STATe.....	195
CALCulate<n>:PMETer<p>:RELative[:MAGNitude].....	195
CALCulate<n>:PMETer<p>:RELative[:MAGNitude]:AUTO ONCE.....	195
CALCulate<n>:RTMS:ALINe:SHOW.....	372
CALCulate<n>:RTMS:ALINe[:VALue].....	372
CALCulate<n>:RTMS:WINDow<n>:IVAL.....	373
CALCulate<n>:SGRam:CLear[:IMMediate].....	292
CALCulate<n>:SGRam:CONTInuous.....	293
CALCulate<n>:SGRam:FRAMe:COUNT.....	293
CALCulate<n>:SGRam:FRAMe:SELeCt.....	294
CALCulate<n>:SGRam:HDEPth.....	294
CALCulate<n>:SGRam:LAYout.....	294
CALCulate<n>:SGRam:THReedim[:STATe].....	295
CALCulate<n>:SGRam:TRACe.....	296
CALCulate<n>:SGRam:TSTamp:DATA?.....	296
CALCulate<n>:SGRam:TSTamp[:STATe].....	297
CALCulate<n>:SGRam[:STATe].....	295
CALCulate<n>:SPECTrogram:CLear[:IMMediate].....	292
CALCulate<n>:SPECTrogram:CONTInuous.....	293
CALCulate<n>:SPECTrogram:FRAMe:COUNT.....	293

CALCulate<n>:SPECTrogram:FRAMe:SElect.....	294
CALCulate<n>:SPECTrogram:HDEPth.....	294
CALCulate<n>:SPECTrogram:LAYout.....	294
CALCulate<n>:SPECTrogram:THReedim[:STATe].....	295
CALCulate<n>:SPECTrogram:TRACe.....	296
CALCulate<n>:SPECTrogram:TSTamp:DATA?.....	296
CALCulate<n>:SPECTrogram:TSTamp[:STATe].....	297
CALCulate<n>:SPECTrogram[:STATe].....	295
CALCulate<n>:UNIT:ANGLE.....	255
CALCulate<n>:UNIT:POWER.....	217
CALCulate<n>:UNIT:THD.....	255
CALibration:AIQ:HATiming[:STATe].....	184
CALibration:PMETer<p>:ZERO:AUTO ONCE.....	194
CONFigure:ADEMod:RESults:AM:DETEctor<det>:MODE.....	257
CONFigure:ADEMod:RESults:AM:DETEctor<det>:REFerence.....	256
CONFigure:ADEMod:RESults:AM:DETEctor<det>:REFerence:MEASStoref<t>.....	257
CONFigure:ADEMod:RESults:AM:DETEctor<det>:STATe.....	256
CONFigure:ADEMod:RESults:FM:DETEctor<det>:MODE.....	257
CONFigure:ADEMod:RESults:FM:DETEctor<det>:REFerence.....	256
CONFigure:ADEMod:RESults:FM:DETEctor<det>:REFerence:MEASStoref<t>.....	257
CONFigure:ADEMod:RESults:FM:DETEctor<det>:STATe.....	256
CONFigure:ADEMod:RESults:PM:DETEctor<det>:MODE.....	257
CONFigure:ADEMod:RESults:PM:DETEctor<det>:REFerence.....	256
CONFigure:ADEMod:RESults:PM:DETEctor<det>:REFerence:MEASStoref<t>.....	257
CONFigure:ADEMod:RESults:PM:DETEctor<det>:STATe.....	256
CONFigure:ADEMod:RESults:UNIT.....	258
DIAGnostic:SERVice:NSOURce.....	211
DISPlay:FORMat.....	269
DISPlay[:WINDow<n>]:MINFo[:STATe].....	314
DISPlay[:WINDow<n>]:MTABLE.....	314
DISPlay[:WINDow<n>]:SGRam:COLor:DEFault.....	297
DISPlay[:WINDow<n>]:SGRam:COLor:LOWer.....	298
DISPlay[:WINDow<n>]:SGRam:COLor:SHAPE.....	298
DISPlay[:WINDow<n>]:SGRam:COLor:UPPer.....	298
DISPlay[:WINDow<n>]:SGRam:COLor[:STYLe].....	299
DISPlay[:WINDow<n>]:SIZE.....	270
DISPlay[:WINDow<n>]:SPECTrogram:COLor:DEFault.....	297
DISPlay[:WINDow<n>]:SPECTrogram:COLor:LOWer.....	298
DISPlay[:WINDow<n>]:SPECTrogram:COLor:SHAPE.....	298
DISPlay[:WINDow<n>]:SPECTrogram:COLor:UPPer.....	298
DISPlay[:WINDow<n>]:SPECTrogram:COLor[:STYLe].....	299
DISPlay[:WINDow<n>][:SUBWIndow<w>]:TRACe<t>:MODE.....	300
DISPlay[:WINDow<n>][:SUBWIndow<w>]:TRACe<t>:MODE:HCONTinuous.....	301
DISPlay[:WINDow<n>][:SUBWIndow<w>]:TRACe<t>:SElect.....	301
DISPlay[:WINDow<n>][:SUBWIndow<w>]:TRACe<t>:Y:SPACing.....	225
DISPlay[:WINDow<n>][:SUBWIndow<w>]:TRACe<t>:Y[:SCALE].....	223
DISPlay[:WINDow<n>][:SUBWIndow<w>]:TRACe<t>:Y[:SCALE]:AUTO ONCE.....	223
DISPlay[:WINDow<n>][:SUBWIndow<w>]:TRACe<t>:Y[:SCALE]:MODE.....	223
DISPlay[:WINDow<n>][:SUBWIndow<w>]:TRACe<t>:Y[:SCALE]:PDIVision.....	224
DISPlay[:WINDow<n>][:SUBWIndow<w>]:TRACe<t>:Y[:SCALE]:RLEVEL.....	217

DISPlay[:WINDow<n>][:SUBWindow<w>]:TRACe<t>:Y[:SCALe]:RLEVel:OFFSet.....	218
DISPlay[:WINDow<n>][:SUBWindow<w>]:TRACe<t>:Y[:SCALe]:RPOStion.....	224
DISPlay[:WINDow<n>][:SUBWindow<w>]:TRACe<t>:Y[:SCALe]:RVALue.....	254
DISPlay[:WINDow<n>][:SUBWindow<w>]:TRACe<t>[:STATe].....	302
EXPort:WAVEform:DISPlayoff.....	177
FETCh:PMETer<p>?.....	196
FORMat:DEXPort:CSEParator.....	281
FORMat:DEXPort:DSEParator.....	282
FORMat:DEXPort:FORMat.....	280
FORMat:DEXPort:HEADer.....	282
FORMat:DEXPort:TRACes.....	282
FORMat[:DATA].....	279
INITiate:SEQuencer:ABORT.....	267
INITiate:SEQuencer:IMMediate.....	267
INITiate:SEQuencer:MODE.....	267
INITiate:SEQuencer:REFResh[:ALL].....	268
INITiate<n>:CONMeas.....	265
INITiate<n>:CONTinuous.....	266
INITiate<n>:REFResh.....	267
INITiate<n>[:IMMediate].....	266
INPut:ATTenuation.....	218
INPut:ATTenuation:AUTO.....	219
INPut:ATTenuation:AUTO:MODE.....	219
INPut:ATTenuation:PROTection:RESet.....	157
INPut:CONNector.....	157
INPut:COUPling.....	157
INPut:DIQ:CDEvice.....	185
INPut:DIQ:RANGe:COUPling.....	185
INPut:DIQ:RANGe[:UPPer].....	186
INPut:DIQ:RANGe[:UPPer]:AUTO.....	186
INPut:DIQ:RANGe[:UPPer]:UNIT.....	186
INPut:DIQ:SRATe.....	186
INPut:DIQ:SRATe:AUTO.....	186
INPut:DPATH.....	158
INPut:EATT.....	220
INPut:EATT:AUTO.....	220
INPut:EATT:STATe.....	220
INPut:EGAIN[:STATe].....	221
INPut:FILE:PATH.....	160
INPut:FILTer:HPASS[:STATe].....	158
INPut:FILTer:YIG[:STATe].....	158
INPut:GAIN:STATe.....	222
INPut:GAIN[:VALue].....	222
INPut:IMPedance.....	159
INPut:IQ:BALanced[:STATe].....	182
INPut:IQ:FULLscale:AUTO.....	183
INPut:IQ:FULLscale[:LEVel].....	183
INPut:IQ:IMPedance.....	183
INPut:IQ:TYPE.....	184
INPut:SElect.....	159

INPut:TYPE.....	160
INSTrument:CREate:DUPLicate.....	151
INSTrument:CREate:REPLace.....	151
INSTrument:CREate[:NEW].....	151
INSTrument:DELeTe.....	152
INSTrument:LIST?.....	152
INSTrument:REName.....	154
INSTrument[:SElect].....	154
LAYout:ADD[:WINDow]?.....	270
LAYout:CATalog[:WINDow]?.....	272
LAYout:IDENtify[:WINDow]?.....	272
LAYout:MOVE[:WINDow].....	273
LAYout:REMove[:WINDow].....	273
LAYout:REPLace[:WINDow].....	273
LAYout:SPLitter.....	274
LAYout:WINDow<n>:ADD?.....	275
LAYout:WINDow<n>:IDENtify?.....	276
LAYout:WINDow<n>:REMove.....	276
LAYout:WINDow<n>:REPLace.....	276
LAYout:WINDow<n>:TYPE.....	277
MMEMory:LOAD:IQ:STATe.....	374
MMEMory:LOAD:IQ:STReam.....	161
MMEMory:LOAD:IQ:STReam:AUTO.....	162
MMEMory:LOAD:IQ:STReam:LIST?.....	162
MMEMory:LOAD<n>:LIMit.....	366
MMEMory:STORe<n>:IQ:COMMeNt.....	374
MMEMory:STORe<n>:IQ:FORMat.....	374
MMEMory:STORe<n>:IQ:STATe.....	375
MMEMory:STORe<n>:LIMit.....	366
MMEMory:STORe<n>:LIST.....	335
MMEMory:STORe<n>:PEAK.....	335
MMEMory:STORe<n>:SPECTrogram.....	283
MMEMory:STORe<n>:TRACe.....	283
OUTPut:ADEMod[:ONLine]:AF[:CFRequency].....	212
OUTPut:ADEMod[:ONLine]:PHONes.....	212
OUTPut:ADEMod[:ONLine]:SOURce.....	212
OUTPut:ADEMod[:ONLine][:STATe].....	211
OUTPut:IQHS:CDEVice?.....	214
OUTPut:IQHS:MARKer.....	214
OUTPut:IQHS:SRATe?.....	214
OUTPut:IQHS[:STATe].....	214
OUTPut:TRIGger<tp>:DIRection.....	238
OUTPut:TRIGger<tp>:LEVel.....	239
OUTPut:TRIGger<tp>:OTYPe.....	239
OUTPut:TRIGger<tp>:PULSe:IMMeDiate.....	240
OUTPut:TRIGger<tp>:PULSe:LENGth.....	240
READ:PMETer<p>?.....	196
SOURce<si>:EXTeRnal<gen>:FREQUency.....	203
SOURce<si>:EXTeRnal<gen>:FREQUency:COUPLing[:STATe].....	203
SOURce<si>:EXTeRnal<gen>:FREQUency:OFFSet.....	205



SOURce<si>:EXTernal<gen>:FREQuency[:FACTor]:DENominator.....	204
SOURce<si>:EXTernal<gen>:FREQuency[:FACTor]:NUMerator.....	204
SOURce<si>:EXTernal<gen>:POWer[:LEVel].....	205
SOURce<si>:EXTernal<gen>:ROSCillator[:SOURce].....	206
SOURce<si>:EXTernal<gen>[:STATE].....	206
SOURce<si>:POWer[:LEVel][:IMMediate]:OFFSet.....	206
SYSTem:COMMunicate:GPIB:RDEvice:GENerator<gen>:ADDRes.....	207
SYSTem:COMMunicate:RDEvice:GENerator<gen>:INTerface.....	207
SYSTem:COMMunicate:RDEvice:GENerator<gen>:LINK.....	207
SYSTem:COMMunicate:RDEvice:GENerator<gen>:TYPE.....	208
SYSTem:COMMunicate:RDEvice:OSCilloscope:ALIGnment:DATE.....	179
SYSTem:COMMunicate:RDEvice:OSCilloscope:ALIGnment:FALignment.....	179
SYSTem:COMMunicate:RDEvice:OSCilloscope:ALIGnment:STEP<st>[:STATE].....	178
SYSTem:COMMunicate:RDEvice:OSCilloscope:IDN.....	179
SYSTem:COMMunicate:RDEvice:OSCilloscope:LEDState.....	179
SYSTem:COMMunicate:RDEvice:OSCilloscope:PSMMode[:STATE].....	180
SYSTem:COMMunicate:RDEvice:OSCilloscope:SRATe.....	180
SYSTem:COMMunicate:RDEvice:OSCilloscope:TCPIP.....	181
SYSTem:COMMunicate:RDEvice:OSCilloscope:VDEvice?.....	181
SYSTem:COMMunicate:RDEvice:OSCilloscope:VFIRmware?.....	181
SYSTem:COMMunicate:RDEvice:OSCilloscope[:STATE].....	178
SYSTem:COMMunicate:RDEvice:PMETer<p>:CONFigure:AUTO[:STATE].....	193
SYSTem:COMMunicate:RDEvice:PMETer<p>:COUNT?.....	193
SYSTem:COMMunicate:RDEvice:PMETer<p>:DEFine.....	193
SYSTem:COMMunicate:TCPIP:RDEvice:GENerator<gen>:ADDRes.....	208
SYSTem:PRESet:CHANnel[:EXEC].....	154
SYSTem:SEQuencer.....	268
SYSTem:SPEaker:VOLume.....	213
TRACe:IQ:FILE:REPetition:COUNT.....	162
TRACe<n>[:DATA].....	280
TRIGger[:SEQuence]:DTIME.....	231
TRIGger[:SEQuence]:HOLDoff[:TIME].....	231
TRIGger[:SEQuence]:IFPower:HOLDoff.....	231
TRIGger[:SEQuence]:IFPower:HYSteresis.....	232
TRIGger[:SEQuence]:LEVel:AM:RELative.....	234
TRIGger[:SEQuence]:LEVel:AM[:ABSolute].....	234
TRIGger[:SEQuence]:LEVel:BBPower.....	232
TRIGger[:SEQuence]:LEVel:FM.....	234
TRIGger[:SEQuence]:LEVel:IFPower.....	233
TRIGger[:SEQuence]:LEVel:IQPower.....	233
TRIGger[:SEQuence]:LEVel:PM.....	235
TRIGger[:SEQuence]:LEVel:RFPower.....	233
TRIGger[:SEQuence]:LEVel[:EXTernal<port>].....	232
TRIGger[:SEQuence]:OSCilloscope:COUPLing.....	182
TRIGger[:SEQuence]:SLOPe.....	235
TRIGger[:SEQuence]:SOURce.....	235
TRIGger[:SEQuence]:TIME:RINTerval.....	238
UNIT<n>:ANGLE.....	255
UNIT<n>:PMETer<p>:POWer.....	200
UNIT<n>:PMETer<p>:POWer:RATIo.....	200



UNIT<n>:POWer.....	217
UNIT<n>:THD.....	255

# Index

## Symbols

\*OPC ..... 230

## A

A weighted filter  
 AF filters ..... 75

Aborting  
 Sweep ..... 63, 64, 103

AC/DC coupling ..... 29, 43, 68, 78, 89

Activating  
 Analog Modulation Analysis (remote) ..... 150

AF ..... 15

AF Auto Scale  
 Y-axis ..... 79, 93

AF center  
 Demodulation spectrum ..... 71

AF CF ..... 13

AF coupling ..... 68, 78, 89

AF filters ..... 30  
 A weighted ..... 75  
 CCIR ..... 75  
 CCITT ..... 75  
 Configuration ..... 73  
 Deactivating ..... 76  
 Deemphasis ..... 76  
 High pass ..... 74  
 Low pass ..... 75  
 Weighting ..... 75

AF full span  
 Demodulation spectrum ..... 72

AF span  
 Demodulation spectrum ..... 71  
 Displayed ..... 13  
 Remote control ..... 246

AF spectrum ..... 70

AF start  
 Demodulation spectrum ..... 71

AF stop  
 Demodulation spectrum ..... 71

AF trigger ..... 30, 32

All Functions Off ..... 132

AM (Offline)  
 Softkey ..... 56

AM Spectrum  
 Evaluation method ..... 18

AM Time Domain  
 Evaluation method ..... 15

Amplitude  
 Configuration ..... 45  
 Scaling ..... 81  
 Settings ..... 45

Analog Baseband  
 Input ..... 44

Analog Modulation Analysis  
 Measurement examples ..... 138  
 Output ..... 89  
 Output settings ..... 88

Analysis  
 Marker functions ..... 120  
 Remote control ..... 291  
 Settings ..... 96

Analysis interval  
 Configuration (MSRA, remote) ..... 370, 372  
 MSRA/MSRT ..... 61, 226

Analysis line ..... 35  
 Configuration ..... 133  
 Configuration (MSRA, remote) ..... 370, 372

Application cards ..... 9

Application notes ..... 9

AQT  
 see Measurement time ..... 12

ASCII trace export ..... 289

Attenuation  
 Auto ..... 48  
 Displayed ..... 12  
 Electronic ..... 48  
 Manual ..... 48  
 Option ..... 48  
 Protective (remote) ..... 157

Audio demodulation  
 Volume (remote control) ..... 213

Audio frequency  
 see AF ..... 15

Auto adjustment  
 Triggered measurement ..... 263

Auto all ..... 93

Auto frequency ..... 93

Auto ID  
 External Mixer (remote) ..... 164  
 Threshold (External Mixer, remote control) ..... 164

Auto level  
 Hysteresis ..... 94, 95  
 Reference level ..... 47, 94  
 Softkey ..... 47, 94

Auto scaling ..... 79, 80, 93

Auto settings  
 MeasTime Auto ..... 94  
 MeasTime Manual ..... 94

Average count ..... 65, 99

Average mode  
 Traces ..... 99

Averaging  
 Traces (remote control) ..... 304

## B

B2000  
 Remote commands ..... 177

Band  
 External Mixer (remote) ..... 166

Band power measurement  
 Activating/Deactivating ..... 131  
 Deactivating ..... 132  
 Power mode ..... 131  
 Span ..... 131

Band power measurement (remote control) ..... 340

Bandwidth settings ..... 61

BB Power  
 Trigger (softkey) ..... 55

Bias  
 External Mixer (remote) ..... 163

Brochures ..... 8

**C**

Calibration	
External generator, remote	208
Capture offset	
MSRA / MSRT secondary applications	62
MSRT secondary applications	62
Remote	371, 373
Softkey	62
Capturing	
I/Q data (remote)	264
Carrier	
Offset	24, 29
Power	24
CCIR filter	
AF filters	75
CCITT filter	
AF filters	75
Center frequency	50, 72
Automatic configuration	93
Displayed	12, 13
Softkey	50, 72
Step size	51
Channel	
Creating (remote)	151
Deleting (remote)	152
Duplicating (remote)	151
Querying (remote)	152
Renaming (remote)	154
Replacing (remote)	151
Closing	
Channels (remote)	152
Windows (remote)	276
Color curve	
Shape	105
Color mapping	
Color curve	105
Color range	105
Color scheme	105
Softkey	103
Spectrograms	103, 104
Color scheme	
Spectrogram	105
Conditions	
Measurement	27
Configuration	
Measurement (remote)	155
Procedure	38
Continue single sweep	
Softkey	64
Continuous sweep	
Softkey	63, 103
Conventions	
SCPI commands	146
Conversion loss	
External Mixer (remote)	169, 170
Conversion loss tables	
Available (remote)	172
Band (remote)	171
Bias (remote)	171
Deleting (remote)	172
External Mixer (remote)	169
Harmonic order (remote)	173
Mixer type (remote)	174
Selecting (remote)	174
Copying	
Channel (remote)	151

Coupling	
Trigger	58

**D**

Data acquisition	
MSRA/MSRT	61, 226
Remote control	225
Settings	61
Data format	
ASCII	288
Binary	288
Remote	282
Data sheets	8
DB per division	
Scaling	77
DBW	
see Demodulation bandwidth	12
DC offset	
Analog Baseband (B71, remote control)	184
Decimal separator	
Trace export	107, 108
Deemphasis filter	
AF filters	76
Remote control	250
Deleting	
Settings files	40
Standards	40
Delta markers	111
Defining	111
Demodulation	
AF spectrum	70
Configuration	67
Display	66
Filter types	30, 62
Process	27
Relative (remote control)	257
Relative (remote)	256
RF spectrum	72
Scaling	73, 77
Settings	67
Spectrum	70
Spectrum (Result Summary)	72
Units	81
Demodulation bandwidth	61, 73
Conditions	29
Deemphasis filter	76
Displayed	12
Maximum	30
Remote control	228
Troubleshooting	143
Detectors	
Relative demodulation	257
Relative demodulation (remote)	256
Remote control	256, 305
Trace	98
Dev per division	
Scaling	77
Deviation	
Scaling	79
Diagram footer information	13
Digital Baseband	
Output settings	91
Digital I/Q	
Connection information	92
Enhanced mode	55

- Output settings information ..... 91
- Triggering ..... 55
- Digital I/Q 40G
  - Output settings ..... 90
- Digital I/Q 40G Streaming Out ..... 91
  - Connected instrument ..... 92
- Digital output
  - Enabling ..... 91
- Direct path
  - Input configuration ..... 43
- Display configuration
  - Softkey ..... 66
- Drop-out time
  - Trigger ..... 58
- Duplicating
  - Channel (remote) ..... 151
- E**
- Electronic input attenuation ..... 48
- Enhanced mode
  - Digital I/Q ..... 55
- Errors
  - IF OVLD ..... 46
- Evaluation
  - Data basis ..... 15
  - Methods ..... 15
- Evaluation methods
  - Remote ..... 270
- Examples
  - Remote control ..... 376
- Export format
  - Traces ..... 289
- Exporting
  - I/Q data ..... 34, 134
  - I/Q data (remote) ..... 373
  - Measurement settings ..... 106
  - Peak list ..... 128
  - Trace data ..... 136
  - Traces ..... 105, 107, 109
- External generator
  - Remote control ..... 202
- External Mixer
  - Activating (remote) ..... 163
  - Band ..... 166
  - Programming example ..... 175
  - RF overrange ..... 170
  - Type ..... 170
- External trigger ..... 53, 54
  - Level (remote) ..... 232
- F**
- File format
  - Export Files ..... 289
  - Trace export ..... 289
- filename
  - Settings ..... 40
- Filters
  - A weighted (AF) ..... 75
  - AF ..... 73
  - CCIR (AF) ..... 75
  - CCITT (AF) ..... 75
  - Demodulation ..... 29, 30, 62
  - High pass (AF) ..... 74
  - High-pass (RF input) ..... 44
  - Low pass (AF) ..... 75
  - Weighting (AF) ..... 75
  - YIG (remote) ..... 158
- Fixed reference
  - Defining ..... 114
  - Remote control ..... 329
- FM (Offline)
  - Softkey ..... 56
- FM Spectrum
  - Evaluation method ..... 19
- FM Time Domain
  - Evaluation method ..... 16
- Format
  - Data ..... 288
  - Data (remote) ..... 282
  - see also File format ..... 289
- Frame count
  - Softkey ..... 66
- Free Run
  - Trigger ..... 53
- Frequency
  - Configuration ..... 70
  - Deemphasis filter ..... 76
  - Deviation ..... 29
  - Deviation, scaling ..... 77
  - Remote control ..... 215
  - Settings ..... 50
  - Span ..... 73
- Frontend settings ..... 41
- G**
- Getting started ..... 7
- H**
- Handover frequency
  - External Mixer (remote) ..... 165
- Hardware settings
  - Displayed ..... 12
- Harmonics
  - External Mixer (remote) ..... 168
- High pass filter
  - AF filters ..... 74
- High-pass filter
  - RF input ..... 44
- History
  - Spectrograms ..... 102
- History Depth
  - Softkey ..... 102
- Hold
  - Trace setting ..... 98
- Hysteresis
  - Lower (Auto level) ..... 95
  - Trigger ..... 57
  - Upper (Auto level) ..... 94
- I**
- I/Q data
  - Exporting (remote) ..... 373
  - Importing (remote) ..... 373
  - Importing/Exporting ..... 34, 134
- I/Q Power
  - Trigger ..... 54
  - Trigger level (remote) ..... 233

- IF Power
  - Trigger ..... 54
  - Trigger level (remote) ..... 233
- Impedance
  - Setting ..... 43
- Importing
  - I/Q data ..... 34, 134
  - I/Q data (remote) ..... 373
- Input
  - Coupling ..... 43
  - Overload (remote) ..... 157
  - RF ..... 43
  - Settings ..... 41, 49
  - Source Configuration (softkey) ..... 41
  - Source, Radio frequency (RF) ..... 42
- Input sources ..... 41
- Instrument security procedures ..... 8
- K**
- Keys
  - MKR ..... 109
  - MKR -> ..... 114, 115
  - MKR FUNCT ..... 120
  - Peak Search ..... 116
  - RUN CONT ..... 63, 103
  - RUN SINGLE ..... 64, 103
- L**
- Limit check
  - Remote control ..... 354
- Limit lines
  - Remote control ..... 355
- Linking
  - Markers ..... 111, 114
- LO feedthrough ..... 43
- Loading
  - Settings files ..... 40
- Low pass filter
  - AF filters ..... 75
- Lower Level Hysteresis ..... 95
- M**
- Marker
  - Search area (softkey) ..... 119
  - Search type (softkey) ..... 119
- Marker functions
  - Deactivating ..... 132
  - Remote control ..... 329
- Marker peak list
  - see Peak list ..... 128
- Marker table
  - Evaluation method ..... 25
- Marker to Trace ..... 112
- Markers
  - Assigned trace ..... 112
  - Band power (remote control) ..... 340
  - Basic settings ..... 109
  - Configuration ..... 109, 112
  - Configuration (remote control) ..... 306
  - Deactivating ..... 112
  - Delta markers ..... 111
  - Fixed reference (remote control) ..... 313, 329
  - Function configuration ..... 120
  - Linked in AF spectrum display ..... 114
  - Linked in time domain ..... 114
  - Linking ..... 111
  - Minimum ..... 117
  - Minimum (remote control) ..... 324
  - n dB down ..... 122
  - n dB down (remote control) ..... 335
  - Next minimum ..... 117
  - Next minimum (remote control) ..... 324
  - Next peak ..... 116
  - Next peak (remote control) ..... 324
  - Peak ..... 116
  - Peak (remote control) ..... 324
  - Peak list (remote control) ..... 331
  - Phase noise measurement ..... 122
  - Phase noise measurement (remote control) ..... 339
  - Position ..... 111
  - Positioning ..... 115
  - Positioning (remote control) ..... 306
  - Remote control ..... 306
  - Search settings (remote) ..... 323
  - Setting up (remote control) ..... 306
  - Spectrograms (remote control) ..... 315, 346
  - State ..... 110
  - Step size ..... 113
  - Step size (remote control) ..... 313
  - Table ..... 113
  - Table (evaluation method) ..... 25
  - Table (remote control) ..... 313
  - Type ..... 111
  - X-value ..... 111
- Maximizing
  - Windows (remote) ..... 270, 296
- Measurement examples
  - Analogue Modulation Analysis ..... 138
- Measurement time ..... 62, 65
  - Auto settings ..... 94
  - Displayed ..... 12
  - Effects ..... 31
  - Value range ..... 30
- Minimum ..... 117
  - Marker positioning ..... 117
  - Next ..... 117
- MKR
  - Key ..... 109
- MKR ->
  - Key ..... 114, 115
- MKR FUNCT
  - Key ..... 120
- Modulation
  - Depth ..... 24
  - Depth, scaling ..... 77
  - Frequency ..... 24, 29
- MSRA
  - Analysis interval ..... 226
  - Operating mode ..... 34
  - Restriction ..... 264
- MSRA secondary applications
  - Capture offset (remote) ..... 371
- MSRA/MSRT
  - Analysis interval ..... 61
- MSRT
  - Analysis interval ..... 226
  - Operating mode ..... 34
  - Restriction ..... 264
- MSRT secondary applications
  - Capture offset ..... 62
  - Capture offset (remote) ..... 373

- Multiple
  - Channels ..... 11
- N**
- n dB down
  - Delta value ..... 122
  - Marker ..... 122
  - Remote control ..... 335
- Next Minimum ..... 117
  - Marker positioning ..... 117
- Next Mode X
  - Softkey ..... 118
- Next Mode Y
  - Softkey ..... 118
- Next Peak ..... 116
  - Marker positioning ..... 116
- Noise
  - Source ..... 87
- O**
- Offset
  - Analysis interval ..... 62
  - Reference level ..... 47
- Options
  - Electronic attenuation ..... 48
  - High-pass filter ..... 44
  - Preamplifier ..... 49
- Oscilloscopes
  - Remote commands (B2000) ..... 177
- Output
  - Analog Modulation Analysis ..... 88, 89
  - Analog Modulation Analysis (remote) ..... 211, 212
  - Configuration ..... 87
  - Digital Baseband settings ..... 91
  - Digital I/Q 40G settings ..... 90
  - Noise source ..... 87
  - Settings ..... 87
  - Trigger ..... 59
- Overload
  - RF input (remote) ..... 157
- Overview
  - Configuration K7 ..... 37
  - Softkey ..... 37
- P**
- Peak excursion ..... 115, 119, 125, 128
- Peak list ..... 126
  - Configuring ..... 125
  - Displaying ..... 125
  - Evaluation method ..... 25
  - Exporting ..... 128
  - Marker numbers ..... 128
  - Maximum number of peaks ..... 128
  - Peak excursion ..... 115, 119, 128
  - Remote control ..... 331
  - Sort mode ..... 128
  - State ..... 128
- Peak search
  - Area (spectrograms) ..... 119
  - Automatic ..... 126
  - Excursion ..... 125
  - Key ..... 116
  - Limits ..... 125
  - List ..... 126
  - Mode ..... 115, 118
  - Mode (spectrograms) ..... 117, 118
  - Reference marker ..... 114
  - Type (spectrograms) ..... 119
- Peaks
  - Marker positioning ..... 116
  - Next ..... 116
  - Softkey ..... 116
- Performance
  - Improving ..... 31
- Performing
  - AM/FM/PM Modulation Analysis ..... 135
- Phase
  - Deviation ..... 29
  - Deviation, scaling ..... 77
  - Unit ..... 82
- Phase noise measurement
  - Activating/Deactivating ..... 124
  - Deactivating ..... 125
  - Marker ..... 122
  - Remote control ..... 339
- Phase Wrap
  - Activating ..... 70
- PM (Offline)
  - Softkey ..... 56
- PM Spectrum
  - Evaluation method ..... 20
- PM Time Domain
  - Evaluation method ..... 17
- Ports
  - External Mixer (remote) ..... 170
- Power mode
  - Band power measurement ..... 131
- Power sensors
  - Trigger mode ..... 56
- Power splitter mode ..... 180
- Preamplifier
  - Setting ..... 49
  - Softkey ..... 49
- Preset
  - Bands (External Mixer, remote) ..... 166
- Presetting
  - Channels ..... 39
- Pretrigger ..... 57
- Programming examples
  - External Mixer ..... 175
  - Statistics ..... 367, 368
- Protection
  - RF input (remote) ..... 157
- Q**
- Quick Config
  - Traces ..... 99
- R**
- Range ..... 80
  - Scaling ..... 80
- RBW ..... 62
  - Displayed ..... 12
  - Remote control ..... 228
- Reference
  - Fixed ..... 114
  - Marker ..... 114

- Reference level ..... 46
  - Auto level ..... 47, 94
  - Displayed ..... 12
  - Offset ..... 47
  - Offset, displayed ..... 12
  - Position ..... 80
  - Unit ..... 46, 47
  - Value ..... 46
- Reference marker ..... 111
- Reference value ..... 78
  - Position ..... 78
- Refreshing
  - MSRA secondary applications ..... 65
  - MSRT secondary applications ..... 65
  - Softkey ..... 65
- Release notes ..... 8
- Remote commands
  - Basics on syntax ..... 145
  - Boolean values ..... 149
  - Capitalization ..... 146
  - Character data ..... 149
  - Data blocks ..... 150
  - Deprecated ..... 375
  - Numeric values ..... 148
  - Optional keywords ..... 147
  - Parameters ..... 148
  - Strings ..... 150
  - Suffixes ..... 147
- Repetition interval ..... 57
  - Softkey ..... 57
- Res BW
  - see RBW ..... 62
- Resetting
  - RF input protection ..... 157
- Residual FM ..... 29
- Resolution bandwidth
  - see RBW ..... 62
- Restoring
  - Channel settings ..... 39
  - Standard files ..... 40
- Result Display ..... 11
- Result displays
  - Marker table ..... 25
  - Peak list ..... 25
- Result Summary
  - Demodulation spectrum ..... 72
  - Evaluation method ..... 23
  - Retrieving values (remote) ..... 284
- Results ..... 15
  - Analyzing ..... 96
  - Data format (remote) ..... 282
  - Exporting ..... 106
  - Retrieving (remote control) ..... 277
  - Stability ..... 31
  - Updating the display ..... 65
- RF (Offline)
  - Softkey ..... 56
- RF attenuation
  - Auto ..... 48
  - Manual ..... 48
- RF full span ..... 73
- RF input ..... 42
  - Overload protection (remote) ..... 157
  - Remote ..... 156
- RF overrange
  - External Mixer ..... 170
- RF Power
  - Trigger ..... 56
  - Trigger level (remote) ..... 233
- RF Spectrum
  - Evaluation method ..... 22
  - Troubleshooting ..... 143
- RF Time Domain
  - Evaluation method ..... 21
- RUN CONT
  - Key ..... 63, 103
- RUN SINGLE
  - Key ..... 64, 103
- S**
  - Safety instructions ..... 8
  - Sample rate ..... 30
  - Samples
    - Performance ..... 31
  - Saving
    - Settings ..... 40
  - Scaling
    - AF ..... 77
    - Amplitude range, automatically ..... 80
    - Automatic ..... 79, 93
    - Configuration ..... 77
    - Result Summary ..... 79
    - RF ..... 79
    - Y-axis ..... 81
    - Y-axis (remote control) ..... 225
  - Screen layout ..... 11
  - Search Configuration (softkey) ..... 115
  - Search Mode
    - Spectrogram markers ..... 117
  - Search settings
    - Markers (remote) ..... 323
  - Searching
    - Configuration (softkey) ..... 117
  - Secure user mode
    - Storage location ..... 40
  - Security procedures ..... 8
  - Select Frame
    - Softkey ..... 65, 102
  - Select Marker ..... 116
  - Sequencer ..... 11
    - Activating (remote) ..... 267
    - Remote ..... 266
  - Sequences
    - Aborting (remote) ..... 267
    - Mode (remote) ..... 267
  - Service manual ..... 7
  - Settings
    - Displayed ..... 37
    - filename ..... 40
    - Restoring files ..... 40
    - Storage location ..... 40
  - Settings files
    - Deleting ..... 40
    - Loading ..... 40
    - Predefined ..... 379
    - Saving ..... 40
  - Signal ID
    - External Mixer (remote) ..... 164
  - Signal-to-noise ratio ..... 29
  - Signal-to-noise-and-distortion
    - see SINAD ..... 24

SINAD .....	24
Querying (remote) .....	287
Troubleshooting .....	143
Single sweep .....	
Softkey .....	64, 103
Slope .....	
Trigger .....	58, 235
Softkey .....	
Calibrate Reflection Open (remote control) .....	209
Calibrate Reflection Short (remote control) .....	209
Calibrate Transmission (remote control) .....	209
Softkeys .....	
AF Auto Scale .....	79, 93
AF Center .....	71
AF Filter Config .....	73
AF Full Span .....	72
AF Span Manual .....	71
AF Start .....	71
AF Stop .....	71
All Functions Off .....	132
AM (Offline) .....	56
Amplitude Config .....	45
Auto All .....	93
Auto Freq .....	93
Auto Level .....	47, 94
BB Power .....	55
Capture Offset .....	62
Center .....	50, 72
Clear Spectrogram .....	66, 104
Color Mapping .....	103
Continue Single Sweep .....	64
Continuous Sweep .....	63, 103
Demod BW .....	61, 73
Demod Config .....	67
Digital I/Q .....	55
Display Config .....	66
External .....	53
FM (Offline) .....	56
Frame count .....	66
Free Run .....	53
Frequency Config .....	70
History Depth .....	102
IF Power .....	54
Input Source Config .....	41
Lower Level Hysteresis .....	95
Marker Config .....	109, 112
Marker Search Area .....	119
Marker Search Type .....	119
Marker to Trace .....	112
Meas Time .....	62, 65
MeasTime Auto .....	94
MeasTime Manual .....	94
Min .....	117
Next Min .....	117
Next Mode X .....	118
Next Mode Y .....	118
Next Peak .....	116
Norm/Delta .....	111
Outputs Config .....	87
Overview .....	37
Peak .....	116
PM (Offline) .....	56
Power Sensor .....	56
Preamp .....	49
Ref Level .....	46
Ref Level Offset .....	47
Refresh .....	65
Repetition interval .....	57
Res BW .....	62
RF (Offline) .....	56
RF Atten Auto .....	48
RF Atten Manual .....	48
RF Power .....	56
Scale Config .....	77
Search Config .....	115, 117
Select Frame .....	65, 102
Select Marker .....	116
Single Sweep .....	64, 103
Span Manual .....	73
Sweep Count .....	65
Time .....	56
Timestamp .....	102
Trace 1/2/3/4 .....	100
Trace Config .....	96
Trigger Offset .....	57
Upper Level Hysteresis .....	94
Sort mode .....	
Peak list .....	128
Span .....	73
Band power measurement .....	131
Displayed .....	13
Manual .....	73
Speaker .....	
Remote control .....	213
Specifications .....	8
Specifics for .....	
Configuration .....	39
Spectrograms .....	
3-dimensional .....	102
Activating/Deactivating .....	101, 102
Clearing .....	66, 104
Color curve .....	105
Color mapping .....	103, 104
Color mapping (remote control) .....	297
Color scheme .....	105
Configuring (remote control) .....	291
Display depth (3-D) .....	102
Frames (remote control) .....	292
History depth .....	102
Markers (remote control) .....	315, 346
Selecting frames .....	65, 102
Settings .....	100
Size .....	101
Timestamps .....	102
Spectrum .....	
Demodulation .....	70
Squelch .....	
AF .....	68
Level .....	68
Remote control .....	242
State .....	68
Standards .....	
Configuration .....	39
Predefined .....	379
Presetting .....	40
VSA measurements .....	39
Statistics .....	
Programming example .....	367, 368
Status registers .....	
STAT:QUES:POW .....	157
Step size .....	
Markers .....	113
Markers (remote control) .....	313



- Storage location
  - Secure user mode ..... 40
  - Settings ..... 40
- Subwindows
  - Spectrogram ..... 101
- Suffixes
  - Common ..... 150
  - Remote commands ..... 147
- Sweep
  - Aborting ..... 63, 64, 103
  - Settings ..... 63
- Sweep Count ..... 65
- Sweep points
  - Displayed ..... 13
- Sweep Points ..... 65
- Sweeps
  - Performing (remote) ..... 264
- T**
- THD ..... 24
  - Querying (remote) ..... 287
  - Troubleshooting ..... 143
  - Unit ..... 82
- Time domain zoom ..... 32, 68
  - Length ..... 69
  - Start ..... 69
  - State ..... 69
  - Time per division ..... 69
- Time frames
  - Continuing ..... 66
  - per sweep ..... 66
  - Selecting ..... 65, 102
- Time per division
  - Displayed ..... 13
  - Time domain zoom ..... 69
- Time trigger
  - Repetition interval ..... 57
  - Softkey ..... 56
- Timestamps
  - Softkey (Spectrogram) ..... 102
  - Spectrograms ..... 102
- Total harmonic distortion
  - see THD ..... 24
- Traces ..... 100
  - Average mode ..... 99
  - Averaging (remote control) ..... 304
  - Configuration ..... 96
  - Configuring (remote control) ..... 299
  - Detector ..... 98
  - Detector (remote control) ..... 256, 305
  - Export format ..... 107, 108
  - Exporting ..... 105, 106, 107, 109, 136
  - Hold ..... 98
  - Mode ..... 97
  - Mode (remote) ..... 300
  - Remote control ..... 277
  - Retrieving results (remote) ..... 278
  - Settings (remote control) ..... 299
  - Settings, predefined ..... 99
- Trigger
  - Drop-out time ..... 58
  - External (remote) ..... 235
  - Holdoff ..... 58
  - Hysteresis ..... 57
  - Offset ..... 57
  - Offset, value range ..... 30
  - Output ..... 59
  - Remote control ..... 230
  - Settings ..... 51
  - Slope ..... 58, 235
- Trigger level ..... 56
  - External trigger (remote) ..... 232
  - I/Q Power (remote) ..... 233
  - IF Power (remote) ..... 233
  - RF Power (remote) ..... 233
- Trigger source ..... 52
  - AF ..... 32
  - AM (Offline) ..... 56
  - BB Power ..... 55
  - Digital I/Q ..... 55
  - External ..... 53
  - External Analog ..... 54
  - External Ch3 ..... 53
  - FM (Offline) ..... 56
  - Free Run ..... 53
  - I/Q Power ..... 54
  - IF Power ..... 54
  - PM (Offline) ..... 56
  - Power Sensor ..... 56
  - RF (Offline) ..... 56
  - RF Power ..... 56
  - Settings ..... 52
  - Time ..... 56
- Troubleshooting ..... 143
  - Demodulation bandwidth ..... 143
  - Input overload ..... 157
  - RF Spectrum ..... 143
  - SINAD ..... 143
  - THD ..... 143
- U**
- Units ..... 81
  - Reference level ..... 46, 47
- Updating
  - Result display ..... 65
- Upper Level Hysteresis ..... 94
- V**
- Videos ..... 9
- Volume
  - Remote control ..... 213
- W**
- Weighting filter
  - AF filters ..... 75
- White papers ..... 9
- Window title bar information ..... 13
- Windows
  - Adding (remote) ..... 270
  - Closing (remote) ..... 276
  - Configuring ..... 39
  - Layout (remote) ..... 274
  - Maximizing (remote) ..... 270, 296
  - Querying (remote) ..... 272
  - Replacing (remote) ..... 273
  - Splitting (remote) ..... 270, 296
  - Types (remote) ..... 270

**X**

X-value  
Marker ..... 111

**Y**

Y-axis  
Scaling ..... 81  
YIG-preselector  
Activating/Deactivating ..... 44  
Activating/Deactivating (remote) ..... 158

**Z**

Zero Phase  
Reference Position ..... 69  
Reference Position (remote) ..... 242  
Zooming  
Time domain ..... 32, 68