

R&S® SMBV100B Vector Signal Generator Getting Started



1423104902

Version 12

ROHDE & SCHWARZ

Make ideas real



This document describes the R&S®SMBV100B, stock no. 1423.1003.02 and its options.

© 2023 Rohde & Schwarz

Muehldorfstr. 15, 81671 Muenchen, Germany

Phone: +49 89 41 29 - 0

Email: info@rohde-schwarz.com

Internet: www.rohde-schwarz.com

Subject to change – data without tolerance limits is not binding.

R&S® is a registered trademark of Rohde & Schwarz GmbH & Co. KG.

The terms HDMI, HDMI High-Definition Multimedia Interface, HDMI trade dress and the HDMI Logos are trademarks or registered trademarks of HDMI Licensing Administrator, Inc.

All other trademarks are the properties of their respective owners.

1423.1049.02 | Version 12 | R&S®SMBV100B

The following abbreviations are used throughout this manual: R&S®SMBV100B is abbreviated as R&S SMBV100B, R&S®WinIQSIM2™ is abbreviated as R&S WinIQSIM2, R&S®VISA is abbreviated as R&S VISA.

Contents

| | |
|--|-----------|
| 1 Safety and regulatory information..... | 7 |
| 1.1 Safety instructions..... | 7 |
| 1.2 Labels on R&S SMBV100B..... | 10 |
| 1.3 Warning messages in the documentation..... | 11 |
| 1.4 Where to find key documents on Rohde & Schwarz..... | 11 |
| 1.5 Korea certification class A..... | 12 |
| 2 Documentation overview..... | 13 |
| 2.1 Getting started manual..... | 13 |
| 2.2 User manuals and help..... | 13 |
| 2.3 Service manual..... | 14 |
| 2.4 Instrument security procedures..... | 14 |
| 2.5 Printed safety instructions..... | 14 |
| 2.6 Data sheets and brochures..... | 14 |
| 2.7 Release notes and open source acknowledgment (OSA)..... | 15 |
| 2.8 Application notes, application cards, white papers, etc..... | 15 |
| 2.9 Videos..... | 15 |
| 3 Key features..... | 16 |
| 4 Preparing for use..... | 17 |
| 4.1 Lifting and carrying..... | 17 |
| 4.2 Unpacking and checking..... | 17 |
| 4.3 Choosing the operating site..... | 18 |
| 4.4 Setting up the R&S SMBV100B..... | 18 |
| 4.4.1 Placing the R&S SMBV100B on a bench top..... | 18 |
| 4.4.2 Mounting the R&S SMBV100B in a rack..... | 20 |

| | | |
|----------|---|-----------|
| 4.5 | Considerations for test setup..... | 21 |
| 4.6 | Connecting to power..... | 22 |
| 4.7 | Connecting to LAN..... | 22 |
| 4.8 | Connecting USB devices..... | 23 |
| 4.9 | Connecting to RF coaxial connectors..... | 24 |
| 4.10 | Connecting to RF..... | 26 |
| 4.11 | Connecting to LO In/Out..... | 26 |
| 4.12 | Connecting to Ref In/Ref Out..... | 27 |
| 4.13 | Connecting to HS Dig I/Q..... | 27 |
| 4.14 | Switching on or off..... | 28 |
| 5 | Instrument tour..... | 30 |
| 5.1 | Front panel tour..... | 30 |
| 5.1.1 | Touchscreen..... | 31 |
| 5.1.2 | Keys..... | 32 |
| 5.1.3 | Connectors..... | 36 |
| 5.2 | Rear panel tour..... | 37 |
| 5.2.1 | Connectors..... | 38 |
| 6 | Trying out the instrument..... | 42 |
| 6.1 | Generating an unmodulated carrier..... | 42 |
| 6.2 | Generating a digitally modulated signal..... | 45 |
| 6.3 | Triggering the instrument with an external signal..... | 47 |
| 6.4 | Enabling and configuring a marker signal..... | 53 |
| 6.5 | Verifying the generated signal with the graphics display..... | 54 |
| 6.6 | Saving and recalling settings..... | 57 |
| 6.7 | Generating an EUTRA/LTE signal..... | 60 |
| 7 | System overview..... | 65 |

| | | |
|-------|---|----|
| 7.1 | Brief introduction to the instrument's concept..... | 65 |
| 7.2 | Signal flow at a glance..... | 65 |
| 7.3 | Internal baseband source ("Baseband" block)..... | 67 |
| 7.4 | Digital baseband input ("BB input"Block)..... | 67 |
| 7.5 | Additional white gaussian noise ("AWGN" block)..... | 68 |
| 7.6 | "I/Q stream mapper" block..... | 68 |
| 7.7 | I/Q modulator ("I/Q mod" block)..... | 68 |
| 7.8 | Analog I/Q output ("I/Q analog" block)..... | 69 |
| 7.9 | RF and analog modulations ("RF" block)..... | 69 |
| 7.10 | Applications examples of the R&S SMBV100B..... | 69 |
| 8 | Instrument control..... | 70 |
| 8.1 | Possible ways to operate the instrument..... | 70 |
| 8.2 | Means of manual interaction..... | 71 |
| 8.3 | Understanding the display information..... | 72 |
| 8.3.1 | Status bar..... | 72 |
| 8.3.2 | Block diagram..... | 73 |
| 8.3.3 | Taskbar..... | 74 |
| 8.3.4 | Additional display characteristics..... | 75 |
| 8.4 | Accessing the functionality..... | 77 |
| 8.5 | Entering data..... | 79 |
| 8.5.1 | Entering numeric parameters..... | 79 |
| 8.5.2 | Entering alphanumeric parameters..... | 80 |
| 8.5.3 | Undo and redo actions..... | 80 |
| 8.6 | Getting information and help..... | 81 |
| 8.7 | Remote control..... | 83 |

8.8 Remote operation over VNC..... 83

9 Contacting customer support..... 85

Index..... 86

1 Safety and regulatory information

The product documentation helps you use the product safely and efficiently. Follow the instructions provided here and in the following chapters.

Intended use

The product generates radio frequency (RF) signals for the development, production and verification of electronic components, modules or devices. The product is intended for industrial use, for example for production and conformance testing, maintenance and engineering laboratories.

Use the product only for its designated purpose. Any other use is considered improper use. Observe the operating conditions and performance limits stated in the data sheet.

Target audience

This document targets at all users, including technicians, operators, administrators and maintenance personnel. The required skills and experience of the users depend on the test setup and application of the product.

Where do I find safety information?

Safety information is part of the product documentation. It warns you of potential dangers and gives instructions on how to prevent personal injury or damage caused by dangerous situations. Safety information is provided as follows:

- In [Chapter 1.1, "Safety instructions"](#), on page 7. The same information is provided in many languages as printed "Safety Instructions". The printed "Safety Instructions" are delivered with the product.
- Throughout the documentation, safety instructions are provided when you need to take care during setup or operation.

1.1 Safety instructions

Products from the Rohde & Schwarz group of companies are manufactured according to the highest technical standards. To use the products safely, follow the instructions provided here and in the product documentation. Keep the product documentation nearby and offer it to other users.

Use the product only for its intended use and within its performance limits. Intended use and limits are described in the product documentation such as the data sheet, manuals and the printed "Safety Instructions". If you are unsure about the appropriate use, contact Rohde & Schwarz customer service.

Using the product requires specialists or specially trained personnel. These users also need sound knowledge of at least one of the languages in which the user interfaces and the product documentation are available.

Reconfigure or adjust the product only as described in the product documentation or the data sheet. Any other modifications can affect safety and are not permitted.

Never open the casing of the product. Only service personnel authorized by Rohde & Schwarz are allowed to repair the product. If any part of the product is damaged or broken, stop using the product. Contact Rohde & Schwarz customer service at <https://www.rohde-schwarz.com/support>.

Lifting and carrying the product

The maximum weight of the product is provided in the data sheet. You can lift or carry the product by yourself, if you can manage the weight on your own. Alternatively, you can use lifting or transporting equipment. Follow the instructions provided by the equipment manufacturer.

Choosing the operating site

Only use the product indoors. The product casing is not waterproof. Water that enters can electrically connect the casing with live parts, which can lead to electric shock, serious personal injury or death if you touch the casing. If Rohde & Schwarz provides accessories designed for your product, e.g. a carrying bag, you can use the product outdoors.

Unless otherwise specified, you can operate the product up to an altitude of 2000 m above sea level. The product is suitable for pollution degree 2 environments where nonconductive contamination can occur. For more information on environmental conditions such as ambient temperature and humidity, see the data sheet.

Setting up the product

Always place the product on a stable, flat and level surface with the bottom of the product facing down. If the product is designed for different positions, secure the product so that it cannot fall over.

Safety instructions

If the product has foldable feet, always fold the feet completely in or out to ensure stability. The feet can collapse if they are not folded out completely or if the product is moved without lifting it. The foldable feet are designed to carry the weight of the product, but not an extra load.

If stacking is possible, keep in mind that a stack of products can fall over and cause injury.

If you mount products in a rack, ensure that the rack has sufficient load capacity and stability. Observe the specifications of the rack manufacturer. Always install the products from the bottom shelf to the top shelf so that the rack stands securely. Secure the product so that it cannot fall off the rack.

Connecting to power

The product is an overvoltage category II product. Connect the product to a fixed installation used to supply energy-consuming equipment such as household appliances and similar loads. Keep in mind that electrically powered products have risks, such as electric shock, fire, personal injury or even death. Replace parts that are relevant to safety only by original parts, e.g. power cables or fuses.

Take the following measures for your safety:

- Before switching on the product, ensure that the voltage and frequency indicated on the product match the available power source. If the power adapter does not adjust automatically, set the correct value and check the rating of the fuse.
- Only use the power cable delivered with the product. It complies with country-specific safety requirements. Only insert the plug into an outlet with protective conductor terminal.
- Only use intact cables and route them carefully so that they cannot be damaged. Check the power cables regularly to ensure that they are undamaged. Also ensure that nobody can trip over loose cables.
- If you connect the product to an external power supply, use the one delivered with the product or recommended in the product documentation. The external power supply must conform to the country-specific regulations.
- Only connect the product to a power source with a fuse protection of maximum 20 A.
- Ensure that you can disconnect the product from the power source at any time. Pull the power plug to disconnect the product. The power plug must be easily accessible. If the product is integrated into a system that does not meet

Labels on R&S SMBV100B





these requirements, provide an easily accessible circuit breaker at the system level.

Cleaning the product

Use a dry, lint-free cloth to clean the product. When cleaning, keep in mind that the casing is not waterproof. Do not use liquid cleaning agents.

Meaning of safety labels

Safety labels on the product warn against potential hazards.

| | |
|---|--|
|  | <p>Potential hazard</p> <p>Read the product documentation to avoid personal injury or product damage.</p> |
|  | <p>Electrical hazard</p> <p>Indicates live parts. Risk of electric shock, fire, personal injury or even death.</p> |
|  | <p>Hot surface</p> <p>Do not touch. Risk of skin burns. Risk of fire.</p> |
|  | <p>Protective conductor terminal</p> <p>Connect this terminal to a grounded external conductor or to protective ground. This connection protects you against electric shock if an electric problem occurs.</p> |

1.2 Labels on R&S SMBV100B

Labels on the casing inform about:

- Personal safety, see "[Connecting to power](#)" on page 9.
- Product and environment safety, see [Table 1-1](#).
- Identification of the product, see the serial number on the [rear panel](#).

Table 1-1: Labels regarding R&S SMBV100B and environment safety

| | |
|---|---|
|  | <p>Labeling in line with EN 50419 for disposal of electrical and electronic equipment after the product has come to the end of its service life. For more information, see the product user manual, chapter "Disposal".</p> |
|---|---|

1.3 Warning messages in the documentation

A warning message points out a risk or danger that you need to be aware of. The signal word indicates the severity of the safety hazard and how likely it will occur if you do not follow the safety precautions.

WARNING

Potentially hazardous situation. Could result in death or serious injury if not avoided.

CAUTION

Potentially hazardous situation. Could result in minor or moderate injury if not avoided.

NOTICE

Potential risks of damage. Could result in damage to the supported product or to other property.

1.4 Where to find key documents on Rohde & Schwarz

Certificates issued to Rohde & Schwarz that are relevant for your country are provided at www.rohde-schwarz.com/key-documents, e.g. concerning:

- Quality management
- Environmental management
- Information security management
- Accreditations

1.5 Korea certification class A



이 기기는 업무용(A급) 전자파 적합기기로서 판매자 또는 사용자는 이 점을 주의하시기 바라며, 가정외의 지역에서 사용하는 것을 목적으로 합니다.

2 Documentation overview

This section provides an overview of the R&S SMBV100B user documentation. Unless specified otherwise, you find the documents at:

www.rohde-schwarz.com/manual/smbv100b

2.1 Getting started manual

Introduces the R&S SMBV100B and describes how to set up and start working with the product. Includes basic operations, typical measurement examples, and general information, e.g. safety instructions, etc. A printed version is delivered with the instrument.

2.2 User manuals and help

Separate manuals for the base unit and the software options are provided for download:

- **Base unit manual**
Contains the description of all instrument modes and functions. It also provides an introduction to remote control, a complete description of the remote control commands with programming examples, and information on maintenance, instrument interfaces and error messages. Includes the contents of the getting started manual.
- **Software option manual**
Contains the description of the specific functions of an option. Basic information on operating the R&S SMBV100B is not included.

The contents of the user manuals are available as help in the R&S SMBV100B. The help offers quick, context-sensitive access to the complete information for the base unit and the software options.

All user manuals are also available for download or for immediate display on the Internet.

2.3 Service manual

Describes the performance test for checking compliance with rated specifications, firmware update, troubleshooting, adjustments, installing options and maintenance.

The service manual is available for registered users on the global Rohde & Schwarz information system (GLORIS):

<https://gloris.rohde-schwarz.com>

2.4 Instrument security procedures

Deals with security issues when working with the R&S SMBV100B in secure areas. It is available for download on the internet.

2.5 Printed safety instructions

Provides safety information in many languages. The printed document is delivered with the product.

2.6 Data sheets and brochures

The data sheet contains the technical specifications of the R&S SMBV100B. It also lists the options and their order numbers and optional accessories.

The brochure provides an overview of the instrument and deals with the specific characteristics.

See www.rohde-schwarz.com/brochure-datasheet/smbv100b

2.7 Release notes and open source acknowledgment (OSA)

The release notes list new features, improvements and known issues of the current firmware version, and describe the firmware installation.

The software makes use of several valuable open source software packages. An open-source acknowledgment document provides verbatim license texts of the used open source software.

See www.rohde-schwarz.com/firmware/smbv100b

2.8 Application notes, application cards, white papers, etc.

These documents deal with special applications or background information on particular topics.

See www.rohde-schwarz.com/application/smbv100b

2.9 Videos

Find various videos on Rohde & Schwarz products and test and measurement topics on YouTube: <https://www.youtube.com/@RohdeundSchwarz>



On the menu bar, search for your product to find related videos.

HOME VIDEOS SHORTS PLAYLISTS COMMUNITY CHANNELS ABOUT

Figure 2-1: Product search on YouTube

3 Key features

The R&S SMBV100B is a new high-performance signal generator developed to meet demanding customer requirements. Offering excellent signal characteristic and straightforward and intuitive operation, the signal generator makes signal generation fast and easy.

Outstanding key features of the R&S SMBV100B are:

- Frequency range from 8 kHz to 6 GHz
- Up to 1 GHz I/Q modulation bandwidth (in RF) with internal baseband
- Support of all important digital standards such as 5G NR, LTE incl eMTC/NB-IoT, WLAN IEEE 802.11, 3GPP FDD/HSPA/HSPA+
- Excellent signal quality for high accuracy in spectral and modulation measurements
- Intuitive operation via touchscreen with block diagram as key element
- Graphical signal monitoring at practically every point in the signal flow
- SCPI macro recorder and code generator for generating executable remote control code from manual operating steps (for MATLAB®, CVI, etc.)

For more information, see data sheet.

4 Preparing for use

Here, you can find basic information about setting up the product for the first time.

4.1 Lifting and carrying

Use the handles at the side, for lifting and carrying the R&S SMBV100B, see "[Lifting and carrying the product](#)" on page 8. Use the handles at the front, for mounting the R&S SMBV100B in a rack.

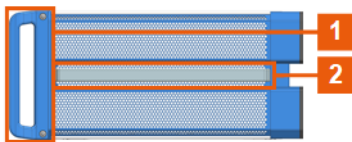

Figure 4-1: Instrument side view with front handles (1) and side handles (2)

4.2 Unpacking and checking

1. Unpack the R&S SMBV100B carefully.
2. Retain the original packing material. Use it to protect the control elements and connectors when transporting or shipping the R&S SMBV100B later. See also chapter "Transporting" in the user manual.
3. Using the delivery notes, check the equipment for completeness.
4. Check the equipment for damage.

If the delivery is incomplete or equipment is damaged, contact Rohde & Schwarz.

4.3 Choosing the operating site

Specific operating conditions ensure proper operation and avoid damage to the product and connected devices. For information on environmental conditions such as ambient temperature and humidity, see the data sheet.

For safety information, see "[Choosing the operating site](#)" on page 8.

Electromagnetic compatibility classes

The electromagnetic compatibility (EMC) class indicates where you can operate the product. The EMC class of the product is given in the data sheet.

- Class B equipment is suitable for use in:
 - Residential environments
 - Environments that are directly connected to a low-voltage supply network that supplies residential buildings
- Class A equipment is intended for use in industrial environments. It can cause radio disturbances in residential environments due to possible conducted and radiated disturbances. It is therefore not suitable for class B environments. If class A equipment causes radio disturbances, take appropriate measures to eliminate them.

4.4 Setting up the R&S SMBV100B

See also:

- "[Setting up the product](#)" on page 8
- "[Intended use](#)" on page 7

4.4.1 Placing the R&S SMBV100B on a bench top

To place the product on a bench top

1. Place the product on a stable, flat and level surface. Ensure that the surface can support the weight of the product. For information on the weight, see the data sheet.

Setting up the R&S SMBV100B

2. **CAUTION!** Foldable feet can collapse. For safety information, see "[Setting up the product](#)" on page 8.

Always fold the feet completely in or out. With folded-out feet, do not place anything on top or underneath the product.

3. **WARNING!** A stack of products can fall over and cause injury. Never stack more than three products on top of each other. Instead, mount them in a rack.

Stack as follows:

- If the products have foldable feet, fold them in completely.
- It is best if all products have the same dimensions (width and length). If the products have different dimensions, stack according to size and place the smallest product on top.
- Do not exceed the permissible total load placed on the product at the bottom of the stack:
 - 50 kg when stacking products of identical dimensions (left figure).
 - 25 kg when stacking smaller products on top (middle figure).

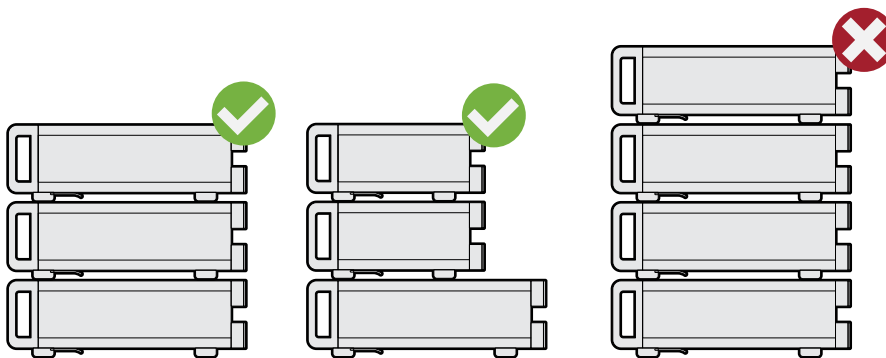

Left = Stacked correctly, same dimensions

Middle = Stacked correctly, different dimensions

Right = Stacked incorrectly, too many products

4. **NOTICE!** Overheating can damage the product.

Prevent overheating as follows:

- Keep a minimum distance of 10 cm between the fan openings of the product and any object in the vicinity to provide sufficient airflow and ventilation.
- Do not place the product next to heat-generating equipment such as radiators or other products.

4.4.2 Mounting the R&S SMBV100B in a rack

To prepare the rack

1. Observe the requirements and instructions in "[Setting up the product](#)" on page 8.
2. **NOTICE!** Insufficient airflow can cause overheating and damage the product. Design and implement an efficient ventilation concept for the rack.

To mount the R&S SMBV100B in a rack

1. Use an adapter kit that fits the dimensions of the R&S SMBV100B to prepare the instrument for rack mounting.
 - a) Order the rack adapter kit designed for the R&S SMBV100B. For the order number, see the data sheet.
 - b) Mount the adapter kit. Follow the assembly instructions provided with the adapter kit.
2. Lift the R&S SMBV100B to shelf height.
3. Grab the handles at the front.
4. Push the R&S SMBV100B onto the shelf until the rack brackets fit closely to the rack.
5. Tighten all screws at the rack brackets with a tightening torque of 1.2 Nm to secure the R&S SMBV100B in the rack.

To unmount the R&S SMBV100B from a rack

1. Loosen the screws at the rack brackets.
2. Bring the lifting equipment to shelf height.
3. Remove the R&S SMBV100B from the rack.
4. If placing the R&S SMBV100B on a bench top again, unmount the adapter kit from the R&S SMBV100B. Follow the instructions provided with the adapter kit.

4.5 Considerations for test setup

Cable selection and electromagnetic interference (EMI)

Electromagnetic interference (EMI) can affect the measurement results.

To suppress electromagnetic radiation during operation:

- Use high-quality shielded cables, especially for the following connector types:
 - BNC
Double-shielded BNC cables.
How to: ["To connect to pluggable connectors"](#) on page 25
 - SMA
Double-shielded SMA cables.
How to: ["To connect to screwable connectors"](#) on page 25
 - USB
Double-shielded USB cables.
How to: [Chapter 4.8, "Connecting USB devices"](#), on page 23.
 - LAN
At least CAT6 STP cables.
How to: [Chapter 4.7, "Connecting to LAN"](#), on page 22
- Always terminate open cable ends.
- Ensure that connected external devices comply with EMC regulations.
- Use cables of the same type and equal length for connection to the I/Q and I/Q Bar interfaces of the instrument.
- Use the cable R&S SMU-Z6 for connection to the Dig I/Q interfaces of the instrument. The cable is available under order number 1415.0201.02.
- Use the cable R&S DIGIQ-HS for connection to the HS Dig I/Q interfaces of the instrument. The cable is available under order number 3641.2948.03.
How to: [Chapter 4.13, "Connecting to HS Dig I/Q"](#), on page 27

Signal input and output levels

Information on signal levels is provided in the data sheet. Keep the signal levels within the specified ranges to avoid damage to the R&S SMBV100B and connected devices.

Preventing electrostatic discharge (ESD)

Electrostatic discharge is most likely to occur when you connect or disconnect a DUT.

- ▶ **NOTICE!** Electrostatic discharge can damage the electronic components of the product and the device under test (DUT).

Ground yourself to prevent electrostatic discharge damage:

- a) Use a wrist strap and cord to connect yourself to ground.
- b) Use a conductive floor mat and heel strap combination.

4.6 Connecting to power

For safety information, see "[Connecting to power](#)" on page 9.

1. Plug the AC power cable into the AC power connector on the rear panel. Only use the AC power cable delivered with the R&S SMBV100B.
2. Plug the AC power cable into a power outlet with ground contact.

The required ratings are listed next to the AC power connector and in the data sheet.

4.7 Connecting to LAN

Network environment

Before connecting the product to a local area network (LAN), consider the following:

- Install the latest firmware to reduce security risks.
- For internet or remote access, use secured connections if applicable.
- Ensure that the network settings comply with the security policies of your company. Contact your local system administrator or IT department before connecting your product to your company LAN.
- When connected to the LAN, the product may potentially be accessed from the internet, which may be a security risk. For example, attackers might misuse or damage the product.

To connect to LAN

- ▶ Connect the LAN socket on the rear panel via an RJ-45 cable to the LAN. Using DHCP (dynamic host configuration protocol), the R&S SMBV100B assigns the IP address automatically.

If connected to the LAN, the R&S SMBV100B displays the IP address at the left bottom of the block diagram.

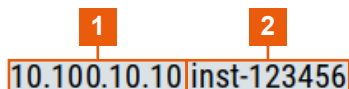
A diagram showing a rectangular box divided into two sections. The left section contains the IP address '10.100.10.10' and is labeled with a red box containing the number '1'. The right section contains the hostname 'inst-123456' and is labeled with a red box containing the number '2'.

10.100.10.10 | inst-123456

1 = IP address
2 = Hostname

If disconnected from the LAN, the R&S SMBV100B displays the IP address *0.0.0.0*.

See also chapter "To configure the instrument for remote access" in the user manual.

4.8 Connecting USB devices

You can connect or disconnect all USB devices from the R&S SMBV100B during operation.

To connect USB storage devices

USB storage devices, such as memory sticks, allow data transfer from or to the R&S SMBV100B. You can also use them for firmware updates.

- ▶ Connect the USB storage device to the USB type A connector on the front panel. Connect the device directly, without connecting cable. Connecting cables can cause electromagnetic radiation and impair a measurement result.

To connect USB devices with external power supply

1. **NOTICE!** Connected devices with external power supply can feed back current into the 5 V power supply of the USB interface and thus damage the R&S SMBV100B.

Connecting to RF coaxial connectors

Ensure that there is no connection between the positive pole of the power supply and the +5 V power pin of the USB interface (VBUS).

2. Connect the USB storage device to the USB connector on the rear panel.

To connect a keyboard

- ▶ Connect the keyboard to the USB connector on the rear panel.

When connected, the R&S SMBV100B detects the keyboard automatically. A detected keyboard has the default layout English – US.

To connect a mouse

- ▶ Connect the mouse to the USB connector on the rear panel.

When connected, the R&S SMBV100B detects the mouse automatically.

To connect power sensors

Connect power sensors of the R&S NRP families to the USB connector on the rear panel.

See chapter "Using power sensors" in the user manual.

4.9 Connecting to RF coaxial connectors

Here, you find information on how to prepare and to connect to RF coaxial connectors of the R&S SMBV100B. Use these RF connectors, for example, for output of the RF signal or for input of an external reference signal.

To prepare for connecting

1. **NOTICE!** Damaged or not clean connections can lead to RF insertion loss and mismatch, and even premature wear of the connectors.
Before connecting to the port, inspect the RF connector visually. Check that it is clean, undamaged and mechanically compatible.
2. **NOTICE!** DC voltage at the RF connector can damage the instrument. Never apply DC voltage to the RF input connectors.
Make sure that the values are within the DC limits given in the data sheet.

Connecting to RF coaxial connectors

3. If your test setup has a DC component at the RF input, insert a DC blocker.
4. Use a high-quality RF cable that matches the RF connector type.
See "[Cable selection and electromagnetic interference \(EMI\)](#)" on page 21.
5. You can connect to two kinds of connectors:
 - "[To connect to screwable connectors](#)" on page 25
 - "[To connect to pluggable connectors](#)" on page 25

To connect to screwable connectors

The R&S SMBV100B provides screwable RF connectors as in [Table 4-1](#).

- **NOTICE!** Excessive tightening can damage the connectors.

To connect the cable with the connector, proceed as follows:

- a) Carefully align the connector of the cable and the connector along a common axis.
- b) Mate the connectors along the common axis until the male pin of the inner connector engages with the female socket of the outer connector.
- c) Turn the nut of the outer connector until the connectors are firmly coupled.
- d) Using a calibrated torque wrench torque the nut to the limit as in the table below. Hold the opposite connector part stationary with a spanner.

Table 4-1: Connector name, type, size, torque limit and nut opening

| Connector | | Torque limit | | Nut opening | |
|-----------|--|--------------|------|-------------|----|
| Type | Name | lb-Inch | Nm | Inch | mm |
| N | RF | 13.3 | 1.5 | 3/4 | 20 |
| SMA | LO In LO Out Ref In 1 GHz Ref Out 1 GHz | 5 | 0.56 | 5/16 | 8 |

To connect to pluggable connectors

The R&S SMBV100B provides pluggable Bayonet Neill-Concelman (BNC) connectors.

- To connect the RF cable with the BNC connector, proceed as follows:
- a) Carefully align the connector of the cable and the BNC connector along a common axis.
 - b) Mate the connectors along the common axis until the male pin of the connector of the cable engages with the female socket of the BNC connector.

For information on how to handle and maintain the RF port, to minimize measurement deviations and ensure its longevity, see the application note [1MA99](#).

If you want to mount test port adapters to your RF connector, see the application note [1MA100](#).

4.10 Connecting to RF

To connect to "RF"

1. Before connecting to the "RF" connector on the front panel, proceed as follows:
 - a) Prepare the "RF" connector. See ["To prepare for connecting"](#) on page 24.
 - b) If activated, deactivate the RF output. In the block diagram, select the block "RF" > "RF Level" > "RF On > Off".

If equipped with an option for rear panel connectors, prepare the "RF" connector on the rear panel.

2. Connect to the "RF" connector. See ["To connect to screwable connectors"](#) on page 25.

To prevent RF output switch-off

- ▶ **NOTICE!** If you set a too high output level without a load connected to the instrument, the reverse power can exceed a limit forcing the R&S SMBV100B to switch off the RF output.

Connect a load with sufficient return loss as given in the data sheet.

4.11 Connecting to LO In/Out

1. Before connecting, prepare the "LO In/Out" connectors on the rear panel. See ["To prepare for connecting"](#) on page 24.
2. Connect to the "LO In/Out" connectors. See ["To connect to screwable connectors"](#) on page 25.

See also chapter "Local oscillator coupling" in the user manual.

4.12 Connecting to Ref In/Ref Out

To connect to "Ref In"/"Ref Out"

For connection, the R&S SMBV100B provides BNC connectors (reference signal frequency $f_{\text{ref}} < 1$ GHz) or SMA connectors ($f_{\text{ref}} = 1$ GHz).

1. Before connecting, prepare the Ref In/Ref Out connectors on the rear panel.
See ["To prepare for connecting"](#) on page 24.
2. Connect to the "Ref In"/"Ref Out" connectors:
 - $f_{\text{ref}} < 1$ GHz: ["To connect to pluggable connectors"](#) on page 25
 - $f_{\text{ref}} = 1$ GHz: ["To connect to screwable connectors"](#) on page 25

4.13 Connecting to HS Dig I/Q

The HS Dig I/Q connector comprises a QSFP+ (Quad Small Form-factor Pluggable) socket that has two components: a QSFP+ cage and a QSFP+ connector. The QSFP+ cable is equipped with the QSFP+ plug.

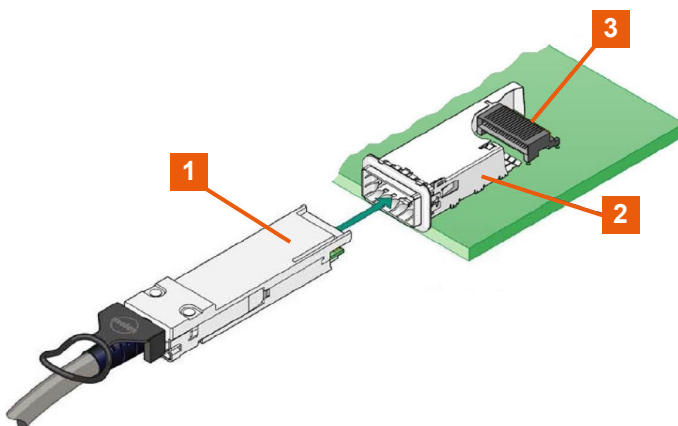

- 1 = QSFP+ plug
- 2 = QSFP+ cage
- 3 = QSFP+ connector

To connect to HS Dig I/Q interface

1. For connection, use the QSFP+ cable R&S DIGIQ-HS.
See "[Cable selection and electromagnetic interference \(EMI\)](#)" on page 21.
2. Hold the QSFP+ plug of the cable by its panes.
3. Turn the QSFP+ cable, so that the release tab shows upwards.
4. Insert and push the QSFP+ plug into the QSFP+ cage.

To disconnect from HS Dig I/Q interface



1. **NOTICE!** If you pull the cable, you can damage the cable and the HS Dig I/Q connector.
Pull the release tab.
2. Pull the QSFP+ plug out of the QSFP+ cage.

See also "Digital baseband input settings" in the user manual.

4.14 Switching on or off

The following table provides an overview of power states, LEDs and positions of the power switch.

Table 4-2: Overview of power states

| State | LED | Position of power switch |
|---------|--|--------------------------|
| Off |  gray | [0] |
| Standby |  orange | [I] |
| Ready |  green | [I] |

To switch on the R&S SMBV100B

The R&S SMBV100B is off but connected to power. See [Chapter 4.6, "Connecting to power"](#), on page 22.

1. Set the switch on the power supply to position [I] on the rear panel.
The LED of the [On/Standby] key on the front panel is orange.
2. Wait until the oven-controlled oscillator (OCXO) warms up. For the warm-up time, see the data sheet.

3. Press the [On/Standby] key on the front panel.

The LED changes to green. The R&S SMBV100B boots.

After booting, the R&S SMBV100B starts up displaying the block diagram on the screen on the front panel.

To check start-up functions

When starting for the first time, the R&S SMBV100B starts with the default settings. When restarting, the R&S SMBV100B recalls the instrument configuration before shut-down.

See chapter "Saving and recalling instrument settings" in the user manual.

When switched on, the R&S SMW automatically monitors main functions. You can query erroneous functions. In addition to automatic monitoring, you can perform maintenance tasks. See the following:

- Chapter "Querying notifications" in the user manual.
- Chapter "Performing maintenance tasks" in the user manual.

To shut down the product

The product is in the ready state.

- ▶ Press the [On/Standby] key.

The operating system shuts down. The LED changes to orange.

In the standby state, the power switch circuits and the OCXO are active. To deactivate them, disconnect the instrument from the power supply.

To disconnect from power

The R&S SMBV100B is in the standby state.

1. **NOTICE!** Risk of data loss. If you disconnect the product from power when it is in the ready state, you can lose settings and data. Shut it down first.
Set the toggle switch on the power supply to position [0].
The LED of the [On/Standby] key is switched off.
2. Disconnect the R&S SMBV100B from the power source.

5 Instrument tour

This chapter explains the control elements and the connectors of the R&S SMBV100B. The views of the front panel and the rear panel help you to get familiar with the instrument and to perform first steps. For specifications of the interfaces, see the data sheet.

The meanings of the labels on the R&S SMBV100B are described in [Chapter 1.2, "Labels on R&S SMBV100B"](#), on page 10.

5.1 Front panel tour

This section provides an overview of the control elements and connectors on the front panel of the R&S SMBV100B. On the [rear panel](#), you find all further connectors.

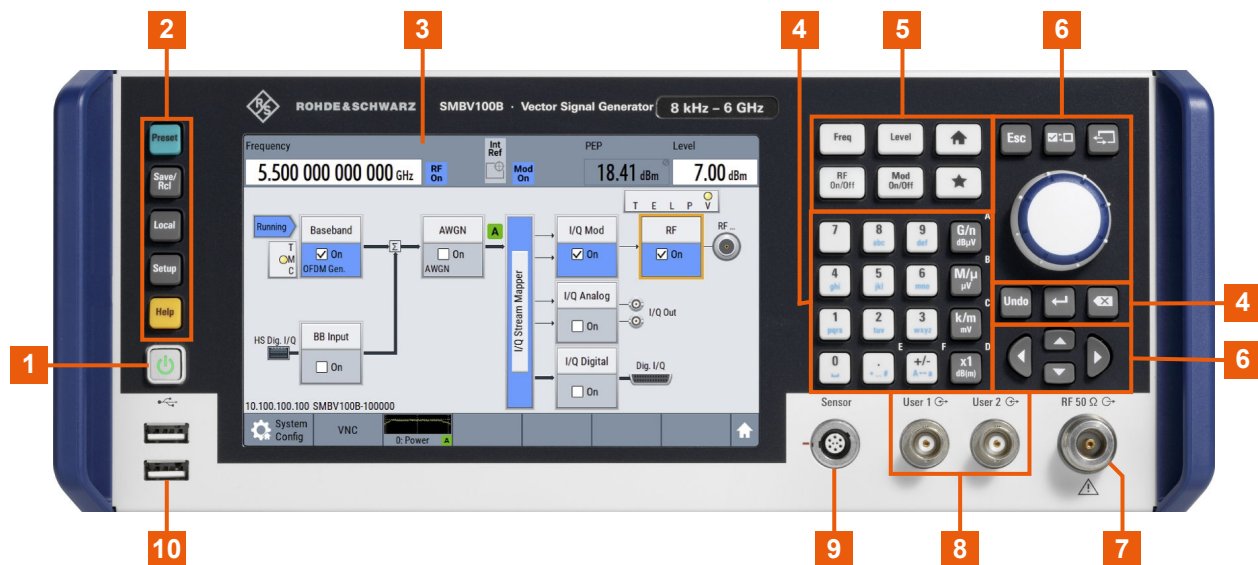

Figure 5-1: R&S SMBV100B front panel controls and connectors

- 1 = On/Standby
- 2 = Utility keys
- 3 = Touchscreen
- 4 = Keypad
- 5 = Function keys
- 6 = Navigation controls
- 7 = RF

- 8 = User x
- 9 = Sensor
- 10 = USB

5.1.1 Touchscreen

The block diagram and the most important settings are displayed on the screen on the front panel. Also, the screen display provides status and setting information and allows you to quickly reconfigure the signal flow. The screen is touch-sensitive, offering an alternative means of user interaction for quick and easy handling of the instrument.

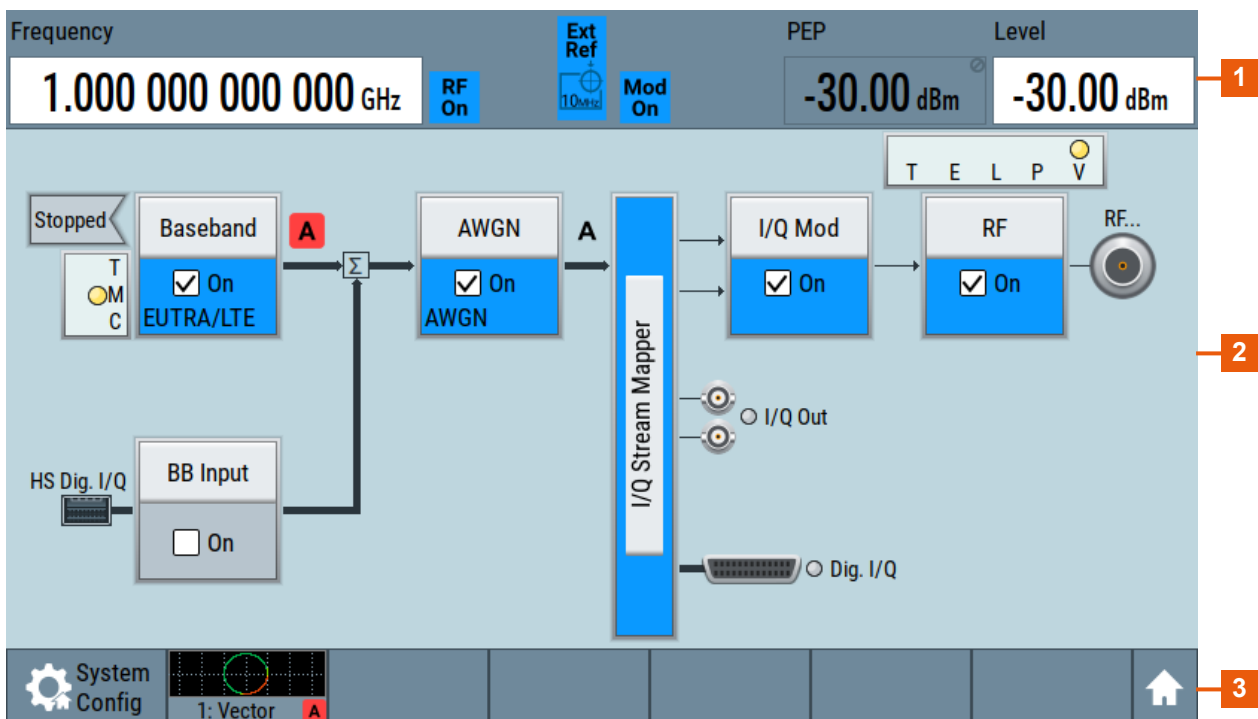

Figure 5-2: Touchscreen elements

- 1 = Status bar (frequency and level display)
- 2 = Block diagram
- 3 = Taskbar/softkey bar

A touchscreen is a screen that is touch-sensitive. It reacts in a specified way when a particular element on the screen is tapped by a finger. Any user interface element that can be clicked by a mouse pointer can also be tapped on the screen to trigger the same behavior.

Using the touchscreen, the following tasks (among others) can be performed by the tap of your finger:

- Changing a setting
- Selecting new settings
- Scrolling through the list of parameters
- Saving or recalling settings
- Opening and closing dialogs

See also:

- [Chapter 8, "Instrument control"](#), on page 70, for operating the touchscreen.
- "Cleaning" in the user manual, for instructions on cleaning the screen.

5.1.2 Keys

5.1.2.1 Utility keys

The utility keys cause the R&S SMBV100B to return to a defined instrument state and provide information on the instrument and assistance.

For more information, refer to chapter "General Instrument Functions" in the user manual.

Table 5-1: Utility keys

| Utility key | Assigned functions |
|-------------|---|
| [Preset] | Sets the instrument to a defined state |
| [Save/Rcl] | Saves and loads instrument setting Accesses the file manager |
| [Local] | Switches from remote control to local (manual) control |
| [Setup] | Accesses the general instrument settings |
| [Help] | Displays context-sensitive help text |

5.1.2.2 On/Standby

The [On/Standby] key switches the instrument from the standby to the ready state or vice versa.

The LED above the [On/Standby] key indicates the instrument state, see [Chapter 4.14, "Switching on or off"](#), on page 28.

5.1.2.3 Function keys

Function keys provide access to most common generator settings and functions. A detailed description of the corresponding functions is provided in the user manual.

Table 5-2: Function keys

| Function key | Assigned functions |
|--------------|---|
| [Freq] | Activates frequency entry. |
| [Level] | Activates level entry. |
| [Home] | Brings the block diagram to the foreground. Active dialogs are minimized. |
| [RF on/off] | Switches the RF output on and off. Press the key again to restore the last active status. Status is displayed in the "Status bar". |
| [Mod on/off] | Switches the modulations on and off. Press the key again to restore the last active status. Status is displayed in the "Status bar". |
| [★ (User)] | Key with a customizable function. |

5.1.2.4 Keypad

The keypad is used to enter alphanumeric parameters, including the corresponding units. It contains the following keys:

Table 5-3: Keys on the keypad

| Type of key | Description |
|-------------------|--|
| Alphanumeric keys | Enter numbers and (special) characters in edit dialog boxes. |
| Decimal point | Inserts a decimal point "." at the cursor position. |

| Type of key | Description |
|---|---|
| Sign key | Changes the sign of a numeric parameter. For an alphanumeric parameter, inserts a "-" at the cursor position. |
| Unit keys (G/n dB μ V, M/ μ μ V, k/m mV and x1 dB(m)) | These keys add the selected unit to the entered numeric value and complete the entry. For level entries (e.g. in dB) or dimensionless values, all units have the value "1" as multiplying factor. Thus, they have the same function as an [Enter] key. |

5.1.2.5 Editing keys

Editing keys enable you to confirm an entry, delete individual characters, or exit the current operation.

Table 5-4: Editing keys

| Type of key | Description |
|-----------------|---|
| [Esc] key | Closes all kinds of dialog boxes, if the edit mode is not active. Quits the edit mode, if the edit mode is active. Equals selecting the "Cancel" button in dialogs, if provided. For "Edit" dialog boxes, the following applies: <ul style="list-style-type: none"> • If data entry has been started, it retains the original value and closes the dialog box. • If data entry has not been started or has been completed, it closes the dialog box. |
| [Enter] key | Has the same effect as pressing the rotary knob <ul style="list-style-type: none"> • Concludes the entry of dimensionless entries. The new value is accepted. • With other entries, this key can be used instead of the default unit key. • In a dialog box, selects the default or focused element. • Calls the next dialog level. • Confirms and closes open input windows. |
| [Backspace] key | Deletes the character to the left of the cursor in editing mode. |

5.1.2.6 Navigation controls

The navigation controls include a rotary knob, navigation keys, and the display keys. They allow you to navigate within the display or within dialog boxes.

Rotary knob

The rotary knob has several functions:

- Increments (clockwise direction) or decrements (counterclockwise direction) numeric instrument parameters at a defined step width.
- Moves the selection, e.g. to a function block in the block diagram
- Shifts the selection bar within focused areas (e.g. lists).
- Acts like the [Enter] key, when it is pressed.
- Opens a context-sensitive menu, when it is pressed and held.

Navigation keys

The navigation keys can be used alternatively to the rotary knob to navigate through dialog boxes, diagrams, or tables.

Table 5-5: Navigation keys

| Type of key | Description |
|------------------|---|
| [Up/Down] key | The [Up] and the [Down] key does the following: <ul style="list-style-type: none"> • In a numeric edit dialog box, increase or decrease the instrument parameter. • In a list, scroll forward and backward through the list entries. • In a table, move the selection bar vertically. • In windows or dialog boxes with vertical scrollbar, move the scrollbar. |
| [Left/Right] key | The [Left] and the [Right] key does the following: <ul style="list-style-type: none"> • In an alphanumeric edit dialog box, move the cursor. • In a list, scroll forward and backward through the list entries. • In a table, move the selection bar horizontally. • In windows or dialog boxes with horizontal scrollbar, move the scrollbar. |

Display keys

The display keys arrange different windows on the display.

Table 5-6: Display keys

| Display key | Assigned functions |
|-----------------|--|
| [Next window] | Toggles between the active dialogs |
| [Home] | Shows the block diagram. |
| [Next window] | Toggles between the open dialogs. |
| [On/Off Toggle] | <ul style="list-style-type: none"> • Switches highlighted elements or a function block on and off. • Switches between two or more settings, e.g. items of selection lists. At the end of a list, the cursor is set on the first entry again. |

| Display key | Assigned functions |
|-------------|-----------------------------------|
| [Undo] | Reverts the last operation. |
| [★ (User)] | Key with a customizable function. |

5.1.3 Connectors

The RF connector and various others interface connectors are on the front panel.

RF

N-type female connector for output of the RF signal.

How to: [Chapter 4.10, "Connecting to RF"](#), on page 26

User x

BNC multipurpose connectors for defining input signals and output signals.

The [Table 5-7](#) lists the signals assigned to the User x connectors in the default instrument state.

Table 5-7: Default configuration of the User x connectors

| User connector | Direction | Default assigned signal |
|----------------|-----------|-------------------------|
| 1 | Output | "Baseband Marker 1" |
| 2 | Output | "Baseband Marker 2" |

A dedicated LED indicates the connector status:

- ● green: an input connector
- ● yellow: an output connector
- ● no light / gray: the connector is not active

See also chapter "Global connectors settings" in the user manual.

Sensor

Connector for R&S NRP sensors.

A power sensor is connected to the R&S SMBV100B by inserting the male connector. To disconnect, pull the connector by its sleeve. You cannot disconnect the sensor simply by pulling at the cable or the rear part of the connector.

The R&S SMBV100B supports the use of R&S NRP power sensors in various ways including the use as a power viewer.

How to: [Chapter "Using Power Sensors"](#) in the user manual

USB

Two female USB (universal serial bus) 2.0 connectors of type A (host USB). These connectors are intended for service and file transfer purposes only. You can connect, for example, a USB memory stick.

Further USB connectors of type A (host USB) and type B (USB In) are available on the rear panel.

How to: [Chapter 4.8, "Connecting USB devices"](#), on page 23.

5.2 Rear panel tour

This section provides an overview of the connectors on the rear panel of the instrument. For technical data of the connectors, refer to the data sheet.

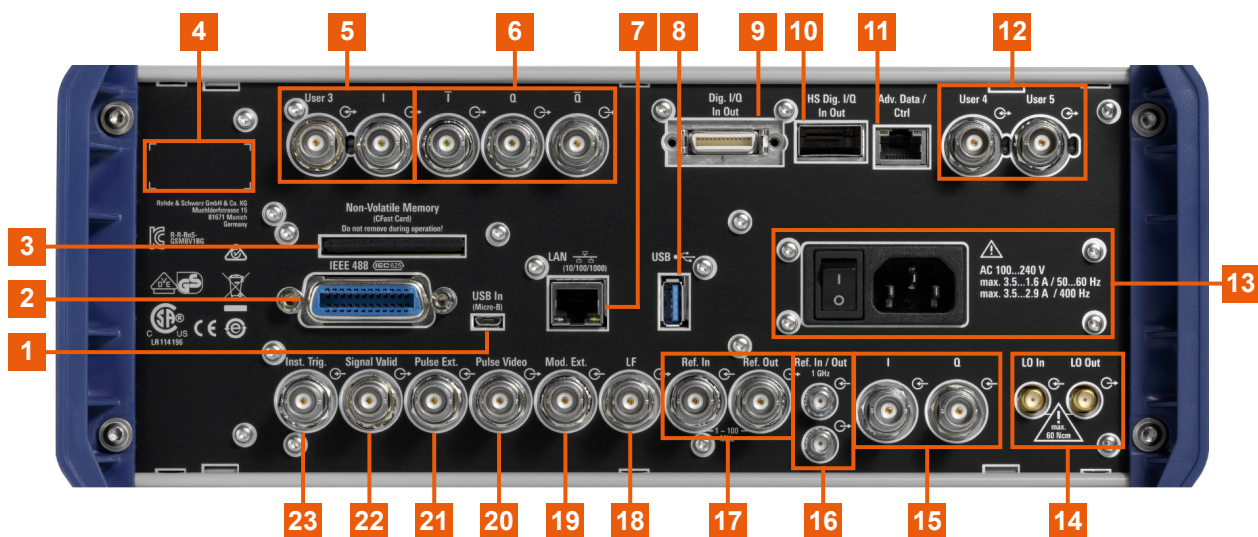

Figure 5-3: Rear panel

- 1, 8 = USB/USB In
- 2 = IEC 625/IEEE 488
- 3 = Non-Volatile Memory
- 4 = Serial number (six digits in the string 1423.1003.02-<serial number>-<checksum>)
- 5, 12 = User x
- 6 = I/Q, I/Q Bar
- 7 = LAN
- 9 = Dig I/Q
- 10 = HS Dig I/Q
- 11 = Adv Data/Ctrl
- 13 = AC power supply connector and switch
- 14 = LO In/LO Out
- 15 = I/Q

| | |
|--------|------------------|
| 16, 17 | = Ref In/Ref Out |
| 18 | = LF |
| 19 | = Mod Ext |
| 20 | = Pulse Video |
| 21 | = Pulse Ext |
| 22 | = Signal Valid |
| 23 | = Inst Trig |

5.2.1 Connectors

USB/USB In

- Female USB (universal serial bus) 2.0 connector of type A (host USB), to connect devices like a keyboard, a mouse, a memory stick, or the R&S NRP-Z3/Z4 cable for the R&S NRP power sensors
- Female USB 3.0 connector of type Micro-B (USB In), for example, for remote control.

How to: [Chapter 4.8, "Connecting USB devices"](#), on page 23

IEC 625/IEEE 488

General purpose interface bus (GPIB) interface for remote control of the instrument. The interface is in compliance with the standards IEC 625, IEEE 488 and SCPI.

Use this interface to connect a computer for remote control of the R&S SMBV100B. To set up the connection, use high-quality shielded cables. See "[Cable selection and electromagnetic interference \(EMI\)](#)" on page 21.

See also "Annex: Hardware interfaces" and chapter "Network and remote control" in the user manual.

Non-Volatile Memory

Option: R&S SMBVB-B80

Slot for removable mass storage.

User x

BNC multipurpose connectors for defining input signals and output signals.

[Table 5-8](#) lists the signals assigned to the User x connectors in the default instrument state.

Table 5-8: Default configuration of the User x connectors

| Connector | Direction | Default assigned signal |
|-----------|-----------|-------------------------|
| "User 3" | "Input" | "Global Trigger" |
| "User 4" | "Input" | "Global Next Segment" |
| "User 5" | "Output" | "Baseband Sync Out" |

A dedicated LED indicates the connector status:

- ● green: an input connector
- ● yellow: an output connector
- ● no light / gray: the connector is not active

See also chapter "Global connectors settings" in the user manual.

I/Q, I/Q Bar

BNC connector for output of direct (single-ended) or differential analog I/Q signals.

Use the connectors for connections as follows:

- I/Q connectors: Direct (single-ended) or positive differential output of analog I/Q signals
- I/Q Bar connectors: Negative differential output of analog I/Q signals

LAN

RJ-45 connector to connect the R&S SMBV100B to a LAN for remote control, remote operation, and data transfer.

How to: [Chapter 4.7, "Connecting to LAN"](#), on page 22

Dig I/Q

Option: R&S SMBVB-K19 for output.

Connectors for the input of a digital I/Q signal from a Rohde & Schwarz instrument, like a signal generator.

HS Dig I/Q

Connectors for the input of high-speed digital I/Q signals, for example, from Rohde & Schwarz instruments.

For more information, see data sheet.

The interface is a QSFP+ (Quad Small Form-factor Pluggable) module. It supports max. bandwidth of up to 50 Gsample/s with optical active cables.

How to: [Chapter 4.13, "Connecting to HS Dig I/Q"](#), on page 27

Adv Data/Ctrl

Interface for exchanging of external data and control signals.

AC power supply connector and switch

Mains power switch for performing the following tasks:

- Connecting the internal power supply to the power source
- Disconnecting the internal power supply from the power source

How to: [Chapter 4.6, "Connecting to power"](#), on page 22.

LO In/LO Out

Option: R&S SMBVB-K90

SMA connector for local oscillator input and output for phase-coherent RF signal:

- LO In: Input of phase coherence signal
- LO Out: Output of phase coherence signal

How to: [Chapter 4.11, "Connecting to LO In/Out"](#), on page 26

I/Q

BNC connector for input of external I/Q signals for analog modulation. The signals are fed directly into the I/Q modulator.

Use the I/Q connector for direct (single-ended) or positive differential input of analog I/Q signals.

See also chapter "Overview of the Input and Output Signals and Interfaces" in the user manual.

Ref In/Ref Out

Input/output for external reference signal.

BNC connectors for reference signals from 1 MHz to 100 MHz.

SMA connectors for 1 GHz reference signals.

How to: [Chapter 4.12, "Connecting to Ref In/Ref Out"](#), on page 27

LF

BNC connector for output of the internal LF generator signal.

See the data sheet and in the user manual, section "Analog modulation".

Mod Ext

BNC connector for input of external analog modulation signals.

Pulse Video

BNC connector for output of the internal pulse generator signal or the looped through pulse signal from Pulse Ext connector (video signal).

Pulse Ext

BNC connector for input of an external pulse modulation signal or an external trigger/gate signal for the pulse generator.

Signal Valid

BNC connector for output of a signal that determines the valid signal times (valid level and frequency) for all analog modulations.

Alternatively, you can use this connector to synchronize pulse signals by activating "Pulse Sync", see "Configuring the RF signal > Analog modulations > Modulation settings > Pulse generator > Pulse generator settings" in the user manual.

Inst Trig

BNC connector for input of external trigger signals. The signals trigger sweeps and list mode.

See chapter "Signal generation and triggering in the sweep and list modes" in the user manual.

6 Trying out the instrument

This chapter introduces the most important functions and settings of the R&S SMBV100B step by step. The complete description of the functionality and its usage is given in the R&S SMBV100B user manual. Basic instrument operation is described in [Chapter 8, "Instrument control"](#), on page 70.

Prerequisites

- The instrument is set up, connected to the power supply, and started up as described in [Chapter 4, "Preparing for use"](#), on page 17.

For the first signal generation tasks, you use the internal baseband and reference signal, so you do not need any additional signal source. More complex signal generation tasks, however, require an instrument equipped with additional options and/or external signals. Each task description lists its prerequisites.

 The screenshots in this description show a fully equipped instrument. Consider that, the block diagram displayed on your particular instrument can differ from the one used in the example.

The instrument is manually operated via the touchscreen. Try out the following:

- [Generating an unmodulated carrier](#)..... 42
- [Generating a digitally modulated signal](#)..... 45
- [Triggering the instrument with an external signal](#)..... 47
- [Enabling and configuring a marker signal](#)..... 53
- [Verifying the generated signal with the graphics display](#)..... 54
- [Saving and recalling settings](#)..... 57
- [Generating an EUTRA/LTE signal](#)..... 60

6.1 Generating an unmodulated carrier

We start out by generating a simple unmodulated signal. The R&S SMBV100B in this example can be a base unit in its minimal configuration (i.e. with installed R&S SMBVB-B103).

Generating an unmodulated carrier

1. On the R&S SMBV100B front panel, press the Preset key to start out in a defined instrument configuration.
2. Set the frequency:
 - a) On the "Status Bar", tap the "Frequency" field.
 - b) On the on-screen keypad, enter 1.955 and press the "GHz" key.

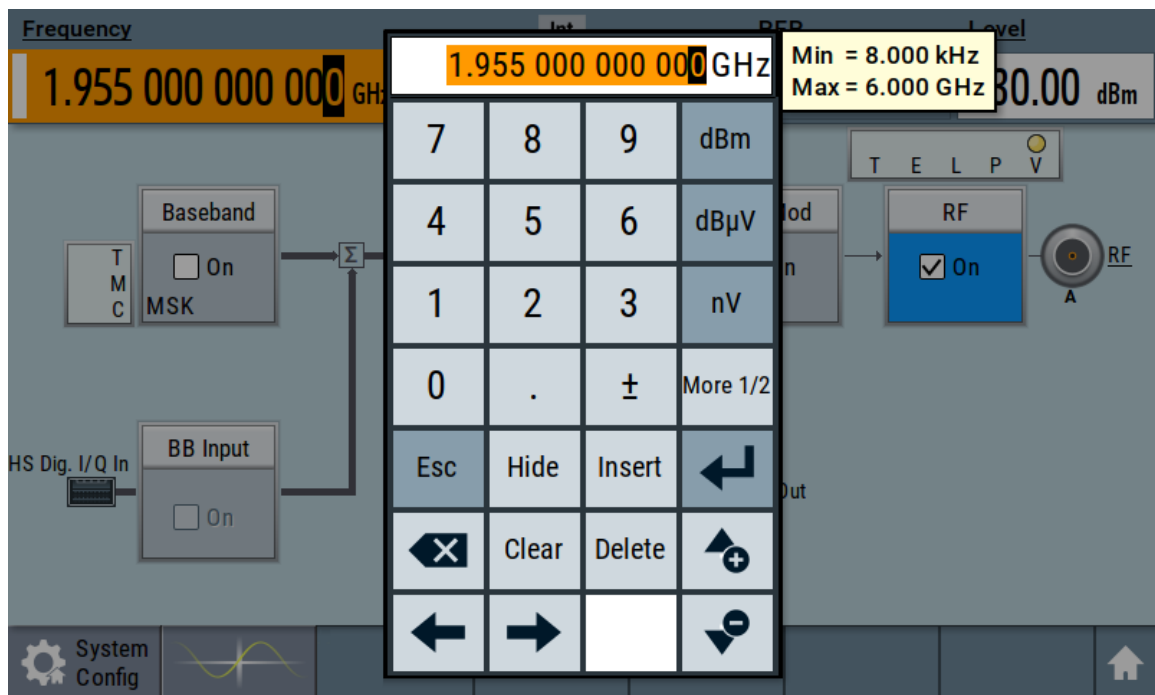

The on-screen keypad closes and the frequency value is displayed.

3. On the "Status Bar", tap the "Level" field and enter the level in the same way.

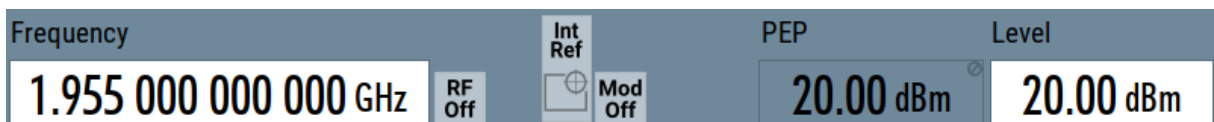

4. Select "Block Diagram > RF Block > On" to enable the output of the generated unmodulated signal.

Generating an unmodulated carrier

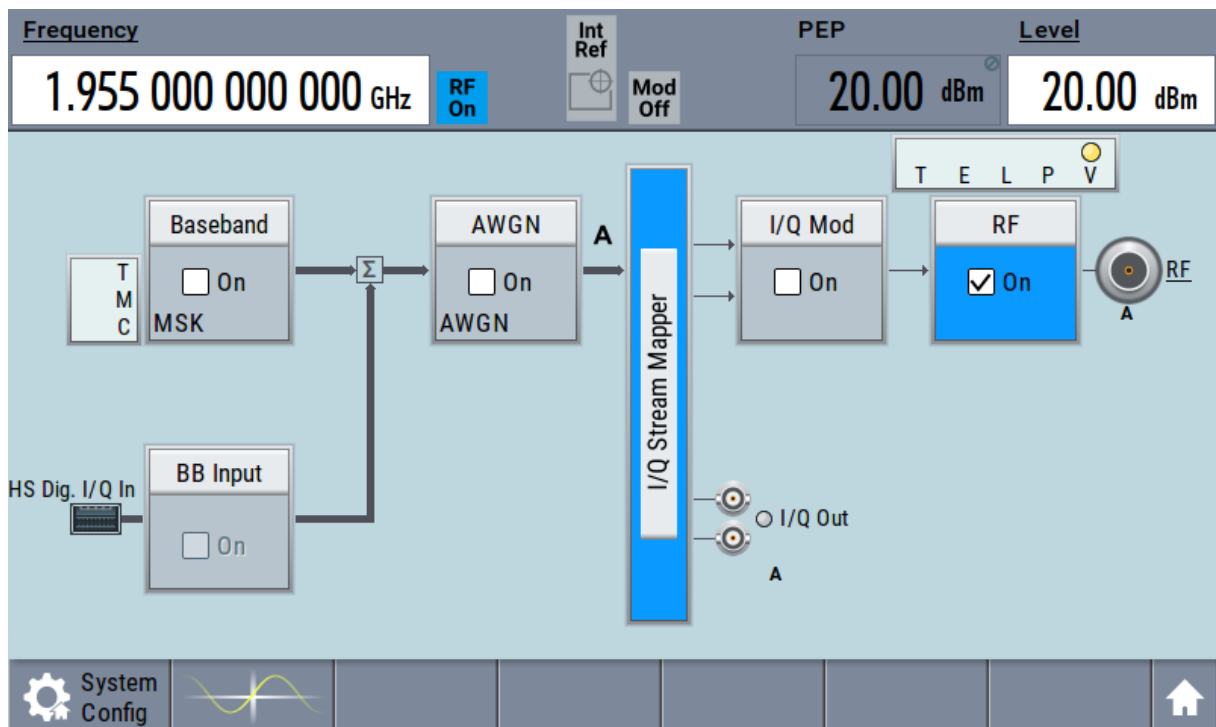

Figure 6-1: Block diagram: Generating an unmodulated signal

The 1.95 GHz signal is output at the RF connector at the front panel of the R&S SMBV100B.

- 💡 Connect RF of the R&S SMBV100B to a signal analyzer, for example R&S®FSW, to display the generated signal.

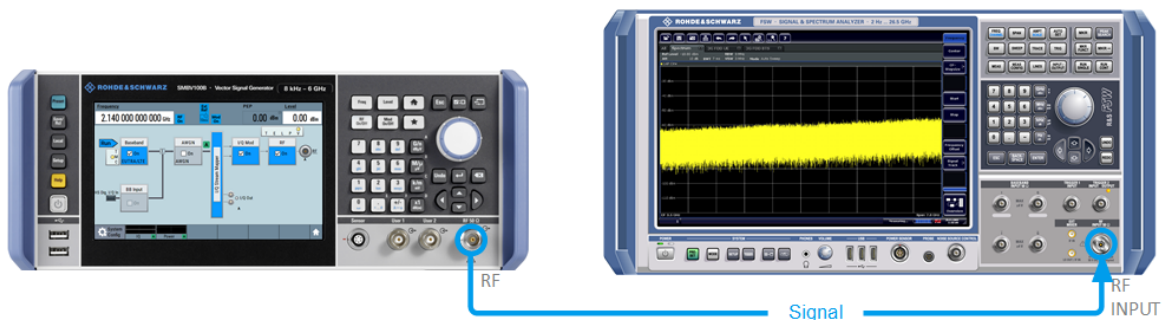

Figure 6-2: Simplified test setup

For the required settings of the signal analyzer, refer to its user manual or its online help.

6.2 Generating a digitally modulated signal

This example shows you how to generate a simple WCDMA-3GPP (QPSK 45° offset) signal with the help of the "Custom Digital Modulation" functionality.

The minimum requirement for R&S SMBV100B in this example is a base unit equipped with:

- Option custom digital modulation R&S SMBVB-K520
- Option frequency R&S SMBVB-B103.

The initial situation is not the instrument's preset state but rather the configuration described in [Chapter 6.1, "Generating an unmodulated carrier"](#), on page 42.

1. In the block diagram, select "Baseband" and navigate to the section "Misc > Custom Digital Mod...".

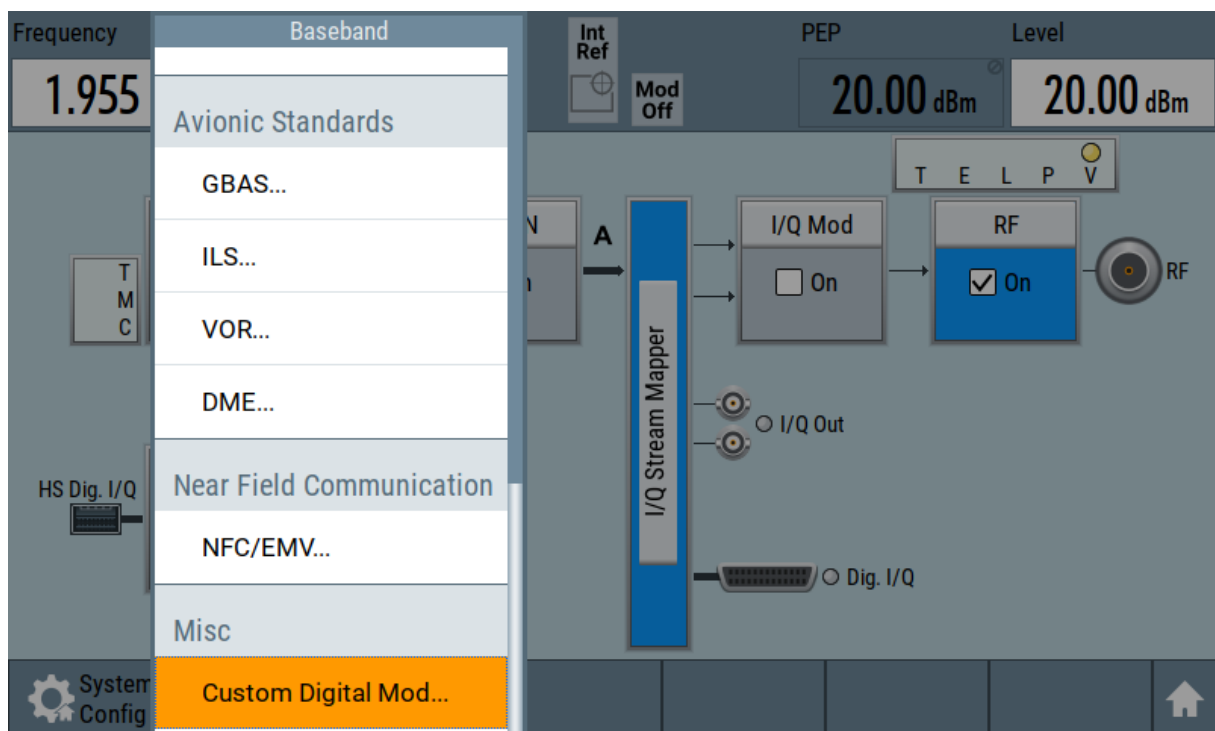

The "Custom Digital Modulation" dialog opens.

2. In the "Custom Digital Modulation" dialog, select "General > Set according to Standard > WCDMA-3GPP".
3. Select "General > State > On" to enable signal generation.

Generating a digitally modulated signal

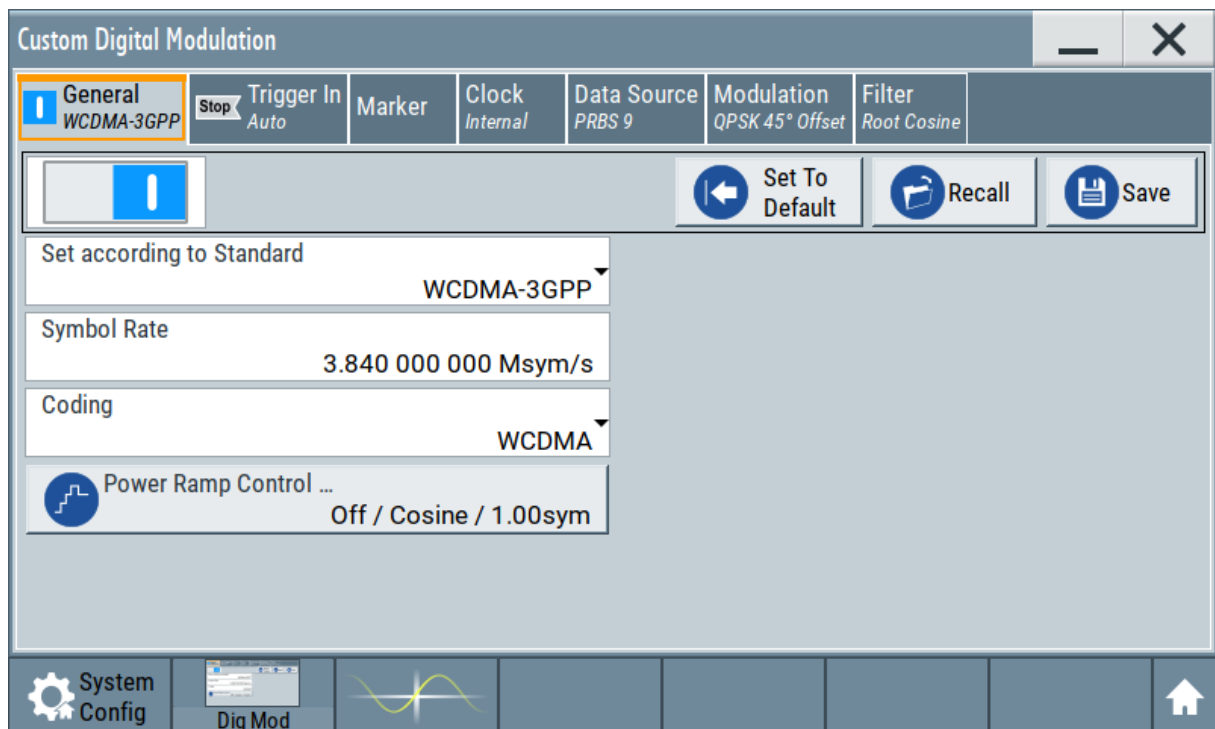

4. Select the "Modulation" tab and observe the used "Modulation Type".

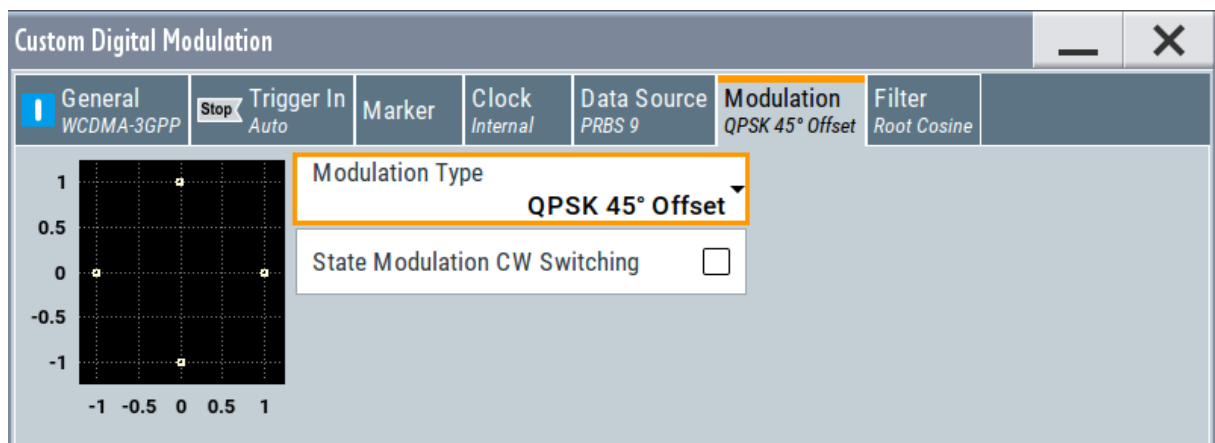

Figure 6-3: Display of the used modulation type

The instrument activates automatically "I/Q Mod", uses the internal trigger and clock signals, and generates a WCDMA-3GPP signal, modulated with a QPSK 45° offset modulation.

Triggering the instrument with an external signal

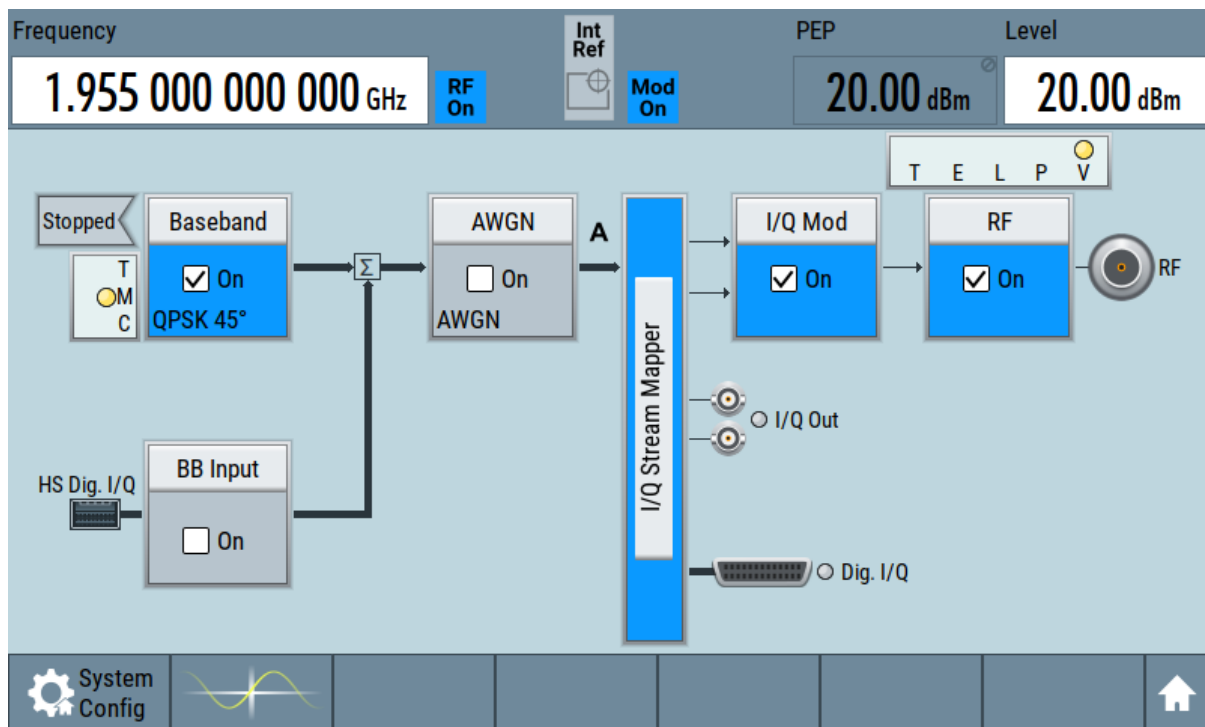

Figure 6-4: Block diagram: Generating a digitally modulated signal

6.3 Triggering the instrument with an external signal

The example configurations are rather theoretical cases, because you rarely use the R&S SMBV100B as a standalone instrument. Usually, the instrument would be connected to a device under test (DUT) and/or other measurement equipment. As a rule, whenever a test setup requires two or more devices, provide them with a common reference frequency. Some test setups require control of the signal generation start and an exact generation start time, determined by a defined trigger event. For example, by triggering the instrument internally or externally from the DUT.

This example illustrates the general principle of external triggering and extends the configuration performed in [Chapter 6.2, "Generating a digitally modulated signal"](#), on page 45 by the configuration of the required trigger signal and connector settings.

This test setup requires one signal analyzer, like the R&S®FSW, as additional equipment.

Triggering the instrument with an external signal

To start the signal generation synchronous to an external global trigger signal

The configuration requires three main steps with the following goals:

1. Observe the current connector configuration. Define an input connector for the external global trigger signal.
See ["To verify the current connector configuration"](#) on page 48
2. Configure the baseband to use this external global trigger signal as trigger source.
See ["To reconfigure the trigger settings"](#) on page 50
3. Connect the instrument and the external trigger source.
See ["To connect the instrument and the external trigger source"](#) on page 52

To verify the current connector configuration

The R&S SMBV100B is equipped with multipurpose bi-directional User connectors. Because the signal direction, input or output, and the signal mapping are configurable, we recommend that you check the current configuration before cabling or further instrument's configurations.

1. To display *an overview* of the current mapping of the logical signals to the connectors, perform one of the following:
 - In the block diagram, select the Trigger/Marker/Clock status LEDs on the left side of the "Baseband" block.



- Select "Baseband > Trigger Marker Clock".

Triggering the instrument with an external signal

Trigger Marker Clock

Baseband A







| | Logical Signal | Connector | Show |
|----------------|----------------|-----------|---|
| Trigger Source | Internal | | |
| Clock Source | Internal | | |
| Clock Output | | | |
| Marker 1 | Radio Frame | User 1 |  ... |
| Marker 2 | Radio Frame | User 2 |  ... |
| Marker 3 | Radio Frame | | |

Diagram Legend

- T = Trigger  = Common to all Basebands
- M = Marker
- C = Clock
-  = Signal is available at Output Connector
-  = Signal Source is external

 Global Connectors ...

The instrument uses its internal trigger and clock signals, and the default mapping of the marker signals to the connectors.

2. To access the related connector settings, perform one of the following:
 - Select "Global Connector Settings"
 - Tap the connector name, for example select the connector "User 1"

Triggering the instrument with an external signal

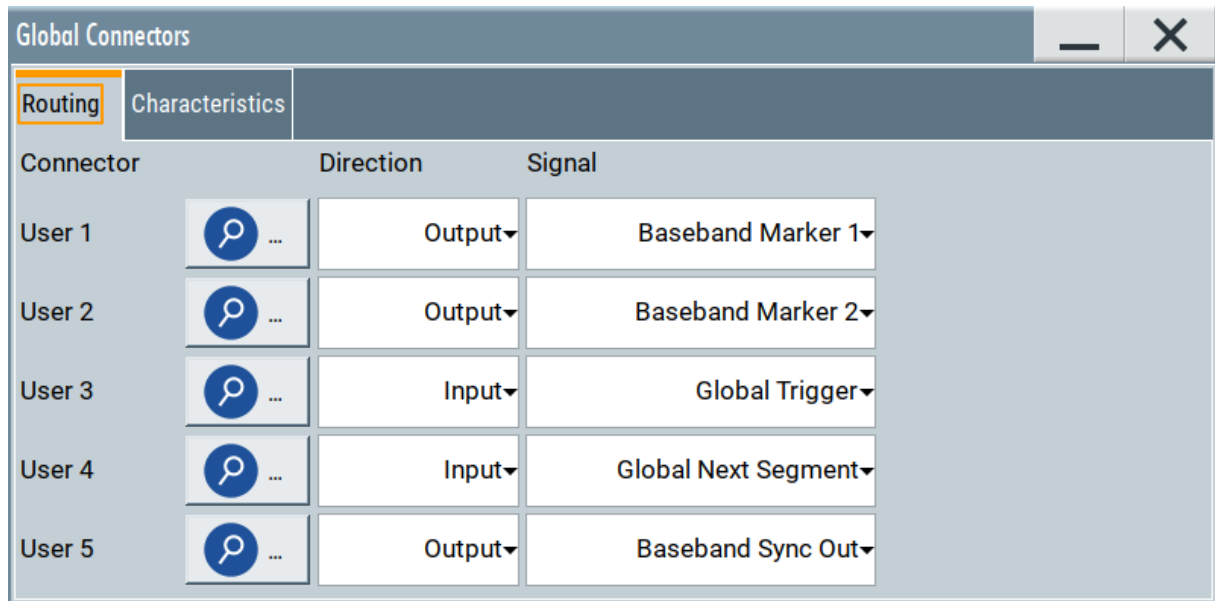

Figure 6-5: Signal mapping to the global connectors

The "Global Connectors" dialog displays the current connectors configuration. The settings are configurable, but in this example we use the default mapping.

- Alternatively, select "Block Diagram > Baseband > Misc > Custom Digital Mod", select the "Trigger In" tab and select "Global Connector Settings".

In the current mapping, the two global connectors **User x** on the front panel are configured as follows:

- "Marker 1/2" are output at the User 1/2 connectors
- The User 3 connector is an input for the "Global Trigger" signal.



Find the physical location of each connector

Use the built-in "Trigger Marker Clock > Show" function to display the location of the selected connector. A blinking marker on the front/rear panel view also indicates the selected connector.

To reconfigure the trigger settings

We assume that the instrument is configured as described in [Chapter 6.2, "Generating a digitally modulated signal"](#), on page 45 and the default connector mapping is maintained (see [Figure 6-5](#)).

- In the block diagram, select "Baseband > Misc > Custom Digital Mod > Trigger In".
- Select the following settings:

Triggering the instrument with an external signal

- a) "Mode > Armed Auto"
- b) "Source > External Global Trigger".

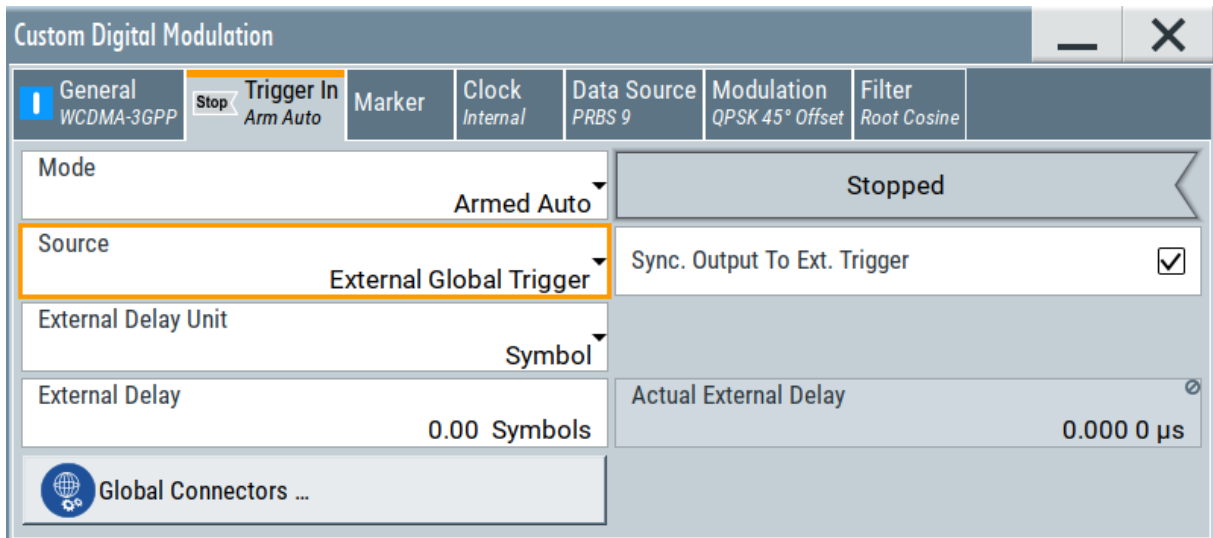

3. Select "Global Connector Settings > Routing".
4. For "User 2", select "Direction > Input" and "Signal > Global Trigger".

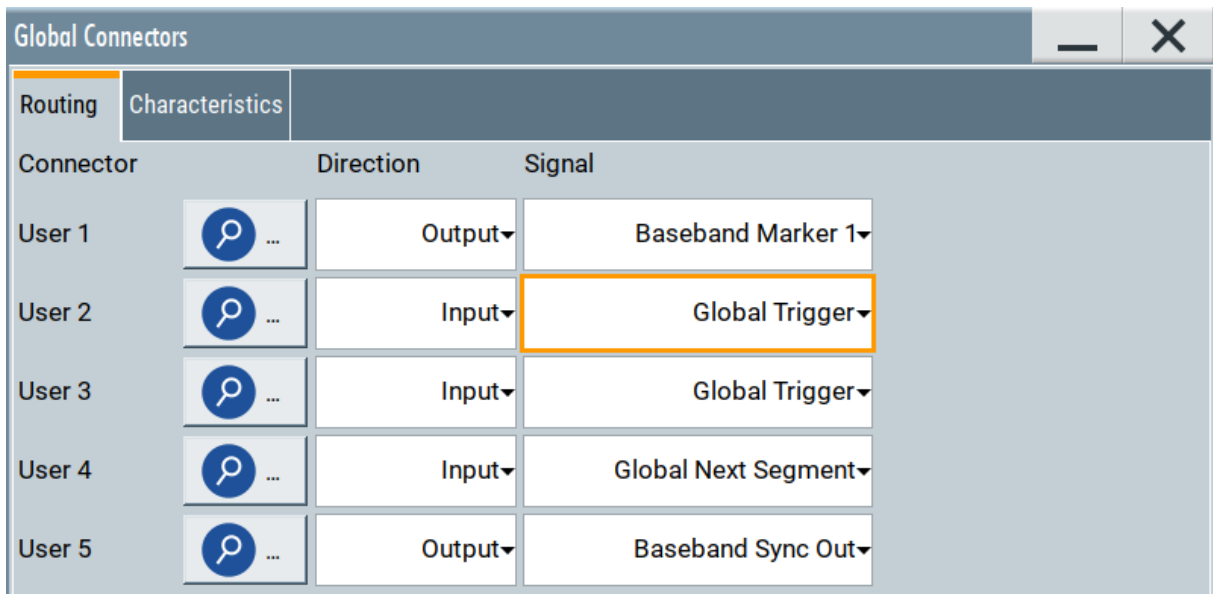

The instrument expects an external global trigger event. In the current configuration, the "Global Trigger" signal has to be supplied at the input connector User 2.

The Trigger/Marker/Clock status LEDs in the block diagram confirm that an external trigger signal is selected; the signal generation is however stopped.

Triggering the instrument with an external signal

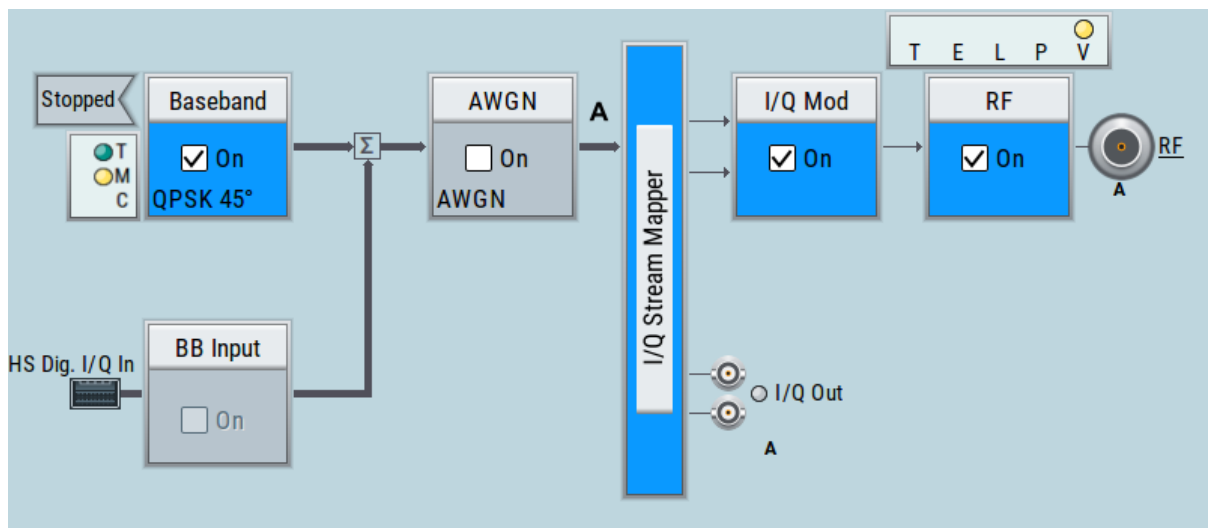

To connect the instrument and the external trigger source

1. Use a suitable cable to connect the external trigger source to the User 2 connector of the R&S SMBV100B. See [Figure 6-6](#).

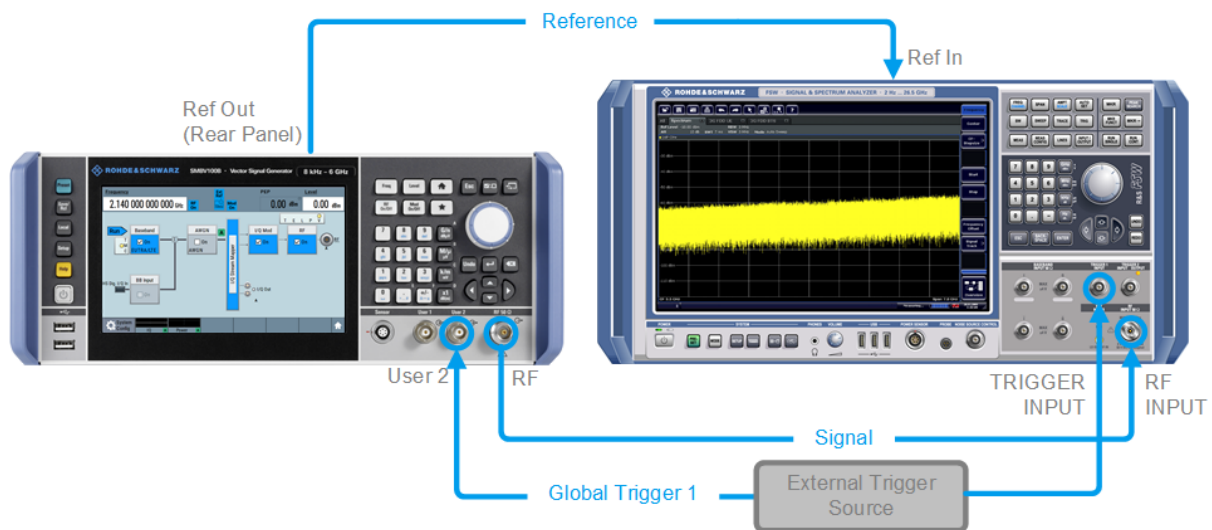

Figure 6-6: Simplified representation of a test setup**

** = The figure depicts the cabling as a general principle; particular test setups do not require all connections at the same time

The [Figure 6-6](#) depicts the location of the connectors and explains the connection as principle. In practice, you would rather "substitute" the analyzer by a DUT, like a base station (BS). Other than in the example, the DUT can be the source for the reference signal. Instead of using an external trigger source, the DUT can also send, for example, a frame trigger signal to the R&S SMBV100B. The R&S SMBV100B acts still as the signal source.

Enabling and configuring a marker signal

2. Use suitable cables to connect the **RF** and **REF OUT** connectors of the R&S SMBV100B to the signal analyzer or the DUT.

Upon the receiving of an external trigger event, the R&S SMBV100B starts the signal generation and then generates a continuous signal. An "Arm" stops the signal generation. A subsequent trigger event causes a restart of the signal generation.



To learn more about this topic, refer to:

- Chapter "Baseband Trigger Signals" in the user manual
- Chapter "Global Connectors" in the user manual

6.4 Enabling and configuring a marker signal

Test setups often require that an external device is synchronized to the generated data stream. For this purpose, the R&S SMBV100B can output marker signals (or markers) also to the generated signal. The R&S SMBV100B provides several regular marker signals and marker signals specific to the firmware option. With suitable marker settings for instance, you can mark slot or frame boundaries or mark the start of a particular modulation symbol.

This example extends further the configurations performed in [Chapter 6.2, "Generating a digitally modulated signal"](#), on page 45. We assume a default connector mapping (see [Figure 6-5](#)).

This test setup requires one oscilloscope, like the R&S®RTO, as additional equipment.

1. In the block diagram, select "Block Diagram > Baseband > Misc > Custom Digital Mod > Marker" tab.
2. Select "Marker Mode > Marker 1 > Pulse" and "Divider = 32".
Generated is a periodic marker with marker frequency of 120 KHz. The signal is output at the User 1 connector of the R&S SMBV100B (see [Figure 6-5](#)).
3. Use a suitable cable to connect the User 1 connector of the R&S SMBV100B to the monitoring instrument, for example oscilloscope like R&S®RTO. See [Figure 6-7](#).

Verifying the generated signal with the graphics display



Figure 6-7: Simplified representation of a test setup for signal monitoring**

** = The figure depicts the cabling as a general principle

4. Use a suitable cable to connect the **I OUT** connector of the R&S SMBV100B to the monitoring instrument.



To learn more about this topic, refer to chapter "Regular Marker Output Signals" in the user manual.

6.5 Verifying the generated signal with the graphics display

It is often useful to check the spectra of the configured signals, before you enable the RF output of the instrument.

The R&S SMBV100B provides a build-in function to represent the generated signal on a graphical signal display. We demonstrate this feature by showing the characteristics at one particular point of the signal processing chain. You can, however, display the signal characteristics at other different stages.

This example shows you how to use this graphical display to verify the generated signal. Use the signal generated in [Chapter 6.4, "Enabling and configuring a marker signal"](#), on page 53.

To access the graphical signal display functionality

- Perform one of the following:

Verifying the generated signal with the graphics display

- a) Select "Taskbar > System Configuration > Graphics"

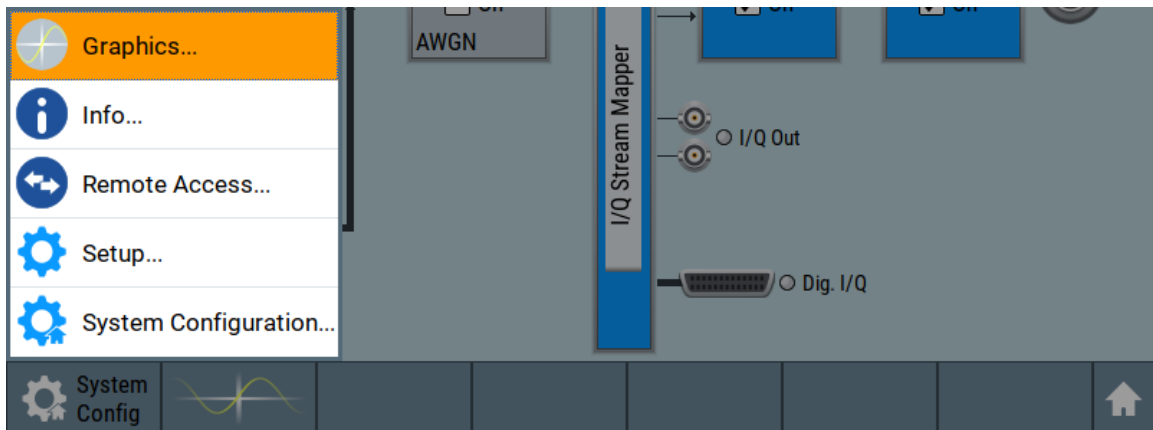

- b) On the "Taskbar", tap the wave icon.

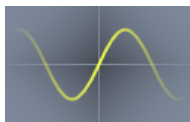

The "Graphics Configuration" dialog opens.

To visualize the signal

1. In the "Graphics Configuration" dialog, select "Mode > Constellation".
2. Select "Source > Baseband".
3. Select "Add" to enable signal display.

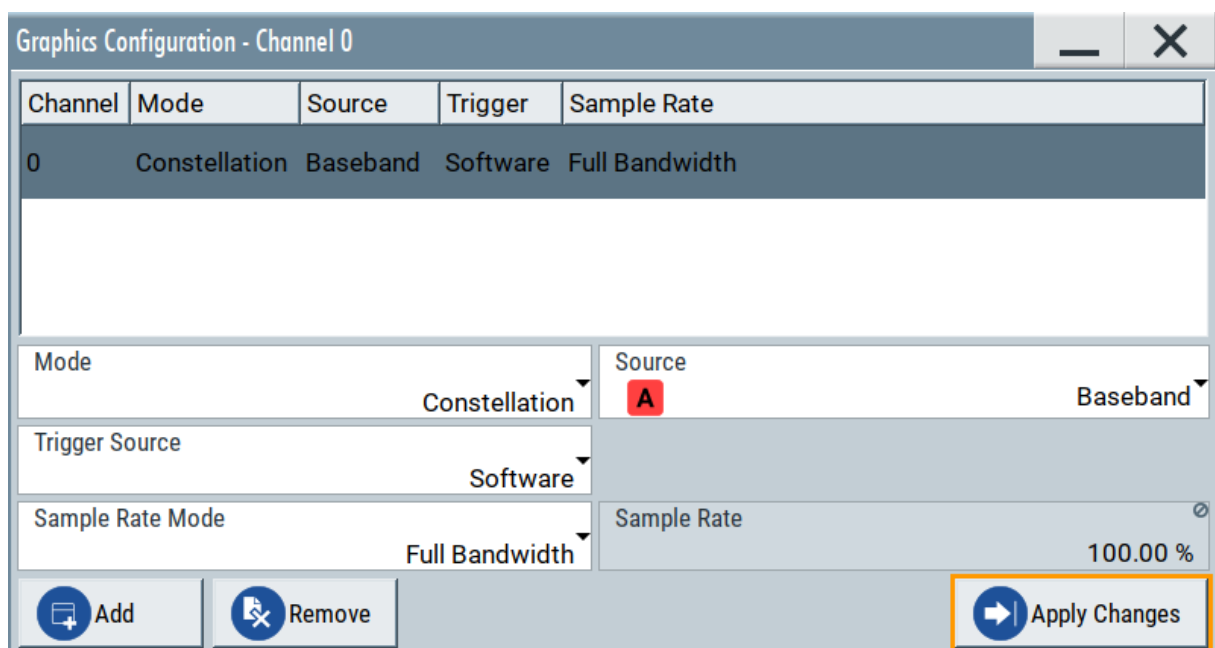

Verifying the generated signal with the graphics display

A new thumbnail (minimized view) indicating the active diagram appears in the "Taskbar".

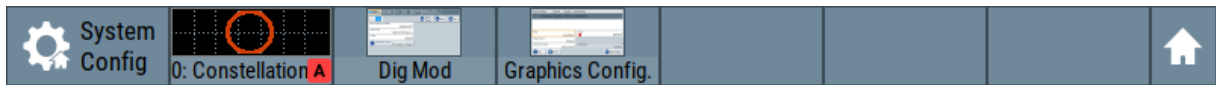

4. Press the thumbnail graphic.

The graphic enlarges and the diagram is displayed in a normal size.

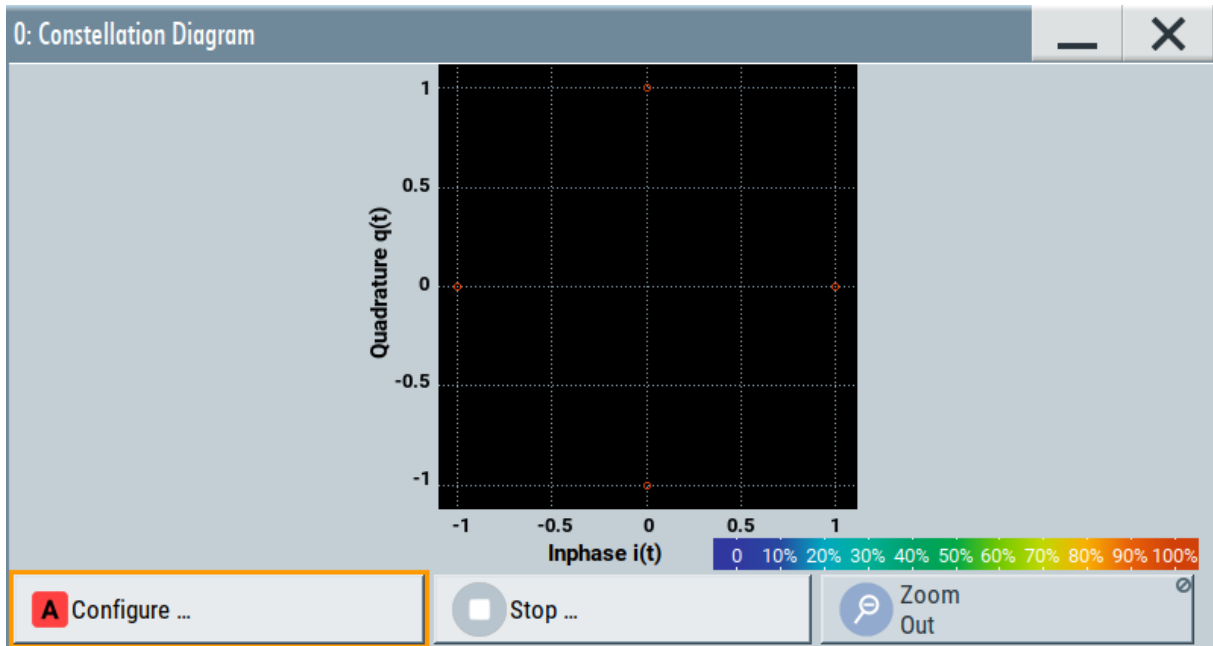

The "Constellation Diagram" displays the 3GPP FDD signal.

5. To retrieve more information, zoom in. In some diagrams you can select "Show Marker" to measure the distance, for example, between two signals. In principle, the zoom in function works like the two-finger pinching for magnifying images on your cellphone.
6. In the "Constellation Diagram" dialog, select "Configure" to return to the "Graphics Configuration" dialog.
Close the "Graphics Configuration" dialog.

This action has no effect on the configured graphics but on the dialog itself.

The block diagram displays the current signal routing. It indicates that frequency and power offsets are enabled and displays the acquisition points for the real-time diagrams minimized in the "Taskbar".

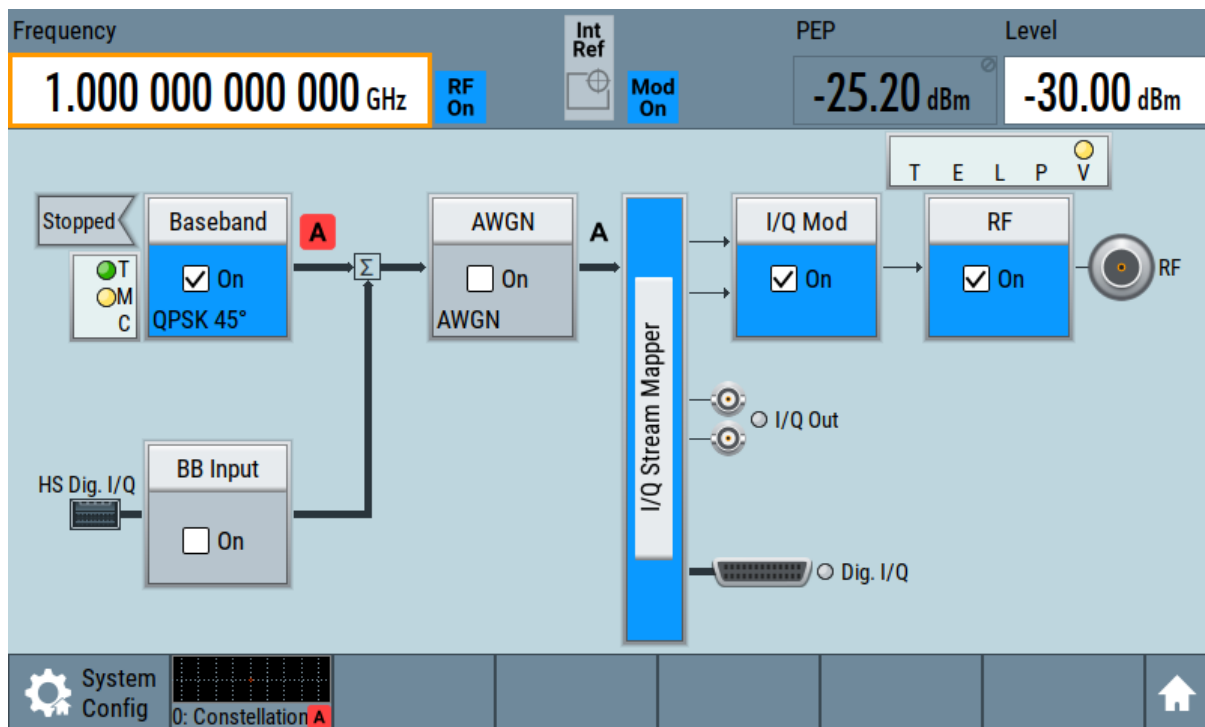

6.6 Saving and recalling settings

To restore the results of our measurements later, we save the instrument settings to a file.

To save the instrument settings to a file

We assume, a test configuration as described in [Chapter 6.4, "Enabling and configuring a marker signal"](#), on page 53.

1. Press the Save/Rcl key on the front panel.
2. In the "Save/Recall" dialog box, select "Operation Mode > Save".
Tap the "Filename", use the on-screen keyboard, and enter *MyTestSignal*.

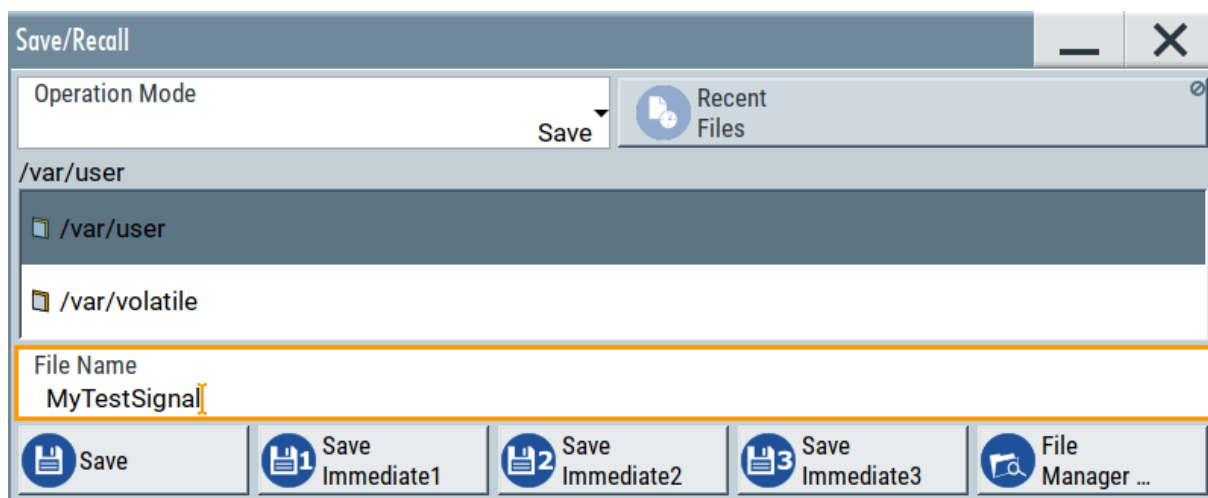

3. Tap the "Save" button.

The file `MyTestSignal.savrcltxt` is saved in the default directory `/var/user`.

To load saved instrument settings

You can restore the settings to the instrument at any time using the settings file.

1. Press the Preset button to restore the default instrument settings so you can check that the saved user settings are restored afterwards.
2. Press the Save/Rcl key.
3. In the "Save/Recall" dialog, select "Recall" operation. Navigate to the directory of the saved file. Select the `MyTestSignal` file.

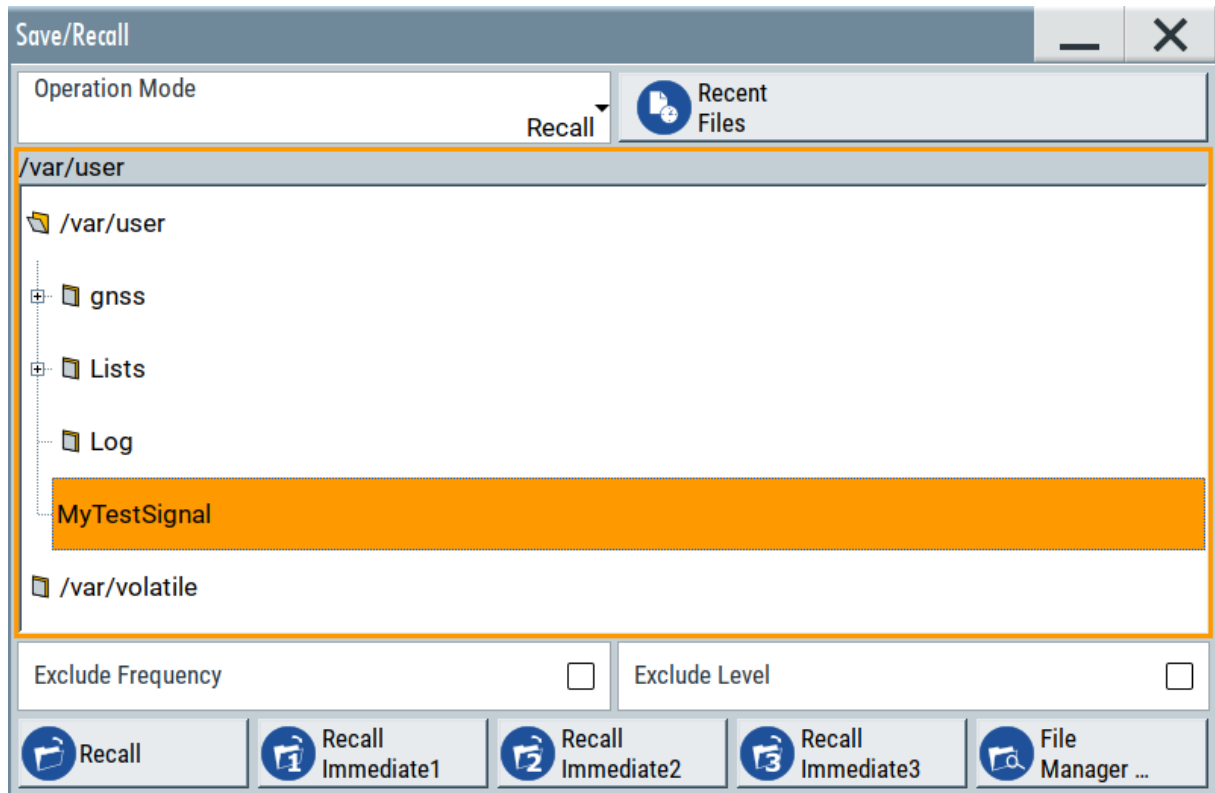

4. Tap the "Recall" button.

All instrument settings are restored and the display resembles the instrument display right before the settings were saved.

How to display all parameters with values different to their preset values

When you load a file to your instrument and do not have enough information on the changed settings, visualize all parameters that have been changed from their default state.

Try out the following:

- Tap and hold on an empty space in the block diagram to access the context-sensitive menu.
- Select "Mark All Parameters Changed from Preset".

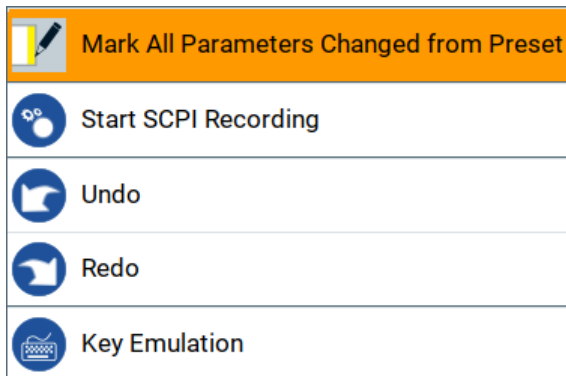

- All changed parameters are highlighted.

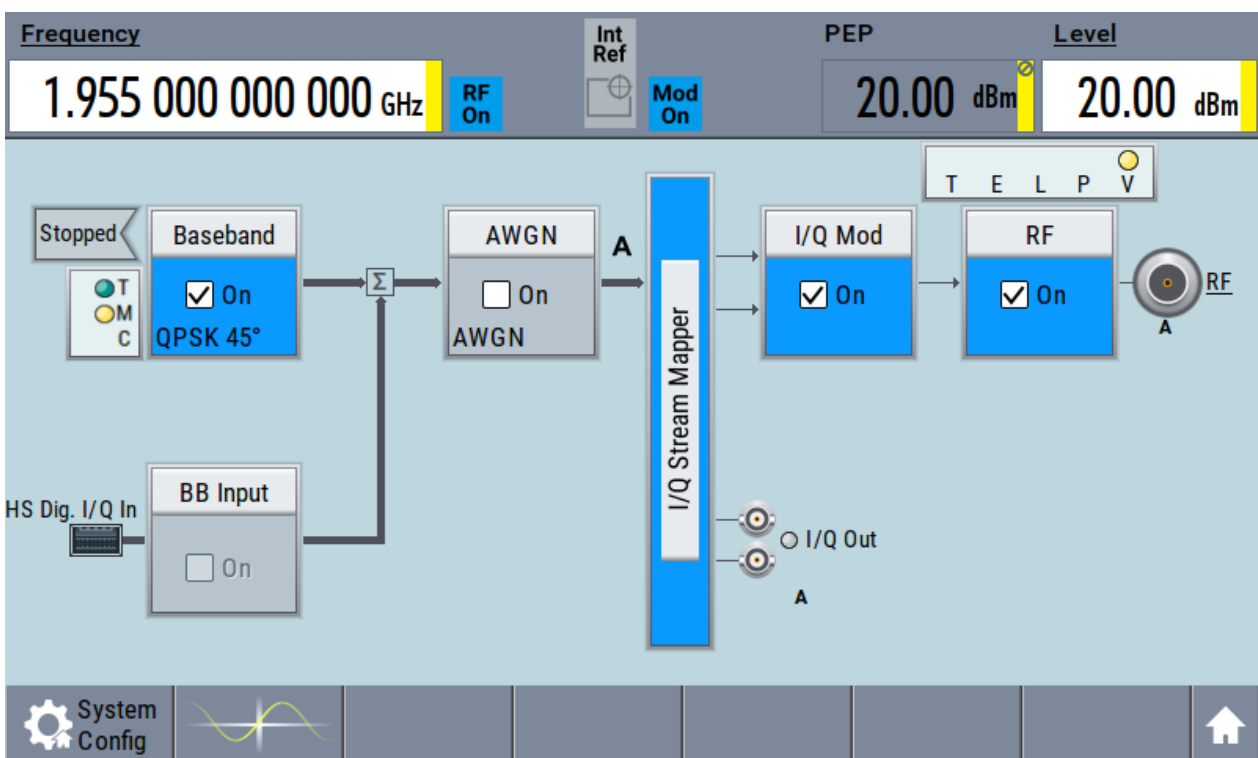

6.7 Generating an EUTRA/LTE signal

The main application field of the R&S SMBV100B is the generation of digital signals in accordance with several telecommunication and wireless standards, like WCDMA, EUTRA/LTE or WLAN, to name a few. This example uses the digital standard EUTRA/LTE to introduce the way you can access and interact with the instrument and experience the advantages provided by the additional options.

The minimum requirement for R&S SMBV100B in this example is a base unit equipped with:

- Option EUTRA/LTE R&S SMBVB-K55
- Option frequency R&S SMBVB-B103

To generate a downlink test signal

The main focus of the following example is not on the R&S SMBV100B capabilities and the features provided by the firmware option. The example aims rather to help you get familiar with the settings and configuration principle common for the digital standards.

We use one of the provided EUTRA test models (E-TM) to show how to generate a test signal upon a quick selection.

1. On the R&S SMBV100B front panel, press the Preset key to start out in a defined instrument configuration.
2. In the block diagram, select "Baseband > Beyond 3G Standards > EUTRA/LTE".

The EUTRA/LTE dialog appears and displays the general settings provided for the digital standard.

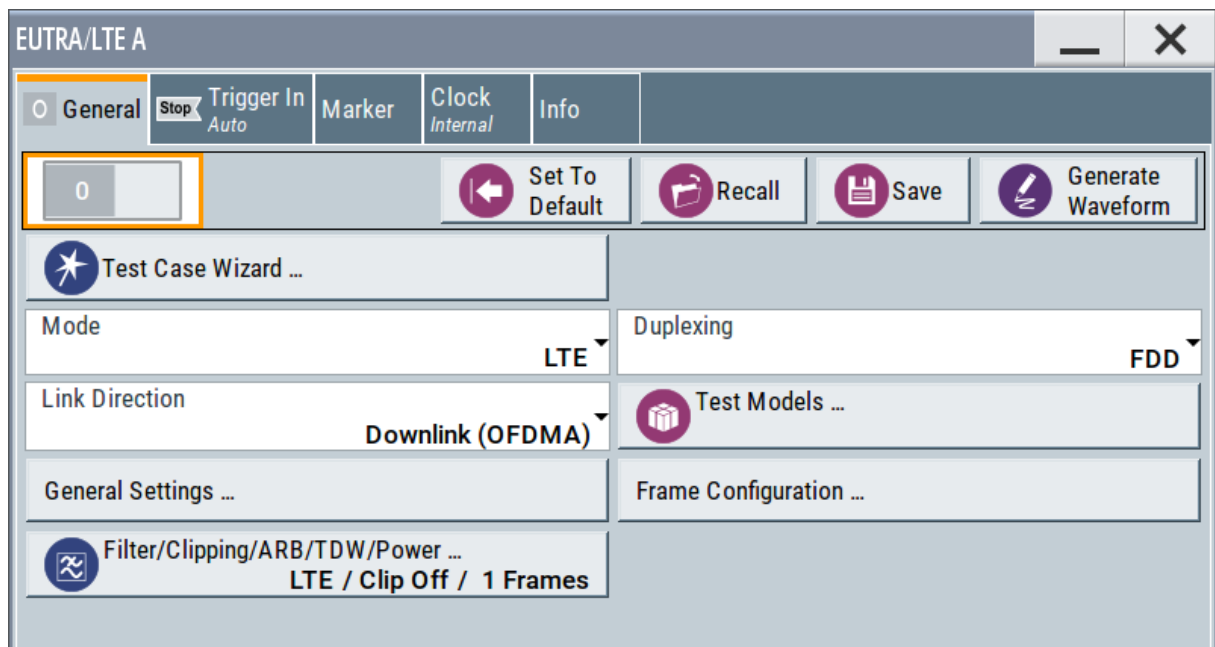

Generating an EUTRA/LTE signal

As in the user interfaces of all digital standards, the "EUTRA/LTE" dialog is divided into several tabs. The "General" tab comprises the primary settings of the standard, the functions for storing and recalling settings and provides access to further functions and dialogs, like the "Filter" settings. The "Trigger In", "Marker" and "Clock" tabs comprise the settings related to the corresponding function.

The more complex the digital standard itself is, the more comprehensive the further dialog and tab structure. The start dialog of each digital standard, however, follows a repeating dialog structure that comprises the tabs "General", "Trigger In", "Marker" and "Clock". (See also [Chapter 8.3.4, "Additional display characteristics"](#), on page 75).

Tip: To display the dialog in its maximal height, press the Resize window key on the front panel.

3. In the "EUTRA/LTE General" tab, select "Test Models".

The test models is a function for quick selection and settings adjustment according to one of the various EUTRA test models (E-TM).

A standard "File Select" function enables you to select from files with predefined settings.

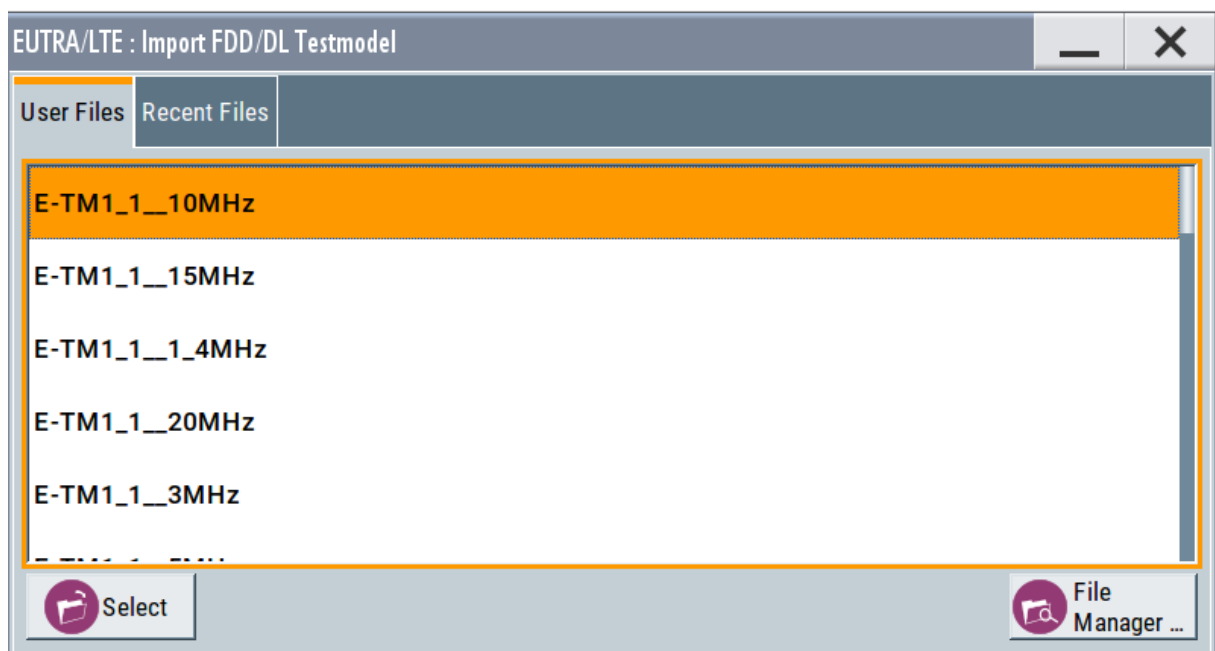

Tip: On the front panel, press the Help key to retrieve detailed information on the current settings and on the contents of the predefined files.

4. Navigate to a file, for example to the E-TM1_1_10MHz (an E-TM1.1 test model with 10 MHz channel bandwidth) and confirm with "Select".

Generating an EUTRA/LTE signal

The dialog closes automatically and the user interface confirms the name of the selected file.

- In the "EUTRA/LTE > General" tab, select "State > On".

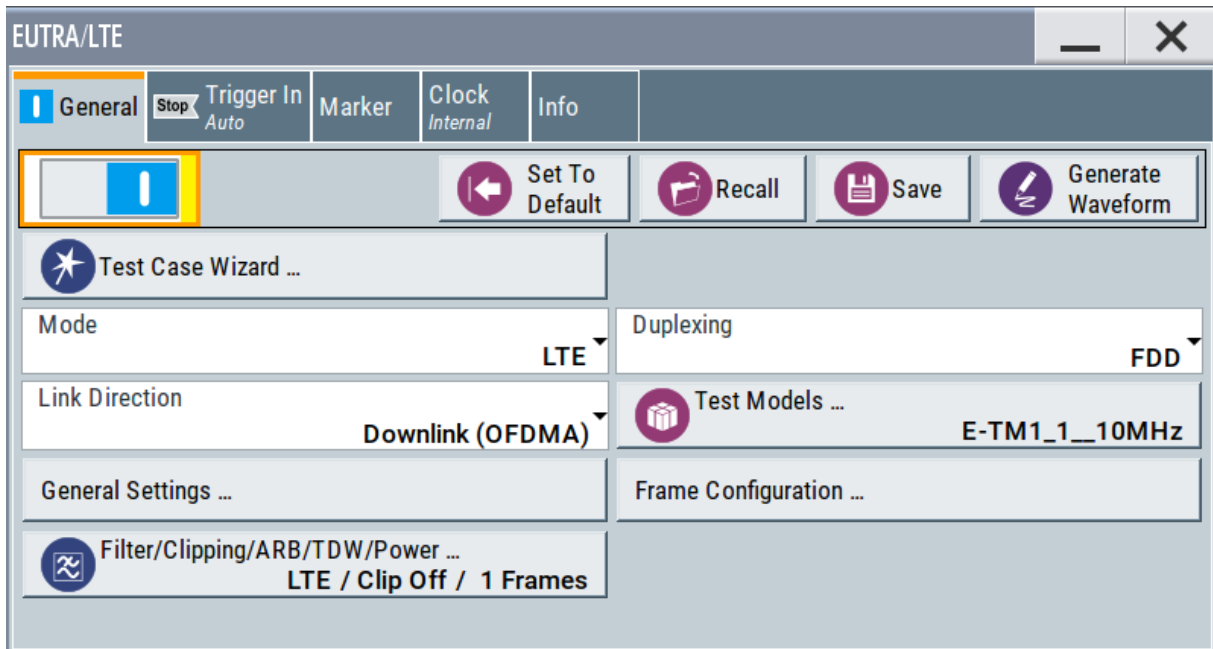

Close the dialog.

- On the "Status Bar", tap the "Frequency" and "Level" fields and enter new values, for example *2.1432 GHz* and *-20 dBm*.

Generating an EUTRA/LTE signal

Select "RF > On".

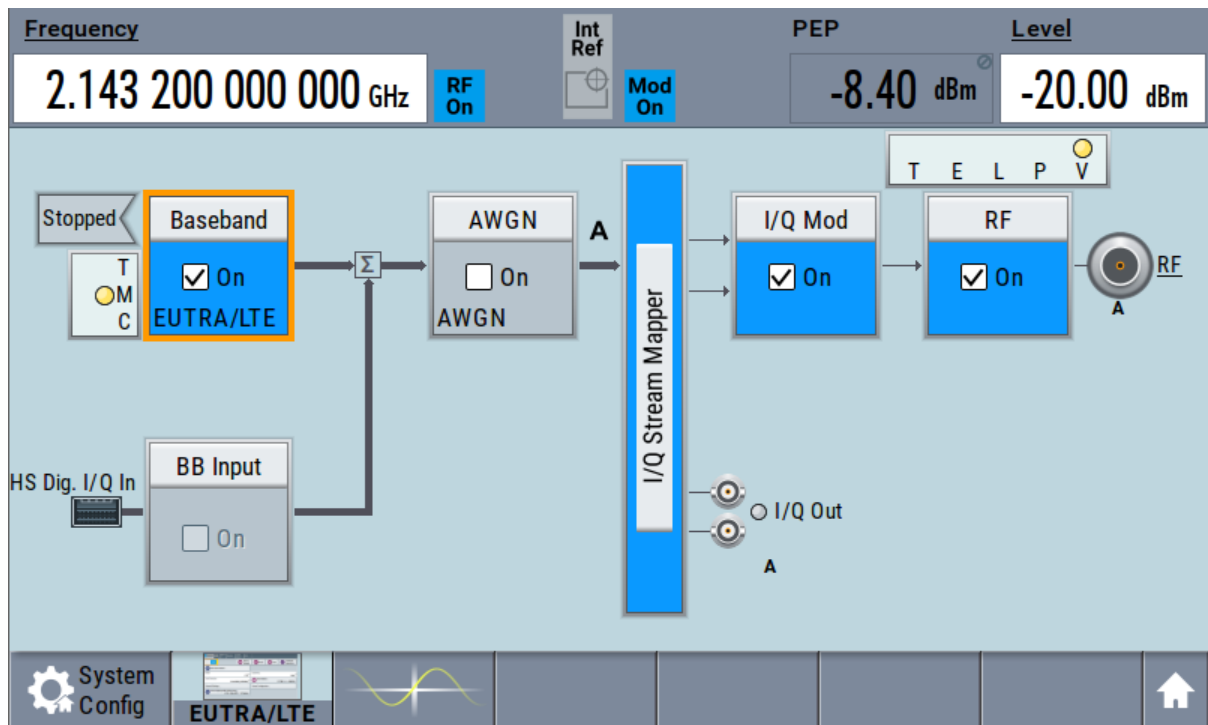

The instrument generates an EUTRA/LTE test signal with the selected channel bandwidth, frequency, and level.

💡 With these first steps, you have gained an impression of the provided functionality.

For a comprehensive description of the full range of capabilities, refer to the user manual "EUTRA/LTE Digital Standard for R&S SMBV100B".

7 System overview

This section helps you to get familiar with the R&S SMBV100B. It provides an introduction to the general concept of the instrument. This section also introduces the main blocks in the signal generation flow.

For information on how to access functions and interact with the R&S SMBV100B, refer to [Chapter 8, "Instrument control"](#), on page 70.

7.1 Brief introduction to the instrument's concept

The R&S SMBV100B offers excellent RF and baseband characteristics. The baseband section of the R&S SMBV100B is fully digital. It contains the hardware for generating and processing I/Q signals in realtime or generating signals with an arbitrary waveform generator.

7.2 Signal flow at a glance

The R&S SMBV100B is equipped with a large touchscreen, that displays a block diagram. The block diagram represents the signal flow and the general stages the signal generation goes through. Depending on the options the R&S SMBV100B is equipped with, the appearance of the block diagram changes.

The following examples do not cover all possible cases but aim to introduce the way the block diagram depicts the installed options.

- An example of a base unit, equipped with R&S SMBVB-B103.

Signal flow at a glance

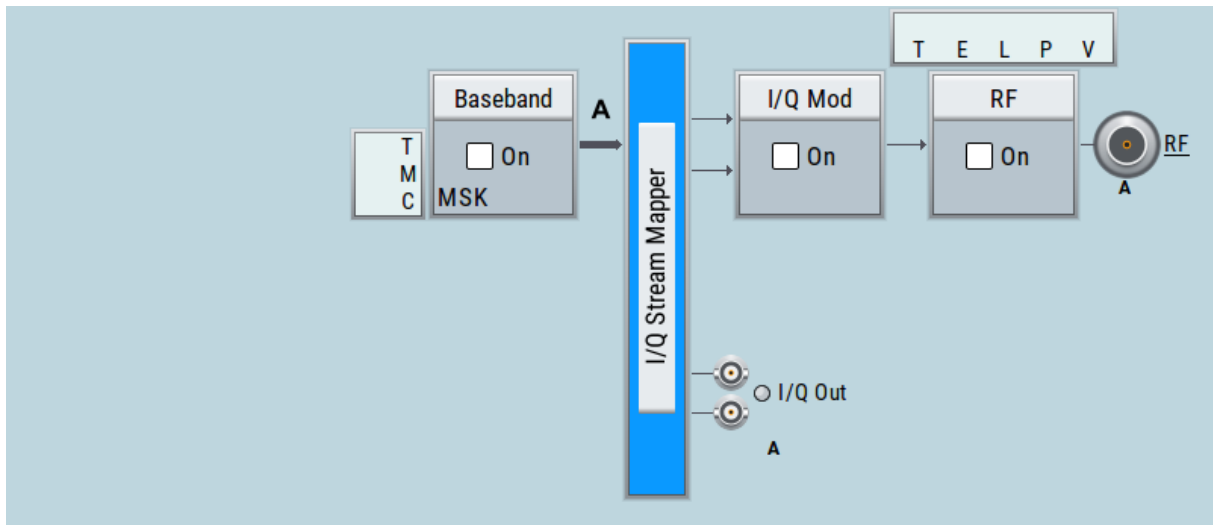

- An example of a fully equipped instrument. The block diagram displays all blocks for that the required hardware and software options are fitted. The block diagram shows the signal flow as it is.

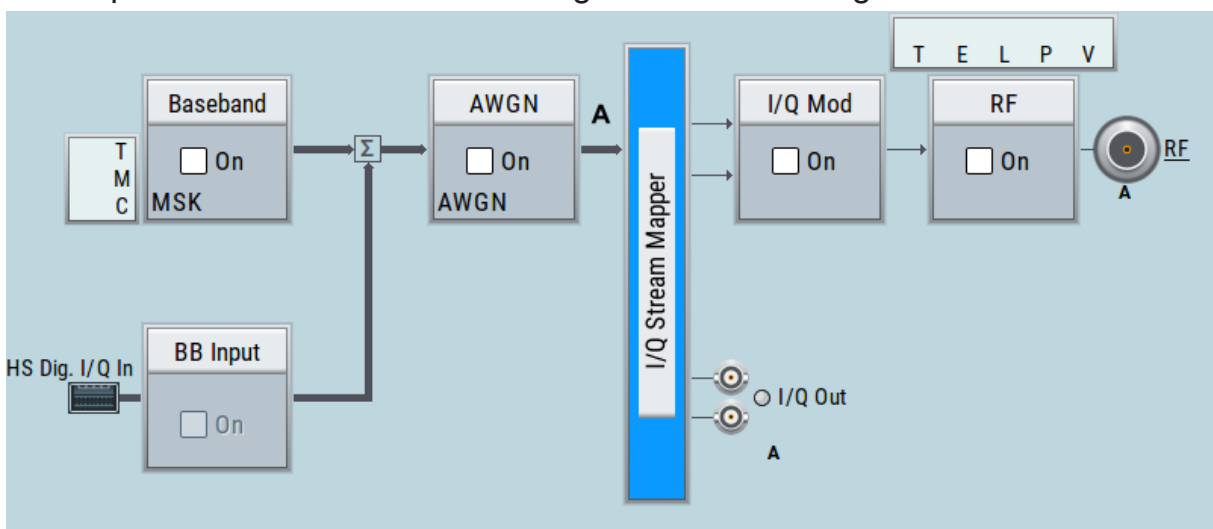

The cross-reference between the installed options and the displayed settings

The [Table 7-1](#) is an excerpt of the available options and lists only the options required *to display* a functional block in the block diagram. The information assumes R&S SMBV100B base unit.

For exact information on the available options, and on the minimum requirements and the interdependencies between the provided options, refer to the R&S SMBV100B data sheet.

Digital baseband input ("BB input"Block)

Table 7-1: Required options per functional block (excerpt)

| Functional block | Required option |
|---------------------|-----------------------|
| "Baseband" | - |
| "BB Input" | |
| "AWGN" | R&S SMBVB-K62 |
| "I/Q Stream Mapper" | - |
| "I/Q Mod" | - |
| "I/Q Analog" | - |
| "RF" | R&S SMBVB-B103/-KB106 |

7.3 Internal baseband source ("Baseband" block)

The "Baseband" block represents the source of the baseband signals (basebands).

This functional block is the access point to:

- *The internal baseband generator*
The baseband generator contains modules for real time signal generation (Custom Digital Modulation) and an arbitrary waveform generator (ARB).
- *The available digital standards*
Generation of digital signals in accordance with the supported standards requires additional software options. For example, option R&S SMBVB-K55 generates signals according to the EUTRA/LTE standard.
- *The baseband offsets function*
Signals from the baseband generator can be shifted in frequency and phase, or boosted in power.

7.4 Digital baseband input ("BB input"Block)

The "BB Input" block is the access point to the settings of the digital interfaces.

The R&S SMBV100B is able to receive and process digital baseband signals. The digital baseband input can be used together with other Rohde & Schwarz instruments, like signal generators. Note, however, that the internal and the exter-

I/Q modulator ("I/Q mod" block)

nal digital signals cannot be used simultaneously. The two blocks "Baseband" and "BB Input" deactivate each other.

The "BB Input" block is the access point to the settings of:

- *The external digital I/Q signals*
The external digital I/Q signals are further processed in the baseband section
- *The baseband offsets function*
The external and internal baseband signals can be shifted in frequency and phase, or boosted in power.

7.5 Additional white gaussian noise ("AWGN" block)

The "AWGN" block is displayed only in instruments equipped with the option R&S SMBVB-K62. This block controls the additional white Gaussian noise generator (AWGN). An additive white noise is required for measurements of mobile radio base stations.

7.6 "I/Q stream mapper" block

As one of the access points to the system configuration settings, the "I/Q Stream Mapper" provides direct access for mapping the generated I/Q streams to the available output connectors. That is, to the analog RF and I/Q output connectors.

7.7 I/Q modulator ("I/Q mod" block)

The "I/Q Mod" block represent the I/Q modulator.

This functional block is the access point to:

- The I/Q modulation of the internal baseband signal
- The I/Q modulation of an external single-ended analog wideband signal
- The analog I/Q impairments

7.8 Analog I/Q output ("I/Q analog" block)

The "I/Q Analog" block represents the analog I/Q output connectors.

This block is the access point to the settings of:

- The analog I/Q output signals
The generated signal can be output as single-ended or differential analog signal.
- The analog I/Q impairments

7.9 RF and analog modulations ("RF" block)

The "RF" block represents the RF settings of the instrument.

This block is the access point to:

- RF frequency and level settings, as well as the reference frequency, local oscillator, user correction, etc.
- The analog modulations
- The list and sweep modes

7.10 Applications examples of the R&S SMBV100B

The R&S SMBV100B can be optimally adapted to the requirements of different applications:

- Generation of digitally modulated signal
The main field of application of the R&S SMBV100B is the generation of digitally modulated signals. The R&S SMBV100B generates a digitally modulated signal in several ways: using the internal baseband generator, using the externally applied digital baseband signals or in an analog wideband I/Q operation.
- Generation of a wanted signal or an interfering signal for receiver tests
- Generation of signals with up to 500 MHz signal bandwidth

8 Instrument control

This chapter provides an overview on how to work with the R&S SMBV100B.

It covers the following topics:

| | |
|---|----|
| • Possible ways to operate the instrument | 70 |
| • Means of manual interaction | 71 |
| • Understanding the display information | 72 |
| • Accessing the functionality | 77 |
| • Entering data | 79 |
| • Getting information and help | 81 |
| • Remote control | 83 |
| • Remote operation over VNC | 83 |

8.1 Possible ways to operate the instrument

There are three ways to operate the R&S SMBV100B:

- **Manual operation:**
Use the touchscreen, hard keys and rotary knob, or an optional mouse and/or keyboard.
- **Remote control:**
Create programs to automatize repeating settings, tests and measurements. The instrument is connected to a computer running the program. This way of operation is described in the user manual, chapter "Network and Remote Control Operation".
- **Remote operation from a computer:**
Remote monitoring and control of the instrument from a connected computer is based on the common cross-platform technology VNC (Virtual Network Computing). On the remote computer, any standard web browser (supporting Java) or a dedicated VNC client (like Ultr@VNC) can be used. See also [Chapter 8.8, "Remote operation over VNC"](#), on page 83.

The following sections show how to operate the instrument manually.

8.2 Means of manual interaction

For the manual interaction with the R&S SMBV100B, you have several methods that you can use as an alternative to perform a task:

- **Touchscreen:**
Touchscreen operation is the most direct way to interact. Almost all control elements and actions on the screen are based on the standard operating system concept. You can tap any user interface element to set parameters in dialog boxes, enter data, scroll within a dialog etc., as if you work with a mouse pointer.
Tapping the screen works like clicking mouse buttons:
 - Touch quickly = click: Selects a parameter or provokes an action.
 - Touch and hold = right-click: Opens a context-sensitive menu.
 - Touch and swipe = drag: Scrolls through the contents of a display element larger than the screen, e.g. a list or a table.
 - Spread or pinch two fingers = zoom out, zoom in:
Increases or decreases the size of an area in a graphical display as it works on your cell phone
- **Function keys and rotary knob:**
The front panel provides nearly all functions and controls to operate the instrument in the classic way, without touchscreen.
- **Optional mouse and/or keyboard:**
These devices work like known from PCs. The navigation keys on the front panel correspond to the keys on the keyboard.

This manual describes the manual interaction with the instrument via the touchscreen. It mentions the alternative methods using the keys on the instrument or the on-screen keypads if it deviates from the standard operating procedures. The usage of the touchscreen and navigation keys is described in [Chapter 8.4, "Accessing the functionality"](#), on page 77.

Throughout the manual, the term "select" refers to any of the following methods:

- Using a finger on the touchscreen
- Using a mouse pointer in the display
- Using a key on the instrument or on a keyboard

8.3 Understanding the display information

The block diagram of the R&S SMBV100B displays all main settings and generator states, divided into three main operation areas.

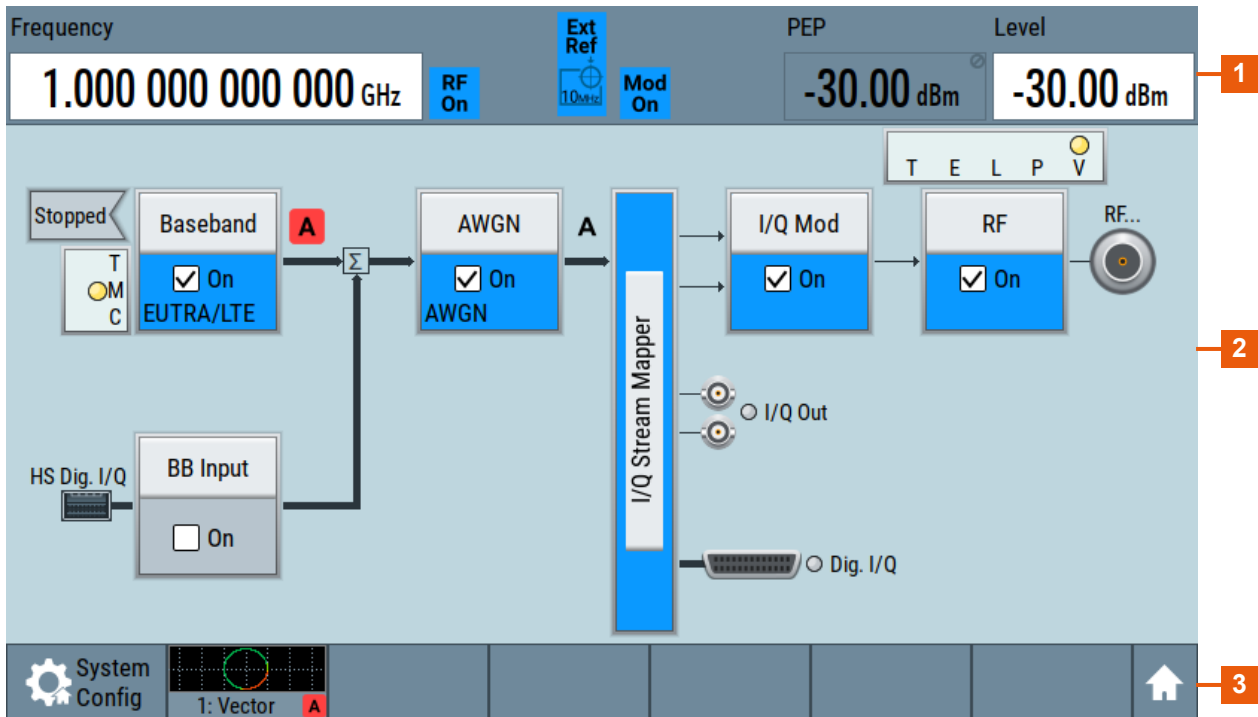

Figure 8-1: Block diagram

- 1 = Status bar (frequency and level display)
- 2 = Block diagram
- 3 = Taskbar/softkey bar

| | |
|--|----|
| • Status bar | 72 |
| • Block diagram | 73 |
| • Taskbar | 74 |
| • Additional display characteristics | 75 |

8.3.1 Status bar

The status bar at the top of the screen indicates the RF frequency and the level of the output signal provided to the DUT. You can set both parameters directly here.

Understanding the display information

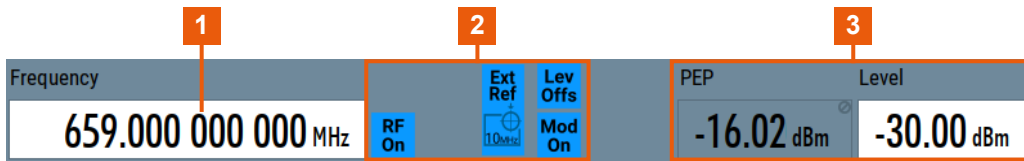

- 1 = Frequency display
- 2 = Status buttons
- 3 = Level display

The status buttons indicate key parameters that are set for the output signal. Most of the status buttons are virtual keys that you can use to open a corresponding menu or dialog.

8.3.2 Block diagram

The block diagram shows the current configuration and the signal flow in the generator with the aid of function blocks, connected by signal lines.

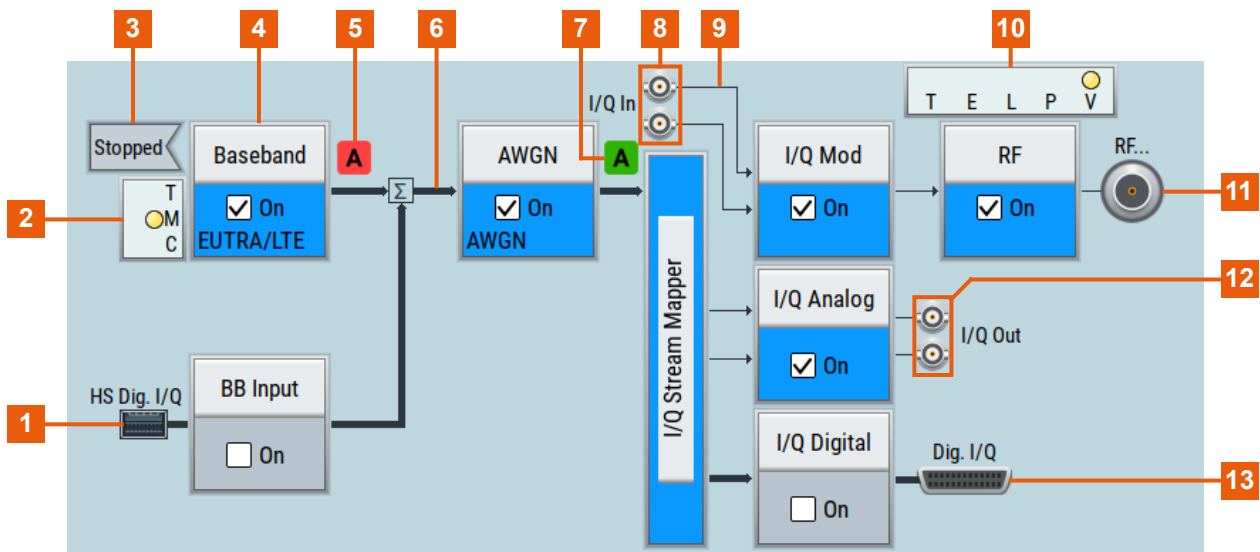

- 1, 8, 11, 12, 13 = Connector icons (RF, analog, digital)
- 2, 10 = Control signal block
- 3 = Status indicator
- 4 = Functional block
- 5, 7 = Graphics indicator
- 6 = Signal line (digital)
- 9 = Signal line (analog)

Starting from left up to the "I/Q Stream Mapper", you can see the functional blocks provided in the baseband domain. After the stream mapper, the analog section contains the digital to analog conversion and modulation to RF.

Understanding the display information

| Legend | Item | Description |
|--------------------------|---|---|
| 1 8 11 12 13 | Connector icons | Represent the interfaces for signal input and output: <ul style="list-style-type: none"> • Digital I/Q signal connector input (1) • Analog I/Q signal connector input (8) • RF signal connector output (11) Icons vary depending on the frequency. <ul style="list-style-type: none"> • Analog I/Q signal connector output (12) • Digital I/Q signal connector output (13) |
| 2 10 | Control signal block | Indicates information on the control signals like signal content, input or output and provides quick access to the corresponding configuration dialog. A dedicated control block is displayed to the left of the baseband block (2) and above the RF block (10). |
| 3 | Status indicator | Indicates whether the signal is running or waiting for a trigger. |
| 4 | Functional block | Represents a basic task in signal generation. The push button provides access to any number of associated actions to accomplish the task. "On/Off" (checkbox) and the block label quickly activates the basic task. |
| 5 7 | Graphics indicator | Denotes that the signal is displayed graphically: Baseband signal (5), stream signal (7) |
| 6 9 | Signal line <ul style="list-style-type: none"> • digital • analog | Shows the currently configured signal flow: <ul style="list-style-type: none"> • Thick lines represent the digital I/Q streams (6). • Thin lines represent the analog signals (9). |

8.3.3 Taskbar

The "Taskbar" contains labeled softkeys and minimized views (thumbnails) of active graphics and dialogs.

Initially, it shows the permanently assigned softkeys. The softkey with the sine wave denotes that no signal is activated for graphical representation.



Figure 8-2: Taskbar in default state

Whenever you open a settings or graphics dialog, it is automatically assigned to the "Taskbar". The softkeys shown in the following figure represent the variants.

Understanding the display information

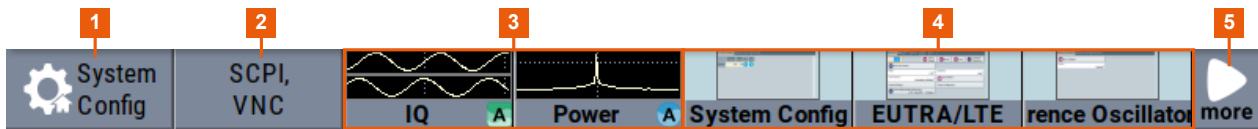

Figure 8-3: Taskbar fully assigned

- 1 = System configuration
- 2 = Remote control connections
- 3 = Graphics
- 4 = Dialogs
- 5 = Diagram / more

| | | |
|---|----------------|--|
| 1 | System Config | Provides access to general system configurations like setup, display, or remote. |
| 2 | Remote | Shows the established remote connections when the instrument is remotely controlled. Tip: An indicator in the status bar shows the current remote control status. |
| 3 | Graphics | Shows that a signal is represented graphically. |
| 4 | Dialogs | Shows a dialog as a thumbnail, the dialog name, and the name of signal channel. |
| 5 | Diagram / more | The diagram icon as shown in Figure 8-2 minimizes all dialogs indicated on the screen. The block diagram is in the foreground. The "More" softkey indicates that more dialogs are open than can be displayed in the taskbar. Use this softkey to open a selection list with the remaining active dialogs, and the "Diagram" function. |

8.3.4 Additional display characteristics

The following section provides a short insight on the indication of the screen in general, and significant elements that you see under specific operating modes, in dialogs or settings.

- **Appearance of active elements**
 - *Active* elements like On/Off switches, state buttons have a **blue** background.
 - *Selected* elements are framed or highlighted **orange**.
 - *Inactive* elements are **gray**.
- **On-Screen keypads**

Understanding the display information

As additional means of interacting with the instrument without having to connect an external keyboard, either a numerical or alphanumerical on-screen keypad appears when you activate an entry field (see [Chapter 8.5, "Entering data"](#), on page 79).

- **Info line**

The "Info line" shows brief status information and error messages. It appears when an event generates a message. If selected, the R&S SMBV100B shows information on static errors and the error history.

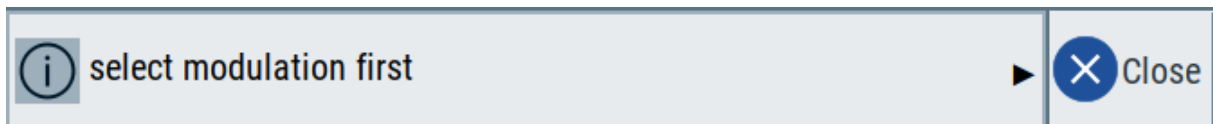

- **Key parameters indicated in tab labels**

Most dialogs are divided into tabs with logically grouped parameters. The tab label expresses the content and can also contain status indicators or the set value of a key parameter.



1 = Status indicators

2 = Key parameter values

- **Scroll bar handle**

An arrow icon that appears when you touch a scroll bar helps you to scroll in a dialog or list.

- **Progress indicators**

A busy icon indicates a currently running process. If a process takes some time, a progress bar shows the current state.

- **Context-sensitive menus**

Within the entire screen display, including single parameters, you can access context-sensitive menus that provide some additional functions.

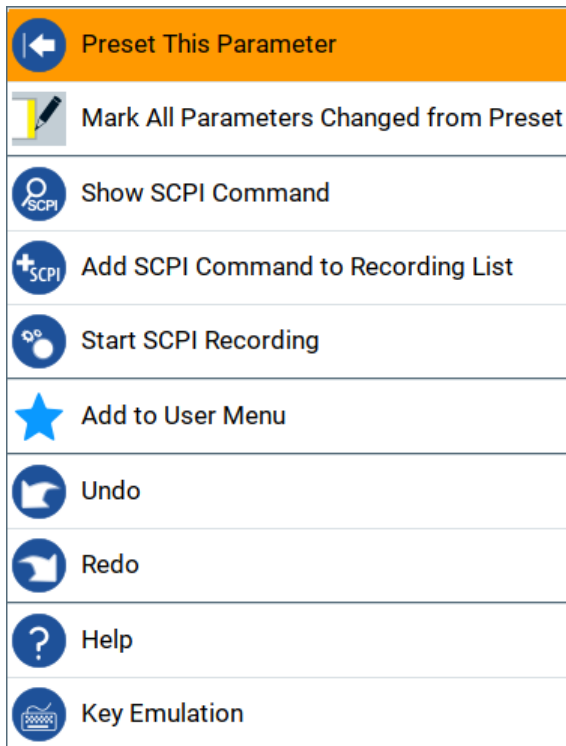

8.4 Accessing the functionality

All functionalities are provided in dialog boxes as known from computer programs. You can control the instrument intuitively with the touchscreen. This section provides an overview of the accessing methods.

The instrument's functions and settings can be accessed by selecting one of the following elements:

- System and function keys on the front panel of the instrument
- Taskbar/softkeys on the touchscreen
- Context-sensitive menus for specific elements on the touchscreen, or with the rotary knob (press and hold).
- Elements on the status bar in the touchscreen
- Displayed setting on the touchscreen that means block diagram and all settings available in dialogs.

To open a dialog box

- ▶ Perform one of the following actions:

- Tap the required block, and then the menu entry.
- Tap the minimized view (thumbnail) on the taskbar.

Some of the utility keys access a dedicated dialog, too.

To minimize a dialog box

- ▶ Tap the "Minimize" icon in the upper right corner.

To close a dialog box

To close a dialog box, you have the same controls as you know from computers or devices with touchscreen.

- ▶ Perform one of the following actions:
 - Tap the "Close" icon in the upper right corner.
 - Press the [Esc] key on the front panel.
 - Drag and drop a minimized dialog from the taskbar to the block diagram.

To select an option in a dialog box

- ▶ Tap the required option.

To select an option in a list

If many options are available - for example, for the trigger mode - the options are provided in a list. The current selection is shown on the list button.

1. Tap in the list.
2. To navigate through the list, try out the following:
 - Using a mouse, scroll in the list to tap the required option.
 - Use the rotary knob.
 - Use [On/Off Toggle] key to select the succeeding option
 - Use the front panel keys:
 - a) Press the [Left/Right] arrow keys to navigate to the list button.
 - b) Press the [Enter] key to open the list.
 - c) Press the [Up/Down] keys to navigate to the required option in the list.
 - d) Press the [Enter] key to select the marked option.

8.5 Entering data

Some parameters have their own key on the front panel.

For data input in dialog boxes, the instrument provides on-screen keypads for entering numeric and alphanumeric values. Thus, you can always set the parameters via the touchscreen, the front panel, or an external keyboard.

To correct an entry

1. Using the arrow keys, move the cursor to the right of the entry you want to delete.
2. Press the [Backspace] key.
3. Deletes the entry to the left of the cursor.
4. Enter your correction.

To complete the entry

- ▶ Press the [Enter] key or the rotary knob.

To abort the entry

- ▶ Press the [Esc] key.
The dialog box closes without changing the settings.

8.5.1 Entering numeric parameters

To enter values with the on-screen keypad

For numeric settings, the instrument displays the numeric keypad. The units specified correspond to the units of the parameter.

1. Enter the numeric value.
Tip: For quick entry, you can enter a value in exponential representation, e.g. $1e7$ for 10000000 .
2. Tap the unit button to complete the entry.
The unit is added to the entry.

Tip: For quick unit change, you can enter shortcuts, e.g. for a frequency value *1e8h* for *100 MHz*.

For an overview of shortcuts supported by the R&S SMBV100B, see chapter "Unit Shortcuts" in the appendix of the user manual.

3. If the parameter does not require a unit, confirm the entered value by pressing "Enter".

To enter values by using the front panel controls

1. Change the currently used parameter value by using the rotary knob or the [Up/Down] keys.
2. If the parameter does not require a unit, confirm the entered value by pressing the [Enter] key or any of the unit keys.
The instrument highlights the editing line to confirm the entry.

If you edit numeric data in tables, the entry field must be in edit mode: Press [Enter], or the rotary knob to activate the edit mode.

8.5.2 Entering alphanumeric parameters

If a field requires alphanumeric input, you can use the on-screen keyboard to enter letters and (special) characters.

8.5.3 Undo and redo actions

Accessed via the context-sensitive menus, "Undo" allows you to restore one or more actions on the instrument. Depending on the available memory, the "Undo" steps can restore all actions.



"Redo" restores a previously undone action.

8.6 Getting information and help

In some dialog boxes, graphics are included to explain the way a setting works.

For further information, you can use the following sources:

- Tooltips give the value range of the parameter.
- The context help provides functional description on a setting.
- The general help explains a dialog box, provides instructions, and general information.

To display context help

- ▶ To access a help topic, perform one of the following:
 - a) Tap and hold the parameter for which you need information and tap "Help" in the context menu.
 - b) Tap the parameter and press the [Help] key.

The "Help" dialog opens. You can browse the help for further information.

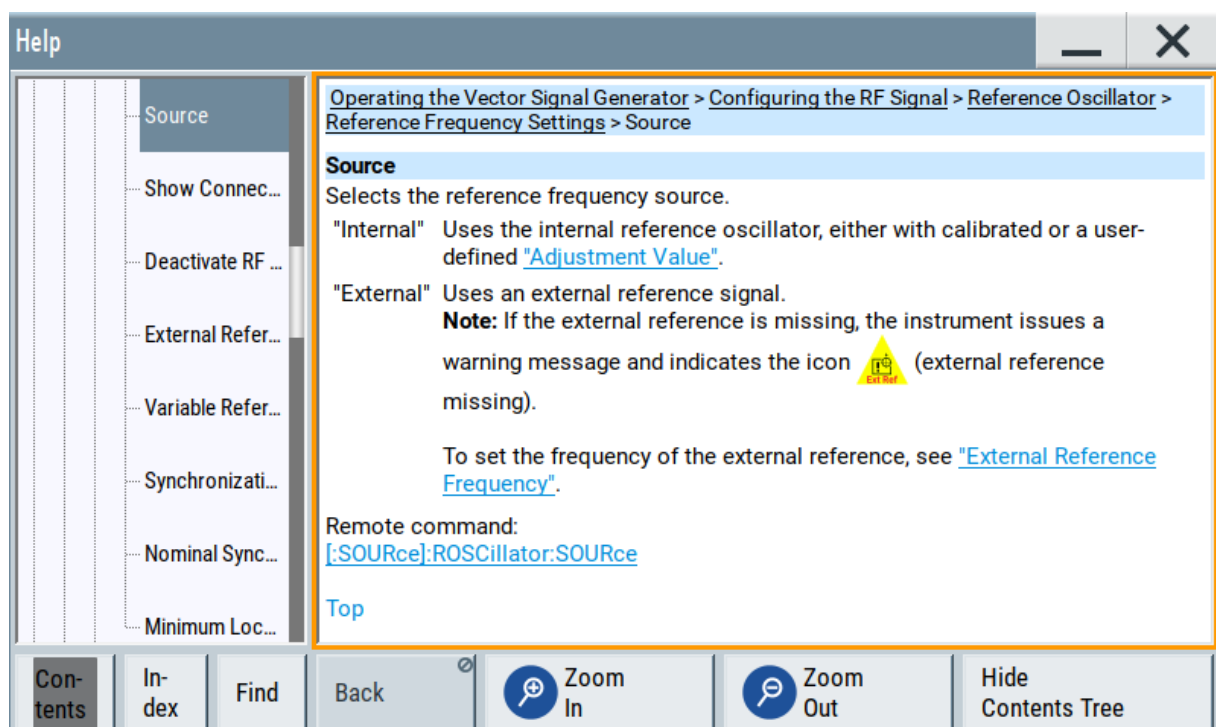

Contents of the help dialog box

The help dialog box covers two main areas:

- "Contents" - contains a table of help contents

- "Topic" - contains a specific help topic

The help system also provides an "Index" and a "Find" area, and "Zoom" functions that are accessed via the corresponding buttons.

To open general help

- ▶ Press the yellow [Help] key on the front panel.
If a dialog box is opened, the help topic for the current tab is shown. Otherwise the "Contents" page appears.

Navigating in the table of contents and in the help topics

1. To move through the displayed contents entries, tap on an entry and scroll or use a connected mouse or the [Up/Down] keys.
Entries with a plus sign contain further entries.
2. To display a help topic, tap on the topic name or double-click the topic name or press the [Enter] key.
3. To follow a cross-reference, tap on the link text.
4. To return to the previous page, select "Back".
This function scrolls back all steps you have performed before.
5. Use the "scroll bars" to shift the visible section of content shown.
6. To maximize the "Topics" area, tap the "Hide Contents Tree" button to hide the contents tree.

Using the index

1. Select the "Index" button.
2. Enter the first characters of the topic you are interested in.
The entries starting with these characters are displayed.
3. Tap on the index entry.
The corresponding help topic is displayed.

8.7 Remote control

In addition to working with the R&S SMBV100B interactively, located directly at the instrument, it is also possible to operate and control it from a remote PC.

The R&S SMBV100B supports various methods for remote control:

- Connecting the instrument to a LAN (see [Chapter 4.7, "Connecting to LAN"](#), on page 22)
- Using the LXI browser interface in a LAN
- Connecting a PC via the IEC-bus (IEEE 488) interface
- Remote control via the USB interface



For remote control over LAN or USB, you can use the R&S VISA (Virtual Instrument Software Architecture) library provided for download at the Rohde & Schwarz website <http://www.rohde-schwarz.com/rsvisa>.

How to configure the remote control interfaces is described in the user manual, chapter "Network and remote control operation".

8.8 Remote operation over VNC

The VNC is an application which can be used to access and control the instrument from a remote computer through a LAN connection. While the instrument is in operation, the instrument screen contents are displayed on the remote computer, and VNC provides access to all applications, files, and network resources of the instrument. Thus, remote operation of the instrument is possible.



Instrument control from a remote computer

To access the basic utility functions of the R&S SMBV100B, perform a right mouse click the block diagram and select "Key Emulation".

A key panel to the right of the block diagram gives access to the utility functions provided by the front panel keys.

The VNC is an add-on program, included in operating system Linux/Unix, and available as a free-of-charge download on the internet.

See also the R&S SMBV100B user manual, chapter "To operate the instrument using VNC".

9 Contacting customer support

Technical support – where and when you need it

For quick, expert help with any Rohde & Schwarz product, contact our customer support center. A team of highly qualified engineers provides support and works with you to find a solution to your query on any aspect of the operation, programming or applications of Rohde & Schwarz products.

Contact information

Contact our customer support center at www.rohde-schwarz.com/support, or follow this QR code:



Figure 9-1: QR code to the Rohde & Schwarz support page

Index

- A**
- Active elements 75
 - Alphanumeric parameters 80
 - Application cards 15
 - Application notes 15
 - ARB 67
 - Arrow keys 35
- B**
- Baseband
 - Input 67
 - Baseband generator 67
 - BB Input 67
 - Bench top, placing 18
 - Block diagram
 - Display 73
 - Brochures 14
- C**
- Carrying the instrument 17
 - Cfast card 38
 - Checking the instrument 17
 - Connecting
 - Keyboard 23
 - LAN 22
 - Memory stick 23
 - Mouse 23
 - Power 22
 - To HS Dig I/Q 27
 - To LO In/LO Out 26
 - To Ref In/Ref Out 27
 - To RF 26
 - To RF coaxial connectors 24
 - USB devices 23
 - Connecting to RF coaxial connectors
 - To connect to pluggable connectors ... 25
 - To connect to screwable connectors ... 25
 - To prepare for connecting 24
 - Connector
 - AC power supply 40
 - Control signal 40
 - Data 40
 - DIFF I/Q 39
 - Differential output 39
 - Digital IQ 39
 - GPIB 38
 - High-speed digital IQ 39
 - I 39, 40
 - I Bar 39
 - IEC/IEEE 38
 - Inst Trig 41
 - LAN 39
 - LF 40
 - LO In 40
 - LO Out 40
 - Mod Ext 40
 - Pulse Ext 41
 - Pulse Video 41
 - Q 39, 40
 - Q Bar 39
 - Ref In 40
 - Ref Out 40
 - RF 36
 - Sensor 36
 - Signal Valid 41
 - Single-ended output 39
 - USB 37, 38
 - USB In 38
 - User 36
 - USER 38
 - Connectors 37
 - Context-sensitive menu 75
 - Custom Digital Modulation 67
 - Customer support 85
- D**
- Data entry 79
 - Data sheets 14
 - Dialog boxes 77
 - Digital standard 67
 - Display
 - Active elements 75
 - Block diagram 73
 - Context-sensitive menu 75
 - Info line 75
 - Information 72
 - On-screen keypad 75
 - Status bar 72
 - Tab labels 75
 - Taskbar 74
 - Documentation overview 13

- E**
- Emulating front panel keys 83
- F**
- Firmware options
 - see Software options 67
 - Function keys
 - Details - see user manual 33
 - Overview 33
- G**
- Getting started 13
- H**
- Head panel
 - See Status bar 31
 - Header
 - See Status bar 31
 - Help 13, 81
 - Hotspot 74
- I**
- Info line 75
 - Input connector 36, 38, 39, 40, 41
 - Instrument
 - Carrying 17
 - Checking 17
 - Lifting 17
 - Operating site 18
 - Unpacking 17
 - Instrument control 70
 - Instrument help 13
 - Instrument security procedures 14
- K**
- Key 33, 35
 - ★ (User) 33
 - Access on a remote computer 83
 - Backspace 33, 34
 - Down 35
 - Emulation 83
 - Enter 33, 34
 - Esc 33, 34
 - Freq 33
 - Help 32
 - Home 33
 - Left 35
 - Level 33
 - Local 32
 - Mod on/off 33
 - Next window 35
 - On/Off Toggle 33, 35
 - On/Standby 32
 - Preset 32
 - Resize window 35
 - RF on/off 33
 - Right 35
 - Save/Rcl 32
 - Setup 32
 - Up 35
 - Keyboard
 - On-screen 79
 - Usage 71
 - Keypad
 - On-screen 79
 - Overview 33
- L**
- LAN
 - Connecting 22
 - Environment 22
 - LF out
 - Connector 39
 - Lifting the instrument 17
 - Loading
 - Trying out 58
- M**
- Manual interaction 71
 - Mass storage
 - Removable 38
 - Mounting, in a rack 20
 - Mouse
 - Usage 71
- N**
- Navigation keys 35
 - Network
 - Environment 22
 - Numeric data entry 79
 - Numeric parameters 79
- O**
- On-screen keyboard 80
 - On-screen keypad 75
 - Open source acknowledgment (OSA) 15
 - Operating site
 - Choosing 18
 - Setting up the instrument 18

| | | | |
|--------------------------------------|--------------------|---------------------------------|----|
| Operation | | Status bar | |
| Manual | 71 | Display | 72 |
| Option | | Switching | |
| R&S SMBVB-K16 | 39 | On or off | 28 |
| R&S SMBVB-K19 | 39 | T | |
| Options | | Tab labels | 75 |
| see User Manual | 67 | Text entry | 79 |
| Output connector | 36, 38, 39, 40, 41 | Tooltips | |
| Output connectors | | Show | 81 |
| RF | 36 | Touchscreen | |
| P | | Compared with mouse | 71 |
| Parameters | | Overview | 31 |
| Entering | 79, 80 | Usage | 71 |
| Placing, on a bench top | 18 | U | |
| Power | | Unpacking the instrument | 17 |
| Connecting the instrument | 22 | User manual | 13 |
| Power on | | Utility keys | |
| Key | 32 | Details - see user manual | 32 |
| Power supply | | Overview | 32 |
| Connector | 40 | V | |
| Preparing for use | 17 | Videos | 15 |
| R | | VNC | |
| Rack, mounting | 20 | Using in a LAN | 83 |
| Release notes | 15 | W | |
| Remote access | | White papers | 15 |
| see Remote operation from a computer | | | |
| | 70 | | |
| Remote control | 83 | | |
| Remote operation | 83 | | |
| Removable | | | |
| Mass storage | 38 | | |
| Non-Volatile Memory | 38 | | |
| RF connector | 36 | | |
| Rotary knob | 34 | | |
| S | | | |
| Safety instructions | 7, 14 | | |
| Saving | | | |
| Trying out | 57 | | |
| Security procedures | 14 | | |
| Serial number | 37 | | |
| Service manual | 14 | | |
| Softkey bar | | | |
| See Taskbar | 74 | | |
| Software options | 67 | | |
| Standby | | | |
| Key | 32 | | |