

R&S® Scope Rider RTH Handheld Oscilloscope Getting Started



1326156102
Version 10

ROHDE & SCHWARZ
Make ideas real



This manual describes the following R&S®RTH models:

- R&S®RTH1002 (1317.5000.K02)
- R&S®RTH1004 (1317.5000.K04)

© 2024 Rohde & Schwarz

Muehldorfstr. 15, 81671 Muenchen, Germany

Phone: +49 89 41 29 - 0

Email: info@rohde-schwarz.com

Internet: www.rohde-schwarz.com

Subject to change – data without tolerance limits is not binding.

R&S® is a registered trademark of Rohde & Schwarz GmbH & Co. KG.

Trade names are trademarks of the owners.

1326.1561.02 | Version 10 | R&S®Scope Rider RTH

Throughout this document, R&S® is indicated as R&S.

Contents

| | |
|---|-----------|
| 1 Safety and regulatory information..... | 5 |
| 1.1 Safety instructions..... | 5 |
| 1.2 Warning messages in the documentation..... | 10 |
| 1.3 Where to find key documents on Rohde & Schwarz..... | 11 |
| 1.4 Korea certification class A..... | 11 |
| 1.5 Regulatory information..... | 12 |
| 2 Preface..... | 14 |
| 2.1 Key features..... | 14 |
| 2.2 Main specifications..... | 14 |
| 2.3 Input isolation..... | 18 |
| 2.4 Documentation overview..... | 19 |
| 3 Preparing for use..... | 21 |
| 3.1 Unpacking the instrument..... | 21 |
| 3.2 Handling the battery..... | 22 |
| 3.3 Powering on/off..... | 24 |
| 3.4 Using the tilt stand..... | 24 |
| 3.5 Considerations for test setup..... | 25 |
| 4 Instrument tour..... | 26 |
| 4.1 Front view..... | 26 |
| 4.2 Top view..... | 28 |
| 4.3 Right view..... | 30 |
| 4.4 Left view..... | 31 |
| 4.5 Rear view..... | 32 |
| 4.6 Display overview..... | 32 |

| | |
|---|-----------|
| 5 Operating the instrument..... | 34 |
| 5.1 Connecting probes..... | 34 |
| 5.2 Connecting test leads (R&S RTH1002)..... | 35 |
| 5.3 Accessing the functionality..... | 36 |
| 5.3.1 Using the touchscreen..... | 36 |
| 5.3.2 Using the navigation wheel..... | 38 |
| 5.3.3 Using front panel keys..... | 42 |
| 5.4 Displaying an unknown signal..... | 44 |
| 5.5 Selecting the mode..... | 45 |
| 5.6 Setting the date, time and language..... | 45 |
| 5.7 Getting information and help..... | 46 |
| 5.7.1 Displaying help..... | 47 |
| 5.7.2 Using the help window..... | 48 |
| 6 Maintenance and support..... | 50 |
| 6.1 Cleaning..... | 50 |
| 6.2 Information for technical support..... | 50 |
| 6.3 Data storage and security..... | 51 |
| 6.4 Transporting, storing and packing..... | 51 |
| 6.5 Disposal..... | 52 |
| 7 Contacting customer support..... | 53 |

1 Safety and regulatory information

The product documentation helps you to use the product safely and efficiently.

Where do I find safety information?

Safety information is part of the product documentation. It warns you of potential dangers and gives instructions on how to prevent personal injury or damage caused by dangerous situations. Safety information is provided as follows:

- In [Chapter 1.1, "Safety instructions"](#), on page 5. The same information is provided in many languages in printed format. The printed "Safety Instructions" for "R&S®Scope Rider RTH" are delivered with the product.
- Throughout the documentation, safety instructions are provided when you need to take care during setup or operation.

The R&S RTH handheld scope is designed for measurements up to measurement category CAT IV 600 V and CAT III 1000 V.

The product is intended for the development, production and verification of electronic components and devices in industrial, administrative and laboratory environments, and for usage in the field. Use the product only for its designated purpose. Observe the operating conditions and performance limits stated in the specifications document.

1.1 Safety instructions

Products from the Rohde & Schwarz group of companies are manufactured according to the highest technical standards. To use the products safely, follow the instructions provided here and in the product documentation. Keep the product documentation nearby and offer it to other users.

Use the product only for its intended use and within its performance limits. Intended use and limits are described in the product documentation such as the specifications document, manuals and the printed "Safety Instructions" document. If you are unsure about the appropriate use, contact Rohde & Schwarz customer support.

Using the product requires specialists or specially trained personnel. These users also need sound knowledge of at least one of the languages in which the user interfaces and the product documentation are available.

Reconfigure or adjust the product only as described in the product documentation or the specifications document. Any other modifications can affect safety and are not permitted.

Never open the casing of the product. Only service personnel authorized by Rohde & Schwarz are allowed to repair the product. If any part of the product is damaged or broken, stop using the product. Contact Rohde & Schwarz customer support at <https://www.rohde-schwarz.com/support>.

Choosing the operating site

The product is designed for usage according to its protection class noted in the specifications document. Interpret the protection class as follows:

- IP51: Protection against dust and vertically falling drops of water or condensation.
- IP54: Protection against splashing water from any direction.

The protection class listed in the specifications document only applies to battery operation. If you operate the product with an external power supply, you can use it indoors only in pollution degree 2 environments where nonconductive contamination can occur. To maintain the protection class, always cover the openings of the product. Water that enters can electrically connect the casing to live parts.

Observe the ambient conditions such as altitude, operating temperature and climatic loading; see the specifications document.

Setting up the product

You can carry the product with you, in your hands or in a carrying accessory designed for the product to leave your hands free for work.

If you put the product down, place its rear side on a flat and level surface, e.g. a table.

If you use the product in a vehicle, install it in the vehicle mount provided for this purpose. Secure the product safely so that it cannot fall out and hurt passengers when the vehicle is moving.

Handling batteries safely

The product contains exchangeable or built-in lithium polymer or lithium ion cells or batteries. The use of the word battery in the following always means all types. Only the battery contents are potentially hazardous. As long as a battery is undamaged and the seals remain intact, there is no danger.

Impact, shock or heat can cause damage such as dents, punctures and other deformations. A damaged battery poses a risk of personal injury. Handle a damaged or leaking battery with extreme care. Immediately ventilate the area since the battery releases harmful gases. If you come into contact with the battery fluid, immediately remove all contaminated clothing. Irritation can occur if the battery fluid comes in contact with your skin or eyes. Immediately and thoroughly rinse your skin or eyes with water and seek medical aid.

For safe handling, follow these rules:

- Do not short-circuit the battery.
- Do not mechanically damage the battery. Do not open or disassemble the battery.
- Do not expose the battery to high temperatures such as open flames, hot surfaces and sunlight.
- Only use the battery with the designated Rohde & Schwarz product.
- Only use the appropriate Rohde & Schwarz charger to charge the batteries. If the batteries are improperly charged, there is a risk of explosion. For charging and discharging temperature ranges, see the product documentation.
- Replace exchangeable batteries only with the same battery type.
- Store the battery in the product or use the product packaging.
- Dispose of exchangeable batteries separately from normal household waste as specified by the local waste disposal agency.

If you disregard these rules, you risk serious personal injury or even death due to explosion, fire or hazardous chemical substances. The product documentation provides further details.

If exchangeable batteries or products with built-in batteries are defective, contact the Rohde & Schwarz customer service. Rohde & Schwarz classifies the severity of the defect. When returning batteries or Rohde & Schwarz products containing batteries, use a carrier qualified to transport dangerous goods and notify the carrier of this classification. Follow the carrier's transport stipulations in line with IATA-DGR, IMDG-Code, ADR or RID.

Connecting to power

If you connect the product to an external power supply, use the one delivered with the product or recommended in the product documentation. The external power supply must conform to the country-specific regulations.

Performing measurements

Take the following measures for your safety:

- Voltages higher than 30 V RMS, or 42 V peak, or 60 V DC are regarded as hazardous contact voltages. When working with hazardous contact voltages, use protective measures to preclude direct contact with the measurement setup:
 - Do not touch exposed connections and components when power is applied.
 - Use only insulated voltage probes, test leads and adapters.
- Make sure that only personnel familiar with the potential risks of measuring electrical quantities controls the instrument. Observe applicable local or national safety regulations and rules for the prevention of accidents.
- Use only specified probes and accessories that comply with the measurement category (CAT) of your measurement task. If you use other than Rohde & Schwarz accessories, make sure that they are suitable for the instrument and the measurement task.
- Observe all voltage and current ratings of the instrument, the probes, and the accessories. The lowest rated component defines the rating of the complete measurement setup. Limits and ratings are marked on the products and listed in the specifications documents.

For probes, consider that the rated voltage depends on the frequency. The voltage limitation curves are provided in the specifications document. Do not exceed these two ratings:

- The maximum measurement voltage from the probe tip to the probe reference lead.
- The maximum floating voltage from the probe reference lead to the ground.
- Set the correct attenuation factor on the instrument according to the probe being used. Otherwise, the measurement results do not reflect the actual voltage level, and you might misjudge the actual risk.
- Set up all connections to the instrument before applying power.
- Do not open the instrument casing.

Safety instructions

- Do not use the instrument if the instrument casing, the display or any probe or accessory are damaged. If you detect or suspect any damage, have the instrument or accessory inspected by qualified service personnel.
- Do not operate the instrument in wet, damp or explosive atmospheres. Make sure that all connectors are completely dry before connecting the inputs.
- Observe the operating conditions specified in the specifications document.

Measurement categories

IEC 61010-2-030 defines measurement categories that rate instruments on their ability to resist short transient overvoltages that occur in addition to the working voltage. Use the measurement setup only in electrical environments for which they are rated.

- 0 - Instruments without rated measurement category
For measurements performed on circuits not directly connected to mains, for example, electronics, circuits powered by batteries, and specially protected secondary circuits. This measurement category is also known as CAT I.
- CAT II:
For measurements performed on circuits directly connected to the low-voltage installation by a standard socket outlet, for example, household appliances and portable tools.
- CAT III:
For measurements performed in the building installation, such as junction boxes, circuit breakers, distribution boards, and equipment with permanent connection to the fixed installation.
- CAT IV:
For measurements performed at the source of the low-voltage installation, such as electricity meters and primary overcurrent protection devices.

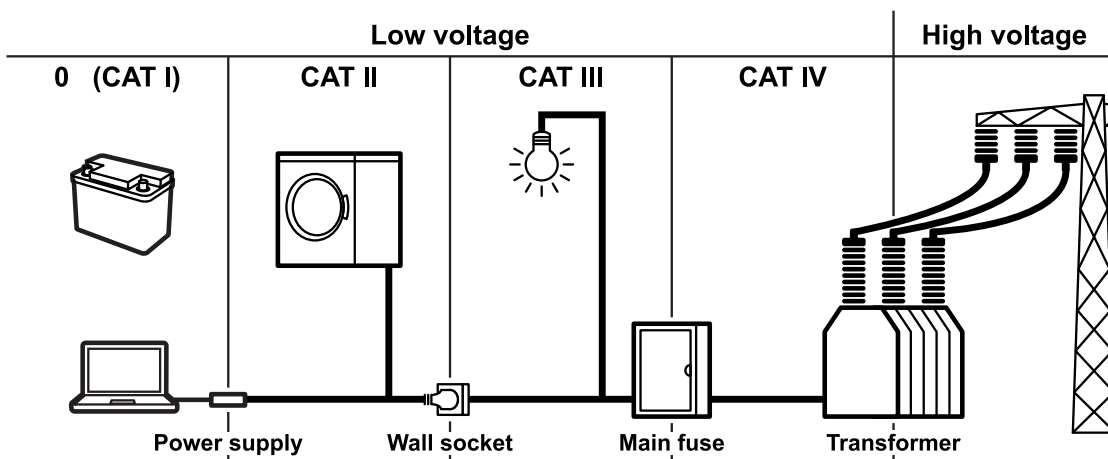

Checking the product for damage

Check the product regularly to ensure that it is undamaged. If you have dropped the product or exposed it to excessive mechanical stress, always check the product. A damaged product can have sharp edges or damaged protection against electromagnetic radiation thus posing a risk of injury.

Cleaning the product

Remove all probes, leads, USB and LAN cables and power supply before cleaning the instrument.

Use a dry, lint-free cloth to clean the product. If the product has protection class IP51 or higher, you can use a standard screen cleaner. Ensure that the cloth is not wet, only damp. When cleaning, keep in mind that the casing is only water-proof up to the specified protection class. Do not use cleaning agents that can damage the instrument such as solvents, acids or alkalis.

Meaning of safety labels

Safety labels on the product warn against potential hazards.

| | |
|---|--|
|  | <p>Potential hazard Read the product documentation to avoid personal injury or product damage.</p> |
|---|--|

| | |
|---|---|
|  | <p>DC - direct current Connect to a DC power supply of the specified voltage range.</p> |
|---|---|

1.2 Warning messages in the documentation

A warning message points out a risk or danger that you need to be aware of. The signal word indicates the severity of the safety hazard and how likely it will occur if you do not follow the safety precautions.

WARNING

Potentially hazardous situation. Could result in death or serious injury if not avoided.

CAUTION

Potentially hazardous situation. Could result in minor or moderate injury if not avoided.

NOTICE

Potential risks of damage. Could result in damage to the supported product or to other property.

1.3 Where to find key documents on Rohde & Schwarz

Certificates issued to Rohde & Schwarz that are relevant for your country are provided at www.rohde-schwarz.com/key-documents, e.g. concerning:

- Quality management
- Environmental management
- Information security management
- Accreditations

1.4 Korea certification class A



이 기기는 업무용(A급) 전자파 적합기기로서 판매자 또는 사용자는 이 점을 주의하시기 바라며, 가정외의 지역에서 사용하는 것을 목적으로 합니다.

1.5 Regulatory information

Part 15 of the FCC and RSS-210 of IC Rules

This device complies with Part 15 of the FCC Rules and with Industry Canada licence-exempt RSS standard(s). Operation is subject to the following two conditions:

- this device may not cause harmful interference, and
- this device must accept any interference received, including interference that may cause undesired operation.

Le présent appareil est conforme aux CNR d'Industrie Canada applicables aux appareils radio exempts de licence. L'exploitation est autorisée aux deux conditions suivantes:

- l'appareil ne doit pas produire de brouillage, et
- l'utilisateur de l'appareil doit accepter tout brouillage radioélectrique subi, même si le brouillage est susceptible d'en compromettre le fonctionnement.

Changes or modifications made to this equipment not expressly approved by Rohde & Schwarz may void the FCC authorization to operate this equipment.

This equipment has been tested and found to comply with the limits for a Class A digital device, pursuant to Part 15 of the FCC Rules. These limits are designed to provide reasonable protection against harmful interference when the equipment is operated in a commercial environment. This equipment generates, uses, and can radiate radio frequency energy and, if not installed and used in accordance with the instruction manual, may cause harmful interference to radio communications. Operation of this equipment in a residential area is likely to cause harmful interference in which case the user will be required to correct the interference at his own expense.

Administrative Regulations on Low Power Radio Waves Radiated Devices warning (Republic of China/Taiwan)

Article 12

- Without permission granted by the NCC, any company, enterprise, or user is not allowed to change frequency, enhance transmitting power or alter original characteristic as well as performance to a approved low power radio-frequency devices.

Article 14

- The low power radio-frequency devices shall not influence aircraft security and interfere legal communications; If found, the user shall cease operating immediately until no interference is achieved.
- The said legal communications means radio communications is operated in compliance with the Telecommunications Act.
- The low power radio-frequency devices must be susceptible with the interference from legal communications or ISM radio wave radiated devices.

LP0002 Warning Statement

- 經審驗合格之射頻電信終端設備，非經許可，公司、商號使用者均不得擅自變更頻率、加大功率或變更原設計之特性及功能。
- 射頻電信終端設備之使用不得影響飛航安全及干擾合法通信；經發現有干擾現象時，應立即停用，並改善至無干擾時方得繼續使用。所謂合法通信係指依電信法規定作業之無線電信。
- 輸入、製造射頻電信終端設備之公司、商號或其使用者違反本辦法規定，擅自使用或變更無線電頻率、電功率者，除依電信法規定處罰外，電信總局並得撤銷其審驗合格證明。

2 Preface

2.1 Key features

The R&S RTH is the perfect multipurpose tool for the lab and in the field. Outstanding key features are:

- Full isolation of all channels and interfaces
- CAT IV 600 V / CAT III 1000 V safety rating
- Bandwidth 60 MHz to 500 MHz with 5 GS/s sampling rate
- Acquisition speed up to 50.000 waveforms per second
- 2 mV/div sensitivity
- Up to 200 V offset range
- 33 automatic measurement functions
- Full operation using touch or keypad
- Wireless LAN and Ethernet for web based remote control and quick data access (optional)

The R&S RTH combines:

- Lab performance oscilloscope
- Logic analyzer with 8 digital inputs (optional)
- Protocol analyzer with trigger and decode (optional)
- Data logger
- Digital multimeter (R&S RTH1002)

2.2 Main specifications

This chapter lists the main characteristics of the R&S RTH. The complete specifications are listed in the specifications document, see [Chapter 2.4, "Documentation overview"](#), on page 19.

Input channels

- R&S RTH1002: 2 oscilloscope channels, 1 multimeter
- R&S RTH1004: 4 oscilloscope channels

Maximum input voltage

- At BNC inputs: CAT IV 300 V
- With probe R&S RT-ZI10 or R&S RT-ZI11: CAT IV 600 V, CAT III 1000 V
- Meter input: CAT IV 600 V; CAT III 1000 V

Voltage ratings: V RMS (50 to 60 Hz) for AC sine wave and V DC for DC applications.

Vertical system

- Analog bandwidth (–3 dB) of oscilloscope channels:
 - R&S RTH1002 and R&S RTH1004: ≥ 60 MHz
 - R&S RTH1002 with -B221 option and R&S RTH1004 with -B241 option: ≥ 100 MHz
 - R&S RTH1002 with -B222 option and R&S RTH1004 with -B242 option: ≥ 200 MHz
 - R&S RTH1002 with -B223 option and R&S RTH1004 with -B243 option: ≥ 350 MHz
 - R&S RTH1002 with -B224 option and R&S RTH1004 with -B244 option: ≥ 500 MHz
- Rise time (calculated):
R&S RTH1002 and R&S RTH1004 with bandwidth of 60 MHz, 100 MHz, 200 MHz, 350 MHz, 500 MHz: < 5.8 ns, < 3.5 ns, < 1.75 ns, < 1 ns, < 700 ps respectively
- DC gain accuracy:
Offset and position set to zero after self-alignment
 - Input sensitivity > 5 mV/div: ± 1.5 % of reading
 - Input sensitivity > 2 mV/div to 5 mV/div: ± 2 % of reading
 - input sensitivity 2 mV/div: ± 2.5 % of reading
- Input impedance: $1\text{ M}\Omega \pm 1\%$ || $12\text{ pF} \pm 2\text{ pF}$ (meas.)
- Input coupling: DC, AC
- Input sensitivity: 2 mV/div to 100 V/div

- Offset
 - Offset range depends on input sensitivity:
 - Input sensitivity ≥ 40 V/div: 0
 - Input sensitivity ≥ 1 V/div to ≤ 20 V/div: ± 200 V
 - Input sensitivity ≤ 500 mV/div: ± 4 V

Horizontal system

- Timebase range: selectable between 1 ns/div and 500 s/div
- Timebase accuracy: ± 10 ppm

Acquisition system

- Maximum real-time sampling rate
 - 1 / 2 / 4 channels active: 5 / 2.5 / 1.25 Gsample/s respectively
- Acquisition modes: sample, high resolution, peak detect, average, envelope
- Max. acquisition length
 - 1 / 2 / 4 channels active: 500 / 250 / 125 ksample/channel respectively

Trigger system

- Trigger modes: auto, normal, single
- Trigger types:
 - Standard: edge, glitch, width, TV/video (PAL, NTSC, SECAM, PAL-M)
 - Optional: TV/video (DTV and HDTV), pattern, state, slew rate, window, runt, data2clock, serial pattern, timeout, interval, protocol
- Trigger level ± 4 div from center of screen

Analysis features

- 4 active automatic waveform measurements
- Cursor measurements
- Mask testing with up to 5 simultaneous masks
- Waveform mathematics
- Data logger
- True RMS Digital Multimeter (R&S RTH1002 only)
 - Resolution: 4 digits, 10,000 counts

Main specifications

- Measurements: voltage: DC, AC, AC+DC, resistance, continuity test, diode test, capacitance, temperature (with PT 100 temperature probe), frequency, current (with current clamp or shunt)
- Protocol trigger and decode (optional)
- Logic analysis with 8 additional digital inputs (optional)

General data

- Display: 7.0" LC TFT color display with 800 × 480 pixel resolution (WVGA)
- Weight with battery: 2.4 kg (5.3 lb) (nom.)
- Dimensions W x H x D:
201 mm x 293 mm x 74 mm (7.91 in x 11.54 in x 2.91 in)
- Interfaces: USB host, USB device, LAN
- Internal storage medium: removable 4 Gbyte microSD card

Power supply

- Power adapter
 - Input: 100 V to 240 V AC, 50 Hz to 60 Hz, 1.5 A
 - Output: +15 V DC, 4.0 A
- Lithium-ion rechargeable smart battery
voltage 11.25 V; capacity 72.0 Wh

Environmental conditions

- Operating temperature
 - Battery only: 0 °C to +50 °C
 - Power adapter: 0 °C to +40 °C
- Storage temperature: –20 °C to +50 °C
- Climatic loading: +25° C/+55 °C at 95 % rel. humidity cyclic, in line with IEC 60068-2-30
- Altitude
 - Operating:
CAT IV 600 V, CAT III 1000 V: up to 2000 m above sea level
CAT III 600 V, CAT II 1000 V: up to 3000 m above sea level
 - Nonoperating: up to 4600 m above sea level
- Pollution degree 2

IP rating

- IP51 in line with IEC 60529

Safety compliance

- IEC / EN / DIN EN 61010-1
- IEC / EN / DIN EN 61010-2-030
- IEC / EN / DIN EN 61010-2-033 (R&S RTH1002)
- UL / CSA 61010-1
- UL / CSA 61010-2-030
- UL / CSA 61010-2-033 (R&S RTH1002)

EMC compliance

- RF emission
 - In line with CISPR 11 / EN 55011 group 1 class A (for a shielded test setup)
 - Complies with the emission requirements stipulated by EN 55011, EN 61326-1 and EN 61326-2-1 class A, making the instrument suitable for use in industrial environments
- Immunity: in line with IEC / EN 61326-1 table 2, immunity test requirements for industrial environments

2.3 Input isolation

The instrument has independently floating isolated inputs. Each input channel has its own signal input and its own reference input. Each input channel is electrically isolated from the other input channels. Therefore, each reference of the used inputs must be connected to a reference voltage. Furthermore, input channels are electrically isolated from the communication ports and the power adapter input.

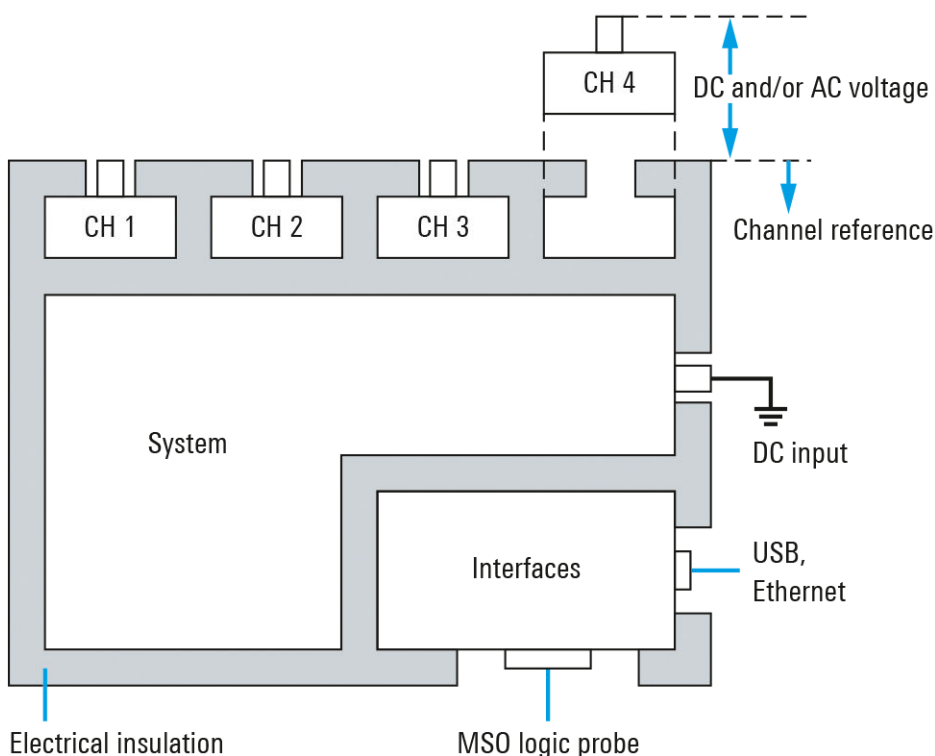

Figure 2-1: Isolation scheme of the R&S RTH

The input isolation has several advantages:

- You can measure independently floating signals simultaneously.
- The risk of causing a short circuit while measuring multiple signals is reduced substantially.
- When measuring signals with different grounds, the induced ground currents are kept to a minimum.

2.4 Documentation overview

The user documentation for the R&S RTH consists of the following parts:

- Instrument Help
The instrument help is part of the instrument's firmware. It offers quick, context-sensitive access to the complete information directly on the instrument.
- Safety Instructions (multilingual)
Provides safety information in many languages. The printed document is delivered with the product.

- Getting Started
The Getting Started manual provides the information needed to set up and start working with the instrument, and describes basic operations. A printed English version is included in the delivery.
- User Manual
The user manual describes all instrument modes and functions in detail. It also provides an introduction to remote control and a complete description of the remote control commands with programming examples. The newest version of the manual is available in English on the R&S RTH product website at www.rohde-schwarz.com/manual/rth.
- Specifications and product brochure
The specifications document, also known as the data sheet, contains the complete instrument specification. It also lists the options and their order numbers, and optional accessories. The product brochure provides an overview of the instrument and deals with the specific characteristics. The documents are available at www.rohde-schwarz.com/brochure-datasheet/rth.
- Calibration Certificate
The document is available on <https://gloris.rohde-schwarz.com/calcert>.
- Open Source Acknowledgment
The Open Source Acknowledgment document provides verbatim license text of open source software that is used in the instrument's firmware. It is available on the R&S RTH website at www.rohde-schwarz.com/firmware/rth, and it can be read directly on the instrument.
- Instrument Security Procedures manual
Provides information on security issues when working with the R&S RTH in secure areas.
- Application cards and application notes
These documents deal with special applications or background information on particular topics. See www.rohde-schwarz.com/application/rth

3 Preparing for use

Here, you can find basic information about setting up the instrument for the first time or when changing the operating site. Read and observe the safety instructions in [Chapter 1.1, "Safety instructions"](#), on page 5, and in the following sections.

3.1 Unpacking the instrument

When you receive your shipping package, unpack and inspect the package and its contents for damage.

1. Unpack the product carefully.
2. Retain the original packing material. Use it when transporting or shipping the product later.
3. Using the delivery notes, check the equipment for completeness.
4. Check the equipment for damage.

If the delivery is incomplete or equipment is damaged, contact Rohde & Schwarz.

Deliveries

The delivery package contains the following items:

- R&S RTH handheld scope
- MicroSD card, installed in the battery compartment
- Power adapter with cable and adapter set for various socket types
- Battery pack
- R&S RT-ZI10 probes (2x for R&S RTH1002; 4x for R&S RTH1004)
- DMM test leads (only for R&S RTH1002)
- Hand strap, attached on the handheld scope
- Printed "Getting Started" manual and "Safety Instructions" brochure

Optional accessories and their order numbers are listed in the specifications document.

3.2 Handling the battery

Consider the following notes on proper handling of batteries:

- When delivered, the battery is in sleeping mode, which is kept as long as the battery is unpacked and unused. The sleeping mode allows for a longer storage time.
- Before you can use the handheld oscilloscope with a new battery, insert the battery pack and charge it.
- Once the battery is used for the first time, it must be charged regularly, at least every 3 months.
- Avoid a deep discharge below 5% of the battery's capacity.
- We recommend changing the battery after 12 months of usage.
- Observe the safety regulations in "[Handling batteries safely](#)" on page 7.

To insert and charge the battery

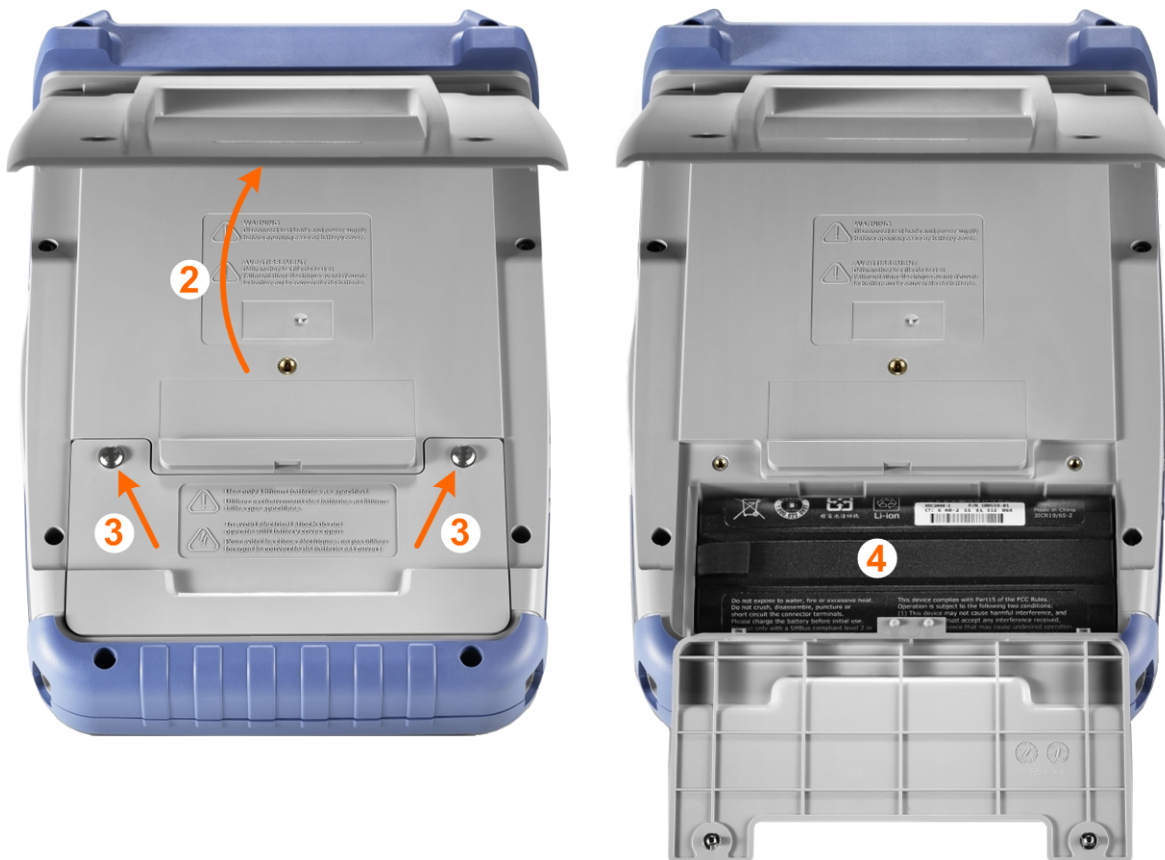

1. Turn off the instrument power. Remove power supply, probes, test leads and all other cables.

2. Fold out the tilt stand on the back of the instrument.
3. Screw open the battery cover.
4. **CAUTION!** Use only the specified Li-ion battery pack, which is delivered with the instrument. You can order additional battery packs at Rohde & Schwarz, see the specifications document for order number.

Insert the battery pack.

5. **WARNING!** Do not operate the instrument with the battery cover open. Screw down the battery cover.
6. **CAUTION!** Use only the specified power adapter, which is delivered with the instrument.

Connect the power adapter to the connector on the left side of the oscilloscope.



7. Fully charge the battery. Charging can take a few hours. If the instrument is on, the battery status is shown on the display. Now you can use the instrument.

3.3 Powering on/off

- ▶ Press the  [Power] key to switch the instrument on or off.
The key blinks and turns green after a few seconds.

Table 3-1: Colors of the [Power] key

| | |
|-----------------|--|
| Green | Power is on |
| Blue | Charging the battery, power is off |
| Orange (yellow) | Battery is fully charged, power adapter is connected, power is off |

If you do not use the instrument for a longer time, the battery gets exhausted. When you connect the power supply and switch on the instrument with an exhausted battery, it takes a few minutes until the instrument can start.

3.4 Using the tilt stand

The R&S RTH has a tilt stand for proper handling while the scope is placed on a table.

- ▶ Pull the tilt stand as shown below.



3.5 Considerations for test setup

Observe safety instructions, see "[Performing measurements](#)" on page 8.

Cable selection and electromagnetic interference (EMI)

Electromagnetic interference (EMI) can affect the measurement results.

To suppress electromagnetic radiation during operation:

- Use high-quality shielded cables, for example, double-shielded RF and LAN cables.
- Always terminate open cable ends.
- Ensure that connected external devices comply with EMC regulations.

Measuring accessories

Use only probes and measuring accessories that comply with IEC 61010-031.

Signal input and output levels

Information on signal levels is provided in the specifications document. Keep the signal levels within the specified ranges to avoid damage to the product and connected devices.

4 Instrument tour

4.1 Front view

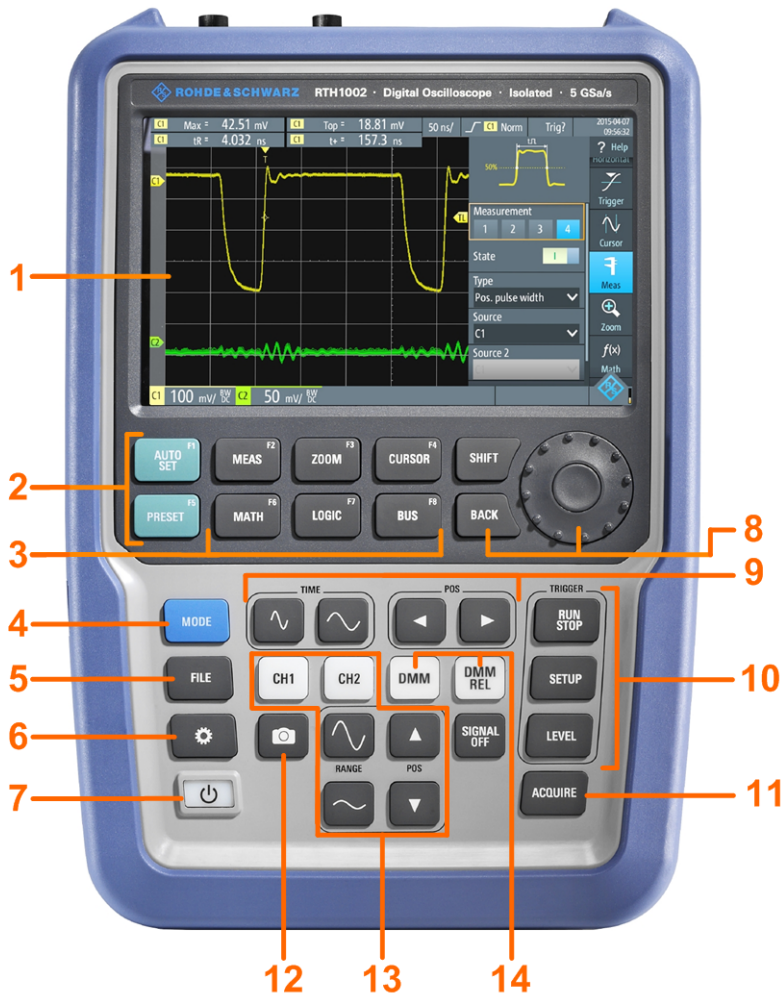

Figure 4-1: Front panel of the R&S RTH1002

- 1 = Touch display
- 2 = Waveform setup with [AUTOSET], reset to default with [PRESET]
- 3 = Analysis functions
- 4 = Mode selection
- 5 = Save/Recall
- 6 = Instrument settings
- 7 = Power on/off
- 8 = Navigation controls
- 9 = Horizontal settings

- 10 = Run/stop acquisition and trigger settings
- 11 = Acquisition settings
- 12 = Screenshot and documentation output
- 13 = Channels and vertical settings
- 14 = Multimeter measurements

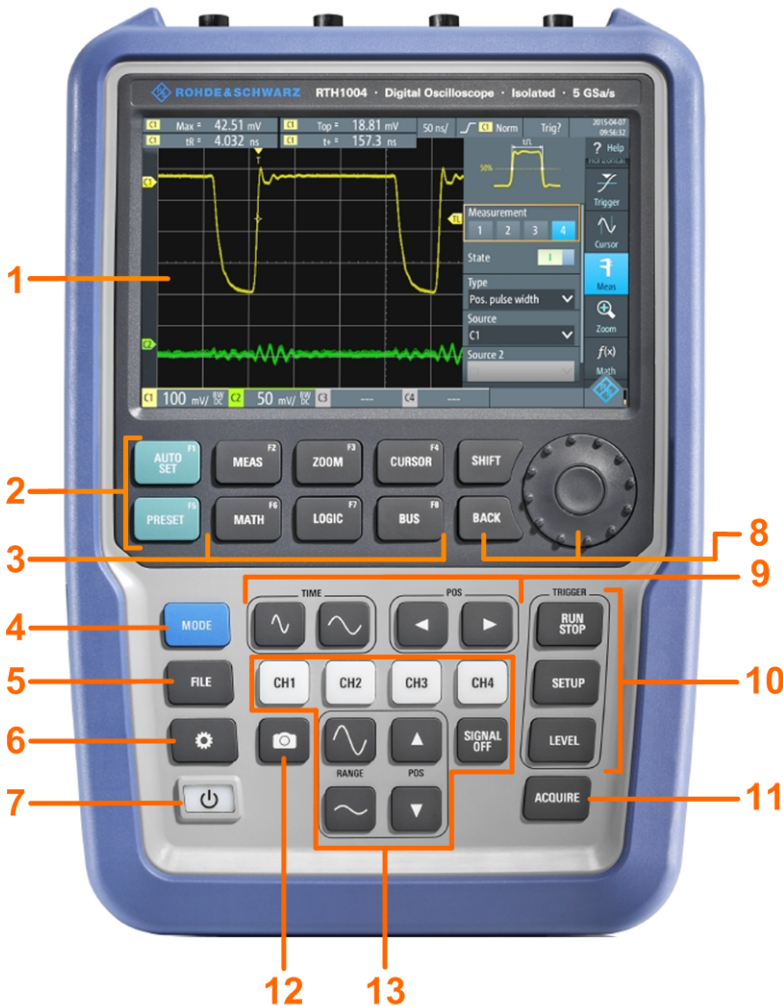

Figure 4-2: Front panel of the R&S RTH1004

- 1 = Touch display
- 2 = Waveform setup with [AUTOSET], reset to default with [PRESET]
- 3 = Analysis functions
- 4 = Mode selection
- 5 = Save/Recall
- 6 = Instrument settings
- 7 = Power on/off
- 8 = Navigation controls
- 9 = Horizontal settings
- 10 = Run/stop acquisition and trigger settings

- 11 = Acquisition settings
- 12 = Screenshot and documentation output
- 13 = Channels and vertical settings

For a description of the keys, see [Chapter 5.3.3, "Using front panel keys"](#), on page 42.

4.2 Top view

The R&S RTH1002 has two BNC input connectors CH1 and CH2, and two 4 mm banana inputs for multimeter measurements.



Figure 4-3: Top view of R&S RTH1002

The R&S RTH1004 has four BNC input connectors CH1, CH2, CH3, CH4.



Figure 4-4: Top view of R&S RTH1004

⚠ WARNING**Shock hazards caused by high voltages**

Voltages higher than 30 V RMS or 42 V peak or 60 V DC are regarded as hazardous contact voltages. When working with hazardous contact voltages, use appropriate protection to avoid electrical shock and injuries:

- Use only insulated probes, cables, test leads and adapters.
- Do not touch voltages higher than 30 V RMS or 42 V peak or 60 V DC.
- Do not apply input voltages above the rating of the instrument and the accessories.
- Use only probes, test leads, and adapters that comply with the measurement category (CAT) of your measurement task.
- Test leads and measurement accessories used for multimeter measurements on a live mains circuit must be rated for CAT III or CAT IV according to IEC 61010-031. The voltage of the measured circuit must not exceed the rated voltage value.

BNC connectors

The channel inputs have double channel-to-channel isolation that allows for independent floating measurements at each input, see [Chapter 2.3, "Input isolation"](#), on page 18. The maximum input voltage is:

- CAT IV 300 V
- With probe R&S RT-ZI10 or R&S RT-ZI11: CAT IV 600 V, CAT III 1000 V

Multimeter inputs

DMM inputs are 4 mm banana plug inputs, which are fully isolated from scope inputs, interfaces, and ground. The maximum input voltage is CAT IV 600 V; CAT III 1000 V.

4.3 Right view



- 1 = LAN
- 2 = USB type B for remote control
- 3 = Probe compensation
- 4 = USB type A for flash drive
- 5 = Logic probe connector

⚠ CAUTION

Risk of injury or instrument damage

Always close the lids of the communication ports and DC input when they are not in use.

LAN connector

RJ-45 connector to connect the instrument to a Local Area Network (LAN). It supports up to 100 Mbit/s.

USB type A connector

USB type A (host USB) connector to connect a USB flash drive to store and reload instrument settings and measurement data. This USB interface is isolated and has only limited functionality, it can only be used for transfer of oscilloscope data files and firmware update. Installing any other software is not possible.

USB type B connector (mini USB)

Mini USB connector (device USB) to connect a computer for remote control of the instrument. The connector is only active if USB is selected in the interface settings.

Probe compensation

Probe compensation terminal to support adjustment of passive probes to the oscilloscope channel.

Logic probe connector

Input for the logic probe R&S RT-ZL04. Logic analysis requires Mixed Signal option R&S RTH-B1, which includes the logic probe R&S RT-ZL04.

⚠ WARNING

Risk of electrical shock - no CAT rating for MSO measurements

The logic probe R&S RT-ZL04 is not rated for any measurement category. To avoid electrical shock or personal injury, and to prevent material damage, make sure that the ground clips of the R&S RT-ZL04 are connected to protective ground on the DUT.

4.4 Left view



1 = DC input

2 = Kensington lock slot

DC input

Connector for the power adapter to charge the battery.

Kensington lock slot

The Kensington lock is used to secure the instrument against theft.

4.5 Rear view



- 1 = Tilt stand to fold out
- 2 = Thread hole M5
- 3 = Battery compartment

4.6 Display overview

In the most important modes scope, mask and XY, the display shows the following information.

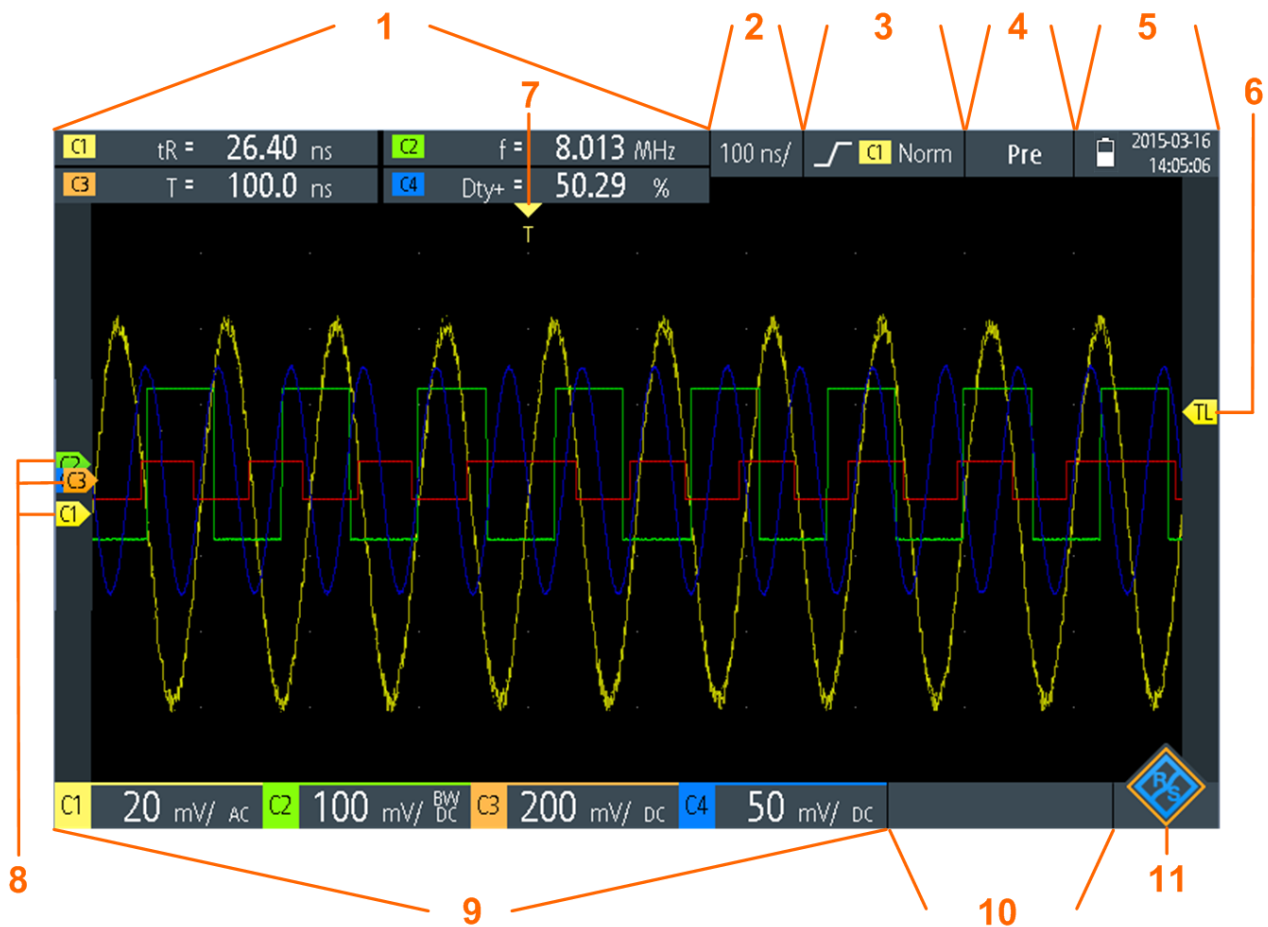

- 1 = Measurement results, which depend on the mode and the selected measurement
- 2 = Time scale (horizontal scale, in s/division)
- 3 = Trigger type, trigger source and trigger mode
- 4 = Capture status
- 5 = Battery status and AC connectivity for battery charging; date and time
- 6 = Trigger level marker, has the color of the trigger source
- 7 = Trigger position marker, has the color of the trigger source
- 8 = Channel markers indicate the ground levels. Channel C3 has the focus
- 9 = Vertical settings for each active channel: vertical scale (vertical sensitivity, in V/division), bandwidth limit (no indicator = full bandwidth, BW= limited frequency), coupling (AC or DC)
- 10 = Logic channels (MSO R&S RTH-B1)
- 11 = Menu button

You can adjust the vertical position of each waveform, the trigger level, and the trigger position by dragging the corresponding marker on the display. Alternatively, tap a marker to set the focus, and use the wheel to adjust the position.

5 Operating the instrument

5.1 Connecting probes

1. Connect one or more probes to the channel inputs at the top of the instrument.
2. To get the most accurate waveform display and best measurement results, remove all redundant connectors: power adapter, USB flash drive, DMM test leads and unused channels.
3. Press and hold the [CH] key of the used input.
4. Select "Probe Setting".
5. **WARNING!** Shock hazards caused by high voltages. Make sure to set the attenuation factor on the instrument according to the probe being used. Otherwise, the measurement results do not reflect the actual voltage level, and you might misjudge the actual risk.

Select the attenuation factor of the probe:

- To set a common attenuation factor, select it on the list.
- To set a user-defined attenuation factor:
 - Select "User".
 - Set the "Probe Factor".

You find the probe's attenuation factor on the probe.

No attenuation with AC coupling:

If AC coupling is set, the attenuation of passive probes has no effect, and voltage is applied to the instrument with factor 1:1. Observe the voltage limits, otherwise you can damage the instrument.

Current measurements:

If you measure current using a shunt resistor as a current sensor, you have to multiply the V/A-value of the resistor by the attenuation of the probe. For example, if you use a 1 Ω resistor and a 10:1 probe, the V/A-value of the resistor is 1 V/A. The attenuation factor of the probe is 0.1, and the resulting current probe attenuation is 100 mV/A.

Connecting test leads (R&S RTH1002)

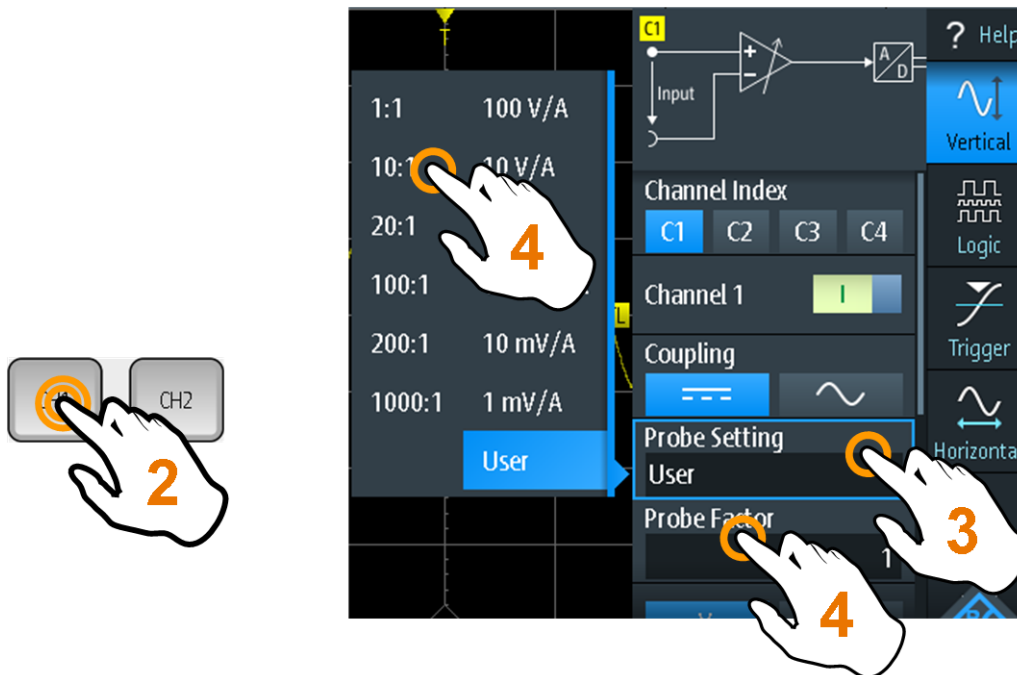

6. Switch off the test circuit.
7. Connect the probe to the DUT.
8. Switch on the test circuit.

5.2 Connecting test leads (R&S RTH1002)

The R&S RTH1002 has an integrated digital multimeter (DMM) and test leads for multimeter measurements.



Figure 5-1: Meter inputs to connect test leads

1. Connect the leads first to the DMM inputs at the top of the instrument, and then to the DUT.
2. To start meter measurements, press the [DMM] key.

5.3 Accessing the functionality

The complete functionality is available in the menus and dialogs on the touchscreen. You can touch the functions directly on the display, or you can use the wheel to navigate and select. In addition, the most important functions are applied to the keys on the front panel to set up and perform measurement tasks quickly.

5.3.1 Using the touchscreen

Using the touchscreen of the R&S RTH is as easy as using your mobile phone. To open the menu, tap the "Menu" button - that is the R&S logo in the right bottom corner of the display.

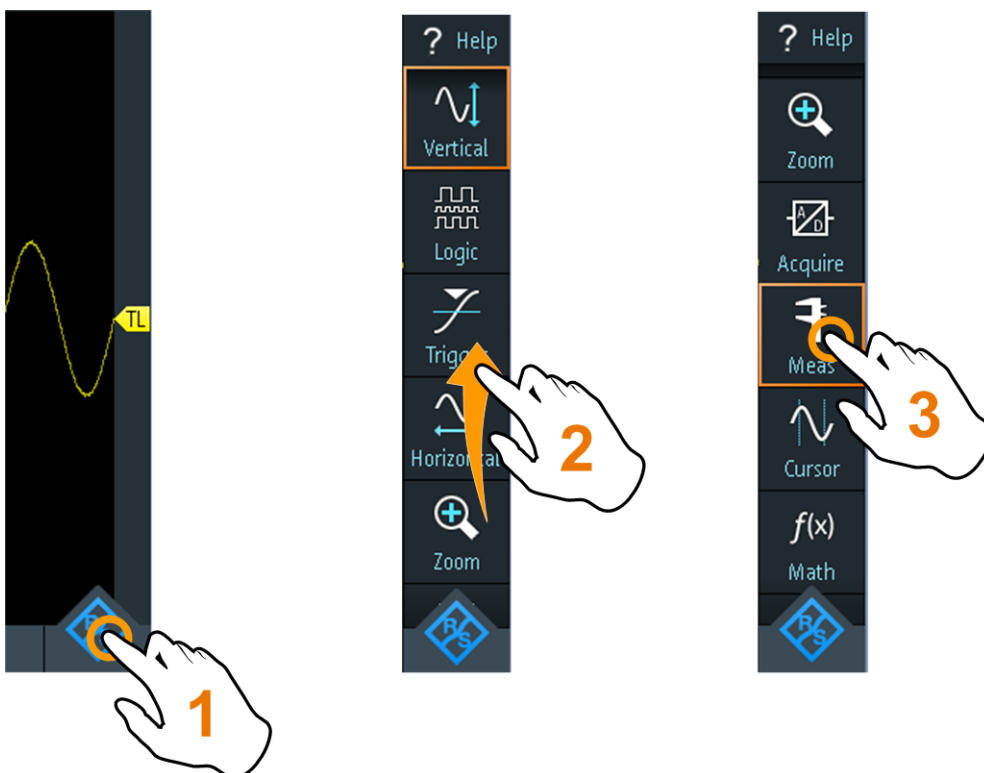

Figure 5-2: Open the menu and select a menu item



Figure 5-3: Switch on or off (left) and select a parameter value (right)

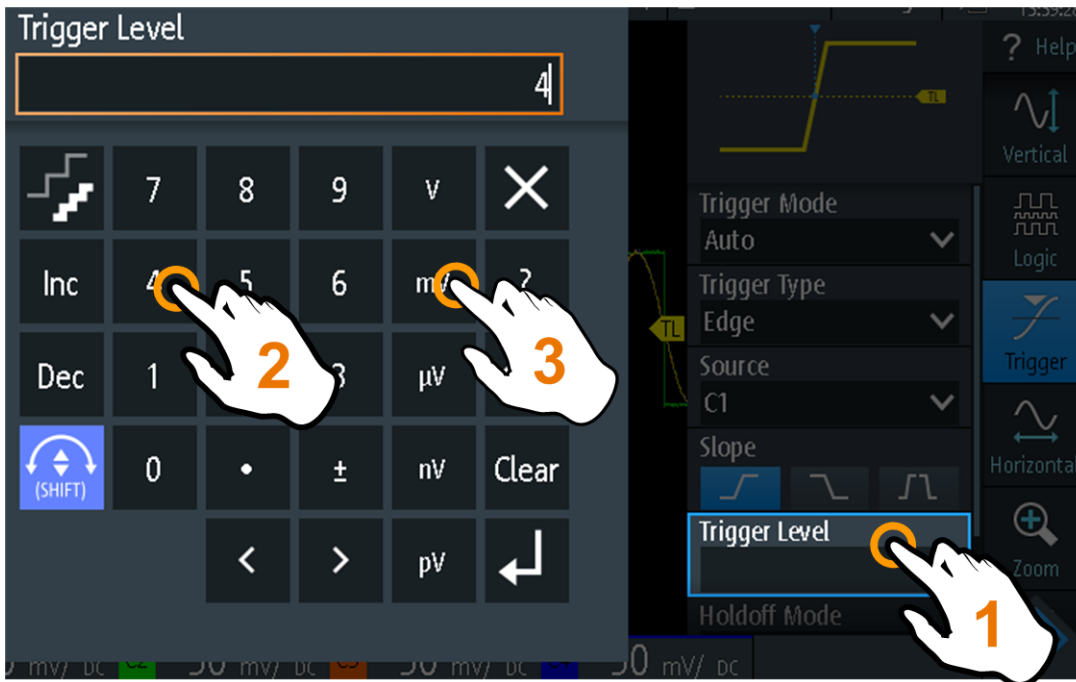

Figure 5-4: Enter a numerical value and unit

5.3.2 Using the navigation wheel

In addition or alternatively to the touchscreen, you can use the wheel to control the R&S RTH.

When using the wheel, always observe the position of the focus - the orange frame or other highlighting that marks the active object on the screen.

- If the focus is on the menu button or somewhere in the menu or dialogs:
 - Turn the wheel to move the focus.
 - Press the wheel button to apply the selection.
- If the focus is on an element in the diagram, for example, on a waveform, cursor line, or trigger level:
 - Turn the wheel to change the position of the active element.
 - Press the wheel button to toggle the active element, for example, to toggle the cursor lines, or zoom size and zoom position.

The [BACK] key closes open dialogs and menus, and resets the focus to the "Menu" button.

Menu navigation

The following procedure describes how to access and navigate the menu. Navigating dialogs and selecting parameter values works in the same way. See also [Figure 5-5](#).

1. Press [BACK] until the focus is on the "Menu" button.
2. Press the wheel button to open the menu.
3. Turn the wheel to move the focus to the required menu item.
4. Press the wheel button to open the dialog, submenu, or keypad for the selected menu item.

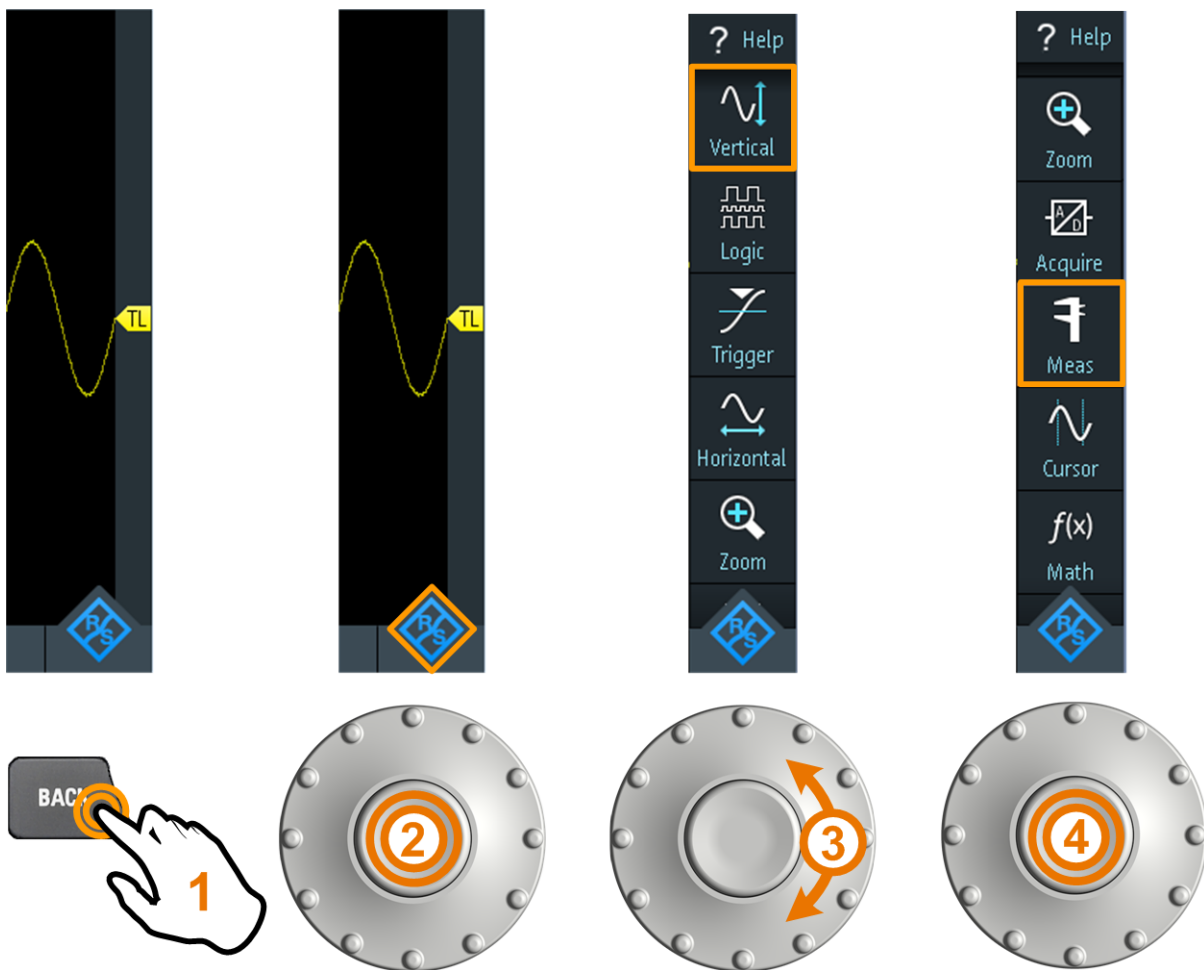

Figure 5-5: Open the menu and select a menu item

Set numerical values using the wheel

1. Set the focus to the required setting, and press the wheel button *once*.
2. Turn the wheel until the required value is shown.
3. Press [BACK].



Figure 5-6: Set numerical values using the wheel

Data entry using wheel and keypad

You can enter precise numerical values on the keypad. See also [Figure 5-7](#).

1. Set the focus to the required setting, and press the wheel button *twice*.
2. Turn the wheel until the focus is on the required number.
3. Press the wheel button.
4. Turn the wheel until the focus is on the required unit.
5. Press the wheel button.

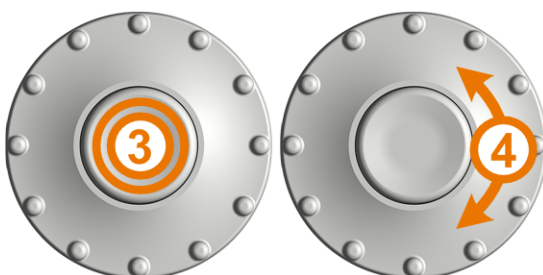
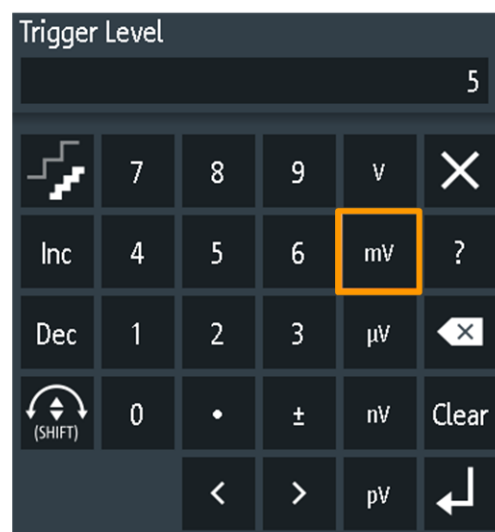
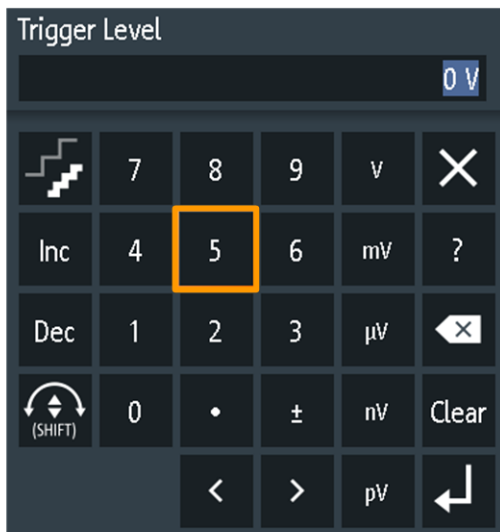
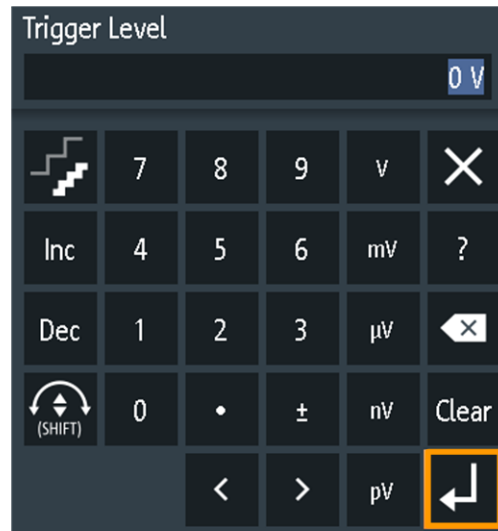





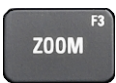

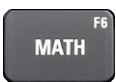

Figure 5-7: Enter a numerical value and unit in the keypad











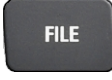

The [SHIFT] button toggles the wheel focus in the keypad. If the focus is on the entry field, turning the wheel changes the value. If the focus is in the lower part, the wheel selects numbers and unit.



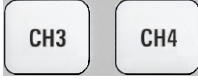

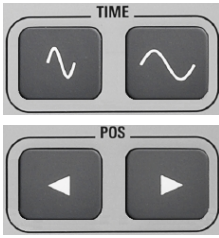

5.3.3 Using front panel keys

For an overview of the front panel keys, see [Figure 4-2](#).

| Key | Press shortly | Press and hold |
|---|--|---|
|  | [AUTOSET] analyses the active channels, adjusts the instrument settings, and displays stable waveforms. | |
|  | [PRESET] sets the instrument to the default factory state. | |
|  | [MEAS] starts or stops the last configured automatic measurements. | Opens or closes the "Meas" dialog to configure the measurements. |
|  | [ZOOM] enables or disables the zoom with the last configuration. If the zoom is on but not in focus, pressing the key focuses the zoom. | Opens or closes the "Zoom" dialog to configure the zoom scale and position. |
|  | [CURSOR] starts or stops the last configured cursor measurement. If the cursor is on but not in focus, pressing the key sets the focus to the first cursor line. | Opens or closes the "Cursor" dialog to configure the measurement. |
|  | [MATH] switches the math waveform on or off. | Opens or closes the "Math" dialog to configure the math waveform. |
|  | Requires logic analyzer option R&S RTH-B1 (MSO). The effect depends on the state of digital channels: If the all digital channels are off, the key switches them on and sets the focus. If the digital channels are on but not in focus, the key sets the focus. If the focus is on digital channels, the key switches them off. | Opens or closes the "Logic" dialog to configure digital channels. |
|  | Activates or deactivates the serial bus. Key function requires at least one serial triggering and decoding option. Available options are listed in the specifications document. | Opens or closes the "Bus" dialog to configure serial protocols. |

| Key | Press shortly | Press and hold |
|---|--|---|
|  | [SHIFT] opens a dialog to save and load instrument settings. | Press and hold for 2 seconds to disable or enable the touchscreen. |
|  | If a dialog or menu is open, [BACK] closes it. If the menu is closed, the key toggles the focus between the focused element in the diagram and the Menu button. | |
|    | Open or close the "Mode", "File" or "Setup" dialog, respectively. | |
|  | Saves measurement documentation: Only screenshot if "one touch" is off. ZIP file with selected data if "one touch" is on. | Opens or closes the "Screenshot" dialog to configure the screenshot and the "one touch" output. |
| All R&S RTH:  Only R&S RTH1004:  | The effect depends on the channel state: If the channel is off, the key switches on the channel and sets the focus. The key lights up. If the channel is on but not in focus, the key sets the focus. The key lights up. | |
| Only R&S RTH1002:  | [DMM] starts or stops the meter measurements (same as [MODE] = "Meter"). [DMM REL] enables or disables relative meter measurements. | Opens or closes the "Meter" dialog to configure the measurements. |
|  | [TIME] and [POS] adjust the horizontal time scale and position of the trigger point. | |
|  | [RANGE] and [POS] set the vertical scale (vertical sensitivity) and the vertical position of the focused waveform (analog or channel, math or reference waveform). | |

Displaying an unknown signal

| Key | Press shortly | Press and hold |
|---|---|----------------|
|  | [SIGNAL OFF] switches off the focused waveform. | |
|  | [RUN STOP] starts and stops the acquisition. | |
|  | [SETUP] opens or closes the "Trigger" dialog to select the trigger type and adjust the trigger settings. | |
|  | [LEVEL] activates the trigger level to be set using the wheel. If the trigger type has two trigger levels, pressing the key toggles the upper and lower levels. | |
|  | [ACQUIRE] opens or closes the "Acquire" dialog to adjust the acquisition mode. | |
|  | [Power] key: switches the power on or off | |

5.4 Displaying an unknown signal

The R&S RTH can display unknown, complex signals automatically. The [AUTOSET] function analyzes the enabled channel signals, and adjusts the horizontal, vertical, and trigger settings to display stable waveforms.

1. Press the [PRESET] key.



[PRESET] sets the instrument to a default factory state. The previous user-defined configuration is removed and all channels except for channel 1 are disabled.

2. Press the [AUTOSET] key.



The waveform is displayed.

5.5 Selecting the mode

A mode comprises all settings and functions that are needed to perform a measurement task. Selecting the mode is the first setup step.

1. Press the [MODE] key.

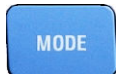

2. Select the mode:

- On the touchscreen: Tap the required mode icon.
- Using controls: Turn the wheel until the required mode is marked, and press the wheel button to select the mode.

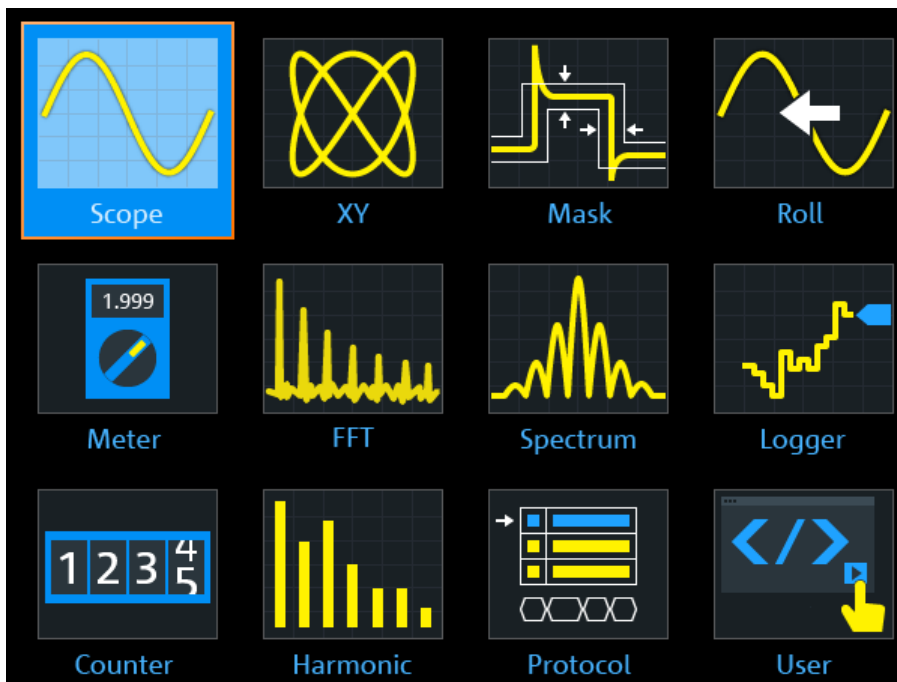

5.6 Setting the date, time and language

The instrument has a date and time clock. You can adjust the clock to the local time, and you can select the display language. Supported languages are listed in the specifications document. The help is provided in English.

A reboot of the instrument is not necessary.

Set the date and time

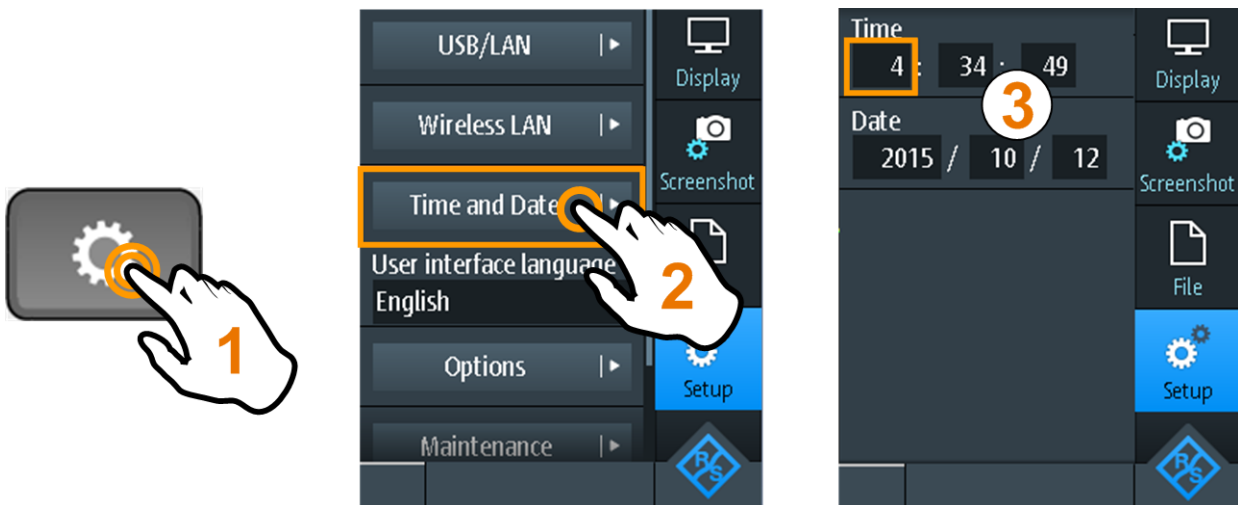

Set the display language



5.7 Getting information and help

In most dialogs, graphics explain the meaning of the selected setting. For further information, you can open the help, which provides functional description of the settings with links to the corresponding remote commands, and background information.

Note: When the help window is open, you can use only the [SHIFT] and [BACK] keys. Other keys may not work as expected. Close the help window before you use the keys.

5.7.1 Displaying help

- "To open the help window" on page 47
- "To show information on a setting" on page 47
- "To close the help window" on page 48

To open the help window

- ▶ Tap the "Help" icon on the top of the menu.



If a dialog is open, the dialog's help topic is shown beside the dialog.
If a menu is open, the table of contents is shown.

To show information on a setting

If a dialog and the help window are open, you can easily call the information on each setting of the dialog.

- ▶ Tap the setting's *name*.

The corresponding help topic is displayed.

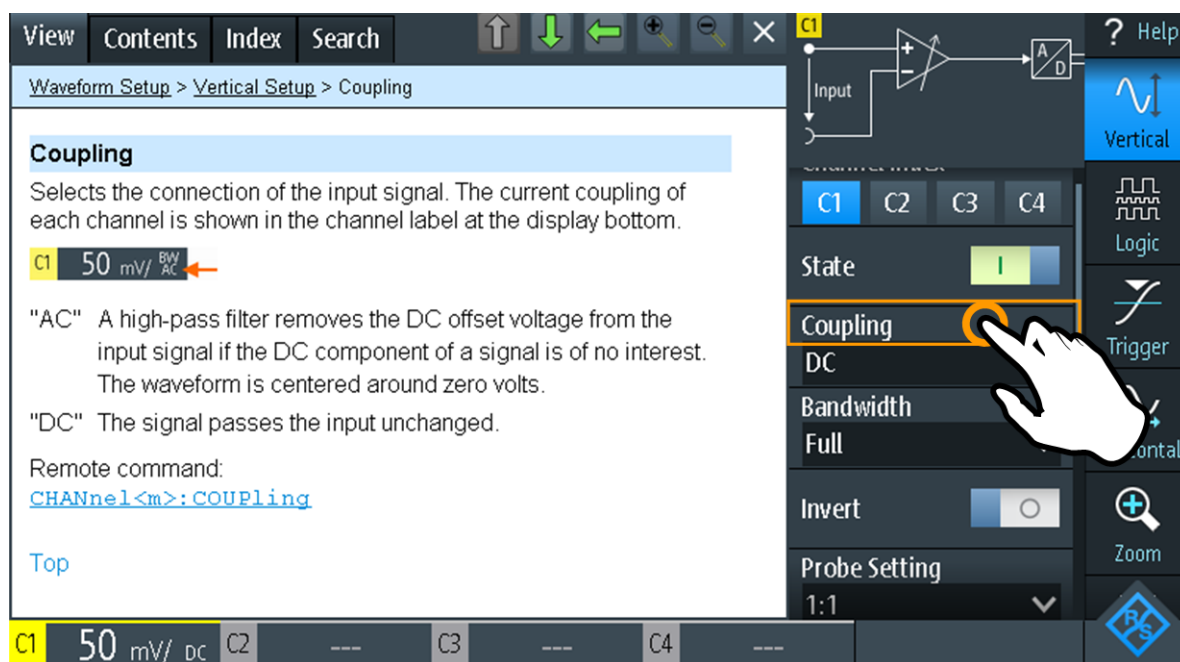

If you tap the *switch* or the *entry field*, you can adjust the setting without closing the help window.

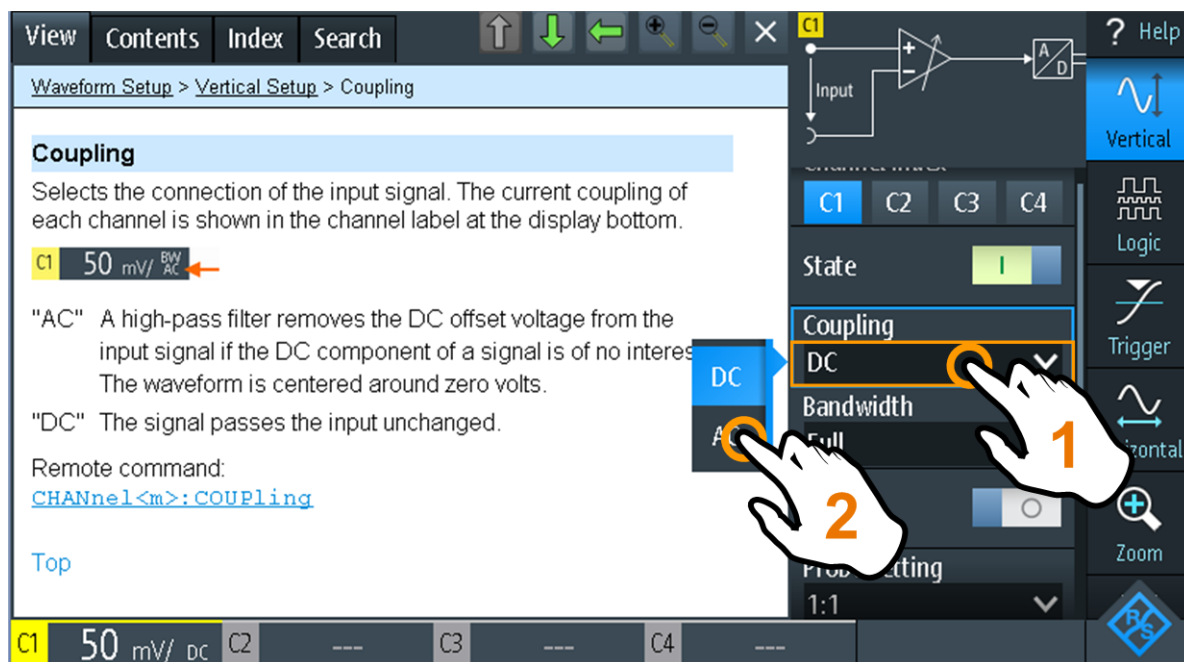

To close the help window

- ▶ Tap the "Close" icon in the upper right corner of the help window, or press [BACK].

5.7.2 Using the help window

The help window has several tabs:



- "View": shows the selected help topic.
- "Contents": contains a table of help contents.
- "Index": contains index entries to search for help topics.
- "Search": provides text search.

The help toolbar provides the following buttons:



- Up and down arrows: browse the topics in the order of the table of contents. Up = previous topic, down = next topic.

- Left and right arrows: browse the topics visited before: Left = back, right = forward.
- Magnifiers: increase or decrease the font.
- ×: closes the help window.

To search for a topic in the index

The index is sorted alphabetically. You can browse the list, or search for entries.

1. Tap the "Index" tab.
2. Tap the entry field on the top of the list.
3. Enter some characters of the keyword that you are interested in.
You can use the Backspace key to delete single characters, and "Clear" to delete all characters in the "Keyword" field.
4. Tap the [Enter] key.
Now only index entries are displayed that contain the keyword characters.
5. To delete the keyword:
 - a) Tap the entry field again.
 - b) Tap "Clear".
 - c) Tap the [Enter] key.

To search the help for a text string

1. Tap the "Search" tab.
2. Tap the entry field on the top.
3. Enter the words that you want to find.
If you enter several words with blanks between, topics containing all words are found.
To find a string of several words, enclose it in quotation marks. For example, a search for *"trigger mode"* finds all topics with exactly *"trigger mode"*. A search for *trigger mode* finds all topics that contain the words *trigger* and *mode*.
4. Tap the [Enter] key.
A list of search results is displayed.
5. To refine the search, use "Match Whole Word" and "Match Case", and tap "Start Search".

6 Maintenance and support

The instrument does not need periodic maintenance. Only the cleaning of the instrument is essential.

6.1 Cleaning

How to clean the product is described in "[Cleaning the product](#)" on page 10.

Do not use any liquids for cleaning. Cleaning agents, solvents, acids and bases can damage the front panel labeling, plastic parts and display.

6.2 Information for technical support

If you encounter problems that you cannot solve yourself, contact your Rohde & Schwarz support center, see [Chapter 7, "Contacting customer support"](#), on page 53. Our support center staff is optimally trained to assist you in solving problems.

The support center finds solutions more quickly and efficiently if you provide them with information on the instrument and an error description. To create, collect and save the required information, you can create a service report. It contains the bug report, all relevant setup information, reporting and log files, and the instrument configuration (device footprint).

1. Press , or open the "Setup" menu.
2. Scroll down.
3. Tap "Maintenance".
4. Select "Service".
5. Tap "Service Report".

The instrument creates the `.report` file and saves it to the USB flash device (if connected), or to the microSD card.

6. Attach the report file to an email in which you describe the problem. Send the email to the customer support address for your region as listed in the internet.

6.3 Data storage and security

The instrument is delivered with the 4 Gbyte microSD card inserted and ready to use. We recommend that you do not remove the microSD card.

All instrument configuration data and user data are stored on the microSD card. In addition, fallback firmware is stored on the microSD card to boot the instrument if an update failed.

If you use the instrument in a secured environment, consider the document "Instrument Security Procedures" that is delivered on the R&S RTH webpage. You can remove the microSD card before the instrument leaves this area. The microSD card slot is under the right lid under the battery pack.

You can also change the microSD card if you need more memory. The instrument supports microSD cards up to 32 Gbyte.

6.4 Transporting, storing and packing

Transporting

To protect and to transport the instrument to another workplace safely and easily, a soft case is provided. Refer to the specifications document for the order number. The maximum transport altitude without pressure compensation is 4600 m above sea level.

Storing

Protect the product against dust. Ensure that the environmental conditions, e.g. temperature range and climatic load, meet the values specified in the specifications document.

Packing

Use the original packaging material. It consists of antistatic wrap for electrostatic protection and packing material designed for the product.

If you do not have the original packaging, use similar materials that provide the same level of protection. You can also contact your local Rohde & Schwarz service center for advice.

6.5 Disposal

Rohde & Schwarz is committed to making careful, ecologically sound use of natural resources and minimizing the environmental footprint of our products. Help us by disposing of waste in a way that causes minimum environmental impact.

Disposing of electrical and electronic equipment

A product that is labeled as follows cannot be disposed of in normal household waste after it has come to the end of its life. Even disposal via the municipal collection points for waste electrical and electronic equipment is not permitted.



Figure 6-1: Labeling in line with EU directive WEEE

Rohde & Schwarz has developed a disposal concept for the eco-friendly disposal or recycling of waste material. As a manufacturer, Rohde & Schwarz completely fulfills its obligation to take back and dispose of electrical and electronic waste. Contact your local service representative to dispose of the product.

7 Contacting customer support

Technical support – where and when you need it

For quick, expert help with any Rohde & Schwarz product, contact our customer support center. A team of highly qualified engineers provides support and works with you to find a solution to your query on any aspect of the operation, programming or applications of Rohde & Schwarz products.

Contact information

Contact our customer support center at www.rohde-schwarz.com/support, or follow this QR code:



Figure 7-1: QR code to the Rohde & Schwarz support page