

R&S® LCX Series LCR Meter Getting Started



1179225402
Version 07

ROHDE & SCHWARZ
Make ideas real



This manual describes the instruments of the R&S®LCX meter series and its options:

- R&S LCX100 LCR Meter (3629.8856.02)
- R&S LCX200 LCR Meter (3629.8856.03)

© 2024 Rohde & Schwarz

Muehldorfstr. 15, 81671 Muenchen, Germany

Phone: +49 89 41 29 - 0

Email: info@rohde-schwarz.com

Internet: www.rohde-schwarz.com

Subject to change – data without tolerance limits is not binding.

R&S® is a registered trademark of Rohde & Schwarz GmbH & Co. KG.

All other trademarks are the properties of their respective owners.

1179.2254.02 | Version 07 | R&S®LCX Series

Throughout this manual, products from Rohde & Schwarz are indicated without the ® symbol, and the instruments of the R&S®LCX series are abbreviated as R&S LCX. For example R&S®LCX200 is indicated as R&S LCX.

Contents

1 Safety and regulatory information.....	5
1.1 Safety instructions.....	5
1.2 Labels on the R&S LCX.....	9
1.3 Warning messages in the documentation.....	9
1.4 Korea certification class A.....	10
2 Documentation overview.....	11
2.1 Getting started manual.....	11
2.2 User manual.....	11
2.3 Tutorials.....	11
2.4 Service manual.....	12
2.5 Instrument security procedures.....	12
2.6 Printed safety instructions.....	12
2.7 Specifications documents and brochures.....	12
2.8 Release notes and open-source acknowledgment (OSA).....	13
2.9 Application notes, application cards, white papers, etc.....	13
2.10 Remote control driver.....	13
3 Preparing for use.....	14
3.1 Lifting and carrying.....	14
3.2 Unpacking and checking.....	14
3.3 Choosing the operating site.....	14
3.4 Setting up the R&S LCX.....	15
3.4.1 Placing the R&S LCX on a bench top.....	15
3.4.2 Mounting the R&S LCX in a rack.....	16
3.5 Considerations for test setup.....	17
3.6 Connecting to power.....	18

3.7	Connecting to LAN.....	21
3.8	Connecting USB devices.....	22
3.9	Connecting a test fixture.....	23
3.10	Switching on or off.....	25
4	Instrument tour.....	26
4.1	Front panel tour.....	26
4.1.1	Touchscreen display.....	27
4.1.2	Keys.....	27
4.1.3	Connectors.....	30
4.2	Rear panel tour.....	30
5	Trying out the instrument.....	34
6	Instrument control.....	38
6.1	Ways to operate the instrument.....	38
6.2	Means of manual interaction.....	38
6.2.1	Understanding the display information.....	40
6.2.2	Accessing the functionality.....	48
6.2.3	Entering data.....	49
6.3	Remote control.....	52
7	Contacting customer support.....	53
	Index.....	54

1 Safety and regulatory information

The product documentation helps you use the product safely and efficiently. Follow the instructions provided here and in the following chapters.

Intended use

The product is intended for the development, production and verification of electronic components and devices in industrial, administrative, and laboratory environments. Use the product only for its designated purpose. Observe the operating conditions and performance limits stated in the specifications document.

Target audience

Only electrically skilled persons are qualified to connect, set up and use the R&S LCX LCR Meter. Such persons have the education and experience needed to recognize risks and avoid hazards of working with electricity.

Where do I find safety information?

Safety information is part of the product documentation. It warns you of potential dangers and gives instructions on how to prevent personal injury or damage caused by dangerous situations. Safety information is provided as follows:

- In [Chapter 1.1, "Safety instructions"](#), on page 5. The same information is provided in many languages in printed format. The printed "Safety Instructions" for "Mains-Powered Products, Not Heavy" (document number 1171.1771.99) are delivered with the product.
- Throughout the documentation, safety instructions are provided when you need to take care during setup or operation.

1.1 Safety instructions

Products from the Rohde & Schwarz group of companies are manufactured according to the highest technical standards. To use the products safely, follow the instructions provided here and in the product documentation. Keep the product documentation nearby and offer it to other users.

Use the product only for its intended use and within its performance limits. Intended use and limits are described in the product documentation such as the speci-

fications document, manuals and the printed "Safety Instructions" document. If you are unsure about the appropriate use, contact Rohde & Schwarz customer support.

Using the product requires specialists or specially trained personnel. These users also need sound knowledge of at least one of the languages in which the user interfaces and the product documentation are available.

Reconfigure or adjust the product only as described in the product documentation or the specifications document. Any other modifications can affect safety and are not permitted.

Never open the casing of the product. Only service personnel authorized by Rohde & Schwarz are allowed to repair the product. If any part of the product is damaged or broken, stop using the product. Contact Rohde & Schwarz customer support at <https://www.rohde-schwarz.com/support>.

Lifting and carrying the product

The maximum weight of the product is provided in the specifications document. You can lift or carry the product by yourself, if you can manage the weight on your own. Alternatively, you can use lifting or transporting equipment. Follow the instructions provided by the equipment manufacturer.

Choosing the operating site

Only use the product indoors. The product casing is not waterproof. Water that enters can electrically connect the casing with live parts, which can lead to electric shock, serious personal injury or death if you touch the casing.

If Rohde & Schwarz provides accessories designed for outdoor use of your product, e.g. a protective cover, you can use the product outdoors.

You can operate the product up to an altitude of 2000 m above sea level. If a higher altitude is permissible, the value is provided in the specifications document. The product is suitable for pollution degree 2 environments where nonconductive contamination can occur. For more information on environmental conditions such as ambient temperature and humidity, see the specifications document.

Setting up the product

Always place the product on a stable, flat and level surface with the bottom of the product facing down. If the product is designed for different positions, secure the product so that it cannot fall over.

If the product has foldable feet, always fold the feet completely in or out to ensure stability. The feet can collapse if they are not folded out completely or if the product is moved without lifting it. The foldable feet are designed to carry the weight of the product, but not an extra load.

If stacking is possible, keep in mind that a stack of products can fall over and cause injury.

If you mount products in a rack, ensure that the rack has sufficient load capacity and stability. Observe the specifications of the rack manufacturer. Always install the products from the bottom shelf to the top shelf so that the rack stands securely. Secure the product so that it cannot fall off the rack.

Connecting the product

Before connecting the interfaces and measuring inputs of the product to other products or electrical circuits, make sure that the other products or electrical circuits provide special protection against electric shock. This protection principle is referred to as SELV (safety extra-low voltage) and is based on a low voltage level and increased insulation. Exceptions are indicated by a measurement category on the product and given in the specifications document.

Connecting to power

The product is an overvoltage category II product. Connect the product to a fixed installation used to supply energy-consuming equipment such as household appliances and similar loads. Keep in mind that electrically powered products have risks, such as electric shock, fire, personal injury or even death. Replace parts that are relevant to safety only by original parts, e.g. power cables or fuses.

Take the following measures for your safety:

- Before switching on the product, ensure that the voltage and frequency indicated on the product match the available power source. If the power adapter does not adjust automatically, set the correct value and check the rating of the fuse.
- If a product has an exchangeable fuse, its type and characteristics are indicated next to the fuse holder. Before changing the fuse, switch off the product

Safety instructions

and disconnect it from the power source. How to change the fuse is described in the product documentation.





- Only use the power cable delivered with the product. It complies with country-specific safety requirements. Only insert the plug into an outlet with protective conductor terminal.
- Only use intact cables and route them carefully so that they cannot be damaged. Check the power cables regularly to ensure that they are undamaged. Also ensure that nobody can trip over loose cables.
- Only connect the product to a power source with a fuse protection of maximum 20 A.
- Ensure that you can disconnect the product from the power source at any time. Pull the power plug to disconnect the product. The power plug must be easily accessible. If the product is integrated into a system that does not meet these requirements, provide an easily accessible circuit breaker at the system level.

Cleaning the product

Use a dry, lint-free cloth to clean the product. When cleaning, keep in mind that the casing is not waterproof. Do not use liquid cleaning agents.

Meaning of safety labels

Safety labels on the product warn against potential hazards.





	<p>Potential hazard Read the product documentation to avoid personal injury or product damage.</p>
	<p>Electrical hazard Indicates live parts. Risk of electric shock, fire, personal injury or even death.</p>
	<p>Hot surface Do not touch. Risk of skin burns. Risk of fire.</p>
	<p>Protective conductor terminal Connect this terminal to a grounded external conductor or to protective ground. This connection protects you against electric shock if an electric problem occurs.</p>

1.2 Labels on the R&S LCX

Labels on the casing inform about:

- Personal safety, see "[Meaning of safety labels](#)" on page 8.
- Product and environment safety, see [Table 1-1](#).

Table 1-1: Labels regarding R&S LCX and environment safety

	Labeling in line with EN 50419 for disposal of electrical and electronic equipment after the product has come to the end of its service life. For more information, see the product user manual, chapter "Disposal".
	Grounding connection
	Chassis grounding connection
	Noiseless ground. The input signal at these connectors must be free from external voltages. The measurement results are otherwise incorrect.

1.3 Warning messages in the documentation

A warning message points out a risk or danger that you need to be aware of. The signal word indicates the severity of the safety hazard and how likely it will occur if you do not follow the safety precautions.

WARNING

Potentially hazardous situation. Could result in death or serious injury if not avoided.

CAUTION

Potentially hazardous situation. Could result in minor or moderate injury if not avoided.

NOTICE

Potential risks of damage. Could result in damage to the supported product or to other property.

1.4 Korea certification class A



이 기기는 업무용(A급) 전자파 적합기기로서 판매자 또는 사용자는 이 점을 주의하시기 바라며, 가정외의 지역에서 사용하는 것을 목적으로 합니다.

2 Documentation overview

This section provides an overview of the R&S LCX user documentation. Unless specified otherwise, you find the documents at:

www.rohde-schwarz.com/manual/lcx

2.1 Getting started manual

Introduces the R&S LCX and describes how to set up and start working with the product. Includes basic operations, typical measurement examples, and general information, e.g. safety instructions, etc. A printed version is delivered with the instrument.

2.2 User manual

The user manual contains the description of all instrument modes and functions. It also provides an introduction to remote control, a complete description of the remote control commands with programming examples, and information on maintenance, instrument interfaces and error messages. Includes the contents of the getting started manual.

The user manual is also available for download or for immediate display on the Internet.

2.3 Tutorials

Tutorials offer guided examples and demonstrations on operating the R&S LCX. They are provided on the product page of the internet.

2.4 Service manual

Describes the performance test for checking compliance with rated specifications, firmware update and maintenance.

The service manual is available for registered users on the global Rohde & Schwarz information system (GLORIS): <https://gloris.rohde-schwarz.com>

2.5 Instrument security procedures

Deals with security issues when working with the R&S LCX in secure areas. It is available for download on the internet.

2.6 Printed safety instructions

Provides safety information in many languages. The printed document is delivered with the product.

2.7 Specifications documents and brochures

The specifications document, also known as the data sheet, contains the technical specifications of the R&S LCX. It also lists the firmware applications and their order numbers, and optional accessories.

The brochure provides an overview of the instrument and deals with the specific characteristics.

See www.rohde-schwarz.com/brochure-datasheet/lcx

2.8 Release notes and open-source acknowledgment (OSA)

The release notes list new features, improvements and known issues of the current firmware version, and describe the firmware installation.

The firmware uses several valuable open source software packages. An open source acknowledgment document provides verbatim license texts of the used open source software.

See www.rohde-schwarz.com/firmware/lcx

2.9 Application notes, application cards, white papers, etc.

These documents deal with special applications or background information on particular topics.

See www.rohde-schwarz.com/application/lcx

2.10 Remote control driver

The instrument drivers enable remote control via the corresponding interfaces. The drivers and installation instructions are available for download on the product page at www.rohde-schwarz.com/driver/lcx.

3 Preparing for use

Here, you can find basic information about setting up the product for the first time.

3.1 Lifting and carrying

See "[Lifting and carrying the product](#)" on page 6.

3.2 Unpacking and checking

1. Unpack the R&S LCX carefully.
2. Retain the original packing material. Use it when transporting or shipping the R&S LCX later.
3. Using the delivery notes, check the equipment for completeness.
4. Check the equipment for damage.

If the delivery is incomplete or equipment is damaged, contact Rohde & Schwarz.

3.3 Choosing the operating site

Specific operating conditions ensure proper operation and avoid damage to the product and connected devices. For information on environmental conditions such as ambient temperature and humidity, see the specifications document.

For safety information, see "[Choosing the operating site](#)" on page 6.

Electromagnetic compatibility classes

The electromagnetic compatibility (EMC) class indicates where you can operate the product. The EMC class of the product is given in the specifications document.

- Class B equipment is suitable for use in:
 - Residential environments
 - Environments that are directly connected to a low-voltage supply network that supplies residential buildings
- Class A equipment is intended for use in industrial environments. It can cause radio disturbances in residential environments due to possible conducted and radiated disturbances. It is therefore not suitable for class B environments. If class A equipment causes radio disturbances, take appropriate measures to eliminate them.

3.4 Setting up the R&S LCX

See also:

- ["Setting up the product"](#) on page 7
- ["Intended use"](#) on page 5

3.4.1 Placing the R&S LCX on a bench top

To place the product on a bench top

1. Place the product on a stable, flat and level surface. Ensure that the surface can support the weight of the product. For information on the weight, see the specifications document.
2. **CAUTION!** Foldable feet can collapse. For safety information, see ["Setting up the product"](#) on page 7.
Always fold the feet completely in or out. With folded-out feet, do not place anything on top or underneath the product.
3. **WARNING!** A stack of products can fall over and cause injury. Never stack more than three products on top of each other. Instead, mount them in a rack.
Stack as follows:

Setting up the R&S LCX

- If the products have foldable feet, fold them in completely.
- All products must have the same dimensions (width and length).
- Do not exceed a total load of 50 kg placed on the product at the bottom of the stack.

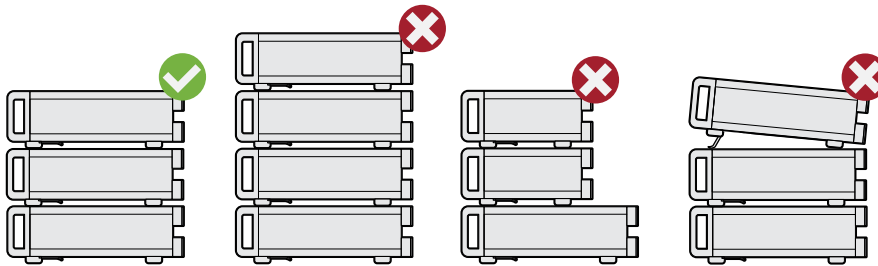

- Left = Stacked correctly
 Middle left = Stacked incorrectly, too many products
 Middle right = Stacked incorrectly, different dimensions
 Right = Stacked incorrectly, folded-out feet

4. **NOTICE!** Overheating can damage the product.

Prevent overheating as follows:

- Keep a minimum distance of 10 cm between the fan openings of the product and any object in the vicinity to provide sufficient airflow and ventilation.
- Do not place the product next to heat-generating equipment such as radiators or other products.

3.4.2 Mounting the R&S LCX in a rack

To prepare the rack

1. Observe the requirements and instructions in "[Setting up the product](#)" on page 7.
2. **NOTICE!** Insufficient airflow can cause overheating and damage the product. Design and implement an efficient ventilation concept for the rack.

Mounting the R&S LCX in a rack

To mount the R&S LCX in a rack:

1. Use an adapter kit that fits the dimensions of the R&S LCX to prepare the R&S LCX for rack mounting.

Considerations for test setup

- a) Order the rack adapter kit designed for the R&S LCX. For the order number, see the specifications document.
 - b) Mount the adapter kit. Follow the assembly instructions provided with the adapter kit.
2. Lift the R&S LCX to shelf height.
 3. Push the R&S LCX onto the shelf until the rack brackets fit closely to the rack.
 4. Tighten all screws at the rack brackets with a tightening torque of 1.2 Nm to secure the R&S LCX at the rack.

Unmounting the R&S LCX from a rack

To unmount the R&S LCX from a rack:

1. Loosen the screws at the rack brackets.
2. Bring the lifting equipment to shelf height.
3. Remove the R&S LCX from the rack.
4. If placing the R&S LCX on a bench top again, unmount the adapter kit from the R&S LCX. Follow the instructions provided with the adapter kit.

3.5 Considerations for test setup

Cable selection and electromagnetic interference (EMI)

Electromagnetic interference (EMI) can affect the measurement results.

To suppress electromagnetic radiation during operation:

- Use high-quality shielded cables, especially for the following connector types:
 - Connectors for external devices
Double-shielded data cables. The length of data cables must not exceed 3 m.
 - Connectors for signal transmission
Shielded coaxial cables. The length of signal cables must not exceed 1 m.
We recommend that you use the R&S LCX-Z11 BNC-to-BNC extension (1 m) from Rohde & Schwarz.
 - BNC

- Double-shielded BNC cables.
 - USB
Double-shielded USB cables. The length of passive USB cables must not exceed 1 m.
 - LAN
At least CAT6+ cables
 - IEEE-488 (GPIB)
Double-shielded cables. We recommend that you use the double-shielded cable "R&S HZ72" from Rohde & Schwarz.
- Always terminate open cable ends.
 - Ensure that connected external devices comply with EMC regulations.

Signal input and output levels

Information on signal levels is provided in the specifications document. Keep the signal levels within the specified ranges to avoid damage to the product and connected devices.

3.6 Connecting to power

For safety information, see "[Connecting to power](#)" on page 7.

 When using the R&S LCX the first time, you can skip [Replacing the external bias fuse](#) and [Replacing the line fuse](#).

If there are any problems during power-on or malfunction of the bias, check the condition of the mains fuse. Also check the fuse for the external bias input as described in these instructions. They explain how to check and change the protective fuses, if necessary.

Replacing the external bias fuse

The bias voltage input of the R&S LCX is protected by a fuse of type IEC 60127-2/5-F0.5L/250V (order no. 0009.5463.00). The externally accessible fuse is at the [rear panel](#).

To check and exchange the external bias fuse:

1. **NOTICE!** Risk of instrument damage. Malfunction of the fuse that protects the bias voltage input from overload can damage the circuitry of the instrument. Do not use either fuse type other than specified, nor a defective fuse, and never short-circuit the fuse.
Make sure that you have disconnected the R&S LCX from the mains.
2. Check the condition of the external bias fuse.
3. If necessary, install the fuse type required for the external bias voltage.
 - a) Unscrew the fuse holder with a suitable screwdriver.
 - b) Pull out the fuse holder.
 - c) Replace the fuse by a fuse of the specified type.
 - d) Insert the fuse holder into the external bias inlet.
When inserting the fuse holder, press it slightly and tighten it.

Replacing the line fuse

The product is protected by one fuse of type IEC 60127-2/5-T2.0H/250V (order no. 0020.7546.00). The externally accessible fuse is part of the IEC socket of the power supply at the [rear panel](#).

To exchange the line fuse:

1. Check the available supply voltage.
The mains voltage must be within the voltage range as denoted on the instrument.
The label is at the [rear panel](#), on the left of the "AC power" connector and power switch.
The power supply module covers a wide power supply range and normally does not require adjustment.
2. If the power supply exceeds the permissible range, contact Rohde & Schwarz customer service.
3. **WARNING!** The fuse is part of the AC power supply. Handling the fuse while the power is on can lead to electric shock.
If necessary, exchange the fuse required for the supply voltage.
4. Before changing the fuse:
 - a) Set the switch on the power supply to position [0].
 - b) Disconnect the R&S LCX from the power source.

5. Replace the line fuse.

a) Unplug the power cable.

b) Press the plastic lock on the bottom of the fuse holder inwards using a screwdriver (with a blade width of approximately 2 mm).

A narrow guide on the bottom of the fuse holder denotes the insertion point.

When unlocking the mechanism, compression springs automatically push the fuse holder outwards.

c) Pull out the fuse holder.

d) Check the condition of the fuse.

e) Replace the fuse by a fuse of the specified type.

A label next to the fuse holder also indicates the fuse type and its characteristics.

f) **Note:** The protruding contact springs must not be deformed. Align the fuse holder with the guide bar facing the socket.

Carefully slide the fuse holder against the spring pressure into the slot until the plastic lock latches.

Connecting to power

To connect the instrument to the mains:

1. Check the available supply voltage.

The mains voltage must be within the voltage range as denoted on the instrument.

The label is at the [rear panel](#), on the left of the "AC power" connector and power switch.

The power supply module covers a wide power supply range and normally does not require adjustment.

2. If the power supply exceeds the permissible range, contact Rohde & Schwarz customer service.

3. If necessary, ground the instrument using the grounding connection \perp .

A ground connector socket is at the [front panel](#) to connect a ground cable with a banana plug.

As an alternative, a ground terminal at the [rear panel](#) enables you to connect a ground cable firmly with a screw:

a) At the [rear panel](#), unscrew the screw of the ground terminal using a cross-recess screw driver.

b) Attach a ground cable with a ring terminal and pass the screw through it.

c) Fasten the screw.

- d) Connect the cable to ground.
4. Plug the AC power cable into the "AC power" connector.
The power supply switch connector is at the [rear panel](#). Only use the power cable delivered with the R&S LCX.
5. Plug the AC power cable into a power outlet with ground contact.
The required ratings are listed next to the AC connector and in the specifications document.

3.7 Connecting to LAN

Establishing the LAN connection

The R&S LCX provides Ethernet (LAN) connectivity. Provided the corresponding rights are assigned, you can use these interfaces for remote control and data transfer from a controller PC. The controller PC must also be connected in the network.

The "LAN" connector is at the [rear panel](#).

To connect the R&S LCX to the LAN:

1. Connect the "LAN" socket using an RJ-45 cable to the LAN.
By default, the R&S LCX configuration uses DHCP that assigns the IP address automatically.
2. **NOTICE!** If the R&S LCX cannot obtain an IP address automatically, or cannot establish the connection, the icon in the status bar turns red.
Possible reasons are that the LAN does not support DHCP or requires a specific TCP/IP configuration, or that the connection is missing.
To troubleshoot the problem, proceed as follows:
 - a) Check if you have connected both, the R&S LCX and the controller PC to the LAN.
 - b) Consult your network administrator to request support and an IP address, if necessary.
 - c) If necessary, assign the IP address manually as described in chapter "Network operation and remote control > Configuring remote access > Assigning the IP addresses manually" in the user manual.

If switched on and connected, the R&S LCX indicates the address information and LAN parameters in the "Ethernet Settings dialog".

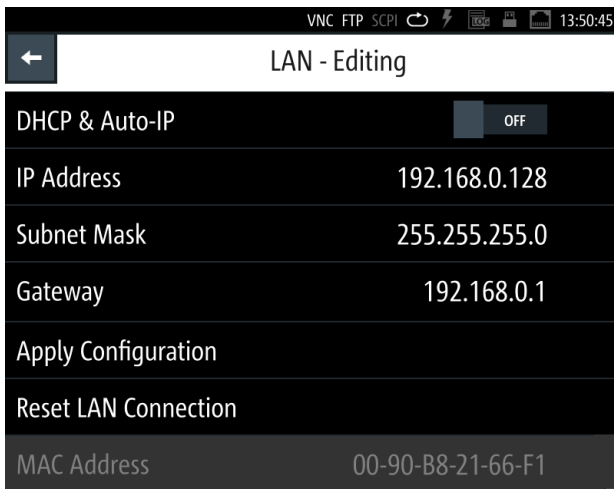

Figure 3-1: LAN settings dialog

3.8 Connecting USB devices

The "USB A" connector is at the [front panel](#). You can connect or disconnect all USB devices from the R&S LCX during operation. But do not remove an external USB memory stick while the instrument is saving data, since it leads to loss of data.

To connect USB storage devices

USB storage devices, such as memory sticks, allow easy data transfer from or to the R&S LCX. You can also use them for firmware updates.

- ▶ Connect the USB storage device to the "USB A" connector.
If you use the front panel connectors, connect the USB storage device directly, without connecting cable. Connecting cables can cause electromagnetic radiation and impair the measurement result.

To connect USB devices with external power supply

It is also possible, to use an USB device with external power supply.

1. **NOTICE!** Connected devices with external power supply can feed back current into the 5 V power supply of the USB interface and thus damage the R&S LCX.

Make sure that there is no connection between the positive pole of the power supply and the +5 V power pin of the USB interface (VBUS).

2. Connect the USB storage device to the "USB A" connector at the front panel.

3.9 Connecting a test fixture

The R&S LCX enables you to measure passive components like capacitors, coils, resistors, transformers. To measure such components requires the use of suitable measurement adapters, in this context considered as test fixtures.

For information on the test fixtures available for the R&S LCX, see "Measurement Setups > About Test Fixtures" in the user manual.

The test fixtures are connected firmly to the four BNC connectors H POT (high potential), H CUR (high current), L POT low potential) and L CUR (low current) at the [front panel](#).

 The following instructions describe the mechanical connection of the adapter only. Before starting a measurement, consider the prerequisites and steps to be performed before as described in [Chapter 5, "Trying out the instrument"](#), on page 34.

Connecting a test fixture to the instrument

To connect a 4-terminal test fixture to the R&S LCX:

1. **NOTICE!** Check all terminals to make sure that they are not damaged.

NOTICE! Before connecting, discharge all components. Externally supplied voltage can damage the BNC connectors of the R&S LCX.

Turn the levers at the "BNC" connectors of the test fixture to the left to release the lock (1).

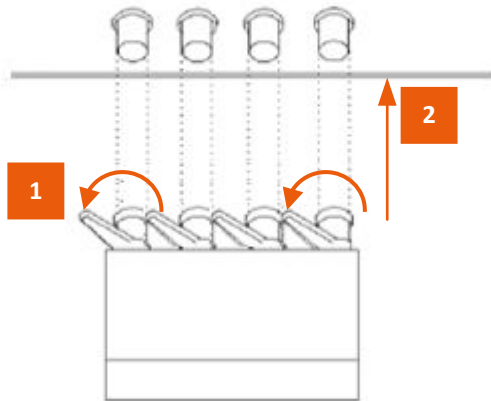

Figure 3-2: Connecting a test fixture

2. Carefully plug the test fixture to the four "BNC" measurement connectors of the R&S LCX (2).
3. Turn all levers to the right to tighten the connection (3).

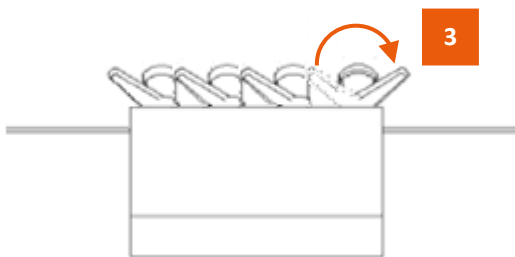

Figure 3-3: Fastening the test fixture

The mechanical test setup is ready for operation.

Connecting a test fixture with the BNC-to-BNC extension

If you are using the BNC-to-BNC extension (option R&S LCX-Z11), you can connect all devices as described in [Connecting a test fixture to the instrument](#). We recommend that you keep the order as follows:

1. Connect the BNC-to-BNC to the R&S LCX.
Proceed as described in [step 1](#).

2. Connect the test fixture to the extension.

3.10 Switching on or off

Switching on the product

The product is off but connected to power.

1. Set the switch on the power supply to position [I].
The power supply switch connector is on the [rear panel](#).
The R&S LCX starts, and the front panel keys light up briefly.
2. Press the power key for a second.
The power is on the front panel.
The instrument checks the system, boots the operating system, and then starts the R&S LCX firmware.
The power lights green.
When starting for the first time, the R&S LCX starts with the default settings.
When restarting the instrument, the settings depend on the instrument configuration before shut-down.

Shutting down the product

- ▶ Press the power key.
All current settings are saved and the operating system shuts down.
The power changes to gray (off).

To disconnect from power

The product is in the standby state.

1. **NOTICE!** Risk of data loss. If you disconnect the product from power when it is in the ready state, you can lose settings and data. Shut it down first.
Set the switch on the power supply to position [0].
2. Disconnect the product from the power source.

4 Instrument tour

The following topics help you to get familiar with the instrument and perform the first steps:

- [Front panel tour](#)
- [Rear panel tour](#)

The sections explain the controls and connections at the front and back of the R&S LCX. For specifications of the interfaces, see the specifications document.

The meanings of the labels on the R&S LCX are described in [Chapter 1.2, "Labels on the R&S LCX"](#), on page 9.

4.1 Front panel tour



Figure 4-1: R&S LCX front panel

- 1 = Basic display keys, see [Chapter 4.1.2.1, "Basic display keys"](#), on page 28
- 2 = Touchscreen display, see [Chapter 4.1.1, "Touchscreen display"](#), on page 27
- 3 = Navigation controls, see [Chapter 4.1.2.2, "Navigation controls"](#), on page 28
- 4 = Function keys, see [Chapter 4.1.2.4, "Function keys"](#), on page 28
- 5 = Setting keys, see [Chapter 4.1.2.5, "Settings keys"](#), on page 29
- 6 = Measurement control keys, see [Chapter 4.1.2.6, "Measurement control keys"](#), on page 29
- 7 = BNC measurement connectors, see ["L CUR, L POT, H CUR, H POT"](#) on page 30
- 8 = Measurement mode keys, see [Chapter 4.1.2.3, "Measurement mode keys"](#), on page 28

9 = Ground connector, see ["Ground socket"](#) on page 30

10 = POWER key, see [Chapter 4.1.2.7, "POWER On/Standby key"](#), on page 29

11 = USB host connector

4.1.1 Touchscreen display

The color TFT touchscreen at the front panel is the graphical user interface. It shows the measurement readings, status information and settings, and provides access to settings dialogs.

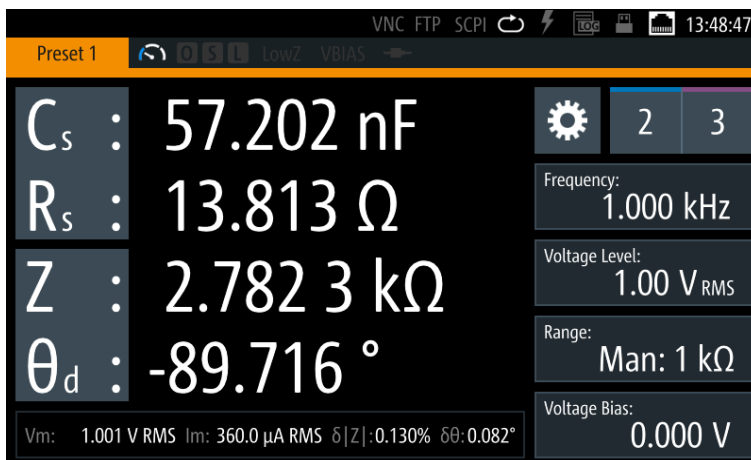

Figure 4-2: Touchscreen display

For details on the screen display, see [Chapter 6.2.1, "Understanding the display information"](#), on page 40.

The touch-sensitive panel provides an alternative means of user interaction for quick and easy handling of the instrument, see [Chapter 6.2, "Means of manual interaction"](#), on page 38.

4.1.2 Keys

This section introduces the functionality of the hardkeys at the front panel. These controls lead you to menus and dialogs displayed on the screen. For information on how to operate the instrument, see [Chapter 6.2, "Means of manual interaction"](#), on page 38.

4.1.2.1 Basic display keys

The utility keys arrange different windows on the display.

Table 4-1: Display keys

Display key	Assigned functions
[home]	Returns to the initial feature screen.
[settings]	Displays a menu list for accessing general instrument functions.
[★ (User)]	Executes a previously assigned user action. Press and hold accesses the favorites menu for assigning a user action.

4.1.2.2 Navigation controls

The navigation controls include a rotary knob and navigation keys. They allow you to navigate within the display or within dialogs, see [Chapter 6.2, "Means of manual interaction"](#), on page 38.

Table 4-2: Navigation controls

Key	Assigned functions
[Rotary knob]	Selects, activates or confirms settings.
[◀] / [▶]	Moves the cursor in entry fields.
[Back]	Returns to a previous level in menus, or closes a view.

4.1.2.3 Measurement mode keys

The measurement controls enable you to select the measurement mode and view of the representation of the measurement readings.

Table 4-3: Measurement mode controls

Key	Assigned functions
[Meas. Mode]	Selects either continuous or manually triggered measurement mode.
[Display Mode]	Selects the display of measurement readings.

4.1.2.4 Function keys

The keys in the function panel select the parameters for the measurement.

Table 4-4: Measurement function controls

Key	Assigned functions
[L]	Selects the function for measuring inductance.
[C]	Selects the function for capacity measurement.
[R]	Selects the measurement for a resistor.
[Transformer]	Selects the transformer measurement.

4.1.2.5 Settings keys

The keys in the settings panel enable you to select measurement ranges and additional parameters for executing the measurement.

Table 4-5: Measurement function controls

Key	Assigned functions
[Freq.]	Sets the signal frequency.
[Range]	Selects the impedance range.
[Level]	Sets the level.
[Comp.]	Opens the "Open/Short/Load Correction" dialog for quick access.
[Bias Level]	Sets the bias voltage and current.
[Bias Enable]	Activates internal or external bias.

4.1.2.6 Measurement control keys

These keys provide control during the measuring procedure.

Table 4-6: Navigation controls

Key	Assigned functions
[Auto]	Activates the automatic selection of the measurement function.
[Hold]	Freezes the measurement range, on the screen indicated with prefix "Hold:" at the range value.
[Trig.]	Triggers a measurement manually.

4.1.2.7 POWER On/Standby key

The [On/Standby] key switches the instrument from the standby to the ready state or vice versa.

The [On/Standby] lights green when the instrument is switched on, see [Chapter 3.10, "Switching on or off"](#), on page 25.

4.1.3 Connectors

The measurement input connectors and the USB connector are on the [front panel](#).

L CUR, L POT, H CUR, H POT

Four BNC sockets:

- "L CUR" (low current): signal output for series measurements (signal generator).
- "L POT" (low potential): signal input for parallel measurement (voltage measurements).
- "H CUR" (high current): signal input for series measurements (current measurements).
- "H POT" (high potential): signal input and output for parallel measurements (measurement bridge).

Ground socket

Protective socket (4 mm banana socket) to ground the R&S LCX, e.g. with a grounded external conductor.

The front panel ground socket is directly connected to the mains safety ground by the line cord.

See [Table 1-1](#).

USB A

Female USB (universal serial bus) connector of type A (host USB). You can connect a USB memory stick, e.g., to record and export measurement data, to capture screenshots, or to update the firmware.

How to: [Chapter 3, "Preparing for use"](#), on page 14

4.2 Rear panel tour

This section provides an overview of the connectors at the rear panel of the instrument. For technical data of the connectors, see the specifications document.



Figure 4-3: R&S LCX rear panel

- 1 = IEEE-488 interface, see ["IEC 625/IEEE 488"](#) on page 31
- 2 = Kensington lock, see ["Kensington lock"](#) on page 31
- 3 = AC power connector and power switch, see ["AC power supply"](#) on page 31
- 4 = Ground terminal, see ["Ground terminal"](#) on page 32
- 5 = D-sub connector, see ["Digital I/O"](#) on page 32
- 6 = Bias connectors and fuse holder, see ["External Voltage Bias"](#) on page 32, ["BIAS Fuse"](#) on page 32
- 7 = Trigger input connector, see ["Trigger Input"](#) on page 32
- 8 = USB host connector, see ["USB A"](#) on page 30
- 9 = USB device connector, see ["USB B"](#) on page 33
- 10 = Ethernet (LAN) interface connector, see ["LAN"](#) on page 33

IEC 625/IEEE 488

Option: R&S NG-B105

General purpose interface bus (GPIB) interface to connect a computer for remote control of the R&S LCX.

See chapter "Network Operation and Remote Control > Connecting the R&S LCX for Remote Access" in the user manual.

Kensington lock

Flat key security slot to prevent the instrument from removal.

The locking system consists of a small, metal-reinforced hole with a metal anchor and a rubberized metal cable that is secured with a key lock. The loop at the end of the cable allows you to tie the unit to a fixed object.

AC power supply

Mains power supply with power switch, fuse holder and IEC socket.

- Mains power switch:

Switch for connecting and disconnecting the internal power supply from the power source, see [Chapter 3.10, "Switching on or off"](#), on page 25.

- Fuse holder
Socket for the fuse securing the line voltage. Depending on the power supply system, the corresponding fuse must be plugged before connecting to power. See "[Connecting to power](#)" on page 20.
- IEC socket
Power supply connector for connecting the R&S LCX to the mains., see [Chapter 3.6, "Connecting to power"](#), on page 18.

Ground terminal

Protective ground terminal to secure the R&S LCX, e.g. with a grounded external conductor, see [Table 1-1](#).

Digital I/O

15-pole D-Sub socket to connect the binning interface.

External Voltage Bias

4 mm safety sockets for external bias voltage.

Note: External BIAS requires constant voltage.

Before applying the voltage, make sure that you have set the constant voltage mode in the supplying instrument. Refer to the user manual of the power supply.

The External Voltage Bias socket is not directly connected to ground.

Indirectly, there is a connection to ground with low impedance over the "H CUR" output buffer.

When the bias voltage is turned on, the potential to ground deviates only by a maximum of ± 18 V. Without external bias, make sure that the voltage at the two sockets does not exceed the safety extra low voltage or the specified 40 V DC.

BIAS Fuse

Socket for the fuse securing the external bias voltage.

Trigger Input

BNC socket for external trigger signal.

The outer conductor of the trigger input is directly connected to the mains safety ground by the line cord.

USB A

Female USB (universal serial bus) connector of type A (host USB). You can connect a USB memory stick, e.g., to record and export measurement data, to capture screenshots, or to update the firmware.

How to: [Chapter 3, "Preparing for use"](#), on page 14

USB B

Female USB (universal serial bus) type B connector. This interface provides remote control of the instrument from a controller PC.

See chapter "Network Operation and Remote Control > Connecting the R&S LCX for Remote Access" in the user manual.

LAN

RJ-45 socket to connect the R&S LCX to a LAN for remote control, remote operation, and data transfer.

How to: [Chapter 3.7, "Connecting to LAN"](#), on page 21

5 Trying out the instrument

As a brief introduction, the following example describes the basic steps to be taken when setting up a measurement. The instructions guide you through the measurement of a resistor.

Further test setups and measurement methods are described in the user manual, see "Measurement Setups".

The test setup uses the R&S LCX-Z3 SMD test fixture connected to the R&S LCX for measuring leadless components.



If necessary, you can connect the R&S LCX-Z11 BNC-to-BNC extension between the R&S LCX and the test fixture, e.g., to make it easier to pick and place the DUTs.

Basic measurement steps

The R&S LCX LCR meter measures the impedance and phase angle with an AC signal, and derives the required characteristics.

As the equivalent circuit of each DUT contains capacitive, real and conductive parts, the characteristics of passive components vary dependent on frequency, level, temperature and additional bias. Even the test equipment can impact the measurement results. Therefore, we recommend that you use the test fixture that fits best for your application, and align the instrument on all frequencies. Keep the order as given to minimize parasitic parts and thus to optimize the measurement accuracy.

1. Select the test fixture that fits best for your application.
2. After power-on set the R&S LCX to an initial state, see ["Setting the initial state"](#) on page 35.
3. Connect the test fixture, see [Chapter 3.9, "Connecting a test fixture"](#), on page 23.
4. Configure the test signal, see ["Setting up the test signal"](#) on page 35.
5. Align the instrument on all frequencies, see ["Aligning the instrument on all frequencies"](#) on page 36.
6. Start a resistor measurement ["Measuring a resistor"](#) on page 37.

Setting the initial state

1. **NOTICE!** Check all terminals to make sure that they are not damaged.
Power on the R&S LCX, as described in [Chapter 3.6, "Connecting to power"](#), on page 18.
2. Switch on the R&S LCX, see [Chapter 3.10, "Switching on or off"](#), on page 25.
3. **NOTICE!** Risk of measurement inaccuracy. Measurements can be inaccurate, if performed when the instrument is not warmed-up. Wait until the instrument has reached its operating temperature before you start the measurement procedure.

The warm-up time is up to 30 minutes.

To start from an initial state, set the instrument to default:

- a) Press the [settings] key at the front panel.
On the front panel, press the [settings] button.
- b) In the "Device" tab, select "Save/Recall Device Settings".
- c) Select "Default Settings".
The instrument prompts you to confirm the operation.
- d) Confirm with "Ok".
The R&S LCX resets all parameters except for system settings.
- e) Select  to return to the settings menu.

Connecting the test fixture

The figure shows schematically the elements to be connected.

- ▶ To connect the test fixture, proceed as described in [Chapter 3.9, "Connecting a test fixture"](#), on page 23.

Setting up the test signal

To configure the test signal:

1. To set the frequency:
 - a) On the screen, select "Frequency".
 - b) Enter, e.g. 10 kHz using the keypad on the screen.
 - c) Confirm with .
2. To select the level parameter:
Before setting the test signal level, you can select either the signal voltage, or the signal current for the level setting:
 - a) Press the [settings] at the front panel.

- b) Select the "Measurement" tab.
- c) Select "Test Signal Level".
- d) Select, e.g. "Voltage".
- e) Confirm with "Set".
- f) Press the [home] key to return to the measurement window.

The R&S LCX provides the selected parameter for the level setting on the screen.

3. To set the test signal level:
 - a) On the screen, select "Level".
 - b) Enter, e.g. 1.3 VRMS.
 - c) Confirm with .
4. If you know the expected range, set the range as follows. Otherwise skip this step and proceed with [step 5](#):
 - a) Select "Range".
 - b) In the "Select Measurement Range" dialog, select the expected impedance, e.g. 10 kΩ.
 - c) Confirm with "Set".
5. On the front panel, press the [Auto] key to activate automatic detection of the measurement function according to the component type of the DUT.

Aligning the instrument on all frequencies

To compensate impacts and measurement errors, you can align the instrument on all frequencies before starting the measurement.

This example describes, how to execute a short and an open correction with the connected SMD test fixture (R&S LCX-Z3).

 During the correction procedure, the R&S LCX sweeps through defined frequency steps that are determined by the selected source impedance and the correction mode.

For information on the frequency steps, see the user manual, chapter "Measurement parameters" > "Setting measurement parameters" > "Aligning the instrument on all frequencies" > "Frequency sequences for open and short correction".

1. Press the [Comp.] key at the front panel.
The "Open/Short/Load Correction" dialog opens.

2. Execute a short correction:
 - a) Short-circuit the contact devices, i.e. the clamps or pins, according to the used test fixture.
 - b) In the "Open/Short/Load Correction" dialog, select "Short correction".
 - c) Set "Enabled" > "ON".
 - d) Select "Start Short Correction (Full)".

The short correction takes about 2 minutes.

3. Execute an open correction:
 - a) Open the contact devices.
Depending on the test fixture, take care that you set the required position. For example, Kelvin clamps require the same position as expected for the measurement, or the spacing between SMD pins must correspond to the size of the measurement sample.
 - b) In the "Open/Short/Load Correction" dialog, select "Open correction".
 - c) Set "Enabled" > "ON".
 - d) Select "Start Open Correction (Full)".

The open correction also lasts for about 2 minutes.

Note: For information on corrections with other test fixtures, see "Measurement Setups > About test fixtures" in the user manual.

Measuring a resistor

1. To select the resistor measurement (DUT component type), press the [R] key.
2. To select the parameters for measurement results display:
 - a) Select the softkey in the upper left corner, to open the selection editor.
 - b) Select the parameters "R-X" (resistance, reactance).
 - c) Repeat the steps to select the second parameters, e.g. select "Z- θ " (impedance, phase angle).
3. Insert the sample resistor in the test fixture as follows:
 - a) To open the contact pins, relax and hold the lever to the left.
 - b) Carefully position the sample between the contacts in the center.
 - c) Release the lever to fix the sample.

The measurement starts and you can see the readings on the screen.

6 Instrument control

This chapter provides an overview on how to work with the R&S LCX. It introduces the possibilities for operating the instrument and describes the basic functionality of the control elements. If a measurement configuration requires specific operating steps, the corresponding settings description in the user manual points it out separately.

- [Ways to operate the instrument](#)..... 38
- [Means of manual interaction](#)..... 38
- [Remote control](#)..... 52

6.1 Ways to operate the instrument

You can operate an R&S LCX in two ways:

- Manual operation
Use the touchscreen and the front panel controls to configure general and measurement settings.
See [Chapter 6.2, "Means of manual interaction"](#), on page 38 for basic information on manual operation of the instrument.
- Remote control
Create programs to automatize repeating settings, tests and measurements. A controller PC with remote access to the instrument runs the programs.
See [Chapter 6.3, "Remote control"](#), on page 52 for an overview of the interfaces provided for remote control.

6.2 Means of manual interaction

For manual interaction of the R&S LCX, use the touchscreen and front panel controls, see [front panel](#). The display shows the current settings, menus and dialogs, when you perform your settings.

For the manual interaction with the R&S LCX, you have several methods that you can use as an alternative to perform a task:

- Touchscreen

Means of manual interaction

Touchscreen operation is the most direct way to interact with the instrument. Almost all control elements and actions on the screen are based on the standard operating system concept. You can tap any user interface element to set parameters in dialogs, enter data, or scroll within a dialog.

Using various finger gestures you can select any user interface element, set parameters in dialogs, enter data using online keypads, or scroll within a dialog.

– **Tapping**



Touch quickly: selects a parameter or provokes an action.

– **Swiping**



Touch and swipe: Scrolls through the contents of a display element larger than the screen, e.g. a menu list.

– **Dragging**



Touch and drag: Shifts the contents from one position to another on the display.

By dragging your finger over a diagram, you can pan the displayed area of the diagram to show results that were previously out of view.

- **System, measurement and function keys**

The front panel hardkeys provide nearly all functions and controls to operate the instrument in the classic way, without touchscreen.

You can access the main functions and parameters, measurement and display modes and configure general instrument settings. When selected, i.e. a function is active, the corresponding function key lights up white.

- **Navigation controls**

The navigation controls include a [rotary knob] and right [▶], left [◀] keys.

The rotary knob allows you to navigate on the home screen or in dialogs, and to set parameters. The [◀] [▶] move the cursor in entry fields.

This manual describes the manual interaction with the instrument using the touchscreen. It mentions the alternative methods using the keys on the instrument or the on-screen keypads if it deviates from the standard operating procedures.

i Throughout the manual, the term "select" refers to any of the described methods, i.e. using a finger on the touchscreen or a key on the instrument or on a keyboard.

For basic instructions on how to control the R&S LCX, see [Chapter 6.2.2, "Accessing the functionality"](#), on page 48.

6.2.1 Understanding the display information

The initial display screen shows the measurement result window, status information and general settings at the top. The main area displays the measurement results, depending on the selected measurement and display mode.

For detailed information, see the user manual, chapter "Display Modes".

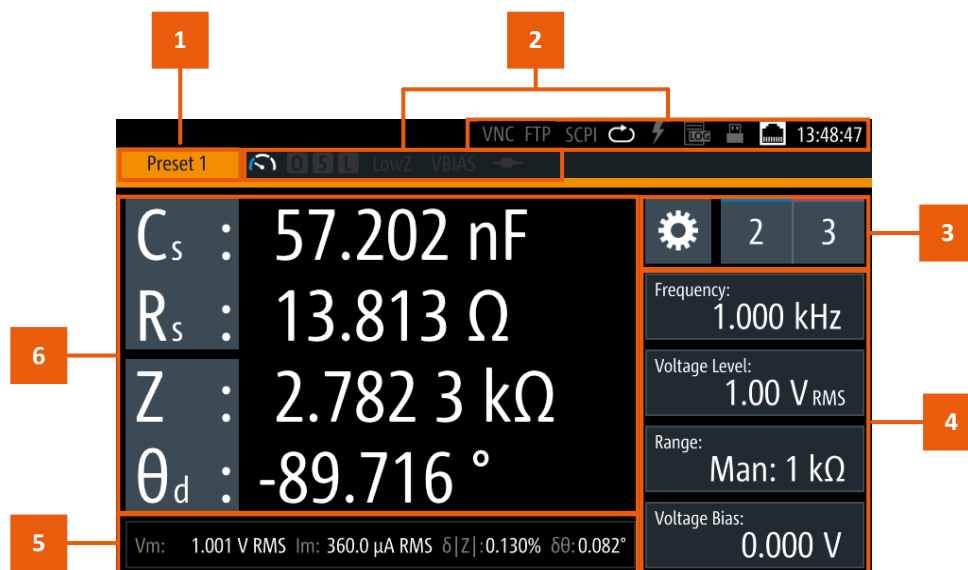

Figure 6-1: Example of screen display

- 1 = Configuration preset indicator, see [Chapter 6.2.1.1, "Configuration preset indicator"](#), on page 41
- 2 = Status bars, see [Chapter 6.2.1.2, "Status bar"](#), on page 41
- 3 = Settings softkey and configuration preset softkeys, see [Chapter 6.2.1.3, "Settings softkey"](#), on page 44, [Chapter 6.2.1.4, "Configuration preset softkeys"](#), on page 44

4 = Signal parameters, see [Chapter 6.2.1.5, "Signal parameters"](#), on page 45

5 = Test signal monitor, see [Chapter 6.2.1.6, "Test signal monitor"](#), on page 45

6 = Measurement parameters and results, see [Chapter 6.2.1.7, "Measurement parameters and results"](#), on page 45

The following sections explain the information areas as labeled.

6.2.1.1 Configuration preset indicator

The R&S LCX enables you to set up to three different measurement configurations and assign them as favorites with the [Chapter 6.2.1.4, "Configuration preset softkeys"](#), on page 44. The indicator displays the currently active preset configuration.

 (Preset 1/2/3) displays the currently active preset configuration.

6.2.1.2 Status bar

You can see two status bar lines. The status bar in the upper line on the right, referred to as instrument status bar, indicates icons which represent the states of connections, remote control communication and operating modes. The status bar to the right of "Preset", is referred to as measurement status bar. Its icons indicate measurement modes and states.









Instrument status bar

The instrument status bar refers to the general instrument configuration and operating modes, see [Table 6-1](#) for information on the icons.

The color of the symbols indicates the status of, e.g. a function, connection or a process:

- **white** - enabled, or running
- **gray** - disabled
- **red** - faulty
- **yellow** - denotes a specific status

Table 6-1: Instrument status bar

Indicator	Description
 Touchscreen	Indicates that the touchscreen is locked. See "General instrument functions > User button" in the user manual.
 Virtual Network Computing	White indicates that the VNC service is enabled for remote access over LAN. See "Network and remote control > Connecting the R&S LCX for remote access" in the user manual.
 File Transfer Protocol	White indicates that the remote access to the file system over LAN is enabled. See "Network and remote control > Connecting the R&S LCX for remote access" in the user manual.
 (Remote control with SCPI commands)	Indicates the status when working with remote control commands: <ul style="list-style-type: none"> • single white flash: SCPI command received successfully • red A remote control error has occurred, entered in the SCPI error queue • gray no SCPI communication
 Measurement mode	White indicates that the R&S LCX measures in continuous measurement mode. See "Instrument functions > Measurement mode" in the user manual.
 Trigger event	Flashes once on a trigger event.
 Logging	Indicates the logging state: <ul style="list-style-type: none"> • white Data logging is running. • red A logging error has occurred. • gray Logging is disabled See "General instrument functions > Logging" in the user manual.
 USB host interface	White indicates that a connected USB memory device is in use. See Chapter 3.8, "Connecting USB devices" , on page 22.

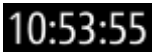
Indicator	Description
USB device interface	The USB remote control connection is established. See "Network operation and remote control > Connecting the R&S LCX for remote access" in the user manual.
 LAN interface	The R&S LCX is connected to LAN. See Chapter 3.7, "Connecting to LAN" , on page 21.
GPIB/IEE-488	The IEE-488 bus interface (GPIB) connection is established. See "Network and remote control > Connecting the R&S LCX for remote access" in the user manual.
 Time	Indicates the time set on the instrument. See "General instrument functions > Date & Time" in the user manual.

Measurement status bar

The measurement status bar provides information on certain measurement modes, functions and states. When activated, indicators displayed in white color represent the corresponding functions.









 For information on the measurement modes and functions, see "Instrument functions > Measurement parameters" in the user manual.



Table 6-2: Measurement status bar

Indicator	Description
Measurement mode	
 Measurement speed	Indicates the set measurement speed: <ul style="list-style-type: none">  fast  medium  slow <p>In triggered mode, the icon is grayed out. See "Instrument functions > Measurement parameters > Measurement settings > Measurement speed" in the user manual.</p>

Indicator	Description
 "O", "S", "L"	Indicates if open, short, and load corrections are enabled. <ul style="list-style-type: none"> • white: full correction enabled • blue: spot correction enabled • gray: correction disabled See "Instrument functions > Measurement parameters > Measurement settings > Open/Short/Load corrections settings" in the user manual.
 "LowZ"	Low impedance measurement mode is set. See "Instrument functions > Measurement parameters > Measurement settings > LowZ mode" in the user manual.
 "BIAS"	Indicates an activated BIAS: <ul style="list-style-type: none"> • "VBIAS": voltage bias, provided for capacitance measurements • "IBIAS": current bias, provided for inductance measurements • "eVBIAS": external voltage bias, for capacitance measurements If disabled, the icons are grayed out. See "Instrument functions > Measurement function > Test signal settings" in the user manual.
 "Cable Length"	White indicates that the cable length is set. The R&S LCX displays the set value (currently only 1 m applicable). See "Instrument functions > Measurement parameters > Measurement settings > Cable length" in the user manual.

6.2.1.3 Settings softkey

The  (settings) softkey opens the measurement dialog for setting additional basic measurement parameters.

6.2.1.4 Configuration preset softkeys

The  (preset configuration) softkeys recall previously assigned measurement configurations, defined for dedicated measurements. You can assign up to three predefinable configuration presets.

How to: see "Measurement Functions > Configuration Preset" in the user manual.

6.2.1.5 Signal parameters

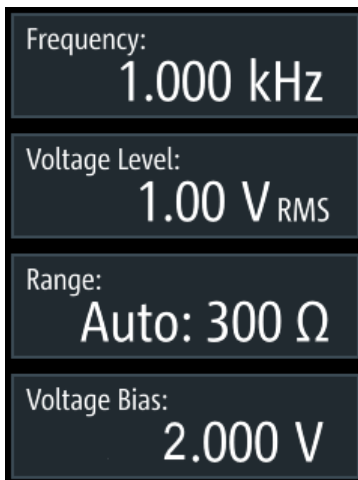

Figure 6-2: Measurement signal parameters

Each softkey opens an on-screen keypad for setting the signal parameters directly. Alternatively, you can use the corresponding settings keys at the [front panel](#).

6.2.1.6 Test signal monitor



Figure 6-3: Test signal monitor

The test signal monitor displays voltage and current results and the measurement accuracy.

6.2.1.7 Measurement parameters and results

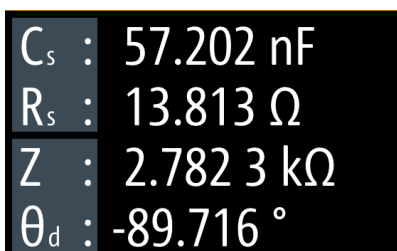

Figure 6-4: Measurement results window

Means of manual interaction

The initial screen shows the basic parameters capacitance " C_s " and serial resistance " R_s ", the impedance " Z " and phase angle " Θ_d ". On the right, the R&S LCX displays the measurement readings.

You can select parameters different from default by tapping the parameter softkeys.

How to: see "[Measuring a resistor](#)" on page 37

The parameter softkeys open an on-screen selection list for selecting parameters other than displayed.

6.2.1.8 Additional display characteristics

The following section provides a short insight on the indication of the screen in general, and significant elements that you see under specific operating modes, in dialogs or settings.

- **Appearance of active elements**

- *Active* elements like On/Off switches, state buttons have a **blue** background.
- *Selected* elements are framed or highlighted **orange**.
- *Inactive* elements are **gray**.

- **Menus and dialogs**

Both, menus and dialogs appear similar, and contain selection lists.

Throughout this manual, a list of functions which lead you to the settings of this function is referred to as menu. The term dialog refers to the views that cover the parameters of a certain function. Some dialogs are divided into tabs with logically grouped parameters.

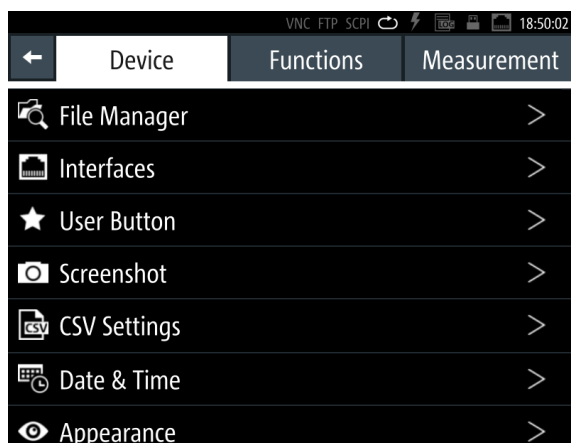

Figure 6-5: Example of a menu

- **Selection editors**

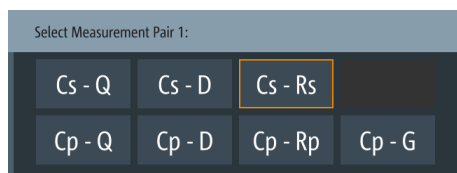

Figure 6-6: Example of selection editor for measurement parameter pairs

When opened, a generic label in the header of the editor window shows the parameter for selection. Each editor lists the available values and buttons to confirm the selection.

- **On-screen keypads**

As additional means of interacting with the instrument, either a numerical or alphanumerical on-screen keypad appears when you activate an entry field (see [Chapter 6.2.3, "Entering data"](#), on page 49).

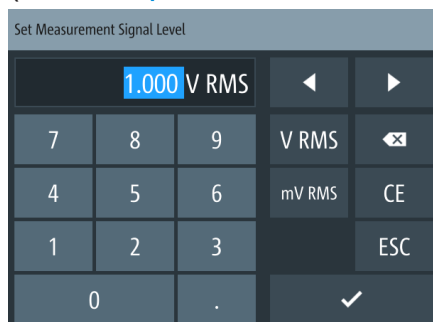

Figure 6-7: Numeric on-screen keypad

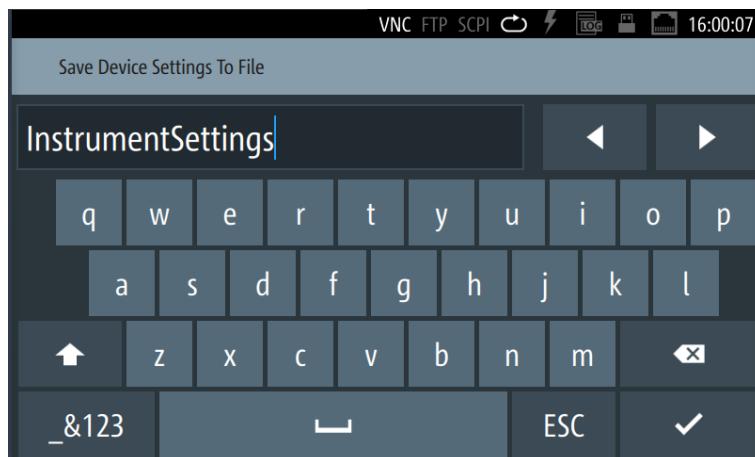

Figure 6-8: Alphanumeric on-screen keyboard

- **Info dialogs**

An "Info dialog" appears when an event generates a message. The generically assigned header shows the affected topic. The message describes the event, and short instructions lead you through the next steps.

- **Scroll bar**

Appears when the list of selection parameters exceeds the size of the screen. Touch and swipe on the screen to scroll up and down.

- **Progress indicator**

Indicates a currently running process. If a process takes some time, a progress bar shows the current state.

6.2.2 Accessing the functionality

All functionalities are provided in dialogs, menus, editors or keypads, as known from computer programs. You can control the instrument intuitively with the touchscreen. This section provides an overview of the accessing methods.

Apart from the main menus "Measurement" and "Device", we use the term "dialog" to refer to all editable windows.

You can access the instrument's functions and settings by using one of the following controls:

- System and function keys at the front panel of the instrument
- Interactive softkeys on the touchscreen, underlined in gray

To open the main menus

To open the two main menus:

1. Press the [settings] at the front panel.
2. Select (tap) the corresponding tab on the screen.

The selection leads you either to a settings parameter directly, or to a dedicated dialog.

To open a dialog

To open one of the dialogs, or editors, you have several options:

1. Press the corresponding hardkey at the front panel, e.g. the [Freq.] key.
2. Select (tap) a softkey on the screen, e.g. "Frequency:"

To close a dialog

1. To return to the home screen, press the [home] key.
2. To return to a previous dialog, the R&S LCX provides several softkeys:
 - Softkeys that prompt you to confirm your selection, as e.g. "Select" or "Ok"
 - the  (back) softkey in the left upper corner of a dialog
 - Softkeys that prompt you to confirm your selection, as e.g. "Select" or "Ok" automatically close a dialog.
 - the [Back] key or the [rotary knob] at the front panel

To select a parameter

If many parameters are available, they are often provided in a list:

1. If necessary, scroll through the list.

Tip: You do not need the focus exactly on the bar, touch and swipe the list.
2. As an alternative, you can use the [rotary knob]:
 - a) Turn the knob to select the parameter.
 - b) Press the knob to confirm your selection.

6.2.3 Entering data

Some parameters have their own key at the front panel.

For data input in dialogs, the instrument provides on-screen keypads for entering numeric and alphanumeric values. Thus, you can always set the parameters using the touchscreen, or the navigation controls at the front panel.

To correct an entry

1. To delete an entry, set the cursor to the right of the entry you want to delete.
To select the position:
 - a) Select (tap) it in the entry field directly.
 - b) Use the cursor softkeys of the on-screen keypad.
 - c) Use the [◀], or [▶] keys at the front panel.
2. On the on-screen keypad, select "Clear".
Deletes the entry to the left of the cursor.
3. Enter your correction.

To complete the entry

To confirm the entry:

- ▶ On the on-screen keyboard, select  (confirm).

To abort the entry

- ▶ On the on-screen keypad, select "ESC".

The dialog closes without changing the settings.

Pressing the [rotary knob] also cancels the action and returns to the previous screen.

6.2.3.1 Entering numeric parameters

To enter values with the on-screen keypad

For numeric settings, the instrument displays the numeric keypad. The units specified correspond to the units of the parameter.

1. Enter the numeric value.
2. Select the unit button to complete the entry.
The unit is added to the entry.

3. If the parameter does not require a unit, confirm the entered value with .

To enter values by using the front panel controls

You can also control the R&S LCX with the front panel controls, e.g. if you have locked the touchscreen.

See "Using the User Button Function" in the user manual.

1. Select the corresponding settings hardkey at the front panel, e.g. select [Freq.].
The on-screen keypad opens.
2. Press the [rotary knob].
The R&S LCX changes to edit mode, and returns to the home screen.
3. Turn the [rotary knob] to select the corresponding entry field (framed **orange**).
4. To enter a value, e.g. the frequency, use the controls as follows:
 - a) Pressing the [rotary knob] enables the entry field for editing.
 - b) Turning the knob decreases or increases the currently selected digit (highlighted in **blue**).
 - c) Pressing the button again switches to the next digit.
Alternatively, you can use the [◀] or [▶] keys.
5. To enter a selection editor, e.g. to change a measurement parameter indicated in the result window:
 - a) Turn the [rotary knob] to select the parameter (softkey on the screen).
 - b) Press the [rotary knob].
The selection editor opens.
 - c) Turn the knob to scroll within the list.
 - d) Press the [rotary knob] again to confirm your selection.
6. To access the main menus and subdialogs, use the functionality of the [rotary knob] and the [◀] or [▶] keys the same way.

6.2.3.2 Entering alphanumeric parameters

If a field requires alphanumeric input, you can use the on-screen keyboard to enter letters and (special) characters.

Access and control are similar as described above.

6.3 Remote control

In addition to operating the R&S LCX directly on the instrument, it is also possible to operate and control it from a remote PC.

Remote control interfaces

The R&S LCX provides several interfaces for remote control:

- Ethernet (LAN) interface
- USB standard interface
- IEE-488 bus interface (GPIB) (option: R&S NG-B105)

For detailed information on how to configure the remote control interfaces, see the user manual, chapter "Network and Remote Control Operation".

See [Chapter 3.7, "Connecting to LAN"](#), on page 21 for an example on how to set up LAN connection for remote control.

7 Contacting customer support

Technical support – where and when you need it

For quick, expert help with any Rohde & Schwarz product, contact our customer support center. A team of highly qualified engineers provides support and works with you to find a solution to your query on any aspect of the operation, programming or applications of Rohde & Schwarz products.

Contact information

Contact our customer support center at www.rohde-schwarz.com/support, or follow this QR code:



Figure 7-1: QR code to the Rohde & Schwarz support page

Index

- A**
- Access
 - Instrument 48
 - Active elements 46
 - Alphanumeric parameters 51
 - Application cards 13
 - Application notes 13
- B**
- Basic steps
 - Trying out 34
 - Bench top, placing the R&S LCX 15
 - Bias
 - connector 32
 - Fuse holder 32
 - Binning
 - connector 32
 - BNC
 - Connectors 30
 - Brochures 12
- C**
- Carrying the instrument 14
 - Checking the instrument 14
 - Configuration preset
 - Indicator 41, 44
 - Softkeys 44
 - Connect to power
 - How to: 20
 - Connecting
 - LAN 21
 - Memory stick 22
 - Power 18
 - Test fixture 23
 - USB devices 22
 - Connecting measurement equipment 23
 - Connector
 - AC power supply 31
 - Bias external 32
 - Bias fuse 32
 - Binning interface 32
 - BNC 30
 - Digital I/O interface 32
 - GPIB 31
 - H CUR 30
 - H POT 30
 - IEC/IEEE 31
 - L CUR 30
 - L POT 30
 - LAN 33
 - Trigger external 32
 - USB A 30, 33
 - USB B 33
- D**
- Connectors
 - Front panel 30
 - Considerations
 - EMI 17
 - Test setup 17
 - Customer support 53
- D**
- Data entry 49
 - Data sheets 12
 - Digital I/O interface
 - connector 32
 - Display
 - Active elements 46
 - Context-sensitive menu 46
 - Front panel 27
 - Info line 46
 - On-screen keypad 46
 - Tab labels 46
 - Display information 40
 - Documentation overview 11
 - Driver for remote control 13
- E**
- EMI
 - Considerations 17
- F**
- Front panel
 - Connectors 30
 - Display 27
 - Overview 26
 - Status bar 41
 - Front panel keys
 - Usage 39
 - Function keys
 - Front panel tour 28
 - Fuse holder
 - AC power supply 31
 - Bias 32

- Fuses
- How to replace the bias fuse 18
 - How to replace the line fuse 19
- G**
- Getting started 11
 - Ground socket 30
 - Ground terminal 32
- H**
- How to:
- Access settings 49
 - Align the instrument on all frequencies 36
 - Basic measurement steps 34
 - Configure the test signal 35
 - Connect a test fixture 23, 35
 - Connect to LAN 21
 - Connect to power 20
 - Connect USB storage device 22
 - Disconnect the instrument from power 25
 - Enter data. 50
 - Measure a resistor 37
 - Mount the instrument in a rack 16
 - Replace the bias fuse 18
 - Replace the line fuse 19
 - Set an initial state 35
 - Shut down 25
 - Switch on 25
 - Unmount the instrument from a rack .. 17
- I**
- Inductance measurement 28
- Instrument**
- Carrying 14
 - Checking 14
 - Lifting 14
 - Operating site 14, 15
 - Tour 26
 - Unpacking 14
- Instrument control** 38
- Manual operation 38
 - Remote control 38
 - Ways of operation 38
- Instrument Control**
- Status bar 41
- Instrument security procedures** 12
- Instrument status bar** 41
- K**
- Kensington lock 31
 - Key 28
 - ◀ 28
 - ★ (User) 28
 - Auto 29
 - Back 28
 - Bias enable 29
 - Bias Level 29
 - C (capacity) 29
 - Comp. (level compensation) 29
 - Freq (frequency) 29
 - Hold 29
 - home 28
 - L (inductance) 29
 - Level 29
 - On/Standby 29
 - R (resistance) 29
 - Range (frequency range) 29
 - Rotary knob 28
 - settings 28
 - Transformer 29
 - Trigger 29
 - Keyboard
 - On-screen 49
 - Keypad
 - On-screen 49
- L**
- LAN
 - Connecting 21
 - How to: Connect for remote access 21
 - Lifting the instrument 14
- M**
- Manual interaction 38
 - Manual operation 38
 - Measurement control keys
 - Front panel tour 29
 - Measurement function keys
 - Front panel tour 28
 - Measurement mode keys
 - Front panel tour 28
 - Measurement settings keys
 - Front panel tour 29
 - Measurement status bar 43
 - Mounting, in a rack 16

- N**
- Navigation controls
 - Front panel tour 28
 - Numeric data entry 49
 - Numeric parameters 50
- O**
- On-screen keyboard 51
 - On-screen keypad 46
 - Open source acknowledgment (OSA) 13
 - Operating site
 - Choosing 14
 - Setting up the instrument 15
 - Operation
 - Manually 38
 - Remotely 52
 - Overview
 - Front panel 26
 - Rear panel 30
- P**
- Parameters
 - Entering 50, 51
 - Power
 - Connecting the instrument 18
 - Power on
 - Key 29
 - Power states 25
 - Power supply
 - Connector 31
 - Fuse holder 31
 - Switch 31
 - Power switch
 - AC power supply 31
 - Preparing for use 14
 - Preset
 - Configuration indicator 41, 44
- R**
- Rack, mounting 16
 - Rear panel
 - Overview 30
 - Release notes 13
 - Remote control 38, 52
 - Driver 13
 - Interfaces 52
 - Replace the bias fuse
 - How to: 18
 - Replace the line fuse
 - How to: 19
- S**
- Safety information 5
 - Safety instructions 5, 12
 - Security procedures 12
 - Service manual 12
 - Settings keys
 - Front panel tour 29
 - Specifications document 12
 - Standby
 - Key 29
 - Status bar
 - Front panel 41
 - Instrument 41
 - Measurement 43
 - Status bar information
 - Measurement status bar 43
 - Switching on or off 25
- T**
- Test fixture
 - Connecting 23
 - Test setup
 - Considerations 17
 - Text entry 49
 - Touchscreen
 - Front panel 27
 - Usage 38
 - Trigger
 - Connector 32
 - Trying out
 - Basic steps 34
 - Tutorials 11
- U**
- Unpacking the instrument 14
 - USB A
 - Connector 30, 33
 - USB B
 - Connector 33
 - User manual 11
 - Using the front panel keys 39
 - Using the touchscreen 38
 - Utility keys
 - Front panel tour 28
- W**
- Ways of operation 38

White papers 13