

R&S® ZNB3000

VECTOR NETWORK ANALYZER

Specifications

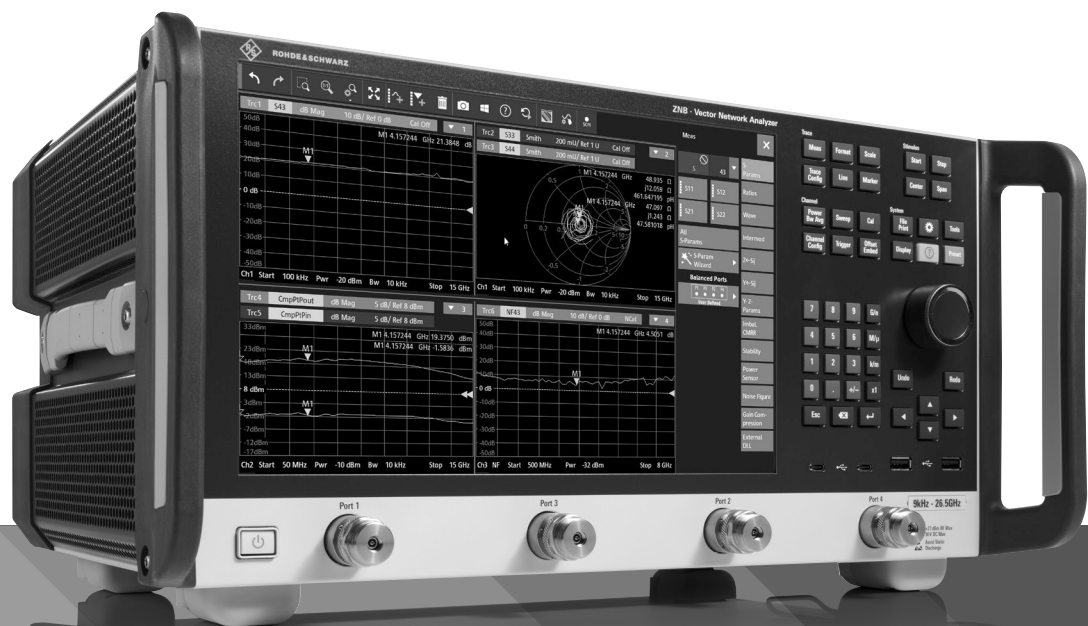

Specifications
Version 02.01

ROHDE & SCHWARZ
Make ideas real



CONTENTS

Definitions	4
Measurement range	5
Dynamic range	6
Measurement speed.....	7
R&S®ZNB3004 measurement accuracy.....	9
R&S®ZNB3020 measurement accuracy.....	11
Effective system data	13
Factory-calibrated system data	14
Test port output.....	16
Test port input.....	17
Additional front panel connectors.....	18
Display	18
Rear panel connectors	18
Options	20
R&S®ZNB3-B1.....	20
R&S®ZNB-B4.....	20
R&S®ZNB-B10.....	20
R&S®ZNB-B12.....	20
R&S®ZN-B14.....	21
R&S®ZNB3-B22/-B24	21
R&S®ZNB3-B31/-B32/-B33/-B34.....	21
R&S®ZNB3-B52/-B54	21
R&S®ZNB-B81.....	22
R&S®ZNB3-K30.....	23
R&S®ZNB3-K980.....	23
General data	24
Dimensions (in mm).....	25
Ordering information	27

Definitions

General

Product data applies under the following conditions:

- Three hours of storage at ambient temperature followed by 30 minutes of warm-up operation
- Specified environmental conditions met
- Recommended calibration interval adhered to
- All internal automatic adjustments performed, if applicable

Specifications with limits

Represent warranted product performance by means of a range of values for the specified parameter. These specifications are marked with limiting symbols such as $<$, \leq , $>$, \geq , \pm or descriptions such as maximum, limit of, minimum. Compliance is ensured by testing or is derived from the design. Test limits are narrowed by guard bands to take into account measurement uncertainties, drift and aging, if applicable. All specification data is valid between +18 °C and +28 °C.

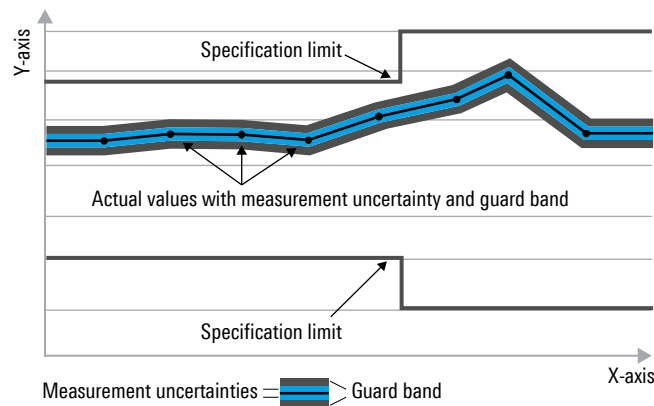

Non-traceable specifications with limits (n. trc.)

Represent product performance that is specified and tested as described under “Specifications with limits” above. However, product performance in this case cannot be warranted due to the lack of measuring equipment traceable to national metrology standards. In this case, measurements are referenced to standards used in the Rohde & Schwarz laboratories.

Specifications without limits

Represent warranted product performance for the specified parameter. These specifications are not specially marked and represent values with no or negligible deviations from the given value, e.g. dimensions or resolution of a setting parameter. Compliance is ensured by design.

Typical data (typ.)

Characterizes product performance by means of representative information for the given parameter. When marked with $<$, $>$ or as a range, it represents the performance met by approximately 80 % of the instruments at production time. Otherwise, it represents the mean value.

Nominal values (nom.)

Characterize product performance by means of a representative value for the given parameter, e.g. nominal impedance. In contrast to typical data, a statistical evaluation does not take place and the parameter is not tested during production.

Measured values (meas.)

Characterize expected product performance by means of measurement results gained from individual samples.

Uncertainties

Represent limits of measurement uncertainty for a given measurand. Uncertainty is defined with a coverage factor of 2 and has been calculated in line with the rules of the Guide to the Expression of Uncertainty in Measurement (GUM), taking into account environmental conditions, aging, wear and tear.

Device settings and GUI parameters are designated with the format “parameter: value”.

Non-traceable specifications with limits, typical data as well as nominal and measured values are not warranted by Rohde & Schwarz.

In line with the 3GPP standard, chip rates are specified in million chips per second (Mcps), whereas bit rates and symbol rates are specified in billion bit per second (Gbps), million bit per second (Mbps), thousand bit per second (kbps), million symbols per second (MSPS) or thousand symbols per second (ksps), and sample rates are specified in million samples per second (Msample/s). Gbps, Mcps, Mbps, MSPS, kbps, ksps and Msample/s are not SI units.

Measurement range

Impedance		50 Ω
Test port connector	R&S®ZNB3004	type N, female
	R&S®ZNB3020	3.5 mm, male, ruggedized
Number of test ports	R&S®ZNB3004	2 or 4
	R&S®ZNB3020	2 or 4
Frequency range ¹	R&S®ZNB3004	9 kHz to 4.5 GHz
	R&S®ZNB3004 with R&S®ZNB3-B082/ R&S®ZNB3-B084	9 kHz to 9.0 GHz
	R&S®ZNB3020	9 kHz to 20.0 GHz
	R&S®ZNB3020 with R&S®ZNB3-B262/ R&S®ZNB3-B264	9 kHz to 26.5 GHz

Static frequency accuracy	The static frequency accuracy is determined with the formula <i>(time since last adjustment in years x aging per year) + temperature drift + achievable initial calibration accuracy</i> using the values specified below. Depending on whether or not the R&S®ZNB-B4 precision frequency reference option is installed, the standard or the improved value have to be taken into account.	
Aging per year	standard	$\pm 1 \times 10^{-6}$
	with R&S®ZNB-B4 precision frequency reference option	$\pm 1 \times 10^{-7}$
Temperature drift (+5 °C to +40 °C)	standard	$\pm 1 \times 10^{-6}$
	with R&S®ZNB-B4 precision frequency reference option	$\pm 1 \times 10^{-8}$
Achievable initial calibration accuracy	standard	$\pm 5 \times 10^{-7}$
	with R&S®ZNB-B4 precision frequency reference option	$\pm 5 \times 10^{-8}$

Frequency resolution		1 Hz
Number of measurement points	per trace	1 to 100 001
Measurement bandwidth	1/1.5/2/3/5/7 steps	
	base unit	1 Hz to 1 MHz
	with R&S®ZNB3-K17 option for increased IF bandwidth	1 Hz to 10 MHz

¹ Specified and typical data given in this specifications document apply to the R&S®ZNB3004 and the R&S®ZNB3020; note their respective frequency ranges with and without the corresponding frequency upgrade option.

Dynamic range

The receiver noise floor referred to in the following is defined as the root mean square (RMS) value of the data trace of the transmission magnitude, which is produced by noise and crosstalk with the test ports short-circuited. The specifications apply at 10 Hz measurement bandwidth, without user correction applied. The dynamic range can be increased by using a measurement bandwidth of 1 Hz. Crosstalk does not limit the dynamic range. Dynamic range performance is specified between port 1 and port 2 as well as between port 3 and port 4 (4-port model). Otherwise, dynamic range performance is typical.

	Specification	Typical	
System dynamic range ²	R&S®ZNB3004, with or without R&S®ZNB3-B082/B084 (without additional options, for extended dynamic range refer to Options)		
	9 kHz to 100 kHz	≥ 110 dB	122 dB
	100 kHz to 50 MHz	≥ 125 dB	138 dB
	50 MHz to 7GHz	≥ 130 dB	140 dB
	7 GHz to 8.5 GHz	≥ 120 dB	130 dB
	8.5 GHz to 9.0 GHz	≥ 115 dB	125 dB
	R&S®ZNB3020, respectively with or without R&S®ZNB3-B262/B264 ³		
	9 kHz to 300 kHz	≥ 115 dB	125 dB
	300 kHz to 1 MHz	≥ 135 dB	145 dB
	1 MHz to 10 MHz ⁴	≥ 140 dB	150 dB
	10 MHz to 100 MHz	≥ 145 dB	155 dB
	100 MHz to 24 GHz	≥ 140 dB	150 dB
	24 GHz to 26.5 GHz	≥ 135 dB	145 dB

² Difference between maximum output power and receiver noise floor.

³ Without enhanced dynamic range mode the nominal system dynamic range above 100 kHz is reduced by 15 dB to 20 dB. Below 100 kHz, the impact could be higher.

⁴ It may typically be degraded at 2 MHz.

Measurement speed

Measured with firmware version 4.10 and Windows 11.

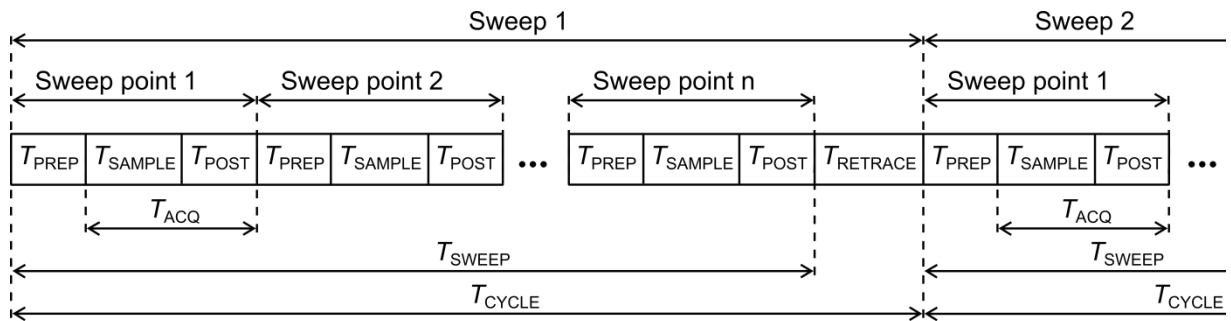

- T_{PREP} Preparation time required to set up the internal hardware components
- T_{SAMPLE} Sampling time (approximately equal to the settling time of the digital filters)
- T_{POST} Time required for hardware postprocessing
- T_{ACQ} Acquisition time ($T_{SAMPLE} + T_{POST}$)
- T_{SWEEP} Time required for one sweep
- $T_{RETRACE}$ Time between two sweeps
- T_{CYCLE} Sweep cycle time ($T_{SWEEP} + T_{RETRACE}$)

Measurement sequence

Nominal sweep cycle times in ms versus number of measurement points ⁵ of the R&S®ZNB3004, with or without R&S®ZNB3-B082/B084, sweep mode: stepped

Number of measurement points	51	201	401	1601	5001
800 MHz start frequency, 1 GHz stop frequency, Memory AGC on, 500 kHz measurement bandwidth					
With correction switched off	0.8	1.3	2.1	5.7	15.1
With 2-port TOSM calibration	1.4	2.6	4.4	11.5	29.7
With 4-port TOSM calibration	2.6	5.8	8.2	22.8	60.9
1 MHz start frequency, 4.5 GHz stop frequency, Memory AGC on, 500 kHz measurement bandwidth					
With correction switched off	1.2	1.9	2.9	6.9	17.1
With 2-port TOSM calibration	2.2	3.7	4.9	12.3	32.4
With 4-port TOSM calibration	4.2	7.2	10.4	25.9	65.8
1 MHz start frequency, 9.0 GHz stop frequency, Memory AGC on, 500 kHz measurement bandwidth					
With correction switched off	1.7	2.6	3.6	7.7	17.4
With 2-port TOSM calibration	3.2	4.7	6.5	13.9	33.7
With 4-port TOSM calibration	6.2	9.6	12.8	28.7	69.3

Nominal sweep cycle times in ms versus number of measurement points ⁵ of the R&S®ZNB3020, with or without R&S®ZNB3-B262/B264, sweep mode: stepped

Number of measurement points	51	201	401	1601	5001
9 GHz start frequency, 10 GHz stop frequency, 500 kHz measurement bandwidth					
With correction switched off	1.1	1.9	3.1	9.4	18.3
With 2-port TOSM calibration	1.7	3.5	6.2	13.5	30.0
With 4-port TOSM calibration	4.3	9.9	14.7	25.9	62.3
1 MHz start frequency, 20 GHz stop frequency, 500 kHz measurement bandwidth					
With correction switched off	3.6	4.3	5.2	10.4	21.7
With 2-port TOSM calibration	7.0	8.5	10.7	18.4	39.1
With 4-port TOSM calibration	14.2	17.6	22.4	39.7	79.3
1 MHz start frequency, 26.5 GHz stop frequency, 500 kHz measurement bandwidth					
With correction switched off	3.9	4.8	5.9	11.8	21.7
With 2-port TOSM calibration	7.7	9.6	11.0	21.2	40.1
With 4-port TOSM calibration	15.6	20.0	23.7	43.7	80.1

⁵ Sweep time is to be understood as cycle time; static frequency accuracy of the instrument applies; measured with firmware version 4.10, Windows 11.

R&S®ZNB3004 measurement accuracy

This data is valid between +18 °C and +28 °C, provided the temperature has not varied by more than 1 °C since calibration. Validity of the data is conditional if an R&S®ZV-Z270 calibration kit is used. This calibration kit is used to achieve the effective system data specified below. Frequency points, measurement bandwidth and sweep time have to be identical for measurement and calibration (no interpolation allowed).

Uncertainty of transmission measurements		Magnitude	Phase
9 kHz to 100 kHz	+0 dB to -20 dB	0.05 dB	0.5°
	-20 dB to -40 dB	0.07 dB	0.6°
	-40 dB to -50 dB	0.09 dB	0.7°
	-50 dB to -60 dB	0.21 dB	1.4°
> 100 kHz to 4 GHz	+0 dB to -20 dB	0.05 dB	0.5°
	-20 dB to -40 dB	0.07 dB	0.6°
	-40 dB to -50 dB	0.09 dB	0.7°
	-50 dB to -60 dB	0.20 dB	1.4°
> 4 GHz to 6.5 GHz	+0 dB to -20 dB	0.05 dB	0.5°
	-20 dB to -40 dB	0.07 dB	0.6°
	-40 dB to -50 dB	0.11 dB	0.8°
	-50 dB to -60 dB	0.25 dB	1.7°
> 6.5 GHz to 9.0 GHz	+0 dB to -20 dB	0.05 dB	0.6°
	-20 dB to -40 dB	0.09 dB	0.8°
	-40 dB to -50 dB	0.20 dB	1.4°
	-50 dB to -60 dB	0.60 dB	4.1°

Specifications are based on a matched DUT, a measurement bandwidth of 10 Hz and a nominal source power of -10 dBm.

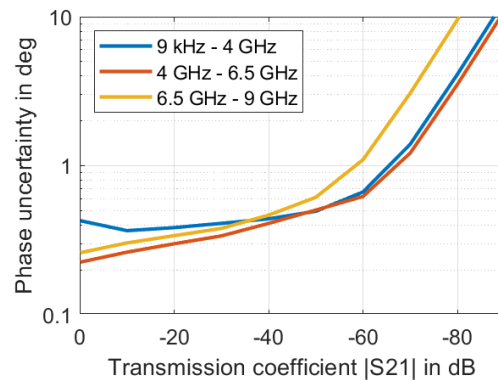
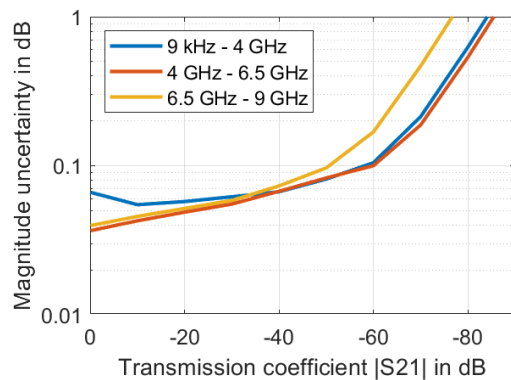

Typical uncertainty of transmission magnitude and transmission phase measurements for the R&S®ZNB3004 with or without frequency upgrade option, in the frequency range from 9 kHz to 9.0 GHz; analysis conditions: $S_{11} = S_{22} = 0$, cal. power: -10 dBm, meas. power: -10 dBm

Uncertainty of reflection measurements	Logarithmic			Linear	
	Reflection level	Magnitude	Phase	Reflection range	Magnitude
9 kHz to 100 kHz	0 dB	0.1 dB	1.0°	0 dB to -15 dB	0.017
	-15 dB	0.4 dB	2.6°	-15 dB to -25 dB	0.008
	-25 dB	1.1 dB	7.1°	-25 dB to -35 dB	0.007
> 100 kHz to 9.0 GHz	0 dB	0.1 dB	0.7°	0 dB to -15 dB	0.013
	-15 dB	0.3 dB	1.9°	-15 dB to -25 dB	0.006
	-25 dB	0.9 dB	6.1°	-25 dB	0.006

Specifications are based on an isolating DUT, a measurement bandwidth of 10 Hz and a nominal source power of -10 dBm.

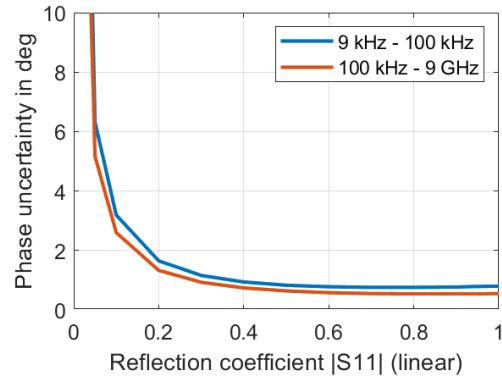
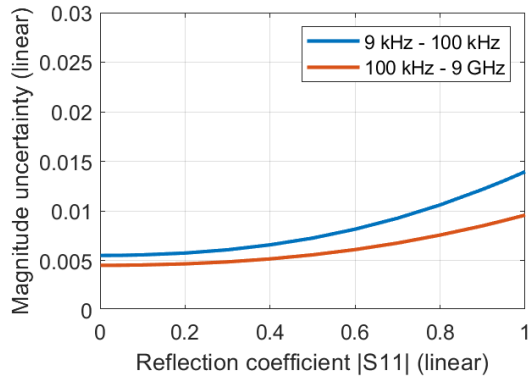

Typical uncertainty of reflection magnitude and reflection phase measurements for the R&S®ZNB3004 with or without frequency upgrade option, in the frequency range from 9 kHz to 9.0 GHz; analysis conditions: $S_{12} = S_{21} = 0$, cal. power: -10 dBm, meas. power: -10 dBm

R&S®ZNB3020 measurement accuracy

This data is valid between +18 °C and +28 °C, provided the temperature has not varied by more than 1 °C since calibration. Validity of the data is conditional if an R&S®ZN-Z235 (with 3.5 mm test port adapter connector) or R&S®ZN-Z229 calibration kit is used. This calibration kit is used to achieve the effective system data specified below. Frequency points, measurement bandwidth and sweep time have to be identical for measurement and calibration (no interpolation allowed).

Uncertainty of transmission measurements		Magnitude	Phase
9 kHz to 300 kHz	0 dB to -20 dB	0.05 dB	0.3°
	-20 dB to -40 dB	0.06 dB	0.4°
	-40 dB to -50 dB	0.08 dB	0.5°
	-50 dB to -60 dB	0.13 dB	0.9°
> 300 kHz to 1 MHz	0 dB to -20 dB	0.04 dB	0.3°
	-20 dB to -40 dB	0.06 dB	0.4°
	-40 dB to -50 dB	0.08 dB	0.5°
	-50 dB to -60 dB	0.13 dB	0.9°
> 1 MHz to 4 GHz	0 dB to -20 dB	0.04 dB	0.3°
	-20 dB to -40 dB	0.06 dB	0.4°
	-40 dB to -50 dB	0.08 dB	0.5°
	-50 dB to -60 dB	0.10 dB	0.7°
> 4 GHz to 9 GHz	0 dB to -20 dB	0.05 dB	0.4°
	-20 dB to -40 dB	0.06 dB	0.5°
	-40 dB to -50 dB	0.08 dB	0.5°
	-50 dB to -60 dB	0.10 dB	0.7°
> 9 GHz to 26.5 GHz	0 dB to -20 dB	0.06 dB	0.7°
	-20 dB to -40 dB	0.07 dB	0.7°
	-40 dB to -50 dB	0.09 dB	0.8°
	-50 dB to -60 dB	0.12 dB	1.0°

Specifications are based on a matched DUT, a measurement bandwidth of 10 Hz, a nominal source power of -10 dBm, EDR Mode on

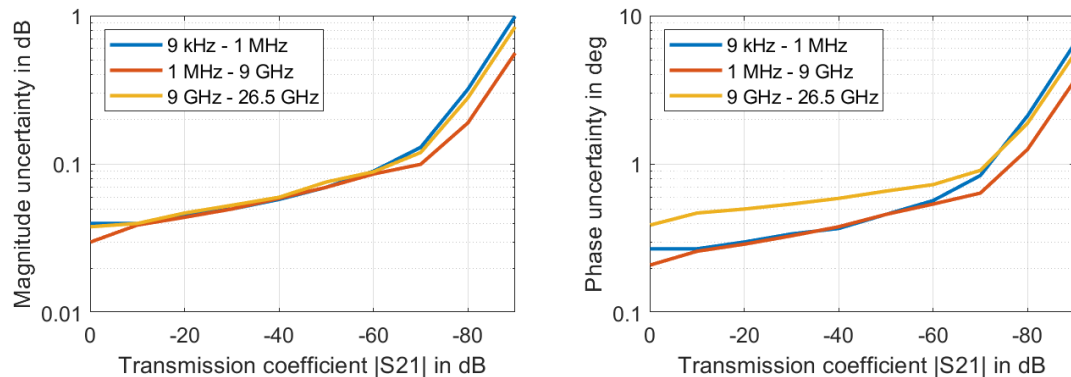

Typical uncertainty of transmission magnitude and transmission phase measurements for the R&S®ZNB3020 with or without frequency upgrade option, in the frequency range from 9 kHz to 26.5 GHz; analysis conditions: $S_{11} = S_{22} = 0$, cal. power: -10 dBm, meas. power: -10 dBm, EDR on

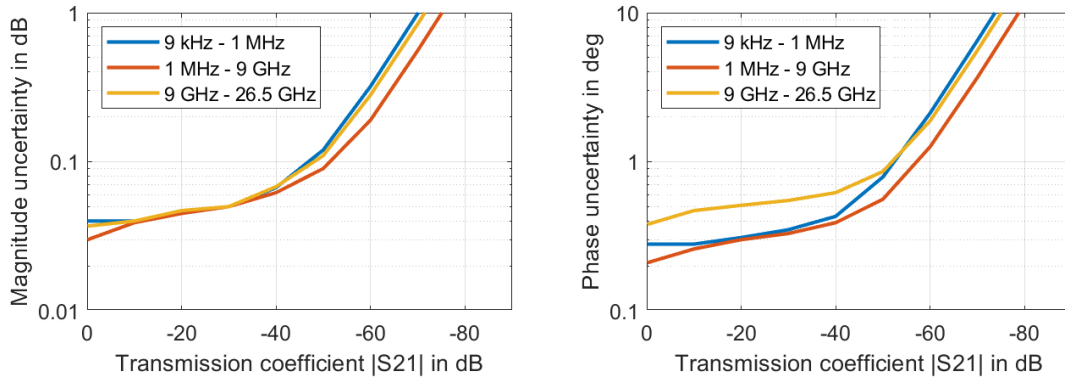

Typical uncertainty of transmission magnitude and transmission phase measurements for the R&S®ZNB3020 with or without frequency upgrade option, in the frequency range from 9 kHz to 26.5 GHz; analysis conditions: $S_{11} = S_{22} = 0$, cal. power: -10 dBm, meas. power: -10 dBm, EDR off

Uncertainty of reflection measurements With R&S®ZN-Z235	Logarithmic			Linear	
	Reflection level	Magnitude	Phase	Reflection range	Magnitude
9 kHz to 10 GHz	0 dB	0.10 dB	0.6°	0 dB to -15 dB	0.011
	-15 dB	0.29 dB	1.9°	-15 dB to -25 dB	0.006
	-25 dB	0.93 dB	6.1°	-25 dB to -35 dB	0.006
> 10 GHz to 20 GHz	0 dB	0.12 dB	0.8°	0 dB to -15 dB	0.014
	-15 dB	0.34 dB	2.3°	-15 dB to -25 dB	0.007
	-25 dB	1.09 dB	7.1°	-25 dB to -35 dB	0.007
> 20 GHz to 26.5 GHz	0 dB	0.14 dB	0.9°	0 dB to -15 dB	0.016
	-15 dB	0.44 dB	2.9°	-15 dB to -25 dB	0.009
	-25 dB	1.40 dB	9.2°	-25 dB to -35 dB	0.009

Specifications are based on an isolating DUT, a measurement bandwidth of 10 Hz and a nominal source power of -10 dBm.

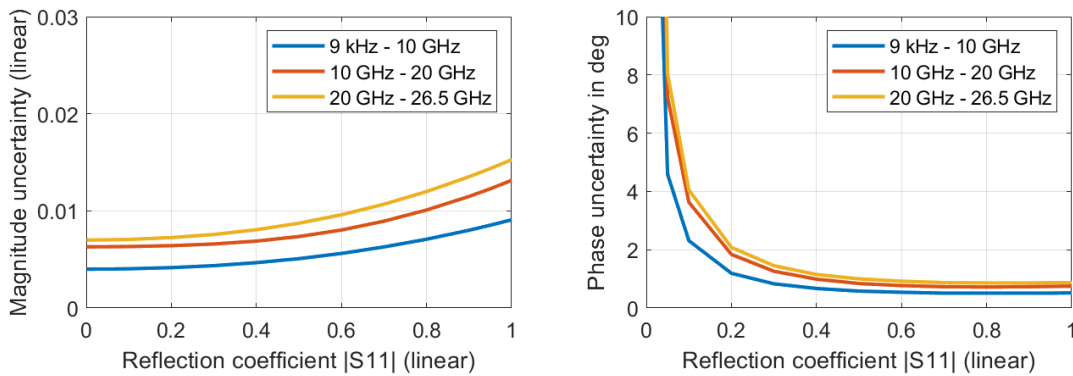

Typical uncertainty of reflection magnitude and reflection phase measurements for the R&S®ZNB3020 with or without frequency upgrade option, in the frequency range from 9 kHz to 26.5 GHz; analysis conditions: $S_{12} = S_{21} = 0$, cal. power: -10 dBm, meas. power: -10 dBm

Effective system data

This data is valid between +18 °C and +28 °C, provided the temperature has not varied by more than 1 °C since calibration. Frequency points, measurement bandwidth and sweep time have to be identical for measurement and calibration (no interpolation allowed). The data is based on a measurement bandwidth of 10 Hz.

R&S®ZNB3004, calibrated using R&S®ZV-Z270	9 kHz to 100 kHz	100 kHz to 9.0 GHz
Directivity	≥ 44 dB	≥ 46 dB
Source match	≥ 39 dB	≥ 43 dB
Load match	≥ 40 dB	≥ 45 dB
Reflection tracking	≤ 0.075 dB	≤ 0.06 dB
Transmission tracking	≤ 0.05 dB	≤ 0.03 dB

R&S®ZNB3020, calibrated using R&S®ZN-Z235	9 kHz to 10 GHz	10 GHz to 20 GHz	20 GHz to 26.5 GHz
Directivity	≥ 46 dB	≥ 44 dB	≥ 42 dB
Source match	≥ 43 dB	≥ 40 dB	≥ 40 dB
Load match	≥ 45 dB	≥ 43 dB	≥ 41 dB
Reflection tracking	≤ 0.04 dB	≤ 0.05 dB	≤ 0.06 dB
Transmission tracking	≤ 0.03 dB	≤ 0.03 dB	≤ 0.03 dB

Factory-calibrated system data

This data is valid between +18 °C and +28 °C. It is based on a source power of –10 dBm and a measurement bandwidth of 1 kHz.

		Specification	Typical
Directivity	R&S®ZNB3004, with or without frequency upgrade option		
	9 kHz to 50 kHz	≥ 20 dB	35 dB
	50 kHz to 9.0 GHz	≥ 30 dB	50 dB
	R&S®ZNB3020, with or without frequency upgrade option		
	9 kHz to 50 kHz	≥ 20 dB	
	50 kHz to 10 GHz	≥ 30 dB	
	10 GHz to 20.0 GHz	≥ 25 dB	
	20.0 GHz to 26.5 GHz	≥ 20 dB	
Source match	R&S®ZNB3004, with or without frequency upgrade option		
	9 kHz to 50 kHz	≥ 20 dB	35 dB
	50 kHz to 9.0 GHz	≥ 30 dB	50 dB
	R&S®ZNB3020, with or without frequency upgrade option		
	9 kHz to 50 kHz	≥ 20 dB	
	50 kHz to 10 GHz	≥ 30 dB	
	10 GHz to 20.0 GHz	≥ 25 dB	
	20.0 GHz to 26.5 GHz	≥ 20 dB	
Reflection tracking	R&S®ZNB3004, with or without frequency upgrade option		
	9 kHz to 9.0 GHz	≤ 0.5 dB	0.05 dB
	R&S®ZNB3020, with or without frequency upgrade option		
	9 kHz to 26.5 GHz	≤ 0.5 dB	
Transmission tracking	R&S®ZNB3004, with or without frequency upgrade option		
	9 kHz to 9.0 GHz	≤ 0.5 dB	0.05 dB
	R&S®ZNB3020, with or without frequency upgrade option		
	9 kHz to 26.5 GHz	≤ 0.5 dB	
Load match	R&S®ZNB3004, with or without frequency upgrade option		
	9 kHz to 50 kHz	≥ 10 dB	15 dB
	50 kHz to 8.5 GHz	≥ 20 dB	25 dB
	8.5 GHz to 9.0 GHz	≥ 15 dB	20 dB
	R&S®ZNB3020, with or without frequency upgrade option		
	9 kHz to 50 kHz	≥ 5 dB	9 dB
	50 kHz to 1 MHz	≥ 15 dB	20 dB
	1 MHz to 100 MHz	≥ 25 dB	35 dB
	100 MHz to 10 GHz	≥ 12 dB	18 dB
	10 GHz to 26.5 GHz	≥ 10 dB	16 dB

Trace stability	IF bandwidth	Specification	Typical	
Trace noise magnitude (RMS)	R&S®ZNB3004, with or without frequency upgrade option ⁶			
	9 kHz to 20 kHz	1 kHz	≤ 0.008 dB	0.004 dB
	20 kHz to 100 kHz	1 kHz	≤ 0.004 dB	0.001 dB
	100 kHz to 100 MHz	10 kHz	≤ 0.004 dB	0.001 dB
	100 MHz to 9.0 GHz	10 kHz	≤ 0.004 dB	0.002 dB
	R&S®ZNB3020, with or without frequency upgrade option ⁷			
	9 kHz to 1 MHz	1 kHz	≤ 0.0015 dB	0.0005 dB
	1 MHz to 16 GHz	10 kHz	≤ 0.0015 dB	0.0005 dB
Trace noise phase (RMS)	R&S®ZNB3004, with or without frequency upgrade option ⁶			
	9 kHz to 20 kHz	1 kHz	≤ 0.070°	0.040°
	20 kHz to 100 kHz	1 kHz	≤ 0.035°	0.010°
	100 kHz to 100 MHz	10 kHz	≤ 0.035°	0.005°
	100 MHz to 9.0 GHz	10 kHz	≤ 0.035°	0.020°
	R&S®ZNB3020, with or without frequency upgrade option ⁷			
	9 kHz to 100 kHz	1 kHz	≤ 0.04°	0.03°
	100 kHz to 1 MHz	1 kHz	≤ 0.015°	0.002°
	1 MHz to 100 MHz ⁸	10 kHz	≤ 0.015°	0.001°
	100 MHz to 6 GHz	10 kHz	≤ 0.015°	0.001°
	6 GHz to 8 GHz	10 kHz	≤ 0.015°	0.002°
	8 GHz to 16 GHz	10 kHz	≤ 0.015°	0.003°
	16 GHz to 24 GHz	10 kHz	≤ 0.015°	0.004°
	24 GHz to 26.5 GHz	10 kHz	≤ 0.015°	0.005°

Measured temperature stability R&S®ZNB3004 ⁹	9 kHz to 100 kHz	100 kHz to 9 GHz
Transmission magnitude, at –10 dBm source power	0.015 dB/K	
Transmission phase ¹⁰ , at –10 dBm source power	0.035°/GHz/K	
Vector network analyzer (VNA) uncertainty model, applicable for R&S®ZNB3-K50 and R&S®ZNB3-K50P real-time measurement uncertainty analysis options		
Tracking magnitude	0.014 dB/K	0.010 dB/K
Symmetry magnitude	0.006 dB/K	0.004 dB/K
Directivity/match	–65 dB	–60 dB
Tracking phase	0.15°/K	0.20°/K
Symmetry phase	0.025°/GHz/K	0.020°/GHz/K

Measured temperature stability R&S®ZNB3020 ⁹	9 kHz to 100 kHz	100 kHz to 8 GHz	8 GHz to 10 GHz	10 GHz to 26.5 GHz
Transmission magnitude, at –10 dBm source power	0.014 dB/K			0.018 dB/K
Transmission phase ¹⁰ , at –10 dBm source power	0.025°/GHz/K			
Vector network analyzer (VNA) uncertainty model, applicable for R&S®ZNB3-K50 and R&S®ZNB3-K50P real-time measurement uncertainty analysis options				
Tracking magnitude	0.004 dB/K	0.008 dB/K	0.01 dB/K	0.014 dB/K
Symmetry magnitude	0.005 dB/K		0.018 dB/K	0.008 dB/K
Directivity/match	–65 dB		–63 dB	–60 dB
Tracking phase	0.15°/K	0.02°/GHz/K		
Symmetry phase	0.15°/K		0.02°/GHz/K	

⁶ At 0 dBm source power, 0 dB reflection.

⁷ At maximum specified source power, 0 dB reflection.

⁸ It may typically be degraded at 2 MHz.

⁹ The stability is obtained by measuring the through connection repeatedly while varying the temperature in the range +18 °C to +28 °C and observing the deviations between the measurements. A temperature drift per Kelvin is deduced.

¹⁰ The phase drift increases linearly with frequency. It is described only by the slope, therefore, the factor between phase drift and frequency is stated.

Test port output

Parameter	Frequency range	Specification	Typical
Power range	without optional extended power range		
	R&S®ZNB3004, with or without frequency upgrade option		
	9 kHz to 100 MHz	-55 dBm to +10 dBm	up to +12 dBm
	100 MHz to 2.5 GHz	-55 dBm to +13 dBm	up to +15 dBm
	2.5 GHz to 7.5 GHz	-55 dBm to +10 dBm	up to +13 dBm
	7.5 GHz to 8.5 GHz	-55 dBm to +8 dBm	up to +12 dBm
	8.5 GHz to 9.0 GHz	-55 dBm to +5 dBm	up to +8 dBm
	R&S®ZNB3020, with or without frequency upgrade option		
	9 kHz to 100 kHz	-30 dBm to +4 dBm	up to +6 dBm
	100 kHz to 1 MHz	-30 dBm to +8 dBm	up to +12 dBm
	1 MHz to 10 MHz	-30 dBm to +10 dBm	up to +15 dBm
	10 MHz to 1 GHz	-30 dBm to +11 dBm	up to +16 dBm
	1 GHz to 6 GHz	-30 dBm to +13 dBm	up to +16 dBm
	6 GHz to 10 GHz	-30 dBm to +13 dBm	up to +15 dBm
	10 GHz to 15 GHz	-30 dBm to +11 dBm	up to +14 dBm
	15 GHz to 20 GHz	-30 dBm to +10 dBm	up to +12 dBm
	20 GHz to 26.5 GHz	-30 dBm to +8 dBm	up to +11 dBm
Minimum power level	using optional extended power range (see Options)		
	R&S®ZNB3004, with or without frequency upgrade option		
	9 kHz to 9.0 GHz	-85 dBm	
	R&S®ZNB3020, with or without frequency upgrade option		
9 kHz to 26.5 GHz	-60 dBm		
Power accuracy, source power: -10 dBm	R&S®ZNB3004, with or without frequency upgrade option		
	9 kHz to 50 kHz	≤ 3 dB	0.5 dB
	50 kHz to 9.0 GHz	≤ 2 dB	0.3 dB
	R&S®ZNB3020, with or without frequency upgrade option		
	9 kHz to 20 GHz	≤ 2 dB	
20 GHz to 26.5 GHz	≤ 2.5 dB		
Power linearity referenced to -10 dBm	R&S®ZNB3004, with or without frequency upgrade option		
	source power ≥ -55 dBm	≤ 1 dB	0.3 dB
	source power < -55 dBm	≤ 2 dB	
	R&S®ZNB3020, with or without frequency upgrade option		
	source power ≥ -30 dBm	≤ 1 dB	
source power < -30 dBm	≤ 2 dB		
Power resolution		0.01 dB	
Second harmonics at 0 dBm and harmonic frequency	R&S®ZNB3004, with or without frequency upgrade option		
	40 kHz to 200 MHz		-30 dBc
	200 MHz to 9.0 GHz		-35 dBc
	R&S®ZNB3020, with or without frequency upgrade option		
	18 kHz to 20 MHz		-20 dBc
20 MHz to 26.5 GHz		-30 dBc	
Third harmonics at 0 dBm and harmonic frequency	R&S®ZNB3004, with or without frequency upgrade option		
	60 kHz to 300 MHz		-30 dBc
	300 MHz to 9.0 GHz		-35 dBc
	R&S®ZNB3020, with or without frequency upgrade option		
	27 kHz to 30 MHz		-20 dBc
30 MHz to 26.5 GHz		-30 dBc	

Test port input

Parameter	Frequency range	Specification	Typical	Nominal
Match	R&S®ZNB3004, with or without frequency upgrade option			
	9 kHz to 50 kHz	> 10 dB		
	50 kHz to 9.0 GHz	> 20 dB		
	R&S®ZNB3020, with or without frequency upgrade option			
	9 kHz to 50 kHz	> 5 dB	9 dB	
	50 kHz to 1 MHz	> 15 dB	20 dB	
	1 MHz to 100 MHz	> 25 dB	35 dB	
Maximum nominal input level	100 MHz to 10 GHz	> 12 dB	18 dB	
	10 GHz to 26.5 GHz	> 10 dB	16 dB	
				+13 dBm
Power measurement accuracy at –10 dBm, without power calibration	R&S®ZNB3004, with or without frequency upgrade option			
	9 kHz to 100 kHz	< 2 dB		
	100 kHz to 9.0 GHz	< 1 dB		
	R&S®ZNB3020, with or without frequency upgrade option			
	9 kHz to 100 kHz	< 2 dB		
	100 kHz to 20 GHz	< 1 dB		
Compression at test port input, input level: > 0 dBm, referenced to –10 dBm	R&S®ZNB3004, with or without frequency upgrade option			
	9 kHz to 7.5 GHz	0 dBm to +10 dBm	< 0.2 dB	
	7.5 GHz to 9 GHz	0 dBm to +8 dBm	< 0.2 dB	
	R&S®ZNB3020, with or without frequency upgrade option			
	9 kHz to 100 kHz	0 dBm to +4 dBm	< 0.2 dB	
	100 kHz to 1 MHz	0 dBm to +8 dBm	< 0.2 dB	
	1 MHz to 10 MHz	0 dBm to +10 dBm	< 0.2 dB	
	10 MHz to 1 GHz	0 dBm to +11 dBm	< 0.2 dB	
	1 GHz to 10 GHz	0 dBm to +13 dBm	< 0.2 dB	
	10 GHz to 15 GHz	0 dBm to +11 dBm	< 0.2 dB	
	15 GHz to 20 GHz	0 dBm to +10 dBm	< 0.2 dB	
	20 GHz to 26.5 GHz	0 dBm to +8 dBm	< 0.2 dB	
	Linearity at test port input, input level: –50 dBm to 0 dBm, referenced to –10 dBm	R&S®ZNB3004, R&S®ZNB3020, with or without frequency upgrade option		
9 kHz to 9.0 GHz			< 0.1 dB	
9.0 GHz to 26.5 GHz			< 0.1 dB	
Damage level		+27 dBm		
Damage DC voltage		30 V		
Noise level ¹¹ , at 1 kHz measurement bandwidth, normalized to 1 Hz	R&S®ZNB3004, with or without frequency upgrade option			
	9 kHz to 100 kHz		< –120 dBm	–130 dBm
	100 kHz to 4 GHz		< –130 dBm	–140 dBm
	4 GHz to 7 GHz		< –125 dBm	–138 dBm
	7 GHz to 9.0 GHz		< –120 dBm	–132 dBm
	R&S®ZNB3020, with or without frequency upgrade option ¹²			
	9 kHz to 300 kHz		< –125 dBm	–135 dBm
	300 kHz to 1 MHz		< –130 dBm	–140 dBm
	1 MHz to 10 MHz ¹³		< –135 dBm	–145 dBm
	10 MHz to 100 MHz		< –140 dBm	–147 dBm
	100 MHz to 3 GHz		< –140 dBm	–147 dBm
	3 GHz to 9 GHz		< –138 dBm	–146 dBm
	9 GHz to 17 GHz		< –139 dBm	–146 dBm
17 GHz to 26.5 GHz		< –139 dBm	–147 dBm	

¹¹ The noise level is defined as the RMS value of the specified noise floor. For different bandwidth add $[10 \times \log_{10}(\text{bandwidth} / 1 \text{ Hz})]$ to the given noise level.

¹² Without enhanced dynamic range mode the nominal noise level is reduced by 15 dB to 20 dB.

¹³ It may typically be degraded at 2 MHz.

Additional front panel connectors

USB		2 ports, type A plug, USB 2.0, max. current 0.9A 2 ports, type C plug, USB 2.0, max. current 1.5A
-----	--	--

Display

Screen		30.7 cm (12.1") diagonal WXGA, 18-bit color LCD with touchscreen
Resolution		1280 × 800 pixel, 125 dpi
Pixel failure rate		$< 1 \times 10^{-5}$

Rear panel connectors

LAN		8-pin, RJ-45, 2.5 Gbit/s
USB host		2 ports, type A plug, version 3.0

REF IN		input for external frequency reference signal
Connector type		BNC, female
Input frequency range		1 MHz to 20 MHz, in steps of 1 MHz
Maximum permissible deviation		1 kHz
Input power		-10 dBm to +15 dBm
Input impedance		50 Ω

REF OUT		output for external frequency reference signal
Connector type		BNC, female
Output frequency		10 MHz
Output power		+9 dBm ± 4 dB at 50 Ω

External monitor		
Connector types		HDMI DisplayPort

USER CONTROL		several control and trigger signals, 25-pin D-Sub, 3.3 V TTL, for controlling external generators, for limit checks, sweep signals, etc.
CHANNEL BIT 0 to CHANNEL BIT 3	pin 8 to pin 11 (outputs)	channel-specific, user-configurable bits
CHANNEL BIT 4 to CHANNEL BIT 7	pin 16 to pin 19 (outputs)	channel-specific, user-configurable bits
DRIVE PORT 1 to DRIVE PORT 4	pin 16 to pin 19 (outputs)	indicates drive ports (can alternatively be used for channel bits 4 to 7)
PASS 1 and PASS 2	pin 13 and pin 14 (outputs)	pass/fail results of limit checks
BUSY	pin 4 (output)	measurements running
READY FOR TRIGGER	pin 6 (output)	ready for trigger
EXT GEN TRIGGER	pin 21 (output)	control signal for external generator
EXT GEN BLANK	pin 22 (input)	handshake signal from external generator
EXTERNAL TRIGGER	pin 2 (input)	first trigger input for analyzer, 5 V tolerant
EXTERNAL TRIGGER 2	pin 25 (input)	second trigger input for analyzer, 5 V tolerant

EXT TRIG IN		trigger input for analyzer
Connector type		BNC, female
TTL signal	edge-triggered or level-triggered	3 V, 5 V tolerant
Polarity	selectable	positive or negative
Minimum pulse width		1 μ s
Input impedance		> 10 k Ω

EXT TRIG OUT		trigger output of analyzer
Connector type		BNC, female
Logic high		3.3 V (typ.)

Options

R&S®ZNB3-B1

Bias tee for the R&S®ZNB3004, with or without frequency upgrade option		
Connector type		BNC, female
Maximum nominal input voltage		30 V
Maximum nominal input current		400 mA
Damage voltage		30 V
Damage current		420 mA
Frequency range	R&S®ZNB3004 with R&S®ZNB3-B1	100 kHz to 4.5 GHz
	R&S®ZNB3004 with R&S®ZNB3-B1/ R&S®ZNB3-B08x	100 kHz to 9.0 GHz
Frequency response data		typical and specified data is valid for the limited frequency range given above

Factory-calibrated system data

This data is valid between +18 °C and +28 °C. The data is based on a source power of –10 dBm and a measurement bandwidth of 1 kHz.

	Frequency range	Specification	Typical
Directivity	100 kHz to 4.5 GHz	≥ 30 dB	50 dB
	4.5 GHz to 9.0 GHz	≥ 30 dB	50 dB
Source match	100 kHz to 500 kHz	≥ 20 dB	30 dB
	500 kHz to 9.0 GHz	≥ 30 dB	50 dB
Reflection tracking	100 kHz to 9.0 GHz	≤ 0.5 dB	0.1 dB
Load match	100 kHz to 500 kHz	≥ 10 dB	15 dB
	500 kHz to 9.0 GHz	≥ 18 dB	25 dB
Transmission tracking	100 kHz to 9.0 GHz	≤ 0.5 dB	0.1 dB

R&S®ZNB-B4

Static frequency accuracy		(time since last adjustment × aging rate) + temperature drift + calibration accuracy
Aging per year	with R&S®ZNB-B4 precision frequency reference option	$\pm 1 \times 10^{-7}$
Temperature drift (+5 °C to +40 °C)	with R&S®ZNB-B4 precision frequency reference option	$\pm 1 \times 10^{-8}$
Achievable initial calibration accuracy	with R&S®ZNB-B4 precision frequency reference option	$\pm 5 \times 10^{-8}$

R&S®ZNB-B10

GPIB interface		remote control interface in line with IEEE 488, IEC 60625; 24-pin
----------------	--	--

R&S®ZNB-B12

Device control		
DIRECT CTRL interface		direct control bus output

R&S®ZNB-B14

Handler I/O		several control and trigger signals, 36-pin Centronics connector, TTL compatible, for controlling external devices, limit checks, sweep signals, etc.
Keysight handler interface compatibility		type 3
Input signals	pin 2, pin 18	TTL compatible
Output signals	pin 3 to pin 17, pin 19 to pin 21, pin 30 to pin 34, pin 36	TTL compatible
Input/output signals	pin 22 to pin 29	TTL compatible
+5 V output	pin 35	+5 V, max. 100 mA
Response time of write strobe signal	pin 32	1 µs
Pulse width of write strobe signal	pin 32	1 µs
Pulse width of external trigger signal	pin 18	> 1 µs
Pulse width of sweep end signal	pin 34	> 10 µs

R&S®ZNB3-B22/-B24

Extended power range		Specification	Typical
Power range for the R&S®ZNB3004, with or without frequency upgrade option	9 kHz to 100 MHz	-85 dBm to +10 dBm	up to +12 dBm
	100 MHz to 2.5 GHz	-85 dBm to +13 dBm	up to +15 dBm
	2.5 GHz to 7.5 GHz	-85 dBm to +10 dBm	up to +13 dBm
	7.5 GHz to 9.0 GHz	-85 dBm to +8 dBm	up to +12 dBm
Power range for the R&S®ZNB3020, with or without frequency upgrade option	9 kHz to 100 kHz	-60 dBm to +4 dBm	up to +6 dBm
	100 kHz to 1 MHz	-60 dBm to +8 dBm	up to +12 dBm
	1 MHz to 10 MHz	-60 dBm to +10 dBm	up to +15 dBm
	10 MHz to 1 GHz	-60 dBm to +11 dBm	up to +18 dBm
	1 GHz to 6 GHz	-60 dBm to +13 dBm	up to +16 dBm
	6 GHz to 10 GHz	-60 dBm to +13 dBm	up to +15 dBm
	10 GHz to 15 GHz	-60 dBm to +11 dBm	up to +14 dBm
	15 GHz to 20 GHz	-60 dBm to +10 dBm	up to +12 dBm
20 GHz to 26.5 GHz	-60 dBm to +8 dBm	up to +11 dBm	

R&S®ZNB3-B31/-B32/-B33/-B34

Receiver step attenuators		
Frequency range	R&S®ZNB3004, without R&S®ZNB3-B08x R&S®ZNB3004, with R&S®ZNB3-B08x	9 kHz to 4.5 GHz 9 kHz to 9.0 GHz
Attenuation		0 dB to 30 dB, in 10 dB steps

R&S®ZNB3-B52/-B54

Extended dynamic range		Specification	Typical
Power range, without optional extended power range	9 kHz to 100 kHz	-55 dBm to +8 dBm	
	100 kHz to 6.5 GHz	-55 dBm to +10 dBm	
	6.5 GHz to 7.5 GHz	-55 dBm to +8 dBm	
	7.5 GHz to 8.5 GHz	-55 dBm to +6 dBm	
	8.5 GHz to 9.0 GHz	-55 dBm to +2 dBm	
Minimum power level using optional extended power range (see Options)	9 kHz to 9.0 GHz	-85 dBm	
Second and third harmonics at 0 dBm	20 kHz to 100 MHz		-20 dBc
	100 MHz to 9.0 GHz		-35 dBc
System dynamic range ¹⁴	9 kHz to 50 MHz	≥ 130 dB	140 dB
	50 MHz to 6.5 GHz	≥ 140 dB	150 dB
	6.5 GHz to 8.5 GHz	≥ 130 dB	138 dB
	8.5 GHz to 9.0 GHz	≥ 125 dB	

¹⁴ The dynamic range is defined as the difference between the actual maximum source power and the RMS value of the data trace of the transmission magnitude, which is produced by noise and crosstalk with the test ports short-circuited. The specification apply at 10 Hz measurement bandwidth, without system error correction. The dynamic range can be increased by using a measurement bandwidth of 1 Hz. Crosstalk does not limit the dynamic range. Dynamic range between port 1 and port 2 and between port 3 and port 4 (4-port model). Otherwise the dynamic range performance is typical.

Test port input		Specification	
Match	9 kHz to 50 kHz	≥ 10 dB	
	50 kHz to 8.5 GHz	≥ 18 dB	
	8.5 GHz to 9.0 GHz	≥ 15 dB	
Maximum nominal input level		+10 dBm	
Compression at test port input, input level: > 0 dBm, referenced to -10 dBm		Input power at test port	
	9 kHz to 100 kHz	+8 dBm	< 0.2 dB
	100 kHz to 6.5 GHz	+10 dBm	< 0.2 dB
	6.5 GHz to 7.5 GHz	+8 dBm	< 0.2 dB
	7.5 GHz to 8.5 GHz	+6 dBm	< 0.2 dB
8.5 GHz to 9.0 GHz	+2 dBm	< 0.2 dB	
Linearity at test port input, input level: -50 dBm to 0 dBm, referenced to -10 dBm	9 kHz to 9.0 GHz	≤ 0.1 dB	
Noise level ¹⁵ , at 1 kHz measurement bandwidth, normalized to 1 Hz	9 kHz to 50 kHz	≤ -125 dBm (1 Hz)	
	50 kHz to 50 MHz	≤ -130 dBm (1 Hz)	
	50 MHz to 6.5 GHz	≤ -140 dBm (1 Hz)	
	6.5 GHz to 9.0 GHz	≤ -130 dBm (1 Hz)	

Trace stability	IF bandwidth	Specification	Typical	
Trace noise magnitude (RMS), at 0 dBm source power, 0 dB reflection	9 kHz to 20 kHz	1 kHz	≤ 0.008 dB	0.004 dB
	20 kHz to 100 kHz	1 kHz	≤ 0.005 dB	0.001 dB
	100 kHz to 1 GHz	10 kHz	≤ 0.005 dB	0.001 dB
	1 GHz to 5 GHz	10 kHz	≤ 0.005 dB	0.002 dB
	5 GHz to 9.0 GHz	10 kHz	≤ 0.005 dB	0.003 dB

Note: The R&S®ZNBx-B52/R&S®ZNBx-B54 options cannot be combined with the R&S®ZNBx-B1 option and/or the R&S®ZNBx-B31/R&S®ZNBx-B32/R&S®ZNBx-B33/R&S®ZNBx-B34 options.

R&S®ZNB-B81

This data is valid in the temperature range from +18 °C to +28 °C and with a maximum measurement bandwidth of 10 kHz.

DC inputs		
Number of ports		4
Connector type		BNC, female
Voltage range		±20 V, ±3 V, ±0.3 V
Measurement accuracy	±20 V	2 % of reading ± 0.02 V
	±3 V	2 % of reading ± 0.002 V
	±0.3 V	2 % of reading ± 0.002 V
Input impedance		≥ 1 MΩ
Damage voltage		30 V

¹⁵ The noise level is defined as the RMS value of the specified noise floor.

R&S®ZNB3-K30

Noise figure measurement	
Recommended setup and options	R&S®ZNB3000 with 2 or 4 ports <ul style="list-style-type: none"> • and diode power sensor (e.g. R&S®NRP40S), see Ordering information • and step attenuator (e.g. R&S®RSC), see Ordering information • and external low noise amplifier (LNA) ¹⁶, optional: switchable • and test cables, see Ordering information • and fixed attenuators: 3 dB, 6 dB, 10 dB, etc.
Noise level of test port input	see section test port input

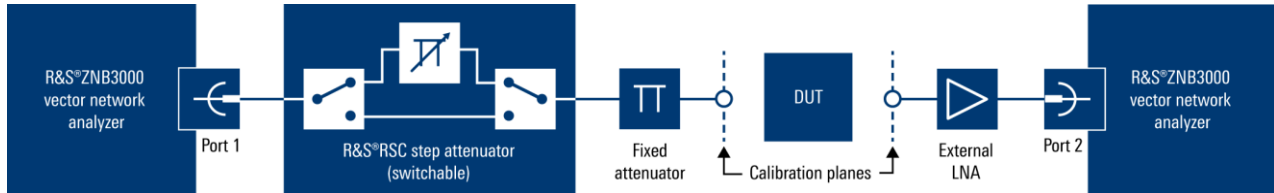

Recommended setup for R&S®ZNB3-K30 noise figure measurement

R&S®ZNB3-K980

Health and utilization monitoring service (HUMS) ^{17, 18}		
Interfaces	protocols and interfaces supported for data readout and display	<ul style="list-style-type: none"> • SNMP (v1, v2c, v3) • REST (JSON) • SCPI • device web
Services	information provided	<ul style="list-style-type: none"> • device information (model, serial number, BIOS, date, time, system, HUMS and software information) • user-defined information tags (e.g. for asset management) • equipment information (hardware, options, software, licenses) • system operating status • instrument security information • service related information (due dates etc.) • mass storage related information • instrument utilization data • device history (event log)

¹⁶ Contact your local Rohde & Schwarz sales office for more information.

¹⁷ For details see application note under: www.rohde-schwarz.com/appnote/GFM336.

¹⁸ For use with common available asset management tools.

General data

Temperature loading		in line with IEC 60068-2-1 and IEC 60068-2-2
	operating temperature range	+5 °C to +40 °C
	storage temperature range	-20 °C to +60 °C
Damp heat		+40 °C at 85 % rel. humidity, in line with IEC 60068-2-30
Altitude	operating environment	max. 2000 m
	storage environment	max. 4500 m
Mechanical resistance	vibration, sinusoidal	5 Hz to 55 Hz, 0.15 mm amplitude constant, 55 Hz to 150 Hz, 0.5 g constant, in line with IEC 60068-2-6
	vibration, random	8 Hz to 500 Hz, acceleration: 1.2 g (RMS) in line with IEC 60068-2-64
	shock	40 g shock spectrum, in line with MIL-STD-810E method no. 516.4 procedure I
Calibration interval		1 year
EMC	RF emission	in line with CISPR 11/EN 55011 group 1 class A (for a shielded test setup); instrument complies with the emission requirements stipulated by EN 55011 and EN 61326-1 class A; this means that the instrument is suitable for use in industrial environments
	immunity	in line with EMC Directive 2014/30/EU including: IEC/EN 61326-1 (immunity test requirement for industrial environment, EN 61326 table 2), IEC/EN 61326-2-1, IEC/EN 61000-3-2, IEC/EN 61000-3-3
Safety		in line with IEC 61010-1, EN 61010-1 and UL 61010-1, CAN/CSA-C22.2 No.61010-1
Power supply		100 V to 240 V \pm 10% 50 Hz to 60 Hz and 400 Hz, max. 3.5 A
Power consumption	R&S®ZNB3004, with 2 ports	max. 450 W, 120 W (typ.)
	R&S®ZNB3004, with 4 ports	max. 450 W, 170 W (typ.)
	R&S®ZNB3020, with 2 ports	max. 450 W, 145 W (typ.)
	R&S®ZNB3020, with 4 ports	max. 450 W, 200 W (typ.)
Test marks		VDE, cCSA _{US} , KCC conformity mark, CE conformity mark
Dimensions	W x H x D	462.5 mm x 239.6 mm x 361.5 mm (18.2 in x 9.4 in x 14.2 in)
Weight	R&S®ZNB3004, R&S®ZNB3020, with 2 ports	14 kg (30.9 lb)
	R&S®ZNB3004, R&S®ZNB3020, with 4 ports	16 kg (35.3 lb)
Shipping weight	R&S®ZNB3004, R&S®ZNB3020, with 2 ports	19 kg (41.9 lb)
	R&S®ZNB3004, R&S®ZNB3020, with 4 ports	21 kg (46.3 lb)

Dimensions (in mm)

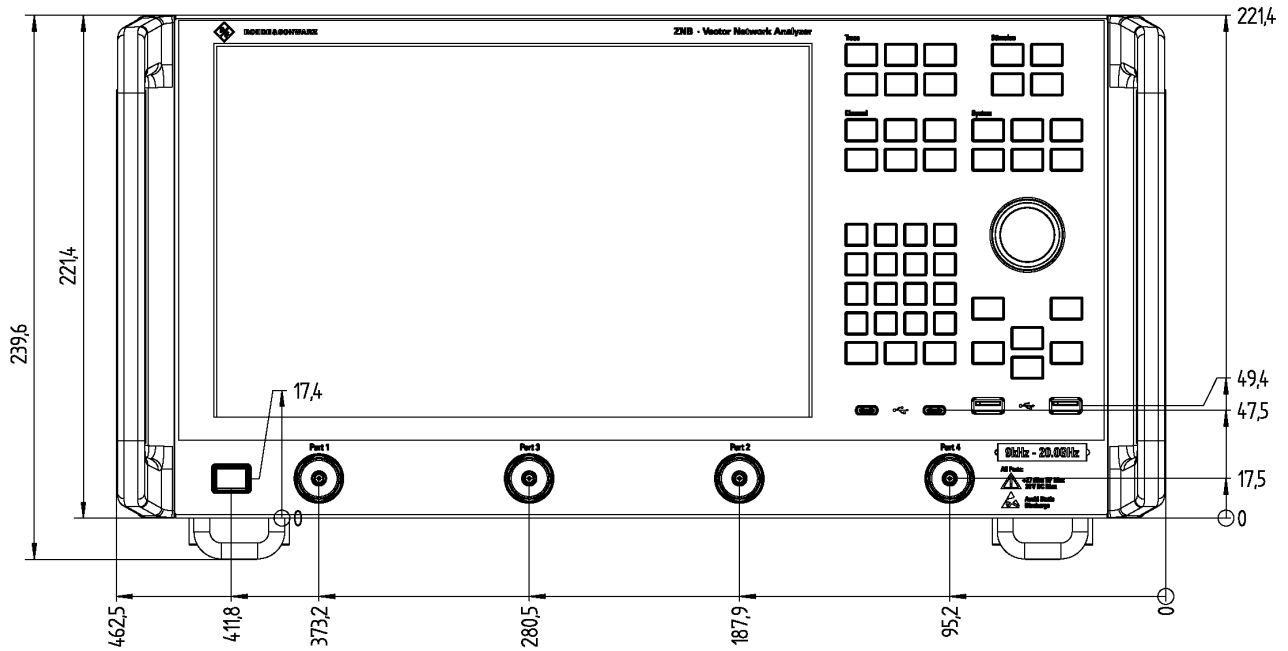

Front view of the R&S®ZNB3000

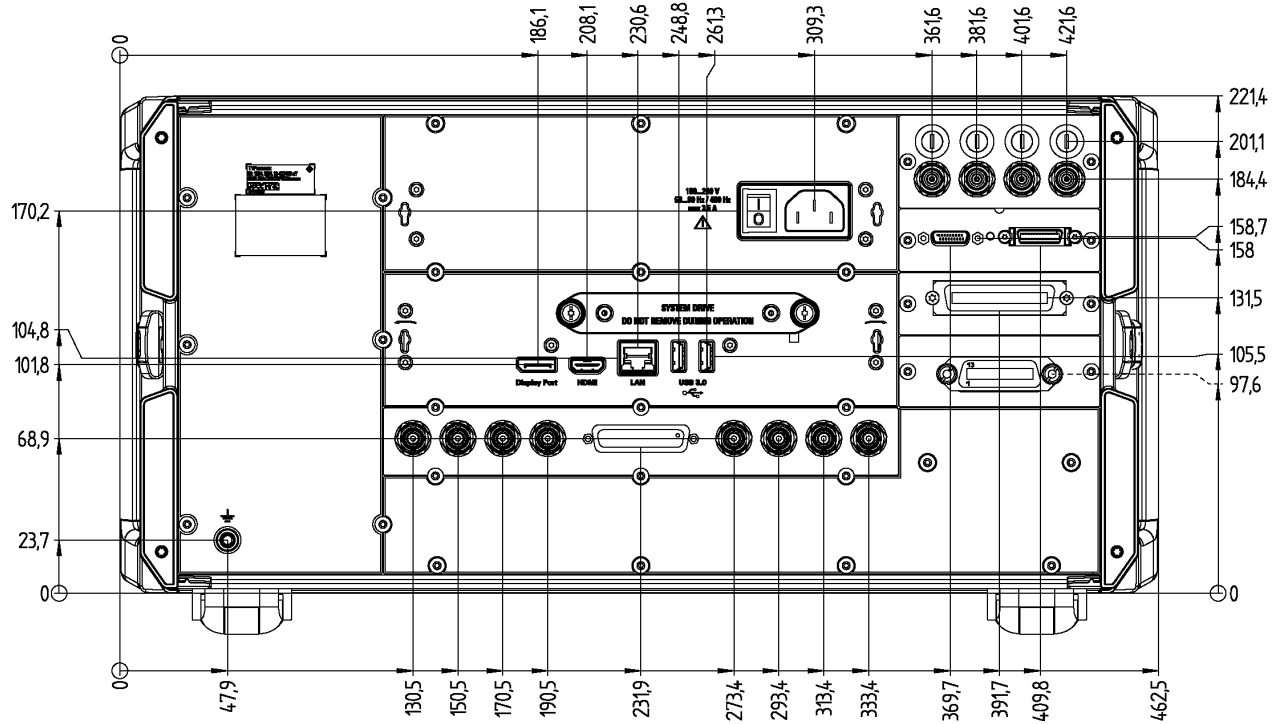

Rear view of the R&S®ZNB3000

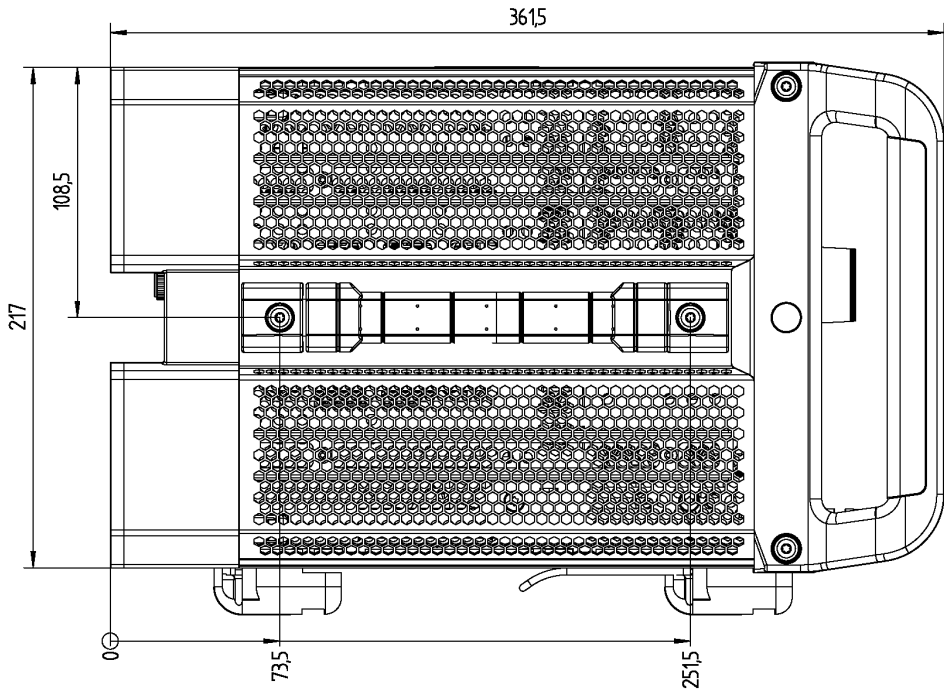

Side view of the R&S®ZNB3000

Ordering information

Designation	Type	Retrofit ¹⁹	On site ²⁰	Order No.
Base unit				
Vector network analyzer, 2-port, 9 kHz to 4.5 GHz (N)	R&S®ZNB3004			1351.5050.02
Vector network analyzer, 4-port, 9 kHz to 4.5 GHz (N)	R&S®ZNB3004			1351.5050.04
Vector network analyzer, 2-port, 9 kHz to 20 GHz (PC3.5)	R&S®ZNB3020			1351.5050.22
Vector network analyzer, 4-port, 9 kHz to 20 GHz (PC3.5)	R&S®ZNB3020			1351.5050.24
Options				
Frequency upgrade				
Upgrade of 2-port R&S®ZNB3004 to 9.0 GHz	R&S®ZNB3-B082	●		1351.5067.02
Upgrade of 4-port R&S®ZNB3004 to 9.0 GHz	R&S®ZNB3-B084	●		1351.5067.04
Upgrade of 2-port R&S®ZNB3020 to 26.5 GHz	R&S®ZNB3-B262	●		1351.5073.02
Upgrade of 4-port R&S®ZNB3020 to 26.5 GHz	R&S®ZNB3-B264	●		1351.5073.04
Extended power range				
Extended power range for 2-port R&S®ZNB3004 base unit	R&S®ZNB3-B22	●		1351.5173.02
Extended power range for 4-port R&S®ZNB3004 base unit	R&S®ZNB3-B24	●		1351.5180.02
Extended power range for 2-port R&S®ZNB3020 base unit	R&S®ZNB3-B22	●		1351.5196.02
Extended power range for 4-port R&S®ZNB3020 base unit	R&S®ZNB3-B24	●		1351.5209.02
Receiver step attenuators				
Receiver step attenuator, port 1, for R&S®ZNB3004 base unit	R&S®ZNB3-B31	●		1351.5250.02
Receiver step attenuator, port 2, for R&S®ZNB3004 base unit	R&S®ZNB3-B32	●		1351.5267.02
Receiver step attenuator, port 3, for R&S®ZNB3004 base unit	R&S®ZNB3-B33	●		1351.5273.02
Receiver step attenuator, port 4, for R&S®ZNB3004 base unit	R&S®ZNB3-B34	●		1351.5280.02
Extended dynamic range ²¹				
Extended dynamic range for 2-port R&S®ZNB3004 base unit	R&S®ZNB3-B52			1351.5296.02
Extended dynamic range for 4-port R&S®ZNB3004 base unit	R&S®ZNB3-B54			1351.5309.02
Bias tees for 2-port R&S®ZNB3004 base unit	R&S®ZNB3-B1			1351.5115.02
Bias tees for 4-port R&S®ZNB3004 base unit	R&S®ZNB3-B1			1351.5121.02
Second internal generator for 4-port R&S®ZNB3004 base unit	R&S®ZNB3-B2	●		1351.5138.02
Second internal generator for 4-port R&S®ZNB3020 base unit	R&S®ZNB3-B2	●		1351.5144.02
Precision frequency reference (OCXO)	R&S®ZNB-B4	●		1316.1769.02
GPIB interface	R&S®ZNB-B10	●	●	1311.5995.04
Device control	R&S®ZNB-B12	●	●	1319.5088.02
Direct control cable	R&S®ZN-B121	●	●	1323.9290.00
Handler I/O	R&S®ZN-B14	●	●	1316.2459.05
RFFE GPIO interface (external)	R&S®ZN-Z15	●	●	1325.5905.02
RFFE GPIO interface (external), including voltage/current measurement	R&S®ZN-Z15	●	●	1325.5905.03
Additional removable SSD, 512 Gbyte	R&S®ZNB3-B19	●	●	1351.5821.02
DC inputs	R&S®ZNB-B81	●		1316.0004.02
Time domain analysis	R&S®ZNB3-K2	●	●	1351.5367.02
Extended time domain analysis	R&S®ZNB3-K20	●	●	1351.5373.02
Distance to fault	R&S®ZNB3-K3	●	●	1351.5380.02
Frequency conversion	R&S®ZNB3-K4	●	●	1351.5396.02
Intermodulation measurements ²²	R&S®ZNB3-K14	●	●	1351.5409.02
10 MHz receiver bandwidth	R&S®ZNB3-K17	●	●	1351.5421.02
Gain compression measurements	R&S®ZNB3-K18	●	●	1355.8902.02
1 mHz frequency resolution	R&S®ZNB3-K19	●	●	1351.5438.02
Noise figure measurement	R&S®ZNB3-K30	●	●	1351.5444.02
Real-time measurement uncertainty analysis ²³	R&S®ZNB3-K50	●	●	1351.5450.02
Real-time measurement uncertainty analysis, preinstalled ²³	R&S®ZNB3-K50P			1351.5467.02
SNP assistant	R&S®ZNB3-K100	●	●	1355.5432.02
EaZy deembedding	R&S®ZNB3-K210	●	●	1351.5480.02
In-situ deembedding	R&S®ZNB3-K220	●		1351.5496.02
Smart fixture deembedding	R&S®ZNB3-K230	●		1351.5509.02
Delta-L PCB characterization	R&S®ZNB3-K231	●		1351.5515.02
Health and utilization monitoring service (HUMS)	R&S®ZNB3-K980	●	●	1351.5521.02
19" rackmount kit	R&S®ZZA-KN5	●	●	1175.3040.00

¹⁹ Option may also be ordered at a later stage, upgrade in service.

²⁰ Option may be installed by the user on site.

²¹ The R&S®ZNBx-B52/-B54 options cannot be combined with the R&S®ZNBx-B1 option and/or the R&S®ZNBx-B31/-B32/-B33/-B34 options.

²² The R&S®ZNB3-K14 requires R&S®ZNB3-K4.

²³ The R&S®ZNB3-K50/-K50P does not support the enhanced dynamic range mode in the R&S®ZNB3020.

Designation	Type	Order No.
Recommended calibration accessories		
Calibration kits for manual calibration – economy		
Calibration kit, 0 Hz to 18 GHz, N (f)	R&S®ZN-Z170	1328.8163.03
Calibration kit, 0 Hz to 26.5 GHz, 3.5 mm (f)	R&S®ZN-Z135	1328.8157.03
Calibration kits for manual calibration – high-end		
Calibration kit, 0 Hz to 18 GHz, N, 50 Ω	R&S®ZV-Z270	5011.6536.02
Calibration kit, 0 Hz to 26.5 GHz, 3.5 mm	R&S®ZN-Z235	1336.8500.02
Calibration units for automatic calibration – economy		
Calibration unit, 5 kHz to 4.5 GHz, 2-port ²⁴	R&S®ZN-ZE104	1350.8040.04
Calibration unit, 5 kHz to 9 GHz, 2-port ¹⁹	R&S®ZN-ZE109	1350.8040.09
Calibration unit, 5 kHz to 26.5 GHz, 2-port ¹⁹	R&S®ZN-ZE126	1350.8040.26
Calibration unit, 100 kHz to 8.5 GHz, 4 ports, SMA (f)	R&S®ZN-Z153	1319.6178.34
Calibration unit, 100 kHz to 8.5 GHz, 6 ports, SMA (f)	R&S®ZN-Z152	1319.6003.36
Calibration unit, 100 kHz to 8.5 GHz, 6 ports, SMA (f)	R&S®ZN-Z154	1319.5120.02
Additional ports 7 to 12, SMA (f)	R&S®ZNZ154-B22	1319.5136.22
Additional ports 13 to 18, SMA (f)	R&S®ZNZ154-B32	1319.5136.32
Additional ports 19 to 24, SMA (f)	R&S®ZNZ154-B42	1319.5136.42
Calibration units for automatic calibration – high-end		
Calibration unit, 100 kHz to 8.5 GHz, 2 ports, N (f)	R&S®ZN-Z51	1319.5507.72
Calibration unit, 100 kHz to 8.5 GHz, 4 ports, N (f)	R&S®ZN-Z51	1319.5507.74
Calibration unit, 100 kHz to 8.5 GHz, 2 ports, 3.5 mm (f)	R&S®ZN-Z51	1319.5507.32
Calibration unit, 100 kHz to 8.5 GHz, 4 ports, 3.5 mm (f)	R&S®ZN-Z51	1319.5507.34
Calibration unit, 9 kHz to 9 GHz, 2 ports, 3.5 mm (f)	R&S®ZN-Z50	1335.6904.30
Calibration unit, 9 kHz to 26.5 GHz, 2 ports, 3.5 mm (f)	R&S®ZN-Z50	1335.6904.32
Calibration unit, 100 kHz to 26.5 GHz, 4 ports, 3.5 mm (f)	R&S®ZN-Z52	1335.6991.30
Calibration unit, 100 kHz to 26.5 GHz, 2 ports, 3.5 mm (f)	R&S®ZN-Z53	1335.7046.32
Calibration unit, 100 kHz to 18 GHz, 2 ports, N (f)	R&S®ZN-Z53	1335.7046.72
Inline calibration units for automatic calibration		
CAN bus controller for inline calibration units	R&S®ZN-Z30	1328.7609.02
Inline calibration unit, 10 MHz to 8.5 GHz	R&S®ZN-Z32	1328.7638.02
Inline calibration unit, 10 MHz to 40 GHz, characterized to 43.5 GHz	R&S®ZN-Z33	1328.7644.02
Inline calibration unit, 10 MHz to 40 GHz, for TVAC, characterized to 43.5 GHz	R&S®ZN-Z33	1328.7644.03
Thermal insulator, 2.92 mm	R&S®ZN-Z391	1350.8504.02
Power sensors		
Three-path diode power sensor, 10 MHz to 33 GHz, 3.5 mm	R&S®NRP33S	1419.0064.02
Attenuators		
Step attenuator, 0 dB to 139 dB, 1 dB steps, DC to 6 GHz, N (f) connectors at front panel, manually switchable	R&S®RSC	1313.8004.03
External step attenuator, 0 dB to 75 dB, 5 dB steps, DC to 40 GHz	R&S®RSC-Z405	1313.9952.02
Switch matrices		
Switch matrix, 10 MHz to 8.5 GHz, 2 VNA ports to 6 test ports	R&S®ZN-Z84	1319.4500.02
Additional test ports 7 to 12, 2 VNA ports to 12 test ports	R&S®ZN-Z84-B22	1319.4969.22
Additional test ports 13 to 18, 2 VNA ports to 18 test ports	R&S®ZN-Z84-B32	1319.4969.32
Additional test ports 19 to 24, 2 VNA ports to 24 test ports	R&S®ZN-Z84-B42	1319.4969.42
Additional test ports 7 to 12, 4 VNA ports to 12 test ports	R&S®ZN-Z84-B24	1319.4969.24
Additional test ports 13 to 18, 4 VNA ports to 18 test ports	R&S®ZN-Z84-B34	1319.4969.34
Additional test ports 19 to 24, 4 VNA ports to 24 test ports	R&S®ZN-Z84-B44	1319.4969.44
Switch matrix, 100 MHz to 26.5 GHz, 2 VNA ports to 6 test ports	R&S®ZN-Z86	1351.2216.02
Additional test ports 7 to 12, 2 VNA ports to 12 test ports	R&S®ZN-Z86-B22	1351.2900.22
Additional test ports 13 to 18, 2 VNA ports to 18 test ports ²⁵	R&S®ZN-Z86-B32	1351.2900.32
Additional test ports 19 to 24, 2 VNA ports to 24 test ports ²⁶	R&S®ZN-Z86-B42	1351.2900.42
Additional test ports 7 to 12, 4 VNA ports to 12 test ports	R&S®ZN-Z86-B24	1351.2900.24
Additional test ports 13 to 18, 4 VNA ports to 18 test ports ²⁷	R&S®ZN-Z86-B34	1351.2900.34
Additional test ports 19 to 24, 4 VNA ports to 24 test ports ²⁸	R&S®ZN-Z86-B44	1351.2900.44
Semi-rigid cable set for R&S®ZNB, 2.92 mm (f) to 2.92 mm (m), 2 or 4 R&S®ZNB ports to R&S®ZN-Z86, benchtop operation	R&S®ZN-ZB26	1328.8911.02

²⁴ Various port options available, see R&S®ZN-ZE1xx specifications (PD 3683.5597.22).

²⁵ Requires R&S®ZN-Z86-B22.

²⁶ Requires R&S®ZN-Z86-B32.

²⁷ Requires R&S®ZN-Z86-B24.

²⁸ Requires R&S®ZN-Z86-B34.

Designation	Type	Order No.
Switch matrix, 100 MHz to 26.5 GHz, with additional RF access	R&S®ZN-Z86X	1351.2222.02
Additional test ports 1 to 12, 2 or 4 VNA ports	R&S®ZNZ86X-B24	1351.2222.24
Additional test ports 1 to 24, 2 or 4 VNA ports	R&S®ZNZ86X-B44	1351.2222.44
Semi-rigid cable set for R&S®ZNB, 2.92 mm (f) to 2.92 mm (m), 2 or 4 R&S®ZNB ports to R&S®ZN-Z86X, benchtop operation	R&S®ZN-ZB26	1328.8911.03
Test cables		
0 Hz to 18 GHz, N (m) to N (m), 50 Ω, length: 0.6 m/1 m	R&S®ZV-Z91	1301.7572.25/.38
0 Hz to 18 GHz, N (m) to N (m), 50 Ω, length: 0.6 m/0.9 m	R&S®ZV-Z191	1306.4507.24/.36
0 Hz to 18 GHz, N (m) to 3.5 mm (m), 50 Ω, length: 0.6 m/1 m	R&S®ZV-Z92	1301.7589.25/.38
0 Hz to 18 GHz, N (m) to 3.5 mm (m), 50 Ω, length: 0.6 m/0.9 m	R&S®ZV-Z192	1306.4513.24/.36
0 Hz to 26.5 GHz, 3.5 mm (f) to 3.5 mm (m), length: 0.6 m/1 m	R&S®ZV-Z93	1301.7595.25/.38
0 Hz to 26.5 GHz, 3.5 mm (f) to 3.5 mm (m), length: 0.6 m/0.9 m/1.5 m	R&S®ZV-Z193	1306.4520.24/.36/ .60

Warranty		
Base unit		1 year
All other items		1 year
Service options		
	Service plans	On demand
Calibration	up to five years ²⁹	pay per calibration
Warranty and repair	up to five years ²⁴	standard price repair
Contact your Rohde & Schwarz sales office for further details.		

The terms HDMI and HDMI High-Definition Multimedia Interface, and the HDMI Logo are trademarks or registered trademarks of HDMI Licensing, LLC in the United States and other countries.

²⁹ For extended periods, contact your Rohde & Schwarz sales office.

Service at Rohde & Schwarz
You're in great hands

- ▶ Worldwide
- ▶ Local and personalized
- ▶ Customized and flexible
- ▶ Uncompromising quality
- ▶ Long-term dependability

Rohde & Schwarz

The Rohde&Schwarz technology group is among the trail-blazers when it comes to paving the way for a safer and connected world with its leading solutions in test & measurement, technology systems and networks & cybersecurity. Founded 90 years ago, the group is a reliable partner for industry and government customers around the globe. The independent company is headquartered in Munich, Germany and has an extensive sales and service network with locations in more than 70 countries.

www.rohde-schwarz.com

Sustainable product design

- ▶ Environmental compatibility and eco-footprint
- ▶ Energy efficiency and low emissions
- ▶ Longevity and optimized total cost of ownership

Certified Quality Management
ISO 9001

Certified Environmental Management
ISO 14001

Rohde & Schwarz training

www.training.rohde-schwarz.com

Rohde & Schwarz customer support

www.rohde-schwarz.com/support

