

R&S® NRPC CALIBRATION KITS

Calibration of power sensors



Product Brochure
Version 06.00

ROHDE & SCHWARZ

Make ideas real



AT A GLANCE

The five modular R&S®NRPC calibration kits are used to calibrate R&S®NRP power sensors, as well as other makes, to a very high level of accuracy. Following calibration, the sensors are within the specified calibration uncertainties and usually remain below these uncertainties. Each calibration kit includes a highly accurate power standard that is traceable to primary power standards of the Physikalisch-Technische Bundesanstalt (PTB, Germany's national metrology institute) by means of a calibration accredited by the Deutsche Akkreditierungsstelle (DAkkS, Germany's national accreditation body).

In combination with a remotely controllable microwave generator, an R&S®NRX power meter and the free-of-charge R&S®Recal+ PC software, the calibration kits enable users to calibrate the power sensors of the R&S®NRP and R&S®FSH family in just a few minutes. Calibration also includes writing the updated calibration values to the sensor's data memory. Plug-ins for the R&S®ZVA and R&S®ZNB vector network analyzers are available for impedance calibration. The calibration uncertainty is determined individually for each power sensor, taking the relevant influence quantities into account.

The additional R&S®NRPC-LS linearity standard complements the calibration setup. It enables remote linearity calibration of the R&S®NRP power sensors.

The R&S®NRPCxx-B1 option is used for regular verification of each R&S®NRPC model. It consists of a thermal power sensor calibrated to the associated power standard and aligned such that it displays, for each frequency point, the same value as the power standard.

Five models are currently available:

- ▶ **R&S®NRPC18** for power sensors with N connector (DC to 18 GHz)
- ▶ **R&S®NRPC33** for power sensors with 3.5 mm connector (DC to 33 GHz)
- ▶ **R&S®NRPC40** for power sensors with 2.92 mm connector (DC to 40 GHz)
- ▶ **R&S®NRPC50** for power sensors with 2.4 mm connector (DC to 50 GHz)
- ▶ **R&S®NRPC67** for power sensors with 1.85 mm connector (DC to 67 GHz)



KEY FACTS

- ▶ Program-controlled calibration of the power sensors of the R&S®NRP and R&S®FSH families
- ▶ Short measurement times for high throughput
- ▶ Modular concept for cost-effective, flexible operation
- ▶ DAkkS-accredited, PTB-traceable

BENEFITS

- High quality and reliability**
▶ page 4
- Precise and accurate**
▶ page 6
- Cost-efficient**
▶ page 8
- Remote control calibration**
▶ page 9

R&S®SMA100B signal generator with R&S®SMA100B-B167 frequency option and R&S®NRPC67 calibration kit

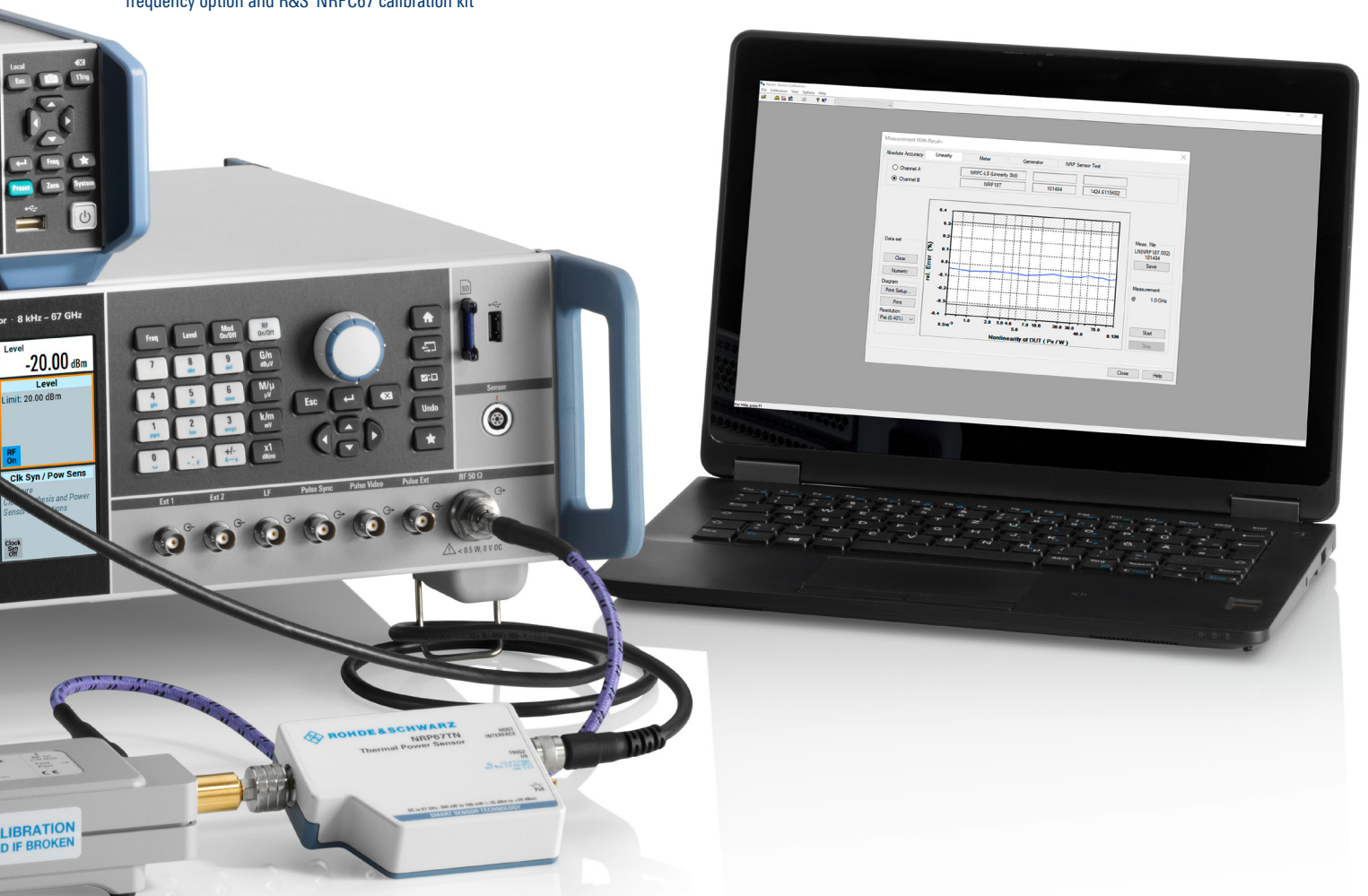

HIGH QUALITY AND RELIABILITY

More than 30 years of experience in manufacturing power meters

Calibration is a matter of trust, especially when using power meters, which are at the top of the calibration hierarchy, for high-frequency test and communications equipment. Rohde&Schwarz and its solid, innovative products have played a key role in shaping this market segment for many years. The company's location in Germany, its experienced development and production experts, and high manufacturing depth ensure that more and more users involved in R&D, production and service worldwide rely on power sensors from Rohde&Schwarz. The technologies developed for these sensors are also used in the R&S®NRPC calibration kits' power standards.

Superior to thermistor based power standards

Especially when extremely high measurement accuracy is required, as is normally the case for power standards, a sensor type based on the antiquated thermistor technology is still being used today. The big advantage of inherent stability is offset by significant limitations that make it extremely difficult to work with these sensors. These limitations include poor impedance matching, long settling times in the seconds range and a small dynamic range.

Examples of R&S®NRP power sensors.



Thermoelectric transducer: used in all thermal power sensors and standards of the R&S®NRP family

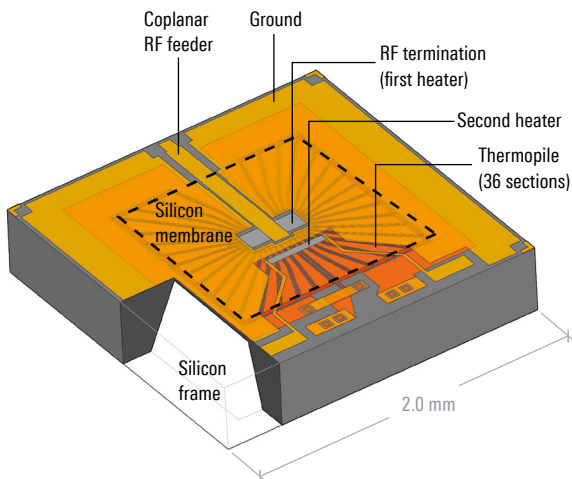

DC reference circuit for thermoelectric transducer

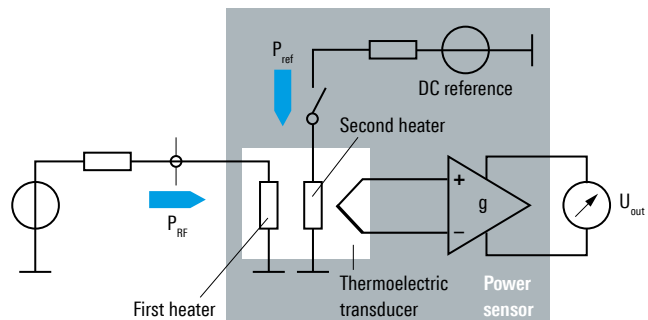

The thermal sensors used in the R&S®NRPC calibration kits' power standards provide more accurate measurements and, at the same time, higher measurement speed, eliminating the disadvantages mentioned above. In addition, the new sensors feature the same high stability provided by thermistor based sensors but are easier to verify, which is a further advantage. The key lies in the frequency range (down to DC) of the thermoelectric transducers used, an exclusive characteristic of all Rohde&Schwarz thermal power sensors. Furthermore, the R&S®NRPC calibration kits provide quick verification at any time: A DC reference circuit has been integrated into the power standard. This allows a fully automatic test to be performed in just a few seconds.

Verification sensor for daily checking

One problem is unsolvable even for the integrated DC reference circuit: detecting a possible degradation of the integrated power splitter or the test port. This is why the R&S®NRPCxx-B1 option is available. It provides a verification sensor that was pre-aligned to the associated power standard during manufacture and exhibits only negligibly small deviations from this standard.

With an impedance of 100 Ω, the verification sensor is extremely mismatched, which makes it possible to detect test port degradation whose only effect is a change in the test port's impedance matching. As a result, the sensor reacts much more sensitively to changes in the source matching than does a normal power sensor, allowing reliable detection of defects.

Exchangeable test port

The test port connector of all R&S®NRPC calibration kits (except R&S®NRPC18) can be easily replaced by the user, eliminating the need for immediate servicing if a power standard's test port is damaged. For this purpose, each calibration kit includes a second connector and corresponding calibration data for the power standard and the verification sensor. As a result, work can continue with unchanged accuracy after only a brief interruption.

Equipment supplied with the R&S®NRPC33/40/50/67, plus R&S®NRPCxx-B1 option



PRECISE AND ACCURATE

Direct link to Germany's national metrology institute

The power standards' stability that is ensured by the DC reference circuit and the verification sensor is an important prerequisite for reproducible, precise measurements. However, to provide a tool suitable for calibrating power sensors, stability needs to be combined with high absolute accuracy. High absolute accuracy means that the traceability to Germany's national metrology institute (PTB) is as direct as possible.

For this reason, Rohde&Schwarz has set up a metrological infrastructure at its production site that allows integration of the transfer standards suitable for exchange with the PTB. Since these transfer standards are also part of the national primary standards, the highest possible level of accuracy is obtained. To keep the influence of random errors as low as possible already at the top of the calibration hierarchy, each frequency point is traced back to the primary standards via the weighted average of multiple transfer standards.

Gamma correction as an important prerequisite

Gamma correction is a synonym for a numeric compensation method that minimizes the mismatch uncertainties accompanying power transfers. As the term implies, the gamma correction method is based on the knowledge of the reflection coefficients of the test port and the DUT and compensates for the measurement errors caused by multiple reflections. For power calibrations in the microwave range, gamma correction is mandatory, because impedance matching generally gets poorer as the frequency increases. This applies to the calibration of power sensors using the R&S®NRPC calibration kits as well as to the calibration of the power standards.

The difficult-to-measure, complex reflection coefficient of the test port plays a key role in gamma correction, since the uncertainty of this coefficient significantly determines the effect of the correction. Through in-house developments and by improving existing methods, Rohde&Schwarz has done pioneering work in this field. The residual mismatch uncertainty following gamma correction has become so small that it is practically negligible.

Calibration hierarchy for Rohde&Schwarz power sensors and standards

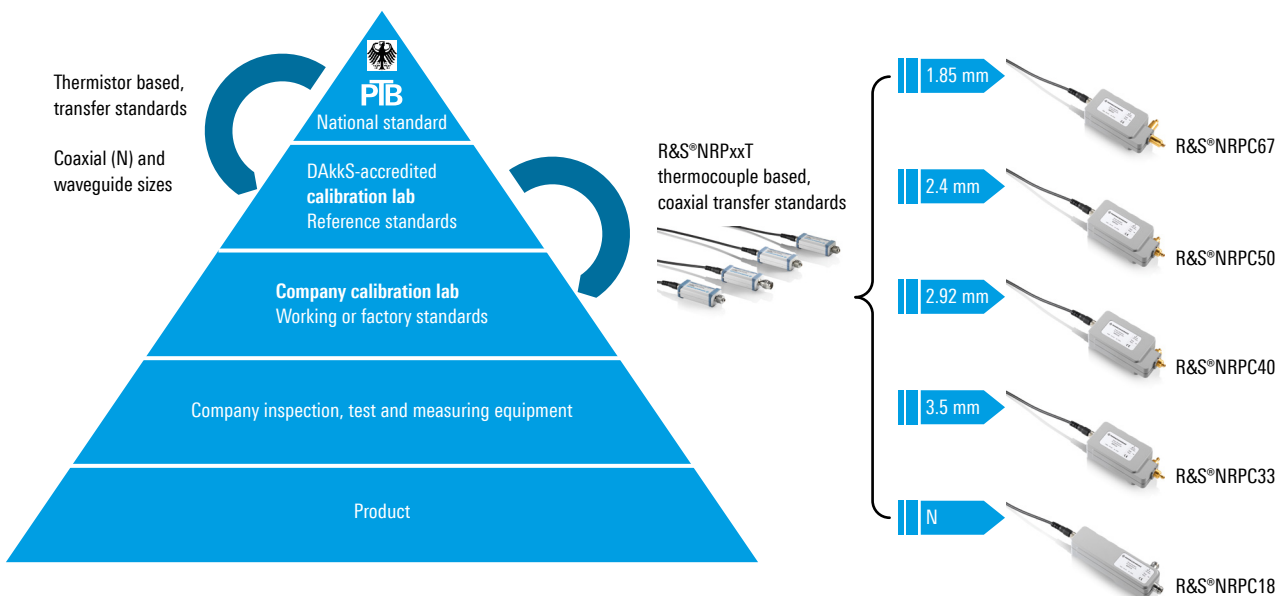

Prior to the power calibration, the DUT's complex reflection coefficients must be determined with a vector network analyzer. If the R&S®Recal+ PC software is used, this procedure can be integrated into power calibration. The user does not have to configure the vector network analyzer or reformat and upload the determined reflection coefficients.

The vector network analyzers and calibration kits that are suitable for integration into R&S®Recal+ are listed in the ordering information.

Dependable specifications

It is difficult to verify the accuracy of power standards, since their measurement uncertainties are in the order of those of the reference instruments. A reliable verification in this respect would require many comparisons with many different reference instruments. This is why the specifications do not state error limits but rather uncertainties for the results delivered by the power standard. Uncertainties are expectation values that are computed according to fixed rules and indicate the spread of

measurement results. The computation takes into account stochastic influences such as measurement noise or the reproducibility of the plug connection, as well as systematic influences whose exact magnitude and sign are unknown. These include, in particular, measurement errors that persist after the correction of known influences due to insufficient knowledge of their exact value.

For the power sensors of the R&S®NRP/R&S®FSH families and the R&S®NRPC calibration kits, Rohde&Schwarz specifies exclusively the measurement uncertainty limits defined in the IEC/EN 60359 standard. Measurement uncertainty limits designate the greatest possible measurement uncertainties that are obtained by a computation according to the rules stated in the GUM¹⁾ and assuming the most unfavorable conditions. The measurement uncertainties achieved in the individual case are usually considerably smaller.

¹⁾ Guide to the Expression of Uncertainty in Measurement (ISO/BIPM guideline).

Measurement uncertainty caused by mismatch as a function of the reflection coefficients of the test port (Γ_{eq}) and of the DUT (Γ_L)

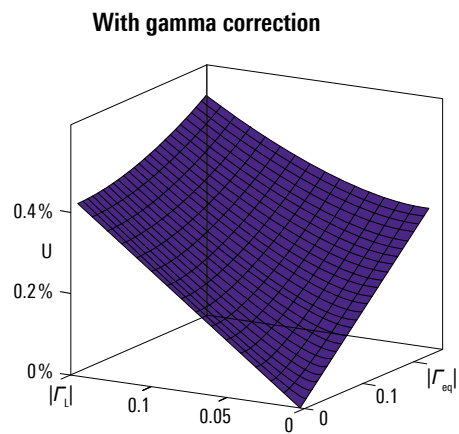
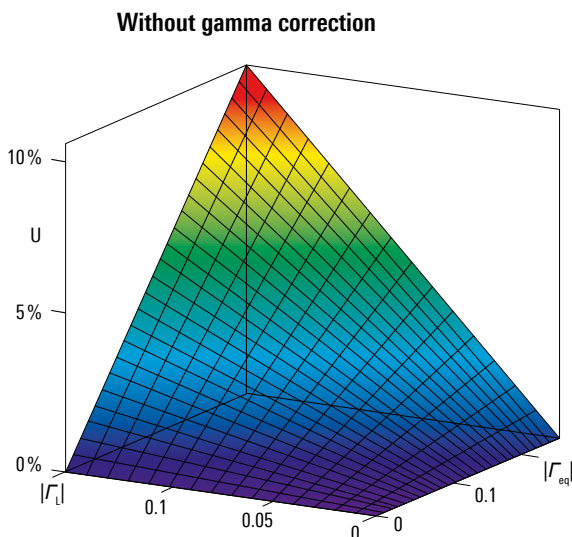

COST-EFFICIENT

Flexible, modular concept

Power measurement assemblies with the R&S®NRPC calibration kit are set up quickly and, because they are compact, can be integrated into almost any work environment. Due to the modular concept, existing signal generators and the R&S®NRX power meter can be used without having to settle for reduced accuracy or performance. This makes good economical sense especially when the power measurement assemblies set up with the R&S®NRPC do not have to be constantly kept ready for operation.

High throughput

The R&S®NRPC calibration kits perform calibration at unprecedented speed. The thermoelectric sensors used in the power standards need only a fraction of the time required by thermistor based sensors. This is particularly advantageous when measurements have to be repeated or when multiple measurement paths must be calibrated. The R&S®Recal+ PC software supports the measurement-time-optimized calibration of power sensors by means of sensor-specific measurement times and parallel measurements on the power standard and the DUT.

For example, for an R&S®NRP40T 40 GHz thermal power sensor, a calibration of the absolute accuracy can be expected to take approx. 4 minutes. Such calibration includes three sweeps from 10 MHz to 40 GHz and subsequent averaging. For an R&S®NRP33S/SN 33 GHz three-path power sensor, the same procedure, including all three measurement paths, takes approx. 15 minutes.

Achievable measurement times per frequency point for the R&S®NRPC and for a thermistor based power standard

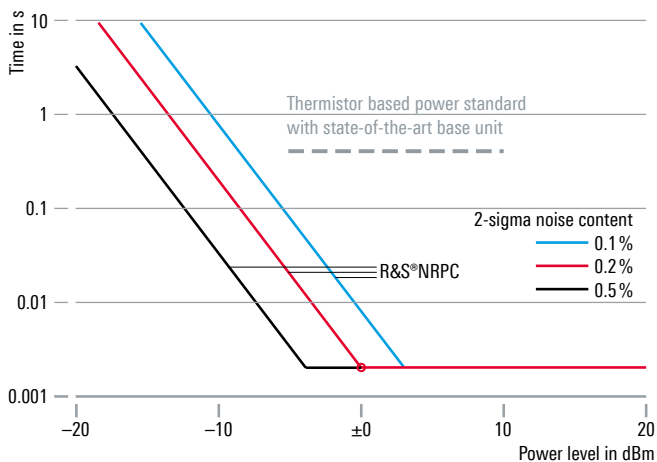

REMOTE CONTROL CALIBRATION

R&S®Recal+ user interface

In combination with a microwave generator, an R&S®NRX power meter and the free-of-charge R&S®Recal+ PC software, the calibration kits enable users to calibrate the power sensors of the R&S®NRP and R&S®FSH families in just a few minutes. The software's interactive user interface offers various standard functions for the measurements and for reading out, computing and writing calibration data to the sensor's data memory. Results can be displayed graphically or in table format. In addition, a complete input or output test report with a cover sheet and a list of measuring equipment can be printed out. The standard scope of functions also includes an archiving function and the possibility to output in plain text the calibration data saved for a sensor. All measuring instruments are controlled via IEC/IEEE bus.

ZVX_Recal plug-in for integrating Rohde & Schwarz vector network analyzers

This plug-in allows different Rohde & Schwarz vector network analyzers to be integrated into the power calibration. Suitable analyzers and associated calibration kits are listed in the ordering information. For users, the integrated reflection measurement has the great advantage that the vector network analyzer is configured and the determined reflection coefficients are uploaded in a suitable format by automatic control. The data can be used for gamma correction and for reporting purposes.

No miscalibrations

Calibration with R&S®Recal+ gives users a certain degree of operating freedom but effectively prevents miscalibrations. All measurements are power-sensor-specifically configured, and critical process steps such as testing and readjusting the power standards via the DC reference circuit are completely inaccessible to the user. If gamma correction is required for a power calibration but the DUT's complex reflection coefficients are not available, it is not possible to generate new correction data from the calibration values. This applies to all power sensors with a frequency limit above 18 GHz. The amount of influence the user exerts on accuracy therefore depends on how much care is taken when screwing the DUT onto the power standard. This means that power sensors can also be calibrated by semi-skilled staff at no major risk.

Integration into application programs

The R&S®NRPC calibration kits can, of course, also be remotely controlled via application programs, for example to calibrate power sensors from other manufacturers or to perform other measurement tasks. The physical connection can be made directly via the power standard's USB interface or via one of the R&S®NRX remote control interfaces (IEC/IEEE bus, Ethernet, USB). All parameters required for the measurements are stored in the power standard's data memory. These parameters include the calibration factors and the test port's equivalent reflection coefficients. For gamma correction, only the DUT's complex reflection coefficients for each frequency point need to be transferred to the power standard, which then performs the complete gamma correction automatically.

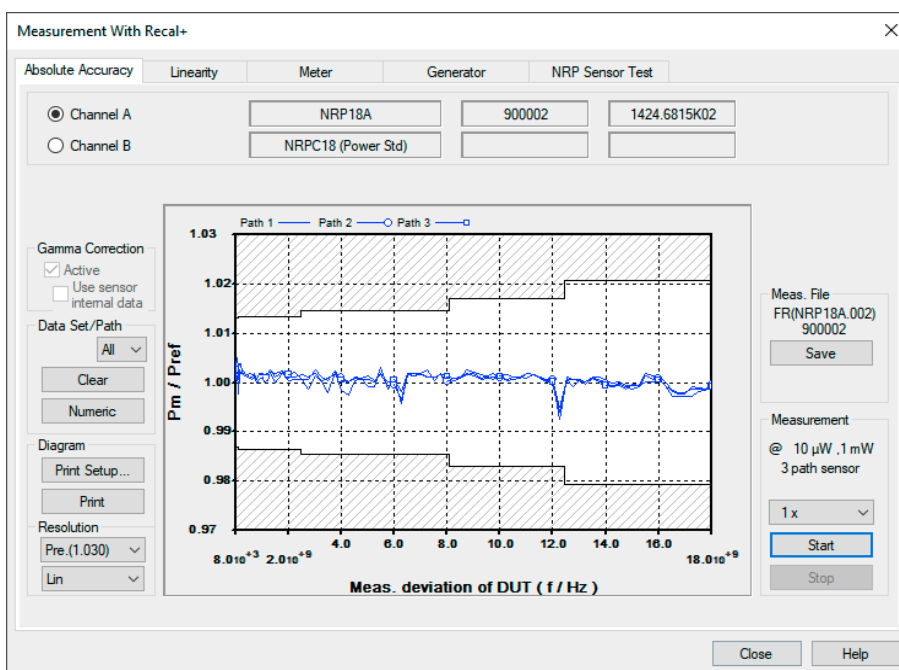

User interface of the R&S®Recal+ PC software with graphical display of the calibration result for an R&S®NRP18A 18 GHz average power sensor.

EXAMPLE

The table below shows a simplified uncertainty budget for the calibration of an R&S®NRP67T power sensor with an R&S®NRPC67 calibration kit at 1 mW (0 dBm). It comprises the major terms only, i.e. the calibration uncertainty of the R&S®NRPC67 and the residual mismatch uncertainty M_u after gamma correction. M_u has been calculated with the following formula:

$$M_u = 200\% \sqrt{2 \left(|\Gamma_{eq}| \frac{U_{\Gamma_{DUT}}}{2} \right)^2 + 2 \left(|\Gamma_{DUT}| \frac{U_{\Gamma_{eq}}}{2} \right)^2}$$

where Γ_{eq} and Γ_{DUT} denote the complex reflection coefficients of the test port and the DUT, whereas $U_{\Gamma_{eq}}$ and $U_{\Gamma_{DUT}}$ denote the expanded uncertainties of these coefficients (see footnote 1 on next page).

Frequency range	DUT reflection coefficient	Uncertainty of Γ_{DUT}	Mismatch uncertainty (k = 2)	Calibration uncertainty of R&S®NRPC67	Total uncertainty (k = 2)
Symbol	$ \Gamma_{DUT} $	$U_{\Gamma_{DUT}}$	M_u		
DC to 100 MHz	< 0.015	0.005	0.07 %	0.7 % (0.030 dB)	0.71 % (0.031 dB)
> 100 MHz to 2.4 GHz	< 0.029	0.005	0.08 %	1.0 % (0.042 dB)	1.01 % (0.044 dB)
> 2.4 GHz to 8.0 GHz	< 0.061	0.007	0.13 %	1.1 % (0.049 dB)	1.11 % (0.048 dB)
> 8.0 GHz to 12.4 GHz	< 0.061	0.009	0.23 %	1.3 % (0.057 dB)	1.33 % (0.057 dB)
> 12.4 GHz to 18.0 GHz	< 0.074	0.010	0.26 %	1.7 % (0.075 dB)	1.73 % (0.074 dB)
> 18.0 GHz to 26.5 GHz	< 0.099	0.014	0.46 %	1.5 % (0.065 dB)	1.57 % (0.068 dB)
> 26.5 GHz to 33.0 GHz	< 0.123	0.015	0.63 %	1.8 % (0.078 dB)	1.91 % (0.082 dB)
> 33.0 GHz to 40.0 GHz	< 0.123	0.015	0.65 %	1.9 % (0.084 dB)	2.01 % (0.086 dB)
> 40.0 GHz to 50.0 GHz	< 0.130	0.017	0.72 %	2.7 % (0.116 dB)	2.80 % (0.120 dB)
> 50.0 GHz to 67.0 GHz	< 0.149	0.020	0.11 %	3.8 % (0.161 dB)	3.93 % (0.167 dB)

SPECIFICATIONS

Power standards							
	R&S®	NRPC18	NRPC33	NRPC40	NRPC50	NRPC67	
Frequency range		DC to 18 GHz	DC to 33 GHz	DC to 40 GHz	DC to 50 GHz	DC to 67 GHz	
Test port power range		10 µW to 100 mW (-20 dBm to +20 dBm)					
Max. input power	average/peak envelope	0.5 W (+27 dBm) continuous/40 W (+46 dBm) for max. 1 µs					
Test port connector		N female	3.5 mm female	2.92 mm female	2.4 mm female	1.85 mm female	
Test port equivalent SWR (equivalent reflection coefficient Γ_{eq})	DC to 4.0 GHz	< 1.07 (< 0.035)	< 1.22 (< 0.10)	< 1.22 (< 0.10)	< 1.22 (< 0.10)	< 1.22 (< 0.10)	
	> 4.0 GHz to 8.0 GHz	< 1.12 (< 0.057)	< 1.22 (< 0.10)	< 1.22 (< 0.10)	< 1.22 (< 0.10)	< 1.22 (< 0.10)	
	> 8.0 GHz to 12.4 GHz	< 1.12 (< 0.057)	< 1.35 (< 0.15)	< 1.35 (< 0.15)	< 1.35 (< 0.15)	< 1.35 (< 0.15)	
	> 12.4 GHz to 18.0 GHz	< 1.17 (< 0.078)	< 1.35 (< 0.15)	< 1.35 (< 0.15)	< 1.35 (< 0.15)	< 1.35 (< 0.15)	
	> 18.0 GHz to 26.5 GHz		< 1.50 (< 0.20)	< 1.50 (< 0.20)	< 1.50 (< 0.20)	< 1.50 (< 0.20)	
	> 26.5 GHz to 33.0 GHz		< 1.65 (< 0.25)	< 1.65 (< 0.25)	< 1.65 (< 0.25)	< 1.65 (< 0.25)	
	> 33.0 GHz to 40.0 GHz			< 1.65 (< 0.25)	< 1.65 (< 0.25)	< 1.65 (< 0.25)	
Uncertainty of Γ_{eq}¹⁾	DC to 4.0 GHz	0.006	0.010	0.010	0.010	0.010	
	> 4.0 GHz to 8.0 GHz	0.008	0.010	0.010	0.010	0.010	
	> 8.0 GHz to 12.4 GHz	0.008	0.015	0.015	0.015	0.015	
	> 12.4 GHz to 18.0 GHz	0.010	0.015	0.015	0.015	0.015	
	> 18.0 GHz to 26.5 GHz		0.017	0.017	0.017	0.017	
	> 26.5 GHz to 33.0 GHz		0.020	0.020	0.020	0.020	
	> 33.0 GHz to 40.0 GHz			0.022	0.022	0.022	
Zero offset	after external zeroing ²⁾	< 28 nW (typ. 15 nW at 1 GHz)					
	Zero drift³⁾	< 8 nW					
	Measurement noise⁴⁾	< 28 nW (typ. 15 nW at 1 GHz)					
	Calibration uncertainty^{5), 6)}	DC to 1 MHz	0.28% (0.012 dB)				
		> 1 MHz to < 10 MHz	0.33% (0.014 dB)				
		≥ 10 MHz to 100 MHz	0.33% (0.014 dB)	0.7% (0.029 dB)	0.7% (0.029 dB)	0.7% (0.030 dB)	0.7% (0.030 dB)
		> 100 MHz to 2.4 GHz	0.50% (0.022 dB)	1.0% (0.041 dB)	1.0% (0.041 dB)	1.0% (0.042 dB)	1.0% (0.042 dB)
> 2.4 GHz to 8.0 GHz		0.68% (0.029 dB)	1.1% (0.048 dB)	1.1% (0.048 dB)	1.1% (0.049 dB)	1.1% (0.049 dB)	
> 8.0 GHz to 12.4 GHz		0.84% (0.036 dB)	1.3% (0.055 dB)	1.3% (0.056 dB)	1.3% (0.057 dB)	1.3% (0.057 dB)	
> 12.4 GHz to 18.0 GHz		1.10% (0.048 dB)	1.7% (0.074 dB)	1.7% (0.075 dB)	1.7% (0.075 dB)	1.7% (0.075 dB)	
> 18.0 GHz to 26.5 GHz			1.4% (0.062 dB)	1.5% (0.063 dB)	1.5% (0.065 dB)	1.5% (0.065 dB)	
> 26.5 GHz to 33.0 GHz		1.7% (0.075 dB)	1.7% (0.075 dB)	1.8% (0.078 dB)	1.8% (0.078 dB)		
> 33.0 GHz to 40.0 GHz			1.9% (0.081 dB)	1.9% (0.084 dB)	1.9% (0.084 dB)		
> 40.0 GHz to 50.0 GHz				2.7% (0.116 dB)	2.7% (0.116 dB)		
> 50.0 GHz to 67.0 GHz					3.8% (0.161 dB)		
Linearity⁷⁾	+23°C ±3.3°C	0.1% (0.004 dB) from -20 dBm to +10 dBm					

¹⁾ Denotes the estimated magnitude of the complex-valued difference between the equivalent test port reflection coefficient and its calibrated value (expressed with a coverage factor of two). Uncertainties of reflection coefficients need to be known for the calculation of the residual mismatch uncertainty after vector-corrected power calibration (gamma correction). The uncertainties given for the test port equivalent reflection coefficient are valid only after calibration at Rohde&Schwarz.

²⁾ Specifications expressed as an expanded uncertainty with a confidence level of 95% (two standard deviations). For calculating zero offsets at higher confidence levels, use the properties of the normal distribution (e.g. 99.7% confidence level for three standard deviations).

³⁾ Within one hour after zeroing, permissible temperature change ±1°C, following a two-hour warm-up of the power standard.

⁴⁾ Two standard deviations at 10.24 s integration time in continuous average mode, with aperture time set to default value. The integration time is defined as the total time used for signal acquisition, i.e. the product of twice the aperture time and the averaging number. Multiplying the noise specifications by $\sqrt{10.24 \text{ s/integration time}}$ yields the noise contribution at other integration times.

⁵⁾ Limits of expanded uncertainty ($k = 2$) for the results delivered by the power standard for measurements performed at the calibration level (0 dBm) within a temperature range of +23°C ±3.3°C and at the calibration frequencies, referenced to the output power available on a perfectly matched load, within one year after calibration. Specifications include uncertainty of calibration, stability over time, temperature effect, zero offset and measurement noise (up to a 2σ value of 0.004 dB).

⁶⁾ Calibration frequencies: DC; from 10 MHz to 100 MHz in 10 MHz steps; from 250 MHz to the upper frequency limit in 250 MHz step. The power standard of R&S®NRPC18 is calibrated at additional frequencies: 9 kHz, 14 kHz, 20 kHz, 30 kHz, 50 kHz, 100 kHz, 200 kHz, 500 kHz, 1 MHz, 2 MHz, 5 MHz.

⁷⁾ Limits of expanded uncertainty ($k = 2$) for relative power measurements referenced to the calibration level (0 dBm), excluding zero offset, zero drift and measurement noise.

Power standard with test port power attenuated by 20 dB ⁸⁾				
	R&S [®]	NRPC18	NRPC33	NRPC40
Frequency range		DC to 18 GHz	DC to 26.5 GHz	DC to 40 GHz
Test port power range		100 nW to 1 mW (−40 dBm to 0 dBm)		
Test port connector		N female	3.5 mm female	2.92 mm female
Test port equivalent SWR (equivalent reflection coefficient Γ_{eq})	DC to 4.0 GHz > 4.0 GHz to 8 GHz 8 GHz to 18 GHz 18 GHz to 26.5 GHz > 26.5 GHz to 40.0 GHz	< 1.11 (< 0.05) < 1.22 (< 0.10) < 1.22 (< 0.10)	< 1.11 (< 0.05) < 1.22 (< 0.10) < 1.22 (< 0.10) < 1.22 (< 0.10)	< 1.11 (< 0.05) < 1.22 (< 0.10) < 1.22 (< 0.10) < 1.22 (< 0.10) < 1.35 (< 0.15)
Uncertainty of Γ_{eq}¹⁾	DC to 8.0 GHz > 8.0 GHz to 12.4 GHz > 12.4 GHz to 18 GHz 18 GHz to 26.5 GHz > 26.5 GHz to 40.0 GHz	0.004 0.005 0.005	0.007 0.010 0.010 0.010	0.007 0.007 0.010 0.010 0.012
Calibration uncertainty⁵⁾	DC to 1 MHz > 1 MHz to < 10 MHz ≥ 10 MHz to 100 MHz > 100 MHz to 2.4 GHz > 2.4 GHz to 4 GHz > 4.0 GHz to 8.0 GHz > 8.0 GHz to 12.4 GHz > 12.4 GHz to 18.0 GHz > 18.0 GHz to 26.5 GHz > 26.5 GHz to 33.0 GHz > 33.0 GHz to 40.0 GHz	0.54 % (0.023 dB) 0.57 % (0.025 dB) 0.57 % (0.025 dB) 0.68 % (0.029 dB) 0.81 % (0.035 dB) 0.94 % (0.041 dB) 1.30 % (0.056 dB) 1.46 % (0.063 dB)	0.7 % (0.031 dB) 1.0 % (0.043 dB) 1.2 % (0.050 dB) 1.2 % (0.050 dB) 1.3 % (0.058 dB) 1.8 % (0.077 dB) 1.5 % (0.065 dB)	0.7 % (0.031 dB) 1.0 % (0.043 dB) 1.1 % (0.050 dB) 1.1 % (0.050 dB) 1.4 % (0.059 dB) 1.8 % (0.078 dB) 1.5 % (0.066 dB) 1.8 % (0.078 dB) 1.9 % (0.083 dB)

⁸⁾ Using the precision attenuator supplied with the R&S[®]NRPC18, R&S[®]NRPC33 and R&S[®]NRPC40.

Verification sensors						
	R&S [®]	NRPC18-B1	NRPC33-B1	NRPC40-B1	NRPC50-B1	NRPC67-B1
Frequency range		DC to 18 GHz	DC to 33 GHz	DC to 40 GHz	DC to 50 GHz	DC to 67 GHz
Power measurement range		1 μW to 100 mW (−30 dBm to +20 dBm)				
Max. input power	average/peak envelope	0.2 W (+23 dBm) continuous/5 W (+37 dBm) for max. 1 μs				
Test port connector		N male	3.5 mm male	2.92 mm male	2.4 mm male	1.85 mm male
Impedance matching (SWR)		< 3 (typ. < 2)				
Calibration uncertainty		not specified; sensors are calibrated and aligned to associated power standard				

Additional characteristics		
Sensor type	power standard	thermoelectric power sensor combined with a resistive power splitter in a power leveling setup
	verification sensors	thermoelectric power sensor
Measurand	power standard	power of wave emanating from test port ⁹⁾
	verification sensors	power of incident wave
Insertion loss (power standards only)	between signal input and test port	6 dB nominal at DC
	over entire frequency range of power standard; including microwave cable	
	R&S [®] NRPC18	< 9.0 dB (typ. < 8.0 dB)
	R&S [®] NRPC33	< 10.9 dB (typ. < 10.0 dB)
	R&S [®] NRPC40	< 11.6 dB (typ. < 10.5 dB)
	R&S [®] NRPC50	< 12.3 dB (typ. < 11.0 dB)
	R&S [®] NRPC67	< 13.5 dB (typ. < 12.0 dB)
Measurement function	stationary and recurring waveforms	continuous average
Continuous average function	measurand	mean power over recurring acquisition interval
	aperture	0.5 ms to 300 ms (5 ms default)
	window function	uniform or von Hann ¹⁰⁾
	duty cycle correction ¹¹⁾	0.001 % to 100 %
	measurement buffer capacity ¹²⁾	1 to 8192 results

Additional characteristics		
Averaging filter	modes	auto off (fixed averaging number) auto on (continuously auto-adapted) auto once (automatically fixed once)
		auto off
	averaging number	1, 2, 4, 6, 8, 10 to 65536 (1 or all even numbers between 2 and 65536)
	auto on/once	
	operating mode: normal	averaging number adapted to resolution setting and power to be measured
	operating mode: fixed noise	averaging number adapted to specified noise content
	result output	
	mode: moving	continuous, independent of averaging number
	rate	can be limited to 0.1 s ⁻¹
	mode: repeat	final result only
Attenuation correction	function	corrects the measurement result by means of a fixed factor (dB offset)
	range	-200.000 dB to +200.000 dB
Embedding (power standards only)	function	incorporates a two-port device at the RF output so that the measurement plane is shifted to the output of this device
	parameters	S ₁₁ , S ₂₁ , S ₁₂ and S ₂₂ of device
	frequencies	0 to 999
Gamma correction (power standards only)	function	removes the influence of impedance mismatch from the measurement result so that the power of the wave emanating at the test port can be read more accurately
	parameters	magnitude and phase of reflection coefficient of DUT
Frequency response correction	function	removes the influence of frequency response for the sensor section and the power splitter
	parameter	center frequency of test signal
	residual uncertainty	see calibration uncertainty specifications $2 \times (\text{aperture} + 300 \mu\text{s}) \times \text{averaging number} + 4 \text{ ms} + t_d$ t_d must be taken into account when auto delay ¹⁴⁾ is active. t_d equals 40 ms with R&S®NRPC33/40/50/67 and 80 ms with R&S®NRPC18
Measurement time ¹³⁾ 2 ^N : averaging number		
Zeroing (duration)		10 s
Temperature effect ¹⁵⁾	DC to 100 MHz	< 0.05%/K (< 0.002 dB/K)
	> 100 MHz to 50 GHz	< 0.10%/K (< 0.004 dB/K)
	> 50 GHz to 67 GHz	< 0.14%/K (< 0.006 dB/K)
Precision termination (part of R&S®NRPC18)		for calibration of R&S®URV5-Z2/-Z4 voltage sensors
	frequency range	DC to 3 GHz
	SWR	< 1.02 (typ. < 1.01)
	max. input power	1 W (+30 dBm)
	RF connector	N male

⁹⁾ Gamma correction can be applied to reduce mismatch uncertainty.

¹⁰⁾ Preferably used with determined modulation when the aperture time cannot be matched to the modulation period. Compared with a uniform window, measurement noise is about 22% higher.

¹¹⁾ For measuring the power of periodic bursts based on an average power measurement.

¹²⁾ To increase measurement speed, the power standard can be operated in buffered mode. In this mode, measurement results are stored in a buffer of user-definable size and then output as a block of data when the buffer is full. To enhance measurement speed even further, the power standard and the verification set can be set to record the entire series of measurements when triggered by a single event. In this case, the power standard and the verification set automatically start a new measurement as soon as the previous measurement is completed.

¹³⁾ Valid for repeat mode, extending from the beginning to the end of all transfers via the USB interface of the power standard. Measurement times under remote control of the R&S®NRX base unit via IEC/IEEE bus are approximately 2.5 ms longer, extending from the start of the measurement up to when the measurement result has been supplied to the output buffer of the R&S®NRX.

¹⁴⁾ With activated auto delay, the beginning of a measurement sequence is delayed so that settled readings are obtained even if the measurement command (remote trigger) coincides with a signal step up to ±10 dB.

¹⁵⁾ Error of the measurement result with respect to temperature.

General data		
Environmental conditions		
Temperature	operating temperature range	+19.7 °C to +26.3 °C
	permissible temperature range	±0 °C to +50 °C
	storage temperature range	-40 °C to +70 °C
Damp heat		+25 °C/+40 °C, 95% relative humidity, cyclic, in line with EN 60068-2-30 with restriction: non-condensing
Mechanical resistance		
Vibration	sinusoidal	5 Hz to 55 Hz, 0.15 mm amplitude constant, 55 Hz to 150 Hz, 0.5 g constant, in line with EN 60068-2-6
	random	10 Hz to 300 Hz, acceleration 1.2 g (RMS), in line with EN 60068-2-64
Shock		40 g shock spectrum, in line with MIL-STD-810E, method 516.4, procedure I
Product conformity		
Electromagnetic compatibility	EU: in line with EMC Directive 2004/108/EC	applied harmonized standards: ▶ EN 61326-1 (industrial environment) ▶ EN 61326-2-1 ▶ EN 55011 (class B)
Safety		in line with EN 61010-1
Calibration interval		1 year
Dimensions and weight		
Dimensions (W × H × L)	case	467 mm × 242 mm × 84 mm (18.39 in × 9.53 in × 3.31 in)
	power standard of R&S®NRPC18	68 mm × 47 mm × 208 mm (2.68 in × 1.85 in × 8.19 in)
	power standard of R&S®NRPC33/40/50	67 mm × 47 mm × 166 mm (2.64 in × 1.85 in × 6.54 in)
	power standard of R&S®NRPC67	75 mm × 47 mm × 177 mm (2.95 in × 1.85 in × 6.97 in)
	verification sensor	48 mm × 30 mm × 138 mm (1.89 in × 1.18 in × 5.43 in)
	length (D) including connecting cable	
		power standard
	verification sensor	1.62 m (64 in)
Weight	case of R&S®NRPCxx, fully equipped	4.2 kg (9.3 lb)
	power standard of R&S®NRPCxx	1.9 kg (4.2 lb)
	R&S®NRPCxx-B1 verification sensors	0.20 kg (0.44 lb)
Product contents	R&S®NRPC18	power standard, precision attenuator, precision termination, microwave cable, adapter cable for R&S®FSH-Z1/-Z18 power sensors, torque wrench, N (male) to BNC (male) adapter, CD-ROM
	R&S®NRPC33/40/50/67	power standard, precision attenuator (not with R&S®NRPC50/67), microwave cable, spare test port connector, torque wrench, adapter from N (male) to connector type (female) of the specific calibration kit, CD-ROM

ORDERING INFORMATION

Designation	Required calibration kit	Type	Order No.
Power sensor calibration kits + options			
Calibration kit, N, DC to 18 GHz, 10 µW to 100 mW		R&S®NRPC18	1418.0931.03
+ Verification kit for R&S®NRPC18		R&S®NRPC18-B1	1418.0954.03
Calibration kit, 3.5 mm, DC to 33 GHz, 10 µW to 100 mW		R&S®NRPC33	1418.0677.03
+ Verification kit for R&S®NRPC33		R&S®NRPC33-B1	1418.0683.03
Calibration kit, 2.92 mm, DC to 40 GHz, 10 µW to 100 mW		R&S®NRPC40	1159.6802.03
+ Verification kit for R&S®NRPC40		R&S®NRPC40-B1	1159.6819.03
Calibration kit, 2.4 mm, DC to 50 GHz, 10 µW to 100 mW		R&S®NRPC50	1159.6883.03
+ Verification kit for R&S®NRPC50		R&S®NRPC50-B1	1159.6890.03
Calibration kit, 1.85 mm, DC to 67 GHz, 10 µW to 100 mW		R&S®NRPC67	1418.1567.02
+ Verification kit for R&S®NRPC67		R&S®NRPC67-B1	1418.1550.02
RF power linearity standard		R&S®NRPC-LS	1421.7004.02
Power meter base units + mandatory options			
Power meter		R&S®NRX	1424.7005.02
+ Second measurement channel		R&S®NRX-K2	1424.9208.02
+ GPIB/IEEE 488 interface		R&S®NRX-B8	1424.8301.02
Signal generators + mandatory options ¹⁾			
RF and microwave signal generator (base unit)		R&S®SMA100B	1419.8888.02
+ Frequency range 8 kHz to 20 GHz	R&S®NRPC18	R&S®SMA-B120	1420.8788.02
+ High output power 20 GHz ²⁾		R&S®SMAB-K33	1420.7300.02
+ Ultra high output power 20 GHz ²⁾	R&S®NRPC-LS	R&S®SMAB-B34	1420.7400.02
+ Frequency range 8 kHz to 40 GHz	R&S®NRPC33/R&S®NRPC40	R&S®SMAB-B140	1420.8988.02
+ Frequency range 8 kHz to 50 GHz	R&S®NRPC50	R&S®SMAB-B150	1420.9049.02
+ High output power 50 GHz		R&S®SMAB-B37	1420.7700.02
+ Frequency range 8 kHz to 67 GHz	R&S®NRPC67	R&S®SMAB-B167	1420.9149.02
+ High output power 67 GHz		R&S®SMAB-B39	1420.7900.02
+ Ultra high output power 67 GHz		R&S®SMAB-K40	1420.9278.02
+ Remote control GPIB/USB		R&S®SMAB-B86	1420.6562.02
Vector network analyzers + mandatory options			
Vector network analyzer, 8.5 GHz, 2 ports	R&S®NRPC18	R&S®ZNB8	1311.6010.42
+ Calibration kit, N type, 0 Hz to 18 GHz		R&S®ZV-Z270	5011.6536.02
Vector network analyzer, 20 GHz, 2 ports	R&S®NRPC18	R&S®ZNB20	1311.6010.62
+ Calibration kit, N type, 0 Hz to 18 GHz		R&S®ZV-Z270	5011.6536.02
Vector network analyzer, 40 GHz, 2 ports	R&S®NRPC33/R&S®NRPC40	R&S®ZNB40	1311.6010.82
+ Calibration kit, 3.5 mm, 0 Hz to 33 GHz		R&S®ZV-Z235E	5011.6707.02
+ Calibration kit, 2.92 mm, 0 Hz to 40 GHz		R&S®ZV-Z229	5011.6559.02
Vector network analyzer, 50 GHz, 2 ports	R&S®NRPC50	R&S®ZNA50	1332.4500.52
+ Calibration kit, 2.4 mm, 0 Hz to 50 GHz		R&S®ZV-Z224	5011.6565.02
Vector network analyzer, 67 GHz, 2 ports	R&S®NRPC67	R&S®ZNA67	1332.4500.62
+ Calibration kit, 1.85 mm, 0 Hz to 67 GHz		R&S®ZV-Z185	5011.6571.02
+ GPIB interface for R&S®ZNB		R&S®ZNB-B10	1311.5995.02

Warranty

Base unit	3 years
All other items ³⁾	1 year

Options

Extended warranty, one year	R&S®WE1	Contact your local Rohde & Schwarz sales office.
Extended warranty, two years	R&S®WE2	
Extended warranty with calibration coverage, one year	R&S®CW1	
Extended warranty with calibration coverage, two years	R&S®CW2	
Extended warranty with accredited calibration coverage, one year	R&S®AW1	
Extended warranty with accredited calibration coverage, two years	R&S®AW2	

¹⁾ The generator option frequency range determines the possible supported R&S®NRPC. For example, R&S®SMAB-B167 frequency option makes it possible to drive all R&S®NRPC calibration kits.

²⁾ The high output power and ultra high output power options are necessary only for calibration of the linearity with R&S®NRPC-LS. It is recommended to select this option.

³⁾ For options installed, the remaining base unit warranty applies if longer than 1 year. Exception: all batteries have a 1 year warranty.

Service at Rohde & Schwarz You're in great hands

- ▶ Worldwide
- ▶ Local and personalized
- ▶ Customized and flexible
- ▶ Uncompromising quality
- ▶ Long-term dependability

Rohde & Schwarz

The Rohde&Schwarz technology group is among the trailblazers when it comes to paving the way for a safer and connected world with its leading solutions in test & measurement, technology systems and networks & cybersecurity. Founded 90 years ago, the group is a reliable partner for industry and government customers around the globe. The independent company is headquartered in Munich, Germany and has an extensive sales and service network with locations in more than 70 countries.

www.rohde-schwarz.com

Sustainable product design

- ▶ Environmental compatibility and eco-footprint
- ▶ Energy efficiency and low emissions
- ▶ Longevity and optimized total cost of ownership

Certified Quality Management

ISO 9001

Certified Environmental Management

ISO 14001

Rohde & Schwarz training

www.training.rohde-schwarz.com

Rohde & Schwarz customer support

www.rohde-schwarz.com/support

