

# ROHDE & SCHWARZ

## GNSS solutions

Rohde & Schwarz GmbH & Co. KG ([www.rohde-schwarz.com](http://www.rohde-schwarz.com))

Rohde & Schwarz customer support ([www.rohde-schwarz.com/support](http://www.rohde-schwarz.com/support)) Rohde & Schwarz training ([www.training.rohde-schwarz.com](http://www.training.rohde-schwarz.com))

R&S® is a registered trademark of Rohde & Schwarz GmbH & Co. KG | PD 5216.1740.32 | Version 02.01 | June 2020 (skw)

Trade names are trademarks of the owners | Rohde & Schwarz GNSS solutions | Data without tolerance limits is not binding

Subject to change | © 2020 Rohde & Schwarz GmbH & Co. KG | 81671 Munich, Germany



# OVERVIEW

## GNSS signal plan

### GPS signal plan

Service name	C/A	P(Y)	L1C	L2C	M-code	L5I L5Q
Frequency band	L1	L1 L2	L1	L2	L1 L2	L5
Center frequency in MHz	1575.42	1575.42 1227.6	1575.42	1227.6	1575.42 1227.6	1176.45
Modulation	BPSK(1)	BPSK(10)	TMBOC (6,1,1/11)	BPSK	BOC	QPSK

### Galileo signal plan

Service name	E1 OS	PRS	E5a OS E5b OS	E6 CS
Frequency band	E1	E1 E6	E5	E6
Center frequency in MHz	1575.42	1575.42 1278.75	1176.45 1207.14	1278.75
Modulation	CBOC(6,1,1/11)	BOC(15,2.5) BOC(10,5)	AltBOC(15,10)	BPSK(5)

### GLONASS signal plan

Service name	C/A	P	G3I G3Q
Frequency band	G1 G2	G1 G2	G3
Center frequency in MHz	1602 ± k·0.5625 1246 ± k·0.4375 k ∈ [-7,6], (FDMA)	1602 ± k·0.5625 1246 ± k·0.4375 k ∈ [-7,6], (FDMA)	1202.025 (CDMA)
Modulation	BPSK(0.5)	BPSK(5)	QPSK(10)

### BeiDou signal plan

Service name	B1I (OS) B1Q (AS)	B1C (OS)	B2I (OS) B2Q (AS)	B2a (OS)	B3I B3Q
Frequency band	B1	B1	B2	B2	B3
Center frequency in MHz	1561.098	1575.42	1207.14	1176.45	1268.52
Modulation	QPSK	BOC	BPSK	BPSK	QPSK

### Power spectral density of key GNSS signals

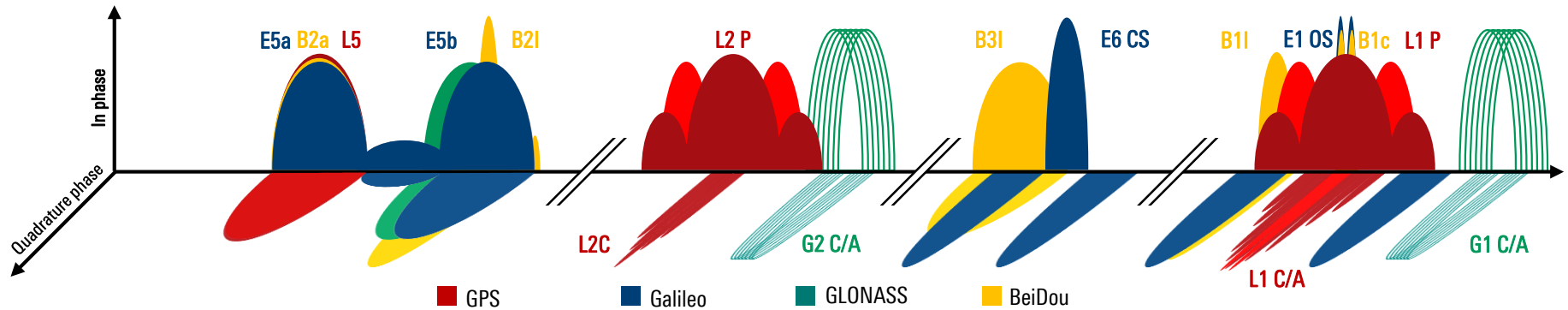

# OVERVIEW

## GNSS signal modulation

Signal modulation for GPS/Galileo/BeiDou/GLONASS G3

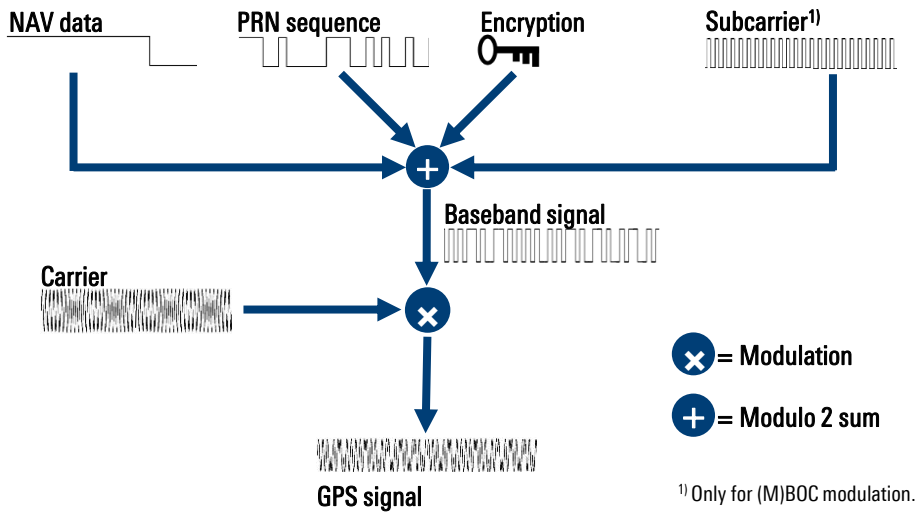

Signal modulation for GLONASS G1/G2

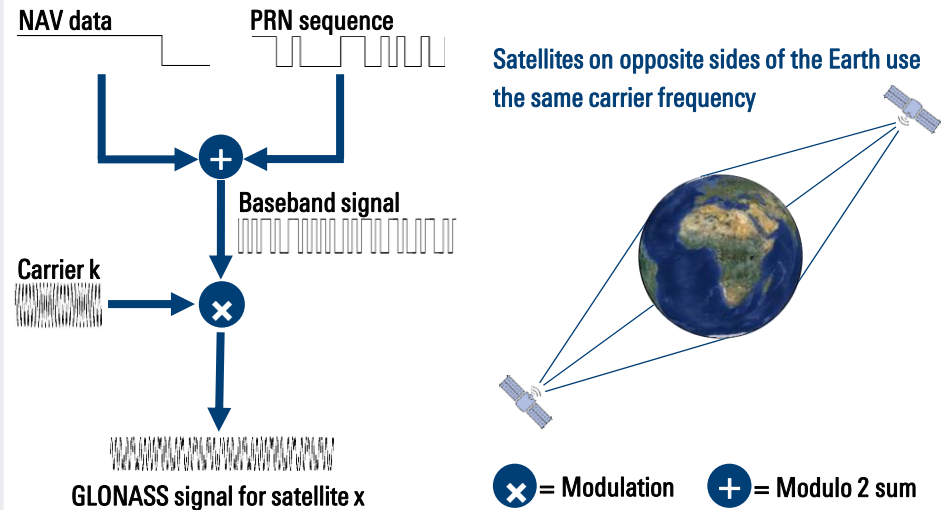

# GNSS SIGNALS

## GPS

### Facts and figures

- ▶ Operated by the United States government
- ▶ First launch in 1978
- ▶ Provides free standard positioning service (SPS) and precision positioning service (PPS) for authorized users
- ▶ 24 (plus three spare) baseline satellites; currently > 30 operational SVs
- ▶ Six orbital planes with an inclination of 55°
- ▶ Orbital altitude: ~20 200 km
- ▶ Orbital period: 11 h 58 min (half a sidereal day)
- ▶ Ground track repetition period: 23 h 56 min (one sidereal day)

### GPS simulation with the R&S®SMBV100B

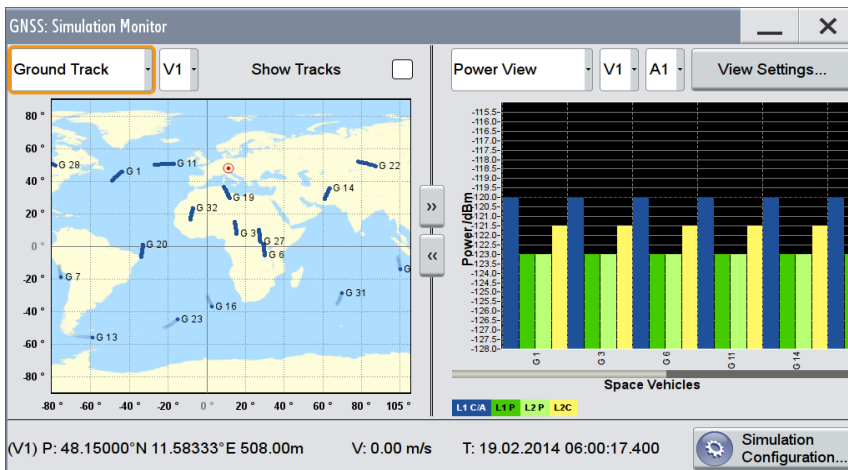

Combined C/A, P and L2C simulation performed by the R&S®SMBV100B

### GPS signal plan

Service name	C/A	P(Y)	L1C	L2CM L2CL	M-code	L5I L5Q
Frequency band	L1	L1 L2	L1	L2	L1 L2	L5
Center frequency in MHz	1575.42	1575.42 1227.6	1575.42	1227.6	1575.42 1227.6	1176.45
Modulation	BPSK(1)	BPSK(10)	TMBOC (6,1,1/11)	BPSK(1)	BOC(10,5)	QPSK(10)
Access technique	CDMA	CDMA	CDMA	CDMA	CDMA	CDMA
Code frequency in MHz	1.023	10.23	1.023	0.5115 0.5115	5.115	10.23
PRN code length	1023	6.19·10 <sup>19</sup>	10230	10230 767250	-	10230
Data rate in bps	50	50	50	50	-	50

### GPS spectrum

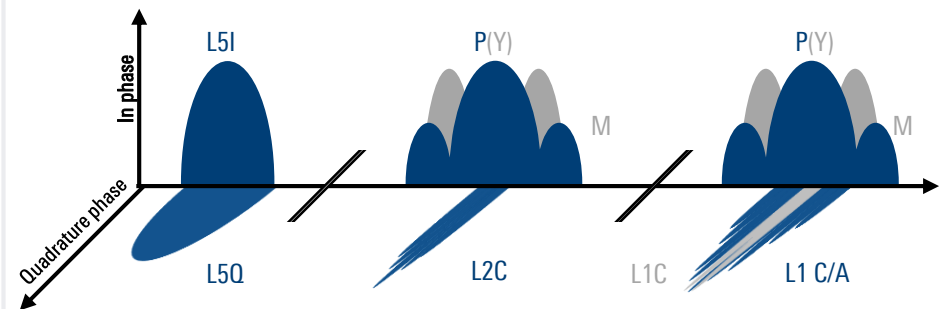

# GNSS SIGNALS

## GLONASS

### Facts and figures

- ▶ Operated by the Russian government
- ▶ First launch in 1982
- ▶ Provides free standard positioning service (ST) and precision positioning service (VT) for authorized users
- ▶ 24 baseline satellites; currently 24 operational SVs
- ▶ Three orbital planes with an inclination of 64.8°
- ▶ Orbital altitude: ~19 150 km
- ▶ Orbital period: 11 h 16 min
- ▶ Ground track repetition period: eight sidereal days

### GLONASS simulation with the R&S®SMBV100B

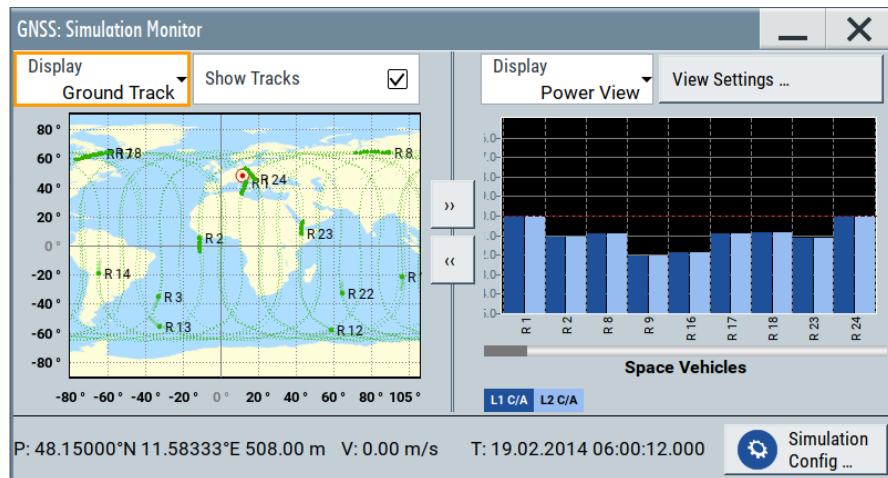

Combined G1 C/A and G2 C/A simulation performed by the R&S®SMBV100B

### GLONASS signal plan

Service name	C/A	P	G3I G3Q
Frequency band	G1 G2	G1 G2	G3
Center frequency in MHz	1602 ± k·0.5625 1246 ± k·0.4375 k ∈ [-7,6]	1602 ± k·0.5625 1246 ± k·0.4375 k ∈ [-7,6]	1202.025
Modulation	BPSK(0.5)	BPSK(5)	QPSK(10)
Access technique	FDMA	FDMA	CDMA
Code frequency in MHz	0.511	5.11	1.023
PRN code length	511	5.11·10 <sup>6</sup>	10230
Data rate in bps	50	50	100

### GLONASS spectrum

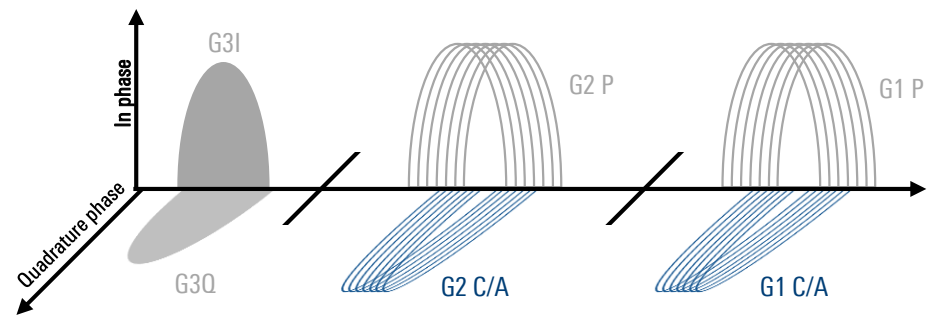

# GNSS SIGNALS

## Galileo

### Facts and figures

- ▶ Joint initiative of the European Commission (EC), the European GNSS Agency (GSA) and the European Space Agency (ESA)
- ▶ First launch in 2011
- ▶ Provides open service (OS), public regulated service (PRS) for authorized users, commercial service (CS) and search and rescue service (SAR)
- ▶ 27 (plus three spare) baseline satellites; currently 22 operational SVs
- ▶ Three orbital planes with an inclination of 56°
- ▶ Orbital altitude: ~23 222 km
- ▶ Orbital period: ~14 h
- ▶ Ground track repetition period: 10 sidereal days

### Galileo simulation with the R&S®SMBV100B

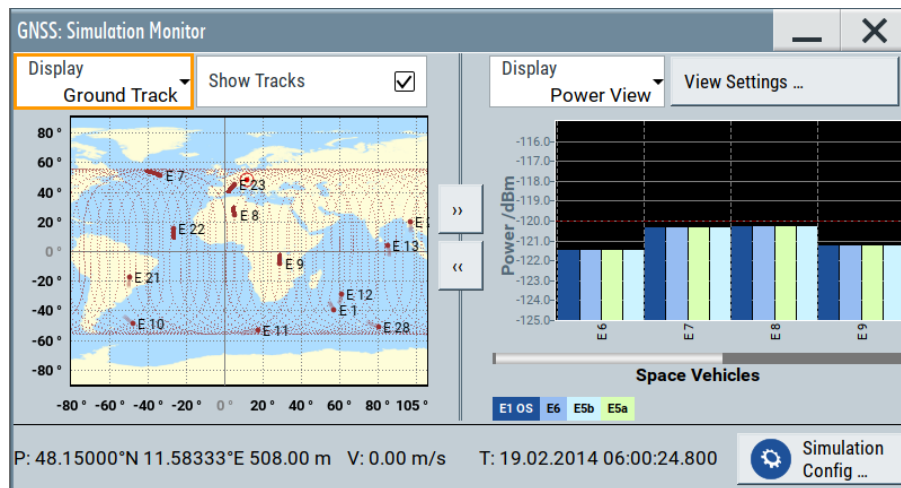

Combined E1 OS, E6, E5a and E5b simulation performed by the R&S®SMBV100B

### Galileo signal plan

Service name	E1 OS	PRS	E5a OS E5b OS	E6 CS
Frequency band	E1	E1 E6	E5	E6
Center frequency in MHz	1575.42	1575.42 1278.75	1176.45 1207.14	1278.75
Modulation	CBOC(6,1,1/11)	BOC(15,2.5) BOC(10,5)	AltBOC(15,10)	BPSK(5)
Access technique	CDMA	CDMA	CDMA	CDMA
Subcarrier frequency in MHz	6.138, 1.023	15.345 10.23	15.345	–
Code frequency in MHz	1.023	2.5575 5.115	10.23	5.115
Primary PRN code length	4092	–	10230	5115

### Galileo spectrum

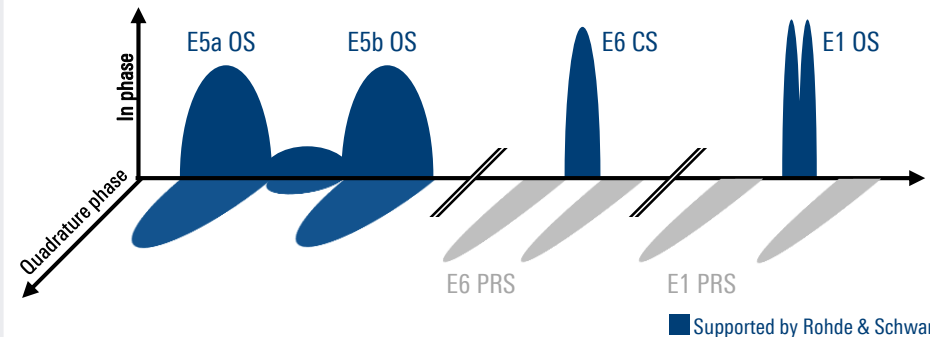

# GNSS SIGNALS

## BeiDou

### Facts and figures

- ▶ Chinese GNSS, managed by the China Satellite Navigation Project Center (CSNPC)
- ▶ First launch in 2000
- ▶ Provides free open service (OS) and authorized service (AS)
- ▶ 30 baseline satellites (BeiDou-III); currently 29 operational SVs
- ▶ 24 MEO, 3 IGSO, 3 GEO satellites (BeiDou-III)
- ▶ MEO satellites:
  - Three orbital planes with an inclination of 55°
  - Orbital altitude: ~21 500 km
  - Orbital period: ~13h
  - Ground track repetition period: seven sidereal days

### BeiDou simulation with the R&S®SMBV100B

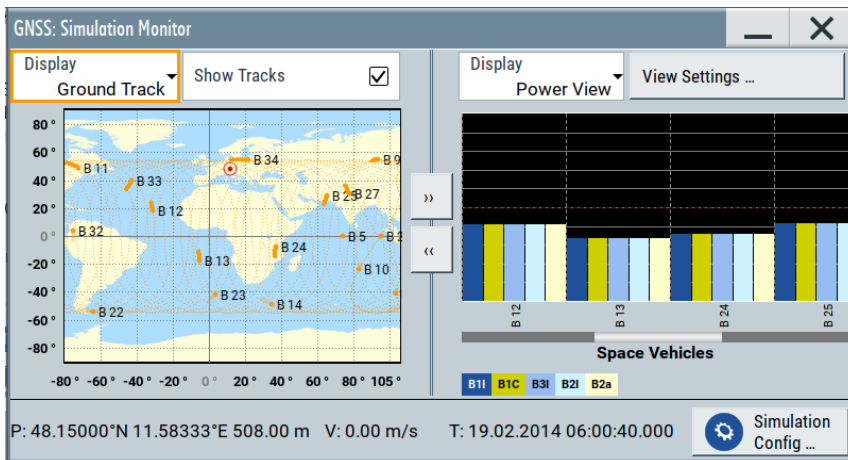

Combined B11, B1C, B21, B2a and B31 simulation performed by the R&S®SMBV100B

### BeiDou signal plan

Service name	B11 (OS) B1Q (AS)	B1C (OS)	B21 (OS) B2Q (AS)	B2a (OS)	B31 (OS) B3Q (AS)
Frequency band	B1	B1	B2	B2	B3
Center frequency in MHz	1561.098	1575.42	1207.14	1176.45	1268.52
Modulation	BPSK(2)	BOC(1,1) QMBOC(6,1,4/33)	BPSK(2) BPSK(10)	BPSK(10)	BPSK(10)
Access technique	CDMA	CDMA	CDMA	CDMA	CDMA
Code frequency in MHz	2.046 10.23	1.023	2.046 10.23	10.23	10.23
Primary PRN code length	2046 -	10230	2046 -	10230	10230
Data rate in bps	500	100	500	200	500

### BeiDou spectrum

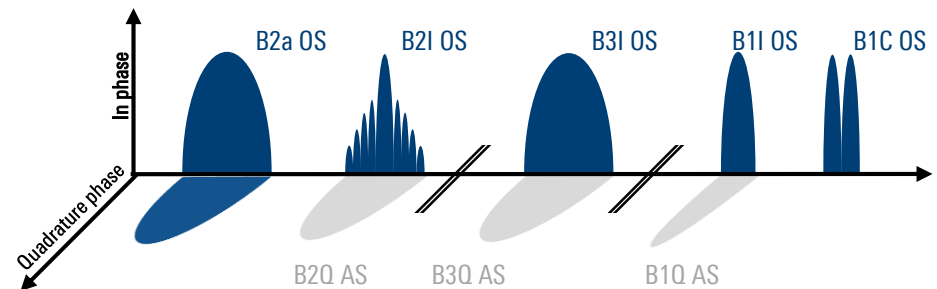

# ROHDE & SCHWARZ SOLUTIONS

## GNSS signal generation

### Your challenges

- ▶ GNSS technology is found in a wide variety of applications from car navigation systems and geodetic T&M equipment to fitness trackers
- ▶ The performance of each newly developed GNSS receiver has to be tested before it is brought to market
- ▶ Controlled and realistic conditions are a prerequisite for conclusive test results
- ▶ GNSS receivers cannot be tested in a real-world environment since this is time consuming, costly and almost impossible to reproduce
- ▶ The structure of GNSS signals is complex and therefore difficult to create manually

### Our solutions

- ▶ Use the R&S®SMBV100B or the R&S®SMW200A to simulate complex satellite constellations in real time and with unlimited simulation time
- ▶ Perform tests in the lab under controlled and repeatable conditions using a Rohde & Schwarz GNSS simulator
- ▶ Perform production tests with the R&S®SMBV100B equipped with the production tester option or precomputed waveforms from R&S®WinIQSIM2™
- ▶ Generate signals for all available GNSS systems:
  - GPS (L1/L2 C/A and P, L2C, L5)
  - GLONASS (G1/G2 C/A)
  - Galileo (E1, E6, E5a, E5b)
  - BeiDou (B1I, B1C, B2I, B2a, B3I)

### Rohde & Schwarz solutions for GNSS signal generation

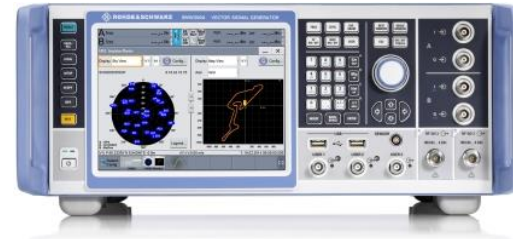

- ▶ High-end GNSS constellation simulator for sophisticated multiconstellation, multifrequency, multi-antenna and multi-vehicle testing (R&S®SMW200A)
- ▶ GNSS constellation simulator for single-frequency receiver characterization (R&S®SMBV100B)
- ▶ GNSS production tester option for R&S®SMBV100B
- ▶ GNSS waveforms for basic receiver testing (R&S®WinIQSIM2™)



# OVERVIEW

## Augmentation signal generation

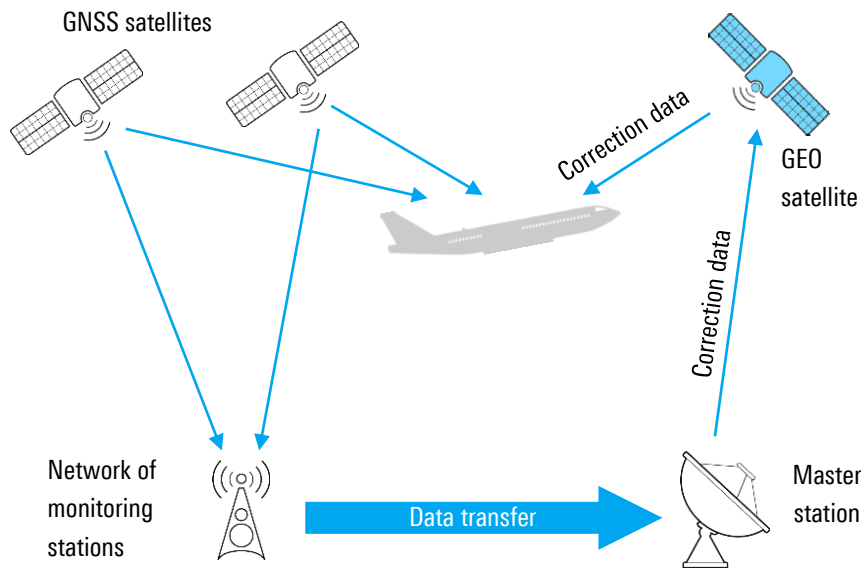

### Principle of SBAS/QZSS

- ▶ Monitoring station at an accurately surveyed position receives GNSS signals and estimates the position; the results are forwarded to the master station
- ▶ At the master station, error correction data is calculated from the mismatch between the GNSS position and the actual position of the monitoring station
- ▶ Augmentation data, including integrity information about the health status of the GNSS satellites, is transmitted to geostationary (GEO) satellites and provided to the user on L1
- ▶ The GNSS's estimated position can be corrected for the GNSS's satellite orbit and clock errors as well as ionospheric disturbances at the receiver
- ▶ No corrections of local effects such as tropospheric effects and inherent multipath and receiver errors

### Satellite based augmentation systems (SBAS)

#### Implementations



**Europe:** European Geostationary Navigation Overlay Service (EGNOS)



**North America:** Wide Area Augmentation System (WAAS)



**Japan:** MTSAT Satellite Augmentation System (MSAS)



**India:** GPS Aided Geo Augmented Navigation system (GAGAN)

#### Benefits and features

Your benefit	Features
Differential correction	Correction for GNSS satellite orbit/clock errors and ionospheric disturbances
GEO ranging (WAAS only)	Additional GPS-like signals from GEO satellites to increase the number of navigation satellites available to users
Integrity service	Information about the quality of the navigation service, including timely warnings in case system performance becomes unreliable

#### Typical applications

- ▶ Civil aviation
- ▶ Precision farming



# OVERVIEW

## SBAS systems

### Wide Area Augmentation System (WAAS)

WAAS augments the GPS standard positioning service (SPS) in the United States and Canada. It was first introduced in 2003 and is currently deployed on three GEO satellites. It provides increased accuracy and integrity monitoring as well as additional ranging signals. The development was mainly driven by civil aviation. WAAS is certified for localizer performance with vertical guidance (LPV) approaches.

**Features**

- ▶ Differential correction
- ▶ Integrity service
- ▶ GEO ranging



### European Geostationary Navigation Overlay Service (EGNOS)

EGNOS augments the GPS standard positioning service in the L1 band in Europe. It became operational in 2011 and is currently deployed on two GEO satellites. It increases availability and accuracy in position reporting and enables integrity monitoring of GPS satellites. Future versions will also broadcast correction data for the L5 band. EGNOS is certified for localizer performance with vertical guidance approaches.

**Features**

- ▶ Differential correction
- ▶ Integrity service



### GPS Aided Geo Augmented Navigation system (GAGAN)

GAGAN augments the GPS standard positioning service in India. It became operational in 2013 and is deployed on three GEO satellites. It increases availability and accuracy in position reporting and enables integrity monitoring of GPS satellites. GAGAN will eventually be supplemented by the IRNSS regional navigation system. As of 2015, GAGAN is certified for approach with vertical guidance (APV-I).

**Features**

- ▶ Differential correction
- ▶ Integrity service



### MTSAT Satellite Augmentation System (MSAS)

MSAS augments the GPS standard positioning service around Japan. It became operational in 2007 and is deployed on two GEO satellites. It increases availability and accuracy in position reporting and enables integrity monitoring of GPS satellites. It is supplemented by the QZSS regional navigation system. As of 2007, MSAS is certified for lateral navigation (LNAV), with certification for localizer performance with vertical guidance approaches planned at a later date.

**Features**

- ▶ Differential correction
- ▶ Integrity service



# OVERVIEW

## Availability and performance

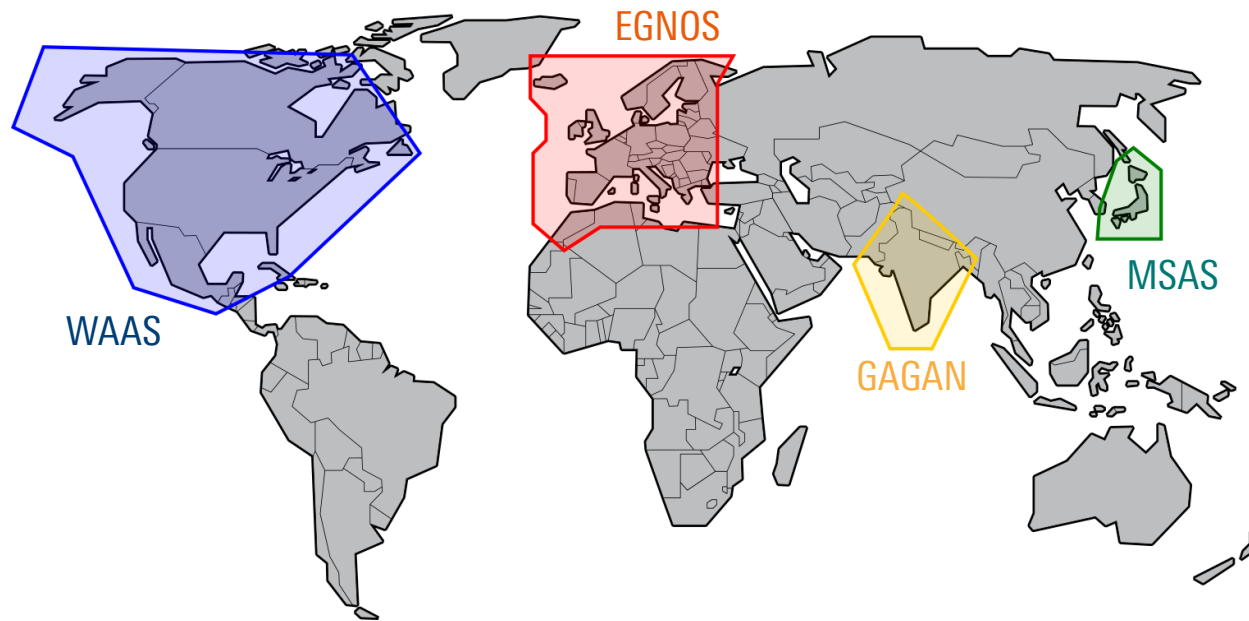

SBAS accuracy						
Accuracy	APV-I requirements	LPV200 requirements	WAAS actual performance <sup>1)</sup>	EGNOS actual performance <sup>1)</sup>	GAGAN actual performance <sup>2)</sup>	MSAS actual performance <sup>1)</sup>
Horizontal error	16 m	16 m	< 1.1 m	< 1.3 m	0.7 m	< 1.0 m
Vertical error	20 m	4 m	< 1.6 m	< 2.4 m	1.52 m	< 1.6 m

<sup>1)</sup> 95th percentile.

<sup>2)</sup> Average.



# OVERVIEW

## QZSS

### Quasi-Zenith Satellite System (QZSS)

#### Overview

- ▶ Covers East Asia and the Oceania region
- ▶ Augmentation and complementary system to GPS
- ▶ One geostationary and three geosynchronous satellites
- ▶ Outlook: extension to a standalone regional navigation satellite system (RNSS) with seven satellites is being carried out



### QZSS signal plan

Service name	C/A	L1C <sup>1)</sup>	SAIF <sup>1)</sup>	L2CM, L2CL <sup>1)</sup>	L5I, L5Q <sup>1)</sup>	LEX <sup>1)</sup>
Frequency band	L1	L1	L1	L2	L5	E6
Center frequency in MHz	1575.42	1575.42	1575.42	1227.6	1176.45	1278.75
Modulation	BPSK(1)	BOC(1,1)	BPSK(1)	BPSK(1)	BPSK(10)	BPSK(5)

<sup>1)</sup> Not supported by Rohde & Schwarz instruments.

### SBAS/QZSS simulation with the R&S®SMW200A

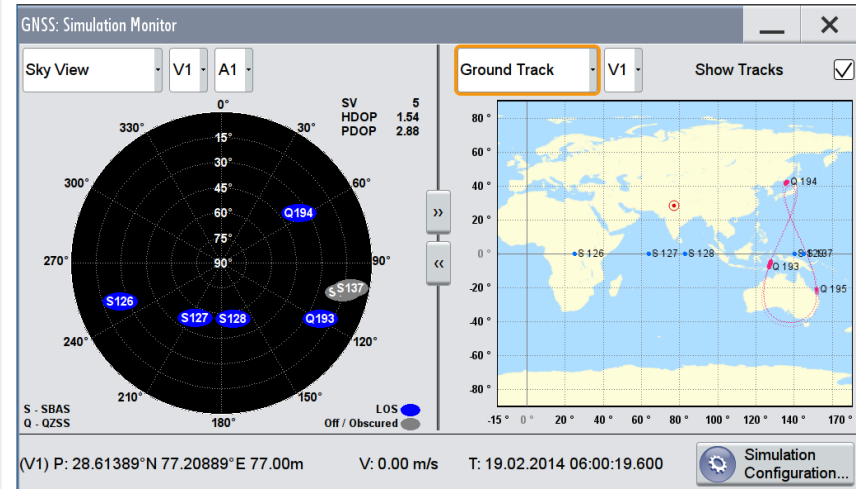

Combined SBAS/QZSS simulation performed by the R&S®SMW200A

# ROHDE & SCHWARZ SOLUTIONS

## SBAS signal generation

### Your challenges

- ▶ The SBAS capabilities of each newly developed GNSS receiver have to be tested carefully
- ▶ Full characterization of a receiver includes evaluating its ability to decode and apply correction data from SBAS signals
- ▶ Testing the GNSS device's response to integrity information and alerts provided by SBAS is also part of the evaluation process
- ▶ Controlled and realistic conditions – considering satellite orbit and clock errors as well as ionospheric disturbances – are a prerequisite for conclusive test results
- ▶ Tests cannot be performed in a real-world environment since this is time consuming, costly and impossible to reproduce
- ▶ Augmentation signals have a complex structure and are difficult to create manually

### Our solutions

- ▶ Use the GNSS simulator in the R&S®SMBV100B or the R&S®SMW200A to simulate complex GPS/SBAS/QZSS scenarios in real time and with unlimited simulation time
- ▶ Perform tests in the lab under controlled and repeatable conditions using simulated SBAS/QZSS signals
- ▶ Apply accurate models of satellite orbit and clock errors as well as ionospheric disturbances for realistic SBAS scenarios
- ▶ Generate signals for the following augmentation systems:  
EGNOS (C/A), WAAS (C/A), MSAS (C/A), GAGAN (C/A), QZSS (C/A)

### Rohde & Schwarz solutions for GNSS signal generation

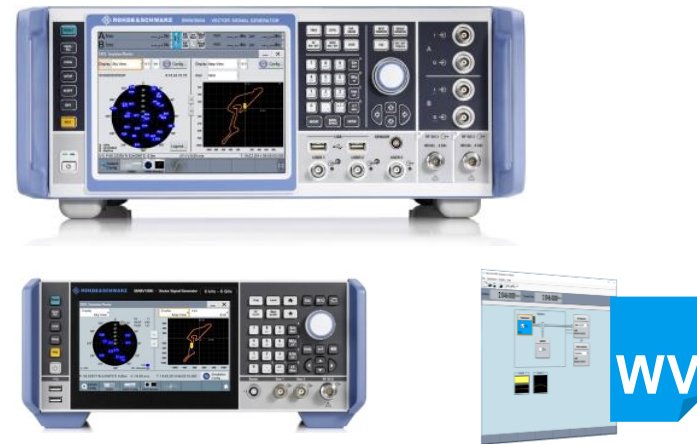

- ▶ High-end GNSS constellation simulator for sophisticated multiconstellation, multifrequency, multi-antenna and multi-vehicle testing (R&S®SMW200A)
- ▶ GNSS constellation simulator for single-frequency receiver characterization (R&S®SMBV100B)
- ▶ GNSS production tester option for R&S®SMBV100B
- ▶ GNSS waveforms for basic receiver testing (R&S®WinIQSIM2™)

# GNSS PERFORMANCE TESTING FOR eCall AND ERA-GLONASS MODULES

## Basic architecture of an automatic emergency call system

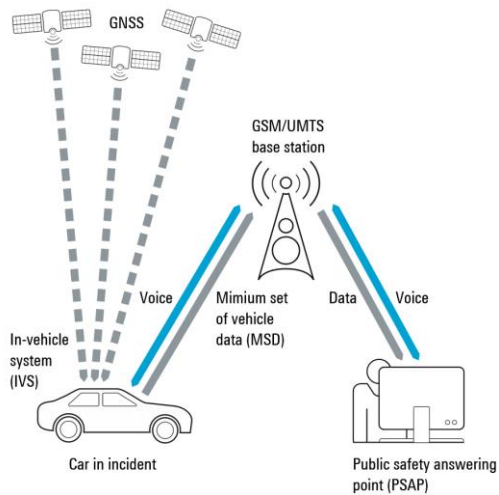

Your benefit	Features
Tests are 100 % reproducible	The GNSS simulator in the <b>R&amp;S®SMBV100B</b> and <b>R&amp;S®SMW200A</b> ensures that scenarios are fully reproducible, which makes the solution ideal for validation measurements prior to official certification tests
Tests are fully automated	The <b>R&amp;S®SMBVB-K360/K361</b> / <b>R&amp;S®SMW-K360/K361</b> in combination with the R&S®CMWrun sequencer software automatically configures the signal generator; no manual instrument configuration is required
Efficiently plan, execute and evaluate validation and certification tests	The test solution features <b>R&amp;S®CMWrun</b> for automatic test configuration, scheduling, DUT configuration, data analysis and test report generation



For more information, visit [www.rohde-schwarz.com/catalog/smbv100a](http://www.rohde-schwarz.com/catalog/smbv100a)

## Test challenges

- ▶ All newly registered cars, trucks and buses in Russia and the Eurasian Customs Union must be equipped with the ERA-GLONASS automatic emergency call system
- ▶ Effective April 1, 2018, newly registered cars and vans in the European Union must be equipped with the automatic emergency call system eCall
- ▶ Each ERA-GLONASS/eCall module has to undergo a certification process before being used in a car; this process comprises a series of conformance and performance tests
- ▶ The performance of the built-in GNSS receivers has to be tested against the GOST-R-55534/33471 standards (ERA-GLONASS) or against the EU regulation EU2017/76, Annex VI (eCall)
- ▶ Tests cannot be performed in a real-world environment since this is difficult to implement, time consuming, costly and almost impossible to reproduce

## Test solutions

- ▶ Perform tests in the lab under controlled and repeatable conditions using the GNSS simulator in the R&S®SMBV100B
- ▶ Install the R&S®SMBVB-K360/K361 and turn the R&S®SMBV100B into a fully automated ERA-GLONASS/eCall performance tester
- ▶ Schedule, configure and analyze your tests using the R&S®CMWrun sequencer software
- ▶ Required GNSS performance tests include:
  - Tracking sensitivity
  - Acquisition sensitivity
  - Time to first fix (TTFF)
  - Location accuracy



# AUTOMATED TESTS WITH R&S®CMWrun AND R&S®SMBVB-K360/K361

## Test setup for automated GNSS performance tests

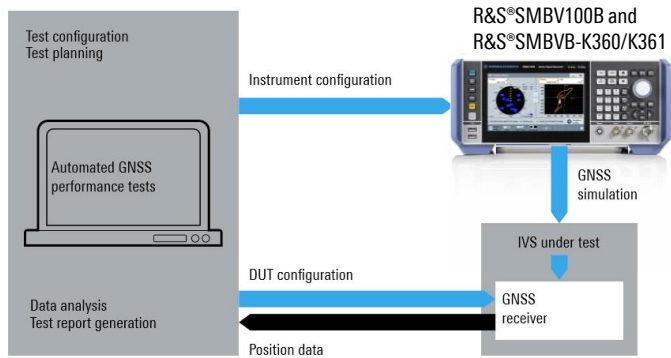

## GNSS simulation with the R&S®SMBV100B

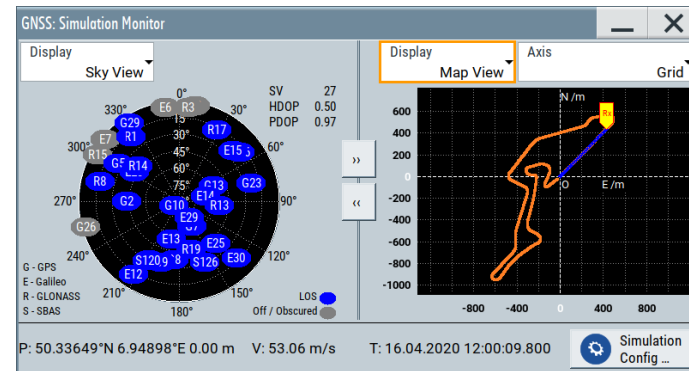

Combined GPS/GLONASS/  
Galileo/SBAS simulation  
performed by the  
R&S®SMBV100B

## Instrument configuration for automated ERA-GLONASS tests

Minimum hardware configuration		
R&S®SMBV100B R&S®SMW200A	Vector signal generator	
R&S®SMBVB-/R&S®SMW-B103	Frequency up to 3 GHz	
R&S®SMBVB-K520 or R&S®SMW-B9/B10 R&S®SMW-B13XT/B13	Baseband real-time extension Baseband generator Baseband main module	
Minimum software configuration		
R&S®SMBVB-/R&S®SMW-K44	GPS	Required for TC 5.1, 5.2, 5.3, 5.4, 5.5, 5.6, 5.7, 5.8 (location accuracy without obstructed signals), 5.9, 5.10, 5.11, 5.12, 5.13, 5.14, 5.15
R&S®SMBVB-/R&S®SMW-K94	GLONASS	
R&S®SMBVB-K137 <sup>1)</sup>	Add 12 channels	
To add for full test coverage		Test cases in line with GOST-R-55534/33471
R&S®SMBVB-/R&S®SMW-K108	Real-world scenarios	Required for TC 5.8 (location accuracy with obstructed signals)
Test automation		
R&S®SMBVB-/R&S®SMW-K360	ERA-GLONASS test suite	+ R&S®CMWrun to be installed on a control PC

<sup>1)</sup> Options K136, K137 only required for R&S®SMBV100B.

## Instrument configuration for automated eCall tests

Minimum hardware configuration		
R&S®SMBV100B R&S®SMW200A	Vector signal generator	
R&S®SMBVB-/R&S®SMW-B103	Frequency up to 3 GHz	
R&S®SMBVB-K520 or R&S®SMW-B9/B10 R&S®SMW-B13XT/B13	Baseband real-time extension Baseband generator Baseband main module	
Minimum software configuration		
R&S®SMBVB-/R&S®SMW-K44	GPS	
R&S®SMBVB-/R&S®SMW-K66	Galileo	Required for TC 2.1, 2.2, 2.3, 2.5, 2.6, 2.7
R&S®SMBVB-/R&S®SMW-K106	SBAS/QZSS	
R&S®SMBVB-/R&S®SMW-K137 <sup>1)</sup>	Add 12 channels	
To add for full test coverage		Test cases in line with EU2017/79, Annex VI
R&S®SMBVB-/R&S®SMW-K94	GLONASS	Required to test against the UNECE 2016/07 regulation
R&S®SMBVB-/R&S®SMW-K108	Real-world scenarios	Required for TC 2.4 (location accuracy with obstructed signals)
R&S®SMBVB-K136 <sup>1)</sup>	Add 6 channels	
Test automation		
R&S®SMBVB-/R&S®SMW-K361	eCall test suite	+ R&S®CMWrun to be installed on a control PC