

R&S® ESSENTIALS

CATALOG 2024/2025 TEST & MEASUREMENT



R&S® ESSENTIALS | CATALOG 2024/2025 | TEST & MEASUREMENT | VERSION 13.00

ROHDE & SCHWARZ

Make ideas real



CONTENTS

Chapter	Page
Company profile	3
Our business fields	3
Test equipment for your bench from R&S®ESSENTIALS	4
Explanation of icons	5
Featured products	6
Learn more	6
Oscilloscopes	8
Oscilloscope portfolio	10
Probe portfolio	28
Power supplies	30
Power supply portfolio	32
Signal generators	50
Signal generator portfolio	51
Handheld analyzers	58
Handheld analyzer portfolio	60
Spectrum analyzers	72
Economy spectrum analyzer portfolio	74
Vector network analyzers	82
Vector network analyzer portfolio	84
EMC precompliance	92
Meters and analyzers	96
Power sensors	104
Service at Rohde&Schwarz: You're in great hands.	112
Calibration you can trust	112
Rohde&Schwarz calibration versus third-party calibration	113
Service	114
Contact information	116
Trademarks	117

ONE COMPANY, THREE DIVISIONS, DIVERSE MARKETS

Rohde & Schwarz ensures a safer and connected world. The group's high-tech products and solutions let companies and countries define and maintain their technological and digital sovereignty.

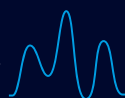

TEST & MEASUREMENT

- ▶ Wireless Communications
- ▶ Industry, Components & Research
- ▶ Aerospace & Defense Testing
- ▶ Automotive



TECHNOLOGY SYSTEMS

- ▶ Secure Communications
- ▶ Critical Infrastructure & Networks
- ▶ Government
- ▶ IP Network Analytics
- ▶ Broadcast, Amplifiers & Media



NETWORKS & CYBERSECURITY

- ▶ Endpoint Security
- ▶ Secure Networks
- ▶ Certified & High-Grade Crypto Solutions

TEST EQUIPMENT FOR YOUR BENCH FROM R&S®ESSENTIALS

Do you know what separates average test equipment from superior? We can sum it up in just one word: **Easy.** R&S®ESSENTIALS test instruments are easy to configure, easy to purchase and easy to use.

Configuring and purchasing these comprehensive and affordable test instruments has never been easier. With the help of the online configurator, you can put together the exact product you need for your test setup, including options and accessories.

For the constantly growing R&S®ESSENTIALS portfolio, Rohde & Schwarz is extending its reach through a global network of distributors. With their help, Rohde & Schwarz can simplify the purchasing experience for customers. You can pick the test instrument distributor when submitting your quote request. Rohde & Schwarz will take care of passing your request on for you to make sure that your application needs and test equipment budget are met. Our global network of authorized distribution partners enables quick and easy purchase of test equipment online. Benefit from 24 h delivery, flexible payment options and other services of our distribution partners that enable simple access to test equipment.

Curious to get some practical tips from experts on specific measurements, learn more about the use of our test equipment in various application scenarios or receive guidance in choosing one of the R&S®ESSENTIALS test instruments? Visit our website now to get started.



EXPLANATION OF ICONS

In this catalog, the instrument interfaces are represented by icons on the first page (bottom left) of each product description. These icons are explained below.

Icon	Explanation
Remote control	
	USB The instrument can be connected to a PC via universal serial bus (USB) using a USB cable with a standard B type plug.
	Mini USB The instrument can be connected to a PC via universal serial bus (USB) using a USB cable with a mini-B type plug.
	Micro USB The instrument can be connected to a PC via universal serial bus (micro USB) using a micro USB cable.
	RS-232 The instrument is equipped with an RS-232 interface.
	TCP/IP The instrument is equipped with an Ethernet interface that can be connected to a local area network (LAN).
	IEEE-488 The instrument is equipped with an IEEE-488 interface, also referred to as general purpose interface bus (GPIB). This bus is widely used for controlling instruments in laboratories.
	WLAN The instrument can be remote controlled via a wireless local area network (WLAN).
Storage	
	USB flash drive The instrument is equipped with a universal serial bus (USB) upstream interface that can be used to connect a USB flash drive or other USB mass storage devices with a standard A type plug.
	Removable hard disk The instrument comes with a removable hard disk, e.g. for saving measurement results.
	SD card An SD card can be inserted, e.g. for saving measurement results.
	Micro SD card A micro SD card can be inserted, e.g. for saving measurement results.
Compatibility	
	LabVIEW The instrument can be controlled using the LabVIEW software from National Instruments.
Display	
	Screen Settings, results, etc. are shown on the integrated display (3.5" to 12.1").
	Touchscreen The user can control the instrument by touching the screen with a special pen and/or one or more fingers.
Miscellaneous	
	DVI output An external monitor can be connected via a digital visual interface (DVI).
	VGA output The instrument can be connected to a PC via the video graphics array (VGA) interface.
	Kensington The instrument can be locked with the Kensington lock.
	50 Ω/1 MΩ The input impedance of the instrument can be switched between 50 Ω and 1 MΩ.
	

FEATURED PRODUCTS



MXO 5 series oscilloscope

The MXO 5 series delivers breakthrough oscilloscope technology to speed up understanding and testing of electronic systems. The specifications for both the four-channel and eight-channel models make the MXO 5 series the industry leader in cutting-edge technology for swift and precise results. The advanced customized oscilloscope technology and revolutionary features are indispensable for insight into circuit behavior.

► [page 22](#)

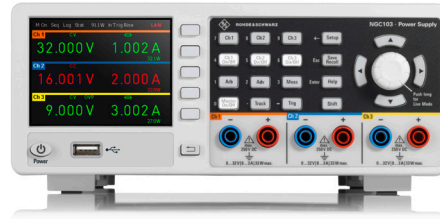

R&S®NGC power supply series

R&S®NGC100 power supply series are very energy efficient, remain cool and quiet, even at maximum load. One, two, or three channels – a wide range of functions and fundamental specifications make the R&S®NGC100 power supply series ideal for development labs, industrial environments, manufacturing and education.

► [page 38](#)



R&S®SMCV100B vector signal generator

The R&S®SMCV100B vector signal generator is the first multistandard platform for automotive, broadcast, navigation and wireless applications. This makes the R&S®SMCV100B unique for use in many applications, from the lab to production and wherever different technologies meet.

► [page 56](#)

LEARN MORE

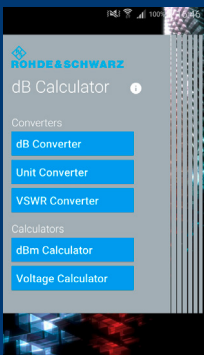

dB or not dB?

True or false: $30 \text{ dBm} + 30 \text{ dBm} = 60 \text{ dBm}$?

Why does 1% work out to be -40 dB one time, but 0.1 dB or 0.05 dB the next time? Sometimes even experienced engineers have trouble answering these questions. Decibels are found everywhere – in power levels, voltages, reflection coefficients, noise figures, field strengths and more. What is a decibel and how should we use it in our calculations? This application note provides a refresher on the subject of decibels.

► www.rohde-schwarz.com/appnote/1MA98

Get the highly rated calculator app for your everyday dB calculations now. Available on all platforms.



dB Calculator for Android



dB Calculator for iOS



dB Calculator for Windows Phone



R&S®NPA power analyzers

The compact testers of the R&S®NPA family enable DC load, AC load and standby current characterization without PC software or remote infrastructure. In addition to a numerical and graphical display with 26 key parameters, the instrument delivers performance and compliance protocols in line with IEC 62301, EN 50564 and EN 61000-3-2

▶ [page 100](#)



R&S®FPL1000 signal and spectrum analyzer

The R&S®FPL1000 is a single measuring instrument for a variety of measurement tasks. It supports spectrum analysis, highly accurate power measurement with power sensors and analysis of analog and digitally modulated signals.

▶ [page 80](#)



R&S®ZNL vector network analyzer

The R&S®ZNL helps reduce investment costs with a unique option concept. The base models support frequencies from 5 kHz up to 20 GHz, and the models up to 6 GHz can be extended with a fully integrated spectrum analyzer and support RF power meters. Furthermore, the spectrum analysis supports a CW signal generator option.

▶ [page 86](#)



RF & Bench Essentials Reference Guide

This guide includes a wide range of time-domain and RF test equipment. It covers most of the tools users want to understand in more detail.

This reference guide can also be a gateway to dig into some of the details contained in a more in-depth fundamental or primer guide on specific measuring instruments.

▶ www.rohde-schwarz.com/rf-essentials

Want to know the latest news from Rohde & Schwarz? Find us at



[linkedin.com/company/rohde-&-schwarz](https://www.linkedin.com/company/rohde-&-schwarz)



twitter.com/RohdeSchwarz



[youtube.com/user/RohdeundSchwarz](https://www.youtube.com/user/RohdeundSchwarz)



[facebook.com/RohdeAndSchwarz](https://www.facebook.com/RohdeAndSchwarz)

OSCILLOSCOPES

The Rohde & Schwarz oscilloscope portfolio offers options ranging from low-cost yet powerful 50 MHz oscilloscopes to full-featured 16 GHz oscilloscopes. Designed by the RF experts at Rohde & Schwarz, all oscilloscopes feature exceptional signal integrity, high value and excellent reliability.

Use the table on pages 10 and 11 to see the differences between each family.

Bandwidth

Bandwidth selection is typically the most crucial parameter when choosing an oscilloscope. Bandwidth is defined as the frequency at which a sine wave is attenuated by 3 dB or is approx. 30% smaller.

Since most signals are not monotone, you have to take into account the harmonic components that make up the signal. Especially when most signals are more like square waves. Capturing a 1 GHz square wave with a 1 GHz oscilloscope will cause the measured waveform to be distorted.

Rule of thumb: $\text{Bandwidth}_{\text{Oscilloscope}} = 3 \text{ to } 5 \times \text{fundamental clock frequency of the test signal}$

The simplest way to determine how much bandwidth the oscilloscope needs is to take 3 to 5 times the clock frequency of the signal you want to measure. For example, a high-speed USB signal at 480 Mbit/s has a clock frequency of 240 MHz which would require a 720 MHz to 1.2 GHz oscilloscope. Another important consideration is the rise/fall time of the signal edges. Always make sure that the instrument can capture a faster rise/fall time than the measured waveform.

Sample rate and memory depth

Sample rate and memory depth are directly related. The sample rate defines how fast the oscilloscope samples and digitizes the waveform. Those samples have to be stored somewhere, which is why memory is important. The more memory you have, the higher you can keep your sample rate (which allows you to take advantage of the full bandwidth of the oscilloscope).

Rule of thumb: You typically want the sample rate to be 5 times the bandwidth of the oscilloscope to accurately reproduce the signal. For example, for a 1 GHz oscilloscope, you need a sample rate of 5 Gsample/s. There are a few times that you can get by with less (down to 2.5 times), but in general, look for a sample rate at least 5 times the bandwidth.

As mentioned, memory depth is directly related to the sample rate. The more memory depth you have, the longer you can capture at high sample rates.

Rule of thumb: Most engineers will want as much memory as they can get to maximize the amount of time captured at high sample rate.

Vertical resolution

The vertical resolution is the number of vertical levels an oscilloscope ADC can sample waveforms into bins. When the oscilloscope is sampling the waveform, it does not have an infinite number of levels to put the sample in. It has to choose a level to put that sample in. The more levels it has to choose from, the more precise it can be. An 8-bit oscilloscope has 256 quantization levels. A 10-bit oscilloscope has 1024. A 12-bit oscilloscope has 4096. A 16-bit oscilloscope has 65536 levels.

Rule of thumb: In general, additional vertical resolution is most useful where you are trying to see a small signal riding on top of a much larger signal. Without the additional precisions, the small signal would be lost in the larger signal. Higher vertical resolution makes measurements more precise. However, pay attention to the noise performance of the instrument frontend.

Update rate

The update rate, sometimes called dead time or blind time, is how fast the oscilloscope can trigger on a waveform (basically one screen's worth of data), process it and then plot it on the display. The faster it can do this, the more likely you are to see infrequent events. The update rate is specified in waveforms per second or waveforms/s. For example, with an update rate of 50 000 waveforms/s, an oscilloscope captures a waveform every 20 μ s. If the oscilloscope's timebase is set to acquire 100 ns of activity across the screen, the rest of that 20 μ s (20 μ s – 100 ns = 19.9 μ s) is consumed by processing and plotting, which means the oscilloscope is dead for 99.5% of the time. If an infrequent anomaly happens during that dead time, the engineer will never see it.

Rule of thumb: Most engineers will want an update rate as fast as possible, assuming they do not have to trade off something else to get it (e.g. memory depth). If the engineer is just interested in single shot captures (e.g. power supply turn-on or low speed serial decode and trigger), then the update rate is not that important.

Products	Page
R&S®ScopeRider RTH handheld oscilloscope	12
R&S®RTC1000 oscilloscope	14
R&S®RTB2000 oscilloscope	16
R&S®RTM3000 oscilloscope	18
MXO 4 series oscilloscope	20
MXO 5 series oscilloscope	22
MXO 5C series oscilloscope	24
R&S®RTO6 oscilloscope series	26

Oscilloscope portfolio



	R&S®RTH1000	R&S®RTC1000	R&S®RTB2000	R&S®RTM3000
Vertical system				
Bandwidth ¹⁾	60/100/200/350/500 MHz	50/70/100/200/300 MHz	70/100/200/300 MHz	100/200/350/500 MHz/1 GHz
Number of channels	2 plus DMM/4	2	2/4	2/4
Vertical resolution; system architecture	10 bit; 16 bit	8 bit; 16 bit	10 bit; 16 bit	10 bit; 16 bit
V/div, 1 MΩ	2 mV to 100 V	1 mV to 10 V	1 mV to 5 V	500 μV to 10 V
V/div, 50 Ω	–			500 μV to 1 V
Horizontal system				
Sampling rate per channel (in Gsample/s)	1.25 (4-channel model); 2.5 (2-channel model); 5 (all channels interleaved)	1; 2 (2 channels interleaved)	1.25; 2.5 (2 channels interleaved)	2.5; 5 (2 channels interleaved)
Maximum memory (per channel; 1 channel active)	125 kpoints (4-channel model); 250 kpoints (2-channel model); 500 kpoints	1 Mpoints; 2 Mpoints	10 Mpoints; 20 Mpoints	40 Mpoints; 80 Mpoints
Segmented memory	standard, 50 Mpoints	–	option, 320 Mpoints	option, 400 Mpoints
Acquisition rate (in waveforms/s)	50 000	10 000	50 000 (300 000 in fast segmented memory mode ²⁾)	64 000 (2 000 000 in fast segmented memory mode ²⁾)
Trigger				
Types	digital	analog	analog	analog
Sensitivity	–	–	at 1 mV/div: > 2 div	at 1 mV/div: > 2 div
Mixed signal option (MSO)				
Number of digital channels ¹⁾	8	8	16	16
Analysis				
Mask test	tolerance mask	tolerance mask	tolerance mask	tolerance mask
Mathematics	elementary	elementary	basic (math on math)	basic (math on math)
Serial protocols triggering and decoding ¹⁾	I ² C, SPI, UART/RS-232/RS-422/RS-485, CAN, LIN, CAN FD, SENT	I ² C, SPI, UART/RS-232/RS-422/RS-485, CAN, LIN	I ² C, SPI, UART/RS-232/RS-422/RS-485, CAN, LIN	I ² C, SPI, UART/RS-232/RS-422/RS-485, CAN, LIN, I ² S, MIL-STD-1553, ARINC 429
Applications ^{1), 2)}	high-resolution frequency counter, advanced spectrum analysis, harmonics analysis, user scripting	digital voltmeter (DVM), component tester, fast Fourier transform (FFT)	digital voltmeter (DVM), fast Fourier transform (FFT), frequency response analysis	power, digital voltmeter (DVM), spectrum analysis and spectrogram, frequency response analysis
Compliance testing ^{1), 2)}	–	–	–	–
Display and operation				
Size and resolution	7" touchscreen, 800 × 480 pixel	6.5", 640 × 480 pixel	10.1" touchscreen, 1280 × 800 pixel	10.1" touchscreen, 1280 × 800 pixel
General data				
Dimensions in mm (W × H × D)	201 × 293 × 74	285 × 175 × 140	390 × 220 × 152	390 × 220 × 152
Weight in kg	2.4	1.7	2.5	3.3
Battery	lithium-ion, > 4 h	–	–	–

¹⁾ Upgradeable.

²⁾ Requires an option.



MXO 4	MXO 5/MXO 5C	R&S® RT06
200/350/500 MHz/1/1.5 GHz	100/200/350/500 MHz/1/2 GHz	600 MHz/1/2/3/4/6 GHz
4	4/8	4
12 bit; 18 bit	12 bit; 18 bit	8 bit; 16 bit
500 μ V to 10 V	500 μ V to 10 V	1 mV to 10 V (HD mode: 500 μ V to 10 V)
500 μ V to 1 V	500 μ V to 1 V	1 mV to 1 V (HD mode: 500 μ V to 1 V)
2.5; 5 (2 channels interleaved)	5 on 4 channels; 2.5 on 8 channels (2 channels interleaved)	10; 20 (2 channels interleaved in 4 GHz and 6 GHz model)
standard: 400 Mpoints; max. upgrade: 800 Mpoints ²⁾	standard: 500 Mpoints max. upgrade: 1 Gpoints ²⁾	standard: 200 Mpoints/800 Mpoints; max. upgrade: 1 Gpoints/2 Gpoints
standard: 10 000 segments; option: 1 000 000 segments	standard: 10 000 segments; option: 1 000 000 segments	standard
> 4 500 000	> 4 500 000 on 4 channels	1 000 000 (2 500 000 in ultra-segmented memory mode)
digital	digital	digital (includes zone trigger)
0.0001 div, across full bandwidth, user controllable	0.0001 div, across full bandwidth, user controllable	0.0001 div, across full bandwidth, user controllable
16	16	16
		user configurable, hardware based
advanced (formula editor)	advanced (formula editor)	advanced (formula editor, Python interface)
I ² C, SPI, UART/RS-232/RS-422/RS-485, CAN, CAN FD, CAN XL, LIN, SPMI, 10BASE-T1S	I ² C, SPI, UART/RS-232/RS-422/RS-485, CAN, CAN FD, CAN XL, LIN, SPMI, 10BASE-T1S, 100BASE-T1	I ² C, SPI, UART/RS-232/RS-422/RS-485, CAN, LIN, I ² S, MIL-STD-1553, ARINC429, FlexRay™, CAN FD, MIPI RFFE, USB 2.0/HSIC, MDIO, 8b10b, Ethernet, Manchester, NRZ, SENT, MIPI D-PHY, SpaceWire, MIPI M-PHY/UniPro, CXPI, USB 3.1 Gen 1, USB-SSIC, PCIe 1.1/2.0, USB Power Delivery, Automotive Ethernet 100/1000BASE-T1
power, digital voltmeter (DVM), frequency response analysis	power, digital voltmeter (DVM), frequency response analysis	power, advanced spectrum analysis and spectrogram, jitter and noise decomposition, clock data recovery (CDR), I/Q data and RF analysis (R&S®VSE), deembedding, TDR/TDT analysis
–		see specifications (PD 5216.1640.22)
13.3" touchscreen, 1920 x 1080 pixel (Full HD)	for MXO 5 only: 15.6" touchscreen, 1920 x 1080 pixel (Full HD)	15.6" touchscreen, 1920 x 1080 pixel (Full HD)
414 x 279 x 162	MXO 5: 445 x 314 x 154 MXO 5C: 445 x 105 x 405	450 x 315 x 204
6	MXO 5: 9 MXO 5C: 8.7	10.7
–	–	–

R&S®Scope Rider RTH Handheld Oscilloscope



The perfect multipurpose tool for the lab or in the field.

- ▶ 60 MHz to 500 MHz at up to 5 Gsample/s
- ▶ High speed acquisition system with history mode
- ▶ 10-bit ADC
- ▶ Excellent sensitivity: 2 mV/div to 100 V/div
- ▶ Up to 200 V offset compensation range
- ▶ 37 automatic measurement functions
- ▶ Deep zoom with 500 ksample acquisition memory

Model overview

Model	Bandwidth	Channel (analog/digital)	Sample rate (analog/digital)	Memory depth	Update rate	Vertical resolution
R&S®RTH1002	60 MHz	2/8 (optional)	5 Gsample/s/1.25 Gsample/s	up to 500 kpoints, 50 Mpoints segmented memory	50000 waveforms/s	up to 10 bit
R&S®RTH1012	100 MHz					
R&S®RTH1022	200 MHz					
R&S®RTH1032	350 MHz					
R&S®RTH1052	500 MHz					
R&S®RTH1004	60 MHz	4/8 (optional)				
R&S®RTH1014	100 MHz					
R&S®RTH1024	200 MHz					
R&S®RTH1034	350 MHz					
R&S®RTH1054	500 MHz					

Important facts

Specification	R&S®Scope Rider RTH	Why this is important
Update rate	50 000 waveforms/s	The faster the update rate, the faster users can find infrequent events.
Memory depth	up to 500 kpoints, 50 Mpoints segmented memory	Allows capture of the longest period of time at high sample rate.
Integration	DMM, MSO, protocol analyzer, data logger	Allows debugging of low speed serial devices and mixed signal designs.
ADC resolution	10 bit	Allows users to see more detail and smaller signals.
Display	7", 800 x 480, touchscreen	Makes it easier to operate and see information on the display.

Scope of delivery

- ▶ User manual
- ▶ Power cord
- ▶ USB cable
- ▶ Passive probes for each channel

Recommended options/accessories

Description	Type
Hardware options (plug-in)	
Mixed signal option, 250 MHz, 8 digital channels	R&S®RTH-B1
Software options	
I ² C/SPI serial decoding	R&S®RTH-K1
UART/RS-232/RS-422/RS-485 serial decoding	R&S®RTH-K2
CAN/LIN serial triggering and decoding	R&S®RTH-K3

Recommended options/accessories

Description	Type
Spectrum analysis	R&S®RTH-K18
Advanced triggering	R&S®RTH-K19
Frequency counter	R&S®RTH-K33
Harmonics analysis	R&S®RTH-K34
User scripting	R&S®RTH-K38
Wireless LAN	R&S®RTH-K200/ R&S®RTH-K200US
Web interface remote control	R&S®RTH-K201
Probes	
Passive probe, 500 MHz, 10:1, isolated, 600 V CAT IV, 1000 V CAT III	R&S®RT-ZI10
Passive probe, 500 MHz, 100:1, isolated, 600 V CAT IV, 1000 V CAT III	R&S®RT-ZI11
Current probe, 100 kHz, 30 A, AC/DC	R&S®RT-ZC03



The perfect choice for:	
Electrical and electromechanical installation and maintenance	Education
Electronic field service and maintenance	Debugging and testing advanced power electronics

Your benefit	Features
Superior performance	<ul style="list-style-type: none"> ▶ Deep memory (up to 50 Msample) and high resolution (5 Gsample/s) ▶ Fast acquisition rate: 50 000 waveforms/s ▶ 10-bit ADC ▶ Excellent sensitivity: 2 mV/div to 100 V/div ▶ Up to 200 V offset range ▶ 37 automatic measurement functions
Outstanding protection and excellent connectivity	<ul style="list-style-type: none"> ▶ Isolated channels: CAT IV 600 V/CAT III 1000 V ▶ IP51 housing that meets military requirements ▶ Wireless LAN and Ethernet for web based remote control and quick data access
8 instruments in one handheld package	<ul style="list-style-type: none"> ▶ Lab performance oscilloscope ▶ Logic analyzer ▶ Protocol analyzer ▶ Data logger ▶ Digital multimeter¹⁾ ▶ Spectrum analyzer ▶ Harmonics analyzer ▶ Frequency counter

¹⁾ Additional multimeter channel in two-channel model.



The high-speed acquisition system of the R&S®ScopeRider RTH captures up to 50 000 waveforms/s and uncovers rare and unexpected signal anomalies

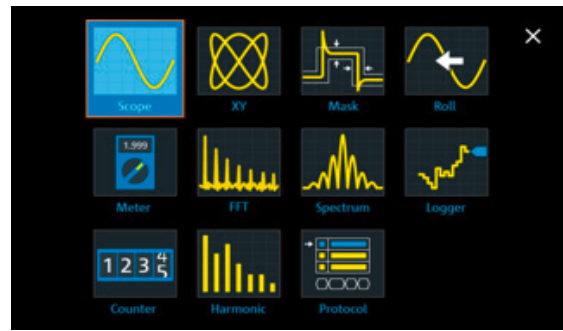

8 instruments in one: users can select the instrument they need at the push of a button

10-bit A/D converter: uncovers even small signal details

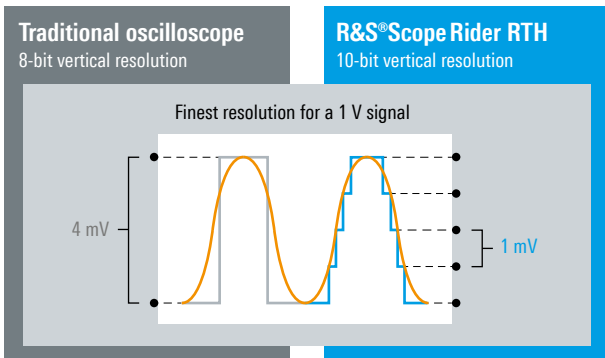

Double insulation for maximum safety

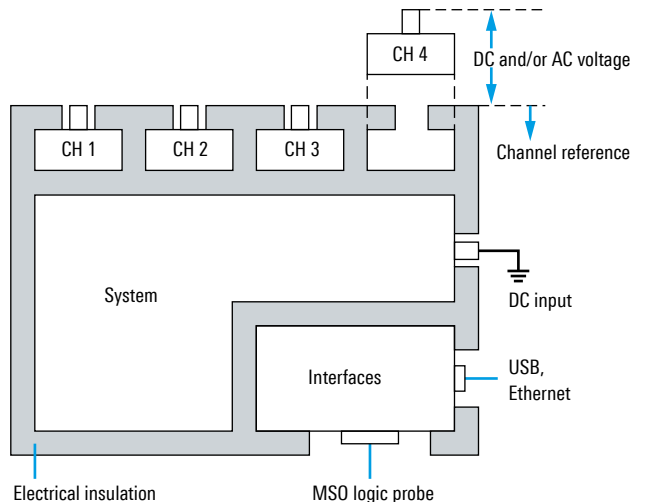

R&S®RTC1000 Oscilloscope

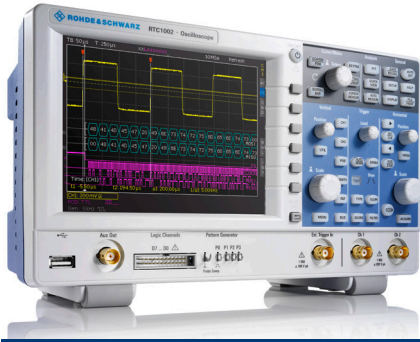

Get your results quicker

- ▶ Low-noise frontend for best results
- ▶ X-in-1 instrument that offers the functionality of an oscilloscope, logic analyzer, protocol analyzer, frequency analyzer, pattern generator, function generator, digital voltmeter and component tester

Model overview

Model	Bandwidth	Channel (analog/digital)	Consists of	Maximum sample rate	Maximum memory depth
R&S®RTC1002	50 MHz		R&S®RTC1000		
R&S®RTC1K-72	70 MHz		R&S®RTC1000 + R&S®RTC-B220		
R&S®RTC1K-102	100 MHz	2	R&S®RTC1000 + R&S®RTC-B221	2 Gsample/s	2 Msample
R&S®RTC1K-202	200 MHz		R&S®RTC1000 + R&S®RTC-B222		
R&S®RTC1K-302	300 MHz		R&S®RTC1000 + R&S®RTC-B223		
R&S®RTC1K-52M	50 MHz		R&S®RTC1000 + R&S®RTC-B1		
R&S®RTC1K-72M	70 MHz		R&S®RTC1000 + R&S®RTC-B220 + R&S®RTC-B1		
R&S®RTC1K-102M	100 MHz	2/8	R&S®RTC1000 + R&S®RTC-B221 + R&S®RTC-B1	2 Gsample/s	2 Msample
R&S®RTC1K-202M	200 MHz		R&S®RTC1000 + R&S®RTC-B222 + R&S®RTC-B1		
R&S®RTC1K-302M	300 MHz		R&S®RTC1000 + R&S®RTC-B223 + R&S®RTC-B1		

Important facts

Specification	R&S®RTC1000	Why this is important
Bandwidth	50/70/100/200/300 MHz (upgradeable, configurable)	Upgradeable bandwidth up to 300 MHz provides investment protection for future requirements.
Maximum memory depth	2 Msample	Allows capture of the longest period of time at high sample rate.
Mixed signal option (MSO)	8 channels, upgradeable, 0.5 Gsample/s, 0.5 Msample	Ideal for analysis of digital buses and correlation with analog signals.
Multifunctional	DVM, counter, waveform generator, pattern generator, component tester	Saves desk space and is a smart investment.

Scope of delivery

- ▶ User manual
- ▶ Power cord
- ▶ R&S®RT-ZP03S single-ended passive probes for each channel

Recommended options/accessories

Description	Type
Hardware options	
Mixed signal upgrade for non-MSO models, 300 MHz	R&S®RTC-B1
Arbitrary waveform generator	R&S®RTC-B6
Software options	
I ² C/SPI serial triggering and decoding	R&S®RTC-K1
UART/RS-232/RS-422/RS-485 serial triggering and decoding	R&S®RTC-K2
CAN/LIN serial triggering and decoding	R&S®RTC-K3
Application bundle (R&S®RTC-K1, -K2, -K3, -B6)	R&S®RTC-PK1
Option bundle	
Soft carrying bag	R&S®RTC-Z3
Rackmount kit	R&S®ZZA-RTC1K



The perfect choice for:	
R&D troubleshooting	Education
Production tests and repair	Electronic hobbyists

Your benefit	Features
Get your results quicker	Fast boot and auto measurement for concise and comprehensive results
Investment protection	Expandable to your needs through software licenses
Compactness saves desk space	Highest integration of instruments in a small form factor

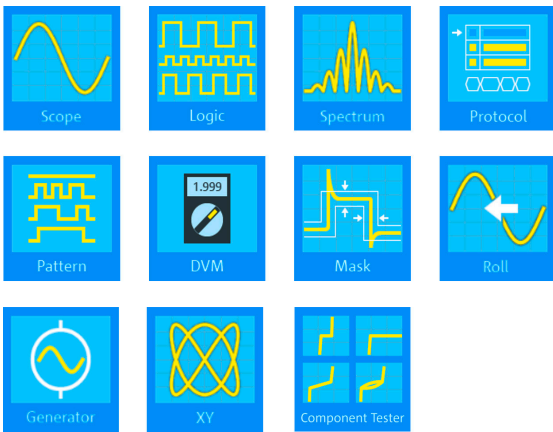

X-in-1 oscilloscope

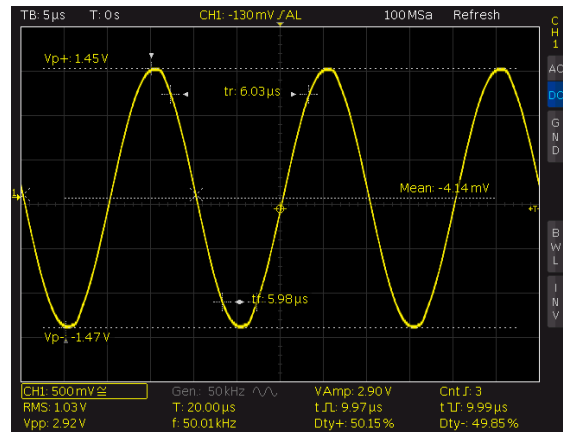

QuickView: automatic measurement and graphical display at the push of a button

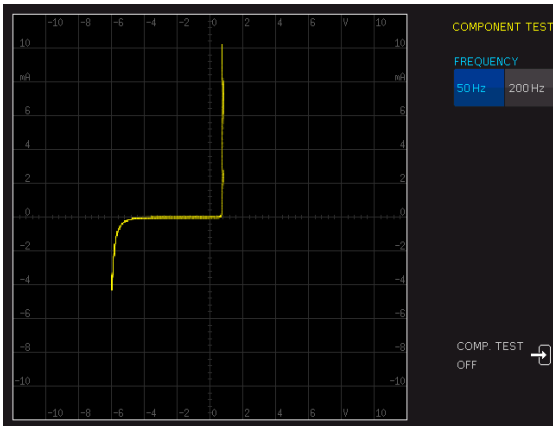

Quickly assess your components with the integrated tester

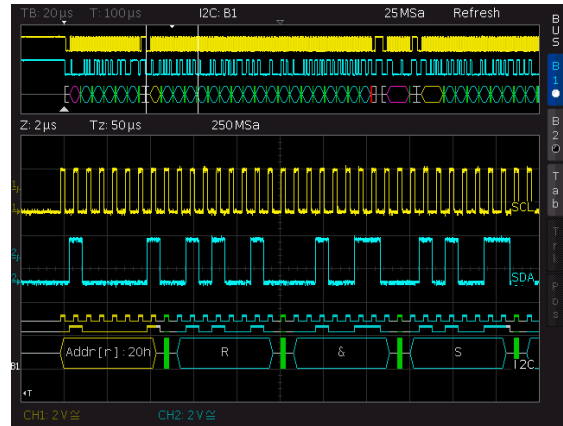

Gather insight into the digital communications on your circuitry



R&S®RTB2000 Oscilloscope



More signal details with the power of 10

- ▶ 10-bit ADC on all sensitivity with very low noise
- ▶ 10 Msample acquisition memory depth on each channel (20 Msample when interleaved)
- ▶ Large 10.1" high-resolution capacitive touchscreen
- ▶ 10-second boot-up time

Model overview

Model	Bandwidth	Channel (analog/digital)	Sample rate (analog/digital)	Memory depth	Update rate	Vertical resolution
R&S®RTB2002	70 MHz	2/16 (optional)	2.5 Gsample/s/1.25 Gsample/s	up to 160 Msample	50 000 waveforms/s	10 bit
R&S®RTB2004	70 MHz	4/16 (optional)	2.5 Gsample/s/1.25 Gsample/s	up to 160 Msample	50 000 waveforms/s	10 bit

Important facts

Specification	R&S®RTB2000	Why this is important
Bandwidth	70/100/200/300 MHz (upgradeable)	Upgradeable bandwidth up to 300 MHz provides investment protection for future requirements.
ADC resolution	10 bit	Allows users to see more detail and smaller signals.
Maximum memory depth	20 Msample (160 Msample history)	Allows capture of the longest period of time at high sample rate.
Display	10.1", 1280 × 800 pixel, capacitive touchscreen	Makes it easier to operate and see information on the display.
Update rate	50 000 waveforms/s	The faster the update rate, the faster users can find infrequent events.
Integration	DVM, counter, function generator, pattern generator, 16 channels MSO	Allows debugging of low speed serial devices and mixed signal designs.
Interfaces	USB, LAN with fast web browser and MTP	Remote control makes updating and monitoring of the instrument easy.

Scope of delivery

- ▶ Single-ended passive probes for each channel
- ▶ Power cord
- ▶ USB cable
- ▶ User manual
- ▶ 3 year warranty

Recommended options/accessories

Description	Type
Hardware options	
Mixed signal upgrade for non-MSO models, 300 MHz, incl. 2 × R&S®RT-ZL03	R&S®RTB-B1
Arbitrary waveform generator	R&S®RTB-B6
Software options	
I ² C/SPI serial triggering and decoding	R&S®RTB-K1
UART/RS-232/422/485 serial triggering and decoding	R&S®RTB-K2
CAN/LIN serial triggering and decoding	R&S®RTB-K3
History and segmented memory with 160 Msample	R&S®RTB-K15
Frequency response analysis (Bode plot)	R&S®RTB-K36
Application bundle (R&S®RTB-K1, -K2, -K3, -K15, -K36, -B6)	R&S®RTB-PK1



The perfect choice for:	
R&D troubleshooting	Education
Production tests and repair	Electronic hobbyists

Your benefit	Features
See small signal details in the presence of large signals	<ul style="list-style-type: none"> ▶ 10-bit ADC ▶ 1280 × 800 pixel display resolution
Capture more time at full bandwidth	<ul style="list-style-type: none"> ▶ 2.5 Gsample/s max. sample rate with up to 20 Msample memory ▶ 12 horizontal divisions
Easier to see and collaborate; faster to operate and interpret results	<ul style="list-style-type: none"> ▶ 10.1" capacitive touchscreen with 1280 × 800 resolution ▶ Grid annotation ▶ Split dual window



X-in-1 oscilloscope

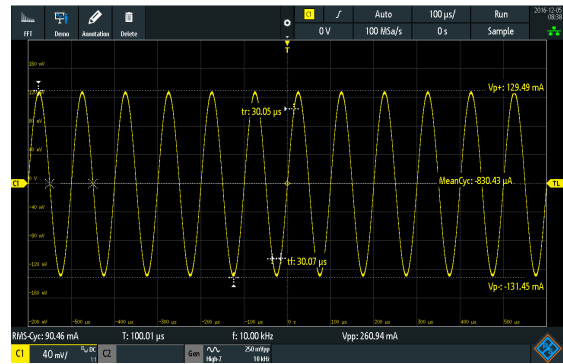

QuickMeas: automatic measurement and graphical display at the push of a button

10 to 160 times more memory depth compared to traditional oscilloscopes in the same instrument class

Capture the longest time periods with class-leading 160 Msample memory

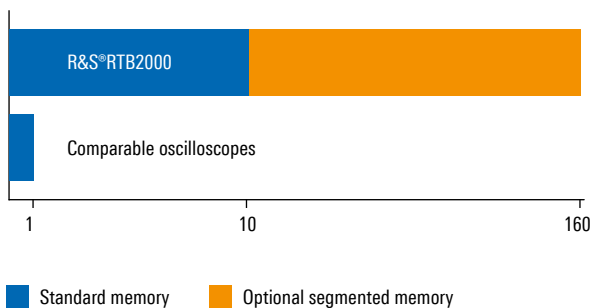

10-bit A/D converter: uncovers even small signal details

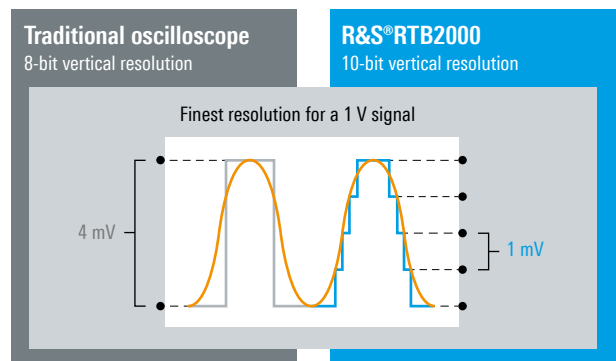

R&S®RTM3000 Oscilloscope



See more of your signal with the power of 10

- ▶ Large 10.1" capacitive touchscreen
- ▶ 10-bit ADC at all sensitivity levels and with very little noise
- ▶ 40 Msample (all channels) and 80 Msample (interleaved) acquisition memory depth
- ▶ 10 s boot time

Model overview

Model	Bandwidth	Channel (analog/digital)	Consists of	Maximum sample rate (analog/digital)	Maximum memory depth
R&S®RTM3002	100 MHz	2	R&S®RTM3002	5 Gsample/s	40 Msample/channel, 80 Msample interleaved standard, 400 Msample (optional)
R&S®RTM3004	100 MHz	4	R&S®RTM3004		
R&S®RTM3K-22	200 MHz	2	R&S®RTM3002 + R&S®RTM-B222		
R&S®RTM3K-24	200 MHz	4	R&S®RTM3004 + R&S®RTM-B242		
R&S®RTM3K-32	350 MHz	2	R&S®RTM3002 + R&S®RTM-B223		
R&S®RTM3K-34	350 MHz	4	R&S®RTM3004 + R&S®RTM-B243		
R&S®RTM3K-52	500 MHz	2	R&S®RTM3002 + R&S®RTM-B225		
R&S®RTM3K-54	500 MHz	4	R&S®RTM3004 + R&S®RTM-B245		
R&S®RTM3K-102	1 GHz	2	R&S®RTM3002 + R&S®RTM-B2210		
R&S®RTM3K-104	1 GHz	4	R&S®RTM3004 + R&S®RTM-B2410		
R&S®RTM3K-02M	100 MHz	2/16	R&S®RTM3002 + R&S®RTM-B1	5 Gsample/s/ 5 Gsample/s	
R&S®RTM3K-04M	100 MHz	4/16	R&S®RTM3004 + R&S®RTM-B1		
R&S®RTM3K-22M	200 MHz	2/16	R&S®RTM3002 + R&S®RTM-B222 + R&S®RTM-B1		
R&S®RTM3K-24M	200 MHz	4/16	R&S®RTM3004 + R&S®RTM-B242 + R&S®RTM-B1		
R&S®RTM3K-32M	350 MHz	2/16	R&S®RTM3002 + R&S®RTM-B223 + R&S®RTM-B1		
R&S®RTM3K-34M	350 MHz	4/16	R&S®RTM3004 + R&S®RTM-B243 + R&S®RTM-B1		
R&S®RTM3K-52M	500 MHz	2/16	R&S®RTM3002 + R&S®RTM-B225 + R&S®RTM-B1		
R&S®RTM3K-54M	500 MHz	4/16	R&S®RTM3004 + R&S®RTM-B245 + R&S®RTM-B1		
R&S®RTM3K-102M	1 GHz	2/16	R&S®RTM3002 + R&S®RTM-B2210 + R&S®RTM-B1		
R&S®RTM3K-10M	1 GHz	4/16	R&S®RTM3004 + R&S®RTM-B2410 + R&S®RTM-B1		

Important facts

Specification	R&S®RTM3000	Why this is important
Bandwidth	100/200/350/500/1000 MHz (upgradeable)	Upgradeable bandwidth up to 1 GHz provides investment protection for future requirements.
ADC resolution	10 bit	Allows users to see more detail and smaller signals.
Maximum resolution	16 bit with high resolution or averaging	Allows users to see more detail and smaller signals.
Maximum memory depth	80 Msample	Allows capture of the longest period of time at high sample rate.
Segmented memory/history	optional, 400 Msample	Ideal for burst signals. Allows capture of the longest time periods at a high sample rate without wasting memory on idle periods.
Display	10.1", 1280 × 800, capacitive touchscreen	Makes it easier to operate and see information on the display.
Hardware dynamic range, full bandwidth	<ul style="list-style-type: none"> ▶ 1 MΩ: 0.5 mV to 10 V ▶ 50 Ω: 0.5 mV to 1 V 	Smallest settings allow users to zoom in on small signals with full bandwidth. Largest settings allow users to properly scale a large waveform.
Boot time	approx. 10 s	Remote control makes updating and monitoring of the instrument easy.



The perfect choice for:	
R&D debugging power	R&D debugging serial buses
Manufacturing test and repair	Education

Your benefit	Features
Easier to see and collaborate; faster to operate and interpret results	10.1" capacitive touchscreen with 1280 × 800 resolution, Grid annotation, split dual window, SmartGrid
Capture more time at full bandwidth	5 Gsample/s max. sample rate with up to 80 Msample memory, 12 horizontal divisions, 400 Msample history mode
See small signal details in the presence of large signals	10-bit ADC. 10.1", 1280 × 800 pixel display resolution
Start working sooner	10 s boot time
Troubleshoot and solve a wide range of problems with one instrument	8 instruments in one: oscilloscope, logic analyzer, spectrum analyzer, protocol analyzer, arbitrary waveform generator, pattern generator, counter, digital voltmeter

Power highlights

- ▶ Analysis of the input, output and transfer functions of switched-mode power supplies
- ▶ Measurement wizard for fast results
- ▶ Simple and fast documentation
- ▶ Analysis of the harmonic current in line with conventional EN, MIL and RTCA standards

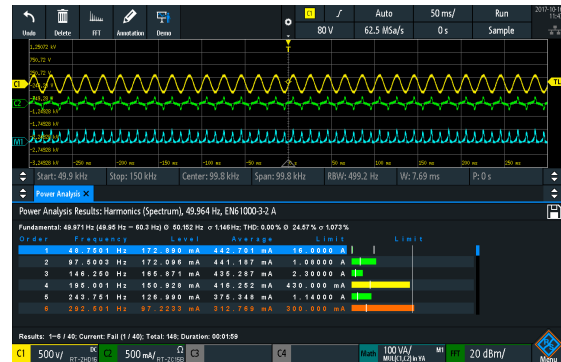

Power analysis measurement

Scope of delivery
▶ User manual
▶ Power cord
▶ R&S®RT-ZP05S single-ended passive probes for each channel

Recommended options/accessories	
Description	Type
Hardware options	
Mixed signal upgrade for non-MSO models, 16 channels, 5 Gsample/s, up to 80 Msample	R&S®RTM-B1
Arbitrary waveform generator	R&S®RTM-B6
Software options	
I ² C/SPI triggering and decoding	R&S®RTM-K1
UART/RS-232/422/485 triggering and decoding	R&S®RTM-K2
History and segmented memory with 400 Msample	R&S®RTM-K15
Spectrum analysis and spectrogram	R&S®RTM-K37
Frequency response analysis (Bode plot)	R&S®RTM-K36
Application bundle ¹⁾ , consists of the following options: (R&S®RTM-K1, -K2, -K3, -K5, -K6, -K7, -K15, -K31, -K36, -K37, -B6)	R&S®RTM-PK1US

¹⁾ The R&S®RTM-PK1US option is only distributed in North America.

8 instruments in one	
Oscilloscope	standard
Logic analyzer (16-channel MSO)	R&S®RTM-B1 MSO option, includes cabling, lead sets and grabbers
Protocol analyzer	options for different serial buses
Spectrum analyzer	R&S®RTM-K37 option with spectrogram
Integrated digital voltmeter	standard
Trigger counter	standard
Waveform generator (25 MHz)	R&S®RTM-B6 option
Pattern generator (4 bit)	R&S®RTM-B6 option

MXO 4 Series Oscilloscope



Next generation oscilloscope for accelerated insight

- ▶ 200 MHz to 1.5 GHz bandwidth
- ▶ 400 Mpoints per channel standard memory
- ▶ > 4.5 million waveforms/s with capture rate of up to 99%
- ▶ Precise digital trigger
- ▶ Up to 5 Gsample/s sample rate

Model overview

Model	Bandwidth	Channel	Sample rate	Maximum memory depth	Optional MSO
R&S®MX044-242	200 MHz	4	5 Gsample/s	400 Mpoints per channel (optional 800 Mpoints)	16 digital channels
R&S®MX044-243	350 MHz				
R&S®MX044-245	500 MHz				
R&S®MX044-2410	1 GHz				
R&S®MX044-2415	1.5 GHz				

Important facts

Specification	MXO 4	Why this is important
Capture rate	> 4.5 million waveforms/s	Find signal anomalies quickly.
ADC resolution	12 bit (18-bit architecture with HD mode)	See your signals accurately.
Memory depth	standard: 400 Mpoints per channel; option: 800 Mpoints interleaved	Capture more time.
Trigger	Industry's most sensitive trigger: 0.0001 vertical division	Isolate events with more precision.

Scope of delivery

- ▶ Power cable
- ▶ Quick start guide
- ▶ 3 year warranty

Recommended options/accessories

Description	Type
Hardware options	
Mixed signal option (MSO) with 16 digital channels	R&S®MXO4-B1
Arbitrary waveform generator, 100 MHz, 2 channels	R&S®MXO4-B6
Memory upgrade to 800 Mpoints on 2 channels	R&S®MXO4-B108
Software options	
Power analysis	R&S®MXO4-K31
Frequency response analysis	R&S®MXO4-K36
Low speed serial triggering and decoding (I ² C/SPI/UART/RS-232/RS-422/RS-485)	R&S®MXO4-K510
Automotive serial triggering and decoding (CAN/CAN FD/CAN XL/LIN)	R&S®MXO4-K520
MIPI low speed protocols (SPMI)	R&S®MXO4-K550
Automotive Ethernet protocols (10BASE-T1S)	R&S®MXO4-K560
Accessories	
Front cover	R&S®MXO4-Z1
Soft case	R&S®MXO4-Z3
Transit case	R&S®MXO4-Z4
19" rackmount kit, 6 HU	R&S®ZZA-MXO4



The perfect choice for:

Hardware debugging; serial bus analysis	Power analysis
EMI debugging	Power integrity



Your go-to tool:

- ▶ Wide range of analysis functions accelerated by hardware for real-time performance, including math, measurements, etc.
- ▶ 16 digital channels activated with R&S®MXO4-B1 probes that can be used simultaneously with all analog channels
- ▶ R&S®MXO4-B6 adds 2 integrated 100 MHz arbitrary waveform generators with a wide range of available waveform shapes
- ▶ Frequency response and impedance analysis are available with R&S®MXO4-K36, making the oscilloscope more versatile for power analysis



Serial bus analysis:

- ▶ Innovative dual-path protocol analysis for correct protocol packet decoding and triggering regardless of sample rate settings for waveform acquisitions
- ▶ Combined with deepest memory and segmentation, the MXO 4 captures longer durations of protocol events to help monitor and understand system behavior
- ▶ Search functionality helps finding events of interest in captured bus activity based on trigger or protocol content

Probe choices

Rohde&Schwarz offers a wide variety of probe choices for your applications including:

- ▶ Active single-ended and differential probes
- ▶ Modular broadband probes
- ▶ High voltage and current probes
- ▶ Power rail probes
- ▶ Logic probes
- ▶ Near-field probes

Your benefit | **Features**

Find signal anomalies quickly

- ▶ World's fastest acquisition rate of up to > 4.5 million waveforms/s reveals infrequent anomalies instantly
- ▶ Industry's fastest trigger rearm time of 21 ns

See your signals accurately

- ▶ 12-bit ADC for high vertical resolution at all sample rates across the full bandwidth
- ▶ 18-bit architecture with HD mode
- ▶ Lowest noise of 104 μ V at 1 GHz on 1 mV/div sensitivity
- ▶ Vertical sensitivity to 500 μ V/div with \pm 5 V offset range

Capture more time

- ▶ Industry's deepest memory of 400 Mpoints per channel (optionally 800 Mpoints interleaved)
- ▶ History and segmentation memory to capture up to 1 million acquisitions

Isolate events with more precision

- ▶ Industry's most sensitive trigger: 0.0001 vertical division
- ▶ Best in class trigger jitter of just 1 ps
- ▶ Adjustable digital trigger filters

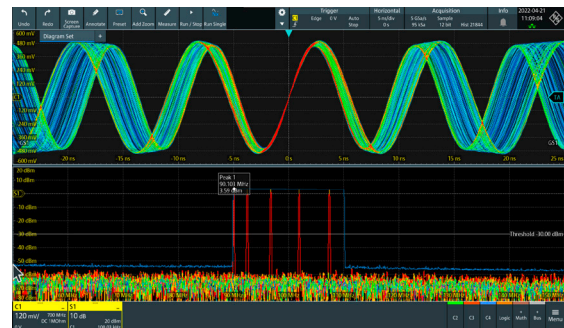

Spectrum analysis:

- ▶ Hardware accelerated processing with an industry leading spectrum acquisition rate of 45 000 FFT/s, ideal for capturing spurious and random spectrum events
- ▶ RF and time domain views with independent control allows intuitive setup while remaining time-correlated
- ▶ Pristine RF spectrum performance with peak list and max./min. hold traces makes MXO 4 perfect for EMI debugging

Visit our probe portfolio to find out more:



MXO 5 Series Oscilloscope



New



Next generation oscilloscope: evolved for more challenges

- ▶ 100 MHz to 2 GHz bandwidth
- ▶ Up to 5 Gsample/s sample rate
- ▶ 500 Mpoints per channel standard memory
- ▶ 12-bit ADC at all sample rates
- ▶ 18-bit architecture with HD mode
- ▶ Precise digital trigger

Model overview

Model	Bandwidth
4-channel model	
R&S®MXO54-350	350 MHz
R&S®MXO54-500	500 MHz
R&S®MXO54-1000	1 GHz
R&S®MXO54-2000	2 GHz
8-channel model	
R&S®MXO58-100	100 MHz
R&S®MXO58-200	200 MHz
R&S®MXO58-350	350 MHz
R&S®MXO58-500	500 MHz
R&S®MXO58-1000	1 GHz
R&S®MXO58-2000	2 GHz

Key specifications

Maximum sample rate	interleaved: 5 Gsample/s; all channels: 2.5 Gsample/s
Channels	analog: 4 or 8; digital: 16 standard (dedicated connector)
Acquisition rate	per channel: 4.5 million acquisitions/s; on 4 channels: 18 million acquisitions/s
ADC resolution	12 bit (all sample rates)
Maximum vertical resolution	18 bit (HD mode)
Standard memory depth	standard: 500 Mpoints per channel; option: 1 Gpoints interleaved
Segmented memory	up to 1 million segments with 1 Mpoints capture
FFT speed	> 45 000 FFT/s
FFT capabilities	log-log display, max./min. hold, peak lists
Vertical noise floor	130 µV (RMS) at 1 mV/div, 2 GHz bandwidth
Vertical offset range	5 V at 1 MΩ coupling
Arbitrary generator	2 channels, 100 MHz with 625 Msample/s
Digital trigger sensitivity	0.0001 div
Trigger hysteresis	user selectable
Trigger jitter	< 1 ps (RMS) (meas.)
Timebase accuracy	±0.2 ppm
Display	15.6" Full HD display with capacitive touch
VESA mount support	•, with R&S®MXO5-Z7 VESA adapter
Operating system	Linux
Upgradeable	bandwidth, protocol trigger and decode, arbitrary waveform generator, analysis capabilities

Scope of delivery

- ▶ 700 MHz passive probe (10:1) per channel
- ▶ Power cable
- ▶ Quick start guide
- ▶ Accessory bag
- ▶ 1 year warranty

Recommended options/accessories

Description	Type
Bandwidth upgrade	
Upgrade of MXO 54 to 500 MHz bandwidth	R&S®MXO5-B245
Upgrade of MXO 54 to 1 GHz bandwidth	R&S®MXO5-B2410
Upgrade of MXO 54 to 2 GHz bandwidth	R&S®MXO5-B2420
Upgrade of MXO 58 to 200 MHz bandwidth	R&S®MXO5-B282
Upgrade of MXO 58 to 350 MHz bandwidth	R&S®MXO5-B283
Upgrade of MXO 58 to 500 MHz bandwidth	R&S®MXO5-B285
Upgrade of MXO 58 to 1 GHz bandwidth	R&S®MXO5-B2810
Upgrade of MXO 58 to 2 GHz bandwidth	R&S®MXO5-B2820

Recommended options/accessories

Options	
Mixed signal option, for MXO 5 series with 16 digital channels	R&S®MXO5-B1
Arbitrary waveform generator, 100 MHz, 2 analog channels	R&S®MXO5-B6
Additional M.2 SSD	R&S®MXO5-B19
Memory option 1 Gpoints	R&S®MXO5-B110
Accessories	
Rackmount kit, for MXO 5 series with 8 HU	R&S®ZZA-MXO5
Front cover	R&S®MXO5-Z1
Soft case (W × H × D: 550 mm × 300 mm × 340 mm)	R&S®MXO5-Z3
Transit case (W × H × D: 613 mm × 478 mm × 337 mm)	R&S®MXO5-Z4
VESA adapter	R&S®MXO5-Z7



The perfect choice for:	
Hardware debugging and serial bus analysis	Power analysis
EMI debugging	Power sequencing
Power integrity	Signal integrity

Important facts		
Specification	MXO 5	Why this is important
Capture rate	< 4.5 million waveforms/s	Find signal anomalies quickly.
ADC resolution	12 bit (18-bit architecture with HD mode)	See your signals accurately.
Memory depth	standard: 500 Mpoints per channel; option: 1 Gpoints interleaved	Capture more time.
Trigger	Industry's most sensitive trigger: 0.0001 vertical division	Isolate events with more precision.
Spectrum	> 45000 FFT/s	Multi-domain approach for signal insights. Fast FFT makes EMI debugging responsive to capture rare RF events.
Channels	4 or 8	See more signals at the same time with R&S®SmartGrid to intuitively arrange necessary waveforms.

Your go-to tool



Serial protocol trigger and decode



Fast spectrum support log-log scale



2 arbitrary generators (1 MHz to 100 MHz)



Power analysis quality and harmonics

Rohde & Schwarz will continue to rollout newer capabilities and functions in the future to meet ever changing requirements.



Digital voltmeter



Math functions



MSO logic analysis



Frequency response

Use cases (highlights)

Inverter and drive train analysis

- ▶ More channels to observe voltage and current signals
- ▶ New WBG devices for faster switching
- ▶ Digital trigger with sensitivity to detect possible shoot-through events
- ▶ Longer record length for monitoring

Power sequencing and integrity

- ▶ Record more power rails longer
- ▶ 18-bit HD for high precision and sensitivity to power ripples
- ▶ Record all power up/down sequences
- ▶ Additional spectrum analysis helps identify spectral noise in debugging

Control loop response of power supply

- ▶ All-in-one tool to observe time and Bode plots
- ▶ Start from 0.01 Hz to 100 MHz
- ▶ Amplitude profile and delayed measurement for settling time

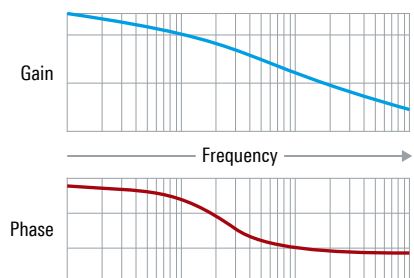
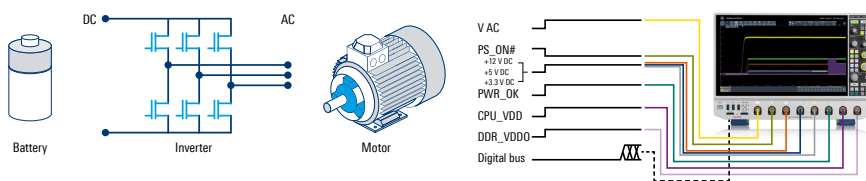

MXO 5C Series Oscilloscope



New

Next generation oscilloscope in a compact form

The MXO 5C delivers breakthrough oscilloscope technology leveraged from MXO 5 series in a 2 HU form factor. Take advantage of the industry's highest channel density from 100 MHz to 2 GHz of bandwidth. Perfect for rackmount applications, it can also be used in bench applications with an external display or web interface with a virtual front panel. The four-channel and eight-channel models with bandwidths from 100 MHz to 2 GHz let you choose the one that is right for you.

Model overview

Model	Bandwidth
4-channel model	
R&S®MXO5C-43	350 MHz
R&S®MXO5C-45	500 MHz
R&S®MXO5C-410	1 GHz
R&S®MXO5C-420	2 GHz
8-channel model	
R&S®MXO5C-81	100 MHz
R&S®MXO5C-82	200 MHz
R&S®MXO5C-83	350 MHz
R&S®MXO5C-85	500 MHz
R&S®MXO5C-810	1 GHz
R&S®MXO5C-820	2 GHz

Key specifications

Integrated micro display	•, IP address, status, firmware, others
External display	HDMI™, DisplayPort – virtual front panel
Maximum sample rate	interleaved: 5 Gsample/s; all channels: 2.5 Gsample/s
Channels	analog: 4 or 8; digital: 16 standard (dedicated connector)
Acquisition rate	per channel: 4.5 million acquisitions/s; on 4 channels: 18 million acquisitions/s
ADC resolution	12 bit (all sample rates)
Maximum vertical resolution	18 bit (HD mode)
Standard memory depth	standard: 500 Mpoints per channel; option: 1 Gpoints interleaved
Segmented memory	up to 1 million segments with 1 Mpoints capture
FFT speed	> 45000 FFT/s
FFT capabilities	log-log display, max./min. hold, peak lists
Vertical noise floor	130 µV (RMS) at 1 mV/div, 2 GHz bandwidth
Vertical offset range	5 V at 1 MΩ coupling
Arbitrary generator	2 channels, 100 MHz with 625 Msample/s
Digital trigger sensitivity	0.0001 div
Trigger hysteresis	user selectable
Trigger jitter	< 1 ps (RMS) (meas.)
Timebase accuracy	±0.2 ppm
Operating system	Linux
Upgradeable	bandwidth, protocol trigger and decode, arbitrary waveform generator, analysis capabilities

Scope of delivery

- ▶ Power cable
- ▶ Quick start guide
- ▶ 1 year warranty

Recommended options/accessories

Description	Type
Bandwidth upgrade	
Upgrade of MXO 54C to 500 MHz bandwidth	R&S®MXO5C-B405
Upgrade of MXO 54C to 1 GHz bandwidth	R&S®MXO5C-B410
Upgrade of MXO 54C to 2 GHz bandwidth	R&S®MXO5C-B420
Upgrade of MXO 58C to 200 MHz bandwidth	R&S®MXO5C-B802
Upgrade of MXO 58C to 350 MHz bandwidth	R&S®MXO5C-B803
Upgrade of MXO 58C to 500 MHz bandwidth	R&S®MXO5C-B805
Upgrade of MXO 58C to 1 GHz bandwidth	R&S®MXO5C-B810
Upgrade of MXO 58C to 2 GHz bandwidth	R&S®MXO5C-B820

Recommended options/accessories

Options	
Mixed signal option, for MXO 5C series with 16 digital channels	R&S®MXO5C-B1
Arbitrary waveform generator, 100 MHz, 2 analog channels	R&S®MXO5C-B6
Additional M.2 SSD	R&S®MXO5C-B19
Memory option 1 Gpoints	R&S®MXO5C-B110
Power analysis	R&S®MXO5C-K31
Frequency response analysis	R&S®MXO5C-K36
Low speed serial triggering and decoding (I ² C/SPI/UART/RS-232/RS-422/RS-485)	R&S®MXO5C-K510
Automotive serial triggering and decoding (CAN/CAN FD/CAN XL/LIN)	R&S®MXO5C-K520
MIPI low speed protocols (SPMI)	R&S®MXO5C-K550
Automotive Ethernet protocols (10BASE-T1S, 100BASE-T1)	R&S®MXO5C-K560

Accessory	
Rackmount kit, for MXO 5C series	R&S®ZZA-KN2NS



The perfect choice for:	
Rackmount	Bench
Oscilloscope or digitizer	General purpose, power electronics

Common applications
<ul style="list-style-type: none"> ▶ Physics research ▶ Automated test ▶ Manufacturing test ▶ Power electronics ▶ Power management (PMIC) ▶ Use with MXO 5 series for up to 16 channels with common trigger

Your benefit	Features
Best choice for your application and budget	<ul style="list-style-type: none"> Choose from a 4-channel or 8-channel version and a wider range of bandwidths (all user bandwidths upgradeable to 2 GHz) ▶ An extremely useful integrated micro display provides quick access to critical information such as instrument IP, firmware version and more
More flexibility for rack-mounts or benches	<ul style="list-style-type: none"> ▶ Use HDMI, DisplayPort or standard LAN web interfaces to visualize instrument controls ▶ Use in tighter spaces: Highest channel density in only 2 HU with 1/3 the depth of competitors
Measurement confidence from superior hardware	<ul style="list-style-type: none"> ▶ Includes 12-bit ADC that run at all sample rates ▶ Includes 500 Mpoints standard memory ▶ Captures up to 99% signal activity ▶ Rohde & Schwarz trigger re-arm time of 21 ns with max. update rate of 4.5 million waveforms/s after preset (86% real-time signal capture) ▶ Trigger isolates small signal details at all bandwidths and vertical settings without any tradeoffs

Important facts		
Specification	MXO 5C	Why this is important
Integrated micro display	low-power display IP address, firmware version and software options, available also when the instrument is turned off	Shows key information without needing a main screen.
Compact form factor	rackmount height: 2 HU	Compact for rackmount and bench applications where space is at a premium and high channel density is needed.
Removable M.2 SSD card	•	Enables data storage in a secure location.
External display	HDMI™, DisplayPort – virtual front panel	Allows users to connect the oscilloscope to an external display or touchscreen and enjoy the same user-friendly user interface as MXO 5 series.

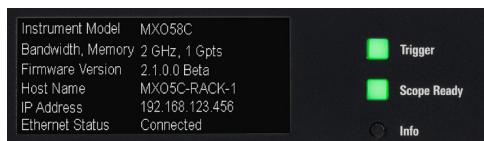

Integrated micro display provides critical info including IP address: Need to quickly find instrument IP address? Need to see if the oscilloscope is booted up and/or running? The world's first oscilloscope micro display gives you quick and easy access to critical information.



Do you need more than eight channels? Then combine a MXO 5 oscilloscope with a second one or with a MXO 5C for to 16 channels with a common trigger

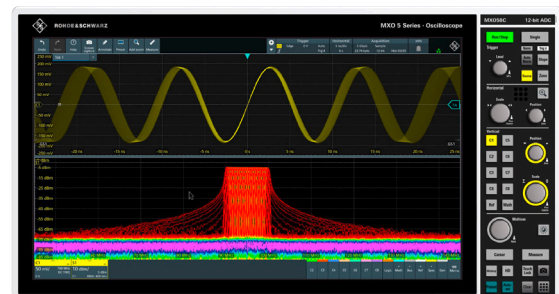

Remote LAN web interface: Interact with Rohde & Schwarz oscilloscopes using the built-in web browser. The front panel has buttons and dials in addition to the setting dialog. Make and download screen images with just a mouse click.

R&S®RTO6 Oscilloscope Series



Instant insight meets in-depth information

- ▶ 6 GHz maximum bandwidth
- ▶ 1 million waveforms/s
- ▶ 9.4 effective number of bits (ENOB) for ultimate signal integrity
- ▶ 2 Gpoints maximum memory
- ▶ Exclusive frequency zone trigger

Model overview

Option	Bandwidth	Channels	Update rate	Sample rate	Vertical resolution	Memory depth
R&S®RTO6-B90	600 MHz	4 input channels	up to 1 000 000 waveforms/s	max. 10 Gsample/s/ on each channel	16-bit system architecture; up to 9.4 effective number of bits (ENOB)	<ul style="list-style-type: none"> ▶ standard: 200 Mpoints per channel ▶ optional: 1 Gpoints per channel or 2 Gpoints on 1 channel
R&S®RTO6-B91	1 GHz					
R&S®RTO6-B92	2 GHz					
R&S®RTO6-B93	3 GHz					
R&S®RTO6-B94	4 GHz					
R&S®RTO6-B96	6 GHz					

Important facts

Specification	R&S®RTO6	Why this is important
Large display and optimized GUI	<ul style="list-style-type: none"> ▶ large 15.6" capacitive touchscreen ▶ Full HD resolution, 1920 × 1080 pixel (16:9) ▶ maximized waveform viewing area, condensed menus and quick-access toolbars for a better user-friendly experience 	A larger waveform viewing area allows users to see more signal details. With a better user-interface and straightforward workflows, quick measurements are easier and productivity greater.
Update rate	up to 1 000 000 waveforms/s	The faster the update rate, the faster users can find infrequent events.
Vertical resolution	up to 16 bit	Users can see more detail and smaller signals.
Trigger sensitivity	0.04 div	Users can trigger on the smallest signal details.
Memory depth	up to 2 Gsample	Allows capture of longest time periods at high sample rate.
Zone trigger	time and frequency domains	Industry-exclusive frequency zone trigger enables powerful debugging across the time and frequency domains and also has a history mode to see previous zone triggers.

Scope of delivery

- ▶ Power cable
- ▶ Quick start guide
- ▶ 3 year warranty

Recommended options/accessories

Hardware options	Type
Mixed signal option, 400 MHz, 16 digital channels	R&S®RTO-B1
Arbitrary waveform generator	R&S®RTO6-B6
16 GHz differential pulse source/TDR/TDT analysis	R&S®RTO6-B7/-K130
Memory upgrade, 400 Mpoints per channel	R&S®RTO6-B104
Memory upgrade, 1 Gpoints per channel	R&S®RTO6-B110
Recommended software options	
Spectrum analysis	R&S®RTO6-K37
Power analysis	R&S®RTO6-K31
Bus analysis	R&S®RTO6-K500
Trigger and decode bundle	R&S®RTO6-TDBDL



The perfect choice for:

Spectrum analysis	Serial bus analysis
EMI debugging	Power integrity

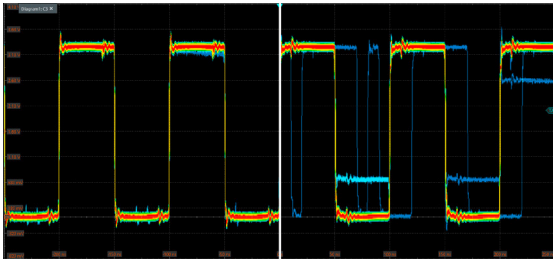

One million waveforms per second: R&S®RTO6 oscilloscopes can update at a high rate of up to one million waveforms per second when histograms, masks or cursor measurements are active. The ASIC based signal processing paths ensure a smooth workflow even when analyzing with the deep acquisition memory.

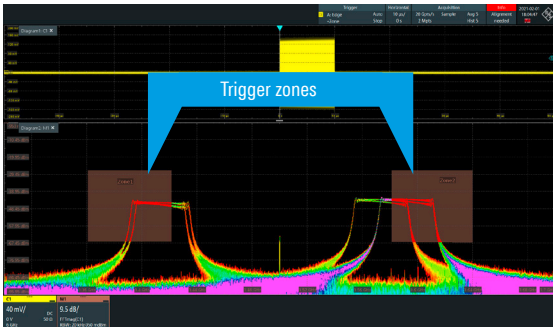

Zone trigger in time and frequency domain: The intuitive touch function can quickly draw shapes over the waveform area to activate the R&S®RTO6 oscilloscope zone trigger, helping graphically separate events in both the time and frequency domains. Define up to eight zones and logically combine them over multiple channels or math functions. Zones activate a trigger signal when a signal either intersects or fails to intersect with the zone, which can be a real-time waveform or a spectrum plot. This powerful, user-friendly feature can separate read/write sequences from the memory of the device under test (DUT).



Streamlined user interface and 15.6" touchscreen: The optimized R&S®RTO6 user interface and large 15.6" Full HD touchscreen simplify daily measurement tasks with straightforward workflows and multi-touch gestures. The enhanced waveform viewing area and condensed menus maximize the usability of R&S®RTO6 oscilloscopes and increase productivity by letting you focus on what is important – measuring.

Your benefit	Features
Find signal anomalies quickly...	...with an unparalleled update rate. By capturing up to 1 million waveforms per second, R&S®RTO6 oscilloscopes acquire, process and display signals extremely quickly. The high update rate increases the likelihood of detecting and displaying signal faults and including them in an analysis.
Capture all signal details...	...with excellent signal integrity. Custom A/D converters with extremely low linearity errors and an ultra-wide, spurious-free dynamic range ensure excellent signal integrity and an ENOB of up to 9.4.
See more...	...with up to 16-bit resolution. The high definition (HD) mode increases the R&S®RTO6 oscilloscope vertical resolution up to 16 bit with digital filtering. The increased resolution allows for sharper waveforms and reveals more signal details that might be masked by noise—or missed entirely.
Find complex signal details...	...with advanced trigger capabilities. The patented digital trigger system enables triggering on the smallest signal amplitudes and isolation of relevant signal events. The unique zone trigger function can separate events in both the time and frequency domain.
Measure more...	...with deep and responsive memory. Applications such as the seamless acquisition of long pulse trains or protocol sequences often require the deep memory of R&S®RTO6 oscilloscopes. Segmented memory and history mode help analyze and play back signal sequences over a long observation period.

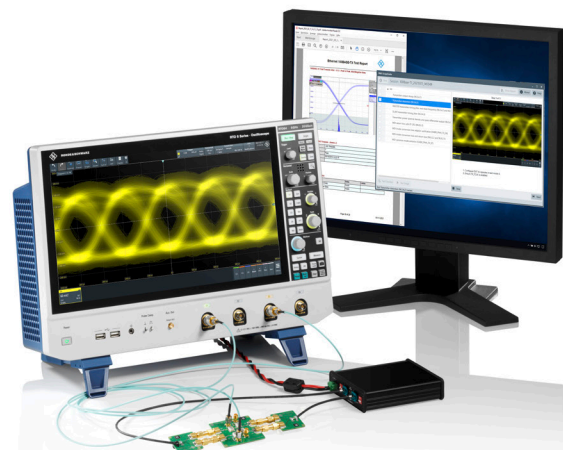

Signal integrity debugging and analysis: R&S®RTO6 oscilloscopes offer comprehensive debugging and analysis tools for signal integrity tests on high speed interfaces and designs. The oscilloscopes offer jitter and noise decomposition, high speed serial pattern trigger with clock data recovery (CDR) for eye diagrams, which is crucial for electric compliance test solutions for USB, Ethernet, PCIe, MIPI, DDR, and more.

Probe portfolio

Probe type

- Passive
- Active single-ended
- Active differential
- Modular
- Power rail
- Multichannel
- High voltage
- Current
- Near-field

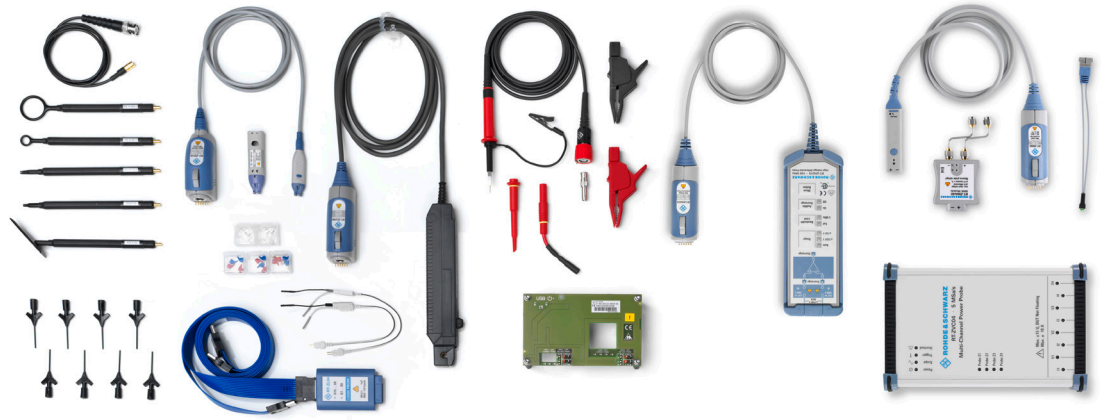

Type	Description	Bandwidth	Dynamic range
R&S®RT-ZP10	passive, single-ended, 10:1	500 MHz	400 V (RMS)
R&S®RT-ZP11	passive, single-ended, 10:1	700 MHz	400 V (RMS)
R&S®RT-ZI10	passive, single-ended, 10:1, isolated	500 MHz	600 V CAT IV, 1000 V CAT III
R&S®RT-ZZ80	passive, single-ended, 10:1, broadband	8 GHz	20 V (RMS)
R&S®RT-ZP1X	passive, single-ended, 1:1	38 MHz	55 V (RMS)
R&S®RT-ZS10L	active, single-ended, 10:1	1 GHz	±8 V
R&S®RT-ZS10E	active, single-ended, 10:1 ¹⁾	1 GHz	±8 V
R&S®RT-ZS10/20/30/60	active, single-ended, 10:1 ^{1), 2)}	1/1.5/3/6/13/16 GHz	±8 V
R&S®RT-ZD10/20/30	active, differential, 10:1 ^{1), 2)}	1/1.5/3 GHz	±5 V, with R&S®RT-ZA15: ±70 V DC, ±46 V AC (peak)
R&S®RT-ZD40	active, differential, 10:1 ^{1), 2)}	4.5 GHz	±5 V
R&S®RT-ZM15/30/60/90/130/160	active, multimode amplifier module, 10:1/2:1 ^{1), 2)}	1.5/3/6/9/13/16 GHz	depends on tip module used
R&S®RT-ZMA10	solder-in ³⁾	⁴⁾	±2.5 V (10:1), ±0.5 V (1:1)
R&S®RT-ZMA12	square-pin ³⁾	⁴⁾ , max. 6 GHz	±2.5 V (10:1), ±0.5 V (1:1)
R&S®RT-ZMA14	flex solder-in ³⁾	⁴⁾	±2.5 V (10:1), ±0.5 V (1:1)
R&S®RT-ZMA15	quick-connect ³⁾	⁴⁾	±2.5 V (10:1), ±0.5 V (1:1)
R&S®RT-ZMA30	browser ³⁾	⁴⁾	±2.5 V (10:1), ±0.5 V (1:1)
R&S®RT-ZMA40	SMA ³⁾	⁴⁾ , max. 6 GHz	±2.5 V (10:1), ±0.5 V (1:1)
R&S®RT-ZMA50	extreme temperature solder-in ³⁾	⁴⁾ , max. 2.5 GHz	±2.5 V (10:1), ±0.5 V (1:1)
R&S®RT-ZPR20/40	active, single-ended, 1:1 ¹⁾	2 GHz/4 GHz	±850 mV
R&S®RT-ZVC02/04	multichannel power probe	1 MHz	±1.8 V to ±15 V, ±4.5 µA to ±10 A
R&S®RT-ZH10	passive, single-ended, 100:1	400 MHz	1 kV (RMS)
R&S®RT-ZH11	passive, single-ended, 1000:1	400 MHz	1 kV (RMS)
R&S®RT-ZI10C	passive, single-ended, 10:1, isolated, compact	500 MHz	300 V CAT III
R&S®RT-ZI11	passive, single-ended, 100:1, isolated	500 MHz	600 V CAT IV, 1000 V CAT III, 3540 V CAT 0
R&S®RT-ZHD07	active, differential, 25:1/250:1 ^{1), 2)}	200 MHz	±750 V (peak)
R&S®RT-ZHD15/16	active, differential, 50:1/500:1 ^{1), 2)}	100 MHz/200 MHz	±1500 V (peak)
R&S®RT-ZHD60	active, differential, 100:1/1000:1 ^{1), 2)}	100 MHz	±6000 V (peak)
R&S®RT-ZC02	AC/DC two range current probe	20 kHz	100 A (RMS), 1000 A (RMS), 0.01 V/A, 0.001 V/A switchable
R&S®RT-ZC03	AC/DC current probe	100 kHz	20 A (RMS), ±30 A (peak), 0.1 V/A
R&S®RT-ZC05B	AC/DC current probe ¹⁾	2 MHz	500 A (RMS), ±700 A (peak), 0.01 V/A
R&S®RT-ZC10/B	AC/DC current probe ¹⁾	10 MHz	150 A (RMS), ±300 A (peak), 0.01 V/A
R&S®RT-ZC15B	AC/DC current probe ¹⁾	50 MHz	30 A (RMS), ±50 A (peak), 0.1 V/A
R&S®RT-ZC20/B	AC/DC current probe ¹⁾	100 MHz	30 A (RMS), ±50 A (peak), 0.1 V/A
R&S®RT-ZC30	AC/DC high-sensitivity current probe	120 MHz	5 A (RMS), ±7.5 A (peak), 1 V/A
R&S®RT-ZC31	AC/DC three range current probe	120 MHz	30 A (RMS), ±50 A (peak), 0.1 V/A, 1 V/A, 10 V/A switchable
R&S®HZ-15	passive E and H near-field probe set	30 MHz to 3 GHz	N/A
R&S®HZ-17	compact H near-field probe set	30 MHz to 3 GHz	N/A

¹⁾ Includes Rohde&Schwarz probe interface. ²⁾ Includes R&S®ProbeMeter and micro button for instrument control.

³⁾ Tip module for R&S®RT-ZMxx probes.

⁴⁾ Depends on amplifier module.

POWER SUPPLIES

Number of channels

Depending on the application and requirements, you can select a power supply unit with 1, 2, 3 or 4 channels.

In many cases, a single output will be sufficient. However, multi-output supplies can deliver important advantages in applications that require, for example, +15 V and -15 V simultaneously. A multi-output supply with independently controllable outputs is usually more versatile than a set of individual supplies. Using a single multi-output supply significantly reduces costs.

Output power

The maximum power is determined by the maximum voltage and current demanded by the device. All multichannel Rohde&Schwarz power supplies allow parallel and serial operation to achieve higher voltage/current output.

Readback measurements and sense lines

Modern power supplies include a multimeter that measures the voltage/current consumed by the device under test (DUT). The readback accuracy and resolution specifies the accuracy and resolution of these measurements.

The output cables that connect a power supply's output to its load have some resistance, and as current flow increases there will be a voltage drop across the cables. The sense lines connected from the supply to the load compensate for these unwanted voltage drops since the voltage can be measured directly at the DUT.

Most Rohde&Schwarz power supplies are equipped with sense lines.

Protection functions

To safeguard the instrument and the DUT, Rohde&Schwarz power supplies provide a variety of protection functions.

Depending on the model, users can separately set the maximum current (electronic fuse, overcurrent protection, OCP), the maximum voltage (overvoltage protection, OVP) and the maximum power (overpower protection, OPP) for each channel. When such a limit is reached, the affected output channel will be switched off.

Overtemperature protection prevents the instrument from overheating.

Products	Page
R&S°NGE100B power supply series	34
R&S°NGA100 power supply series	36
R&S°NGC100 power supply series	38
R&S°HMP power supply series	40
R&S°NGP800 power supply series	42
R&S°NGL200 high precision power supply series	44
R&S°NGM200 high precision power supply series	46
R&S°NGU source measure units	48

Power supply portfolio



	Basic units R&S®NGE102B/103B	R&S®NGA101/102/141/142	Performance units R&S®HMP2020/2030	R&S®HMP4030/4040
Electrical specifications				
Number of output channels	2/3	1/2	2/3	3/4
Maximum output power	66 W/100 W	40 W/80 W/40 W/80 W	188 W	384 W
Maximum output power per channel	33.6 W	40 W	80 W, except R&S®HMP2020, CH1: 160 W	160 W
Output voltage per channel	0 V to 32 V	R&S®NGA101/102: 0 V to 35 V R&S®NGA141/142: 0 V to 100 V	0 V to 32 V	0 V to 32 V
Maximum output current per channel	3 A	R&S®NGA101/102: 6 A R&S®NGA141/142: 2 A	5 A, except R&S®HMP2020, CH1: 10 A	10 A
Voltage ripple and noise (RMS) (20 Hz to 20 MHz)	< 1.5 mV (typ.)	R&S®NGA101/102: < 0.5 mV (meas.); R&S®NGA141/142: < 1.5 mV (meas.)	< 1.5 mV (meas.)	< 1.5 mV (meas.)
Current ripple and noise (RMS) (meas.) (20 Hz to 20 MHz)	< 2 mA	< 500 µA	< 1 mA	< 1 mA
Load recovery time ¹⁾ (meas.)	< 200 µs	R&S®NGA101/102: < 100 µs; R&S®NGA141/142: < 50 µs	< 1 ms	< 1 ms
Programming/readback resolution				
Voltage	10 mV	1 mV	1 mV	1 mV
Current	1 mA	programming: 1 mA readback: 0.1 mA	< 1 A: 0.1 mA (10 A CH: 0.2 mA); ≥ 1 A: 1 mA	< 1 A: 0.2 mA; ≥ 1 A: 1 mA
Readback accuracy (± (% of output + offset))				
Voltage	< 0.1% + 20 mV	R&S®NGA101/102: 0.02% + 5 mV R&S®NGA141/142: 0.02% + 10 mV	< 0.05% + 5 mV	< 0.05% + 5 mV
Current	< 0.1% + 5 mA	< 0.03% + 500 µA	< 0.1% + 2 mA	< 0.1% + 2 mA
Special functions				
Measurement functions	voltage, current, power	voltage, current, power	voltage, current	voltage, current
Protection functions	OVP, OCP, OPP, OTP	OVP, OCP, OPP, OTP	OVP, OCP, OTP	OVP, OCP, OTP
FuseLink function	•	• (R&S®NGA102/142)	•	•
Fuse delay	•	•	•	•
Remote sensing	–	•	•	•
Sink mode	–	–	–	–
Output delay	–	–	–	–
Trigger input/output	o/o	o/o	–	–
Arbitrary function	• (CH1: EasyArb)	• (CH1: EasyArb)	• (EasyArb)	• (EasyArb)
Analog/modulation interface	–	–	–	–
Data logging	–	• (standard mode)	–	–
Display and interfaces				
Display	3.5" QVGA	3.5"/QVGA	240 × 64 pixel LCD	240 × 128 pixel LCD
Rear panel connections	–	8-pin connector block	4-pin connector block per channel	8-pin connector block per 2 channels
Remote control interfaces	standard: USB; optional: LAN	standard: USB, LAN	optional: USB, LAN, IEEE-488 (GPIB), RS-232	optional: USB, LAN, IEEE-488 (GPIB), RS-232
General data				
Dimensions (W × H × D)	222 × 97 × 310 mm	222 × 97 × 448 mm	285 × 93 × 405 mm	285 × 136 × 405 mm
Weight	4.9 kg/5.0 kg	6.6 kg/7.0 kg/6.9 kg/7.3 kg	7.8 kg/8.0 kg	12.4 kg/12.8 kg
Rack adapter	R&S®HZC95 option	R&S®HZN96 option	R&S®HZ42 option	R&S®HZP91 option

All data valid at +23°C (–3°C/+7°C) after 30 minutes warm-up time.

¹⁾ 10% to 90% load change within a band of ±20 mV of set voltage.

²⁾ In the most sensitive measurement range.

• yes – no o optional



R&S®NGP802/822/804/814/824	Specialty units R&S®NGL201/NGL202	R&S®NGM201/202	R&S®NGU201/411/401
2/4	1/2	1/2	1
400 W/800 W	60 W/120 W	60 W/120 W	60 W/20 W/60 W
200 W	60 W	60 W	60 W/20 W/60 W
0 V to 32 V (32 V channels); 0 V to 64 V (64 V channels)	0 V to 20 V	0 V to 20 V	R&S®NGU201: 0 V to 20 V (R&S®NGU411: ≤ 10 V: 2 A) R&S®NGU411/401: -20 V to +20 V (R&S®NGU411: > 10 V: 1 A)
20 A (32 V channels); 10 A (64 V channels)	≤ 6 V output voltage: 6 A; > 6 V output voltage: 3 A	≤ 6 V output voltage: 6 A; > 6 V output voltage: 3 A	≤ 6 V output voltage: 8 A; > 6 V output voltage: 3 A
< 3 mV (meas.)	< 500 μV (meas.)	< 500 μV (meas.)	< 500 μV (meas.)
< 3.5 mA	< 1 mA	< 1 mA	< 1 mA
< 400 μs	< 30 μs	< 30 μs	< 30 μs
1 mV	1 mV/10 μV	1 mV/5 μV ²⁾	50 μV/1 μV ³⁾
0.5 mA	0.1 mA/10 μA	0.1 mA/10 nA ³⁾	100 nA/100 pA ³⁾
< 0.05% + 5 mV (32 V channels); < 0.05% + 10 mV (64 V channels)	< 0.02% + 2 mV	< 0.02% + 500 μV ³⁾	< 0.02% + 500 μV ³⁾
< 0.1% + 20 mA (32 V channels); < 0.1% + 10 mA (64 V channels)	< 0.05% + 250 μA	< 0.05% + 15 μA ³⁾	< 0.025% + 15 nA ³⁾
voltage, current, power, energy OVP, OCP, OPP, OTP	voltage, current, power, energy OVP, OCP, OPP, OTP	voltage, current, power, energy OVP, OCP, OPP, OTP	voltage, current, power, energy OVP, OCP, OPP, OTP
•	• (R&S®NGL202)	• (R&S®NGM202)	–
•	•	•	•
•	•	•	•
–	•	•	•
•	• (R&S®NGL202)	• (R&S®NGM202)	–
o/o	o/o	o/o	o/o
• (QuickArb)	• (QuickArb)	• (QuickArb)	• (QuickArb)
o/–	–	–	R&S®NGU411/ 401: modulation interface
• (standard mode)	• (standard mode)	• (standard and fast mode)	• (standard and fast mode)
TFT 5" 800 × 480 pixel WVGA touch	TFT 5" 800 × 480 pixel WVGA touch	TFT 5" 800 × 480 pixel WVGA touch	TFT 5" 800 × 480 pixel WVGA touch
8-pin connector block per 2 channels	8-pin connector block per channel	8-pin connector block per channel	8-pin connector block
standard: USB, LAN; optional: IEEE-488 (GPIB)	standard: USB, LAN; optional: IEEE-488 (GPIB)	standard: USB, LAN; optional: IEEE-488 (GPIB)	standard: USB, LAN; optional: IEEE-488 (GPIB)
362 × 100 × 451 mm	222 × 97 × 436 mm	222 × 97 × 436 mm	222 × 97 × 436 mm
7.5 kg/8.0 kg	7.1 kg/7.3 kg	7.2 kg/7.4 kg	7.1 kg
R&S®ZZA-GE23 option	R&S®HZN96 option	R&S®HZN96 option	R&S®HZN96 option

R&S®NGE100B Power Supply Series



Meets your daily needs

What sets these power supplies apart from others in their class?

- ▶ All channels are galvanically isolated and earth-free
- ▶ All channels are electrically equivalent with the same voltage, current and power
- ▶ Parallel and serial operation
- ▶ Protection functions to safeguard instrument and DUT
- ▶ Tracking and link functions
- ▶ Remote control via USB interface and optional LAN

Model overview

Model	Channel count	Maximum voltage	Maximum current	Maximum power	Resolution
R&S®NGE102B	2	2 × 32 V	2 × 3 A	66 W	10 mV/1 mA
R&S®NGE103B	3	3 × 32 V	3 × 3 A	100 W	10 mV/1 mA

Important facts

Specification	R&S®NGE100	Why this is important
Interface options	USB, LAN (optional) Wi-Fi® (optional)	Modern and common interface capabilities allow quick and ready access to control and program the instrument.
Dimensions	½ 19" 2 HU	A small footprint for the power supply allows placement in tight lab space conditions or university settings as well as high-density manufacturing and rack applications.
Arbitrary function generation	EasyArb	Easily programmable time/voltage or time/current curves.

Scope of delivery

- ▶ Power cable
- ▶ Quick start guide
- ▶ 3 year warranty

Recommended options/accessories

Description	Type
Base unit	
Two-channel power supply	R&S®NGE102B
Three-channel power supply	R&S®NGE103B
Software options	
Ethernet remote control	R&S®NGE-K101
Digital I/O trigger	R&S®NGE-K103
System components	
19" rack adapter, 2 HU	R&S®HZC95



The perfect choice for:	
Education	R&D
Maintenance and repair	Manufacturing test

Your benefit	Features
Straightforward operation	All basic functions can be operated via direct keys on the front panel. The rotary knob can be used to adjust the desired voltage and current
The separate output channels can work like individual power supplies	All channels are electrically equivalent, galvanically isolated, earth-free and can be combined in serial or in parallel to achieve higher voltages or currents
Small, compact and quiet	Combination of primary transformer, secondary switching regulator and additional linear control reduces weight and size while maintaining robustness and low ripple

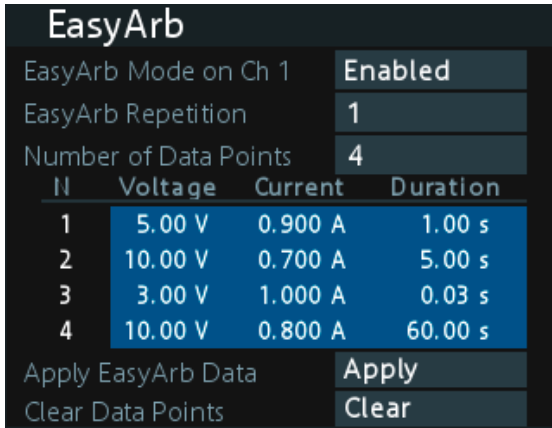

Comfort features for special applications: EasyArb allows the user to program time/voltage or time/current sequences

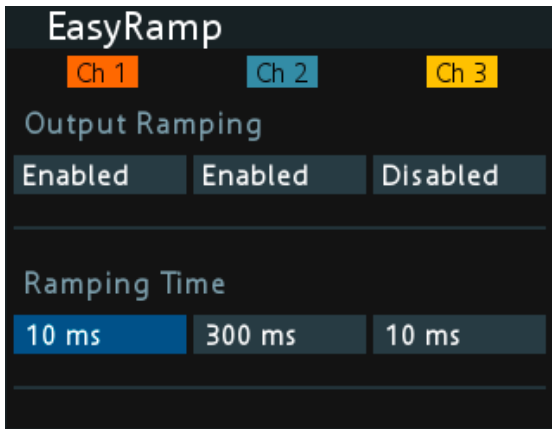

Comfort features for special applications: EasyRamp simulates operating conditions with controlled rise of supply voltage to prevent a sudden voltage surge

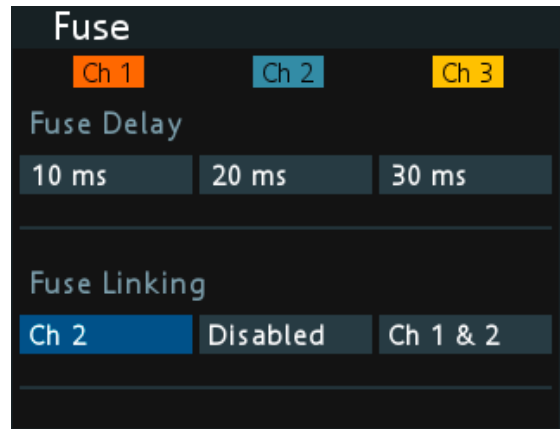

Users can set the power supply so that all channels are switched off if one channel hits the limit; or it can be set to leave one channel working

Parallel and serial operation

Running in parallel, higher currents can be achieved; serial connected channels yield higher voltages.

Parallel operation: max. 9 A

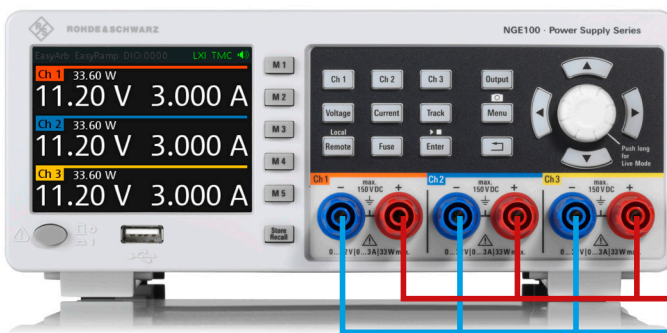

Serial operation: max. 96 V

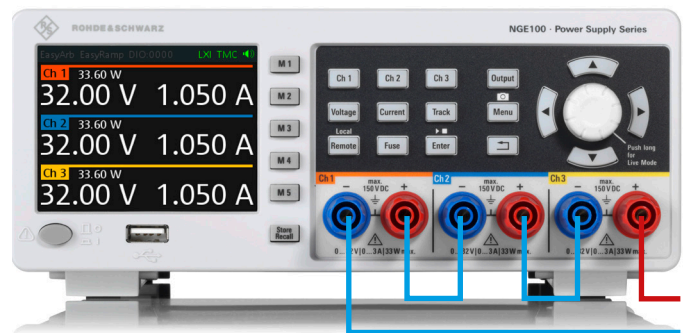

R&S®NGA100 Power Supply Series



Linear. Accurate. Affordable.

The R&S®NGA100 power supplies are linear, compact and easy to use. All models have excellent readback accuracy with a low-current range for demanding measurements.

Features such as data logging, arbitrary waveforms, built-in statistics and remote sensing make the instruments ideal for various bench applications. Equipped with a number of different remote interfaces, including USB and Ethernet, the R&S®NGA100 power supplies are also great for automated tests. Advanced protective functions keep devices connected and power supplies safe.

Model overview

Model	Channels	Maximum output power	Maximum voltage	Maximum current	Ripple and noise (20 Hz to 20 MHz)	Readback accuracy
R&S®NGA101	1	40 W	35 V	6 A	< 0.5 mV (RMS), < 500 µA (RMS)	< 0.02% + 5 mV, < 0.03% + 500 µA
R&S®NGA102	2	80 W	70 V (serial)	12 A (parallel)	< 1.5 mV (RMS), < 500 µA (RMS)	< 0.02% + 10 mV, < 0.03% + 500 µA
R&S®NGA141	1	40 W	100 V	2 A	< 0.5 mV (RMS), < 500 µA (RMS)	< 0.02% + 5 mV, < 0.03% + 500 µA
R&S®NGA142	2	80 W	200 V (serial)	4 A (parallel)	< 1.5 mV (RMS), < 500 µA (RMS)	< 0.02% + 10 mV, < 0.03% + 500 µA

Important facts

Specification	R&S®NGA100	Why this is important
Readback accuracy	<ul style="list-style-type: none"> voltage <ul style="list-style-type: none"> - R&S®NGA101, R&S®NGA102: < 0.02% + 5 mV - R&S®NGA141, R&S®NGA142: < 0.02% + 10 mV current: < 0.03% + 500 µA 	The R&S®NGA100 can accurately measure and replicate the actual power consumption for a device, even at low voltage and current levels. This simplifies the setup by reducing the need for external multimeters.
Ripple and noise (20 Hz to 20 MHz)	<ul style="list-style-type: none"> voltage <ul style="list-style-type: none"> - R&S®NGA101, R&S®NGA102: < 0.5 mV (RMS) - R&S®NGA141, R&S®NGA142: < 1.5 mV (RMS) current: < 500 µA (RMS) 	Allows the supply of interference-free voltage to sensitive DUTs with advanced electronic circuitry that is often sensitive to interference on supply lines.
Maximum output power	80 W	Increased output power enables the driving of DUTs with greater power consumption.

Scope of delivery

- ▶ Power cable
- ▶ Quick start guide
- ▶ 3 year warranty

Recommended options/accessories

Description	Type
Software options	
Digital trigger I/O	R&S®NGA-K103
System components	
19" rack adapter, 2 HU	R&S®HZN96









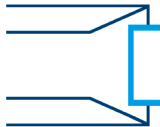

The perfect choice for:	
R&D	Manufacturing
IoT and low-power designs	General purpose and education

Your benefit	Features
Linear design	The linear design of the output stages allows R&S®NGA100 power supplies to operate with minimal residual ripple and noise for extremely stable output voltage and current.
FlexPower	The R&S®NGA100 power supplies operate with maximum power at various operating points and cover far more applications than single-range power supplies.
Channel fusion	Activate channel fusion in either serial or parallel mode and the device will act like a single-channel version of itself with double voltage or current capabilities.
Low-current measurement range	IoT devices can have multiple sleep modes with very low current consumption. To accurately determine these operating states, R&S®NGA100 power supplies have a low-current measurement range.

Power supplies

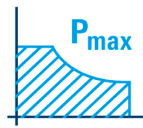
Features

 EasyRamp	 Channel fusion	 EasyArb	 Remote sensing	 Built-in measurements
 Data logging	 Save/recall device settings	 FlexPower	 Digital trigger I/O	 High accuracy

R&S®NGA101/R&S®NGA102 FlexPower curve per output

The R&S®NGA100 series operates with maximum power at various operating points and covers far more applications than single-range power supplies.

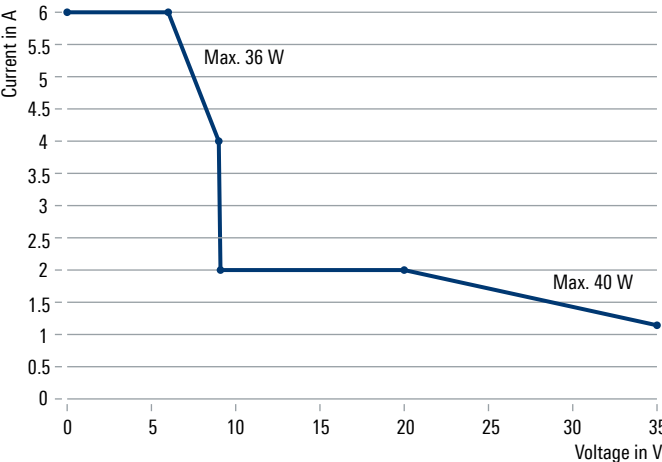

Channel fusion

Activate channel fusion in either serial or parallel mode and the device will act like a single-channel version of itself. In serial mode, the outputs are connected internally, while the parallel mode requires external wiring.

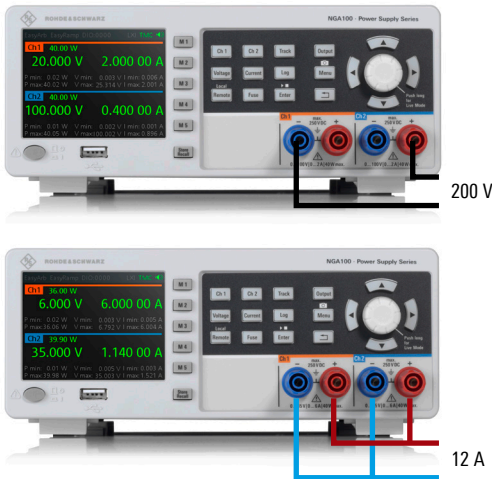

R&S®NGC100 Power Supply Series



New



Compact and easy to use

One, two or three channels – R&S®NGC100 power supply specifications and wide range of functions make them ideal for development labs and industrial environments. Thanks to their high energy efficiency, the power supplies remain cool and quiet, even at maximum load. Practical interfaces and connectors let users work quickly and conveniently with the R&S®NGC100 series – even in 19" racks.

Model overview

Model	Channels	Maximum output power per channel	Maximum output current per channel	Output voltage per channel	Maximum output power	Ripple and noise (20 Hz to 20 MHz)	Programming resolution	Readback resolution
R&S®NGC101	1	100 W	10 A	0 V to 32 V	100 W	< 450 μ V (RMS), < 4 mV (peak-to-peak) (meas.)	1 mV/1 mA	1 mV/0.1 mA
R&S®NGC102	2	50 W	5 A					
R&S®NGC103	3	33 W	3 A					

Important facts

Specification	R&S®NGC100	Why this is important
Readback accuracy	1 mV/0.1 mA	The R&S®NGC100 can accurately measure and replicate actual device power consumption, even at low voltage and current levels. This simplifies the setup by reducing the need for external multimeters.
Ripple and noise (20 Hz to 20 MHz)	< 450 μ V (RMS), < 4 mV (peak to peak) (meas.)	Allows the instrument to supply interference-free voltage to sensitive DUTs with advanced electronic circuitry which often reacts to supply line interference.

Scope of delivery

- ▶ Power cable
- ▶ Quick start guide
- ▶ 3 year warranty

Recommended options/accessories

Description	Type
Single-channel power supply	R&S®NGC101
Single-channel power supply, GPIB	R&S®NGC101-G
Two-channel power supply	R&S®NGC102
Two-channel power supply, GPIB	R&S®NGC102-G
Three-channel power supply	R&S®NGC103
Three-channel power supply, GPIB	R&S®NGC103-G
19" rack adapter, 2 HU, for one or two R&S®NGC100 power supplies	R&S®HZC95



The perfect choice for:	
Engineering labs	Production testing
Education	Maintenance and repair

Remote sensing

Improve voltage regulation and measurement accuracy with remote sensing that regulates the output voltage directly at the DUT input terminals instead of the power supply output terminals. The remote sensing function compensates for voltage drops over the supply leads – especially in applications with high current consumption. The R&S®NGC100 power supplies provide separate sense lines for each output channel.

Data logging

Logging data is key to long-term monitoring, reviewing test setups and repeating test conditions when analyzing power behavior and optimizing power consumption. The R&S®NGC100 power supplies simultaneously log voltage and current measurements over time on all outputs with a maximum acquisition time of 1000 sample/s. Easily export the time-stamped data as a CSV file for analysis, reports and documentation.



Ideal for industrial environments: Power supply units in industrial production are often found in 19" racks. All R&S®NGC100 models can be integrated into 19" racks with the R&S®HXC95 rackmount adapters.

FlexPower: Get maximum power at various operating points.

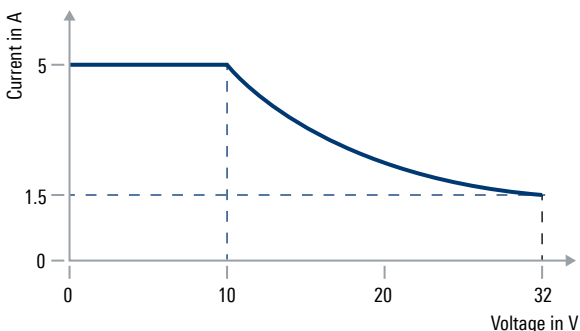

Your benefit	Features
All measured parameters clearly displayed	The brilliant color display shows voltage, current and power values in real time.
Flexible channel configurations for up to 96 V	All channels are galvanically isolated and can be combined to drive balanced circuitries or for higher voltages/currents.
Safe working environment	<ul style="list-style-type: none"> ▶ FuseLink allows you to freely combine the electronic fuses in each channel ▶ A fuse delay can be set to prevent the power supply from switching off prematurely due to a short current spike ▶ Fan speed is automatically adjusted to the load condition, allowing you to work in a quiet environment
Emulate real-world scenarios	Arbitrary waveforms can be generated for voltage and current. This function can be configured and executed via the control panel or an external interface.
Control inrush currents	Increase the output voltage continuously within a timeframe of 10 ms to 10 s with the EasyRamp function.

Power supplies

Arbitrary functions

Emulate the normal behavior of your power subsystems early in the design process and simulate power problems for DUT design verification.

The EasyArb function lets you generate complex time-varying voltage and current sequences of output changes with dwell times down to 10 ms.

External trigger events

An external trigger signal (TTL) to the voltage interface on the back panel of the instrument can start an arbitrary function, activate and deactivate output delays and activate data logging.



WAGO cage clamp: To facilitate typical calibration setups, the rear panel connector was designed with a WAGO cage clamp.

R&S®HMP Power Supply Series



Up to four channels in a single instrument

The R&S®HMP power supplies are primarily designed for industrial use – for production environments as well as for development labs. These rugged instruments offer high efficiency with low residual ripple and many protection functions.

- ▶ Four models: 2 or 3 channels with 188 W total output power, 3 or 4 channels with 384 W total output power
- ▶ Galvanically isolated, floating outputs with overload and short-circuit protection
- ▶ Remote sensing eliminates voltage drops on the load leads
- ▶ Comfortable programming features and 19" rack adapters ensure perfect integration into production environments

Model overview

Model	No. of channels	Output voltage per channel	Output current per channel	Total output power	Maximum output power per channel	Maximum voltage in serial operation	Maximum current in parallel operation
R&S®HMP2020	2		CH1: 0 A to 10 A CH2: 0 A to 5 A	188 W	CH1: 160 W CH2: 80 W	64 V	15 A
R&S®HMP2030	3	0 V to 32 V	0 A to 5 A	188 W	80 W	96 V	15 A
R&S®HMP4030	3		0 A to 10 A	384 W	160 W	96 V	30 A
R&S®HMP4040	4		0 A to 10 A	384 W	160 W	128 V	40 A

Important facts

Specification	R&S®HMP2020/2030; R&S®HMP4030/4040	Why this is important
Number of output channels	2/3; 3/4	More channels in a compact package provide more flexibility for any specific application, especially with equal channels.
Total output power	max. 188 W; max. 384 W	With more output power, DUTs with more power consumption can be driven.
Maximum output power per channel	80 W (R&S®HMP2020: 160 W); 160 W	Same output power on all channels provides more flexible configuration in specific applications.
Maximum output voltage	32 V (all channels); 32 V (all channels)	With the same output voltage on each channel, there are no limitations for using channels in different applications.
Maximum current per channel	5 A (R&S®HMP2020: 10 A); 10 A	With the same output current on each channel, there are no limitations for using channels in different applications.
Sense function	•, for each channel	Sense function provides more accurate voltage at the DUT especially when high current is needed.
Dimensions (W × H × D)	285 mm × 95 mm × 405 mm; 285 mm × 136 mm × 405 mm	The size of the instrument determines how much space is left on the workbench for the measurement setup.
Weight	7.8 kg/8.0 kg; 12.4 kg/12.8 kg	If the instrument has to be used in different places, it is better to have a lighter instrument.

Scope of delivery

- ▶ Quick start guide
- ▶ Set of power cables
- ▶ 3 year warranty

Recommended options/accessories

Description	Type
Interfaces and system components	
Dual interfaces (RS-232/USB)	R&S®HO720, R&S®HO732
IEEE-488 (GPIB) interface	R&S®HO740
19" rack adapter, 2 HU, for R&S®HMP2020/HMP2030	R&S®HZ42
19" rack adapter, 4 HU, for R&S®HMP4030/HMP4040	R&S®HZIP91



The perfect choice for:	
Engineering lab	Production testing
Maintenance and repair	General purpose

Your benefit	Features
Up to 4 channels in a single compact box	Flexible configuration for any specific application, including sense lines for each channel to compensate voltage drops over the supply leads
Channels galvanically isolated and floating	Serial operation with up to 128 V or parallel operation with up to 40 A
Overcurrent protection (electronic fuse) and overvoltage protection	To safeguard the instrument and the DUT. The fuse link technology switches off all selected channels when one of them reaches its current limit
Easily programmable time/voltage or time/current curves	To vary voltage or current during a test sequence; can be programmed manually via the user interface or via the external interfaces

Power supplies



Connections for all channels – including sense lines – are also provided on the rear panel (shown here: R&S®HMP4040)

All channels galvanically isolated and floating

The R&S®HMP power supply family consists of instruments with two, three or four channels. The circuitry of each channel is completely isolated from the others; there is no connection to chassis ground. This makes it easy to combine the channels to drive balanced circuitries that might need +12 V/–12 V, for example, and avoids any ground problems in complex DUTs.

Supplying balanced circuits

Two channels can be connected together to supply balanced circuits with e.g. +12 V/–12 V.

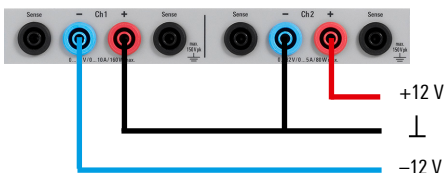

Intuitive to use

All basic R&S®HMP power supply functions can be operated directly via keys on the front panel. It is only necessary to use the menu level for special functions that are needed less frequently.

Color coding of operating states

All settings and operating conditions, including the output power and the status of the protection functions, are shown on the display and indicated by the colors of the illuminated channel keys. The colors of the illuminated keys indicate the different operating conditions:

- ▶ Active channel in constant voltage mode: green
- ▶ Active channel in constant current mode: red
- ▶ Channel in setting mode: blue

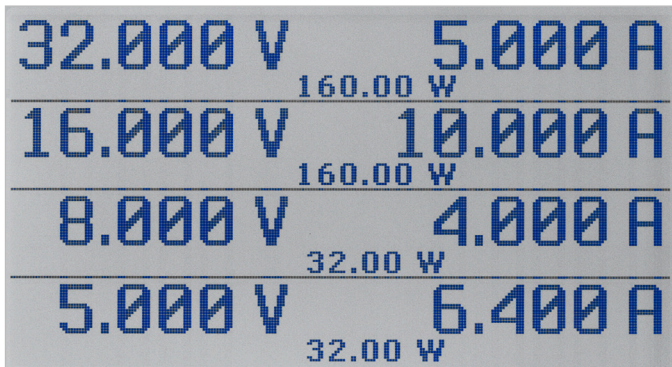

All settings and operating states are clearly visualized. Constant voltage mode is indicated by a green key, constant current mode is indicated by a red key. The key color changes to blue in setting mode.

R&S®NGP800 Power Supply Series



Boost your efficiency with quad-core power

The R&S®NGP800 DC power supply series, comprising five models with 400 W or 800 W, provides maximum power at a variety of operating points. The two or four 200 W outputs can each supply up to 64 V or up to 20 A. Electrically equivalent and galvanically isolated outputs can be wired in series or parallel for up to 250 V or 80 A.

All R&S®NGP800 power supplies include remote sense terminals, USB and a LAN interface. A user-installable GPIB interface, a digital trigger I/O, an analog input and a wireless LAN interface are optional, making these instruments great on the bench in automated test systems.

Model overview

Model	Channel count	Total output power	Readback resolution	Voltage per channel	Output current per channel	Output power per channel
R&S®NGP802	2	400 W	▶ voltage: 1 mV ▶ current: 0.5 mA	0 V to 32 V	20 A	200 W
R&S®NGP804	2	400 W		0 V to 32 V	20 A	200 W
R&S®NGP814	4	800 W		▶ CH1, CH2: 0 V to 32 V ▶ CH3, CH4: 0 V to 64 V	▶ CH1, CH2: 20 A ▶ CH3, CH4: 10 A	200 W
R&S®NGP822	2	400 W		0 V to 64 V	10 A	200 W
R&S®NGP824	4	800 W		0 V to 64 V	10 A	200 W

Important facts

Specification	R&S®NGP800	Why this is important
Maximum output power	400 W/800 W	For power hungry devices.
Number of outputs	2/4	Powers up to 4 DUTs simultaneously.
Maximum voltage per output	32 V/64 V	Covers 48 V applications.
Maximum current per output	20 A/10 A	Meets high current consumption requirements.
Maximum power per output	200 W	Gets the full 200 W on each output (no shared total power among channels).
Programming resolution	1 mV/0.5 mA	Accurately sets your supply voltage and current.
Readback resolution	1 mV/0.5 mA	Replaces a DMM in many applications.
Acquisition rate	125 sample/s	Great for in-depth post analysis.
Display	5" 800 × 480 pixel touch	Enter values much faster with intuitive touch display.

Scope of delivery

- ▶ Power cable
- ▶ Terminal blocks
- ▶ Quick start guide
- ▶ 3 year warranty

Recommended options/accessories

Description	Type
Hardware option	
IEEE-488 (GPIB) interface	R&S®NG-B105
Software options	
Digital I/O trigger	R&S®NGP-K103
Analog input	R&S®NGP-K107
System components	
19" rack adapter, 2 HU	R&S®ZZA-GE23



The perfect choice for:	
R&D	Manufacturing
Automotive	General purpose

Your benefit	Features
Power four DUTs simultaneously	<ul style="list-style-type: none"> ▶ Up to four independent, floating outputs ▶ All outputs galvanically isolated ▶ Space, cost and time efficient
Maximum power at various operating points	<ul style="list-style-type: none"> ▶ FlexPower ▶ Up to 80 A when connected in parallel ▶ Up to 250 V when connected in series
All you need at a glance	<ul style="list-style-type: none"> ▶ Large high-resolution touchscreen ▶ Built-in measurements ▶ Detailed statistics

Power supplies

More functions



EasyRamp



Output delay



QuickArb

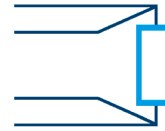

Remote sensing



Built-in measurements



Data logging



Save/recall device settings

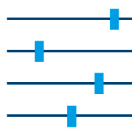

User adjustment



Digital trigger I/O

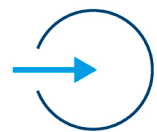

Analog input



Large high-resolution touchscreen: The home screen gives you a clear overview of all your channels. Each channel can be selected for a more detailed view with a wide variety of additional information such as statistics and icons indicating the status of set protection levels or special functions.

Parallel and serial operation

In case your application requires more voltage or current, connect the outputs in series or parallel and get up to 250 V (R&S®NGP824) or 80 A (R&S®NGP804). Using the tracking function, voltage and current are adjusted on all selected channels simultaneously.

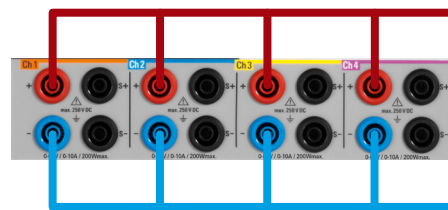

Parallel operation:
max. 80 A

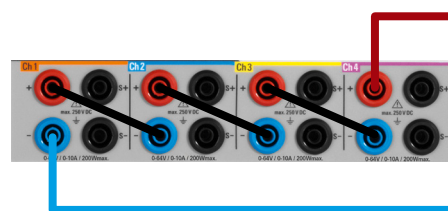

Serial operation:
max. 250 V

R&S®NGL200 High Precision Power Supply Series



What sets these power supplies apart from others?

- ▶ Fast regulation of output voltage with minimum overshoot and very fast load recovery time
- ▶ Minimum residual ripple and noise to supply interference-free voltage to sensitive DUTs
- ▶ Readings with up to 6½ digit resolution are perfect for characterizing devices that have low power consumption in standby mode and high current in full load operation
- ▶ Two quadrants: operates as source or sink

Model overview

Model	Number of channels	Maximum output power	Output power per channel	Output voltage per channel	Output current per channel	Load recovery time	Programming resolution
R&S®NGL201	1	60 W	max. 60 W	0 V to 20 V	▶ ≤ 6 V: 6 A ▶ > 6 V: 3 A	< 30 μs	1 mV/0.1 mA
R&S®NGL202	2	120 W					

Important facts

Specification	R&S®NGL200	Why this is important
Large high-resolution touchscreen	TFT 5" 800 × 480 pixels WVGA touch	Easy operation and display of a wide variety of additional information such as power values and statistics.
Various protection and safety functions	OVP, OCP, OPP, OTP, adjustable limits	Protect your DUT and the power supply.
Sense function for lead resistance compensation	▶ R&S®NGL201: front and rear panels ▶ R&S®NGL202: rear panel	Regulate the voltage directly at the load, compensating for voltage drops over the supply leads.
QuickArb	▶ dwell time: 1 ms to 10 h ▶ maximum number of points: 4096	Simulate different battery charging conditions or program very short voltage drops to test the power-up behavior of a DUT.
Remote control via various interfaces	USB, Ethernet, IEEE-488 (optional)	Key for integration into test systems and automated operation via scripts.
Fast command processing time	< 6 ms (nom.)	Complex measurement sequences require ever faster setting, measuring and command processing times.

Scope of delivery

- ▶ Power cord
- ▶ Quick start guide
- ▶ 3 year warranty

Optimized load recovery time

Power supplies usually respond to abrupt load changes with overshoot and slow recovery times. Thanks to specially optimized control circuits, the R&S®NGL200 series achieves recovery times of < 30 μs with minimal overshoot, making them perfect for supplying sensitive components.

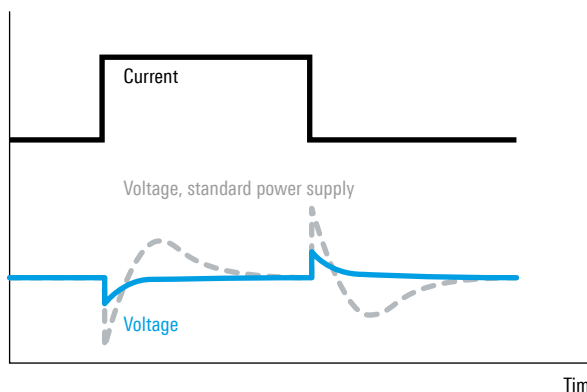

The perfect choice for:	
Battery tests	Power consumption tests
Simulation of voltage drops	Supplying sensitive designs

Overvoltage protection (OVP), overpower protection (OPP)

If the voltage/power exceeds the configured maximum value, the channel is switched off and the corresponding symbol flashes on the display.

Overcurrent protection (electronic fuse, OCP)

The channels of R&S®NGL200 power supplies provide electronic fuses that can be set individually. If the channel current exceeds the set current, the channel is automatically switched off and a message is displayed.

QuickArb function

The Arb function lets you configure time/voltage or time/current sequences. With up to 4096 points and a dwell time resolution of up to 1 ms, the QuickArb function sets new standards.

Easy Ramp function

The output voltage can be increased continuously within a time frame of 10 ms to 10 s to avoid an abrupt rise of the supply voltage as is sometimes required by sensitive applications.

Your benefit	Features
Optimized load recovery time with minimal overshoot	Due to the optimized load recovery time of < 30 μs with minimal overshoot during challenging load conditions, the R&S®NGL200 is perfect when testing IoT and other battery-powered devices which require very little current in sleep mode and abruptly increase current when switching to transmit mode.
Low ripple and noise	To supply interference-free voltage to sensitive designs such as complex semiconductors and to support the development of power amplifiers and MMICs.
Sink and source operation	The linear two-quadrant output amplifier design of the R&S®NGL200 enables sink and source operation to simulate batteries and loads.
6½ digit resolution	With up to 6½ digit resolution when measuring voltage, current and power, the R&S®NGL200 is optimal for characterization of devices with low standby power consumption and high current in full load operation. It can replace an additional DMM in many applications.

Power supplies



Easy operation: The high-resolution capacitive touchscreen is the central operating element for R&S®NGL200 power supplies. Icons clearly show the status of the set protection levels or special functions. Active channels in constant voltage mode light up green, while red is used for constant current mode. When the channels are switched on, the key lights up blue (active).



Readings with up to 6½ digit resolution: With a resolution of up to 6½ digits when measuring voltage, current and power, the R&S®NGL200 power supplies are perfect for measurements on devices that have low power consumption in standby mode and high current in full load operation. The large high-resolution display provides a lot of additional information such as power values and statistics.

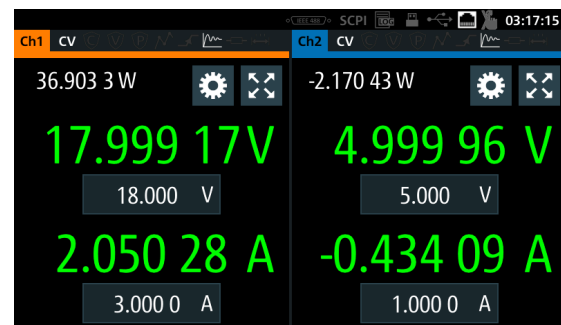

Two-quadrant operation, minimum ripple and noise: The architecture of the R&S®NGL200 power supplies allows them to function both as a source and a sink. The power automatically switches from sink and source mode. In this example, CH2 is operating as a load. The linear design of the output stages reduces residual ripple and noise to a minimum and makes the R&S®NGL200 the perfect tool to support the development of power amplifiers and MMICs.

R&S®NGM200 High Precision Power Supply Series



High-speed accuracy

What sets these power supplies apart from others in their class?

- ▶ All channels are galvanically isolated and earth-free
- ▶ All channels are electrically equivalent with the same voltage, current and power
- ▶ Parallel and serial operation in source mode
- ▶ Protection functions to safeguard instrument and DUT
- ▶ Tracking and link functions
- ▶ Remote control via USB interface and LAN, unique in this class



Model overview

Model	Channel count	Maximum output power	Output power per channel	Output voltage per channel	Output current per channel	Load recovery time	Maximum readback resolution
R&S®NGM201	1	60 W	max. 60 W	0 V to 20 V	≤ 6 V: 6 A; > 6 V: 3 A	< 30 μs	1 μV/10 nA
R&S®NGM202	2	120 W	3 × 3 A				

Important facts

Specification	R&S®NGM200	Why this is important
Number of channels	1/2	More channels provide more flexibility for any specific application.
Maximum output power per channel	60 W	With more output power, DUTs with more power consumption can be driven.
Voltage ripple and noise (20 Hz to 20 MHz)	< 500 μV (RMS), < 2 mV (peak-to-peak)	Allows the instrument to supply interference-free voltage to sensitive DUTs with advanced electronic circuitry that is often sensitive to interference on the supply lines.
Load recovery time (20 mV)	< 30 μs	Important to supply DUTs when switching from low power consumption in standby mode to high current in full load operation without creating voltage drops or overshoots.
Maximum measurement speed	500 000 sample/s (2 μs)	High-speed acquisition, allows detection of spikes in the microsecond range that cannot be detected with slower instruments.
Protection functions	OCP/OVP/OPP/OTP	These functions safeguard the instrument and the device under test from damage.

Scope of delivery

- ▶ Power cable
- ▶ Quick start guide
- ▶ 3 year warranty

Optimized load recovery time

Under challenging load conditions, most power supplies respond with slow recovery times and overshoots. Specially developed circuits in the R&S®NGM200 power supplies achieve a load recovery time of < 30 μs with minimal overshoot, making them perfect for supplying sensitive components.

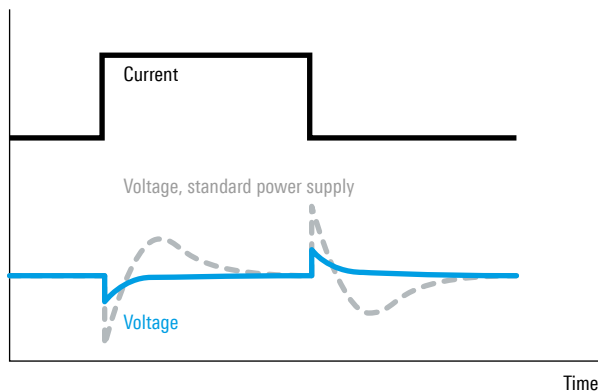

The perfect choice for:	
Battery tests	Power consumption tests
Simulation of voltage drops	Supplying sensitive designs

Your benefit	Features
Minimal overshoot from abrupt load changes	<ul style="list-style-type: none"> ▶ Optimized load recovery time < 30 μs ▶ Handles abrupt load changes from a few μA to the ampere range without creating voltage drops or overshoots
Supply interference-free voltage to sensitive designs	<ul style="list-style-type: none"> ▶ Low ripple and noise values allow you to supply interference-free voltage to sensitive designs such as semiconductors and to support the development of power amplifiers and MMICs
Capture fast variations in voltage/current	<ul style="list-style-type: none"> ▶ Acquisition rate: up to 500 ksample/s ▶ Voltage and current results available every 2 μs ▶ On the two-channel R&S®NGM202, data acquisition on both channels in parallel
Realistic battery simulation	<ul style="list-style-type: none"> ▶ Simulate the actual battery output performance ▶ Testing can be based on a selected battery model ▶ Battery capacity, state of charge (SoC) and open circuit voltage (Voc) can be set to any state to test the device under specific circumstances

Power supplies

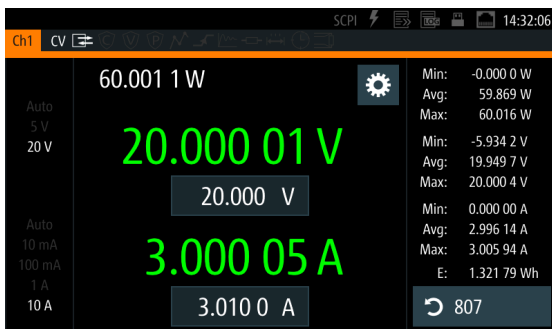

Readings with up to 6 ½ digit resolution: With a resolution of up to 6 ½ digits when measuring voltage, current and power, the R&S®NGM200 power supplies are perfect for characterizing devices that have low power consumption in standby mode and high current in full load operation. Two voltage measurement ranges and four current measurement ranges provide high accuracy and resolutions down to 1 μV/10 nA.

The high-resolution display provides additional information such as power values and statistics.



Two-quadrant operation, minimum ripple and noise: The architecture of the R&S®NGM200 power supplies allows them to function both as a source and a sink. The instruments automatically switch between sink and source operation. In this example, CH2 works as a load.

The linear design of the output stages reduces residual ripple and noise to a minimum and makes them perfect for the development of power amplifiers and MMICs.

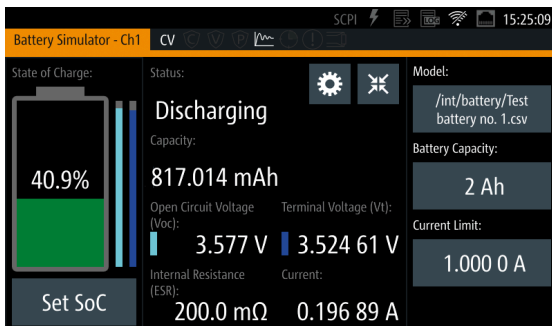

Battery simulation: When battery-operated devices have to be optimized for lifecycle, the discharging behavior of the battery type needs to be considered. The battery simulator function makes it possible to simulate the real battery output performance. Testing can be based on a selected battery model, and battery capacity, SoC and Voc can be set to any state to test the device under specific circumstances.

The discharging behavior of a battery can also be simulated, for example when designing battery chargers. In this application, the R&S®NGM200 is used in sink mode.

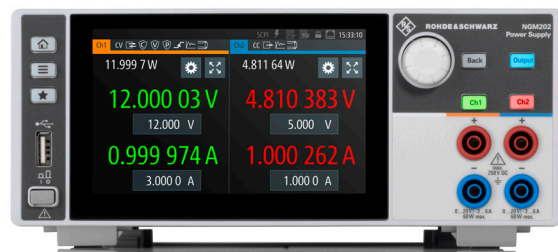

Easy operation: The high-resolution capacitive touchscreen is the central operating element for the R&S®NGM200 power supplies. Icons clearly show the status of set protection levels or special functions. When the power supply is in constant voltage mode, the numbers and the keys light up green. Red is used for constant current mode. The Output button lights up blue to indicate that channels are switched on (active).

R&S®NGU Source Measure Units



What sets this source measure unit apart?

- ▶ Two or four quadrants: source or sink operation with bipolar voltage
- ▶ Minimum residual ripple and noise for interference-free voltage to sensitive DUTs
- ▶ Fast regulation of output voltage with minimum overshoot and very fast load recovery time
- ▶ Acquisition rate of up to 500 ksample/s to capture extremely fast voltage or current variations
- ▶ Voltage priority and current priority modes
- ▶ High-capacitance mode
- ▶ Modulation input (R&S®NGU401/411)

Model overview

Model	Output voltage	Maximum output/sink power	Maximum output/sink current	Load recovery time	Maximum acquisition rate	Ripple and noise
R&S®NGU201	0 V to 20 V	60 W	≤ 6 V: 8 A; > 6 V: 3 A	< 30 μs	500 ksample/s	< 500 μV (RMS); < 1 mA (RMS) (meas.)
R&S®NGU401	-20 V to +20 V		≤ 10 V: 2 A; > 10 V: 1 A			
R&S®NGU401						

Important facts

Specification	R&S®NGU	Why this is important
Quadrants	2/4	The source measure unit can function both as a source and a sink and simulate batteries or loads with two-quadrant architecture. Four-quadrant architecture units can source and sink in both polarities. This enables measuring the forward and reverse characteristics of semiconductor devices in a single test operation without changing the circuit.
Voltage ripple and noise (20 Hz to 20 MHz)	< 500 μV (RMS), < 2 mV (peak-to-peak)	The instrument can supply interference-free voltage to sensitive DUTs with advanced electronic circuitry which are often sensitive to interference on the supply lines.
Load recovery time (20 mV)	< 30 μs	Important for supplying DUTs when switching from low power consumption in standby to high current in full load operation without creating voltage drops or overshoots.
Maximum measurement speed	500 000 sample/s (2 μs)	High-speed acquisition allows detection of spikes in the micro-second range that cannot be detected with slower instruments.
Protection functions	OCP/OVP/OPP/OTP	These functions safeguard the instrument and the device under test.

Scope of delivery

- ▶ Power cable
- ▶ Quick start guide
- ▶ 3 year warranty

Recommended options/accessories

Description	Type
Options	
Digital trigger I/O	R&S®NGU-K103
Digital voltmeter function	R&S®NGU-K104
IEEE-488 (GPIB) interface	R&S®NGU-B105
Battery simulation	R&S®NGU-K106
System components	
19" rack adapter, 2 HU	R&S®HZN96



The perfect choice for:	
High-precision source and sink measurements	Semiconductor characterization
Supplying bipolar voltages	Simulation of voltage drops
Battery tests	Power consumption tests

Your benefit	Features
Minimal overshoot from abrupt load changes	<ul style="list-style-type: none"> ▶ Optimized load recovery time of < 30 μs ▶ Handles abrupt load changes from a few nA to the ampere range without creating voltage drops or overshoots
Analyze fast variations in voltage/current	<ul style="list-style-type: none"> ▶ Acquisition rate of up to 500 ksamples/s ▶ Voltage and current results available every 2 μs
Supply positive and negative voltages and currents	<ul style="list-style-type: none"> ▶ Four-quadrant operation allows the R&S®NGU401/411 to act as a source or sink in both polarities ▶ Enables tasks such as measuring the forward and reverse characteristics of semiconductor devices in a single test operation without changes to the circuit
Can act as an AC source	<ul style="list-style-type: none"> ▶ The R&S®NGU401/411 source measure unit provides a modulation input to connect an arbitrary generator. The output follows the modulation input signal, the instrument acts as an AC source and simulates glitches and unstable conditions

Power supplies

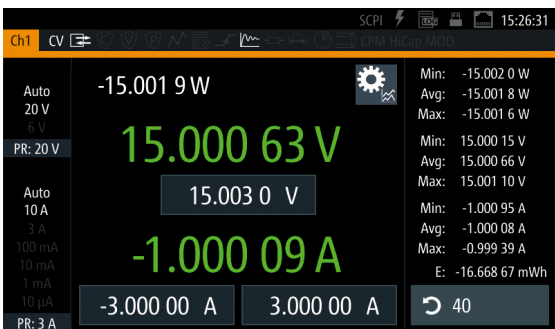

Two quadrants: operates as source and sink: The two-quadrant architecture of this source measure unit can function both as a source and a sink and simulate batteries and loads. The source measure unit automatically switches from source mode to sink mode. As soon as the externally applied voltage exceeds the set nominal voltage, current flows into the instrument, as indicated by a negative current reading. The linear design of the output stages reduces residual ripple and noise to a minimum.



Four quadrants: source or sink operation with arbitrary polarity: The R&S®NGU401 can supply positive and negative voltages and currents with its four-quadrant architecture and can act as a source or sink in both polarities.

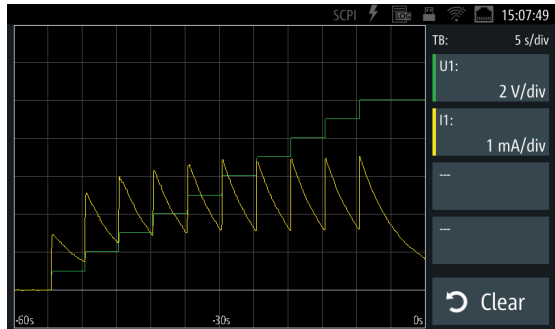

High-resolution graphical display of data: Here, the charging current of a capacitor is displayed while the voltage is increased stepwise. Up to four measurement functions can be selected and plotted against time, while minimum and maximum values can also be marked.

Optimized load recovery time

Under challenging load conditions, most power supplies respond with slow recovery times and overshoots. Specially developed circuits in the R&S®NGU source measure units achieve a load recovery time of < 30 μs with minimal overshoot, making them perfect for supplying sensitive components.

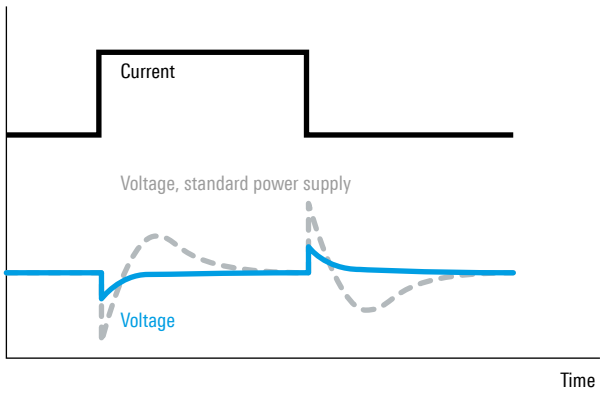

SIGNAL GENERATORS

Frequency range

The frequency range is the most important specification when selecting a suitable signal generator. The generator's upper and lower frequency limits must cover the needs of the application.

Output power

Output power is another key specification for selecting a signal generator. The higher the available power, the more likely you will be able to compensate for losses in the setup caused by cabling and components.

Instruments equipped with an electronic step attenuator provide very accurate low power levels and are not subject to the wear and tear of conventional mechanical attenuators.

Spectral purity

There are several measurements for assessing the spectral purity of a signal generator, including phase noise, spurious, harmonics and subharmonics. Phase noise measures the jitter of a signal. The better the spectral purity of a signal generator, the less it influences DUT measurements.

CW or modulated

Continuous wave (CW) generators provide only an unmodulated carrier frequency whereas analog signal generators can modulate the carrier frequency with e.g. AM, FM, ϕ M and pulse modulation.

Products	Page
R&S®HMF25xx arbitrary function generator	52
R&S®SMB100B RF signal generator	54
R&S®SMCV100B vector signal generator	56

Signal generator portfolio



	Vector signal generators R&S®SMCV100B	Analog signal generators R&S®SMB100B
Description	vector RF source	RF signal generator, outstanding performance and usability in a compact size
Performance	●●●●	●●●●●
Main features	<ul style="list-style-type: none"> ▶ good RF performance ▶ high output power ▶ RF DAC design 	<ul style="list-style-type: none"> ▶ very low SSB phase noise ▶ very high output power
Frequency range	4 kHz to 3/6/7.125 GHz	8 kHz to 1/3/6 GHz
I/Q modulation bandwidth	up to 240 MHz (internal)	–
Peak envelope power (PEP) (at 1 GHz/10 GHz)	+20 dBm/n.a.	+26 dBm/n.a.
SSB phase noise (at 1 GHz, 1 Hz measurement bandwidth, 20 kHz offset)	< -125 dBc	< -126 dBc
Harmonics (at 1 GHz)	< -30 dBc (level ≤ +13 dBm)	< -30 dBc (level ≤ +13 dBm)
Nonharmonics (at 1 GHz, > 10 kHz offset from carrier)	< -52 dBc, -60 dBc (typ.) (level > +10 dBm)	< -76 dBc (level > +10 dBm)
Dimensions (W × H × D)	222 × 97 × 366 mm (8.74 × 3.82 × 14.41 in)	344 × 108 × 372 mm (13.6 × 4.3 × 14.7 in)

All values are specified, if not otherwise stated.

WinIQSIM2 Generator supports output of digital I/Q signals generated with R&S®WinIQSIM2 simulation software.

- The higher the number of points, the higher the performance.

R&S®HMF25xx Arbitrary Function Generator

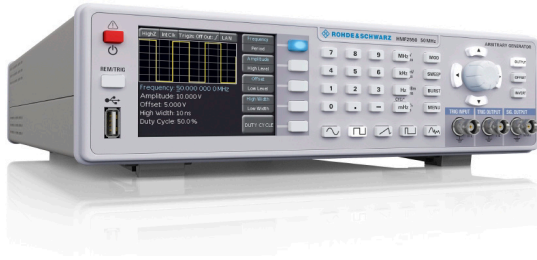

Accurate, versatile and affordable

- ▶ Two models: the R&S®HMF2525 with 25 MHz and the R&S®HMF2550 with 50 MHz maximum frequency
- ▶ 14-bit resolution and 8 ns rise time
- ▶ As well as standard waveforms such as sine, rectangle and triangle, the instruments provide powerful arbitrary signal functionality. In addition to predefined signal shapes such as sin(x)/x, white or pink noise, they can also output customer-specific, arbitrary shapes with a signal length of up to 256 ksample
- ▶ The burst, sweep, gating, internal and external triggering operating modes and the AM, FM, PM, PWM and FSK modulation functions (in each case internal and external) can be applied to all signals

Model overview						
Model	Frequency range	Output voltage	Total harmonic distortion	Arbitrary waveform vertical resolution	Arbitrary waveform signal memory length	Interface
R&S®HMF2525	10 µHz to 25 MHz	5 mV to 10 V (peak-to-peak) (into 50 Ω) 10 mV to 20 V (peak-to-peak) (open circuit)	0.04% (typ.) (f ≤ 100 kHz)	14 bit	up to 256 kpoints	dual-interface USB/RS-232, optional interfaces LAN/USB and IEEE-488 (GPIB)
R&S®HMF2550	10 µHz to 50 MHz	5 mV to 10 V (peak-to-peak) (into 50 Ω) 10 mV to 20 V (peak-to-peak) (open circuit)	0.04% (typ.) (f ≤ 100 kHz)	14 bit	up to 256 kpoints	

Important facts		
Specification	R&S®HMF2525/R&S®HMF2550	Why this is important
Widest measurement range across all functions	<p>R&S®HMF2525:</p> <ul style="list-style-type: none"> ▶ sine: 10 µHz to 25 MHz ▶ square: 10 µHz to 25 MHz ▶ pulse: 100 µHz to 12.5 MHz ▶ ramp/triangle: 10 µHz to 5 MHz ▶ arbitrary: 100 µHz to 12.5 MHz <p>R&S®HMF2550:</p> <ul style="list-style-type: none"> ▶ sine: 10 µHz to 50 MHz ▶ square: 10 µHz to 50 MHz ▶ pulse: 100 µHz to 25 MHz ▶ ramp/triangle: 10 µHz to 10 MHz ▶ arbitrary: 100 µHz to 25 MHz 	Allows utilization of the function generator for more applications and use cases.
Crisp color display	3.5" color TFT QVGA	See crisp representation of the waveform and all parameters.

Scope of delivery
<ul style="list-style-type: none"> ▶ User manual ▶ Power cord ▶ 3 year warranty

Recommended options/accessories	
Description	Type
Options and system components	
Dual Ethernet/USB interface	R&S®HO732
IEEE-488 (GPIB) interface	R&S®HO740
19" rackmount kit, 2 HU	R&S®HZ42



The perfect choice for:	
Engineering lab	Maintenance and repair
Education	General purpose

Your benefit	Features
Powerful pulse generator	Provides pulses with a recurrence rate of up to 12.5 MHz/25 MHz; the pulse width can be set from 15 ns to 999 s with a resolution of 5 ns. Rise/fall time can be selected from 8 ns to 500 ns – a very useful feature when characterizing input hysteresis of semiconductor devices
Easily create arbitrary waveforms	Arbitrary waveforms can be developed with PC software. Stored waveforms can be loaded via the front USB port or imported via the complementary HME Explorer software (available for download)

Signal generators

Signal examples

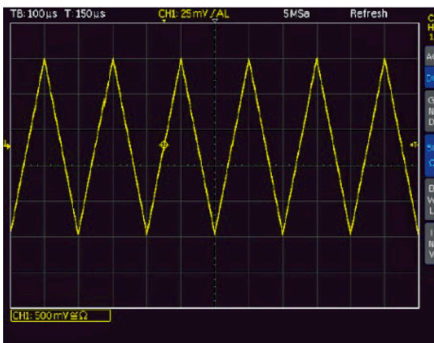

Triangle signal

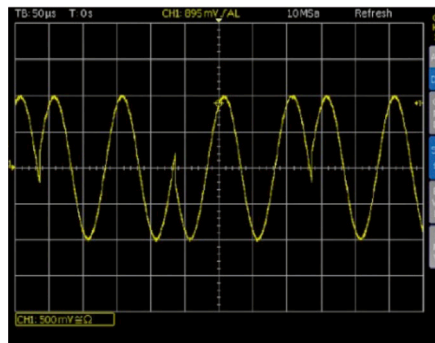

Phase modulation (PM)

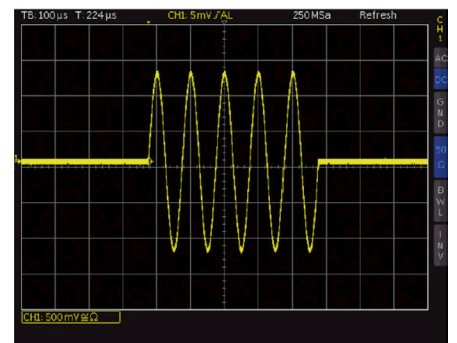

Burst example

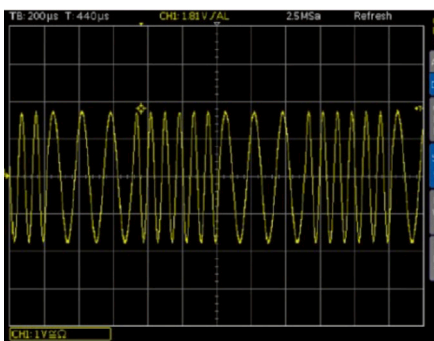

Frequency shift keying (FSK)

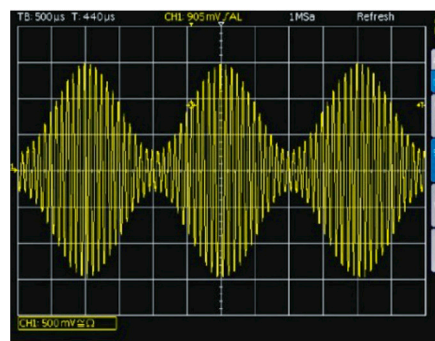

Amplitude modulation (AM)

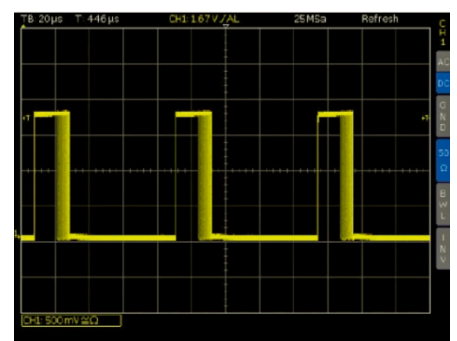

Pulse width modulation (PWM)

R&S®SMB100B RF Signal Generator



Perfect for signal quality, perfect for output power, perfect for use

The R&S®SMB100B RF signal generator is all about performance and versatility in a small footprint. Outstanding spectral purity and very high output power combined with comprehensive functionality and very simple operation are some of the impressive features of the R&S®SMB100B.

Model overview

Model (frequency range)	Configuration	Maximum output power (10 MHz < f ≤ 6 GHz)	Phase noise (1 GHz, at 20 kHz)	Optional analog modulation
1 GHz				
R&S®SMB100B	R&S®SMB100B, R&S®SMBB-B101	+18 dBm	< -126 dBc	AM, FM, phase, pulse
R&S®SMB100B (ultra high output power)	R&S®SMB100B, R&S®SMBB-B101, R&S®SMBB-K31, R&S®SMBB-B32	+26 dBm	< -126 dBc	AM, FM, phase, pulse
3 GHz				
R&S®SMB100B	R&S®SMB100B, R&S®SMBB-B103	+18 dBm	< -126 dBc	AM, FM, phase, pulse
R&S®SMB100B (ultra high output power)	R&S®SMB100B, R&S®SMBB-B103, R&S®SMBB-K31, R&S®SMBB-B32	+26 dBm	< -126 dBc	AM, FM, phase, pulse
6 GHz				
R&S®SMB100B	R&S®SMB100B, R&S®SMBB-B106	+18 dBm	< -126 dBc	AM, FM, phase, pulse
R&S®SMB100B (ultra high output power)	R&S®SMB100B, R&S®SMBB-B106, R&S®SMBB-K31, R&S®SMBB-B32	+26 dBm	< -126 dBc	AM, FM, phase, pulse

Important facts

Specification	R&S®SMB100B	Why this is important
Frequency range	8 kHz to 1/3/6 GHz	To cover the frequency range of the DUT.
Phase noise (f = 1 GHz, 20 kHz offset)	< -126 dBc	A generator with lower phase noise will add less unwanted noise to the DUT. This shows the true performance of the DUT. Test the device, not the generator.
Output power at 6 GHz	+26 dBm	A higher power level allows a wider range of testing. In addition, extra power enables the user to compensate for fixtures and cables between the generator and the test point, and removes the need for external amplifiers.
Dimensions (W × H × D)	344 mm × 108 mm × 372 mm	A smaller footprint takes up less space on a crowded workbench.
Weight	≤ 6.8 kg	

Scope of delivery

- ▶ Quick start guide
- ▶ Power cord
- ▶ 1 year warranty

Recommended options/accessories

Reference oscillator options	Type
OCXO reference oscillator ¹⁾	R&S®SMBB-B1
OCXO reference oscillator, high performance ¹⁾	R&S®SMBB-B1H
High performance pulse modulator	R&S®SMB-K22
Pulse generator	R&S®SMB-K23
Pulse train	R&S®SMB-K27

¹⁾ Only the R&S®SMBB-B1 or the R&S®SMBB-B1H option can be installed.



The perfect choice for:	
Local oscillator substitution for design and test engineers	Receiver sensitivity testing for design and test engineers
FM receiver testing	Pulsed signals in aerospace and defense applications to test radar systems

Your benefit	Features
No need for external amplifiers	Ultra high output power (34 dBm, 1 GHz, meas.)
User-configurable pulse scenarios	Pulse train option in combination with the pulse modulator and pulse generator option
Quickly and correctly create remote control programs	The instrument's built-in SCPI macro recorder with code generator can automatically record all manual settings and create an executable MATLAB® script.
Compensation of external frequency responses	The R&S®SMB100B provides a user correction (UCOR) function for this purpose.
Replace your legacy signal generator	R&S®LegacyPro enables the R&S®SMB100B to reliably emulate a wide range of legacy generators from vendors such as Keysight, Agilent, HP, Anritsu and Rohde&Schwarz

Signal generators

Perfect for signal quality

Single-sideband phase noise (1 GHz, 1 Hz bandwidth, measured): Thanks to its innovative synthesizer design, the R&S®SMB100B has very low SSB phase and wideband noise and excellent suppression of nonharmonic signal components.

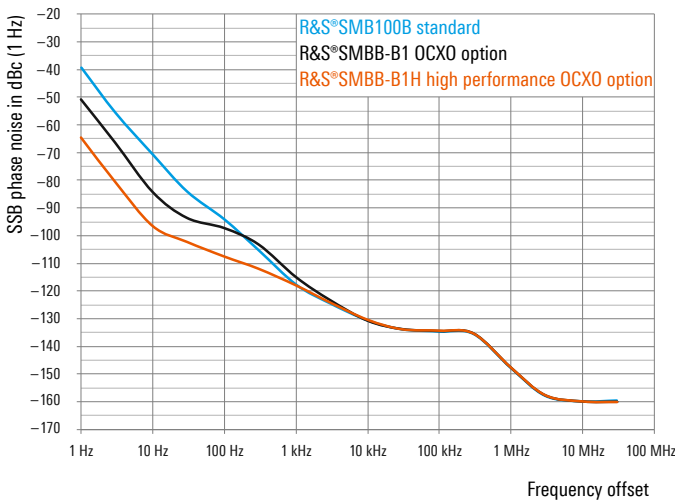

Perfect for output power

Measured maximum output power for the base unit, with the high power option (R&S®SMBB-K31) and with the additional ultra high power option (R&S®SMBB-B32). The R&S®SMB100B provides very high output power, no external amplifier is required downstream. This simplifies the test setup and results in high absolute level accuracy.

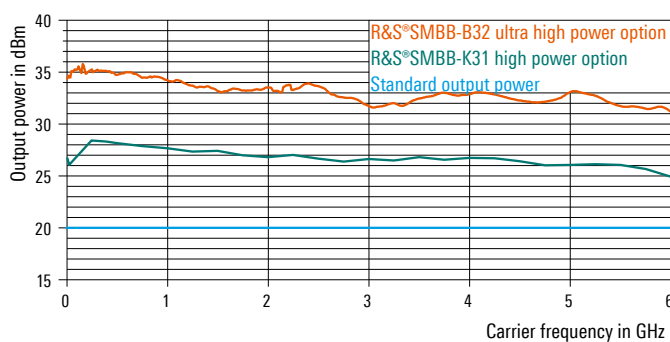

Perfect for use

The R&S®SMB100B has a user-friendly high-resolution touchscreen interface which is fast and simple to operate.

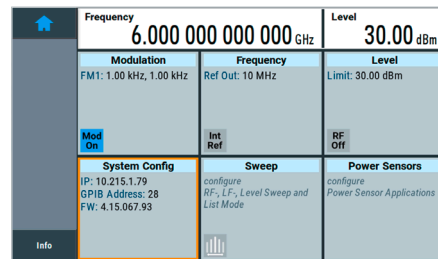

Main screen with all important parameters and information

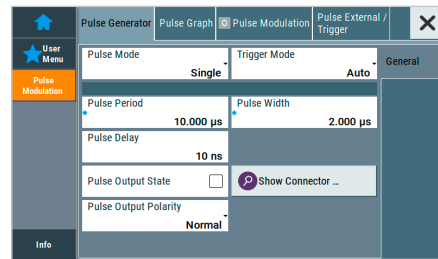

Individual menu items can be added to the user menu; added items are marked with a blue star

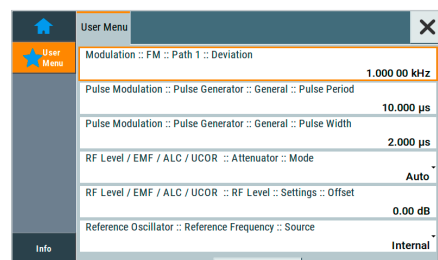

Example of a user menu; individually composed parameters can be directly set in this menu

R&S®SMCV100B Vector Signal Generator



Maximum flexibility in applications and in production

The R&S®SMCV100B features a new Direct-RF DAC concept for RF signal generation. This concept enables I/Q modulation and up-conversion in the digital domain which eliminates I and Q imbalance errors and the LO leakage known from traditional analog I/Q modulators.

The R&S®SMCV100B options concept is fully software defined. No hardware options need to be selected for full functions of the available instrument. This includes upgrades to the RF frequency, memory, I/Q modulation bandwidth and for a wide variety of applications.

Model overview

Model	Frequency	RF output power	Phase noise	Display
R&S®SMCV100B	4 kHz to 3/6/7.125 GHz	up to +25 dBm	< -125 dBc (f = 1 GHz, 10 kHz offset)	5" touch display (800 × 480 pixel)

Important facts

Specification	R&S®SMCV100B	Why this is important
Multistandard platform	multistandard platform for automotive, broadcast, navigation and wireless applications with numerous digital standards	Since only one instrument is needed for a wide variety of applications, it has the flexibility for deployment at any time for other tasks on a production line. This minimizes potential unused capacity and allows a massive reduction of downtime on production lines.
Frequency range	4 kHz up to 7.125 GHz	To cover the DUT frequency range.
Phase noise	< -125 dBc	A generator with lower phase noise will add less unwanted noise to the DUT, revealing its true performance. Test the device, not the generator.
RF output power	up to +25 dBm	A higher power level allows a wider range of testing. Extra power enables the user to compensate for fixtures and cables between the generator and the test point, and removes the need for external amplifiers.

Scope of delivery

- ▶ Power cable
- ▶ Quick start guide
- ▶ 3 year warranty

Recommended options/accessories

Description	Type
Frequency options	
4 kHz to 3 GHz	R&S®SMCVB-B103
Frequency extension to 6 GHz	R&S®SMCVB-KB106
Frequency extension to 7.125 GHz	R&S®SMCVB-KB107
RF options	
High output power	R&S®SMCVB-K31
Low phase noise	R&S®SMCVB-K709

Recommended options/accessories

Digital standards (cellular)	
5G NR Release 15	R&S®SMCVB-K444
5G NR Release 16	R&S®SMCVB-K448
5G NR Release 17	R&S®SMCVB-K471
5G NR Sidelink	R&S®SMCVB-K470
LTE Release 8	R&S®SMCVB-K255
LTE Release 9	R&S®SMCVB-K284
LTE Release 10	R&S®SMCVB-K285
LTE Release 11	R&S®SMCVB-K412
LTE Release 12	R&S®SMCVB-K413
LTE Release 13/14/15	R&S®SMCVB-K419
Cellular IoT Release 13	R&S®SMCVB-K415
Cellular IoT Release 14	R&S®SMCVB-K443
Cellular IoT Release 15	R&S®SMCVB-K446
3GPP FDD	R&S®SMCVB-K242
3GPP FDD HSPA/HSPA+, enhanced BS/MS tests	R&S®SMCVB-K283
GSM/EDGE	R&S®SMCVB-K240
EDGE Evolution	R&S®SMCVB-K241



The perfect choice for:	
General purpose	Labs
EMC testing and validation	Manufacturing

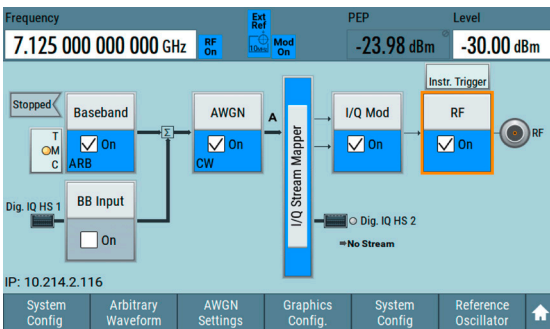

Graphical user interface with block diagram: Instantly see the signal flow in the R&S®SMCV100B as well as the instrument input and output states. An integrated graphic function displays the generated signal in real time.

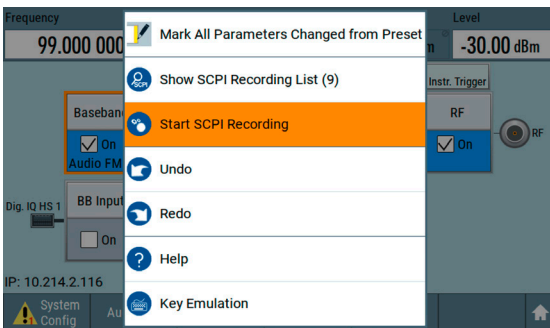

Built-in SCPI macro recorder: The integrated SCPI macro recorder with built-in code generator allows users to automatically record all manual settings and create a directly executable MATLAB® script.

Your benefit	Features
First multistandard platform for automotive, broadcast, navigation and wireless applications	<ul style="list-style-type: none"> ▶ Frequency range from 4 kHz to 7.125 GHz <ul style="list-style-type: none"> - Modern RF signal generation concept - Direct RF upconversion from 4 kHz to 2.5 GHz ▶ Modulation bandwidth up to 240 MHz ▶ Powerful internal baseband generator <ul style="list-style-type: none"> - Real-time broadcast coder - Custom digital modulation - Internal baseband signal generation with ARB ▶ I/Q streaming capabilities <ul style="list-style-type: none"> - Playback of long I/Q sequences from solid state disk drive for EMC testing ▶ Support of R&S®WinIQSIM2 waveform generation <ul style="list-style-type: none"> - Wireless standards such as 5G NR, LTE, non-cellular IoT, Wi-Fi® (IEEE 802.11) - Navigation standards for functional Go/NoGo tests and predefined position fix tests
Maximum flexibility in production	<ul style="list-style-type: none"> ▶ From functional end-of-line testing (EOLT) to application-specific device software testing ▶ Fully software defined signal generation for easy upgrading at customer site ▶ Standardization of production lines with a single vector signal generator ▶ Minimizes downtime of production lines
User friendly in any detail	<ul style="list-style-type: none"> ▶ Half a rack size, big performance, leading operation concept with block diagram ▶ 5" touch display (800 × 480 pixel) in a 2 HU instrument ▶ SCPI macro recorder

Signal generators

Recommended options/accessories	
Wireless connectivity standards	
IEEE 802.11a/b/g/n	R&S®SMCVB-K254
IEEE 802.11ac	R&S®SMCVB-K286
IEEE 802.11ax	R&S®SMCVB-K442
Bluetooth® EDR	R&S®SMCVB-K260
Bluetooth® 5.x	R&S®SMCVB-K417
LoRa®	R&S®SMCVB-K431
IEEE 802.11be	R&S®SMCVB-K447

Recommended options/accessories	
Digital standards (broadcast)	
DVB-H/DVB-T	R&S®SMCVB-K252
DAB/T-DMB	R&S®SMCVB-K253
DVB-S2/DVB-S2X	R&S®SMCVB-K416
Other standards and modulation systems	
Multicarrier CW signal generation	R&S®SMCVB-K261
Additive white Gaussian noise (AWGN)	R&S®SMCVB-K262
NFC A/B/F	R&S®SMCVB-K289
OFDM signal generation	R&S®SMCVB-K414

HANDHELD ANALYZERS

Frequency range

The frequency range specifies the range of frequencies over which the spectrum analyzer will operate. Different measurement applications may require a larger frequency range to evaluate harmonics, spurs or alternate channels. In this case, it makes sense to consider a higher frequency model in order to capture all potential signals of interest.

Application example: Detecting the third-order harmonics of a 915 MHz signal requires a spectrum analyzer of more than 2.745 GHz maximum frequency.

Upgradeability

All handheld analyzers have various upgrade options. The analyzer's capability can be increased to meet the task's requirements. Some models even offer frequency upgrades without having to add hardware. All upgrades are done via keycode, which eliminates the need to send the analyzer to a Rohde & Schwarz service center. There is no downtime.

A simple upgrade can transform a basic analyzer into a multitasking analyzer. If the function is only needed temporarily, a temporary license is also available.

Features and capabilities

Handheld analyzers provide a wide range of features and options to support different tasks in the field. Supported measurements include:

- ▶ Advanced spectrum measurements, e.g. channel power, occupied bandwidth, harmonic distortion
- ▶ Cable and antenna measurements, e.g. distance-to-fault, cable loss, VSWR
- ▶ Signal demodulation, e.g. AM/FM/PM demodulation and demodulation in line with specific wireless or mobile standards
- ▶ Vector signal analysis
- ▶ Spectrum monitoring and interference hunting

Some of these tasks require additional accessories, for example an antenna with the corresponding frequency range, a GPS receiver for position logging or a calibration kit for cable and antenna measurements.

Operating duration

To facilitate measurements anytime, anywhere, handheld analyzers must be mobile. All handheld analyzers are battery operated. Depending on the task, measurements can take a few minutes or even a day. Typically, a battery can last 3 hours to 4.5 hours. Thanks to state-of-the-art design concepts, the newer handheld analyzer generation consumes considerably less power. With a single charge, it is now possible to complete a full day's work in the field without having to take along an extra battery or look for a power source.

For longer operating periods (for example when a handheld spectrum analyzer is installed at a remote location for a week to perform spectrum recording), simply take out the battery and use a power adapter. If there is a power outage, the analyzer will automatically power up when AC power returns. There is no need to send someone to the site to power up the analyzer.

Products	Page
R&S®FSH handheld spectrum analyzer	62
R&S®Spectrum Rider FPH handheld spectrum analyzer	64
R&S®Cable Rider ZPH cable and antenna analyzer	66
R&S®ZVH cable and antenna analyzer	68
R&S®ZNH handheld vector network analyzer	70

Handheld analyzer portfolio



	R&S® FSH	R&S® FPH
Description	handheld combination analyzer; with spectrum analyzer up to 20 GHz and two-port vector network analyzer up to 8 GHz	handheld spectrum analyzer; up to 44 GHz
Performance	●●	●
Frequency models	9 kHz to 20 GHz (3.6/8/13.6/20 GHz models available)	5 kHz to 44 GHz (2/3/4/6/8/13.6/20/26.5/31/44 GHz models available)
Analysis bandwidth	–	–
Phase noise	–105 dBc (1 Hz) (f = 500 MHz, 30 kHz offset)	–95 dBc (1 Hz) (f = 500 MHz, 30 kHz offset)
DANL, at 1 GHz, preamplifier OFF	–146 dBm	–146 dBm
DANL, at 1 GHz, preamplifier ON	–165 dBm	–163 dBm
TOI	+15 dBm	+10 dBm
Highlights	handheld combination analyzer: spectrum, full two-port vector network analyzer, power meter, cellular demodulation, interference hunting, EMI receiver mode, EMF measurement, vector voltmeter, pulse measurement	handheld spectrum analyzer: spectrum, power meter, interference hunting, EMI receiver mode, pulse measurement, field strength meter, modulation analyzer (AM/FM/ASK/FSK), up to 9 h operating time
Dimensions	194 mm × 300 mm × 144 mm (7.6 in × 11.8 in × 5.7 in)	202 mm × 294 mm × 76 mm (8.0 in × 11.6 in × 3 in)

- The higher the number of points, the higher the performance.



R&S® ZVH	R&S® ZPH	R&S® ZNH
handheld cable and antenna analyzer; up to 8 GHz with optional vector network analyzer and spectrum analyzer	handheld cable and antenna analyzer; up to 4 GHz with optional spectrum analyzer	cable and antenna analyzer
••	•	
100 kHz to 8 GHz (3.6 GHz/8 GHz models available)	5 kHz to 4 GHz (3 GHz/4 GHz models available)	30 kHz to 26.5 GHz (4/8/18/26.5 GHz models available)
–	–	
–105 dBc (1 Hz) (f = 500 MHz, 30 kHz offset)	–95 dBc (1 Hz) (f = 500 MHz, 30 kHz offset)	
–146 dBm	–146 dBm	
–165 dBm	–163 dBm	
+10 dBm	+10 dBm	
handheld combination analyzer: spectrum, cable and antenna, full two-port vector network analyzer, power meter, vector voltmeter	handheld combination analyzer: spectrum, cable and antenna, power meter, interference hunting, pulse analyzer, signal generator, modulation analyzer (AM/FM/ASK/FSK), built-in bias tee, extremely fast boot and measurement time	two-port handheld vector analyzer, cable and antenna measurement, full two-port S-parameter measurement, power sensor support, pulse measurement, vector voltmeter, power sensor versus frequency, time domain analysis
194 mm × 300 mm × 144 mm (7.6 in × 11.8 in × 5.7 in)	202 mm × 294 mm × 76 mm (8.0 in × 11.6 in × 3 in)	202 mm × 294 mm × 76 mm (8 in × 11.6 in × 3 in)



R&S®FSH Handheld Spectrum Analyzer



Expandable platform that eliminates the need for multiple instruments

Depending on the model and options installed, the R&S®FSH can be used as a:

- ▶ Spectrum analyzer
- ▶ Interference hunting analyzer
- ▶ Cable and antenna analyzer
- ▶ Two-port vector network analyzer
- ▶ Power meter

Model overview

Model (frequency range)	Tracking generator	Preamplifier included	Resolution bandwidth	Phase noise	Level measurement uncertainty	DANL	TOI
R&S®FSH4 (9 kHz to 3.6 GHz)		•					> +10 dBm, +15 dBm (typ.)
R&S®FSH4 (9 kHz to 3.6 GHz)	•	•					
R&S®FSH4 (100 kHz to 3.6 GHz)	•	•				-161 dBm, -165 dBm (typ.)	
R&S®FSH8 (9 kHz to 8 GHz)		•					
R&S®FSH8 (9 kHz to 8 GHz)	•	•					
R&S®FSH8 (100 kHz to 8 GHz)	•	•	1 Hz to 3 MHz	-95 dBc (1 Hz), -105 dBc (1 Hz) (typ.)	up to 1 dB, 0.5 dB (typ.)		> +3 dBm, +10 dBm (typ.)
R&S®FSH13 (9 kHz to 13.6 GHz)		•					
R&S®FSH13 (9 kHz to 13.6 GHz)	•	•					
R&S®FSH20 (9 kHz to 20 GHz)		•					
R&S®FSH20 (9 kHz to 20 GHz)	•	•				-158 dBm, -162 dBm (typ.)	

Important facts

Specification	R&S®FSH	Why this is important
Demodulation	GSM/GPRS/EDGE, WCDMA, TD-SCDMA CDMA2000®, 1xEV-DO, LTE TDD, LTE FDD	Allows modulation measurements on relevant wireless standards.
VNA support	full two-port	Allows for cable loss and antenna testing and characterization, as well as distance to fault measurements. Two-port capability increases accuracy of transmission measurements.
Wizard support for common measurement functions	•	Increases repeatable field test patterns and reduces user error.
Entry level model	3.6 GHz	Determines lowest cost entry point into the family.
Preamplifier	•	Increases sensitivity for low signal level measurements.

Scope of delivery

- ▶ Lithium-ion battery pack
- ▶ USB cable
- ▶ LAN cable
- ▶ AC power supply
- ▶ User manual
- ▶ 3 year warranty (one year for battery and accessories)

Recommended options/accessories

Description	Type
EMF measurement application	R&S®FSH-K105
Pulse measurements with power sensor ^{1), 2)}	R&S®FSH-K29
Spectrogram measurement application	R&S®FSH-K14
Interference analysis	R&S®FPH-K15
Geotagging measurement application ¹⁾	R&S®FSH-K16

¹⁾ Software license.

²⁾ Requires R&S®FSH-Z129 for R&S®FSH4/8/13/20 with serial numbers < 121000.



Recommended options/accessories

Indoor mapping measurement application	R&S®FSH-K17
Receiver mode and channel scan measurement application	R&S®FSH-K43
LTE FDD downlink pilot channel and EVM measurement application ³⁾	R&S®FSH-K50
LTE FDD downlink extended channel and modulation measurement application ^{3), 4)}	R&S®FSH-K50E
LTE TDD downlink pilot channel and EVM measurement application ³⁾	R&S®FSH-K51
LTE TDD downlink extended channel and modulation measurement application ^{3), 5)}	R&S®FSH-K51E
Lithium-ion battery pack, 6.75 Ah	R&S®HA-Z206
Near-field probes	R&S®HZ-15
Yagi antenna, 824 MHz to 960 MHz	R&S®HA-Z900
Yagi antenna, 1710 MHz to 1990 MHz	R&S®HA-Z1900
Segmented sweep	R&S®FSH-K20

³⁾ Only for R&S®FSH analyzers with serial numbers ≥ 105000.

⁴⁾ R&S®FSH-K50 required.

⁵⁾ R&S®FSH-K51 required.

The perfect choice for:	
Installation and maintenance of transmitter stations	EMI debugging/ RF design validation
Interference hunting	Electromagnetic fields measurements

Your benefit	Features
An expandable platform for every RF handheld measurement application	Expanded modes of operation for field strength measurements, power measurements, network analysis, interference analysis, vector voltmeter, pulse measurements
Extensive support for numerous wireless technologies	Modulation analysis for cellular technologies, including over-the-air LTE-Advanced carrier aggregation signal analysis
Most efficient instrument in the field	<ul style="list-style-type: none"> ▶ Sunlight readable display ▶ Generation of user-defined test sequences (R&S®FSH wizard) ▶ Wizard streamlines test development ▶ Remote control and data export with free R&S®Instrument View software ▶ Fast measurement mode switching ▶ SD card and USB port for data storage



Vector network analyzer mode: For cable loss and antenna testing and characterization as well as distance to fault measurements. Two-port capability for transmission measurements



Wizard function support for common measurements: User-definable test sequences that reduce operating errors in the field

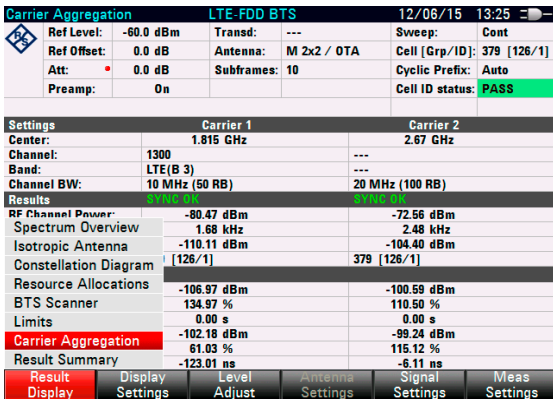

Support of numerous wireless communications standards: Modulation measurements on GSM/GPRS/EDGE, WCDMA, TD-SCDMA CDMA2000®, 1xEV-DO, LTE TDD, LTE FDD



The R&S®FSH with laptop

Handheld analyzers



R&S®Spectrum Rider FPH Handheld Spectrum Analyzer



The three key Ps for lab and field environments

Performance: excellent DANL and phase noise

- ▶ Weak signals can be easily captured

Portability: weighs as little as 2.5 kg

- ▶ Carrying holster (R&S®HA-Z322) to free up hands
- ▶ Side strap included for easy transportation
- ▶ Selection of carrying cases available

Price: low starting price and optional software keycode upgrades

- ▶ Competitive and attractive price
- ▶ No downtime, no recalibration needed

Model overview

Model	Frequency range	Preamplifier	Resolution bandwidth	Phase noise (f = 500 MHz, 1 MHz offset)	Level measurement uncertainty	DANL	TOI
.02 + R&S®FPH-B3 + R&S®FPH-B4	5 kHz to 2 GHz up to 3 GHz up to 4 GHz	optional	1 Hz to 3 MHz	-125 dBc (1 Hz)	0.5 dB (typ.)	-163 dBm (typ.)	+10 dBm (typ.)
.06 + R&S®FPH-B8	5 kHz to 6 GHz up to 8 GHz			▶ model .13: -125 dBc (1 Hz)			
.13/.23 + R&S®FPH-B20	5 kHz to 13.6 GHz up to 20 GHz			▶ model .23: -125 dBc (1 Hz)			
.26/.36 R&S®FPH-B31	5 kHz to 26.5 GHz up to 31 GHz			▶ model .26: -125 dBc (1 Hz)			
.44/.54	5 kHz to 44 GHz			▶ model .36: -125 dBc (1 Hz)		-162 dBm (typ.)	
				-120 dBc (1 Hz)			

Important facts

Specification	R&S®Spectrum Rider FPH	Why this is important
Software upgradeable frequency ranges	•	Investment protection. Allows users to buy only what they need, when they need it.
Touchscreen (capacitive)	•	Allows faster measurement setup and configuration. Ability to pinch and zoom to set span.
Backlit keypad	•	Ability to use the equipment in all lighting conditions.
Fanless design	•	Quiet operation, sealed to protect against dust and water.

Scope of delivery

- ▶ Lithium-ion battery pack
- ▶ Side strap for your hand
- ▶ Power cord
- ▶ USB cable
- ▶ User manual
- ▶ 3 year warranty (one year for battery and accessories)

Recommended options/accessories

Description	Type
Spectrum analyzer 100 Hz frequency extension, from 5 kHz down to 100 Hz ¹⁾	R&S®FPH-B29
Analog modulation analysis AM/FM	R&S®FPH-K7
Power sensor support	R&S®FPH-K9
Channel power meter	R&S®FPH-K19
Pulse measurements with power sensor	R&S®FPH-K29
Interference analysis	R&S®FPH-K15
Signal strength mapping	R&S®FPH-K16
Receiver mode	R&S®FPH-K43
EMF measurement application	R&S®FPH-K105



¹⁾ For serial number ≥ 103100.
Not applicable to R&S®Spectrum Rider FPH model .02.

The perfect choice for:	
Spectrum clearance (5G ready)	Interference hunting
Pulse measurement	EMI debugging and RF design validation

Your benefit	Features
Battery life twice that of today's handheld spectrum analyzers	<ul style="list-style-type: none"> ▶ models .02/.06/13/.26: > 6 h battery life ▶ models .23/.36/44/.54: 4.5 h battery life
Smartphone style capacitive touchscreen; also available with traditional interface	<ul style="list-style-type: none"> ▶ 7" antiglare capacitive color touchscreen ▶ On-screen keyboard ▶ Smartphone-like gestures ▶ Adjustable display brightness ▶ Backlit large button keypad ▶ Multifunction rotary knob
Buy only what you need; upgrade later without returning analyzer for servicing	<ul style="list-style-type: none"> ▶ Selection of 2/6/13.6/26.5 GHz base models ▶ Frequency upgrade keycode options available for each base model ▶ Channel power meter keycode option

Battery life comparison (in hours)

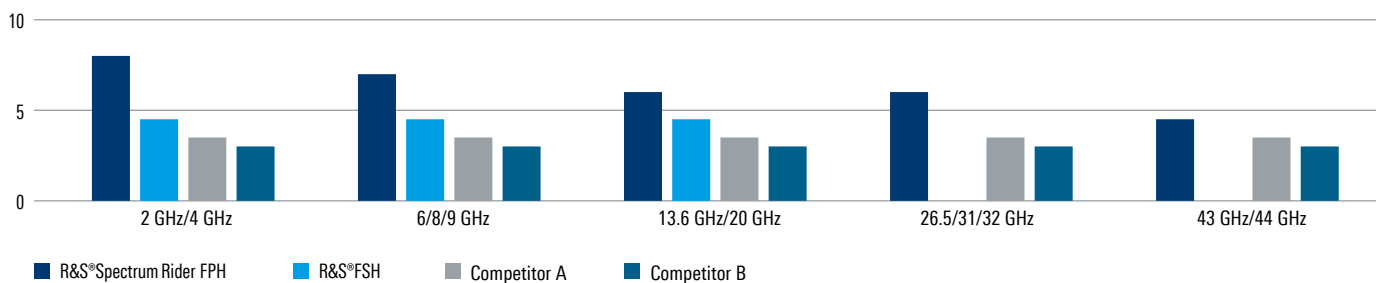

Price comparison (in EUR)

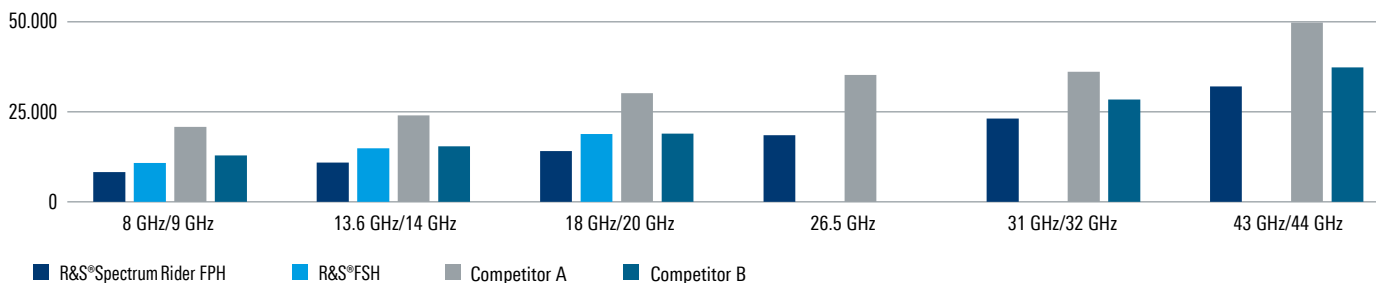

Lightweight design

Every additional gram adds to user fatigue in the field. Thanks to the state-of-the-art design, each unit weighs only 2.5 kg – regardless of the frequency range.

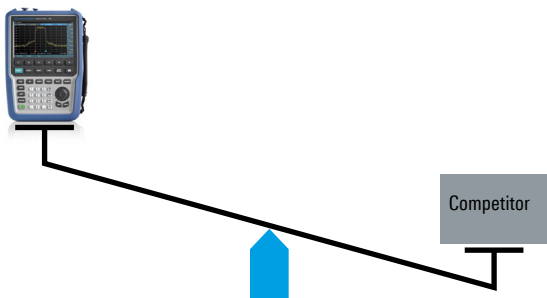

Performance and features

The R&S®SpectrumRider FPH has exceptional phase noise and DANL to capture known and unknown signals. The R&S®SpectrumRider FPH easily measures a wide range of parameters such as total harmonic distortion, occupied bandwidth, output power and channel power, making it the ideal tool for field work.

Other products to consider

- ▶ R&S®NRP power sensors: all models up to 110 GHz supported
- ▶ R&S®FSH: when you need digital modulation analysis



R&S®CableRider ZPH Cable and Antenna Analyzer



Save time in the field

The R&S®CableRider ZPH is a cable and antenna analyzer that is available in two models. The one-port model has all the essential basic measurement capabilities required for installing and maintaining antenna systems in the field. Its unique features ensure fast and efficient cable and antenna measurements. The two-port model offers more functionality and can perform spectrum analysis (R&S®ZPH-K1 option). It has an independent tracking source plus an integrated bias tee. All these add-ons make the R&S®CableRider ZPH the perfect field installation and maintenance tool.

Model overview

Model	Frequency range	Frequency extension	Measurement speed	Data points	Measurement mode (standard)	Measurement mode (optional)
R&S®ZPH one-port model (model .02)	2 MHz to 3 GHz				DTF, return loss, VSWR, one-port cable loss, Smith chart, phase	power meter, power measurement with power sensor, pulse measurement
R&S®ZPH two-port model (model .12)	<ul style="list-style-type: none"> ▶ CAT mode: 2 MHz to 3 GHz ▶ spectrum mode: 5 kHz to 3 GHz 	up to 4 GHz (R&S®ZPH-B4 option)	0.3 ms/point	101 to 2501	DTF, return loss, VSWR, one-port cable loss, Smith chart, phase, S_{21}	power meter, power measurement with power sensor, pulse measurement, spectrum analysis, interference analysis, AM/FM/ASK/FSK modulation analysis

Important facts

Specification	R&S®ZPH	Why this is important
Measurement speed	0.3 ms/point	Total overall test time is an important parameter impacted greatly by measurement speed. Faster measurement time per point increases overall throughput. This is especially important if hand-tuning of devices (antennas, resonators) is required.
Battery operation time	up to 6.5 h/9 h (mode dependent)	The advantages of having a long-lasting battery are obvious – no need to bring an extra battery with additional weight when climbing up a mast or tower, no dead batteries during measurement.
Automatic calibration unit	● ¹⁾	With little or no VNA experience, users can make a valid calibration and accurate measurements. An auto-cal unit also eliminates the need to deal with individual open, short, match and through calibration standards. Auto-cal based calibrations can be performed in the field or the lab to ensure consistent and reliable results.
Capacitive touchscreen with gesture support	●	Intuitive (smartphone-like) operation. Allows faster measurement setup and configuration. Ability to pinch and zoom to set span.

¹⁾ With R&S®ZN-Z103 calibration unit.

Scope of delivery

- ▶ Power cord
- ▶ Lithium-ion battery pack
- ▶ 3 year warranty (one year for battery and accessories)

Recommended options/accessories

Description	Type
Frequency upgrade (3 GHz to 4 GHz)	R&S®ZPH-B4
Spectrum analyzer preamplifier (requires R&S®ZPH-K1)	R&S®ZPH-B22
Calibration unit, one-port, 2 MHz to 4 GHz	R&S®ZN-Z103
Combined open/short/50 Ω load calibration standard, for calibrating VSWR and DTF measurements, DC to 3.6 GHz	R&S®FSH-Z29
Soft carrying bag	R&S®HA-Z220
Rainproof carrying holster	R&S®HA-Z322



The perfect choice for:	
Installation and maintenance of AM/FM radio stations	Spectrum clearance/interference hunting ¹⁾
RF cable testing	Antenna measurement

¹⁾ Only with two-port model.

Your benefit	Features
Hybrid operation	Large keypads and sensitive capacitive touchscreen
Make the right measurement right away	Wizard function, settings preconfigured in advance
One-step calibration	No toggling between O/S/L standards with the R&S®ZN-Z103 automatic calibration unit
Shortest test time	Fastest measurement speed (0.3 ms/point), short boot and warm-up times
Work under bright or dim conditions	Non-reflective display with adjustable backlight, illuminated keypad
Buy what you need when you need it	Upgrade via keycode, no downtime, no recalibration required
Simple wireless remote operation	Free downloadable Android/iOS apps (third-party wireless router required)

Handheld analyzers

More functions

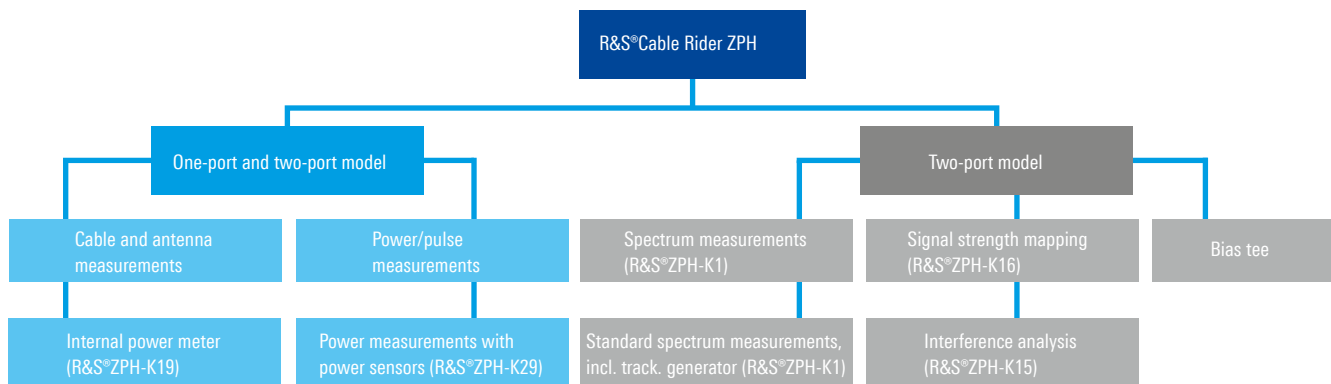

Remote wireless control apps

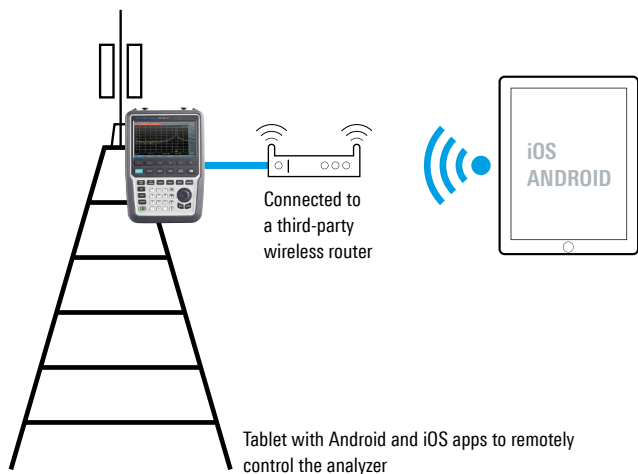

One-step calibration with automatic calibration unit (R&S®ZN-Z103)



Combined OSL calibration kit (R&S®FSH-Z29)



R&S®ZVH Cable and Antenna Analyzer



For more efficiency in the field

Depending on the options installed, the R&S®ZVH can be a cable and antenna analyzer, a two-port vector network analyzer, a power meter or a spectrum analyzer. Free software and apps are available to conveniently remote control the analyzer. The wizard function also allows users to preconfigure test sequences for repeatability and reduce measurement and troubleshooting time.

Model overview

Model (frequency range)	Number of ports	Dynamic range	Port output power	Data points	Measurement mode (standard)
R&S®ZVH4 (100 kHz to 3.6 GHz)	2	100 dB	0 dBm to -40 dBm	101 to 1201	reflection, DTF, one-port cable loss
R&S®ZVH8 (100 kHz to 8 GHz)	2	100 dB	0 dBm to -40 dBm	101 to 1201	reflection, DTF, one-port cable loss

Important facts

Specification	R&S®ZVH	Why this is important
Factory calibration available	•	Ensures accurate measurements even if the field technician forgets the calibration procedure.
Wizard support for common measurement functions	•	Increases repeatable field test patterns and reduces user errors.
Entry bandwidth	3.6 GHz	Determines lowest cost entry point into the family.
Preamplifier	included	Increases sensitivity for low signal level measurements.

Scope of delivery

- ▶ Lithium-ion battery pack
- ▶ LAN cable
- ▶ USB cable
- ▶ AC power supply
- ▶ CD-ROM with software and documentation
- ▶ Quick start guide
- ▶ 3 year warranty (one year for battery and accessories)

Recommended options/accessories

Description	Type
Options	
Remote control via LAN or USB	R&S®ZVH-K40
Transmission measurement	R&S®ZVH-K39
Vector network analysis	R&S®ZVH-K42
Vector voltmeter	R&S®ZVH-K45
Spectrum analysis	R&S®ZVH-K1
Spectrogram measurement application	R&S®ZVH-K14
Power meter	R&S®ZVH-K9
Popular accessories	
Combined open/short/50 Ω load calibration standard, DC to 8 GHz	R&S®FSH-Z28
Combined open/short/50 Ω load calibration standard, DC to 3.6 GHz	R&S®FSH-K29
Lithium-ion battery pack, 6.75 Ah	R&S®HA-Z206
Soft carrying bag	R&S®HA-Z220
Hard case	R&S®HA-Z321
GPS receiver	R&S®HA-Z240



The perfect choice for:	
Installation and maintenance of AM/FM radio stations	RF cable measurement
Antenna measurement	General purpose spectrum measurement

Your benefit	Features
Make the right measurement right away	Wizard function, preconfiguration of settings in advance
An expandable platform for every RF handheld measurement application	Expanded modes of operation for field strength measurements, power measurements, network analysis, vector voltmeter, pulse measurements
Simple wireless remote operation	Free downloadable Android/iOS apps, R&S®MobileView (third-party wireless router required)
Most efficient instrument in the field	<ul style="list-style-type: none"> ▶ Sunlight readable display ▶ Wizard streamlines test development ▶ Remote control and data export with free R&S®Instrument View software ▶ Fast switching of measurement modes ▶ SD card and USB port for data storage

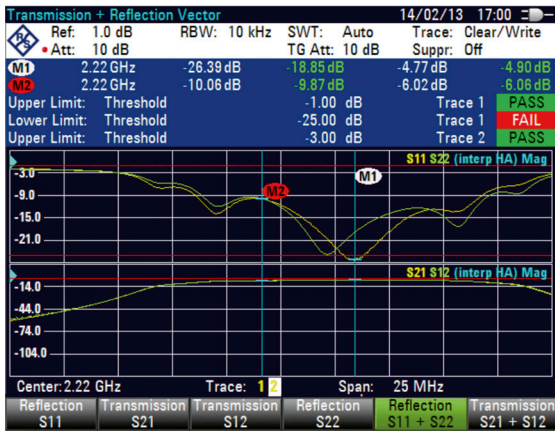

Vector network analysis: Simultaneous display of four S-parameters (S_{11} , S_{21} , S_{12} , S_{22})

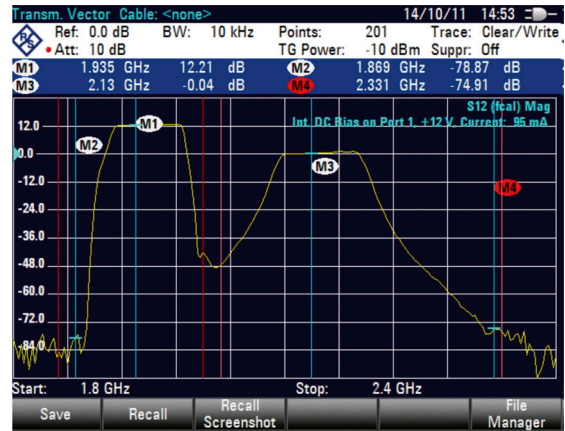

Two-port capability for transmission measurements



Remote control via LAN or USB: The R&S®ZVH can be remotely controlled via the USB or LAN interface and integrated into user-specific programs.

Wizard function: Fast and accurate measurements in three simple steps

- 1 Project manager/expert creates the test sequences
- 2 Operator uses the wizard to execute the test sequences
- 3 Operator shows the measurement result to the project manager/expert and documents it

Remote wireless control apps

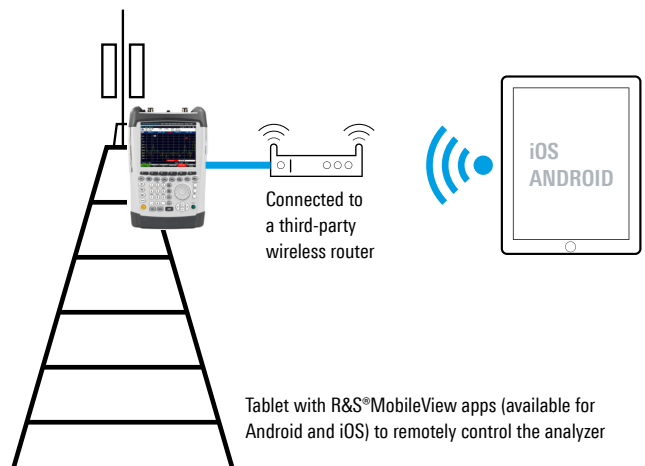

Handheld analyzers

R&S®ZNH Handheld Vector Network Analyzer



Lightweight design, heavyweight performance

R&S®ZNH is a full two-port handheld vector network analyzer that offers one-port cable and antenna measurement and full two-port S-parameter measurements. The touch based interface is simple to operate and a configuration overview menu makes measurement preparation more efficient. The R&S®ZNH may have a small form factor but it is complete in every detail and delivers high performance and all the key functions.

Model overview

Model, frequency range	Number of ports	Basic functions	Dynamic range	Maximum port output power	Trace noise	Measurement points
R&S®ZNH4, 30 kHz to 4 GHz	2	DTF, one-port cable loss, VSWR, return loss, S_{11} , S_{21} , S_{12} , S_{22} (magnitude and phase)	up to 100 dB (typ.)	up to 0 dBm (meas.) (300 kHz ≤ f ≤ 24 GHz)	<ul style="list-style-type: none"> ► magnitude (RMS): 0.0015 dB to 0.0040 dB (typ.) ► phase (RMS): 0.015° to 0.025° (typ.) 	16001
R&S®ZNH8, 30 kHz to 8 GHz						
R&S®ZNH18, 30 kHz to 18 GHz						
R&S®ZNH26, 30 kHz to 26.5 GHz						

Important facts

Specification	R&S®ZNH	Why this is important
Dynamic range	up to 100 dB (typ.)	This allows the instrument to accommodate large variations between the maximum and minimum power levels in a measurement.
Battery operating time	4 h	Long battery life means saves weight by eliminating the need for a spare battery in the field, while still having plenty of power for measurements.
Display	7" capacitive WVGA touchscreen with gesture support	Intuitive operation for faster measurement setup and configuration. Span is set with pinch and zoom.
Receiver architecture	The four-receiver architecture consists of two reference receivers and two test receivers at both port 1 and port 2.	The R&S®ZNH can support more advanced calibration types such as unknown through, open, short and match (UOSM) calibration. Such calibration is useful for DUTs with different input or output connector types at the test ports.

Scope of delivery

- Power cable
- Quick start guide
- 3 year warranty

Recommended options/accessories

Description	Type
Calibration kit, type N (m), 50 Ω, 0 Hz to 18 GHz	R&S®ZN-Z170
Calibration kit, type N (f), 50 Ω, 0 Hz to 18 GHz	R&S®ZN-Z170
Calibration kit, 3.5 mm (m), 50 Ω, 0 Hz to 26.5 GHz	R&S®ZN-Z135
Calibration kit, 3.5 mm (f), 50 Ω, 0 Hz to 26.5 GHz	R&S®ZN-Z135
Calibration kit, 50 Ω, 2 MHz to 4 GHz	R&S®ZN-Z103
Calibration kit, 50 Ω, 1 MHz to 6 GHz	R&S®ZN-Z103
Soft carrying bag	R&S®HA-Z220
Carrying holster	R&S®HA-Z322



The perfect choice for:	
Field testing	R & D
Education	Manufacturing

Highlights

- ▶ Unknown through calibration (UOSM) is possible
- ▶ Various calibration kits are supported
- ▶ Calibration kit information can be entered manually with R&S®InstrumentView software

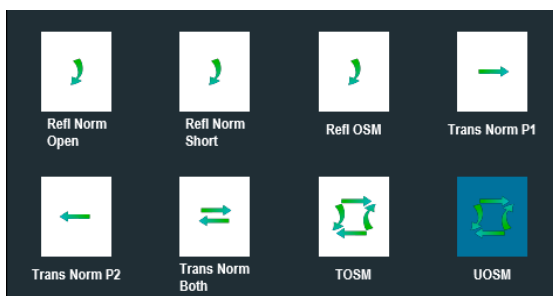

Simple to operate

Intuitive operation using smartphone-like touch gestures

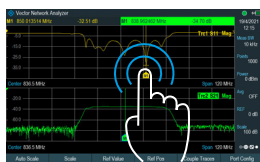

Add a marker with a double tap

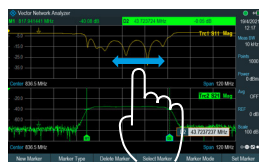

Move a marker by dragging the marker label

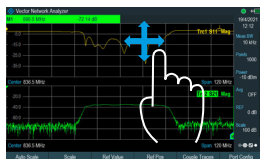

Delete a marker by crossing it out

Simple to configure

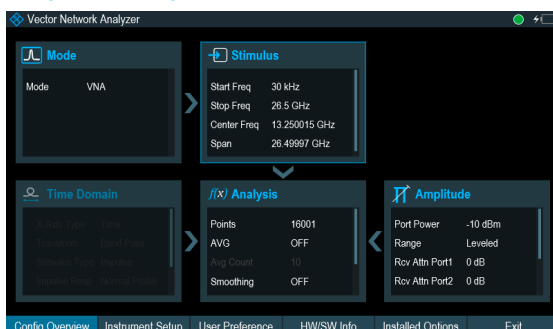

Configurable dashboard for fast parameter setting

Your benefit	Features
Additional protection from overloading without external attenuator	Built-in receiver step attenuator with attenuation from 0 dB to 15 dB in 5 dB steps
Directly calibrate DUTs with different input/output connectors	Using UOSM calibration
Easy operation	<ul style="list-style-type: none"> ▶ Intuitive touchscreen controls smartphone-like touch gestures ▶ Adjustable display brightness and backlit keypad for bright sunlight or dim environments ▶ Wizard function automates test sequences so that recurring measurements are quick, easy and mistake-free ▶ Battery life of four hours when fully charged ▶ Configurable dashboard with overview menu for quick measurement setup and 70% fewer taps
Easy configuration	<ul style="list-style-type: none"> ▶ Flexible calibration approach ▶ Numerous calibration standards and kits are supported. Calibration kit information can be easily entered manually with R&S®InstrumentView software
More functionality	<ul style="list-style-type: none"> ▶ Many functions come standard, such as one-port cable and antenna analysis and full S-parameter measurement ▶ Buy only what you need – options can be ordered independently and without prerequisites ▶ Four-receiver architecture

Handheld analyzers

Preconfigure in three simple steps

Eliminate measurement errors due to wrong inputs

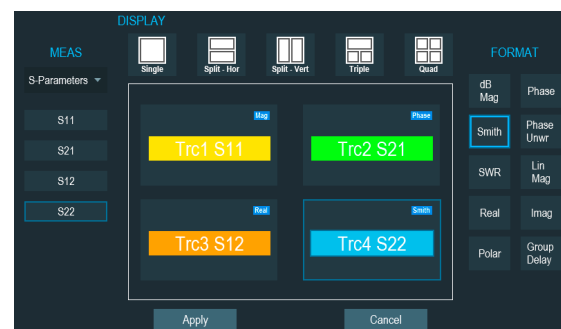
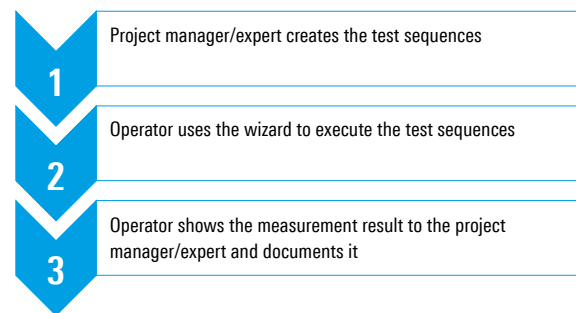

Just a few taps to configure the measurement display and format

SPECTRUM ANALYZERS

The Rohde & Schwarz spectrum analyzer portfolio offers options ranging from low-cost, yet powerful 1 GHz analyzers to full-featured 85 GHz spectrum analyzers. Designed by the RF experts at Rohde & Schwarz, the spectrum analyzers feature exceptional signal integrity, high value and excellent reliability.

Use the table on pages 74 and 68 to see the differences between each family.

Frequency range

The frequency range specifies the range of frequencies over which the spectrum analyzer will operate. Different measurement applications may require a larger frequency range to evaluate harmonics, spurs or alternate channels. In this case, it makes sense to consider a higher frequency model in order to capture all potential signals of interest.

Application example: Detecting the third-order harmonics of a 915 MHz signal requires a spectrum analyzer with a maximum frequency greater than 2.745 GHz.

Dynamic range

The dynamic range is the analyzer's ability to detect weak signals in the presence of strong signals. The dynamic range is limited on the lower end by the analyzer's inherent noise and spurs and on the upper end by nonlinearities. The inherent noise is specified by the displayed average noise level (DANL), given in dBm and normalized to 1 Hz resolution bandwidth.

The nonlinearities are given by the 1 dB compression point, second harmonic distortion and third-order intercept (TOI).

A preamplifier reduces the DANL, which helps detect weak signals but increases other distortions and reduces the overall dynamic range.

An input attenuator with a small step size helps use the maximum dynamic range.

Application example: Spurious emission measurements, EMI debugging: To detect a weak signal of -100 dBm with a resolution bandwidth of 10 kHz and a signal to noise ratio (SNR) of 10 dB, the DANL must be below -110 dBm/10 kHz, which is equivalent to -150 dBm (1 Hz).

Maximum input level



1 dB compression of 1st mixer



Optimum mixer level

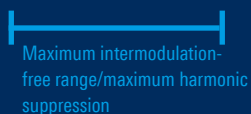

Features and capabilities

Modern spectrum analyzers provide a wide range of options for enhanced signal analysis and ease of use. Possible firm-ware or software options include:

- ▶ Advanced spectrum measurements, e.g. spectrogram, channel power, occupied bandwidth, third-order intercept point
- ▶ I/Q analysis mode with a specific analysis bandwidth for capturing and analyzing signals, including phase information
- ▶ Software for signal demodulation, e.g. AM/FM/PM demodulation, vector signal analysis, signal demodulation in line with specific wireless or mobile standards
- ▶ Certain use cases and measurements require dedicated hardware. Possible hardware options include:
 - Battery operation or 12 V/24 V DC power for portable or vehicular operation
 - Tracking generator for scalar network analysis
 - 28 V DC output for noise figure measurements with a noise source
 - Remote control requires a IEEE-488 (GPIB), LAN or WLAN interface

Application example: Amplitude transmission measurements on an RF filter require a tracking generator.

Phase noise

The spectrum analyzer's inherent phase noise limits measurements very close to a carrier since spurs at e.g. 1 kHz offset may be hidden in the analyzer's phase noise. The inherent phase noise also limits the ability to perform phase noise measurements on the signal source and it impacts error vector magnitude (EVM) measurements on digitally modulated signals, especially narrowband signals.

Application example: To detect a spur at a certain frequency offset at 70 dB below the carrier with a 10 dB SNR and 10 Hz RBW, the SSB phase noise must be below -90 dBc (1 Hz).

Products	Page
R&S®FPC spectrum analyzer	76
R&S®FSC spectrum analyzer	78
R&S®FPL1000 spectrum analyzer	80

Economy spectrum analyzer portfolio



	R&S®FPC	R&S®FSC
Description	bench spectrum analyzer with vector network analyzer and signal generator up to 3 GHz	compact and cost-effective spectrum analyzer
Performance	●	●
Frequency models	5 kHz to 3 GHz (1/2/3 GHz models available)	9 kHz to 6 GHz (3 GHz/6 GHz models available)
Analysis bandwidth	–	–
Phase noise	–92 dBc (1 Hz) (f = 500 MHz, 30 kHz offset)	–95 dBc (1 Hz) (f = 500 MHz, 30 kHz offset)
DANL, at 1 GHz, preamplifier OFF	–150 dBm	–146 dBm
DANL, at 1 GHz, preamplifier ON	–165 dBm	–165 dBm
TOI	+10 dBm	+15 dBm
Highlights	economy spectrum analyzer by combining the value of three instruments: spectrum analyzer, vector network analyzer, signal generator, EMI receiver mode, modulation analyzer (AM/FM/ASK/FSK)	compact spectrum analyzer with great RF performance, small form factor
Dimensions	396 mm × 178 mm × 147 mm (15.6 in × 7.0 in × 5.8 in)	233 mm × 158.1 mm × 350 mm (9.2 in × 6.2 in × 13.8 in)

- The higher the number of points, the higher the performance.



R&S® FPL1000

general purpose spectrum analyzer

•••

5 kHz to 3/7.5/14/26.5 GHz

40 MHz

< -105 dBc (1 Hz)
(f = 1 GHz, 10 kHz offset)

< -149 dBm

< -163 dBm

> 17 dBm

battery, tracking generator;
signal analysis applications: noise, analog demodulation,
vector signal analyzer, NB-IoT (with R&S®VSE), EMI

408 mm × 186 mm × 235 mm
(16.06 in × 7.32 in × 9.25 in)

R&S®FPC Spectrum Analyzer



Spectrum analyzer

The R&S®FPC base instrument has a frequency range from 5 kHz to 1 GHz. With keycode options, it can be unlocked up to 3 GHz and other features can be activated. The R&S®FPC provides the best dynamic range in its class. In combination with RBW settings down to 1 Hz, it resolves the finest details, which are displayed on the high-resolution 10.1" WXGA display. Wired or wireless remote control options are available for free.

Network analyzer

The R&S®FPC features an internal VSWR bridge that makes purchasing and mounting/dismounting an external bridge unnecessary. S_{11} reflection measurements are supported, including Smith chart and DTF features.

The value of three instruments in one

Signal generator

The R&S®FPC not only features standard tracking generator measurements with frequency offset functionality, its signal source is independent to enable signal generator functionality. A CW signal can be set within the frequency range, or in a coupled mode to follow the center frequency setting of the spectrum analyzer mode.

Model (frequency range)	Preamplifier included	Independent signal generator	Tracking generator	Resolution bandwidth	Phase noise	DANL	TOI
R&S®FPC1000 (5 kHz to 1 GHz)	optional	-	-	1 Hz to 3 MHz	< -103 dBc (1 Hz) (f = 500 MHz, 100 kHz offset)	down to -165 dBm (typ.) (with preamplifier)	+7 dBm
R&S®FPC-B2 (5 kHz to 2 GHz, frequency upgrade)							
R&S®FPC-B3 (5 kHz to 3 GHz, frequency upgrade)							
R&S®FPC1500 (5 kHz to 1 GHz)		•	•				
R&S®FPC-B2 (5 kHz to 2 GHz, frequency upgrade)							
R&S®FPC-B3 (5 kHz to 3 GHz, frequency upgrade)							

Specification	R&S®FPC1000	R&S®FPC1500	Why this is important
DANL (normalized to 1 Hz)	< -165 dBm (typ.) (power amplifier = on)		Most "economy" spectrum analyzers sacrifice premium components and superior RF design choices in favor of cost reduction. True RF performance in an economy instrument gives you the confidence of the most accurate measurements within your frequency needs.
TOI	+17 dBm (attenuation = 10 dB)		
Phase noise at 100 kHz offset	< -103 dBc (1 Hz) (typ.)		Visualizing important signal details is not just a matter of the RF specifications; the high-resolution display of the R&S®FPC spectrum analyzers allows hardware signal details to be displayed on screen.
Display	10.1" (1366 x 768 pixel)		
Modulation analysis	spectrum analysis and modulation analysis		A wider range of both modulation and spectrum analysis allow the spectrum analyzer to pair more suitably with a larger range of applications. Modulation analysis can allow demodulation of simple modulation formats such as ASK/FSK as well as AM/FM.
Tracking generator	-	tracking generator model with the unique value of three instruments in one	A spectrum analyzer with tracking generator is most useful for scalar transmission measurements, for example on filters. The R&S®FPC1500 comes with an extra: frequency conversion measurements (enabled by the independent type source of the instrument). This is great for RF mixer characterization.



The perfect choice for:	
R&D and service labs	Test automation
Professionals, hobbyists	Education and training

Your benefit	Features
Value of three	The R&S®FPC1500 combines the value of a spectrum analyzer, a vector network analyzer and a signal generator
More resolution for better measurements	Lowest noise floor in class down to -165 dBm (typ.) (with preamplifier), resolution bandwidth down to 1 Hz, 10.1" WXGA display
Investment protection	All upgrades available via keycode, no additional calibration required

Scope of delivery
▶ Power cable
▶ 3 year warranty (one year for accessories)

Recommended options/accessories	
Description	Type
Modulation analysis	R&S®FPC-K7
Vector network analysis	R&S®FPC-K42
Receiver mode	R&S®FPC-K43
Advanced measurements	R&S®FPC-K55
19" rackmount kit	R&S®ZZA-FPC1
Near-field probes, 30 MHz to 3 GHz (set of 5 probes)	R&S®HZ-15
Amplifier, 100 kHz to 3 GHz	R&S®HZ-16
Near-field probes, 30 MHz to 3 GHz (set of 2 probes)	R&S®HZ-17
Carrying case	R&S®RTB-Z3

Recommended options/accessories	
Description	Type
Spectrum analyzer frequency upgrade, 1 GHz to 2 GHz	R&S®FPC-B2
Spectrum analyzer frequency upgrade, 2 GHz to 3 GHz	R&S®FPC-B3
Spectrum analyzer preamplifier	R&S®FPC-B22
Wi-Fi® connection support	R&S®FPC-B200
Wi-Fi® USB nano flash drive	R&S®FPC-Z2

Highlights

Class-leading spectrum analyzer

✓ Value of three	✓ 10.1" display
✓ Low noise floor	✓ Flexible upgrade concept
✓ High max. input power	✓ Easy to control

Frequency extension using keycodes

Buy what you need when you need it.

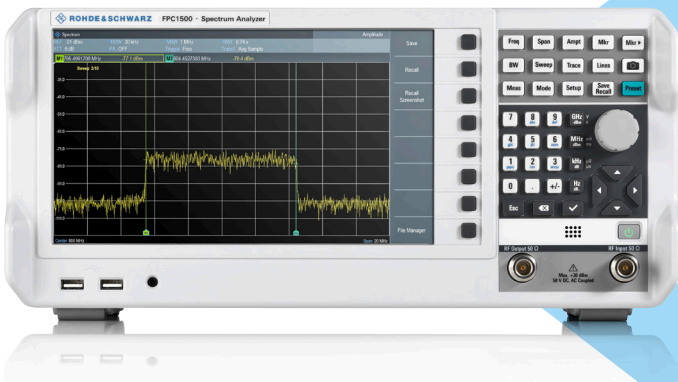
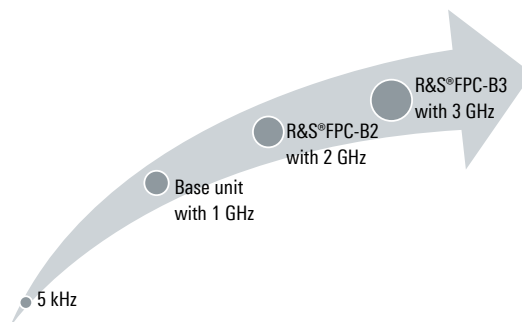

Spectrum analyzer		
Investment protection	High resolution	Easy virtual control
Vector network analyzer		
Internal VSWR bridge	One-port VNA (S ₁₁)	Smith chart
Signal generator		
Tracking generator	Independent signal source	Coupled CW mode

Spectrum analyzers

R&S®FSC Spectrum Analyzer

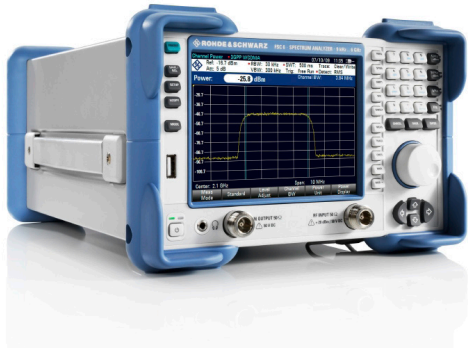

- ▶ **Compact form factor**
The R&S®FSC has the smallest footprint in its class at only 3 HU, 1/2 19". It takes up very little space on a bench. Two R&S®FSC analyzers or one R&S®FSC and an R&S®SMC signal generator fit in just 3 HU of rack space
- ▶ **Cost-effective**
Total cost of ownership is excellent due to affordable initial and calibration costs, plus very low operating cost with only 12 W power consumption

Compact and cost-effective spectrum analyzer

- ▶ **Performance**
 - The R&S®FSC features very good RF performance. Its DANL, TOI and phase noise make it ideal for many standard measurement applications
 - General purpose spectrum analysis presets for spectral characteristics, e.g. harmonics, AM modulation depth and ACLR are included as standard

Model overview							
Model	Frequency range	Preamplifier	Resolution bandwidth	Phase noise	Level measurement uncertainty	DANL	TOI
R&S®FSC3, model .03 (base)	9 kHz to 3 GHz	optional	10 Hz to 3 MHz	-95 dBc (1 Hz), -105 dBc (1 Hz) (typ.)	up to 1 dB, 0.5 dB (typ.)	-161 dBm, -165 dBm (typ.)	> +10 dBm, +15 dBm (typ.)
R&S®FSC3, model .13 (tracking gen.)	9 kHz to 3 GHz				up to 1.5 dB, 0.5 dB (typ.)	-161 dBm, -165 dBm (typ.)	> +10 dBm, +15 dBm (typ.)
R&S®FSC6, model .06 (base)	9 kHz to 6 GHz				up to 1.5 dB, 0.5 dB (typ.)	-155 dBm, -159 dBm (typ.)	> +3 dBm, +10 dBm (typ.)
R&S®FSC6, model .16 (tracking generator)	9 kHz to 6 GHz				up to 1.5 dB, 1 dB (typ.)	-155 dBm, -159 dBm (typ.)	> +3 dBm, +10 dBm (typ.)

Important facts

Specification	R&S®FSC	Why this is important
Tracking generator dynamic range	90 dB (typ.)	Provides higher dynamic range when performing filter measurements.
Phase noise		Lower phase noise enables greater signal detection accuracy close to the carrier.
30 kHz	up to -95 dBc (1 Hz)	
100 kHz	up to -100 dBc (1 Hz)	
1 MHz	up to -120 dBc (1 Hz)	

Recommended options/accessories

Description	Type
Preamplifier for spectrum analyzer	R&S®FSC-B22
19" rackmount kit for two R&S®FSC	R&S®ZZA-T33
19" rackmount kit for one R&S®FSC	R&S®ZZA-T34
Headphones	R&S®FSH-Z36
Near-field probes, 30 MHz to 3 GHz	R&S®HZ-15
Preamplifier for R&S®HZ-15, 100 kHz to 3 GHz	R&S®HZ-16



The perfect choice for:	
R&D service labs	Test automation
Professionals, hobbyists	Education and training

Your benefit	Features
Easy to set up	Owing to its compact design, the R&S®FSC only takes up minimal bench space
Easy to operate	All important settings are available via proper hardkeys, supplemented by softkeys at the bottom of the display
Wide choice	4 base models to fit customer needs

Highlights

Class-leading spectrum analyzer

✓ High RF performance	✓ Low power consumption
✓ Low noise floor	✓ Compact form factor
✓ High max. input power	✓ Easy to control

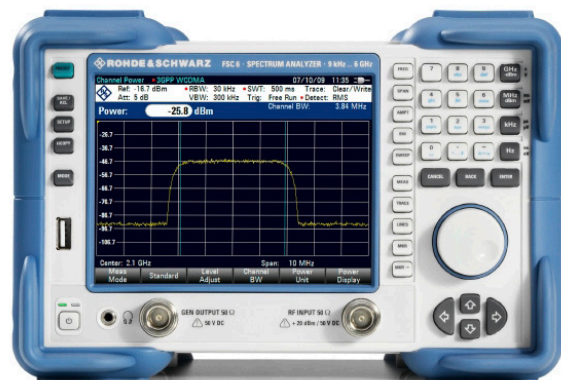

Tracking generator for scalar transmission measurements

Spectrum analyzers

Easy virtual control¹⁾: control it your way, be it wired or wirelessly

Wireless remote control with R&S®MobileView app



Wired/wireless remote control with R&S®InstrumentView PC software



Flexible remote control on demand, anywhere, anytime.

¹⁾ Via a wireless router connected to the instrument's LAN port.

R&S®FPL1000 Spectrum Analyzer



Easy to carry with benchtop performance

The R&S®FPL1000 spectrum analyzer combines excellent RF performance with a small footprint. The light weight and optional battery/DC power make it the ideal instrument for the lab and in the field.

Operating the multi-touch display instrument is intuitive and fun to use. The R&S®FPL1000 supports multiple tasks in one instrument at an attractive price.

Model overview

Model	Frequency range	DANL at 1 GHz	Phase noise (f = 1 GHz, 10 kHz offset)	TOI at 1 GHz	Spurious response	Battery operation
R&S®FPL1003	5 kHz to 3 GHz	-166 dBm (typ.)	-108 dBc (1 Hz) (typ.)	+20 dBm (typ.)	< -70 dBc (typ.)	optional
R&S®FPL1007	5 kHz to 7.5 GHz					
R&S®FPL1014	5 kHz to 14 GHz					
R&S®FPL1026	5 kHz to 26.5 GHz					

Important facts

Specification	R&S®FPL1000	Why this is important
Analysis bandwidth	▶ 10 MHz standard ▶ 40 MHz optional	Digital demodulation possible within the analysis bandwidth.
Spurious	< -70 dBc	Unambiguous detection of small signals.
Phase noise (f = 1 GHz, 10 kHz offset)	< -105 dBc (1 Hz)	Analysis close to the carrier or of narrowband signals.
TOI at 1 GHz	> 17 dBm	Higher dynamic range to detect small signals in the presence of strong ones.
Dimensions (W x H x D)	408 mm x 186 mm x 235 mm	Smaller dimensions leave more space on the workbench and make it easier to integrate into a rack.
Weight	6 kg	Low weight for enhanced portability.
Battery operation	optional	Full portability.

Recommended options/accessories

Description	Type
OCXO frequency reference	R&S®FPL1-B4
Additional interfaces	R&S®FPL1-B5
Internal generator up to 3 GHz/7.5 GHz for R&S®FPL1003/R&S®FPL1007 (factory fitted)	R&S®FPL1-B9
IEEE-488 (GPIB) interface	R&S®FPL1-B10
YIG preselector bypass	R&S®FPL1-B11
Second hard disk (SSD)	R&S®FPL1-B19
RF preamplifier up to 7.5/14/26.5 GHz	R&S®FPL1-B22
1 dB steps for electronic attenuator	R&S®FPL1-B25
DC power supply, 12 V/24 V	R&S®FPL1-B30
Internal lithium-ion battery with charging unit	R&S®FPL1-B31
40 MHz analysis bandwidth	R&S®FPL1-B40

Recommended options/accessories

Description	Type
AM/FM/φM measurement demodulator	R&S®FPL1-K7
Power sensor measurement with R&S®NRP-Zxx power sensors	R&S®FPL1-K9
Noise figure measurement application	R&S®FPL1-K30
Phase noise measurement application	R&S®FPL1-K40
EMI measurement application	R&S®FPL1-K54
Vector signal analysis	R&S®FPL1-K70
Multi-modulation analysis ¹⁾	R&S®FPL1-K70M
BER measurements with PRBS data ¹⁾	R&S®FPL1-K70P

¹⁾ Requires R&S®FPL1-K70.



The perfect choice for:	
Research, education, service and maintenance	General purpose signal analysis and demodulation
Fast and easy integration into automated tests	Basic function test and EMI debugging in R&D

Your benefit	Features
One instrument for multiple tasks	<ul style="list-style-type: none"> ▶ Spectrum analysis ▶ Power meter ▶ Analog and digital signal analysis
More space on your test bench	▶ Smallest footprint in its class (depth of only 23.5 cm)
Take it with you everywhere	<ul style="list-style-type: none"> ▶ Top handle and low weight ▶ Optional battery pack, over 3 h operation ▶ Optional 12 V/24 V DC power supply

Up to 40% more space on your desk

The R&S®FPL1000 leaves up to 40% more space on a typical 80 cm workbench than comparable analyzers. With 60% less weight than comparable analyzers, it is the most portable benchtop analyzer.

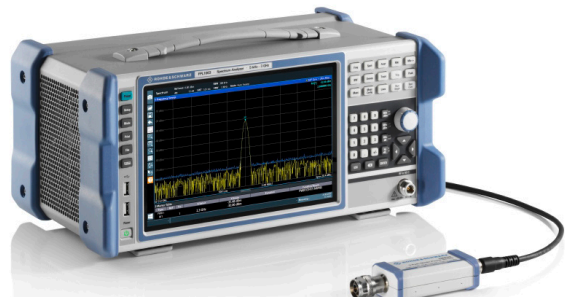
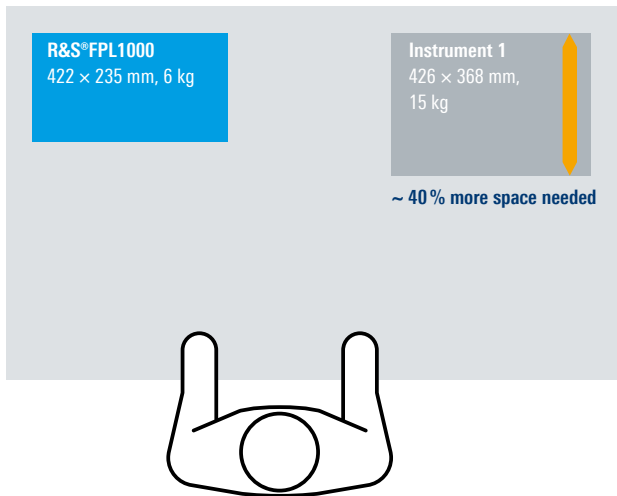

Use as a power meter: Turn the R&S®FPL1000 into a power meter with R&S®NRP power sensors and the R&S®FPL1-K9 option

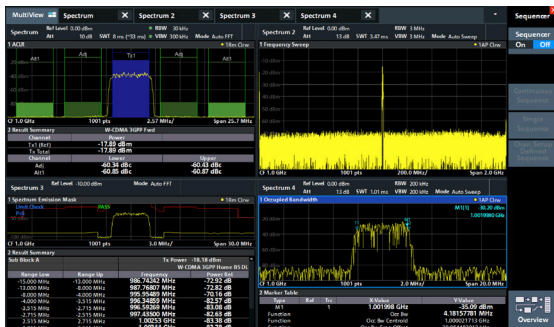

Flexible user interface: Configure your result windows the way you want. Display different measurement channels at once. Sequential channel updating allows parallel measurement of e.g. spectrum, spectrogram, I/Q analysis and analog demodulation.

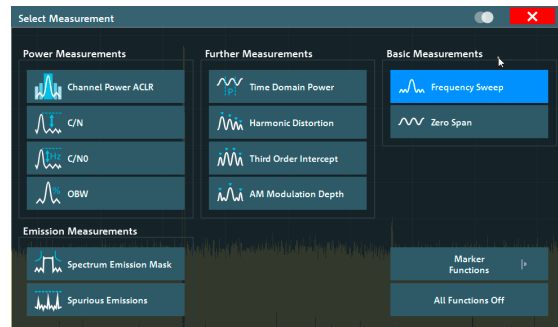

Many predefined measurements: Fast and easy access to a wealth of measurement and marker functions in the base model, including spectrogram measurements and I/Q analysis. Quick configuration through clear menus and touchscreen operation.

Spectrum analyzers

VECTOR NETWORK ANALYZERS

A vector network analyzer (VNA) reveals the response of an electrical network. A VNA includes at least one source to stimulate the device under test (DUT) in the forward and/or reverse direction, typically with frequency or continuous wave (CW) at a certain power, or power sweep at a certain frequency. Its receivers measure the signals that are reflected by or transmitted through the DUT. S-parameters are the most commonly used parameters in VNAs. They are calculated as the ratio between response and stimulus signals and provide information about the DUT characteristics, such as filter rejection and transmission, amplifier gain, cable attenuation and network matching.

Frequency range

The frequency range of a VNA is defined as its minimum and maximum settable frequency values. This is important as it needs to cover the frequency range of the DUT.

Sometimes a value for overrange is given, which allows a wider frequency range than officially specified. The measurement can be configured, but the operator must be aware that there is no performance data specified for the overrange and there might not be a matching calibration kit.

Rule of thumb: The frequency range of a VNA has to match the DUT's requirements.

Dynamic range

Also, the higher the dynamic range, the faster it is possible to measure through the use of wider IFBW. The dynamic range is defined as the difference between the max. source power and the noise floor of the instrument. For the specification of the dynamic range, typically a noise floor at 10 Hz IF bandwidth (IFBW) is used. By selecting a wider IFBW, an engineer can perform faster measurements at the cost of the dynamic range due to the increased noise floor. If the IF bandwidth is increased by a factor of 10, the dynamic range is reduced by approximately 10 dB.

Rule of thumb: Especially for DUTs with very high frequency blocking characteristics, it is important to have a low noise floor so that even signals with higher attenuation can be discerned from the unwanted noise. For accurate measurements, the signal-to-noise ratio (SNR) should be at least 20 dB.

Measurement speed

The measurement speed tells you how fast a measurement can be performed. This is especially critical for production environments, but is also interesting in a laboratory environment.

In general, the measurement speed is mainly determined by the number of measurement points, the IF bandwidth, whether calibration and/or offset are active and what type of calibration is used. If you have a low number of points, a high IF bandwidth and offset and calibration are inactive, the total sweep time can be in the range of milliseconds.

On the contrary, if you have a measurement setup with many channels and traces, a high number of measurement points, a narrow IF bandwidth and active calibration, the total test time can take several minutes.

Rule of thumb: One quick way to decrease the test time for one channel with one trace is to increase the IF bandwidth or reduce the number of points.

Approx. $t_{Test} \approx \text{number of points} / \text{IFBW}$

Passive and active components

It is important to choose the right VNA for measurement of the DUT depending on the required performance and test functions.

If passive components such as filters, cables and attenuators need to be measured, the VNA only needs to be able to perform standard S-parameter measurements and time-domain measurements, for example to know where a cable might be broken. For a simple filter with a high-blocking stopband, you might just need to measure its reflection (S_{11} and S_{22}) or its transmission (S_{21} and S_{12}) S-parameters. However, you still require a high dynamic range to characterize it precisely in its stopband range.

If active components need to be measured, you need to analyze the required test parameters even more carefully to find the appropriate VNA. If you want to measure the compression point of an amplifier, for example, you will need to be able to perform a power sweep and a power calibration, which is not a standard feature in all VNAs.

Products	Page
R&S®ZNL vector network analyzer	86
R&S®ZNLE vector network analyzer	88
R&S®ZND vector network analyzer	90

Vector network analyzer portfolio



	R&S®ZNL	R&S®ZNLE
Frequency range	5 kHz to 20 GHz	100 kHz to 20 GHz
Overrange	–	–
Ports	two N(f) 50 Ω	two N(f) 50 Ω
Test set	bidirectional (S_{11} , S_{12} , S_{21} , S_{22})	bidirectional (S_{11} , S_{12} , S_{21} , S_{22})
Dynamic range	▶ up to 120 dB (spec.) ▶ up to 130 dB (typ.)	▶ up to 110 dB (spec.) ▶ up to 120 dB (typ.)
Number of points	1 to 100001	1 to 5001
IF bandwidth	1 Hz to 500 kHz	1 Hz to 500 kHz
Trace noise	▶ 0.0035 dB (RMS) (spec.) ▶ 0.0005 dB (RMS) (typ.)	▶ 0.005 dB (RMS) (spec.) ▶ 0.001 dB (RMS) (typ.)
Measurement speed (201 points, 100 kHz IF bandwidth, 200 MHz span, two-port calibration)	9.6 ms	9.6 ms
Maximum power	▶ 0 dBm (spec.) ▶ +3 dBm (typ.)	0 dBm
Minimum power	▶ –10 dBm (base unit) ▶ –40 dBm (with R&S®ZNLx-B22)	–10 dBm
Power sweep range	–	–
Power sensor support	available in spectrum analyzer mode	–
Display	25.6 cm (10.1") diagonal WXGA color LCD with touchscreen, 1280 × 800 pixel	25.6 cm (10.1") diagonal WXGA color LCD with touchscreen, 1280 × 800 pixel
Dimensions (W × H × D)	408 mm × 186 mm × 235 mm	408 mm × 186 mm × 235 mm
Weight	6 kg to 8 kg	6 kg
Calibration unit support	●	●
User port	–	–
GPIB interface	○	○
Handler I/O interface	–	–
Time domain	●	–
Distance to fault	●	–
Spectrum analysis	○	–
Power range extension	○	–

● available/yes

– not available/no

○ optional



R&S® ZND
100 kHz to 4.5 GHz or 8.5 GHz (optional)
–
two
<ul style="list-style-type: none"> ▶ unidirectional (S_{11}, S_{21}) ▶ bidirectional (S_{11}, S_{12}, S_{21}, S_{22}) ▶ up to 120 dB (spec.) ▶ 130 dB (typ.)
2 to 5001
1 Hz to 300 kHz
<ul style="list-style-type: none"> ▶ < 0.005 dB (RMS) ▶ 0.001 dB (RMS) (typ.)
12 ms
<ul style="list-style-type: none"> ▶ +3 dBm (spec.) ▶ 10 dBm (R&S®ZND-B7 option) ▶ –20 dBm (spec.) ▶ –45 dBm (R&S®ZND-K7 option)
up to 55 dB (with options)
available in base unit
30.7 cm (12.1") diagonal WXGA color LCD with touchscreen
462.5 mm x 239.6 mm x 361.5 mm
14 kg
•
•
○
○
○
○
–
–
○



R&S®ZNL Vector Network Analyzer



One device for all your measurements

Measurement equipment for RF applications must fulfill high quality standards. Instruments should be easy to use and offer high versatility. Fast measurements and reliable performance are crucial.

With the R&S®ZNL, Rohde&Schwarz exceeds these expectations and offers even more: Vector network analysis, spectrum analysis and power meter measurements are unified in a single, compact instrument, making the R&S®ZNL a universal allrounder.

Model overview

Model	Frequency range	Dynamic range	Output power	IF bandwidth	Measurement speed
R&S®ZNL3	5 kHz to 3 GHz	120 dB (spec.), 130 dB (typ.)	-40 dBm to 0 dBm (spec.)	1 Hz to 500 kHz	16.7 ms for 401 points (100 kHz IFBW, TOSM, 200 MHz span)
R&S®ZNL4	5 kHz to 4.5 GHz				
R&S®ZNL6	5 kHz to 6 GHz				
R&S®ZNL14	5 kHz to 14 GHz				
R&S®ZNL20	5 kHz to 20 GHz				

Important facts

Specification	R&S®ZNL	Why this is important
Frequency	5 kHz to 20 GHz	The measuring instrument has to cover the working frequency range of the DUT.
Dynamic range	120 dB (spec.), 130 dB (typ.)	A high dynamic range is important for measuring e.g. high-rejection filters. It also makes it possible to use a larger IF filter for faster measurement speed.
Output power	-40 dBm to 0 dBm (spec.)	A high output power is needed if you need to measure high-rejection filters (requires more dynamic range) or very long cables.
Speed	16.7 ms for 401 points (100 kHz IFBW, TOSM, 200 MHz span)	Especially in production environments, it is important to measure fast. Because time is money.
Display	•	Having an integrated monitor reduces hassle when configuring measurements.
External PC	not required	The R&S®ZNL just needs to be switched on, and users can start measuring without having to configure an external PC.
Dimensions (W x H x D)	408 mm x 186 mm x 235 mm	The size of the VNA determines how much space is left on the workbench for the measurement setup. It is usually better to have more space.
Weight	6 kg to 8 kg	If the instrument needs to be moved around, it is better to have a lighter instrument.

Scope of delivery

- ▶ Printed operating manual
- ▶ CD with manual
- ▶ Power cable
- ▶ 3 year warranty (one year for battery and accessories)

Recommended options/accessories

Description	Type
Vector network analyzer, 5 kHz to 3 GHz	R&S®ZNL3
Vector network analyzer, 5 kHz to 4.5 GHz	R&S®ZNL4
Vector network analyzer, 5 kHz to 6 GHz	R&S®ZNL6
Vector network analyzer, 5 kHz to 14 GHz	R&S®ZNL14
Vector network analyzer, 5 kHz to 20 GHz	R&S®ZNL20

Recommended options/accessories

Description	Type
Spectrum analyzer function	R&S®ZNLx-B1
Time domain analysis	R&S®ZNL-K2
Distance-to-fault measurements	R&S®ZNL-K3
Independent CW source ¹⁾	R&S®ZNL-K14
AM/FM/φM analog modulation analysis ¹⁾	R&S®FPL1-K7
Measurements with R&S®NRP power sensors ¹⁾	R&S®FPL1-K9

For more information about the R&S®VSE vector signal explorer software and selected options, contact your local Rohde&Schwarz sales office.

¹⁾ Requires R&S®ZNLx-B1 hardware option.



The perfect choice for:	
General purpose RF lab measurements	Low-cost volume manufacturing
Education and training	IoT and wireless manufacturing and troubleshooting

Highlights

- ▶ Widest frequency range from 5 kHz to 20 GHz
- ▶ 3 instruments in 1: vector network analyzer, spectrum analyzer and power meter
- ▶ Optional independent CW signal generator for spectrum analysis
- ▶ Two-port vector network analyzer for bidirectional measurements
- ▶ MultiView operation
- ▶ Wide dynamic range of up to 130 dB (typ.)
- ▶ Output power: from -40 dBm to 3 dBm (typ.)
- ▶ Fast measurements, e.g. 16.7 ms at 100 kHz IFBW (401 points, 200 MHz span, two-port calibration)
- ▶ Compact size and low weight (6 kg to 8 kg)
- ▶ Optional battery pack



MultiView provides a convenient overview of all active R&S®ZNL modes. The figure shows a combination of spectrum analyzer and network analyzer. In this view, all modes can be updated sequentially.

Portable for use on the go: With batteries, the R&S®ZNL can be used outside the labs. Batteries are hot-swappable.



Your benefit	Features
3 instruments in 1, plus an independent CW signal generator	A full two-port VNA that supports true spectrum analyzer hardware (R&S®ZNLx-B1) as well as power sensors (optional), turning it into a power meter. The R&S®ZNL with the R&S®ZNLx-B1 option can also benefit from the R&S®ZNL-K14 option, which allows the stimulation of a DUT by an independent continuous wave generator for analysis in the frequency spectrum domain
Widest frequency range in the market	The R&S®ZNL has an unrivaled frequency operation range. The start frequency at 5 kHz is the lowest in the market for VNAs ranging up to 20 GHz
Fully portable	The R&S®ZNL is very lightweight (6 kg to 8 kg) and very compact (408 mm x 235 mm footprint) and has a top handle for easy transport. The battery pack allows it to be used on the go
Clearly structured user interface with multi-touch	Wide capacitive touchscreen for convenient configuration with multi-touch gesturing. Undo/redo softkeys and fully integrated context-sensitive help menu for user-friendly operation
Compatible with R&S®VSE	The R&S®ZNL is fully compatible with the R&S®VSE vector signal explorer software and selected options for in-depth analysis of the device under test

Compact, lightweight instrument

The R&S®ZNL saves up to 67% of desk space, leaving plenty of room for the measurement setup.

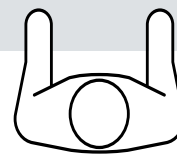
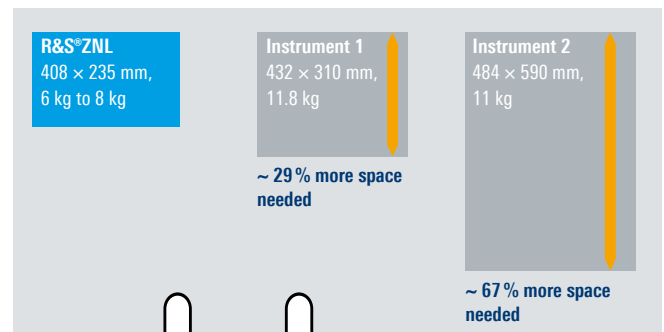

A padded soft carrying bag for safe transportation of the R&S®ZNL.



Vector network analyzers

R&S®ZNLE Vector Network Analyzer



Vector network analysis made easy

With the R&S®ZNLE, vector network analysis measurements are as easy as ABC: easy to use, easy to calibrate, easy to configure.

Fast measurement speeds, reliable RF performance and a clearly structured user interface make the R&S®ZNLE the perfect choice for vector network analysis measurements on passive components.

Model overview

Model	Frequency range	Dynamic range	Output power	IF bandwidth	Measurement speed
R&S®ZNLE3	100 kHz ¹⁾ to 3 GHz	110 dB (spec.), 120 dB (typ.)	0 dBm	1 Hz to 500 kHz	16.7 ms for 401 points (100 kHz IFBW, TOSM, 200 MHz span)
R&S®ZNLE4	100 kHz ¹⁾ to 4.5 GHz				
R&S®ZNLE6	100 kHz ¹⁾ to 6 GHz				
R&S®ZNLE14	100 kHz ¹⁾ to 14 GHz				
R&S®ZNLE18	100 kHz ¹⁾ to 18 GHz ²⁾				

¹⁾ With R&S®ZNLE-B100 option.

²⁾ 20 GHz overrange.

Important facts

Specification	R&S®ZNLE	Why this is important
Frequency	100 kHz to 20 GHz	The measuring instrument has to cover the working frequency range of the DUT.
Dynamic range	110 dB (spec.), 120 dB (typ.)	A high dynamic range is important for measuring e.g. high-rejection filters. It also makes it possible to use a larger IF filter for faster measurements.
Output power	up to 0 dBm	High output power is required when measuring high-rejection filters (requires more dynamic range) or very long cables.
Speed	16.7 ms for 401 points (100 kHz IFBW, TOSM, 200 MHz span)	Especially in production environments, measurements need to be fast. Because time is money.
Display	•	An integrated monitor reduces hassle when configuring measurements.
External PC	not required	The R&S®ZNLE just needs to be switched on, and users can start measuring without having to configure an external PC.
Dimensions (W x H x D)	408 mm x 186 mm x 235 mm	VNA size determines how much space is left on the workbench for the measurement setup. It is usually better to have more space.
Weight	6 kg	If the instrument needs to be moved, a lighter instrument is better.



R&S®ZN-ZE1x calibration units can be used with the R&S®ZNLE to conveniently and quickly perform system error correction.

Scope of delivery

- ▶ Power cable
- ▶ Operating manual
- ▶ CD with manual
- ▶ 3 year warranty

Recommended options/accessories

Description	Type
Vector network analyzer, 1 MHz to 3 GHz	R&S®ZNLE3
Vector network analyzer, 1 MHz to 4.5 GHz	R&S®ZNLE4
Vector network analyzer, 1 MHz to 6 GHz	R&S®ZNLE6
Vector network analyzer, 1 MHz to 14 GHz	R&S®ZNLE14
Vector network analyzer, 1 MHz to 18 GHz ²⁾	R&S®ZNLE18
Extended frequency range, lower end, 1 MHz to 100 kHz	R&S®ZNLE-B100
Time domain analysis	R&S®ZNL-K2
Distance-to-fault measurements	R&S®ZNL-K3
GPIB interface	R&S®FPL1-B10



The perfect choice for:	
Passive RF components tests	Education and training
Automated testing	Production environment

Your benefit	Features
Solid performance in an economic instrument	Standalone vector network analyzer with fast measurement speed and low trace noise
Clearly structured user interface with multi-touch display	Wide capacitive touchscreen for convenient configuration with multi-touch gesturing. Undo/redo softkeys and fully integrated context-sensitive help menu for user-friendly operation
Standard instrument for use in the lab	De/embedding, fixture compensation, support of automatic calibration units and remote control via LAN or IEEE-488 (GPIB)
Precise time-domain measurements	The broad frequency range from 100 kHz (with R&S®ZNLE-B100 option) to 20 GHz (overrange) makes the R&S®ZNLE ideal for measurements in the time domain, where spatial resolution is crucial

Highlights

- ▶ Broad frequency range: from 100 kHz to 20 GHz
- ▶ Time domain and distance-to-fault options for deeper analysis of filters and cables
- ▶ Compact standalone vector network analyzer with fully integrated PC
- ▶ Fast measurement speeds
- ▶ Innovative user interface and wide 10.1" multi-touch display
- ▶ Windows 10 operating system
- ▶ Support of calibration units

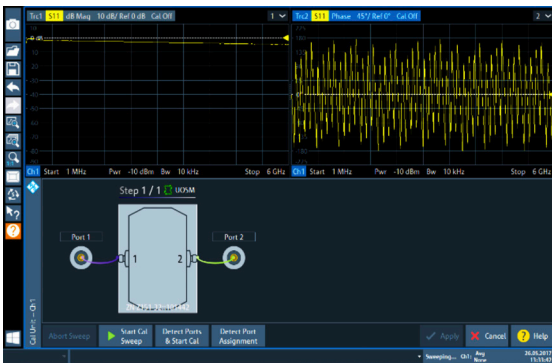

Automatic calibration units supported for convenient automatic system error correction. To be even quicker, one-step autocalibration is available.

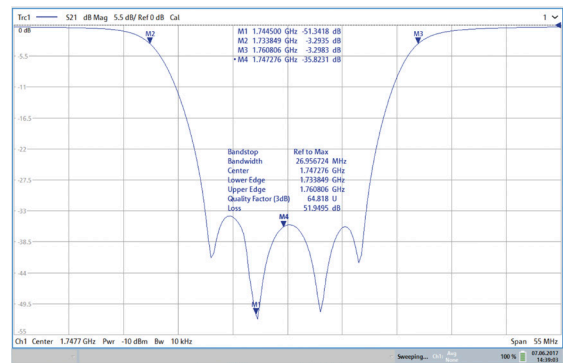

Vector network analysis: Automatic filter characterization with advanced marker functions – all important values in one step

Up to 67% more space on your desk

The R&S®ZNLE leaves up to 67% more space on a typical 80 cm workbench than comparable analyzers. Weighing 60% less than comparable analyzers, it is the most portable benchtop analyzer. The R&S®ZNLE fits easily on any desk for convenient everyday measurements such as tuning a filter.



R&S®ZNLE 408 × 235 mm, 6 kg	Instrument 1 432 × 310 mm, 11.8 kg	Instrument 2 484 × 590 mm, 11 kg
	~ 29% more space needed	~ 67% more space needed

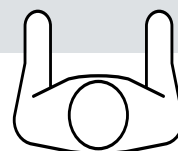

R&S®ZND Vector Network Analyzer

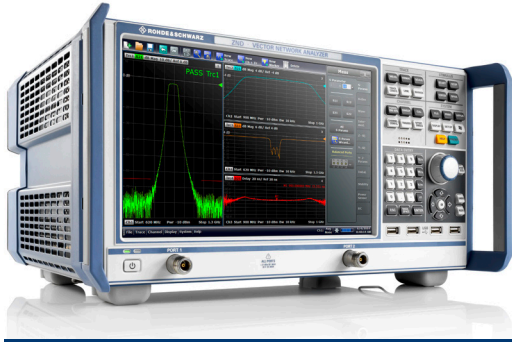

The analyzer that grows with your requirements

The R&S®ZND is a base network analyzer that provides unidirectional measurements up to 4.5 GHz. Options are available to perform bidirectional measurements and to extend the frequency range to 8.5 GHz.

Model overview

Model	Frequency range	Dynamic range	Maximum output power	No. of points	IF bandwidth	Measurement speed
R&S®ZND	100 kHz to 4.5 GHz	▶ up to 120 dB (spec.) ▶ up to 130 dB (typ.)	+3 dBm (spec.)	2 to 5001	1 Hz to 300 kHz	12 ms ¹⁾
R&S®ZND	100 kHz to 8.5 GHz (option)					

¹⁾ 201 points, 200 MHz span, 100 kHz IF bandwidth, 2-port calibration on.

Important facts

Specification	R&S®ZND	Why this is important
Frequency range	100 kHz to 4.5 GHz or 8.5 GHz	This has to cover the working frequency range of the DUT.
Dynamic range	▶ up to 120 dB (spec.) ▶ up to 130 dB (typ.)	A high dynamic range is important for the measurement of e.g. high blocking filters, and it allows the use of larger IF filter for faster measurement speed.
Power sweep range	-45 dBm to +3 dBm (spec.) with option	Characterizing amplifiers requires a wide power sweep range. To avoid saturating the amplifier, the VNA needs to be able to generate a low power stimulus.
IFBW	1 Hz to 300 kHz	Narrow IFBW is required to provide a high dynamic range and wide IFBW reduces measurement times.
Measurement speed	13 ms (401 points, 200 MHz span, 300 kHz IFBW, full calibrated)	Especially in an production environment it is important to measure fast.
Trace noise	< 0.005 dB (RMS)	For accurate measurements a low trace noise is needed.
Dimensions (W x H x D)	461.1 mm x 239.9 mm x 351.0 mm	This determines how much space is needed for the whole setup, as you always need space in front of the VNA for the measurement setup.
Weight	13.5 kg	

Scope of delivery

- ▶ Quick start guide
- ▶ CD with manual
- ▶ Power cable
- ▶ 3 year warranty

Recommended options/accessories

Hardware options	Type
High output power	R&S®ZND-B7
GPIB interface	R&S®ZND-B10
Additional removable hard disk	R&S®ZND-B19
Handler I/O	R&S®ZN-B14
Extended frequency range, unidirectional, 8.5 GHz	R&S®ZND-K1
Time domain analysis (TDR)	R&S®ZND-K2
Full test set, base unit, bidirectional, 4.5 GHz	R&S®ZND-K5
Full test set, bidirectional, 8.5 GHz	R&S®ZND-K6
Extended power range for R&S®ZND	R&S®ZND-K7
Extended frequency range, full test set, bidirectional, 8.5 GHz	R&S®ZND-K8



The perfect choice for:	
Passive and simple active RF components tests	Education
Production tests and repair	Engineering office

Your benefit	Features
Grows with your requirements	The base unit is a 4.5 GHz unidirectional test set. This can be upgraded via key codes to enable the bidirectional test set and to change the upper frequency limit to 8.5 GHz. If more features are needed, transition to the higher class R&S®ZNB is easy, as they have the same form factor, user interface and overlapping remote control commands
Solid RF performance	Output power of up to +10 dBm, dynamic range up to 130 dB
Easy to operate	12.1" touchscreen with 1280 × 800 pixel resolution, flat menu structures for efficient operation. Flexible display configuration for each measurement task

Upgrade options for R&S®ZND base unit

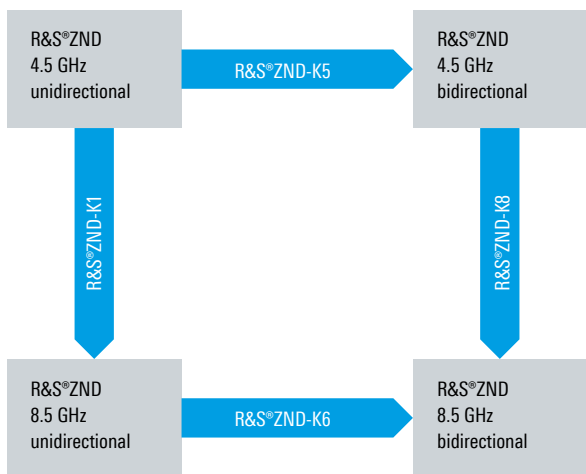

Unidirectional/bidirectional test set

The unidirectional test set incorporated in the R&S®ZND can be used to test passive components such as filters, connectors and antennas.

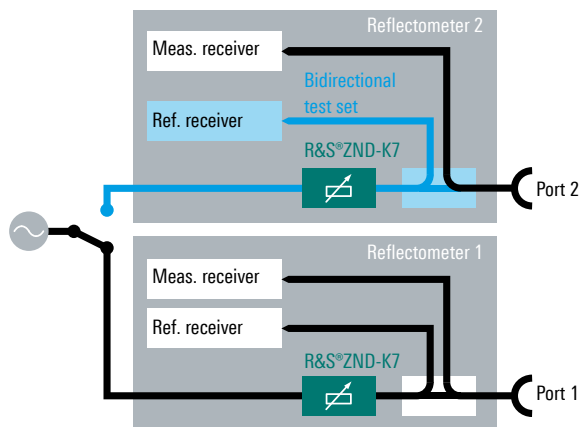

Clearly structured user interface

- Large color touchscreen (12.1")**
Clearly arranged display of many traces
- Toolbar**
Fast access to frequently used functions
- Soft panel**
Optionally on the right or left, for direct instrument control without submenus
- Logically arranged hardkeys**
Just a few keystrokes to desired configuration

Preloaded setups
Switchover between instrument setups by clicking a tab

Over 100 channels and traces
Display of all parameters

Pop-up menus
Fast access to desired function

Widely spaced test ports
Easy connection of DUT
Plenty of space for connecting test cables

Transparent dialog windows
Traces remain visible

USB connectors for auxiliary equipment
Connection of power sensor, automatic calibration unit, mouse/keyboard, memory stick

Online help
Context-sensitive, including remote control commands

Undo/Redo
Cancels or restores the last one to six entries



EMC PRECOMPLIANCE

Products	Page
R&S®ESL EMI test receiver	93
R&S®EPL1000 EMI test receiver	94

Solutions from Rohde & Schwarz

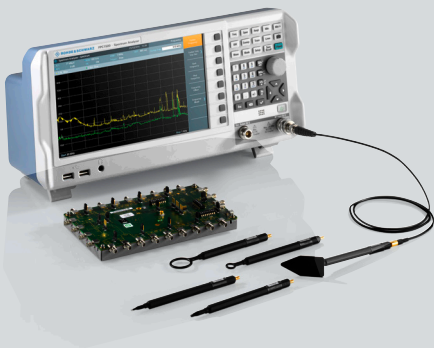

R&S®FPC-K43 receiver mode

The R&S®FPC offers the optional R&S®FPC-K43 receiver mode for EMI debugging on circuit boards, integrated circuits or cable shielding. It includes the ability to record two traces as well as to display a logarithmic scale of the frequency axis. The R&S®FPC-B22 preamplifier compensates for coupling loss of probes and increases sensitivity to detect small interfering signals.

Cost effective yet powerful, the R&S®FPC can be used to analyze and locate disturbance sources during development.

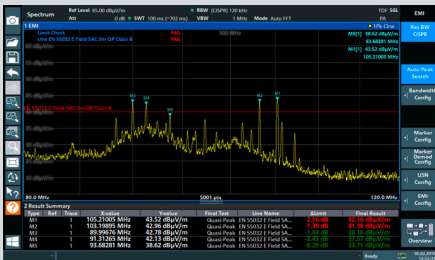

R&S®FPL1-K54 EMI measurement

The R&S®FPL1-K54 EMI measurement application adds EMI diagnostic functions to the R&S®FPL1000 signal and spectrum analyzer. The R&S®FPL1-K54 offers EMI bandwidths for commercial and military applications, detectors including quasi-peak, CISPR-average and RMS-average, limit lines and correction factors. Up to 200001 user-defined sweep points enable higher frequency resolution regardless of large or small span and bandwidths settings.



R&S®ELEKTRA EMC test software

The R&S®ELEKTRA EMC test software controls complete EMC systems and automates measurements of equipment under test (EUT) being certified for emissions (EMI) and immunity (EMS). R&S®ELEKTRA simplifies configuration of test systems and test descriptions in accordance with common standards. It speeds up test execution and paves the way to quickly generating a comprehensive test report.

R&S®ESL EMI Test Receiver



Compact, cost-effective measuring receiver

The R&S®ESL EMI test receiver combines two instruments in one: measuring EMC disturbances in line with commercial standards and also serving as a full-featured spectrum analyzer for diverse lab applications. The R&S®ESL is designed to meet the needs of cost-conscious users who want to perform diagnostic and precompliance EMI measurements up to 3 GHz or 6 GHz.

Model (frequency range)	Measurement range	Amplitude accuracy	DANL with preamplifier	Resolution bandwidths	Tracking generator
R&S®ESL3 (9 kHz to 3 GHz)	-70 dBm to +23 dBm	0.5 dB	< -152 dBm (1 Hz)	10 Hz to 10 MHz (-3 dB), 200 Hz, 9 kHz, 120 kHz (-6 dB), 1 MHz (impulse)	not available
R&S®ESL3 (9 kHz to 3 GHz)					integrated
R&S®ESL6 (9 kHz to 6 GHz)					not available
R&S®ESL6 (9 kHz to 6 GHz)					integrated

Scope of delivery
<ul style="list-style-type: none"> ▶ Power cable ▶ Quick start guide ▶ CD-ROM (with operating manual and service manual) ▶ 3 year warranty

Recommended options/accessories	
Description	Type
OCXO reference frequency	R&S®FSL-B4
Additional interfaces (video out, IF out, noise source control, AUX port, R&S®NRP-Zxx power sensor)	R&S®FSL-B5
Gated sweep	R&S®FSL-B8
AM/FM/φM measurement demodulator	R&S®FSL-K7
Power sensor support (requires R&S®FSL-B5 or R&S®NRP-Z3/-Z4)	R&S®FSL-K9

The perfect choice for:	
EMI measurements and debugging of commercial products	EMC labs
Standard RF spectrum measurements	Development and mobile users

Your benefit	Features
EMI measurements	<ul style="list-style-type: none"> ▶ Very good RF characteristics ▶ Frequency range covering the most important EMI measurements in commercial product standards ▶ All CISPR weighting detectors included ▶ All major functions of an advanced EMI test receiver, including fully automated EMI test sequences
Compact and mobile	<ul style="list-style-type: none"> ▶ Rugged case as standard ▶ Compact size ▶ Lightweight ▶ Optional battery operation for installation, maintenance and on-site applications
Standard RF spectrum measurements	Complete functionality of an R&S®FSL3/ R&S®FSL6 spectrum analyzer included

EMC precompliance



R&S®EPL1000 EMI Test Receiver



New

Quick, precise and compliant EMI measurements up to 30 MHz

The R&S®EPL1000 fully complies with CISPR16-1-1. The very fast time domain scan can check the complete CISPR bands A or B in a single shot. Built-in preselection ensures a high dynamic range and enables the acquisition of short pulses. The R&S®EPL1000 offers four-channel click rate analysis, a spectrogram function, IF analysis and further functions for detailed analysis. Automation simplifies measurements and ensures exact reproducibility of test sequences. These and many more functions make the R&S®EPL1000 ideal for conducted voltage and current measurements. Typical applications include precompliance measurements, precertification and certification in line with IEC, EN, CISPR and FCC.

Important facts		
Specification	R&S®EPL1000	Why this is important
Fast time domain scan	RBW = 9 kHz, frequency segment 29.85 MHz, RBW = 120 kHz, frequency segment 24.6 MHz	It measures one CISPR band (band A or B) in one shot. This keeps overall measurement times small and enables fast identification of infrequent emissions.
Click rate analyzer	<ul style="list-style-type: none"> ▶ CISPR 14-1 ▶ DENAN-law 	The R&S®EPL1-K59 click rate analyzer has everything you need for CISPR 14-1 compliant discontinuous disturbance measurements (click measurements). These measurements can be easily configured and run for a defined period of time or until a specific number of clicks are detected. The measured values are automatically evaluated in line with CISPR 14-1 edition 6 or 7 and a PASS/FAIL information is given.

Scope of delivery
<ul style="list-style-type: none"> ▶ Power cable ▶ Quick start guide ▶ 1 year warranty

Recommended options/accessories	
Description	Type
EMI test receiver, 5 kHz to 30 MHz	R&S®EPL1000
Hardware options	
Internal generator, 5 kHz to 30 MHz	R&S®EPL1-B91
Replacement SSD, including controller unit	R&S®EPL1-B19
OCXO, precision frequency reference	R&S®FPL1-B4
GPIO interface	R&S®FPL1-B10
DC power supply for 12 V/24 V supply voltage	R&S®FPL1-B30
Lithium-ion battery pack, with controller unit for internal battery slot	R&S®FPL1-B31

Recommended options/accessories	
Keycode options	
Click rate analyzer	R&S®EPL1-K59
IF analysis	R&S®EPL1-K56
AM/FM/PM measurement demodulator	R&S®FPL1-K7
Protective hard cover	R&S®EPL1-Z1
Soft carrying bag, for transport and outdoor operation	R&S®EPL1-Z2
H-style shoulder harness (requires R&S®FPL1-Z2 option)	R&S®EPL1-Z3
Spare lithium-ion battery pack	R&S®FPL1-Z4
Antiglare display film, for outdoor operation	R&S®FPL1-Z5
19" rackmount kit	R&S®EPL1-Z6
Lithium-ion battery charger, for charging spare batteries	R&S®FSV-B34
Accredited calibration	R&S®ACAEP1000
Documentation of calibration values	R&S®DCV-2



The perfect choice for:	
Product certification and precertification	Basic function test and EMI debugging in R&D
Research, education and government	Testing for commercial products against IEC, EN, CISPR and FCC

Your benefit	Features
Precise and standard-compliant EMI identification	R&S®EPL1000 meets CISPR 16-1-1, MIL-STD-461 and DO-160 requirements and can be used to develop and certify a wide range of electrical products for both commercial and military.
Fast measurements thanks to time domain scan	With a single scan, it can measure an entire CISPR band (A or B). This enables fast and reliable detection of sporadic emissions
Automation of measurements	Automatic measurement of: <ul style="list-style-type: none"> ▶ Multiple frequency segments with individual settings ▶ Multiple lines connected to a LISN
Comprehensive EMI analysis functions	Includes click rate analyzer, bargraph, spectrogram, zero span, IF analysis, AM/FM output and spectrum analysis functions
Simple integration into EMI test systems	R&S®EPL1000 can be integrated into TCP/IP network via its Ethernet interface. This allows remote control using SCPI commands to EMC test software like R&S®ELEKTRA.

Fast measurement with time domain scan

The R&S®EPL1000 can measure an entire CISPR band (A or B) in a single shot, for much shorter total measurement times. Highly parallelized measurements enable longer gap-less checks of relatively large frequency segments and reliable and fast detection of sporadic emissions.

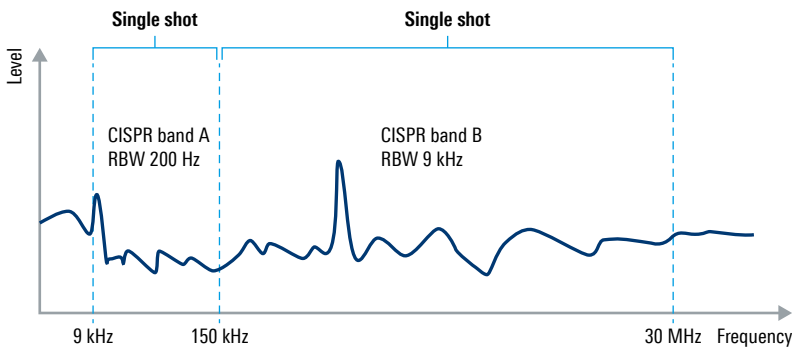

Precise and standard-compliant EMI identification

The R&S®EPL1000 meets CISPR 16-1-1 requirements and also supports the decadic 6 dB bandwidths require by MIL-STD-461 and DO-160. The R&S®EPL1000 can be used to develop and certify a wide range of electrical products.

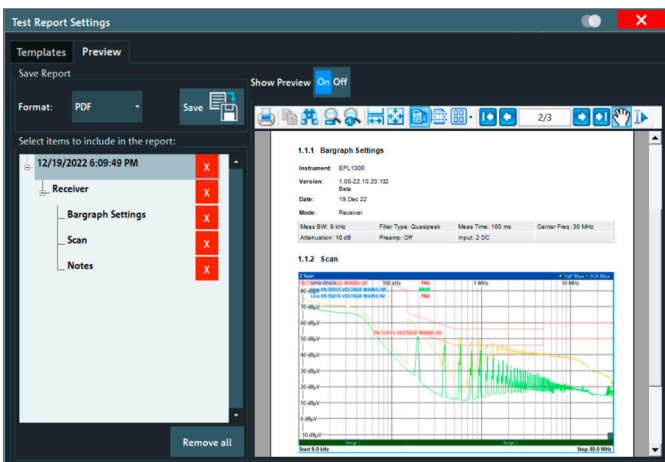

METERS AND ANALYZERS

What is an LCR bridge/meter?

An LCR bridge measures impedance parameters such as inductance, capacitance and resistance of an electronic component. Benchtop LCR meters typically have selectable test frequencies of more than 100 kHz to create data points at multiple spot frequencies. They often include options to superimpose a DC voltage or current on the AC measuring signal. In addition, benchtop meters allow the usage of special fixtures to measure surface mount device (SMD) components, air core coils and transformers. Often used in a general capacity, LCR bridges/meters can be used to validate and test development components during incoming inspection and to determine variations between parts. With fast measurements that shorten test times and binning interfaces to control a handler/sorter, LCR bridges/meters are also ideal for production facilities.

What is an arbitrary waveform generator?

An arbitrary waveform generator (AWG) generates electrical waveforms. It is usually used to test all aspects of a receive (RX) device to determine performance limits and unexpected behavior. AWGs can generate signals that closely approximate real-world signals, both wanted signals and interferers. The generated signals can be modified in precise ways to operate the receivers as usual or at performance limits.

Unlike function generators, AWGs can generate any arbitrarily defined waveform at their output. Some AWGs also operate as conventional function generators to produce standard waveforms such as sine, square, ramp, triangle, noise and pulse. Some units include additional built-in waveforms such as exponential rise and fall times, $\sin x/x$ and ECG. Some AWGs allow users to retrieve waveforms from a number of digital and mixed-signal oscilloscopes.

What is a power analyzer?

The power analyzer measures and characterizes both AC and DC power. Basic power analyzers provide fundamental numerical measurements, while advanced power analyzers support a wider range of both numerical and graphical measurements, including advanced analysis functions such as inrush current characterization and harmonic analysis. In addition to these measurements, some analyzers facilitate automated conformance tests for standby and harmonic measurements.

What is a digital multimeter?

Digital multimeters form the backbone of electronic measurements, supporting engineers in a wide range of applications. These devices measure voltage, current and resistance, combining the features of a voltmeter, ammeter and ohmmeter in a single device. Accuracy and speed are the most important parameters of digital multimeters, with usability a close third. This makes them invaluable for circuit troubleshooting, component testing and system validation.

Products	Page
R&S°LCX LCR meter	98
R&S°NPA power analyzers	100
R&S°HMC8012 digital multimeter	102

R&S®LCX LCR Meter



What sets this LCR meter apart?

- ▶ Fast, accurate and versatile
- ▶ Upgradeable frequency range
- ▶ Test signals for all requirements
- ▶ DC bias
- ▶ Data logging function
- ▶ High-resolution touchscreen
- ▶ Versatile test fixtures

Model overview					
Model	Measurement functions	Frequency range	Test signal voltage (RMS)	Test signal current (at 100 Ω)	Internal bias voltage
R&S®LCX100		DC, 4 Hz to 300 kHz	10 mV to 10 V	0.1 mA to 100 mA	
R&S®LCX200	Cp, Cs, Lp, Ls, D, Q, G, Rp, Rs, Rdc, R, X, Z, Y, Θd, Θr, B, M, N	DC, 4 Hz to 500 kHz (1 MHz or 10 MHz optional)	≤ 1 MHz: 10 mV to 10 V, ≤ 5 MHz: 50 mV to 2 V, > 5 MHz: 100 mV to 1 V	≤ 1 MHz: 0.1 mA to 100 mA, ≤ 5 MHz: 0.5 mA to 20 mA, > 5 MHz: 1 mA to 10 mA	0 V to 10 V

Important facts		
Specification	R&S®LCX100, R&S®LCX200	Why this is important
Test fixtures	R&S®LCX-Z1, R&S®LCX-Z2, R&S®LCX-Z3, R&S®LCX-Z4, R&S®LCX-Z5, R&S®LCX-Z11	Versatile fixtures for lead-type devices, SMD components and transformers to perform measurements quickly.
Triggering	continuous, manual, or remote control via binning interface or trigger input	Accommodates more complex manufacturing setups.
Data logging	data rate up to 10 sample/s	Records measured values every 100 ms.
Interfaces	standard: USB, LAN; optional: IEEE-488 (GPIB)	Most operations for an LCR meter are programmed. Having a modern and easy to use interface helps minimize input errors.

Scope of delivery
3 year warranty

Recommended options/accessories	
Description	Type
LCR meter, 300 kHz, base unit	R&S®LCX100
LCR meter, 500 kHz, base unit	R&S®LCX200
Advanced analysis functions	R&S®LCX-K106
Digital I/O ports and binning function	R&S®LCX-K107
Extended bias functions	R&S®LCX-K108
Frequency upgrade to 1 MHz, for R&S®LCX200	R&S®LCX-K201
Frequency upgrade to 10 MHz, for R&S®LCX200	R&S®LCX-K210
IEEE-488 (GPIB) interface, for R&S®NGP/LCX	R&S®NG-B105
Test fixture for axial/radial lead type devices	R&S®LCX-Z1
Kelvin clip lead	R&S®LCX-Z2
Test fixture for SMD components	R&S®LCX-Z3
Test tweezers for SMD components	R&S®LCX-Z4
Transformer test cables	R&S®LCX-Z5
BNC extension, length: 1 m	R&S®LCX-Z11
19" rack adapter, 2 HU	R&S®ZZA-GE23



The perfect choice for:

Component R&D

Component production

Service and testing

Education

R&S®LCX-Z1



R&S®LCX-Z3



R&S®LCX-Z4



R&S®LCX-Z2



R&S®LCX-Z11



R&S®LCX-Z5



Test fixtures for a wide range of applications: LCR meters from Rohde & Schwarz can perform measurements on a wide range of components. Test fixtures are available that match the shape of the component.



Display and usability: Up to four measurement parameters can be shown on the display at the same time with additional information

Your benefit

Versatile functionality, all frequently used measurements supported

DC measurements and test signal frequencies of up to 10 MHz

Easy to use

Features

▶ Performs the full range of measurements required to characterize resistors, capacitors and inductors

▶ Frequency range from 4 Hz to 300 kHz
▶ Upper frequency limit of 500 kHz; extendable to 1 MHz or 10 MHz using software options

▶ Modern and intuitive operation thanks to a large capacitive touchscreen
▶ Frequently used functions directly accessible via the front panel keys

List of measurement functions

Cp	Capacitance value measured with parallel-equivalent circuit model
Cs	Capacitance value measured with series-equivalent circuit model
Lp	Inductance value measured with parallel-equivalent circuit model
Ls	Inductance value measured with series-equivalent circuit model
D	Dissipation factor
Q	Quality factor (inverse of D)
G	Equivalent parallel conductance measured with parallel-equivalent circuit model
Rp	Equivalent parallel resistance measured with parallel-equivalent circuit model
Rs	Equivalent series resistance measured with series-equivalent circuit model
Rdc	Direct current resistance
R	Resistance
X	Reactance
Z	Impedance
Y	Admittance
θ_d	Phase angle of impedance/admittance (degree)
θ_r	Phase angle of impedance/admittance (radian)
B	Susceptance
M	Mutual inductance
N	Turns ratio

Options for advanced applications

▶ R&S®LCX-K106 advanced analysis functions

For dynamic impedance measurements that sweep the frequency, voltage or current of the test signal or bias signal

▶ R&S®LCX-K107 digital I/O ports and binning function

Includes trigger input and eight data lines for binning

▶ R&S®LCX-K108 extended bias functions

External DC bias voltage of up to 40 V and internal bias source in current regulation mode of up to 200 mA (DC)

▶ R&S®LCX-K201/-K210 frequency upgrade

Upgrade to 1 MHz/10 MHz for the R&S®LCX200

R&S®NPA Power Analyzers



New



All-in-one: the compact class that has it all

The R&S®NPA power analyzer is the first compact AC/DC load and standby current characterization tester for measurement with no additional tools such as computers or remote infrastructure. The instrument has performance and compliance protocols in line with IEC 62301, EN 50564 and EN 61000 3-2 along with a numerical and graphical display with 26 key parameters.

Model overview

Model	GPIB	Bandwidth	Sampling rate	Resolution	Voltage input	Current input	Basic accuracy	Frequency accuracy	Input impedance
R&S®NPA101 power meter	–	DC to 100 kHz	500 ksample/s	simultaneous display of current and voltage, each with 16 bit	up to 600 V (RMS)	up to 20 A (RMS)	0.05% of reading	0.1 % of reading	2 MΩ
R&S®NPA501 power analyzer	–								
R&S®NPA501-G power analyzer	•								
R&S®NPA701 compliance tester	–								
R&S®NPA701-G compliance tester	•								

Important facts

Specification	R&S®NPA	Why this is important
Configurable user interface and display	Fully configurable 3.5" QVGA color TFT display	Allows users to see the measurements. Also convenient for documentation and screenshot capture.
On-instrument policy testing	on-instrument IEC 62301, EN 50564, EN 61000-3-2	Allows users to verify policies on the spot, without a PC and avoiding all of the associated IT and antivirus issues
Broad set of advanced analysis	waveform mode, trend chart, inrush mode, harmonics view	Gain insight into user problems quickly and easily with integrated analysis tools that are quick and easy to use.

Scope of delivery

- ▶ Power cable
- ▶ Quick start guide
- ▶ 3 year warranty

Recommended options/accessories

Description	Type
Power meter, DC to 100 kHz	R&S®NPA101
Power analyzer, DC to 100 kHz	R&S®NPA501
Power analyzer, DC to 100 kHz, incl. IEEE-488 (GPIB) interface	R&S®NPA501-G
Compliance tester, DC to 100 kHz	R&S®NPA701
Compliance tester, DC to 100 kHz, incl. IEEE-488 (GPIB) interface	R&S®NPA701-G
Accessories	
Mains adapter, EU version	R&S®NPA-Z1
Mains adapter, UK version	R&S®NPA-Z2
Mains adapter, US version	R&S®NPA-Z3
Mains adapter, CHN/AUS version	R&S®NPA-Z4
19" rack adapter, 2 HU, for one or two R&S®NPA power supplies	R&S®HZC95



The perfect choice for:	
Engineering labs	Production testing
Education	General purpose

Graphical views

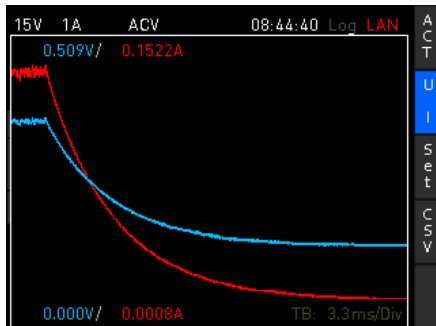

Inrush function

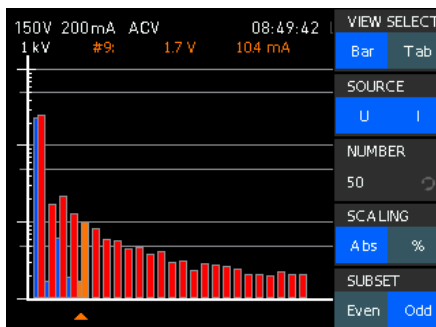

Harmonic analysis bargraph

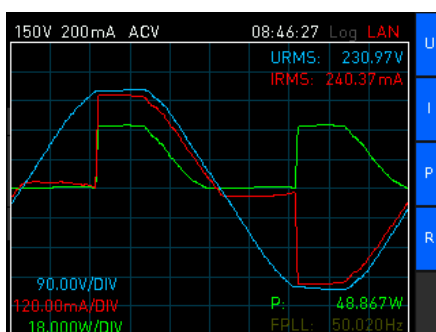

Waveform function: load with phase-angle control

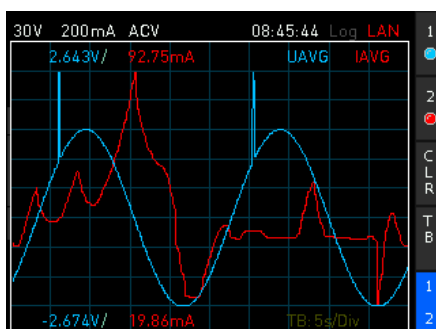

Trend chart function

Your benefit	Features
Clear display of all measured parameters	<ul style="list-style-type: none"> ▶ Simultaneous display of up to 10 numerical measurement functions ▶ User configurable measurement display ▶ Graphical display modes for inrush, harmonic analysis, waveform and trend chart
High measurement accuracy	<ul style="list-style-type: none"> ▶ Basic accuracy: 0.05% ▶ Signal acquisition from DC to 100 kHz at a sampling rate of 500 ksample/s ▶ Simultaneous display of current and voltage, each with 16 bit resolution
Everyday measurement functions	<ul style="list-style-type: none"> ▶ 26 different measurement and mathematical functions ▶ Limit testing with pass/fail indication for up to six selectable limits

List of measurement functions

Basic (all R&S®NPA models)

P	Active power (W)
S	Apparent power (VA)
Q	Reactive power (VAR)
PF	Lambda power factor (λ)
PHI	Phase shift (ϕ)
FU	Voltage frequency value (Hz)
FI	Current frequency value (Hz)
FPLL	Acquisition frequency (Hz)
URMS	RMS voltage (U RMS)
UAVG	Average voltage (U AVG)
IRMS	RMS current (I RMS)
I AVG	Average current (I AVG)
UTHD	Total harmonic distortion U
ITHD	Total harmonic distortion I
WHM, WHP, WH, AHM, AHP, AH	Energy counter (integrator values)
Logging	Measured value logging (CSV)

Advanced and graphical

(R&S®NPA501, R&S®NPA501-G, R&S®NPA701, R&S®NPA701-G)	
UPPeak	Maximum voltage (U PEAK)
UMPeak	Minimum voltage (U PEAK)
IPPeak	Maximum current (I PEAK)
IMPeak	Minimum current (I PEAK)
PPPeak	Maximum power (P PEAK)
PMPeak	Minimum power (P PEAK)
Harmonics	Bargraph of up to 50 harmonics
Waveform	Waveform display (displays one period of voltage, current or power)
Trend chart	Current and voltage displayed as a waveform
Inrush	Triggered display of waveform (single shot)
Limit / PASS/FAIL	Limit display
Sensor input	Input for current probe/external shunt
DIN/AIN	Digital/analog inputs and outputs (BNC)

Compliance evaluation

(R&S®NPA701, R&S®NPA701-G)	
IEC62301	Standby standard
EN50564	Extended standby
EN61000-3-2	Harmonic current for EMC, CE approval

R&S®HMC8012 Digital Multimeter



See more – up to three results in parallel

- ▶ True RMS measurement, AC, AC + DC
- ▶ Simultaneous display of three measurement functions, e.g. DC + AC + statistics
- ▶ Measurement functions: DCV, DCI, ACV, ACI, frequency, resistance (2-wire and 4-wire), temperature, capacitance, diode and continuity test
- ▶ Mathematic functions: limit testing, minimum, maximum, average, offset, DC power, calculation of dB and dBm
- ▶ Data logging to internal memory or USB stick

Model overview

Model	Measurement range	Basic accuracy	Number of digits	IEEE-488 (GPIB)	LabVIEW
R&S®HMC8012	DC to 100 kHz	0.015% in DC range	5.75 digits	–	•
R&S®HMC8012-G	DC to 100 kHz	0.015% in DC range	5.75 digits	•	•

Important facts

Specification	R&S®HMC8012	Why this is important
Logging capability	saves up to 4 Gbyte of data directly to USB thumb drive, 200 measurements	Fast and large file capability for large data sets
Number of measurements displayed	3 simultaneous	More information visible at a glance; no need to toggle through measurements

Scope of delivery

- ▶ R&S®HZ15 silicone test leads with safety connectors and test probe, length: 1 m (black + red)
- ▶ Operating manual
- ▶ Power cable
- ▶ 3 year warranty

Recommended options/accessories

Description	Type
PT100 temperature probe, 2-wire	R&S®HZ812
PT100 temperature probe, 4-wire	R&S®HZ887
Silicone test leads (included with base unit)	R&S®HZ15
19" rackmount kit, 2 HU for R&S®HMC series	R&S®HZC95



The perfect choice for:	
General purpose	Engineering lab
Production testing	Hobbyists

Your benefit	Features
See more at a glance with three values displayed on one screen	Measured voltage, measured current, calculated power
Limit testing on color display for easy minimum/maximum analysis	Programmable test functions such as limit and min./max.
10 A range as standard	One current input with up to 10 A and no need to change connectors for different ranges
Saves up to 4 Gbyte of data directly onto storage devices	Writes directly to USB thumb drive

Application	How the R&S®HMC8012 meets your needs
General purpose	<ul style="list-style-type: none"> ▶ Clear 5 3/4-digit display ▶ Quick and easy measurements ▶ High resolution and accuracy ▶ Extremely useful in service and repair centers, training centers, universities and schools
Engineering lab	<ul style="list-style-type: none"> ▶ Wide frequency range from DC to 100 kHz ▶ Accurate four-wire resistance measurement ▶ Long-term data logging capability ▶ Fanless design
Production environment	<ul style="list-style-type: none"> ▶ LXI-compliant Ethernet interface ▶ USB and Ethernet interface, IEEE-488 (GPIB) (R&S®HMC8012-G only) ▶ SCPI remote control functionality ▶ LabVIEW drivers available

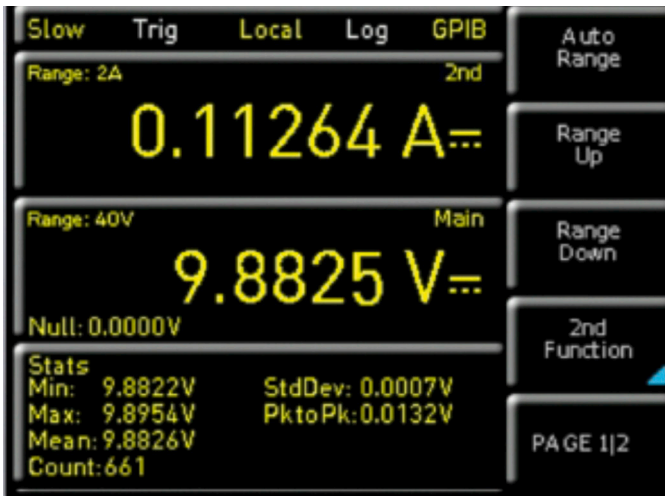

Simultaneous measurement display: Simultaneous display of three measurements, including DCI and ACI at the same time



Ideal for industrial environments: Easily slots into R&S®HMC95 2 HU 19" rackmount kit for production environment

POWER SENSORS

Products	Page
R&S®NRX power meter	106
R&S®NRP-Z211/-Z221 two-path diode power sensors	108
R&S®NRP power sensors	110

R&S®NRX Power Meter



The new power meter generation with a modern and intuitive user interface

The R&S®NRX simultaneously supports up to four Rohde & Schwarz power sensors and displays the results clearly on the flexible configurable screen. The user interface with the touchscreen based operating concept simplifies operation. In addition, function keys on the front panel provide quick access to the most important functions.

Model overview

Model	Frequency range	Power measurement range	Measurement channels	Display	Compatible sensors	Weight
R&S®NRX	DC to 170 GHz (sensor-dependent)	0.1 fW to 30 W (average) (sensor-dependent)	1 to 4	5"/12.7 cm (touch) with 800 x 480 pixel resolution (WVGA)	<ul style="list-style-type: none"> ▶ R&S®NRPxxS(N)/T(N)/A(N)/P series ▶ R&S®NRP-Zxx series ▶ R&S®NRQ6 frequency selective power sensor ▶ R&S®NRT-Zxx directional power sensors 	2.35 kg/2.58 kg (option-dependent)

Important facts

Specification	R&S®NRX	Why this is important
Large high-resolution touchscreen	TFT 5" 800 x 480 pixel	Intuitive and fast operation.
Number of measurement channels	1 to 4	Flexibility to meet current and future requirements.
Sensor compatibility	R&S®NRPxxS/SN, R&S®NRPxxT/TN/TWG, R&S®NRPxxA/AN, R&S®NRP-Zxx, R&S®NRT-Zxx	One base unit for all current Rohde & Schwarz power sensors and selected discontinued sensors.
Automatic pulse analysis	with R&S®NRPxP sensors	Time-saving, no need for manual calculation.
Sensor check source	50 MHz/1 GHz, CW and pulse mode	High-precision sensor verification in a module.
Power reflection measurements	R&S®NRX-B9 option	First base unit compatible with termination and directional power sensors in a single device.

Scope of delivery

- ▶ Quick start guide
- ▶ Power cord
- ▶ 3 year warranty

Recommended options/accessories

Description	Type
Base unit	
Power meter	R&S®NRX
Hardware options	
Sensor check source	R&S®NRX-B1
Third (C) and fourth (D) sensor connector, for R&S®NRP	R&S®NRX-B4
IEEE-488 (GPIB) interface	R&S®NRX-B8
Sensor interface, for R&S®NRT	R&S®NRX-B9

Recommended options/accessories

Description	Type
Software options	
Second measurement channel	R&S®NRX-K2
Third and fourth measurement channel	R&S®NRX-K4
Keysight emulation mode (N1911A/N1912A/N432A/E4418A/E4419A)	R&S®NRX-K301
Recommended extras for R&S®NRPxxS(N)/T(N)/A(N) power sensors	
A minimum of one interface cable is required for power sensor operation.	
8-pole interface cable, length: 1.50 m	R&S®NRP-ZK8
8-pole interface cable, length: 3.00 m	R&S®NRP-ZK8
8-pole interface cable, length: 5.00 m	R&S®NRP-ZK8
Recommended extras for R&S®NRX	
19" rack adapter (for one R&S®NRX power meter and one empty casing)	R&S®ZZA-KNA22
19" rack adapter (for two R&S®NRX power meters)	R&S®ZZA-KNA24



The perfect choice for:	
Easy RF power measurements	Multichannel measurements
RF pulse analysis	System integration

Your benefit	Features
Easy to use	<ul style="list-style-type: none"> ▶ Clear color touchscreen supports the intuitive, window-based operating concept ▶ Color-coded key parameters and functions can be seen at a glance ▶ Results are presented in numerical and graphical display windows that can be easily configured
Sensor check source	<ul style="list-style-type: none"> ▶ Superior pulse reference generator ▶ Test source for sensor and DUT ▶ Variable mode (CW/pulse), frequency (50 MHz/1 GHz) and discrete power steps
All-in-one base unit	<ul style="list-style-type: none"> ▶ Supports multipath, thermal, wideband and averaging sensors ▶ Supports frequency selective power sensors ▶ Supports directional power sensors

Universal sensor connectivity

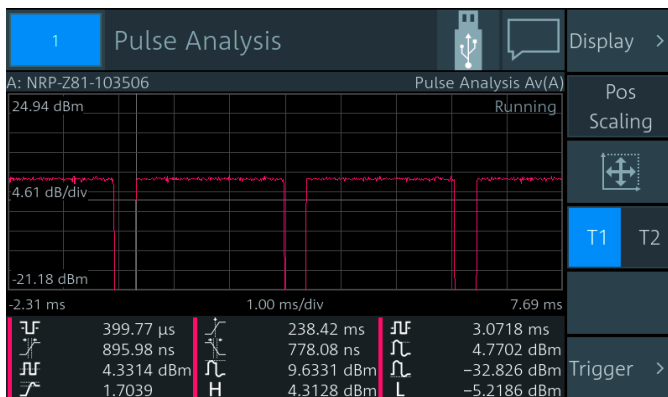
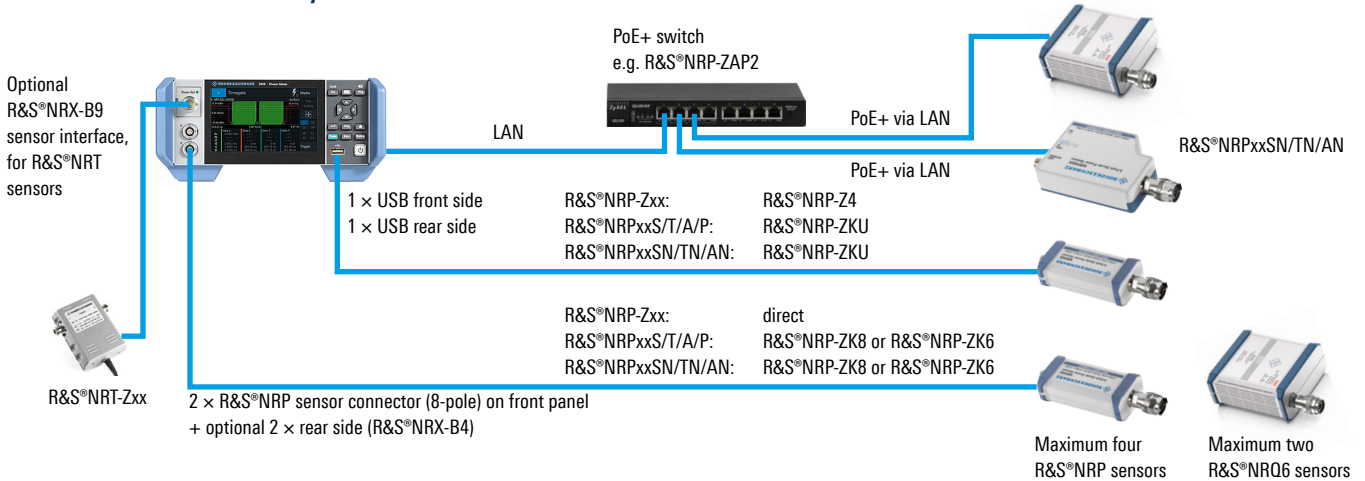

Automatic pulse analysis: All R&S®NRPxP wideband power sensors allow automatic pulse analysis. Up to 12 of 18 user-selected pulse parameters can be displayed in addition to the measurement trace.



Flexible device interfacing: The R&S®NRX provides three different remote interfaces for integration in automated test setups: Ethernet, USB and optionally IEEE-488 (GPIB) (R&S®NRX-B8).

R&S®NRP-Z211/-Z221 Two-Path Diode Power Sensors



Get accurate results faster

The R&S®NRP-Z211/-Z221 two-path diode power sensors combine all key characteristics relevant for their use in production. They are cost-effective, fast, precise and USB-capable, offering the best price/performance ratio in their class.

- ▶ Innovative two-path diode power sensor with enhanced interrange performance
- ▶ 80 dB dynamic range for CW and modulated signals
- ▶ Automatic burst detection and acquisition
- ▶ Low sensitivity to harmonics

Model overview

Model	Frequency range	Sensor type	Connectivity
R&S®NRP-Z211	10 MHz to 8 GHz	multipath (2 diode)	USB
R&S®NRP-Z221	10 MHz to 18 GHz	multipath (2 diode)	USB

Scope of delivery

3 year warranty

Recommended options/accessories

Description	Type
USB adapter cable (passive)	R&S®NRP-Z4
USB adapter cable (active)	R&S®NRP-Z3
Sensor hub	R&S®NRP-Z5



The perfect choice for:
 Base stations and mobile equipment
 Calibration

Your benefit	Features
USB sensors with no compromises	The R&S®NRP-Zxx power sensors are USB sensors that can be used standalone and have no downside in terms of versatility, accuracy and functionality
Highest accuracy	R&S®SmartSensor technology
Fastest time to accurate measurements	<ul style="list-style-type: none"> ▶ Widest measurement range ▶ Lowest noise floor ▶ Fastest measurements

R&S®NRPV: convenient power measurements via PC application

- ▶ Pulse delay measurement on different traces (1).
- ▶ Gated measurement of two GSM/EDGE traces with the R&S®NRP-Z81 (2).

In combination with the R&S®NRPV virtual power meter software, the USB capability of the R&S®NRP-Z211/-Z221 power sensors can be ideally utilized. The software covers all sensor functions and supports up to four sensors connected to a laptop/PC via the R&S®NRP-Z4 USB adapter cables or the R&S®NRP-Z5 sensor hub. The sensors are automatically detected when plugged in and added to all open measurement windows (hot plugging).

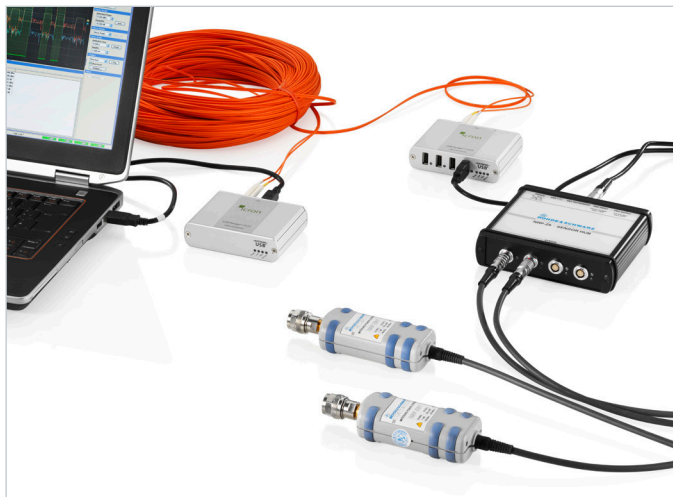

Multiple ways to operate R&S®NRP-Z211/-Z221 power sensors

- ▶ The power sensors can be operated either on an R&S®NRX base unit or directly on a laptop/PC. They are also supported by numerous signal generators, signal analyzers, spectrum analyzers and network analyzers from Rohde & Schwarz. The R&S®NRP-Z4 passive USB adapter cable is all that is needed to connect the sensors to a laptop/PC.
- ▶ The R&S®NRP-Z5 sensor hub allows users to connect up to four sensors to a laptop/PC without additional adapters and to simultaneously start the measurements using an external trigger signal.

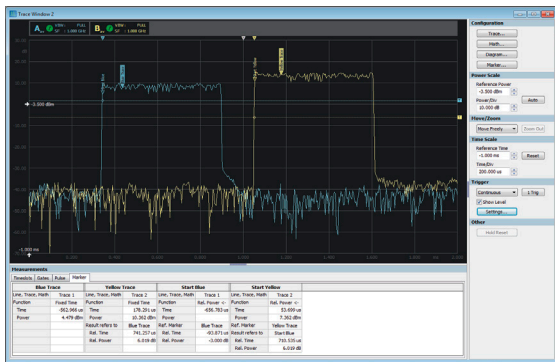

(1)

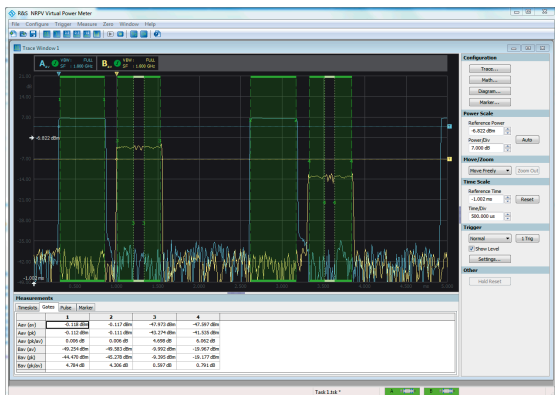

(2)

R&S®NRP Power Sensors



Intelligent, LAN enabled power measurements

The R&S®NRP power sensors have long been recognized for delivering supreme precision and speed. The R&S®NRPxxS(N), R&S®NRPxxT(N) and R&S®NRPxxA(N) power sensors take power measurements to the next level. They offer USB capability and can be additionally controlled via LAN. This makes the R&S®NRP power meter portfolio unique in the industry

Model overview

Model	Frequency range	Sensor type	Connectivity	Description
R&S®NRX ¹⁾	–	power meter	–	Base unit supports up to four R&S®NRP sensors.
R&S®NRPxxS, R&S®NRPxxSN ²⁾	10 MHz to 90 GHz	three-path diode	USB, LAN	Leading performance sensors deliver accurate results quickly. Models available ranging from 10 MHz to 90 GHz.
R&S®NRPxxT, R&S®NRPxxTN	DC to 170 GHz	thermal	USB, LAN	Most accurate results. Models available ranging from DC to 170 GHz.
R&S®NRPxxA, R&S®NRPxxAN	8 kHz to 18 GHz	average	USB, LAN	Ideal for EMC applications. Models available ranging from 8 kHz to 6 GHz or 18 GHz.
R&S®NRPxP	50 MHz to 50 GHz	wideband	USB	Ideal for characterizing pulses. Models available ranging from 50 MHz to 50 GHz.
R&S®NRP-Z2xx	10 MHz to 18 GHz	two-path diode	USB	A cost-effective measurement solution.

¹⁾ No cable supplied as standard. Please select R&S®NRP-ZKU for USB (4 lengths available) and/or R&S®NRP-ZK6 + R&S®NRP-ZK8 (3 lengths available) for PC, R&S®NRX and Rohde & Schwarz instrument connection.

²⁾ No cable supplied as standard. To operate the R&S®NRPxxSN sensors over the LAN interface, a power over Ethernet adapter is required, such as the R&S®NRP-ZAP2 (no LAN cables come with the R&S®NRP-ZAP2). The sensor can also be operated with the R&S®NRP-ZKU or R&S®NRP-ZK6 + R&S®NRP-ZK8 cables.

Important facts

Sensor type R&S®	Specification	Rohde & Schwarz power sensor	Why this is important
NRPxxS/SN multipath sensor	LAN connection	all models	LAN connection allows remote control and access anywhere.
	measurement range	–70 dBm to +23 dBm	Make accurate measurements on signals with lower power levels. Less internal noise means faster, more accurate measurements.
	measurement speed	> 50 000 readings/s	A faster sensor significantly increases test time to accuracy.
	external trigger	•	Allows you to control the moment when the sensor will take its reading. The built-in trigger on R&S®NRP sensors operates at power levels 13 dB lower than the competition.
NRPxxT/TN thermal sensor	LAN connection	all models, except 110 GHz sensor	LAN connection allows remote control and access anywhere.
	measurement time	45 ms	A faster sensor significantly increases test time to accuracy.
	linearity	< 0.007 dB	
NRPxxA/AN average sensor	LAN connection	all models	LAN connection allows remote control and access anywhere.
	frequency range	► 8 kHz to 6 GHz ► 8 kHz to 18 GHz	Measure a wider spectrum using a single device. EMC specifications are moving towards starting at 8 kHz, making the R&S®NRPxxS/SN the only sensors available for this.
	measurement range	–70 dBm to +23 dBm	Higher measurement range allows a simpler test setup with less need for external attenuators. Make accurate measurements on signals with lower power levels. Less internal noise means faster, more accurate measurements.
NRPxP sensor	frequency range	up to 50 GHz	Enables wideband or pulsed measurements in the key frequency bands between 40 GHz and 50 GHz.
	measurement range	–60 dBm to +20 dBm	Make accurate measurements on signals with lower power levels. Less internal noise means faster, more accurate measurements.

The perfect choice for:	
Base stations and mobile equipment	Calibration

Your benefit	Features
Make a measurement anywhere with LAN based sensors	Complete range of LAN sensors (multipath, thermal and average), from DC to 90 GHz
High measurement speed	> 50 000 readings/s ¹⁾
Fastest time to accurate measurements	<ul style="list-style-type: none"> ▶ Widest measurement range ▶ Lowest noise floor ▶ Fastest measurements

¹⁾ For R&S®NRPxxS(N).

Scope of delivery
<ul style="list-style-type: none"> ▶ Quick start guide ▶ CD with operating and service manual ▶ Power cable ▶ 3 year warranty

Key facts

- ▶ Maximum dynamic range: -70 dBm to +45 dBm
- ▶ Frequency range: DC to 170 GHz
- ▶ More than 50 000 readings/s¹⁾
- ▶ Flexible operation with R&S®NRX base unit, laptop/PC and many Rohde&Schwarz instruments
- ▶ Control and monitoring via LAN and USB
- ▶ Easy LAN operation from a web browser
- ▶ R&S®NRPxxS(N) for widest dynamic range
- ▶ R&S®NRPxxT(N) for highest accuracy
- ▶ R&S®NRPxxA(N) for EMC applications

¹⁾ For R&S®NRPxxS(N).

Simultaneous, location-independent remote monitoring of multiple R&S®NRPxxSN/TN/AN power sensors using a web browser

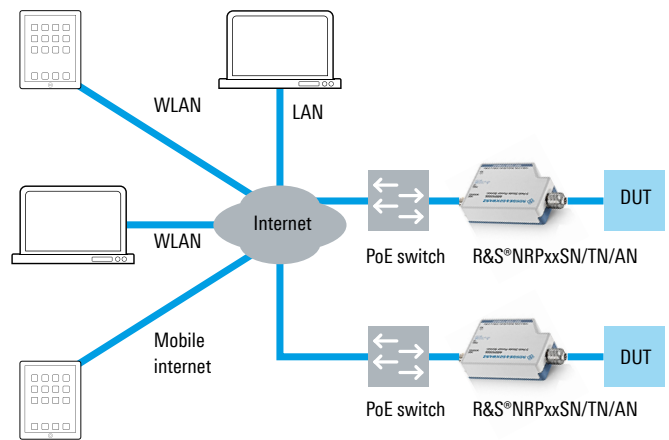

Multiple ways to operate the R&S®NRPxxS(N), R&S®NRPxxT(N) and R&S®NRPxxA(N) power sensors

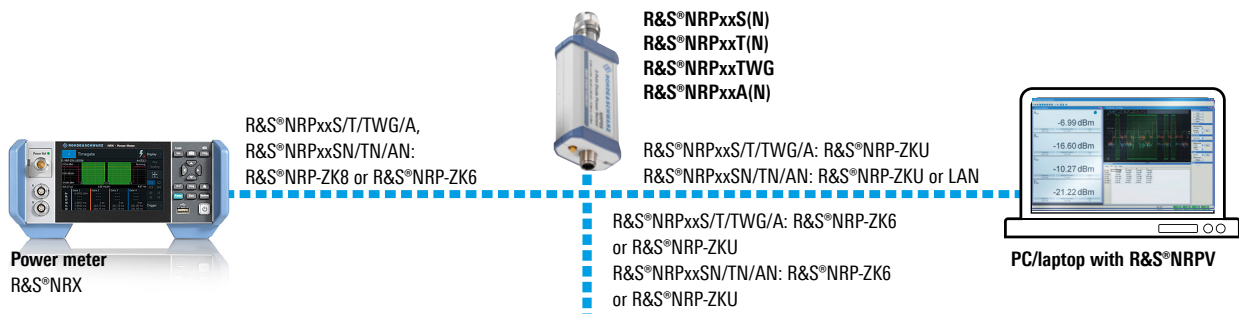

Supported Rohde & Schwarz instruments



Signal generators
e.g. R&S®SMW200A



Signal and spectrum analyzers
e.g. R&S®FSW



Network analyzers
e.g. R&S®ZNA

YOU'RE IN GREAT HANDS.

CALIBRATION YOU CAN TRUST



LONG-TERM BENEFITS: R&S®SERVICE CONTRACTS

LOW, PREDICTABLE COSTS

RELIABLE AND DEPENDABLE

TRANSPARENT AND FLEXIBLE

ROHDE & SCHWARZ CALIBRATION VERSUS THIRD-PARTY CALIBRATION

Two factors determine the quality of a calibration service:

- ▶ Compliance with relevant standards
- ▶ Coverage of technical parameters

A Rohde & Schwarz instrument has the technical capabilities and parameters to meet your needs. So, the calibration process has to cover all the technical parameters over the full performance range specified in the data sheet.

A review of calibration reports from third-party providers reveals that they do not always test all the relevant parameters.

This can lead to serious, unpredictable gaps in instrument performance. Accredited calibrations require the scope of accreditation to cover every parameter.

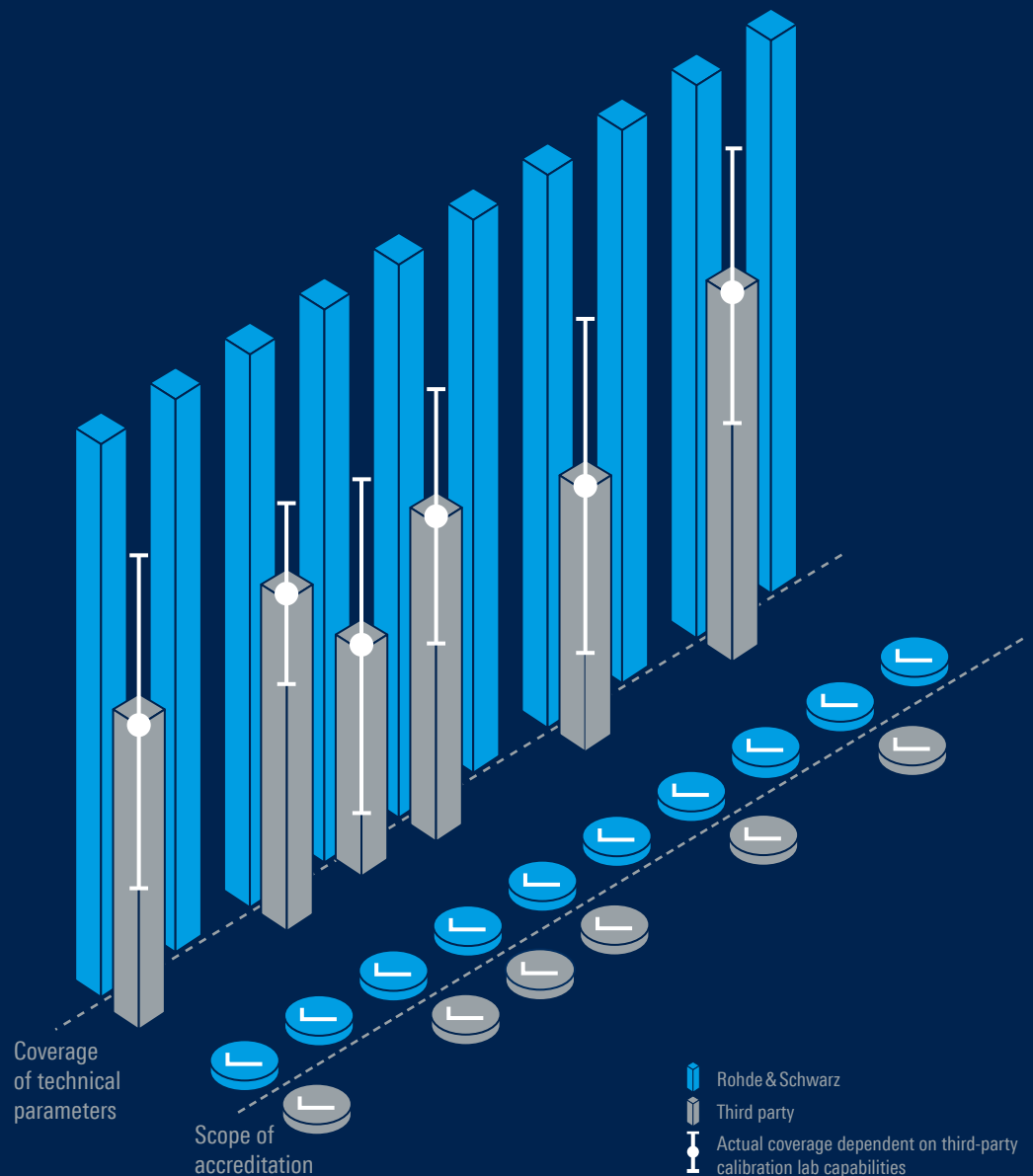

SERVICE

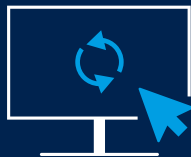

Rohde & Schwarz stands for innovative service products over the entire product lifecycle, supported by a global service network.

The following services are available in over 70 countries:

- ▶ On-site calibration and support
- ▶ Preventive and predictive maintenance
- ▶ Product updates and upgrades
- ▶ Remote service

Rohde & Schwarz regional service centers, plants and specialized subsidiaries provide a wide range of additional services:

- ▶ System integration
- ▶ Application support
- ▶ Development of customized modules, equipment and systems
- ▶ Software development
- ▶ Installation and commissioning
- ▶ On-site calibration and repair services

During the product's overall lifecycle, Rohde & Schwarz offers the following services as part of service level agreements:

- ▶ System support
- ▶ Specialized trainings (different formats, such as online courses, virtual classrooms, and classroom courses)
- ▶ Maintenance
- ▶ Spare parts service
- ▶ Integrated logistics support
- ▶ Obsolescence management
- ▶ Technical documentation
- ▶ Preventive and predictive maintenance



SERVICE AT ROHDE & SCHWARZ YOU'RE IN GREAT HANDS

Worldwide

Local and personalized

Customized and flexible

Uncompromising quality

Long-term dependability

FROM PRESALES TO SERVICE. AT YOUR DOORSTEP.

The Rohde & Schwarz network in over 70 countries ensures optimum on-site support by highly qualified experts.

User risks are reduced to a minimum at all project stages:

- ▶ Solution finding/purchase
- ▶ Technical startup/application development/integration
- ▶ Training
- ▶ Operation/calibration/repair



CONTACT INFORMATION

Rohde & Schwarz GmbH & Co. KG

www.rohde-schwarz.com

Corporate communications

Rohde & Schwarz GmbH & Co. KG
Corporate Communications
Mühldorfstraße 15
81671 Munich, Germany
Phone +49 89 4129 139 58
Fax +49 89 4129 135 63
press@rohde-schwarz.com

Sales

The addresses of the local sales companies can be found at: www.sales.rohde-schwarz.com

Rohde & Schwarz training

www.training.rohde-schwarz.com

Rohde & Schwarz customer support

Our customer support centers will be happy to answer any questions regarding our products and service:
www.rohde-schwarz.com/support



Plants

Memmingen plant

info.rsdmb@rohde-schwarz.com

Teisnach plant

info.teisnach@rohde-schwarz.com

Vimperk plant

info.vimperk@rohde-schwarz.com

Singapore and Malaysia plants

solutions.asia@rohde-schwarz.com

TRADEMARKS

Trade names are trademarks of the owners

- ▶ R&S® is a registered trademark of Rohde&Schwarz GmbH&Co. KG.
Example: R&S®FSC spectrum analyzer
- ▶ CDMA2000® is a registered trademark of the Telecommunications Industry Association (TIA-USA).
- ▶ LoRa® Mark and LoRa Logo are registered trademarks of Semtech Corporation.
- ▶ The Bluetooth® word mark and logos are registered trademarks owned by Bluetooth SIG, Inc. and any use of such marks by Rohde&Schwarz is under license.
- ▶ The terms HDMI, HDMI High-Definition Multimedia Interface, HDMI trade dress and the HDMI Logos are trademarks or registered trademarks of HDMI Licensing Administrator, Inc.
- ▶ Windows is a registered trademark of Microsoft Corp., USA
- ▶ Wi-Fi® is a registered trademark of Wi-Fi Alliance®.
- ▶ “WiMAX”, “Mobile WiMAX”, “Fixed WiMAX”, “WiMAX Forum”, “WiMAX Certified”, “WiMAX Forum Certified”, “WiGRID”, the WiMAX Forum logo, the WiMAX Forum Certified logo and the WiGRID logo are trademarks or registered trademarks of the WiMAX Forum.

Published by

Rohde&Schwarz GmbH&Co. KG

Compilation, layout: Silke Knobloch, Department GF-BS1

Translation: Department GF-BS2

Rohde & Schwarz representative