



ROHDE & SCHWARZ

Test and Measurement
Division

Operating Manual

Option SMIQB17

Noise Generator and Distortion Simulator

1104.9000.02

Printed in the Federal
Republic of Germany



Before putting the product into operation for the first time, make sure to read the following



Safety Instructions

Rohde & Schwarz makes every effort to keep the safety standard of its products up to date and to offer its customers the highest possible degree of safety. Our products and the auxiliary equipment required for them are designed and tested in accordance with the relevant safety standards. Compliance with these standards is continuously monitored by our quality assurance system. This product has been designed and tested in accordance with the EC Certificate of Conformity and has left the manufacturer's plant in a condition fully complying with safety standards. To maintain this condition and to ensure safe operation, observe all instructions and warnings provided in this manual. If you have any questions regarding these safety instructions, Rohde & Schwarz will be happy to answer them.

Furthermore, it is your responsibility to use the product in an appropriate manner. This product is designed for use solely in industrial and laboratory environments or in the field and must not be used in any way that may cause personal injury or property damage. You are responsible if the product is used for an intention other than its designated purpose or in disregard of the manufacturer's instructions. The manufacturer shall assume no responsibility for such use of the product.

The product is used for its designated purpose if it is used in accordance with its operating manual and within its performance limits (see data sheet, documentation, the following safety instructions). Using the products requires technical skills and knowledge of English. It is therefore essential that the products be used exclusively by skilled and specialized staff or thoroughly trained personnel with the required skills. If personal safety gear is required for using Rohde & Schwarz products, this will be indicated at the appropriate place in the product documentation.

Symbols and safety labels

Observe operating instructions	Weight indication for units >18 kg	Danger of electric shock	Warning! Hot surface	PE terminal	Ground	Ground terminal	Attention! Electrostatic sensitive devices

Supply voltage ON/OFF	Standby indication	Direct current (DC)	Alternating current (AC)	Direct/alternating current (DC/AC)	Device fully protected by double/reinforced insulation

Safety Instructions

Observing the safety instructions will help prevent personal injury or damage of any kind caused by dangerous situations. Therefore, carefully read through and adhere to the following safety instructions before putting the product into operation. It is also absolutely essential to observe the additional safety instructions on personal safety that appear in other parts of the documentation. In these safety instructions, the word "product" refers to all merchandise sold and distributed by Rohde & Schwarz, including instruments, systems and all accessories.

Tags and their meaning

DANGER	This tag indicates a safety hazard with a high potential of risk for the user that can result in death or serious injuries.
WARNING	This tag indicates a safety hazard with a medium potential of risk for the user that can result in death or serious injuries.
CAUTION	This tag indicates a safety hazard with a low potential of risk for the user that can result in slight or minor injuries.
ATTENTION	This tag indicates the possibility of incorrect use that can cause damage to the product.
NOTE	This tag indicates a situation where the user should pay special attention to operating the product but which does not lead to damage.

These tags are in accordance with the standard definition for civil applications in the European Economic Area. Definitions that deviate from the standard definition may also exist. It is therefore essential to make sure that the tags described here are always used only in connection with the associated documentation and the associated product. The use of tags in connection with unassociated products or unassociated documentation can result in misinterpretations and thus contribute to personal injury or material damage.

Basic safety instructions

1. The product may be operated only under the operating conditions and in the positions specified by the manufacturer. Its ventilation must not be obstructed during operation. Unless otherwise specified, the following requirements apply to Rohde & Schwarz products:
prescribed operating position is always with the housing floor facing down, IP protection 2X, pollution severity 2, overvoltage category 2, use only in enclosed spaces, max. operation altitude max. 2000 m. Unless specified otherwise in the data sheet, a tolerance of $\pm 10\%$ shall apply to the nominal voltage and of $\pm 5\%$ to the nominal frequency.
2. Applicable local or national safety regulations and rules for the prevention of accidents must be observed in all work performed. The product may be opened only by authorized, specially trained personnel. Prior to performing any work on the product or opening the product, the product must be disconnected from the supply network. Any adjustments, replacements of parts, maintenance or repair must be carried out only by technical personnel authorized by Rohde & Schwarz. Only original parts may be used for replacing parts relevant to safety (e.g. power switches, power transformers, fuses). A safety test must always be performed after parts relevant to safety have been replaced (visual inspection, PE conductor test, insulation resistance measurement, leakage current measurement, functional test).
3. As with all industrially manufactured goods, the use of substances that induce an allergic reaction (allergens, e.g. nickel) such as aluminum cannot be generally excluded. If you develop an allergic reaction (such as a skin rash, frequent sneezing, red eyes or respiratory difficulties), consult a physician immediately to determine the cause.

Safety Instructions

4. If products/components are mechanically and/or thermally processed in a manner that goes beyond their intended use, hazardous substances (heavy-metal dust such as lead, beryllium, nickel) may be released. For this reason, the product may only be disassembled, e.g. for disposal purposes, by specially trained personnel. Improper disassembly may be hazardous to your health. National waste disposal regulations must be observed.
5. If handling the product yields hazardous substances or fuels that must be disposed of in a special way, e.g. coolants or engine oils that must be replenished regularly, the safety instructions of the manufacturer of the hazardous substances or fuels and the applicable regional waste disposal regulations must be observed. Also observe the relevant safety instructions in the product documentation.
6. Depending on the function, certain products such as RF radio equipment can produce an elevated level of electromagnetic radiation. Considering that unborn life requires increased protection, pregnant women should be protected by appropriate measures. Persons with pacemakers may also be endangered by electromagnetic radiation. The employer is required to assess workplaces where there is a special risk of exposure to radiation and, if necessary, take measures to avert the danger.
7. Operating the products requires special training and intense concentration. Make certain that persons who use the products are physically, mentally and emotionally fit enough to handle operating the products; otherwise injuries or material damage may occur. It is the responsibility of the employer to select suitable personnel for operating the products.
8. Prior to switching on the product, it must be ensured that the nominal voltage setting on the product matches the nominal voltage of the AC supply network. If a different voltage is to be set, the power fuse of the product may have to be changed accordingly.
9. In the case of products of safety class I with movable power cord and connector, operation is permitted only on sockets with earthing contact and protective earth connection.
10. Intentionally breaking the protective earth connection either in the feed line or in the product itself is not permitted. Doing so can result in the danger of an electric shock from the product. If extension cords or connector strips are implemented, they must be checked on a regular basis to ensure that they are safe to use.
11. If the product has no power switch for disconnection from the AC supply, the plug of the connecting cable is regarded as the disconnecting device. In such cases, it must be ensured that the power plug is easily reachable and accessible at all times (length of connecting cable approx. 2 m). Functional or electronic switches are not suitable for providing disconnection from the AC supply. If products without power switches are integrated in racks or systems, a disconnecting device must be provided at the system level.
12. Never use the product if the power cable is damaged. By taking appropriate safety measures and carefully laying the power cable, ensure that the cable cannot be damaged and that no one can be hurt by e.g. tripping over the cable or suffering an electric shock.
13. The product may be operated only from TN/TT supply networks fused with max. 16 A.
14. Do not insert the plug into sockets that are dusty or dirty. Insert the plug firmly and all the way into the socket. Otherwise this can result in sparks, fire and/or injuries.
15. Do not overload any sockets, extension cords or connector strips; doing so can cause fire or electric shocks.
16. For measurements in circuits with voltages $V_{\text{rms}} > 30 \text{ V}$, suitable measures (e.g. appropriate measuring equipment, fusing, current limiting, electrical separation, insulation) should be taken to avoid any hazards.
17. Ensure that the connections with information technology equipment comply with IEC 950/EN 60950.
18. Never remove the cover or part of the housing while you are operating the product. This will expose circuits and components and can lead to injuries, fire or damage to the product.

Safety Instructions

19. If a product is to be permanently installed, the connection between the PE terminal on site and the product's PE conductor must be made first before any other connection is made. The product may be installed and connected only by a skilled electrician.
20. For permanently installed equipment without built-in fuses, circuit breakers or similar protective devices, the supply circuit must be fused in such a way that suitable protection is provided for users and products.
21. Do not insert any objects into the openings in the housing that are not designed for this purpose. Never pour any liquids onto or into the housing. This can cause short circuits inside the product and/or electric shocks, fire or injuries.
22. Use suitable overvoltage protection to ensure that no overvoltage (such as that caused by a thunderstorm) can reach the product. Otherwise the operating personnel will be endangered by electric shocks.
23. Rohde & Schwarz products are not protected against penetration of water, unless otherwise specified (see also safety instruction 1.). If this is not taken into account, there exists the danger of electric shock or damage to the product, which can also lead to personal injury.
24. Never use the product under conditions in which condensation has formed or can form in or on the product, e.g. if the product was moved from a cold to a warm environment.
25. Do not close any slots or openings on the product, since they are necessary for ventilation and prevent the product from overheating. Do not place the product on soft surfaces such as sofas or rugs or inside a closed housing, unless this is well ventilated.
26. Do not place the product on heat-generating devices such as radiators or fan heaters. The temperature of the environment must not exceed the maximum temperature specified in the data sheet.
27. Batteries and storage batteries must not be exposed to high temperatures or fire. Keep batteries and storage batteries away from children. If batteries or storage batteries are improperly replaced, this can cause an explosion (warning: lithium cells). Replace the battery or storage battery only with the matching Rohde & Schwarz type (see spare parts list). Batteries and storage batteries are hazardous waste. Dispose of them only in specially marked containers. Observe local regulations regarding waste disposal. Do not short-circuit batteries or storage batteries.
28. Please be aware that in the event of a fire, toxic substances (gases, liquids etc.) that may be hazardous to your health may escape from the product.
29. Please be aware of the weight of the product. Be careful when moving it; otherwise you may injure your back or other parts of your body.
30. Do not place the product on surfaces, vehicles, cabinets or tables that for reasons of weight or stability are unsuitable for this purpose. Always follow the manufacturer's installation instructions when installing the product and fastening it to objects or structures (e.g. walls and shelves).
31. Handles on the products are designed exclusively for personnel to hold or carry the product. It is therefore not permissible to use handles for fastening the product to or on means of transport such as cranes, fork lifts, wagons, etc. The user is responsible for securely fastening the products to or on the means of transport and for observing the safety regulations of the manufacturer of the means of transport. Noncompliance can result in personal injury or material damage.
32. If you use the product in a vehicle, it is the sole responsibility of the driver to drive the vehicle safely. Adequately secure the product in the vehicle to prevent injuries or other damage in the event of an accident. Never use the product in a moving vehicle if doing so could distract the driver of the vehicle. The driver is always responsible for the safety of the vehicle; the manufacturer assumes no responsibility for accidents or collisions.
33. If a laser product (e.g. a CD/DVD drive) is integrated in a Rohde & Schwarz product, do not use any other settings or functions than those described in the documentation. Otherwise this may be hazardous to your health, since the laser beam can cause irreversible damage to your eyes. Never try to take such products apart, and never look into the laser beam.



Por favor lea imprescindiblemente antes de la primera puesta en funcionamiento las siguientes informaciones de seguridad



Informaciones de seguridad

Es el principio de Rohde & Schwarz de tener a sus productos siempre al día con los standards de seguridad y de ofrecer a sus clientes el máximo grado de seguridad. Nuestros productos y todos los equipos adicionales son siempre fabricados y examinados según las normas de seguridad vigentes. Nuestra sección de gestión de la seguridad de calidad controla constantemente que sean cumplidas estas normas. Este producto ha sido fabricado y examinado según el comprobante de conformidad adjunto según las normas de la CE y ha salido de nuestra planta en estado impecable según los standards técnicos de seguridad. Para poder preservar este estado y garantizar un funcionamiento libre de peligros, deberá el usuario atenerse a todas las informaciones, informaciones de seguridad y notas de alerta. Rohde&Schwarz está siempre a su disposición en caso de que tengan preguntas referentes a estas informaciones de seguridad.

Además queda en la responsabilidad del usuario utilizar el producto en la forma debida. Este producto solamente fue elaborado para ser utilizado en la industria y el laboratorio o para fines de campo y de ninguna manera deberá ser utilizado de modo que alguna persona/cosa pueda ser dañada. El uso del producto fuera de sus fines definidos o despreciando las informaciones de seguridad del fabricante queda en la responsabilidad del usuario. El fabricante no se hace en ninguna forma responsable de consecuencias a causa del maluso del producto.

Se parte del uso correcto del producto para los fines definidos si el producto es utilizado dentro de las instrucciones del correspondiente manual del uso y dentro del margen de rendimiento definido (ver hoja de datos, documentación, informaciones de seguridad que siguen). El uso de los productos hace necesarios conocimientos profundos y el conocimiento del idioma inglés. Por eso se deberá tener en cuenta de exclusivamente autorizar para el uso de los productos a personas péritas o debidamente minuciosamente instruidas con los conocimientos citados. Si fuera necesaria indumentaria de seguridad para el uso de productos de R&S, encontrará la información debida en la documentación del producto en el capítulo correspondiente.

Símbolos y definiciones de seguridad

Ver manual de instrucciones del uso	Informaciones para maquinaria con un peso de > 18kg	Peligro de golpe de corriente	¡Advertencia! Superficie caliente	Conexión a conductor protector	Conexión a tierra	Conexión a masa conductora	¡Cuidado! Elementos de construcción con peligro de carga electrostática

potencia EN MARCHA/PARADA	Indicación Stand-by	Corriente continua DC	Corriente alterna AC	Corriente continua/alterna DC/AC	El aparato está protegido en su totalidad por un aislamiento de doble refuerzo

Informaciones de seguridad

Tener en cuenta las informaciones de seguridad sirve para tratar de evitar daños y peligros de toda clase. Es necesario de que se lean las siguientes informaciones de seguridad concienzudamente y se tengan en cuenta debidamente antes de la puesta en funcionamiento del producto. También deberán ser tenidas en cuenta las informaciones para la protección de personas que encontrarán en otro capítulo de esta documentación y que también son obligatorias de seguir. En las informaciones de seguridad actuales hemos juntado todos los objetos vendidos por Rohde&Schwarz bajo la denominación de „producto“, entre ellos también aparatos, instalaciones así como toda clase de accesorios.

Palabras de señal y su significado

PELIGRO	Indica un punto de peligro con gran potencial de riesgo para el usuario. Punto de peligro que puede llevar hasta la muerte o graves heridas.
ADVERTENCIA	Indica un punto de peligro con un potencial de riesgo mediano para el usuario. Punto de peligro que puede llevar hasta la muerte o graves heridas .
ATENCIÓN	Indica un punto de peligro con un potencial de riesgo pequeño para el usuario. Punto de peligro que puede llevar hasta heridas leves o pequeñas
CUIDADO	Indica la posibilidad de utilizar mal el producto y a consecuencia dañarlo.
INFORMACIÓN	Indica una situación en la que deberían seguirse las instrucciones en el uso del producto, pero que no consecuentemente deben de llevar a un daño del mismo.

Las palabras de señal corresponden a la definición habitual para aplicaciones civiles en el ámbito de la comunidad económica europea. Pueden existir definiciones diferentes a esta definición. Por eso se debiera tener en cuenta que las palabras de señal aquí descritas sean utilizadas siempre solamente en combinación con la correspondiente documentación y solamente en combinación con el producto correspondiente. La utilización de las palabras de señal en combinación con productos o documentaciones que no les correspondan puede llevar a malinterpretaciones y tener por consecuencia daños en personas u objetos.

Informaciones de seguridad elementales

1. El producto solamente debe ser utilizado según lo indicado por el fabricante referente a la situación y posición de funcionamiento sin que se obstruya la ventilación. Si no se convino de otra manera, es para los productos R&S válido lo que sigue: como posición de funcionamiento se define principalmente la posición con el suelo de la caja para abajo , modo de protección IP 2X, grado de suciedad 2, categoría de sobrecarga eléctrica 2, utilizar solamente en estancias interiores, utilización hasta 2000 m sobre el nivel del mar.
A menos que se especifique otra cosa en la hoja de datos, se aplicará una tolerancia de $\pm 10\%$ sobre el voltaje nominal y de $\pm 5\%$ sobre la frecuencia nominal.
2. En todos los trabajos deberán ser tenidas en cuenta las normas locales de seguridad de trabajo y de prevención de accidentes. El producto solamente debe de ser abierto por personal périto autorizado. Antes de efectuar trabajos en el producto o abrirlo deberá este ser desconectado de la corriente. El ajuste, el cambio de partes, la manutención y la reparación deberán ser solamente efectuadas por electricistas autorizados por R&S. Si se reponen partes con importancia para los aspectos de seguridad (por ejemplo el enchufe, los transformadores o los fusibles), solamente podrán ser sustituidos por partes originales. Despues de cada recambio de partes elementales para la seguridad deberá ser efectuado un control de

Informaciones de seguridad

- seguridad (control a primera vista, control de conductor protector, medición de resistencia de aislamiento, medición de medición de la corriente conductora, control de funcionamiento).
3. Como en todo producto de fabricación industrial no puede ser excluido en general de que se produzcan al usarlo elementos que puedan generar alergias, los llamados elementos alergénicos (por ejemplo el níquel). Si se produjeran en el trato con productos R&S reacciones alérgicas, como por ejemplo urticaria, estornudos frecuentes, irritación de la conjuntiva o dificultades al respirar, se deberá consultar inmediatamente a un médico para averiguar los motivos de estas reacciones.
 4. Si productos / elementos de construcción son tratados fuera del funcionamiento definido de forma mecánica o térmica, pueden generarse elementos peligrosos (povos de sustancia de metales pesados como por ejemplo plomo, berilio, níquel). La partición elemental del producto, como por ejemplo sucede en el tratamiento de materias residuales, debe de ser efectuada solamente por personal especializado para estos tratamientos. La partición elemental efectuada inadecuadamente puede generar daños para la salud. Se deben tener en cuenta las directivas nacionales referentes al tratamiento de materias residuales.
 5. En el caso de que se produjeran agentes de peligro o combustibles en la aplicación del producto que debieran de ser transferidos a un tratamiento de materias residuales, como por ejemplo agentes refrigerantes que deben ser repuestos en periodos definidos, o aceites para motores, deberán ser tenidas en cuenta las prescripciones de seguridad del fabricante de estos agentes de peligro o combustibles y las regulaciones regionales para el tratamiento de materias residuales. Cuiden también de tener en cuenta en caso dado las prescripciones de seguridad especiales en la descripción del producto.
 6. Ciertos productos, como por ejemplo las instalaciones de radiación HF, pueden a causa de su función natural, emitir una radiación electromagnética aumentada. En vista a la protección de la vida en desarrollo deberían ser protegidas personas embarazadas debidamente. También las personas con un bypass pueden correr peligro a causa de la radiación electromagnética. El empresario está comprometido a valorar y señalar áreas de trabajo en las que se corra un riesgo de exposición a radiaciones aumentadas de riesgo aumentado para evitar riesgos.
 7. La utilización de los productos requiere instrucciones especiales y una alta concentración en el manejo. Debe de ponerse por seguro de que las personas que manejen los productos estén a la altura de los requerimientos necesarios referente a sus aptitudes físicas, psíquicas y emocionales, ya que de otra manera no se pueden excluir lesiones o daños de objetos. El empresario lleva la responsabilidad de seleccionar el personal usuario apto para el manejo de los productos.
 8. Antes de la puesta en marcha del producto se deberá tener por seguro de que la tensión preseleccionada en el producto equivalga a la del la red de distribución. Si es necesario cambiar la preselección de la tensión también se deberán en caso dabo cambiar los fusibles correspondientes del producto.
 9. Productos de la clase de seguridad I con alimentación móvil y enchufe individual de producto solamente deberán ser conectados para el funcionamiento a tomas de corriente de contacto de seguridad y con conductor protector conectado.
 10. Queda prohibida toda clase de interrupción intencionada del conductor protector, tanto en la toma de corriente como en el mismo producto ya que puede tener como consecuencia el peligro de golpe de corriente por el producto. Si se utilizaran cables o enchufes de extensión se deberá poner al seguro, que es controlado su estado técnico de seguridad.
 11. Si el producto no está equipado con un interruptor para desconectarlo de la red, se deberá considerar el enchufe del cable de distribución como interruptor. En estos casos deberá asegurar de que el enchufe sea de fácil acceso y nabejo (medida del cable de distribución aproximadamente 2 m). Los interruptores de función o electrónicos no son aptos para el corte de la red eléctrica. Si los productos sin interruptor están integrados en construcciones o instalaciones, se deberá instalar el interruptor al nivel de la instalación.

Informaciones de seguridad

12. No utilice nunca el producto si está dañado el cable eléctrico. Asegure a través de las medidas de protección y de instalación adecuadas de que el cable de eléctrico no pueda ser dañado o de que nadie pueda ser dañado por él, por ejemplo al tropezar o por un golpe de corriente.
13. Solamente está permitido el funcionamiento en redes de distribución TN/TT aseguradas con fusibles de como máximo 16 A.
14. Nunca conecte el enchufe en tomas de corriente sucias o llenas de polvo. Introduzca el enchufe por completo y fuertemente en la toma de corriente. Si no tiene en consideración estas indicaciones se arriesga a que se originen chispas, fuego y/o heridas.
15. No sobrecargue las tomas de corriente, los cables de extensión o los enchufes de extensión ya que esto pudiera causar fuego o golpes de corriente.
16. En las mediciones en circuitos de corriente con una tensión de entrada de $U_{eff} > 30 \text{ V}$ se deberá tomar las precauciones debidas para impedir cualquier peligro (por ejemplo medios de medición adecuados, seguros, limitación de tensión, corte protector, aislamiento etc.).
17. En caso de conexión con aparatos de la técnica informática se deberá tener en cuenta que estos cumplan los requisitos de la EC950/EN60950.
18. Nunca abra la tapa o parte de ella si el producto está en funcionamiento. Esto pone a descubierto los cables y componentes eléctricos y puede causar heridas, fuego o daños en el producto.
19. Si un producto es instalado fijamente en un lugar, se deberá primero conectar el conductor protector fijo con el conductor protector del aparato antes de hacer cualquier otra conexión. La instalación y la conexión deberán ser efectuadas por un electricista especializado.
20. En caso de que los productos que son instalados fijamente en un lugar sean sin protector implementado, autointerruptor o similares objetos de protección, deberá la toma de corriente estar protegida de manera que los productos o los usuarios estén suficientemente protegidos.
21. Por favor, no introduzca ningún objeto que no esté destinado a ello en los orificios de la caja del aparato. No vierta nunca ninguna clase de líquidos sobre o en la caja. Esto puede producir corto circuitos en el producto y/o puede causar golpes de corriente, fuego o heridas.
22. Asegúrese con la protección adecuada de que no pueda originarse en el producto una sobrecarga por ejemplo a causa de una tormenta. Si no se verá el personal que lo utilice expuesto al peligro de un golpe de corriente.
23. Los productos R&S no están protegidos contra el agua si no es que exista otra indicación, ver también punto 1. Si no se tiene en cuenta esto se arriesga el peligro de golpe de corriente o de daños en el producto lo cual también puede llevar al peligro de personas.
24. No utilice el producto bajo condiciones en las que pueda producirse y se hayan producido líquidos de condensación en o dentro del producto como por ejemplo cuando se desplaza el producto de un lugar frío a un lugar caliente.
25. Por favor no cierre ninguna ranura u orificio del producto, ya que estas son necesarias para la ventilación e impiden que el producto se caliente demasiado. No pongan el producto encima de materiales blandos como por ejemplo sofás o alfombras o dentro de una caja cerrada, si esta no está suficientemente ventilada.
26. No ponga el producto sobre aparatos que produzcan calor, como por ejemplo radiadores o calentadores. La temperatura ambiental no debe superar la temperatura máxima especificada en la hoja de datos.

Informaciones de seguridad

27. Baterías y acumuladores no deben de ser expuestos a temperaturas altas o al fuego. Guardar baterías y acumuladores fuera del alcance de los niños. Si las baterías o los acumuladores no son cambiados con la debida atención existirá peligro de explosión (atención celulas de Litio). Cambiar las baterías o los acumuladores solamente por los del tipo R&S correspondiente (ver lista de piezas de recambio). Baterías y acumuladores son deshechos problemáticos. Por favor tirelos en los recipientes especiales para este fin. Por favor tengan en cuenta las prescripciones nacionales de cada país referente al tratamiento de deshechos. Nunca sometan las baterías o acumuladores a un corto circuito.
28. Tengan en consideración de que en caso de un incendio pueden escaparse gases tóxicos del producto, que pueden causar daños a la salud.
29. Por favor tengan en cuenta que en caso de un incendio pueden desprenderse del producto agentes venenosos (gases, líquidos etc.) que pueden generar daños a la salud.
30. No sitúe el producto encima de superficies, vehículos, estantes o mesas, que por sus características de peso o de estabilidad no sean aptas para él. Siga siempre las instrucciones de instalación del fabricante cuando instale y asegure el producto en objetos o estructuras (por ejemplo paredes y estantes).
31. Las asas instaladas en los productos sirven solamente de ayuda para el manejo que solamente está previsto para personas. Por eso no está permitido utilizar las asas para la sujecion en o sobre medios de transporte como por ejemplo grúas, carretillas elevadoras de horquilla, carros etc. El usuario es responsable de que los productos sean sujetados de forma segura a los medios de transporte y de que las prescripciones de seguridad del fabricante de los medios de transporte sean tenidas en cuenta. En caso de que no se tengan en cuenta pueden causarse daños en personas y objetos.
32. Si llega a utilizar el producto dentro de un vehículo, queda en la responsabilidad absoluta del conductor que conducir el vehículo de manera segura. Asegure el producto dentro del vehículo debidamente para evitar en caso de un accidente las lesiones u otra clase de daños. No utilice nunca el producto dentro de un vehículo en movimiento si esto pudiera distraer al conductor. Siempre queda en la responsabilidad absoluta del conductor la seguridad del vehículo y el fabricante no asumirá ninguna clase de responsabilidad por accidentes o colisiones.
33. Dado el caso de que esté integrado un producto de laser en un producto R&S (por ejemplo CD/DVD-ROM) no utilice otras instalaciones o funciones que las descritas en la documentación. De otra manera pondrá en peligro su salud, ya que el rayo laser puede dañar irreversiblemente sus ojos. Nunca trate de descomponer estos productos. Nunca mire dentro del rayo laser.

Contents

1	Fitting the Option	1.1
2	Manual Operation.....	2.1
2.1	NOISE / DIST Menu.....	2.2
2.2	Measurement of CARRIER/NOISE RATIO (DIAG-C/N MEAS)	2.5
2.3	Loading New Distortion Characteristics	2.6
2.4	Level Correction of the Distortion Simulator.....	2.7
2.5	Calculation of the Distortion Characteristic from Polynomial Equations.....	2.9
3	Remote Control	3.1
3.1	Description of IEC/IEEE-Bus Commands.....	3.1
3.1.1	CALibration System	3.1
3.1.2	DIAGnostic System.....	3.1
3.1.3	SOURCe:DISt Subsystem.....	3.2
3.1.4	SOURCe:NOISe Subsystem	3.6
4	Performance Test.....	4.1
4.1	Test Instructions.....	4.1
4.1.1	Residual Carrier	4.1
4.1.2	Carrier and Image Frequency Suppression and Intermodulation	4.1
4.1.3	Frequency Response through to Outputs I-FADED and Q-FADED	4.2
4.1.4	Frequency Response through to RF Output.....	4.3
4.1.5	Distortion Simulator	4.4
4.1.6	Noise Frequency Response	4.5
4.1.7	Carrier/Noise Ratio	4.6
4.1.8	Error Vector	4.7
4.2	Performance Test Report.....	4.8

Index

A

AM/AM conversion.....	2.6
AM/PM conversion.....	2.6

C

Calibration	
NDSIM and I/Q modulator.....	1.2
Carrier and Image Frequency Suppression and Intermodulation	
Carrier Noise Ratio.....	4.1
Measurement.....	4.6
Measurement.....	2.5
CARRIER/NOISE RATIO.....	2.2
Commands	
CALibration System.....	3.1
DIAGnostic System.....	3.1
SOURce	
DIST Subsystem	3.2
NOISe Subsystem.....	3.6
Conversion	
AM/AM.....	2.6
Interpolation points	2.6
AM/PM.....	2.6
Interpolation points	2.6

D

Distortion	
Switching On/Off.....	2.2
Distortion characteristics	
Calculation from polynomial equations.....	2.9
Enter a new distortion characteristic	2.8
Loading new distortion characteristics	2.6
Selection.....	2.3
Distortion simulator	
Level correction	2.7
Performance test	4.4
Setting commands	3.2

E

Error vector.....	4.7
-------------------	-----

F

Frequency response	
Through to outputs I-FADED and Q-FADED.....	4.2
Through to RF output.....	4.3

I

Installation.....	1.1
Interpolation points	
AM/AM conversion.....	2.6
AM/PM conversion.....	2.6

L

Level correction	
Crest Factor	2.7
Distortion simulator.....	2.7
Polynomial.....	2.4; 3.5

M

Menu	
NOISE/DIST.....	2.2
NOISE/DIST - POLYNOMIAL.....	2.3
UTILITIES - DIAG - C/N MEAS	2.5
Module NDSIM	
View	1.2

N

Noise frequency response.....	4.5
Noise generator	
Setting commands.....	3.6
Noise generator and distortion simulator	
Block diagram	2.1
Functions	2.1
Noise source	
Switching On/Off.....	2.2

P

Performance Test.....	4.1
Performance test report.....	4.8
Polynomial	
Coefficient AM-AM	2.3, 3.5
Coefficient AM-PM	2.3, 3.5
Entering the parameters	2.3
Level correction.....	2.4, 3.5
Polynomial equations	2.9

R

RECALCULATE	2.4, 3.5
Residual carrier	4.1

S

Signal	
Carrier signal.....	2.5
Noise and carrier signal.....	2.5
Noise signal.....	2.5
System bandwidth.....	2.2





Safety Instructions

This unit has been designed and tested in accordance with the EC Certificate of Conformity and has left the manufacturer's plant in a condition fully complying with safety standards.

To maintain this condition and to ensure safe operation, the user must observe all instructions and warnings given in this operating manual.

1. The unit may be used only in the operating conditions and positions specified by the manufacturer. Unless otherwise agreed, the following applies to R&S products:
Pollution severity 2, overvoltage category 2, IP degree of protection 2X, altitude max. 2000 m.
The unit may be operated only from supply networks fused with max. 16 A.
 2. For measurements in circuits with voltages $V_{rms} > 30\text{ V}$, suitable measures should be taken to avoid any hazards.
(using, for example, appropriate measuring equipment, fusing, current limiting, electrical separation, insulation).
 3. If the unit is to be permanently wired, the PE terminal of the unit must first be connected to the PE conductor on site before any other connections are made (installation and cabling of the unit to be performed only by qualified technical personnel).
 4. For permanently installed units without built-in fuses, circuit breakers or similar protective devices, the supply circuit must be fused such as to provide suitable protection for the users and equipment.
 5. Prior to switching on the unit, it must be ensured that the nominal voltage set on the unit matches the nominal voltage of the AC supply network.
If a different voltage is to be set, the power fuse of the unit may have to be changed accordingly.
 6. Units of protection class I with disconnectible AC supply cable and appliance connector may be operated only from a power socket with earthing contact and with the PE conductor connected.
 7. It is not permissible to interrupt the PE conductor intentionally, neither in the incoming cable nor on the unit itself as this may cause the unit to become electrically hazardous.
- Any extension lines or multiple socket outlets used must be checked for compliance with relevant safety standards at regular intervals.
8. If the unit has no power switch for disconnection from the AC supply, the plug of the connecting cable is regarded as the disconnecting device. In such cases it must be ensured that the power plug is easily reachable and accessible at all times (length of connecting cable approx. 2 m). Functional or electronic switches are not suitable for providing disconnection from the AC supply. If units without power switches are integrated in racks or systems, a disconnecting device must be provided at system level.
 9. Applicable local or national safety regulations and rules for the prevention of accidents must be observed in all work performed.
Prior to performing any work on the unit or opening the unit, the latter must be disconnected from the supply network.
Any adjustments, replacements of parts, maintenance or repair may be carried out only by authorized R&S technical personnel.,
Only original parts may be used for replacing parts relevant to safety (eg power switches, power transformers, fuses). A safety test must be performed after each replacement of parts relevant to safety.
(visual inspection, PE conductor test, insulation-resistance, leakage-current measurement, functional test).
 10. Ensure that the connections with information technology equipment comply with IEC950/EN60950.
 11. Equipment returned or sent in for repair must be packed in the original packing or in packing with electrostatic protection.
 12. Any additional safety instructions given in this manual are also to be observed.

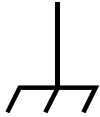
Safety-related symbols used on equipment and documentation from R&S:

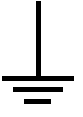
						
Observe operating instructions	Weight indication for units >18 kg	PE terminal	Ground terminal	Danger! Shock hazard	Warning! High temperatures Warning! Hot surfaces	Ground



ROHDE & SCHWARZ
EC Certificate of Conformity



Certificate No.: 99015

This is to certify that:

Equipment type	Order No.	Designation
SMIQ02B	1125.5555.02	Vector Signal Generator
SMIQ03B	1125.5555.03	
SMIQB10	1085.5009.02	Modulation Coder
SMIQB11	1085.4502.02	Data Generator
SMIQB12	1085.2800.02	Memory Extension
SMIQB14	1085.4002.02	Fading Simulator
SMIQB15	1085.4402.02	Second Fading Simulator
SMIQB17	1104.9000.02	Noise Generator
SMIQB46	1105.0006.02	Low ACP
SMIQB47	1125.5090.02	Low ACP

complies with the provisions of the Directive of the Council of the European Union on the approximation of the laws of the Member States

- relating to electrical equipment for use within defined voltage limits
(73/23/EEC revised by 93/68/EEC)
- relating to electromagnetic compatibility
(89/336/EEC revised by 91/263/EEC, 92/31/EEC, 93/68/EEC)

Conformity is proven by compliance with the following standards:

EN61010-1 : 1993 + A2 : 1995
EN50081-1 : 1992
EN50082-2 : 1995

Affixing the EC conformity mark as from 1999

ROHDE & SCHWARZ GmbH & Co. KG
Mühldorfstr. 15, D-81671 München

Munich, 1999-02-25

Central Quality Management FS-QZ / Becker

1 Fitting the Option

Depending on which options are fitted, the NDSIM module (option SMIQB17) is mounted in the slot labelled FSIM1/FMOD/NDSIM or FSIM2/FMOD/NDSIM or E6GHZ/FMOD/NDSIM (in older units slot FSIM1/FMOD or FSIM2/FMOD).

To ensure that the firmware supports the option, the firmware version 3.70 or higher is necessary. The current firmware can be loaded with the enclosed disk.

After an instrument warm-up period of 1 hour, the NDSIM as well as the IQ Modulator should be calibrated. Then the instrument is ready for use.

Six coaxial connecting cables (W601, W602, W603, W388 or W604, W605, W391 or W606) and the adhesive option label are part of the equipment supplied with the option.

Fitting the option

- Plug the module into the appropriate slot.
- Lock it and fasten all screws.
- Open the air inlets at the housing frame by breaking out the safety glass plate which belongs to the option.
- If options FSIM1 and FSIM2 are fitted, cables W388 (W604) and W391 (W606) have to be connected as shown in the following tables.
- Depending on which modules are installed in the SMIQ, the following coaxial connections are to be made:

		SMIQ without option MCOD without option FSIM1 without option FSIM2	SMIQ with option MCOD without option FSIM1 without option FSIM2	Remark about cable
Cable	from NDSIM	to	to	
W244	X601	FRO I-connector	-	Cable was provided with unit
W245	X602	FRO Q-connector	-	Cable was provided with unit
W601	X601	-	MCOD X325	W601 was provided with NDSIM
W602	X602	-	MCOD X328	W602 was provided with NDSIM
W603	X603	IQMOD X244	IQMOD X244	W603 was provided with NDSIM
W388	X604	REAR I-FADED	REAR I-FADED	W388 was provided with NDSIM, valid for SMIQ 1125.5555.xx
W604	X604	AUX I-FADED	AUX I-FADED	W604 was provided with NDSIM, valid for SMIQ 1084.8004.xx
W605	X605	IQMOD X245	IQMOD X245	W605 was provided with NDSIM
W391	X606	REAR Q-FADED	REAR Q-FADED	W391 was provided with NDSIM, valid for SMIQ 1125.5555.xx
W606	X606	AUX Q-FADED	AUX Q-FADED	W606 was provided with NDSIM, valid for SMIQ 1084.8004.xx

		SMIQ with option MCOD with option FSIM1 without option FSIM2	SMIQ with option MCOD with option FSIM1 with option FSIM2	Remark about cable
Cable	from NDSIM	to	to	
W601	X601	FSIM1 X367	FSIM1 X367	W601 was provided with NDSIM
W602	X602	FSIM1 X370	FSIM1 X370	W602 was provided with NDSIM
W603	X603	IQMOD X244	IQMOD X244	W603 was provided with NDSIM
W388	X604	REAR I-FADED	REAR I-FADED	W388 was provided with NDSIM, valid for SMIQ 1125.5555.xx
W604	X604	AUX I-FADED	AUX I-FADED	W604 was provided with NDSIM, valid for SMIQ 1084.8004.xx
W605	X605	IQMOD X245	IQMOD X245	W605 was provided with NDSIM
W391	X606	REAR Q-FADED	REAR Q-FADED	W391 was provided with NDSIM, valid for SMIQ 1125.5555.xx
W606	X606	AUX Q-FADED	AUX Q-FADED	W606 was provided with NDSIM, valid for SMIQ 1084.8004.xx

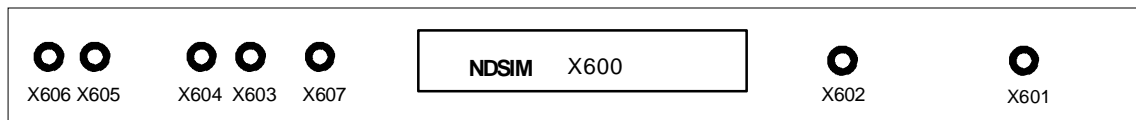

Fig. 1-1 Module NDSIM

Connector X607 is unused and provided only in some modules.

- The included adhesive label 'Option included' is to be fixed at the rear panel of the SMIQ.

Calibrating the NDSIM and the I/Q Modulator

- Warm-up the instrument for 1 hours.
- Call up menu UTILITIES - CALIB - VECTOR MOD.

2 Manual Operation

The noise generator and the distortion simulator perform the following two functions:

- Addition of noise to SMIQ output level. Since the CARRIER/NOISE RATIO can be finely varied, different reception conditions can be realistically simulated.
- Simulation of TWTA (Traveling Wave Tube Amplifier) distortion of satellite. The signal received by the satellite is strongly distorted and thus more difficult to demodulate than an undistorted signal. Real reception conditions can be simulated with the distortion simulator and the receivers can thus be tested realistically.

The noise generator outputs an AWGN signal (Additive White Gaussian Noise), ie the noise power ratio is Gaussian-distributed and the noise signal is added to the signal.

Distortion is performed via AM/AM conversion and AM/PM conversion. The respective characteristics can be loaded or modified via IEC/IEEE bus.

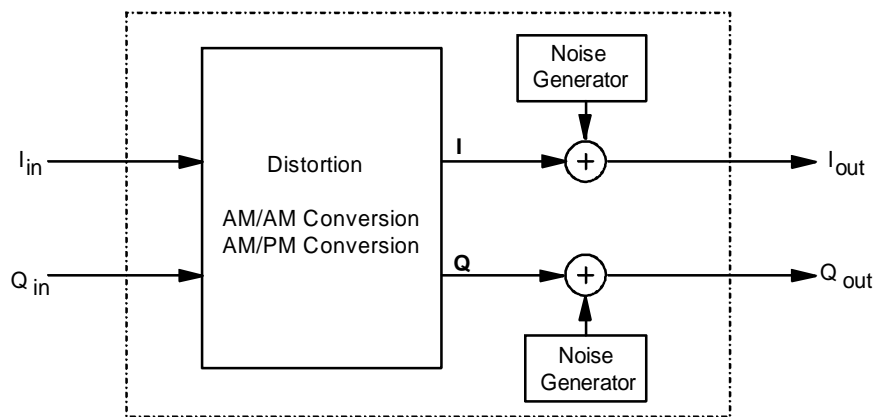

Fig. 2-1 Block diagram of noise generator and distortion simulator

The noise generator and distortion simulator are independant functional units and can be operated separately. They exclusively use baseband signals I and Q. Both external I/Q signals and I/Q signals internally generated by the modulation coder can be distorted and superimposed with noise. The noise generator can also be switched on if internal and external modulation are switched off. The unmodulated carrier is then superimposed with the noise signal.

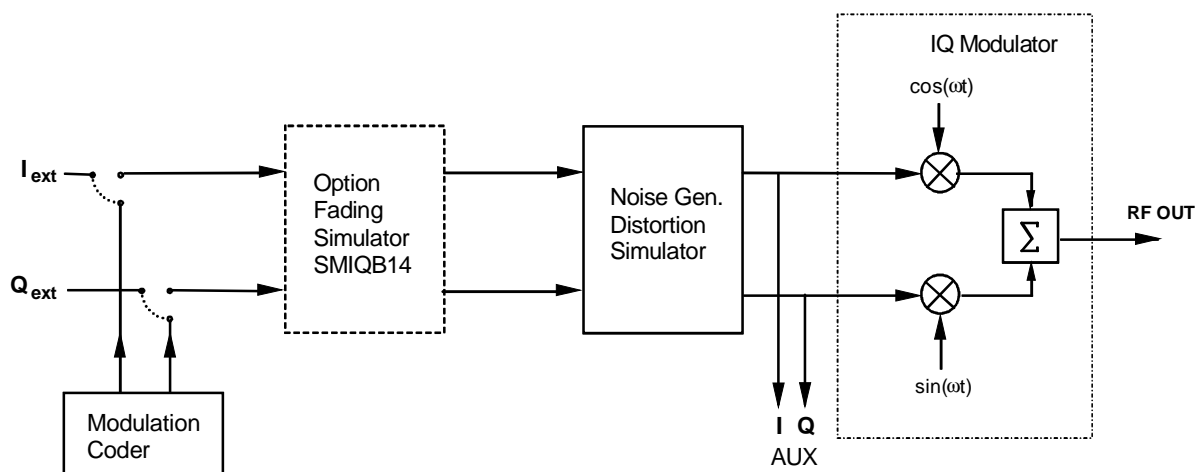

Fig. 2-2 Noise generator and distortion simulator in SMIQ

2.1 NOISE / DIST Menu

The NOISE/DIST menu comprises all the settings of the noise generator and the distortion simulator.

For calibration of the noise generator and the distortion simulator, see Operating Manual of SMIQ, Chapter 2, Section Calibration VECTOR MOD.

Note: Functions NOISE/DIST and BB-AM cannot be set at the same time and switch off mutually.

Menu selection: NOISE/DIST

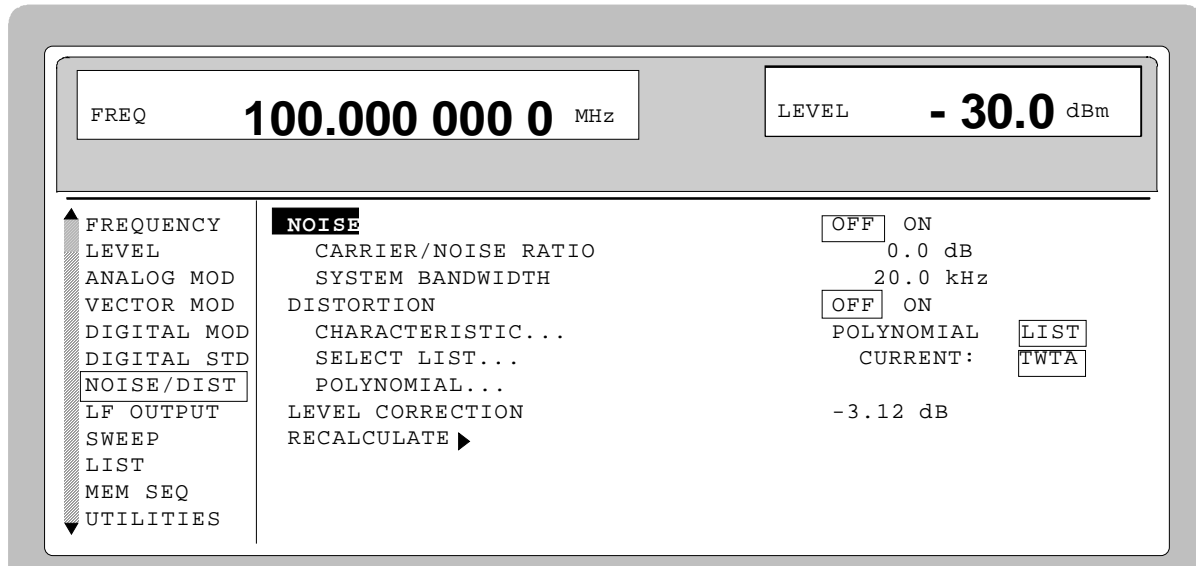

Fig. 2-3 Menu NOISE/DIST (presetting)

NOISE Switch on/off of noise source. The noise source is an AWGN (Additive White Gaussian Noise) signal.

IEC/IEEE-bus command : SOUR:NOIS ON

CARRIER/NOISE RATIO Input value of the carrier-to-noise ratio. Setting range is 5.0 to 30 dB. When changing the CARRIER/NOISE RATIO, the noise power is changed as well but the carrier power remains unchanged. The carrier power is the power displayed in the header under LEVEL.

IEC/IEEE-bus command : SOUR:NOIS:SNR 10 DB

SYSTEM BANDWIDTH Input value of system bandwidth. The system bandwidth is the HF-bandwidth by which the noise power is calculated. The bandwidth of the generated system noise can only be set in steps. The set bandwidth is to be 1.4 times the system bandwidth at minimum and 10 MHz at maximum.

Setting range: 10 kHz to 10 MHz;
Resolution: three digits

IEC/IEEE-bus command : SOUR:NOIS:BAND 1.23 MHz

DISTORTION Switch on/off of distortion.

IEC/IEEE-bus command : SOUR:DIST ON

CHARACTERISTIC... Switchover between distortion data from the polynomial and list. Under polynomial the distortion data are calculated from the coefficients entered into the polynomial menu. Under list they are calculated according to the characteristic transferred via the IEC/IEEE-bus and selected under SELECT LIST.

IEC/IEEE-bus command : SOUR: DIST: MODE POLY | DATA

SELECT LIST... Opens a window for selecting the distortion characteristics. Several distortion characteristics can be stored in the memory at the same time.

IEC/IEEE-bus command : SOUR: DIST: DATA: SEL "TWTA"

POLYNOMIAL Opens a window for entering the polynomial parameters.

Menu selection: NOISE/DIST - POLYNOMIAL...

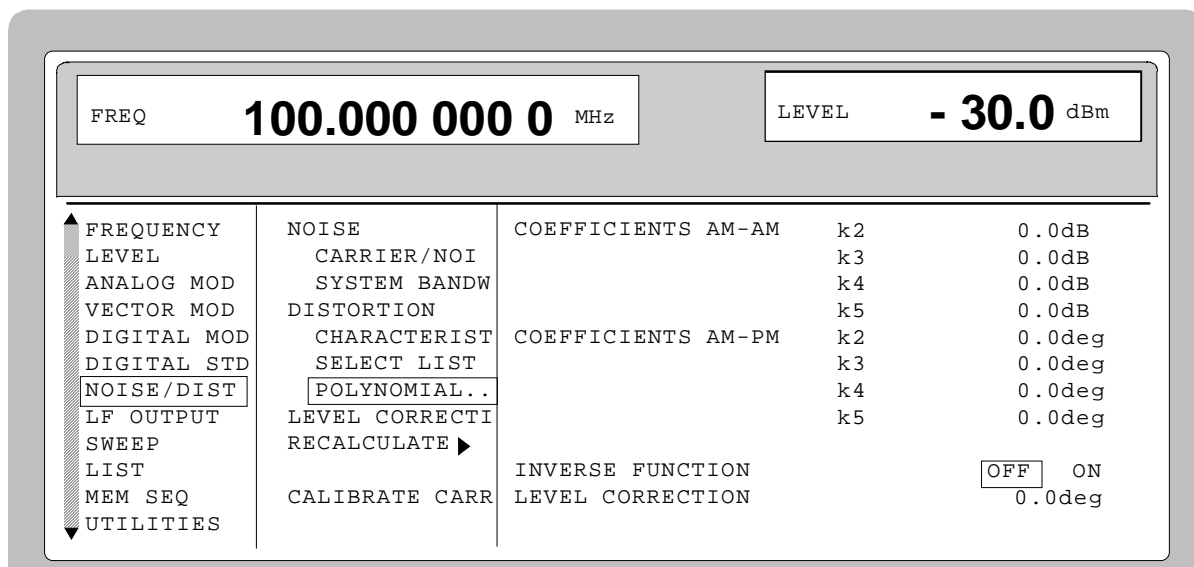

Fig. 2-4 Menu NOISE/DIST - POLYNOMIAL...

(POLYNOMIAL) COEFFICIENT AM-AM Entry of polynomial coefficients k2 to k5 for the AM-AM distortion in dB. The polynomial has the following form:

$$A_{out} = A_{in} + n_2 \cdot A_{in}^2 + n_3 \cdot A_{in}^3 + n_4 \cdot A_{in}^4 + n_5 \cdot A_{in}^5$$
 with $n_{<i>i>} = 10^{(k_{<i>i>}/20)} - 1$, $i = 2, 3, 4, 5$
 Normalization: $A_{out_n} = 0 \dots 1$, $A_{in} = 0 \dots 1$
 The coefficient n0 is always 0 and n1 is always 1.
 Value range: -10.0 to +10.0 dB
 IEEE-bus : SOUR: DIST: POLY: AMAM: K2 -2 DB

COEFFICIENT AM-PM Entry of polynomial coefficients k2 to k5 for the AM-PM distortion in degrees. The polynomial has the following form:

$$P_{out} = P_{in} + k_2 \cdot A_{in}^1 + k_3 \cdot A_{in}^2 + k_4 \cdot A_{in}^3 + k_5 \cdot A_{in}^4$$
 The coefficients K0 and K1 are always 0.
 Value range: - 60.0 to + 60.0 degrees.
 IEEE-bus : SOUR: DIST: POLY: AMPM: K3 -45 DEG

- (POLYNOMIAL)**
- INVERSE FUNCTION** Compensation of an amplifier connected after the SMIQ, the coefficients entered correspond to the measured distortion of the amplifier.
OFF The above equations are applicable.
ON AM-AM distortion:
 inverse function of $A_{out_n}(A_{in})$,
 AM-PM distortion:
 $P_{out} = P_{in} - k_2 * A_{out_n}(A_{in})^1 -$
 $k_3 * A_{out_n}(A_{in})^2 - k_4 * A_{out_n}(A_{in})^3 -$
 $k_5 * A_{out_n}(A_{in})^4$
 IEEE-bus : SOUR: DIST: POLY: IFUN ON
- LEVEL CORRECTION** Entry of the level correction for the polynomial. The value entered is active and is displayed in the main menu after selection of the polynomial and calling up RECALCULATE. It can be edited only here.
 Value range: -20 dB to +6 dB
 IEEE-bus : SOUR: DIST: POLY: LEV: CORR -10 DB
- LEVEL CORRECTION** Display of level correction to correct the output level so that the attenuation or gain of the distortion simulator can be compensated. For the polynomial the level correction can be entered into submenu POLYNOMIAL. The level correction for the lists can only be transferred via the IEC/IEEE bus.
 Value range: -20 dB to +6 dB
 IEC/IEEE-bus command : SOUR: DIST: DATA: LEV: CORR -3.12 DB
- RECALCULATE ►** Distortion data are active since as they are transferred into the module. This is necessary when the available characteristic has been overwritten via the IEC/IEEE bus or when a polynomial parameter has been modified.
 IEC/IEEE-bus command : SOUR: DIST: REC

2.2 Measurement of CARRIER/NOISE RATIO (DIAG-C/N MEAS)

Submenu DIAG-C/N MEAS sets the instrument into a mode to measure the carrier/noise ratio for service purposes.

Menu selection: UTILITIES - DIAG - C/N MEAS

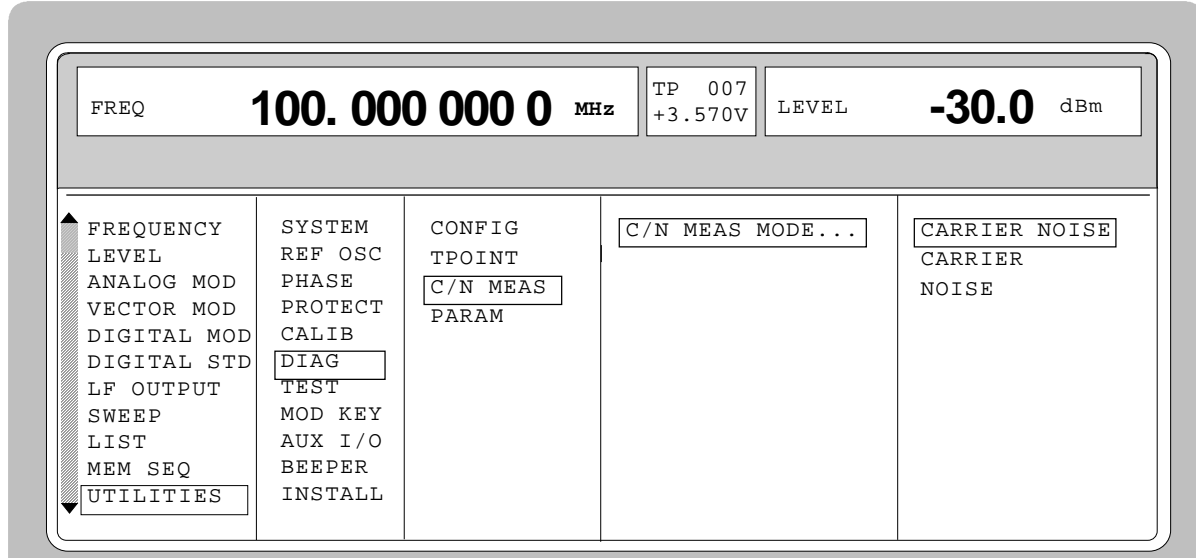

Fig. 2-5 Menu UTILITIES - DIAG - C/N MEAS

CARRIER NOISE	Noise and carrier signal IEC/IEEE-bus command	:DIAG:CNM:MODE CN
CARRIER	Only carrier signal IEC/IEEE-bus command	:DIAG:CNM:MODE CARR
NOISE	Only noise signal IEC/IEEE-bus command	:DIAG:CNM:MODE NOIS

2.3 Loading New Distortion Characteristics

SMIQ is supplied with a preset distortion characteristic that corresponds to the typical characteristic of a traveling wave tube amplifier in WorldSpace satellites. The name of the characteristic set as standard is TWTA (Traveling Wave Tube Amplifier). Other user-defined distortion characteristics can also be stored in SMIQ. If several characteristics are stored, they can be selected under SELECT LIST... .

A new characteristic is formed by the interpolation points of AM/AM and AM/PM conversion. Entry is possible via IEC/IEEE bus. SMIQ determines the complete characteristic based on these interpolation points by cubic spline interpolation. The factory-set characteristics (TWTA) of AM/AM and AM/PM conversion are shown in the following figures. The continuous line indicates the interpolated characteristic. The circles show the reference points. The input values are on the x-axis, the output values on the y-axis.

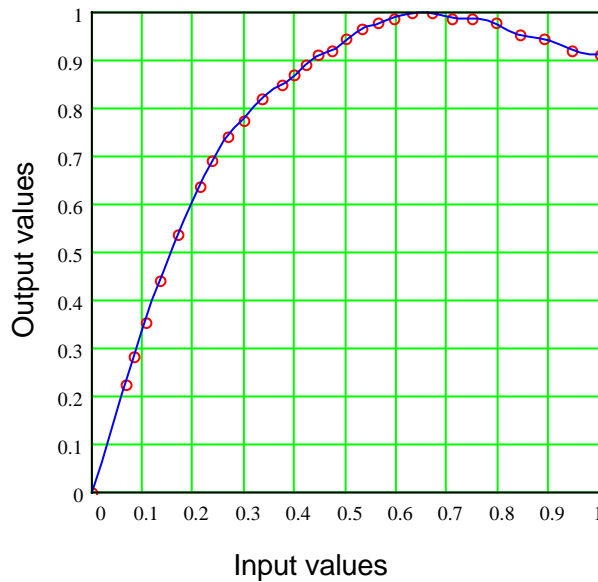

Fig. 2-6 AM/AM conversion

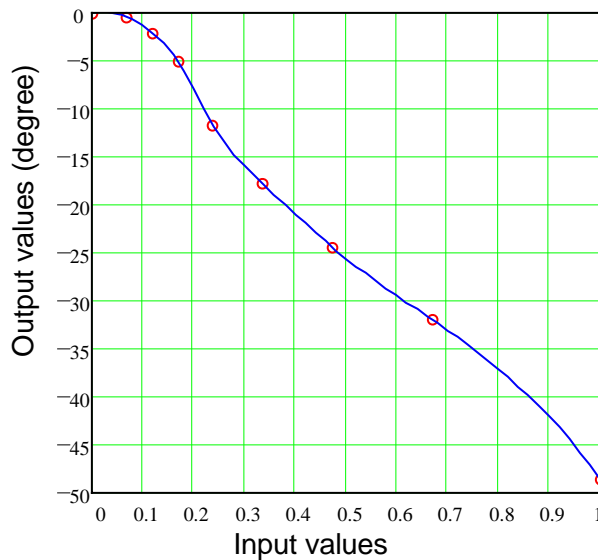

Fig. 2-7 AM/PM conversion

The two characteristics are formed by 2 data fields, the x-axis and the y-axis. 4 data fields therefore have to be loaded for a new distortion characteristic. The minimum number of interpolation points that can be entered for a characteristic is 5, the maximum number is 30. The limit values for the data fields are as follows:

Input values (x-axis) of AM/AM conversion:	-100 dB to 0 dB
Output values (y-axis) of AM/AM conversion:	-100 dB to 0 dB
Input values (x-axis) of AM/PM conversion:	-100 dB to 0 dB
Output values (y axis) of AM/PM conversion:	-180° to +180°

2.4 Level Correction of the Distortion Simulator

The level correction influences the level if digital modulation is switched on (not with VECTOR MOD ON) and the distortion simulator is active.

For the rms level set as LEVEL to appear at the RF output, the level control has to compensate for the attenuation or gain of the distortion characteristic. For this purpose, level correction (-20 dB to 6 dB) stored under the previously selected name is transmitted via IEC/IEEE-bus command. If this characteristic is active, the output level is increased or decreased by the level-correction value. The value by which the level is increased or decreased is indicated under LEVEL CORRECTION.

As the attenuation/gain of the distortion characteristic is dependent on the type of input signal being dealt with, the level correction applies only to one particular type of digital modulation (modulation type, filter type and filter parameters) and fading setting.

For the characteristic TWTA, for instance, which is supplied as standard, -3.12 dB is stored as level correction. This value only applies to "WorldSpace Modulation" (QPSK, SQR-COS/0.4).

For the determination of level correction through measurement, the parameter is at first set to 0 dB via IEC/IEEE bus. The desired type of digital modulation is then set, and the characteristic TEST (linear characteristic supplied, LEVEL CORRECTION = 0 dB) activated, followed by the new characteristic. The level difference of the two characteristics is measured at the RF output by means of an RF level meter. The level correction for the new characteristic is then adjusted to the level difference measured via IEC/IEEE bus. If the level difference is measured again, the result should be 0 dB \pm 0.1 dB.

As theoretically the characteristic gain (negative level correction) cannot exceed the crest factor of the modulation used, the warning "Warning 426 Absolute value of level correction > crest factor of Digital Mod;" is displayed if the magnitude of the negative level correction exceeds the crest factor. The correction is also restricted to the crest factor when the level is set, so LEVEL and PEP are identical.

Step-by-step instruction to enter a new distortion characteristic via IEC/IEEE bus:

- | | |
|---|---|
| 1. Enter the name of a new characteristic | <hr/> IEC/IEEE-bus command
<pre>:SOUR:DIST:DATA:SEL "TWTAl"</pre> The characteristic is listed under a freely selectable name (max. 8 characters) in the select menu that comprises different characteristics. |
| 2. Enter the data field for input values (x-axis) of AM/AM conversion in dB | <hr/> IEC/IEEE-bus command
<pre>:SOUR:DIST:DATA:AMB -23.5,-21.5,-19.5,-17.5,-15.5,-13.5,-12.5,-11.5,-10.5,-9.5,-8.5,-8,-7.5,-7,-6.5,-6,-5.5,-5,-4.5,-4,-3.5,-3,-2.5,-2,-1.5,-1,-0.5,0</pre> |
| 3. Enter the data field for output values (y-axis) of AM/AM conversion in dB | <hr/> IEC/IEEE-bus command
<pre>:SOUR:DIST:DATA:AM -12.9,-10.9,-9,-7.1,-5.4,-3.9,-3.2,-2.6,-2.2,-1.7,-1.4,-1.2,-1,-0.8,-0.7,-0.5,-0.3,-0.2,-0.1,0,0,-0.1,-0.1,-0.2,-0.4,-0.5,-0.7,-0.8</pre> |
| 4. Enter the data field for input values (x-axis) of AM/PM conversion in dB | <hr/> IEC/IEEE-bus command
<pre>:SOUR:DIST:DATA:PMB -23.5,-18.5,-15.5,-12.5,-9.5,-6.5,-3.5,0</pre> |
| 5. Enter the data field for output values (y-axis) of AM/PM conversion in degrees | <hr/> IEC/IEEE-bus command
<pre>:SOUR:DIST:DATA:PM 0,-2.1,-5,-11.6,-17.7,-24.4,-31.9,-48.6</pre> |
| 6. Enter the level correction | <hr/> IEC/IEEE-bus command
<pre>:SOUR:DIST:DATA:LEV:CORR -3.12</pre> |
| 7. Data transmission to the module | <hr/> IEC/IEEE-bus command
<pre>:SOUR:DIST:REC</pre> |

Note: The values of the above example correspond to the TWTa characteristic that is supplied.

2.5 Calculation of the Distortion Characteristic from Polynomial Equations

A characteristic can be defined by entering polynomial coefficients in submenu POLYNOMIAL instead of transferring reference values via the IEC/IEEE bus. The characteristic is calculated and loaded from the four polynomial coefficients for AM-AM and AM-PM using the equations specified under section 2.1. An IEC/IEEE-bus transfer is not required in this case.

It is possible to compensate the distortion of an amplifier connected after the SMIQ using the INVERSE FUNCTION.

The characteristic entered via polynomial coefficients should be identical to the distortion characteristic of the amplifier.

The level correction described in section 2.4 can be directly entered in the POLYNOMIAL menu. If the polynomial is activated, this value can be displayed and set in the NOISE/DIST menu under LEVEL CORRECTION. The determination by measurement of the level correction is performed as described in section 2.4.

3 Remote Control

3.1 Description of IEC/IEEE-Bus Commands

3.1.1 CALibration System

The CALibration system contains the commands to calibrate the noise generator and distortion simulator.

Command	Parameter	Default Unit	Remark
:CALibrate :NDSim [:MEASure]?			Query only

:CALibration:NDSim[:MEASure]?

This command triggers an offset calibration of module NDSIM.

Example: :CAL:NDS?

Answer: 0 if OK, 1 if faulty.

3.1.2 DIAGnostic System

The DIAGnostic system contains the commands for the settings that allow the Noise/Dist Ratio to be measured.

Command	Parameter	Default Unit	Remark
:DIAGnostic :CNMeasure :MODE	CN CARRier NOISe		

:DIAGnostic:CNMeasure:MODE CN | CARRier | NOISe

This command determines the signal at the output of the instrument. The following modes can be selected:

CN carrier and noise signal

CARRier carrier signal only

NOISe noise signal only

Example: :DIAG:CNM:MODE CN

*RST value is CN

3.1.3 SOURCe:DiST Subsystem

Subsystem DiSTortion comprises all commands for setting the distortion simulator. The NDSim subsystem under CALibrate is available for the offset calibration.

Command	Parameter	Default Unit	Remark
[:SOURce]			
:DiSTortion			Not-SCPI
[:STATe]	ON OFF		
:MODE	POLYnomial DATA		
:DATA			
:CATalog?			Query only
:SElect	"name of characteristic"		
:DElete	"name of characteristic"		
:ALL			
:AM	-100 dB to 0 dB {, -100 dB to 0 dB } block data	dB	
:FREE?			Query only
:POINts?			Query only
:AMBase	-100 dB to. 0 dB {, -100 dB to 0 dB } block data	-	
:POINts?			Query only
:PM	-180 degrees ... +180 degrees {, -180 degreesto +180 degrees} block data	dB	
:FREE?			Query only
:POINts?			Query only
:PMBase	-100 dB to 0 dB {, -100 dB to 0 dB } block data	-	
:POINts?			Query only
:LEVel			
:CORRection	-20.0 to 6.00	dB	
:POLYnomial			Not-SCPI
:AMAM			
:K<i>	-10 dB to +10 dB	dB	
:AMPM			
:K<i>	-60 deg to +60 deg		
:IFUNction	ON OFF		
:LEVel			
:CORRection	-20 dB to +6 dB	dB	
:RECalculate			

[:SOURce]:DiSTortion[:STATe] ON | OFF

This command switches the distortion function on or off.

Example: `:SOUR:DiST ON`

*RST value is OFF

[:SOURce]:DiSTortion:MODE POLYnomial | DATA

Distortion data are calculated either by a list (`:DiST:DATA...` commands) or from the coefficients of a polynomial (`:DiST:POLY...` commands).

Example: `:SOUR:DiST POLY`

*RST value is DATA

[:SOURCE]:DISTORTION:DATA:AMBASE:POINTS?

This command provides the length of the input-value list (x-axis) of AM/AM conversion in elements. The command is a query and hence has no *RST value.

Example: `:SOUR:DIST:DATA:AMB:POINTs?` Answer eg: 0

[:SOURCE]:DISTORTION:DATA:PM -180 degrees to +180 degrees {, -180 degrees to +180 degrees } | block data

This command fills the output values (y-axis) for the AM/PM conversion of the selected characteristic with data. The data can be transmitted as a list of any length separated by commas or as a binary block. If they are transmitted as block data, 8 (4) bytes are interpreted as floating-point value with double accuracy; settable with command `FORMAT:DATA`. *RST does not influence data lists.

Example: `:SOUR:DIST:DATA:PM 0,-1.2,-3.8,-9.5,-15.9,-23,-30.4,-43.4`

[:SOURCE]:DISTORTION:DATA:PM:FREE?

This command outputs two values. One indicates the remaining storage capacity for new AM/PM characteristics and the other provides information about the space which is already occupied. All indications refer to the number of elements. The command is a query and hence has no *RST value.

Example: `:SOUR:DIST:DATA:PM:FREE?` Answer eg: 30, 0

[:SOURCE]:DISTORTION:DATA:PM:POINTS?

The command provides the length of the output-value list (y-axis) of AM/PM conversion in elements. The command is a query and hence has no *RST value.

Example: `:SOUR:DIST:DATA:PM:POINTs?"` Answer eg: 0

[:SOURCE]:DISTORTION:DATA:PMBASE -100 dB to 0 dB {, -100 dB to 0 dB } | block data

This command fills the input values (x-axis) for the AM/PM conversion of the selected characteristic with data. The data can be transmitted as a list of any length separated by commas or as a binary block. If they are transmitted as block data, 8 bytes are interpreted as floating-point value; settable with command `FORMAT:DATA`. *RST does not influence data lists.

Example: `:SOUR:DIST:DATA:PMB -23.5,-18.5,-15.5,-12.5,-9.5,-6.5,...`

[:SOURCE]:DISTORTION:DATA:PMBASE:POINTS?

The command provides the length of the input-value list (x-axis) of AM/PM conversion in elements. The command is a query and hence has no *RST value.

Example: `:SOUR:DIST:DATA:PMB:POINTs?"` Answer eg: 0

[:SOURCE]:DISTORTION:DATA:LEVEL:CORRECTION -20 to +6.00 dB

This command serves for setting the level correction for a particular characteristic.

Example: `:SOUR:DIST:DATA:LEV:CORR -3.12 dB` *RST value is 0 dB

[:SOURce]:DISTortion:POLYnomial:AMAM:K<i> -10 dB to +10 dB

The command sets the coefficients k2 to k5 for the AM-AM distortion.

Example: :SOUR:DIST:POLY:AMAM:K3 3.4 dB

*RST value is 0 dB

[:SOURce]:DISTortion:POLYnomial:AMPM:K<i> -60 deg to +60 deg

The command sets the coefficients k2 to k5 for the AM-PM distortion.

Example: :SOUR:DIST:POLY:AMPM:K4 12.8 deg

*RST value is 0 deg

[:SOURce]:DISTortion:POLYnomial:IFUNction ON | OFF

The command switches on and off the inversion of the distortion characteristic to compensate an amplifier connected after the SMIQ.

Example: :SOUR:DIST:POLY:IFUN ON

*RST value is OFF

[:SOURce]:DISTortion:POLYnomial:LEVel:CORRection -20 dB to +6 dB

The command sets the level correction for the distortion characteristic from the polynomial coefficients.

Example: :SOUR:DIST:DATA:LEV:CORR -3.12 DB

*RST value is 0 dB

[:SOURce]:DISTortion:RECalculate

The distortion data transmitted to the unit via IEC/IEEE bus are loaded in the module and become active. This command triggers an action and therefore has no *RST value.

Example: :SOUR:DIST:REC

3.1.4 SOURCe:NOISe Subsystem

Subsystem NOISe comprises all commands for setting the noise generator. The NDSim subsystem under CALibrate is available for the offset calibration. In the DIAGnostic subsystem the noise or carrier signal can be switched off for C/N measurements (refer to chapter 4, Performance Test, in the Operating Manual).

Command	Parameter	Default Unit	Remark
:NOISe			Not-SCPI
[:STATe]	ON OFF		
:SNRatio	-5.0 to 30.0	dB	
:BANDwidth BWIDth	10k to 10M	Hz	

[:SOURce]:NOISe[:STATe] ON | OFF

This command switches White Gaussian Noise on or off.

Example: `:SOUR:NOIS ON`

*RST value is OFF

[:SOURce]:NOISe:SNRatio -5.0 to 30.0 dB

This command sets the S/N ratio.

Setting range is -5 dB to +30 dB, resolution is 0.1 dB.

Example: `:SOUR:NOIS:SNR 10 DB`

*RST value is 0 dB

[:SOURce]:NOISe:BANDwidth|BWIDth 10000 to 10000000 Hz

This command sets the noise bandwidth. Setting range is 10 kHz to 10 MHz.

Example: `:SOUR:NOIS:BAND 1.23 MHZ`

*RST value is 10 kHz

4 Performance Test

4.1 Test Instructions

4.1.1 Residual Carrier

Test equipment	Spectrum analyzer (Operating Manual SMIQ, Table 5-1, item 2).
Test setup	<ul style="list-style-type: none"> ➤ Connect the spectrum analyzer to the RF output of the SMIQ. ➤ Terminate I and Q inputs with 50 Ω.
Measurement	<ul style="list-style-type: none"> ➤ SMIQ settings <ul style="list-style-type: none"> - Test level 7 dBm - Test frequencies 1.472 GHz and according to Table 5-2 (Operating Manual SMIQ). - Switch on noise/distortion characteristic TEST. - Select OFF in the VECTOR MOD/STATE menu. ➤ Analyzer setting <ul style="list-style-type: none"> - Center frequency = test frequency, span 1 MHz, - Reference level = test level - Scale 10 dB/div. ➤ First, measure the unmodulated level as reference. ➤ Then, switch on the vector modulation with open inputs (STATE ON) and measure the residual carrier. <ul style="list-style-type: none"> ⇒ The residual carrier in dBc corresponds to the level of the residual signal found referred to the output signal of the test item without modulation (dBc = referred to the carrier).

4.1.2 Carrier and Image Frequency Suppression and Intermodulation

Test equipment	Spectrum analyzer (Operating Manual SMIQ, Table 5-1, item 2).
Test setup	<ul style="list-style-type: none"> ➤ Connect the spectrum analyzer to the RF output of the SMIQ.
Measurement	<ul style="list-style-type: none"> ➤ SMIQ settings <ul style="list-style-type: none"> - Test level 7dBm. - Test frequencies 1.472 GHz and according to Table 5-2 (SMIQ). - Switch on noise/distortion characteristic TEST. - Switch on digital modulation $\pi/4$ DQPSK. - Symbol rate 800 ksym/s - Filter SQR COS 0.35 - Data source PATTERN 0 ➤ Analyzer setting <ul style="list-style-type: none"> - Center frequency = test frequency, span 1MHz, - Reference level = test level ➤ Measure spectral-line level at test frequency +100 kHz. ➤ Then measure spectral lines at test frequency, test frequency -100 kHz/+200 kHz/+300 kHz, and calculate level difference to first level measurement.

4.1.3 Frequency Response through to Outputs I-FADED and Q-FADED

Test equipment	<ul style="list-style-type: none">- Spectrum analyzer (Operating Manual SMIQ, Table 5-1, item 2).- Generator (Table 5-1, item 5, Operating Manual SMIQ).
Test setup	<ul style="list-style-type: none">➤ Connect SMIQ rear-panel output I-FADED to the spectrum analyzer and the generator to the I input of SMIQ.➤ Terminate Q input with 50 Ω.
Test method	<p>If a sinusoidal AC voltage is applied to the I input, the signal output at AUX will also be sinusoidal, and its level can be measured with the spectrum analyzer.</p>
Measurement	<ul style="list-style-type: none">➤ SMIQ settings<ul style="list-style-type: none">- Switch on Vector Modulation- Switch on noise/distortion characteristic TEST.➤ Generator settings<ul style="list-style-type: none">- Level 0.5 V (V_{peak}) corresponding to 4 dBm.➤ Analyzer setting<ul style="list-style-type: none">- Start frequency = 0 MHz- Stop frequency = 5 MHz➤ Vary the generator frequency from 0.1 to 5 MHz and measure the level.➤ For evaluation, determine level difference referred to 0.1 MHz.<ul style="list-style-type: none">⇒ The modulation frequency response is the difference between highest and lowest level.
Test setup	<ul style="list-style-type: none">➤ Connect SMIQ rear-panel output Q-FADED to the spectrum analyzer and the generator to the Q input of SMIQ.➤ Terminate I input with 50 Ω.
Measurement	<ul style="list-style-type: none">➤ as above

4.1.4 Frequency Response through to RF Output

Test equipment	<ul style="list-style-type: none">- Spectrum analyzer (Operating Manual SMIQ, Table 5-1, item 2).- Generator (Operating Manual SMIQ, Table 5-1, item 5).
Test setup	<ul style="list-style-type: none">➤ Connect the spectrum analyzer to the RF output of the SMIQ.➤ Connect the generator to the I output of the SMIQ.➤ Terminate Q input with 50 Ω.
Test method	By applying a sinusoidal AC voltage to the I input, an amplitude modulation with carrier suppression is generated. Modulation frequency response is determined by measuring the sidebands in dependence of the frequency of the AC voltage applied.
Measurement	<ul style="list-style-type: none">➤ SMIQ settings<ul style="list-style-type: none">- Test level 7dBm- Test frequencies 1.472 GHz and according to Table 5-2 (SMIQ).- Switch on vector modulation- Switch on noise/distortion characteristic TEST.➤ Generator settings<ul style="list-style-type: none">- Level 0.5 V (V_{peak}) corresponding to 4 dBm.➤ Analyzer setting<ul style="list-style-type: none">- Center frequency = test frequency, span 10 MHz,- Reference level = test level- Scale 1 dB/div.➤ Vary frequency at generator between 0.1 and 5 MHz and observe modulation sidebands on the analyzer.➤ For evaluation, determine difference between modulation sidebands and the first sideband at 0.1 MHz.<ul style="list-style-type: none">⇒ Modulation frequency response is the difference between the top and bottom sidebands.
Test setup	<ul style="list-style-type: none">➤ Connect the generator to Q input of SMIQ.➤ Terminate I input with 50 Ω.
Measurement	<ul style="list-style-type: none">➤ as above

4.1.5 Distortion Simulator

Test equipment	Spectrum analyzer (Operating Manual SMIQ, Table 5-1, item 2).
Test setup	➤ Connect the spectrum analyzer to the RF output of the SMIQ.
Measurement	<ul style="list-style-type: none">➤ SMIQ settings<ul style="list-style-type: none">- Level 7 dBm- Test frequency 1.472 GHz- Switch on noise- Distortion characteristic TWTA.- Digital modulation standard WORLDSPACE- Filter mode LOW_EVM- Data source DATA_LIST,- Edit data list '0011"➤ Analyzer setting<ul style="list-style-type: none">- Center frequency = test frequency, span 20 MHz,- Reference level = 10 dBm- Scale 10 dB/div.➤ Measure spectral-line level at test frequency + 920 kHz.➤ Then measure spectral lines at test frequency, test frequency -920 kHz/+2760 kHz/+4600 kHz/+6440 kHz/+8280 kHz, and calculate level difference to first level measurement.

4.1.6 Noise Frequency Response

Test equipment	Spectrum analyzer (Operating Manual SMIQ, Table 5-1, item 2).
Test setup	<ul style="list-style-type: none">➤ Connect the spectrum analyzer to the RF output of the SMIQ.➤ Terminate I and Q inputs with 50 Ω.
Measurement	<ul style="list-style-type: none">➤ SMIQ settings<ul style="list-style-type: none">- Test level -10 dBm.- Test frequency 1.472 GHz- Switch on noise generator.- Carrier noise ratio 4 dB- System bandwidth 1.84 MHz- Switch on vector modulation.➤ Analyzer setting<ul style="list-style-type: none">- Center frequency = test frequency, span 5 MHz,- Reference level = -25 dBm- Scale 1 dB/div.- RBW 100 kHz, VBW 5 Hz➤ Measure frequency response of noise signal between test frequency - 1290 kHz and test frequency + 1290 kHz.➤ SMIQ settings<ul style="list-style-type: none">- noise generator/system bandwidth 10 MHz➤ Analyzer setting<ul style="list-style-type: none">- Center frequency = test frequency, span 20 MHz,- RBW 500 kHz, VBW 5 Hz➤ Measure frequency response of noise signal between test frequency - 5000 kHz and test frequency + 5000 kHz.

4.1.7 Carrier/Noise Ratio

Test equipment	Broadband demodulator for digital modulation (Operating Manual SMIQ, Table 5-1, item 27).
Test setup	➤ Connect the broadband demodulator to the RF output of the SMIQ.
Test method	<p>For determining C/N (carrier/noise ratio), the noise power N is measured by integrating power density at 1.84 MHz, and useful-signal power C by integrating power density at 2.576 MHz.</p> <p>From C [dBm] and N [dBm], $C/N[\text{dB}] = C[\text{dBm}] - N[\text{dBm}]$ can be derived.</p> <p>As the useful signal (C) and the noise signal (N) are superimposed, the menu UTILITIES – DIAG – CN MEAS has been created, which allows the useful or noise signal to be switched off.</p>
Measurement	<ul style="list-style-type: none">➤ SMIQ settings<ul style="list-style-type: none">- Level -20 dBm / -10 dBm / 0 dBm- Test frequencies 1.472 GHz- Digital modulation standard WORLDSPACE- Filter mode LOW_EVM- Data source PRBS,- Switch on noise- Distortion characteristic TEST.- Carrier/noise ratio -5 dB / 4 dB / 20 dB- System bandwidth 1.84 MHz- UTILITIES – DIAG – CN MEAS - CARRIER➤ Demodulator settings<ul style="list-style-type: none">- Reference level = 10 dBm- Test bandwidth = 3 MHz- Integration of useful power C[dBm] at 2.576 MHz- 500 averaging➤ SMIQ settings<ul style="list-style-type: none">- UTILITIES – DIAG – CN MEAS - NOISE➤ Integration of noise power N [dBm] at above 1.84 MHz, 500 averaging.➤ Repeat all measurements with distortion characteristic TWTA.

4.1.8 Error Vector

Test equipment	Broadband demodulator for digital modulation (Operating Manual SMIQ, Table 5-1, item 27).
Measurement	<ul style="list-style-type: none">➤ SMIQ settings<ul style="list-style-type: none">- Level 7 dBm- Test frequencies 1.472 GHz and according to Table 5-2 (SMIQ).- Digital modulation standard WORLDSPACE- Filter mode LOW_EVM- Data source PRBS,- Switch on noise/distortion characteristic TEST. ➤ Demodulator settings<ul style="list-style-type: none">- QPSK modulation- Symbol rate 4 Msym/s- Filter SQR COS/0.4- Reference level = 10 dBm- Test bandwidth = double symbol rate- Evaluation over 150 symbols- 10 averaging ➤ Measure the rms error vector magnitude for the given symbol rates on demodulator.

4.2 Performance Test Report

Characteristic	Min.	Actual	Max.	Unit
Noise generation and distortion simulation				
Residual carrier			-50	dBc
Carrier and image-frequency suppression, and intermodulation 1.472 GHz 1.472 GHz -100 kHz 1.472 GHz +200 kHz 1.472 GHz +300 kHz			-40 -40 -55 -55	dBc dBc dBc dBc
Frequency response up to 5 MHz (I-FADED, Q-FADED)			0.7	dB
RF freq. response up to 1.29 MHz RF freq. response up to 5 MHz			0.4 0.8	dB dB
Distortion simulator Test frequency Test frequency - 920 kHz Test frequency +-2760 kHz Test frequency +-4600 kHz Test frequency +-6440 kHz Test frequency +-8280 kHz	-1 -13 -24 -31 -37		-30 +1 -7 -18 -25 -31	dBc dBc dBc dBc dBc dBc
Noise frequency response test freq. -1290 kHz to +1290 kHz test freq. -5000 kHz to +5000 kHz			0.4 0.8	dB dB
C-measurement, Distortion OFF/TWTA Test level -20 dBm -10 dBm 0 dBm	-21 -11 -1		-19 -9 1	dBm dBm dBm
C/N measurement, Distortion OFF/TWTA C/N = -5 dB C/N = 4 dB C/N = 20 dB	-5.2 3.8 19.8		-4.8 4.2 20.2	dB dB dB
Error vector			2	%