



Filters & Combiners

DATA SHEET

700 MHz RX Bandpass Test Filter

BPT-0703748-0-S3



- 1W filter with an RX band pass of 45 MHz in the 700 MHz RX Band
- Excellent rejection of ≥ 20 dB within 10 MHz of the pass band
- High reliability of >500K Hours MTBF

Overview

Communication Components, Inc. Dual bandpass filter allows a 45 MHz pass band in the RX portion of the 700 MHz Band, while rejecting signals within 10 MHz of the passband.

The CCI Bandpass filter provides optimal performance for the passband with low insertion loss, low Intermodulation, and high power handling. Excellent return loss delivers the best match to the antennas and base station, saving precious transmit power. The Bandpass filter is the ideal solution for providing additional rejection at the band edge.

Technical Description:

The bandpass filter consists of multiple cavity resonators to achieve 20 dB of rejection within 10 MHz of the pass band. Extensive temperature compensation is employed to insure frequency stability over the specified temperature range.



Filters & Combiners

SPECIFICATIONS

700 MHz RX Bandpass Test Filter

BPT-0703748-0-S3

Electrical

RF Parameters	Ports	Frequency(MHz)	Specification
Return Loss	Input TX/RX	703-748	15 dB minimum
	Output TX/RX	703-748	15 dB minimum
Insertion Loss	Input to Output	703-748	1.2 dB maximum
Rejection	Input to Output	693	20 dB minimum
		758	20 dB minimum

General Characteristics	
Impedance	50 ohms
Continuous Average Power	1 W max.
Peak Power	10 W Max.

Environmental

Operating Temperature	-20 °C to +70 °C
Ingress Protection	IP20 (Indoor)
MTBF	>500,000 hours

Mechanical

Model	Single
Connectors	2 x N-female
Housing Dimensions (HxWxD)	80.0 x 54.0 x 50.0 mm (3.15 x 2.13 x 1.97 in.)
Dimensions w/Connectors (HxWxD)	118.0 x 54.0 x 50.6 mm (4.65 x 2.13 x 1.99 in.)
Weight	0.5 kg (1.1 lbs)
Mounting	Optional mounting bracket available



Filters & Combiners

SPECIFICATIONS

700 MHz RX Bandpass Test Filter

BPT-0703748-0-S3

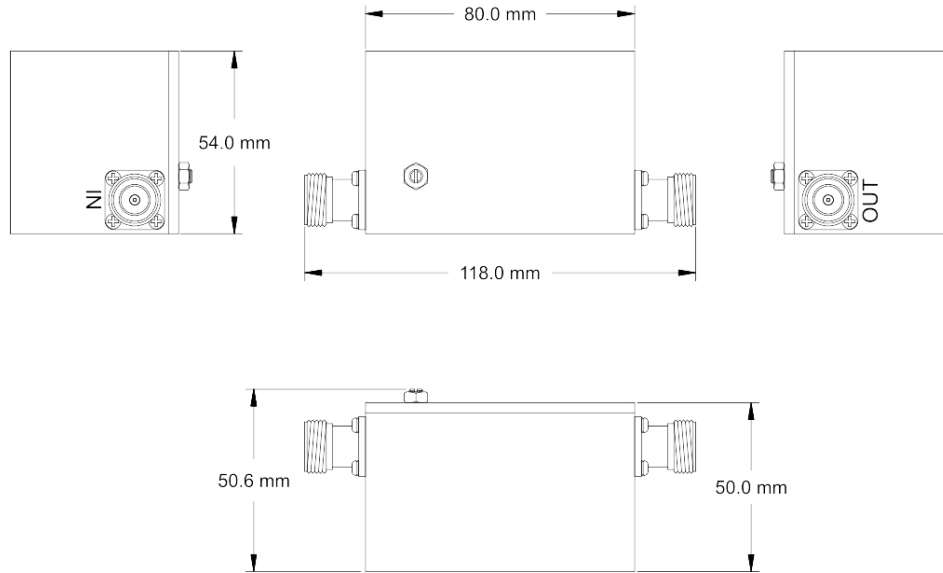

Indoor Passband Filter Outline Drawing BPT-0703748-0-S3

Filter Characteristics

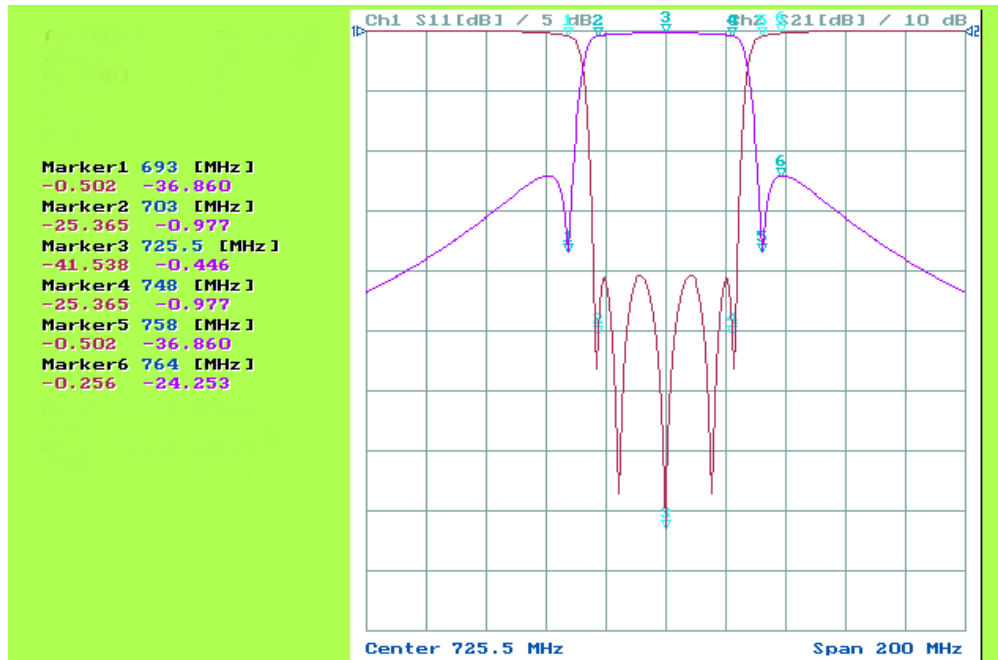

BPT-0703748-0-S3 RX Filter Characteristics



Filters & Combiners

STANDARDS & CERTIFICATIONS

700 MHz RX Bandpass Test Filter

BPT-0703748-0-S3

Parts & Accessories

BPT-0703748-0-S3 Single 45 MHz Outdoor Bandpass filter pass band of 703-748 MHz with N-female connectors and No DC/AISG Pass-thru

Standards & Compliance

Safety	EN 60950-1, UL 60950-1
Emission	EN 55022
Immunity	EN 55024
Environmental	IEC 60068-2-1, IEC 60068-2-2, IEC 60068-2-5, IEC 60068-2-6, IEC-60068-2-11, IEC 60068-2-14, IEC 60068-2-18, IEC 60068-2-27, IEC 60068-2-29, IEC 60068-02-30, IEC 60068-2-52, IEC 60068-2-64, IEC61000-4-5, GR-63-CORE 4.3.1, EN 60529 IP67, IP68

Certifications

Federal Communication Commission (FCC) Part 15 Class B, CE, CSA US, ISO 9001:2008

