

Design and Use of a DTV Monitoring System consisting of DVQ(M), DVMD/DVRM and DVRG

Application Note

When monitoring transmission systems it is often necessary to control the monitoring equipment and to check the measurement results from a remote station. The user may also be interested to know which transmission data cause an error or violate a standard.

Rohde & Schwarz offers several instruments that meet all these requirements in the field of digital TV transmission.

This application note gives an overview of the design and use of a DTV monitoring system made up of the above-mentioned instruments and meeting the requirements.



Contents

1. Introduction	2
2. Multichannel Digital Video Quality Analyzer DVQM.....	3
2.1. Operation and Remote Control	3
2.2. Setting the IP Address.....	4
3. DTV Monitoring System.....	4
4. Software.....	5
4.1. DTV NetView	6
4.2. Quality Monitor.....	7
4.3. Stream Explorer and Realtime Monitor	8
4.4. IP-SNMP Config	9
4.5. DVRG Commander	9
5. Network Configuration	10
5.1. Hub	11
5.2. Terminal Server.....	11
5.3. Network Parameters.....	12
6. Troubleshooting	13
6.1. Network Problems	13
6.2. Trigger Function	13
6.3. DTV NetView	14
7. List of Mentioned Hardware and Software.....	14
7.1. Software	14
7.2. Hardware	14

1. Introduction

When monitoring transmission systems it is often necessary to control the monitoring equipment and to check the measurement results from a remote station. The user may also be interested to know which transmission data cause an error or violate a standard.

Rohde & Schwarz offers several instruments that meet all these requirements in the field of digital TV transmission.

- DVRM or DVMD are used for transport stream analysis,
- DVQ or DVQM (multichannel version of DVQ) are used for monitoring individual programs of the transport stream for picture quality and failures,
- DTV Recorder Generator DVRG is used for triggered recording of a transport stream.

This application note gives an overview of the design and use of a DTV monitoring system made up of the above-mentioned instruments and meeting the described requirements.

First a short overview is given of configuration capabilities and applications of Multichannel Digital Video Quality Analyzer DVQM. This is followed by a system description including software. Particular attention is given to network-specific characteristics and parameters.

It is assumed that the reader is familiar with the applications of the Multichannel Digital Video Quality Analyzer DVQM and the transport stream analyzers DVMD/DVRM. A detailed description of these instruments is given in the respective data sheets and manuals.

Unless specified otherwise, all programs mentioned in this document are stored on the 'Quality Explorer Suite' CD. The CD is supplied with the DVQ and DVQM as well as with option DVQ-B1.

2. Multichannel Digital Video Quality Analyzer DVQM

The DVQM has been designed for monitoring various programs of one or several transport streams. Upon delivery it is configured to customer requirements. The Configuration Sheet should be used to specify requirements. On this sheet, the occupation of the individual slots of the DVQM (analyzer board, descrambling board or free slot) and the configuration of the individual analyzer boards (installation of video quality analysis option and preset IP address) can be specified. Fig. 1 shows possible configurations.

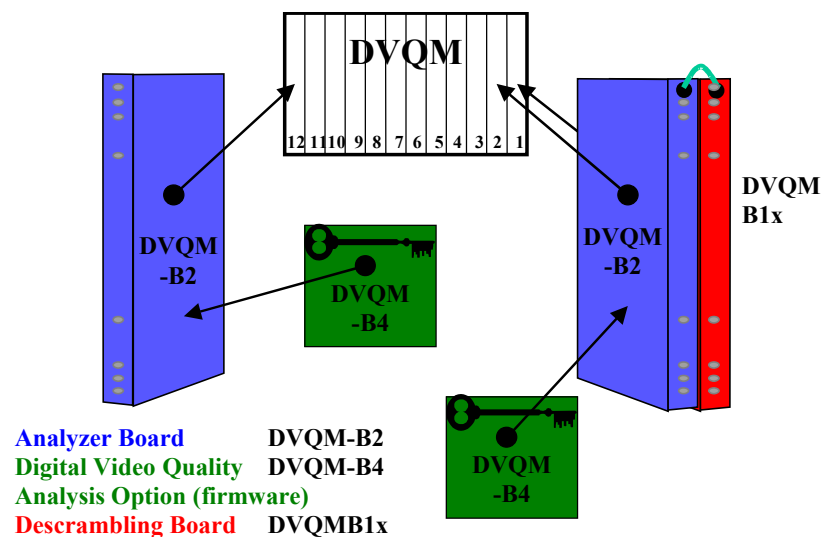

Fig. 1 Configuration of DVQM

Since the DVQM has been designed especially for monitoring, it is equipped with very few LEDs and control elements (ON/OFF key only). Each analyzer board operates independently. Descrambling boards, if any, are assigned to and controlled by an analyzer board.

But for a few exceptions, the specifications of the DVQ also apply to the analyzer board. One exception is that the analyzer board has no synchronous parallel interface SPI and neither keys nor a display.

2.1. Operation and Remote Control

Interaction between the individual analyzer boards of the DVQM is controlled by an external PC connected to the analyzer boards via Ethernet. Each analyzer board is individually addressed via the network. This concerns the configuration of the board as well as the reading of measurement results or detected faults. Since descrambling boards are controlled via the associated analyzer boards, they have no network interface of their own.

Rohde & Schwarz offers comprehensive software for convenient operation of the DVQM. A detailed software description is given in Chapter 4. Thanks to the simple network management protocol (SNMP) of the individual analyzer boards, the DVQM can be directly integrated in a customized monitoring system by means of a separate software. The analyzer boards use the same management information base (MIB) as the DVQ. The MIB file is stored on the Quality Explorer Suite CD (same directory as the DVQ firmware).

The DVQM can also be remote-controlled by means of SCPI commands. All available SCPI commands are described in the DVQ/DVQM manual. The same remote-control commands are used for the DVQ and for an analyzer board.

2.2. Setting the IP Address

To be able to use the Ethernet interface of an analyzer board, the IP address must be known. The address is factory-set to the value specified in the Configuration Sheet.

If the IP address is not known or if it has to be changed, this can be done via the RS-232 interface on each analyzer board. The Ethernet interface can be programmed with the aid of the IP-SNMP Config program. The use of this program is explained in the Readme.pdf file which is stored in the same directory as the program. For further information on this program refer to section 4.4.

3. DTV Monitoring System

Video quality analysis of the individual programs by the DVQM can be enhanced by adding one or more DVRMs or DVMDs for protocol analysis of the transport stream (each DVRM/DVMD can monitor one transport stream). A DVRG can also be integrated in the system for recording a defined part of the transport stream before and after an event when a fault has occurred. Recording of the transport stream section can be initialized by any instrument with a relay output. In this case the trigger input of the DVRG is connected in parallel to the relay outputs of all analyzers.

This allows subsequent and in-depth analysis of the transport stream before and after the trigger event. The individual transport stream sections are stored in separate, automatically numbered files in the DVRG. With the aid of date and time of the stored file and of the report entries of the individual units, the cause of each recorded event can be subsequently reconstructed. DVQ, DVRM and the analyzer boards of the DVQM are equipped with relay outputs as standard. In the DVMD they can be retrofitted via option DVMD-B5.

The interfaces with the relay outputs of the individual instruments and the trigger input of the DVRG are described in the instrument manuals.

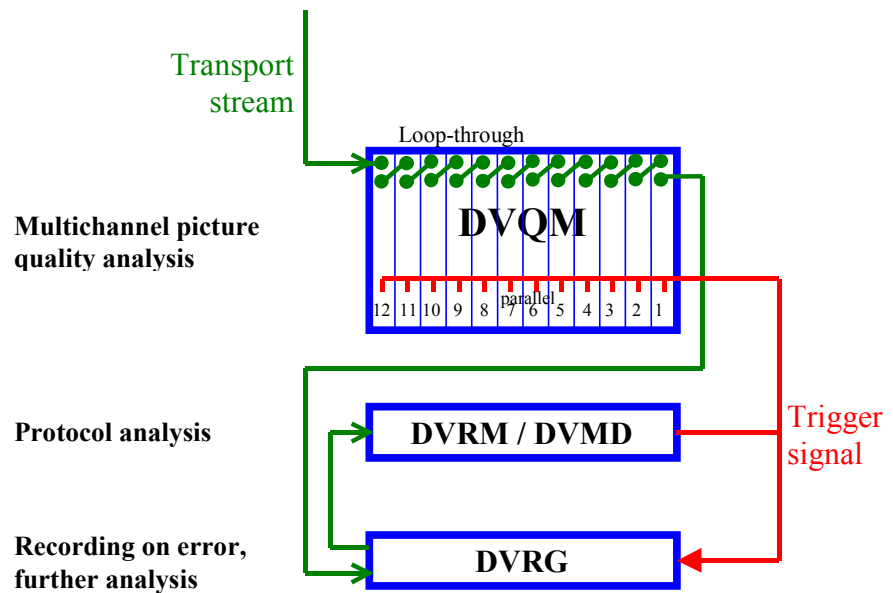

Fig. 2 Transport stream input and trigger signalling

Fig. 2 shows a basic system setup for monitoring a transport stream. The transport stream to be monitored is applied to all analyzers, i.e. to all DVQM analyzer boards, a DVRM/DVMD and a DVRG. The setup can be easily enhanced for monitoring several transport streams. A DVRM/DVMD and a DVRG are required for each transport stream. The number of analyzer boards corresponds to the number of transmitted programs. If the scan mode is used, the number of analyzer boards can be reduced but in this case not all programs can be monitored in parallel. The analyzer boards of the DVQM can also be supplemented by DVQs which are then used like the analyzer boards.

To simplify operation, all instruments should be networked. The software from Rohde & Schwarz offered for this purpose is described in the next Chapter. Chapter 5 describes networking and explains the network parameters to be configured.

4. Software

Several programs developed by Rohde & Schwarz for the described instruments complete the system functions and enable convenient interaction between user and equipment. The programs serve for instrument configuration, display and storage of measurement results and for in-depth analysis. Fig. 3 shows the assignment of programs and instruments.

- The Quality Monitor can be used with a DVQ or an analyzer board of the DVQM.
- The Stream Explorer and the Realtime Monitor are used with DVRM/DVMD.
- The DTV NetView software can be used with individual DVQs and analyzer boards but also with DVRMs and DVMDs. In addition, it can be employed for starting the Quality Monitor, Stream Explorer or Realtime Monitor programs for selected instruments.

DTV Monitoring System

- IP-SNMP Config serves for configuring individual analyzer boards.
- The DVRG Commander is used for remote-control of the DVRG.

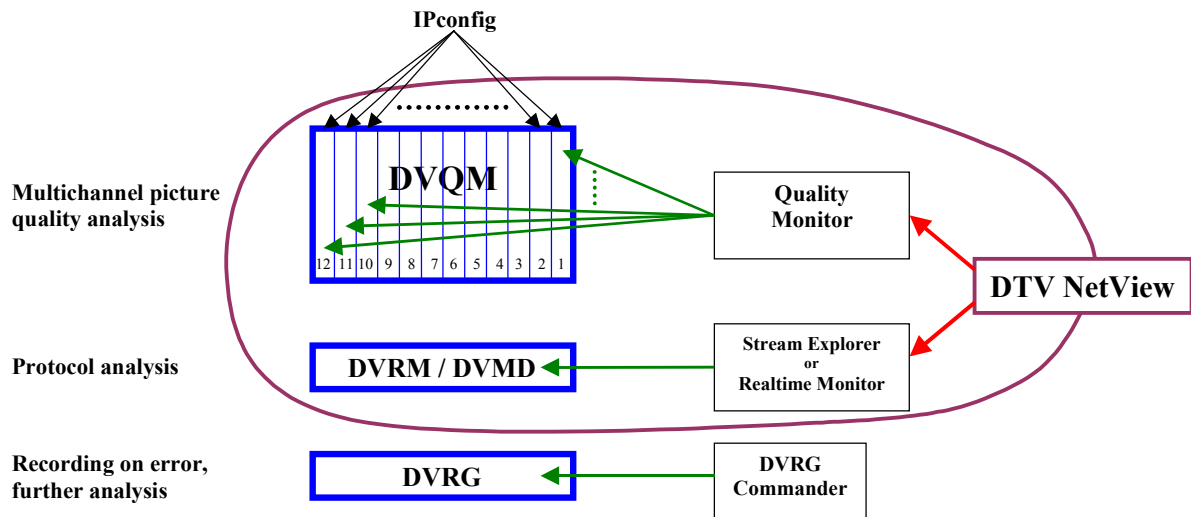

Fig. 3 Programs and measuring instruments

4.1. DTV NetView

An individually configured monitoring system comprising DVQ, DVQM, DVRM and DVMD units can be managed by DTV NetView. DTV NetView permits configuration of individual units and display of measurement results (see Fig. 4). Furthermore, it lists the report entries of the individual instruments which can be displayed in the right half of the program menu instead of the Statistics window. Report entries can be stored automatically or manually.

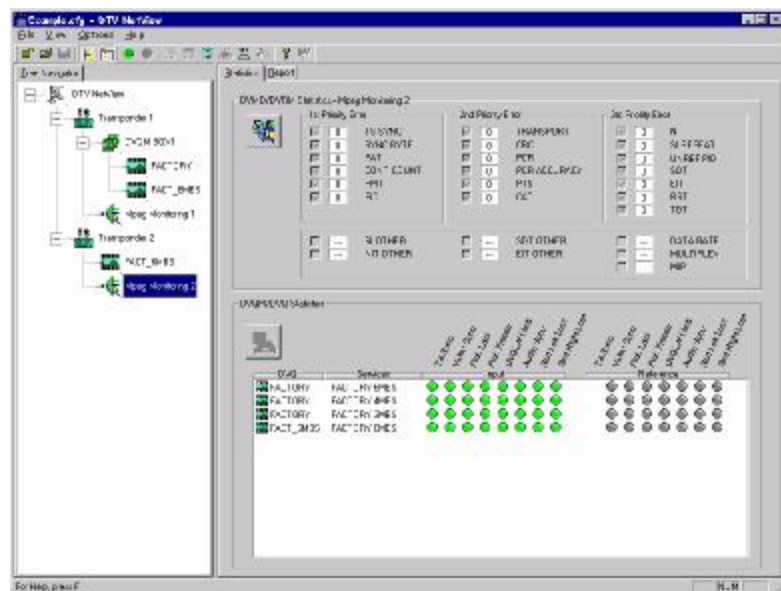

Fig. 4 DTV NetView window

DTV Monitoring System

DTV NetView is configured by means of a configuration file which contains a list of the measuring instruments in the system and all information required for communication. Communication is via Ethernet. The TCP/IP address and the port must be configured. A name has to be defined for each measuring instrument. This name is then used in the DTV NetView window for instrument identification. The instruments can be organized in groups for a better overview.

To configure a DVQ or an analyzer board, the name of the respective unit is marked in the program window and then the DVQ/DVQM settings dialog is called. With the aid of this dialog, the programs to be monitored and the limits for error definition can be set, for instance.

DVRMs or DVMDs are configured in the same way. The name of the instrument is marked and the respective configuration window called.

For further information on DTV NetView refer to the respective manual and the online help. The manual is stored in the same directory as the program.

4.2. Quality Monitor

The Quality Monitor can be used for read-out and display of measurement results of a DVQ or analyzer board. The results include the weighted quality parameter, the data rate of the video elementary stream, the temporal activity and the spatial activity. These parameters are displayed by the Quality Monitor in the form of traces versus time, see Fig. 5. Data can be stored in the CSV format. Data in this format can also be processed by other programs, e.g. Excel. Data can be stored automatically by the Quality Monitor.

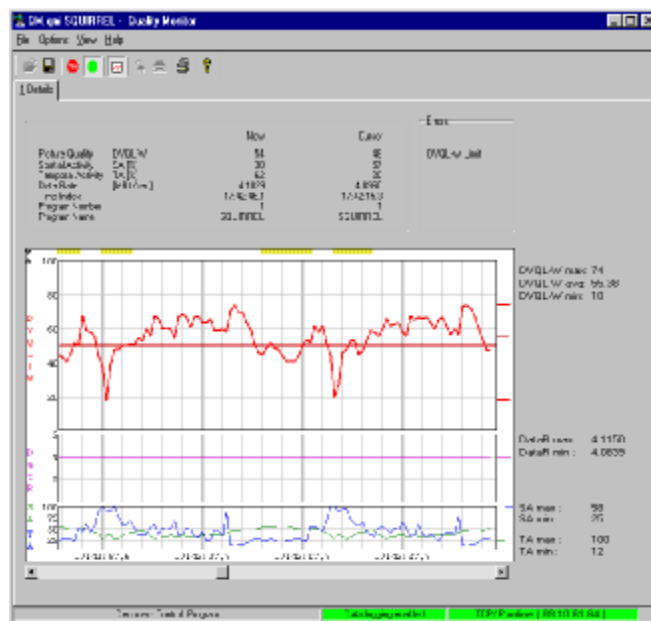

Fig. 5 Quality Monitor window

PCs and measurement instrument are linked via Ethernet or RS-232. The program can be started directly by the user for a defined measuring instrument, or called with the aid of NetView for an instrument marked in DTV NetView.

DTV Monitoring System

The Quality Monitor can be started on a PC several times for different measuring instruments.

In addition to display and storage of measurement results, the DVQ settings dialog can be called with the Quality Monitor or with DTV NetView. With this dialog, an analyzer board or a DVQ can be configured, see also section 4.1. For further information refer to the online help or the respective manual.

4.3. Stream Explorer and Realtime Monitor

Stream Explorer is a software option (DVMD-B1) for DVMD or DVRM and used for in-depth analysis of a transport stream. It is not stored on the Quality Explorer Suite CD.

Same as the Quality Monitor, the Stream Explorer can be directly started by the user for a defined instrument. It can also be started with DTV NetView.

DVRM/DVMD and the PC are linked via RS-232, or via Ethernet if a terminal server is used, see section 5.2.

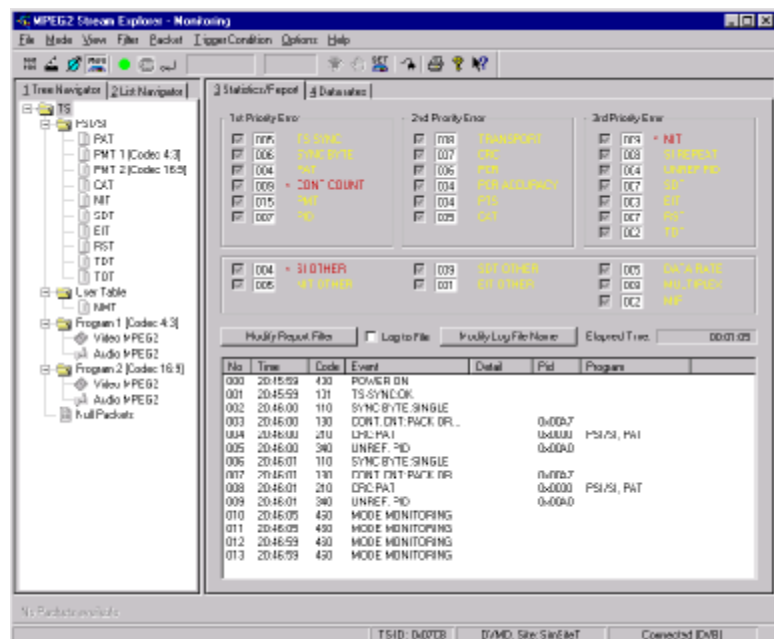

Fig. 6 Stream Explorer window

The Realtime Monitor, another software from Rohde & Schwarz, can be used in the same way as the Stream Explorer. The Realtime Monitor also complements the information on transport stream analysis obtained from DTV NetView, however to a limited extent compared to the Stream Explorer. The information added to that of DTV NetView includes display of the analyzed transport stream elements and of the data rates used.

The Realtime Monitor is supplied with DVRM/DVMD. It is not stored on the Quality Explorer Suite CD.

For configuration of a DVRM/DVMD, the same dialog can be called via the Stream Explorer, the Realtime Monitor and DTV NetView.

4.4. IP-SNMP Config

The IP-SNMP Config program is used to configure the parameters of the Ethernet interface and the traps of the SNMP protocol. The program is only required for these settings. All other parameters (limit values, programs monitored, alarm lines, etc) are configured with the Quality Monitor or DTV NetView programs.

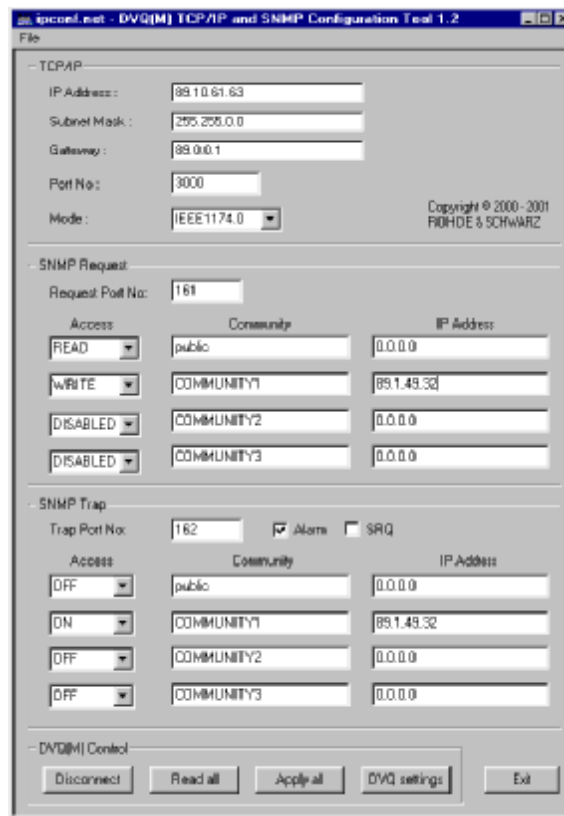

Fig. 7 IP-SNMP Config window

Each analyzer board of the DVQM is separately configured. When IP-SNMP Config is used, communication with the analyzer board is exclusively via RS-232. The use of this program is explained in the Readme.pdf file stored in the same directory as the program.

4.5. DVRG Commander

The DVRG Commander program serves for remote-control of DVRG. With this program, the DVRG can be easily controlled from any PC in the network. Communication is carried out via Ethernet. The DVRG Commander is part of the DVRG firmware as of version 1.21. Fig. 8 shows the DVRG Commander window.



Fig. 8 DVRG Commander window

5. Network Configuration

A precondition for error-free operation of the whole system is a correctly configured network. This chapter gives a short overview of the mentioned network components and explains the function of the individual network parameters of the measuring instruments. A comprehensive introduction to network technology cannot be given in this Application Note. Please refer to the Application Notes "**Hints for using the Ethernet Interface of the DVQ**" (7BM04_0E) and "**Remote Usage of Stream Explorer via Ethernet Network**" (7BM01_0E) for further information. They are stored on the Quality Explorer Suite CD.

The monitoring system used as an example further up is also used here. Fig. 9 shows mentioned instruments and required network links.

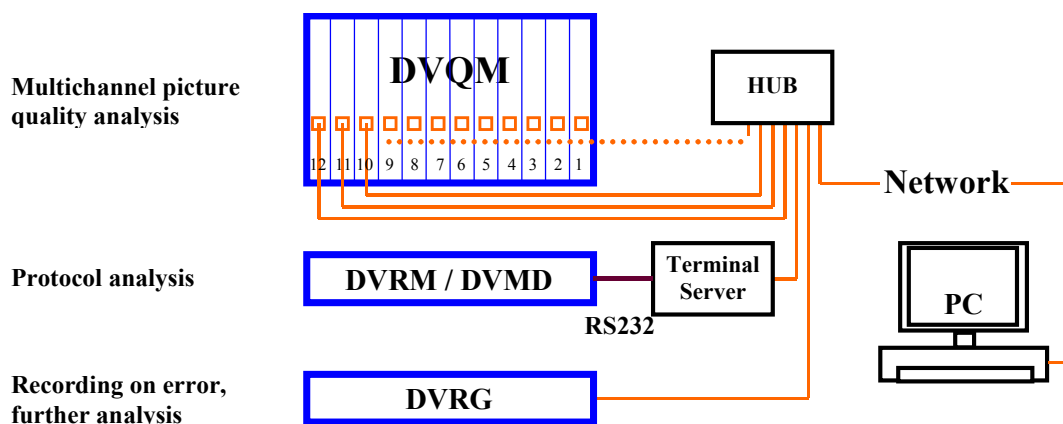

Fig. 9 Network links

The basis for communication between PC and measuring instruments is an Ethernet network with TCP/IP protocol. All measuring instruments and the PC are directly or indirectly connected to this network. Since the instruments for protocol analysis - DVMD/DVRM - have no Ethernet interface, they cannot be directly connected. They are linked to the network

via a terminal server (also called COM port server). The use of the server is described in section 5.2. The term terminal server will be used in the following description.

Please get in touch with R&S for information on upcoming options for direct connection of DVRM / DVMD to an Ethernet.

If several instruments must be connected to one Ethernet interface, a hub should be used as shown in the example. The next section contains further information on the use of such an instrument. The network parameters to be set are explained in section 5.3.

5.1. Hub

The function of a hub is to output the signals received at one connector via all other connectors. All connected instruments can communicate with each other, and together with the hub they form a separate subnet. The cable from the hub to the main network is connected like any other cables to the instruments. Only non-crossed cables are used, see also Application Note **"Hints for using the Ethernet Interface of DVQ"** (7BM04_0E). Hubs are available with a variable number of connectors and for networks of different transmission rates (10 / 100 Mbit/s; 10 / 100 BaseT). Normally they have their own power supply. DVQ and the analyzer boards support a rate of 10 Mbit/s. The DVRG is designed for 100 Mbit/s. Special settings on the hub are normally not required. In the example shown in Fig. 9, all the instruments are connected to the network via one hub so that only one network connector is required. Each analyzer board and the DVRG are directly connected to the hub. The DVRM/DVMD is connected to the hub via a terminal server.

5.2. Terminal Server

The terminal server (also called COM port server) enables communication via Ethernet with instruments that only have an RS-232 interface. Terminal servers with a variable number of RS-232 interfaces are available. They also have an Ethernet interface for connection to the network. An Ethernet interface and the used RS-232 interfaces must therefore be configured. The parameters for the RS-232 interface depend on the connected instrument and the application. When DVMD and DVRM are used together with DTV NetView, Stream Explorer or the Realtime Monitor, the following settings should be made for the RS-232 interfaces of terminal server and DVMD/DVRM:

- Baud rate: 115.2 Kbaud,
- Data bits: 8
- Stop bit: 1
- Parity: none
- Handshake: hardware, CTS/RTS

It must be taken into account that the terminal server supports the RawData transfer mode which is used because also binary data are to be transmitted. In the RawData transfer mode, 1:1 transmission is performed by the terminal server for data transmission.

The settings of the Ethernet interface largely correspond to those of a normal Ethernet interface. It should be borne in mind that, normally, one IP port number is assigned to one COM port of the terminal server. If the

DTV Monitoring System

terminal server has several COM ports, several IP port addresses are available. It is also possible to assign several IP port numbers to one COM port. The selected number also determines the employed transfer mode. Example:

IP port 6000: COM port 1, Telnet
IP port 6100: COM port 1, RawData
IP port 7000: COM port 2, Telnet
IP port 7100: COM port 2, RawData
etc.

For further information on parameters of the Ethernet interface refer to section 5.3. Fig. 10 shows the connection of a DVRM/DVMD to the Ethernet via a terminal server.

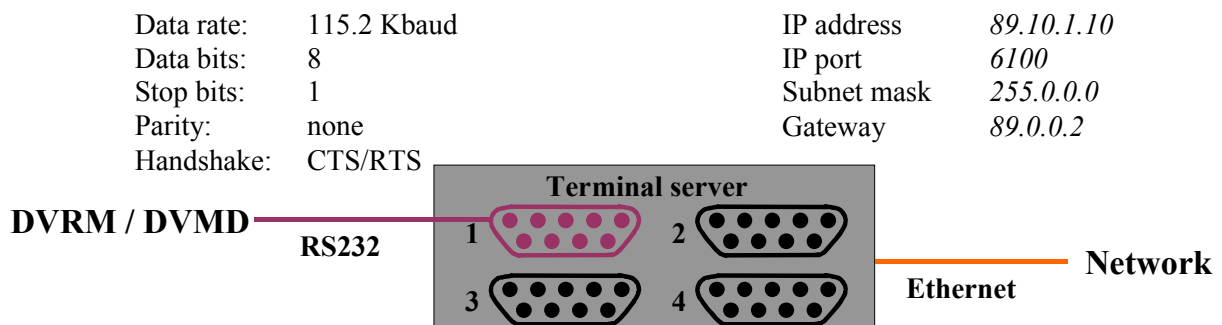

Fig. 10 Example of a terminal server configuration with DVRM/DVMD

5.3. Network Parameters

The main parameters of an Ethernet interface are IP address, port, subnet mask and gateway. These parameters must also be set on the individual analyzer boards, the DVRG and on the terminal server. Specifying an IP address and the port defines a single service for a specific unit. On a terminal server, this may be the RS-232 interface to be used for data transmission. This is why the two parameters must also be specified for any instruments connected via DTV NetView. If further programs (Quality Monitor or Stream Explorer / Realtime Monitor) are started from DTV NetView for individual instruments or boards, DTV NetView hands these parameters to the called program. If the program is started directly and not via DTV NetView, the user must inform the program on these parameters.

Since communication with a DVRM/DVMD must be performed via a terminal server, the IP address of the terminal server must be specified with the appropriate port number. Communication between the terminal server and the measuring instrument is independent and defined by the parameters of the RS-232 interface. Fig. 10 shows the configuration of an RS-232 interface for use of a DVRM/DVMD and the configuration of an Ethernet interface.

6. Troubleshooting

6.1. Network Problems

If problems occur in the communication with the instruments via the network, the addressability of the individual units should be checked with the aid of the PING command. See also Application Note "**Hints for using the Ethernet Interface of DVQ**" (7BM04_0E). If this check is not successful, the problem should be searched for at the network level. The following should be checked:

- Are all IP addresses correctly set?
- Has an address been assigned twice?
- Is the same gateway and the same network (subnet mask) set on all instruments (applies to LAN only)?
- Are the correct cables used and if so are they correctly connected?
- Are the hub and the terminal server switched on?

If the PING command is successful but initialization by DTV NetView is still not possible, try to directly address the instruments via the Quality Monitor and Stream Explorer / Realtime Monitor. This can first be done locally by establishing a direct connection between a PC with crossed cable and an analyzer board or a DVQ. The DVRM/DVMD can be directly connected to the PC by means of the serial cable leading to the terminal server. Care should be taken that the RS-232 interface of the PC is not used by another program.

In a further step, an attempt can be made to establish the connection via the hub or the terminal server. Only if this is successful should an attempt be made to establish a connection via the main network.

6.2. Trigger Function

Correct recording of the transport stream in case of an error depends on several parameters. If problems occur, check the following:

- Is the correct mode set on the DVRG and recording started?
- Is "??" contained in the file name for recording for automatic file numbering (as of DVRG firmware 2.00).
- Is monitoring of the desired parameters activated on the measuring instruments?
- Are alarm lines assigned to the individual faults?
- Has the trigger connection been correctly established?

To check whether the trigger input of the DVRG functions correctly, short-connect the two connector contacts of the trigger input used on the DVRG. For input contact assignment refer to the manual. Short-connecting the contacts should trigger a stop of recording delayed by the set value.

6.3. DTV NetView

To be able to start the Quality Monitor and Stream Explorer / Realtime Monitor from DTV NetView, the programs must be installed. Their installation is independent from that of DTV NetView. In addition, the directories containing the programs must be correctly set in DTV NetView.

7. List of Mentioned Hardware and Software

All instruments and programs are listed below with the version number required for the described applications.

7.1. Software

Realtime Monitor	2.20
Stream Explorer	2.20
Quality Monitor	1.30
DTV NetView	1.10
IP-SNMP Config	1.20
DVRG Commander	1.00

7.2. Hardware

DVQ	3.01
DVQM	see DVQ
DVRM	2.80
DVMD	2.80
DVRG	1.21

The version number of the hardware refers to the firmware.



ROHDE & SCHWARZ

ROHDE & SCHWARZ GmbH & Co. KG · Mühldorfstraße 15 · D-81671 München · P.O.B 80 14 69 · D-81614 München ·
Telephone +49 89 4129 -0 · Fax +49 89 4129 - 13777 · Internet: <http://www.rohde-schwarz.com>

This application note and the supplied programs may only be used subject to the conditions of use set forth in the download area of the Rohde & Schwarz website.