

APPLICATION NOTE

**Measurements on
S-VHS and RGB Signals
with
Video Measurement System R&S
VSA and Video Analyzer R&S UAF**

Products:

<i>Video Analyzer</i>	<i>R&S UAF</i>
<i>Video Measurement System</i>	<i>R&S VSA</i>

Contents

Measurements on S-VHS and RGB Signals with Video Measurement System R&S VSA and Video Analyzer R&S UAF

1 Introduction	3
2 Requirements	3
3 Measurements in S-VHS Format.....	4
3.1 First Measurement Method	4
3.2 Typical R&S VSA Configuration for Measuring S-VHS Signals	5
3.3 Second Measurement Method	6
3.4 Third Measurement Method	7
4 Measurements in RGB Format	8
4.1 Measuring the RGB Components	9
4.2 Time Offset between the Primary Colours RGB	10
4.3 Signal Interfaces on STBs and DVD Players	12
4.3.1 S-VHS Connector	12
4.3.2 SCART Connector	12
5 Conclusion	13
6 Configuration of VSA for running a Basic program	14
Appendix 1	
VSA_RGB.bas	
Measurement of video parameters of RGB Components using R&S VSA	15
Appendix 2	
RGBTime.bas	
Measurement of time offset using the R&S BASIC program	18
Additional Information	18

Measurements on RGB and S-VHS Signals with Video Measurement System R&S VSA and Video Analyzer R&S UAF

1 Introduction

The R&S VSA and R&S UAF video analyzers have been designed for measurements on CCV signals. Under certain conditions, they can also be used for measuring the primary colour components RGB and TV signals in the SVHS format. Since the signals available at the SCART connectors of set-top boxes (STBs) and DVD players often use these formats, these measurements are more important than ever in the production of STBs and also for DVD players in digital TV.



Fig. 1 Video Measurement System R&S VSA and Video Analyzer R&S UAF

2 Requirements

The signals demodulated and decoded by STBs or generated by DVD players have to meet certain requirements when the primary colour components RGB are to be measured. It is known that a monochrome signal is obtained when the red, green and blue colour components of identical amplitude are added. Conversely, it can be said that the red, green and blue colour components obtained from a monochrome signal have the same waveform. For the measurements, this means that test line CCIR18 - the multiburst which is only a monochrome signal - carries the multiburst on all three components after the RGB components have been separated. The same applies to the $\sin x/x$ and black-line signals, the white reference bar, the 2T pulse and the 5step staircase in test line CCIR17.

These are the main signals required for automatic measurements with the R&S VSA and R&S UAF video analyzers.

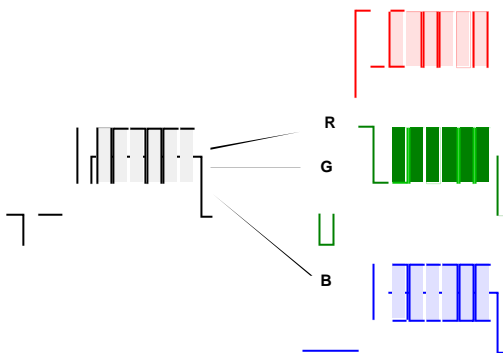
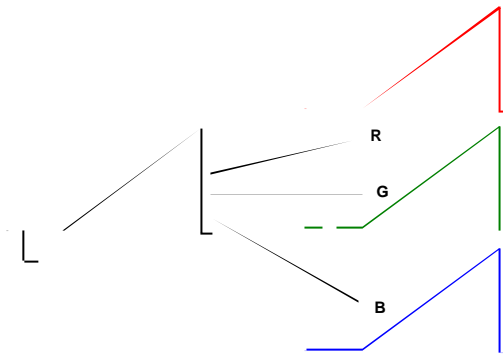
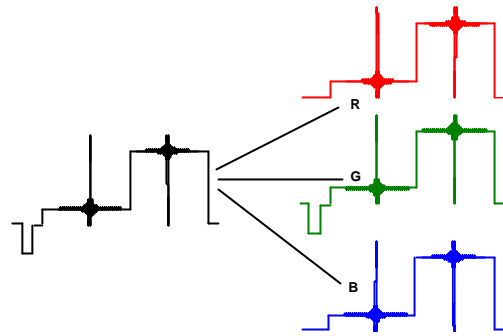

Fig. 2 $\sin x/x$, sawtooth and multiburst signals split into RGB components

In the RGB mode, the sync pulse is normally added only to the green channel so that the video analyzer can obtain the sync signal only from the green component. If an additional "composite sync" signal output is available on the instrument to be measured, this signal should ensure that the Gen Lock function can be used.

Appropriate test signals are needed to meet these requirements.

If the output signals of an STB are to be measured, the transport streams (TS) stored on the hard disk of the R&S DVG or R&S DVRG are used. All previously described signals are stored on the hard disks. The R&S SFQ modulates the MPEG2-coded transport streams according to DTV standards; the STB demodulates and decodes the RF signals and forwards the RGB signals to the SCART connector. If the STB is equipped with a common interface (CI), the desired TS can also be directly applied to the MPEG2 decoder of the STB. Possible error sources for demodulation in the front end of the STB can thus be avoided.



Fig. 3 MPEG2 Measurement Generators R&S DVG and R&S DVRG

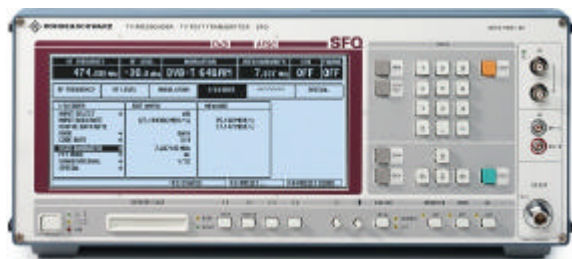

Fig. 4 TV Test Transmitter R&S SFQ

A professional set of test DVDs - as is now offered by Rohde & Schwarz - is required for measuring a DVD player. On these DVDs, too, all necessary signals are available in highest coding quality. Signals of top quality are essential for professional video measurements with the R&S UAF or R&S VSA.

3 Measurements in S-VHS Format

Requirements are different in the case of the Y/C system (Y = brightness or luminance and C = colour information or chrominance), which is also called S-VHS. The video analyzer input linked to the Y component ensures synchronization or, if an additional output is available for the composite sync signal, the composite sync signal should also in this case allow the Gen Lock function to be used.

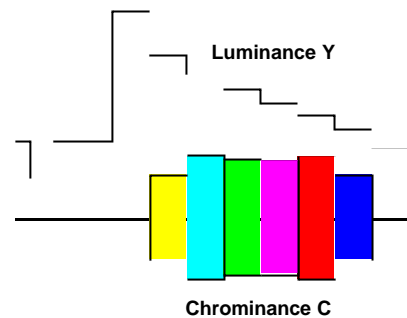

Fig. 5 S-VHS format of 100/0/75/0 colour bar

S-VHS signals can be measured in three ways.

3.1 First Measurement Method:

The Y and C components are passively added via the two lothrough filter inputs of the R&S VSA. The video analyzer therefore "sees" a CCVS at the selected input and measures all relevant parameters including the group delay in the 20T pulse of test line CCIR17. The parameters "differential gain" and "differential phase" produced when the Y and C signals are added do not exist in the chrominance channel per definition, since the colour information is transmitted at a constant DC level of 0 V, and these parameters are therefore not evaluated.

Another requirement to be met by the DVD player or the STB to be tested is sufficient return loss a_r at the two Y and C outputs. Required is an $a_r > 34$ dB in the range from DC to 5 MHz. Assuming the worst case, i.e. the impedance of the Y output is 2% (corresp. to 34 dB) higher than the nominal 75 Ω and that of the C output is 2% below 75 Ω , the following is obtained for the luminance signal:

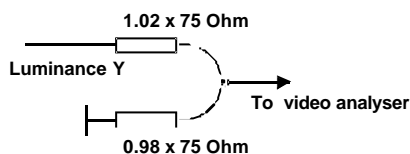

Fig. 6 Luminance corrupted by return loss or incorrect source impedance

The signal to the video analyzer is attenuated at the voltage divider with the ratio $V = 0.98 / (1.02 + 0.98) = 0.49$. Since the nominal value is 0.5, the luminance level is 2% too low.

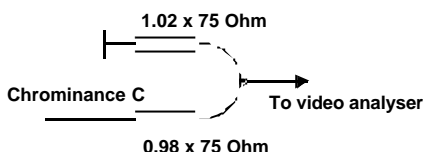

Fig. 7 Chrominance corrupted by return loss or incorrect source impedance

Correspondingly, the chrominance level is 2% too high.

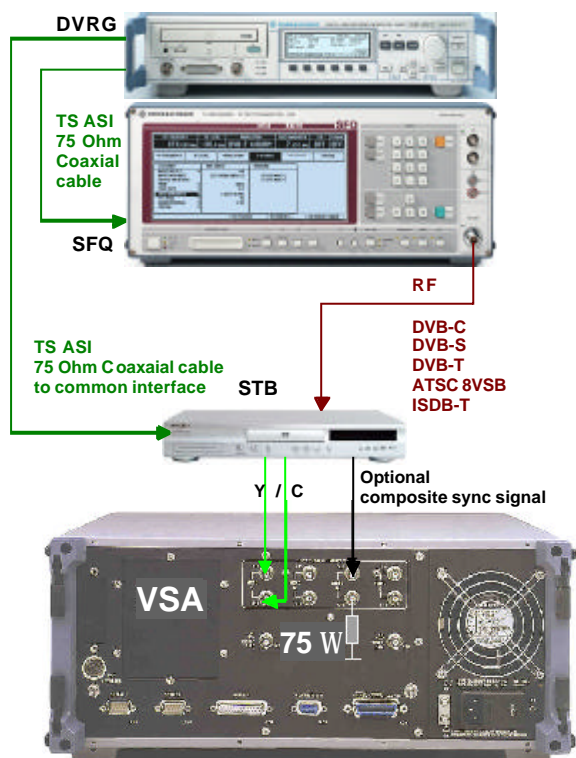

Fig. 8 Test setup for first measurement in the S-VHS format using R&S VSA

If these maximum tolerances can be accepted in production, addition is the simplest way to measure S-VHS signals.

In production, every second that extends the production process should be avoided, however. The measurement should therefore be as short as possible. For the Video Measurement System R&S VSA, this means that the main parameters of a group have to be chosen for the measurement, as any increase of parameters would extend the measurement time.

3.2 Typical R&S VSA Configuration for Measuring S-VHS Signals

Parameters to be measured with the R&S UAF or R&S VSA at the S-VHS output:

- CCIR17 Luminance bar amplitude
- Tilt
- Luminance nonlinearity
- Delay between luminance and chrominance at 20T pulse

- CCIR18 Amplitude frequency response of multiburst
- Black line S/N ratio

- Full field Burst amplitude
- Sync amplitude

When measurements are performed with the R&S VSA, amplitude and group-delay frequency response are of course measured with the optimal $\sin x/x$ signal.

Since the Video Measurement System R&S VSA measures time and frequency as well, the following parameters can be evaluated:

- Line period
- Line jitter
- Colour subcarrier frequency

While a fixed set of parameters is measured with the R&S UAF in the test lines used, single parameters of a parameter group can be selected in the R&S VSA. A list of parameters is therefore available for the CODEC43 test pattern which is stored in the R&S DVG, R&S DVRG and also on the R&S Test DVDs.

Parameter	Value	Unit	Status	Ref	Test Signal	Line
Lum Bar Ampl (abs)	706.6	mV	<input type="checkbox"/>	CCIR17		34
Sync Ampl (abs)	301.3	mV	<input type="checkbox"/>	CCIR17		34
Burst Ampl (abs)	296.8	mV	<input type="checkbox"/>	CCIR17		34
C/L Delay (pulse)	-14	ns	<input type="checkbox"/>	CCIR17		34
Tilt	0.2	%/bar	<input type="checkbox"/>	CCIR17		34
C/L Interm (pulse)	-1.2	%/bar	<input type="checkbox"/>	CCIR17		34
Lum NL	0.5	%	<input type="checkbox"/>	CCIR17		34
Sin x/x Amplitude pos	-0.92	dB/grat	<input type="checkbox"/>	Sin x/x		603
Sin x/x Amplitude neg	-0.84	dB/grat	<input type="checkbox"/>	Sin x/x		603
Sin x/x Group Delay pos	-6	ns/grat	<input type="checkbox"/>	Sin x/x		603
Sin x/x Group Delay neg	-1	ns/grat	<input type="checkbox"/>	Sin x/x		603
Lum Noise Lumw (bar)	75.5	dB/bar	<input type="checkbox"/>	Quiet		50
Line Period	64.000	µs	<input type="checkbox"/>	CCIR17		34
SC Frequency	4433615.76	Hz	<input type="checkbox"/>	Full Field		
Line Jitter pp	3	ns	<input type="checkbox"/>	Full Field		

Fig. 9 Configuration of R&S VSA for measuring S-VHS signals

3.3 Second Measurement Method:

The Video Analyzer R&S UAF is particularly suitable for automatic measurements of test lines in the S-VHS standard. Not only can the three loopthrough filter inputs A, B and C be selected in the INPUT SELECT menu but inputs A and B can also be added in the R&S UAF. The return loss is in this case no longer a function of the source impedance of the instruments to be tested, but is determined by the highly accurate 75 Ω terminations at the loopthrough filters.

The terminations supplied with the R&S UAF and the R&S VSA have an ohmic resistance of ±0.1% for a return loss of >50 dB up to 20 MHz. These values do not have a measurable influence on the signal quality.

INPUT - SELECT						
A	B	C	A&B	OFF	A	B
←	INPUT	→	←	REF	→	EXIT

Fig. 10 Input configuration of R&S UAF for measuring S-VHS signals

Internally, the video analyzer "sees" a CCVS signal and measures all parameters including the group delay of the 20T pulse in test line CCIR17. The parameters "differential gain" and "differential phase" produced when the Y and C signals are added do not exist in the chrominance channel per definition, as the colour information is transmitted at a constant DC level of 0 V. An evaluation is therefore not useful.

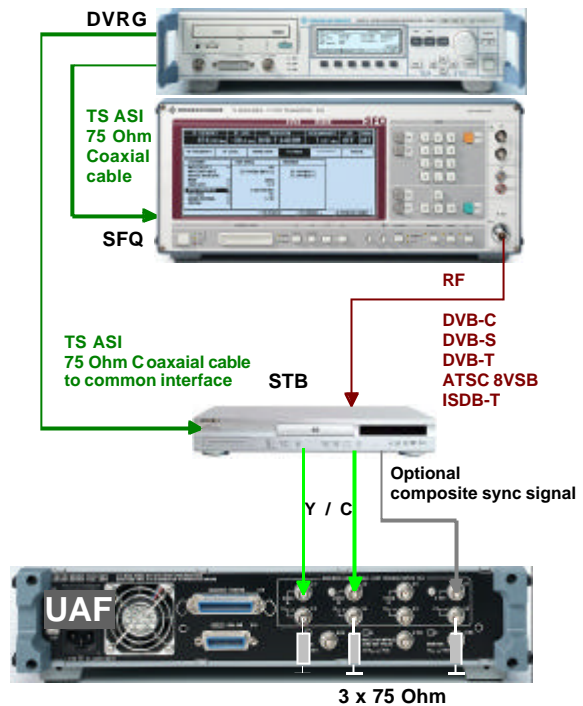

Fig. 10 Test setup for second measurement in S-VHS format with R&S UAF

The Video Analyzer R&S UAF measures the 28 major parameters in only 1 second. It is therefore ideal for use in production. The three measurement inputs and the additional sync input for the R&S UAF offer all advantages for S-VHS signal analysis. As can be seen on the R&S UAF rear panel, all inputs are in loopthrough technique. The difference to the R&S VSA is the number of parameters that can be measured and the additional functions of the R&S VSA such as scope function, vectorscope, controller function and a few other options.

Typical R&S UAF configuration for measuring S-VHS signals:

- CCIR17 Luminance bar amplitude
- Tilt
- Luminance nonlinearity
- Delay between luminance and chrominance at 20T pulse
- CCIR18 Amplitude frequency response of multiburst
- Black line S/N ratio
- Full field Burst amplitude

This configuration is set on the R&S UAF under TEST LINES after pressing the SETUP key.

SETUP / TESTLINES CCIR					
TESTSIG	LINE	TESTSIG	LINE	TESTSIG	LINE
CCIR 17	34	BLACK	50	RED BAR	0
CCIR 18	595	BURST	23	FT-DIST	0
CCIR 330	0	SYNC	3	V-DATA	0
CCIR331	0	ZERO RP	0		
STD		ABORT	MODE 1	EXIT	

Fig. 11. Configuration of R&S UAF for measuring S-VHS signals

Very narrow tolerances can be achieved in production with this measurement method. The accuracy only depends on the tolerances of terminations and of the video analyzers. Here the Video Analyzer R&S UAF performs measurements of highest precision.

3.4 Third Measurement Method:

The Y and C components are applied to two different video analyzer inputs. Both loopthrough inputs are terminated into 75 Ω. Each signal component is separately measured. Since the R&S VSA has four loopthrough filter inputs, two inputs are available for other tasks. The composite sync signal for analyzer synchronization can be applied to one of these inputs, the other input is used for automatic CCVS measurements.

Using a separate input to measure each signal component is an accurate method because the associated terminations have a very small tolerance of 0.1%. The artificial differential gain and differential phase parameters are not produced either. These measurements therefore allow for a more accurate representation of the S-VHS video signal.

Fig. 12 Test setup for measuring DVD players in S-VHS format with R&S VSA

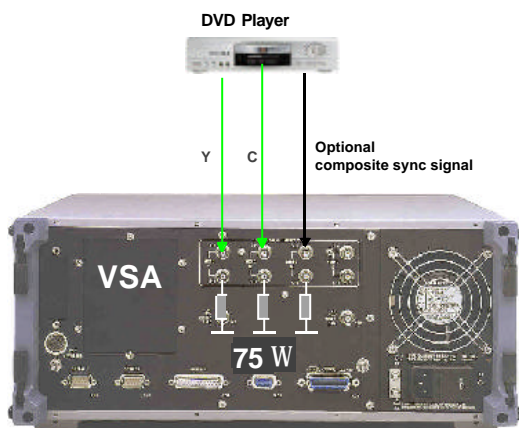

The delay between the luminance and chrominance signal cannot be measured however. The first measurement could be a solution in this case because this parameter is not affected by the return loss.

Since this method requires that the Y and C components be measured one after the other, the high precision of the S-VHS measurement is at the expense of the measurement time which is twice as long.

4 Measurements in RGB Format

The signals required for automatic measurements of the analog outputs of STBs in RGB format with R&S VSA or R&S UAF are provided by the test setup below. The CCVS SCART output can, of course, also be measured.

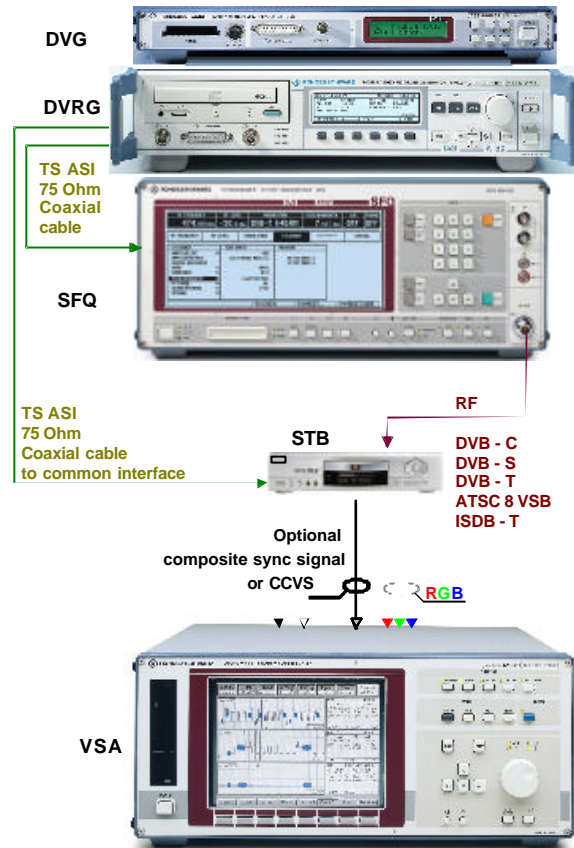

Fig. 13. Test setup for measuring STBs in RGB format with R&S VSA

A much simpler test setup can be used for measuring the outputs of DVD players because the test signals can in this case be taken from the R&S Test DVDs. As already mentioned, the test DVDs contain signals of highest coding quality so that digital and analog signal processing in the DVD player under test can be accurately measured.

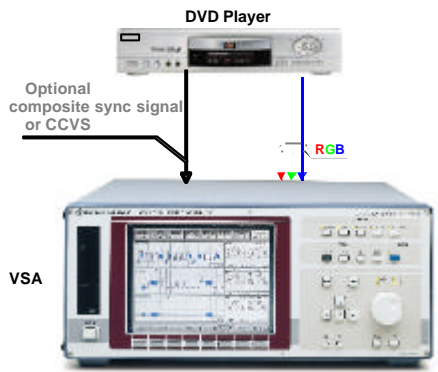

Fig. 14 Test setup for measuring DVD players in RGB format with R&S VSA

The DTV Recorder Generator R&S DVRG or the MPEG2 Measurement Generator R&S DVG are connected to the ASI (asynchronous serial interface) of the TV Test Transmitter R&S SFQ by means of a 75 Ω coaxial cable for transmitting the MPEG2 transport stream CODEC43. The more favourably priced TV Test Transmitter R&S SFL may be used instead of the R&S SFQ.



Fig. 15 Test Transmitter R&S SFL

The TV test transmitter modulates data in line with DVB, ATSC or ISDB standards. The STB for the selected standard demodulates, decodes and converts the data to the analog RGB and also to the CCVS format. The DVD player with the R&S Test DVDs supply the RGB test signals with the high accuracy required for measuring the signal quality of a DVD player. The analog signals are analyzed by the Video Measurement System R&S VSA. The Video Analyzer R&S UAF may be used instead. For this purpose connect the Red component to input A, the Green component to input B and the Blue component to input C of the video analyzer and don't forget to terminate the loop through input filters with 75 Ω .



Fig. 16 Video Analyzer R&S UAF

As can be seen from the next section, the amplitude frequency response and group-delay measurement with \sin/x and the parameter measurement on an STB or DVD player in the time domain cannot be performed with the Video Analyzer R&S UAF.

Parameters in the time domain are true design parameters and the \sin/x measurement is replaced by the multiburst measurement in the R&S UAF. Because of the high measurement speed and the possibility to measure all major parameters, the Video Analyzer R&S UAF is the ideal instrument for use in production.

4.1 Measuring the RGB Components

The CODEC43 transport stream contains all signal elements required for the measurement. All there is to do is to select the line number containing the required signal elements in the Video Measurement System R&S VSA or Video Analyzer R&S UAF and to start the measurement.

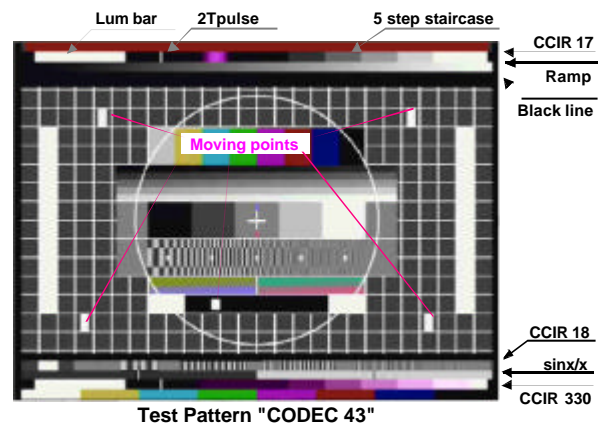

Fig. 17 CODEC43 test pattern with signal elements

Test signal	Line ranges		Test line to be selected in the R&S UAF/VSA
	1st field	2nd field	
<i>Red area</i>	24 - 30	336 - 343	27
CCIR 17	31 - 38	344 - 351	34
Sawtooth	39 - 46	352 - 359	42
Black line	47 - 58	360 - 371	50
Multiburst	277 - 286	592 - 599	595
Sin/x	287 - 294	600 - 607	603
CCIR 330	295 - 302	608 - 615	611
Colour bar	303 - 310	616 - 623	619

Test signals in italics are not required for RGB measurements.

Table 1 Lines of CODEC43 test pattern

All major parameters of the RGB components can be measured with the lines defined above.

- Luminance bar amplitude
measured at white bar in CCIR17
Measuring instrument: R&S UAF or R&S VSA
- Amplitude frequency response, 0.5 to 5.8 MHz
measured with CCIR18
Measuring instrument: R&S UAF or R&S VSA
- Amplitude frequency response, 0.2 to 6 MHz
measured with $\sin x/x$
Measuring instrument: R&S VSA
- Group delay, 0.2 to 6 MHz
measured with $\sin x/x$
Measuring instrument: R&S VSA
- 2T pulse parameters
measured at 2T pulse in CCIR17
Measuring instrument: R&S UAF or R&S VSA
- Luminance nonlinearity
measured with 5-step staircase in
CCIR17
Measuring instrument: R&S UAF or R&S VSA
- Tilt of white reference bar
measured at white bar in CCIR17
Measuring instrument: R&S UAF or R&S VSA
- Noise
measured in black line
Measuring instrument: R&S UAF or R&S VSA
- Sync pulse amplitude
measured in full-field signal of
green channel
Measuring instrument: R&S UAF or R&S VSA

The following parameters can only be measured with the R&S VSA at the green component which nominally contains the sync pulse.

- Sync pulse width
- Line period
- Field period
- Line jitter

These four parameters characterize the time behaviour of signal generation in the STB or the DVD player. Normally, they are to be considered design parameters. In production, they should nevertheless be monitored by means of sample measurements.

All video parameters concerning the colour subcarrier of the CCVS are irrelevant and should not be measured at the RGB components level. As with video parameter measurements in the S-VHS system, a fixed set of parameters is defined in the R&S UAF for the test lines used. In the R&S VSA, however, the desired parameters of a parameter group can be individually selected. A list of parameters is therefore available for RGB measurements when the CODEC43 test pattern is used.

Parameter	Value	Unit	Status	Ref	Test Signal	Line
Lum Bar Ampl (abs)	700.8	mV	<input type="checkbox"/>	CCIR17		34
Sync Ampl (abs)	298.4	mV	<input type="checkbox"/>	CCIR17		34
2T Pulse Amplitude	-0.2	%/bar	<input type="checkbox"/>	CCIR17		34
2T Pulse k-Factor	0.6	%/k	<input type="checkbox"/>	CCIR17		34
Tilt	0.3	%/bar	<input type="checkbox"/>	CCIR17		34
Lum NL	0.4	%	<input type="checkbox"/>	CCIR17		34
Sin x/x Amplitude pos	-0.86	dB/grat	<input type="checkbox"/>	Sin x/x		603
Sin x/x Amplitude neg	-0.95	dB/grat	<input type="checkbox"/>	Sin x/x		603
Sin x/x Group Delay pos	-12	ns/grat	<input type="checkbox"/>	Sin x/x		603
Sin x/x Group Delay neg	-16	ns/grat	<input type="checkbox"/>	Sin x/x		603
Lum Noise Lumw (bar)	79.6	dB/bar	<input type="checkbox"/>	Quiet		50
Hum (bar)	52.2	dB/bar	<input type="checkbox"/>	Full Field		
FP Full Field	40000.007	us	<input type="checkbox"/>	Full Field		
Line Period	64.000	us	<input type="checkbox"/>	CCIR17		34
Sync Duration	4.698	us	<input type="checkbox"/>	CCIR17		34
Line Jitter pp	2	ns	<input type="checkbox"/>	Full Field		

Fig. 18. R&S VSA configuration for measuring RGB signals

Since the terminations have narrow tolerances, each signal component is measured with the highest accuracy. The high measurement accuracy is however at the expense of the measurement time, which is three times as long because the R, G and B components have to be measured one after the other.

The RGB parameters can also be measured automatically via the controller function of the R&S VSA when the R&S BASIC program VSA-RGB1.bas is used. The program is available on the R&S homepage as an appendix to this Application Note. A printout of the program is attached as Appendix 1. Once initialized, the R&S VSA requires only slightly more than two seconds for measuring a primary colour component. The CODEC43 test pattern is again used as the test signal.

4.2. Time Offset between the Primary Colours RGB

If a time offset occurs between the three primary colour components, the edges of individual picture items are multicoloured. A time difference is caused, for instance, through analog filtering of the RGB data after D/A conversion when the three filters have different delays, or during digital signal processing when different processes are performed in the three signal paths.

It is therefore important that the delay differences are measured with high resolution.

In the Video Measurement System R&S VSA, the 2T pulse of test line CCIR17 is used to determine the time positions of the RGB components in the range ± 500 ns with an accuracy of <5 ns.

For this measurement, select the 3-window display in the Scope mode and choose the "Simultan" mode. Select display of line 34 using the Line softkey. This diagram contains test line CCIR17, and $26 \mu\text{s}$ after the rising edge of the sync pulse, the 2T pulse.

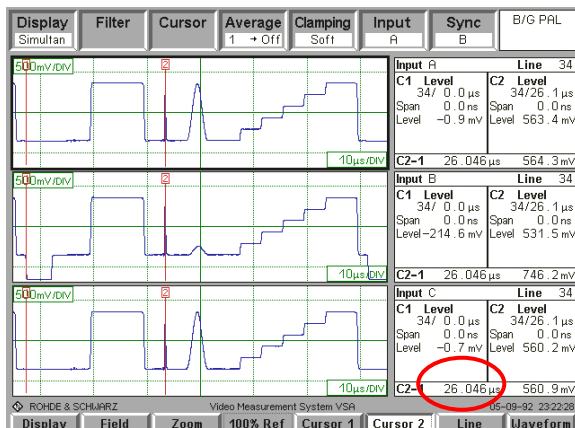

Fig. 19. CCIR17 in Scope mode:
red component (top)
green component with sync pulse (center)
blue component (bottom)

The measured 2T pulse follows $26.046 \mu\text{s}$ after the 50% value of the sync pulse leading edge. This time diagram cannot be displayed with the highest resolution and the nominal value of $26.0 \mu\text{s}$ is not displayed. The diagram does not show the time offset to the reference component carrying the sync pulse.

For an accurate offset measurement, set the horizontal axis to 100 ns/div using the MOVE/EXPAND function keys and the spinwheel

on the R&S VSA front panel. After correct adjustment, only the 2T pulses of test line CCIR17 in RGB format are shown in the three displays.

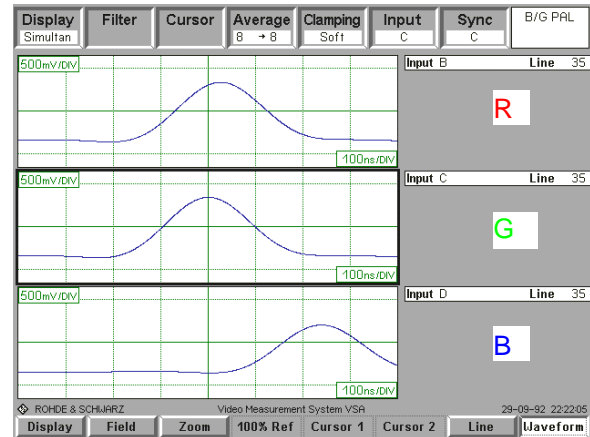

Fig. 20 Horizontally expanded simultan diagram of Fig. 19

Select Pulse for Cursor 1 (width about $2 \mu\text{s}$) and Level for Cursor 2 (width $0 \mu\text{s}$). To simplify operation, select simultaneous transfer of cursor settings to all three displays by selecting All Displays in the Cursor pulldown menu.

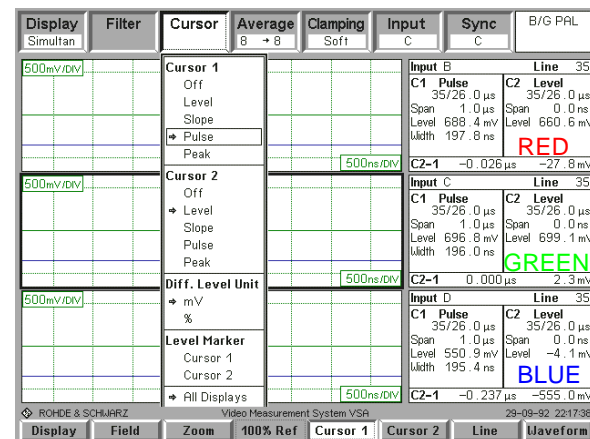

Fig. 21 Cursor settings for measuring the time offset between R - G and G - B

Shift the Pulse cursor to the center of the 2T reference pulse of the green component, which is displayed in the center window for input C. Shift the Level cursor until $0.000 \mu\text{s}$ is displayed as the time difference C2-C1 for the green component.

The R&S VSA now automatically measures the difference between the time centers of the 2T pulses of the red and blue components relative to the time center of the 2T pulse of the green component.

The R&S VSA calculates the time centers of the 2T pulses from the time positions of the 50% amplitude of the rising and the falling 2T pulse edges. The time centers of the 2T pulses are in the middle between the time positions of the 50% amplitudes.

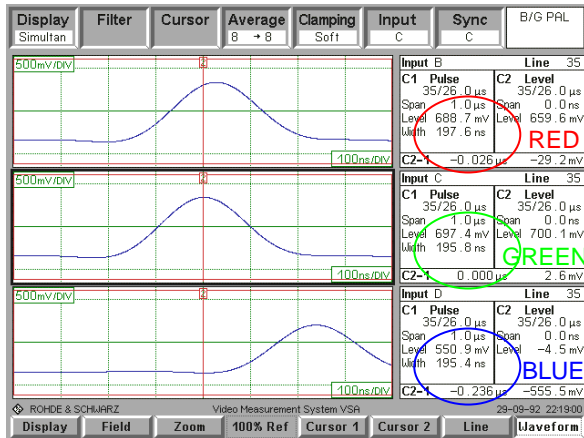

Fig. 22. Measuring the time offset between R - G and B - G

This example shows that the red pulse component of input B is delayed by 26 ns against the green component. The level is 688.7 mV which is about 1.5% too low. However, these distortions in the time and level domain are not visible on the screen.

The blue component is clearly too late and its level is too low. On the TV screen, this delay is shown by vertical white lines which have yellowish/reddish shadows at the front and a blue aftershadow. The blue component is measured. It has a delay of 236 ns against the green component and a level of only 550.9 mV, which is 21% too low.

The time offset measurement can also be performed automatically with the aid of the controller function of the R&S VSA when the R&S BASIC program RGBZeit.bas is used. The program is available on the R&S homepage as an Appendix to this Application Note. A hardcopy of the program is enclosed as Appendix 2. Once initialized, the R&S VSA requires hardly more than one second for measuring the time differences of the red and blue components to the green reference component. The CODEC43 test pattern with test signal CCIR17 in line 34 is again used as the test signal.

4.3 Signal Interfaces on STBs and DVD Players

4.3.1 S-VHS Connector

Standard S-VHS male and female connectors are provided with 4 contacts for ground and Y component (chrominance) in one housing. They are normally referred to as Hosiden connectors.

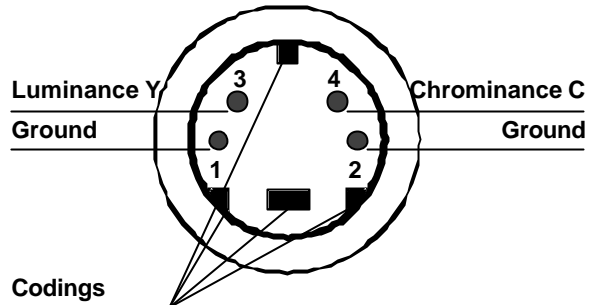

Fig. 23. S-VHS connector - contact side

Video analyzers are equipped with coaxial 75 Ω BNC connectors. To ensure a reliable connection to the measuring instrument, we therefore recommend to adapt the above connector to BNC for luminance and chrominance.

Adapters for Hosiden connectors to two coaxial 75 Ω BNC connectors are not commercial. Customers must create their own adapters.

4.3.2 SCART Connector

SCART is the abbreviation of "Syndicat des Constructeurs d'Appareils Radiorécepteurs et Téléviseurs". SCART connectors are commonly used as video and audio interfaces on STBs, DVD players and other video and audio consumer units. The SCART interface is defined by standards EN 50 049 or IEC 933.

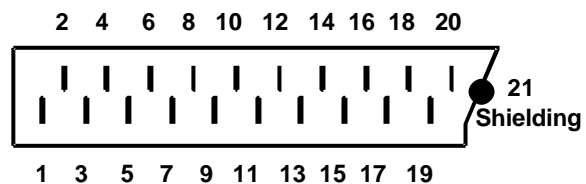

Fig. 24 SCART connector - contact side

Table 2 shows the most common contact assignment but the standard allows for three other pin configurations which are not described here.

1	Audio, right, off
2	Audio, right, on
3	Audio, left / mono off
4	Audio, ground
5	Blue, ground
6	Audio, left / mono on
7	Blue
8	Input/output switching voltage
9	Green, ground
10	Not used
11	Green
12	Not used
13	Red, ground
14	Not used
15	Red
16	Blanking signal, 1 = blanking
17	CCVS, ground
18	Ground, blanking signal
19	CCVS off
20	CCVS on
21	Shielding

Table 2 Most common contact assignment of SCART connector

Here, too, the following applies:

Video analyzers are equipped with coaxial 75 Ω BNC connectors. To ensure reliable connections to the measuring instrument, we recommend to adapt the SCART connector to BNC for the three primary colours RGB and the S-VHS and CCVS signals.

Adapters from SCART to coaxial 75 Ω BNC connectors for the video signals are not commercial. Adaptation is normally via standard Cinch connectors and then commercial Cinch - BNC adapters are used.

Standard SCART cables for audio signals are also available with Cinch connectors which can then be adapted to BNC as described above.

5 Conclusion

Analog measurements are not obsolete. As long as digital video signals have to be D/A-converted for display on the - still commonly used - analog screen, the analog outputs of the involved instruments have to be checked to make sure that the required quality parameters are complied with. In production, where not one second of test time can be wasted, the fast Video Analyzer R&S UAF is the optimum solution to check compliance with required quality criteria.

If comprehensive measurements are to be performed, the flexible Video Measurement System R&S VSA with its great variety of measurement functions is the right choice. This system can also be used as an IEC 625/IEEE488-bus controller for final production test systems without any other facilities being required.

6 Configuration of VSA for running a Basic program

- Change VSA to controller mode:
 - press **hardkey CONTROLLER**
 - select **MAPPING** **ENTER**
 - DISPLAY**
 - select Front Panel **DOS**
 - select ext. Monitor **DOS**
 - KEYBOARD**
 - select Keyboard **ext. Monitor** **ENTER**
- press **two times ESC** hardkey
- DOS Mode is selected C:\>
- type in C:\> **cd RS-BASIC** **ENTER**
- C:\RS-BASIC>**BASIC** **ENTER**
- (change to R&S Basic)
- insert disk** with Basic programs **VSA_RGB1.BAS** and **RGBTIME1.BAS** into slot of VSA and type in **ALOAD"A:VSA_RGB1.BAS"** **ENTER**
- program **VSA_RGB1.BAS** is loaded into VSA
- type in **SAVE"VSA_RGB1.BAS"** **ENTER**
- program **VSA_RGB1.BAS** is stored in VSA
- type in **ALOAD"A: RGBTIME1.BAS"** **ENTER**
- program **RGBTIME1.BAS** is loaded into VSA
- type in **SAVE" RGBTIME1.BAS"** **ENTER**
- program **RGBTIME1.BAS** is stored in VSA
- type in **LOAD"VSA_RGB1.BAS"** **ENTER**
- RUN**
- the RGB measurements are executed
- to call a new program type in **delete all** **ENTER**
- type in **LOAD"RGBTIME1.BAS"** **ENTER**
- RUN**
- the timing measurements between (R and G) and (B and G) are executed

STOP program	CRTL / BREAK
back to BASIC	F8
RUN	F2
LOAD	F5
SAVE	F6
back to DOS	bye

Appendix 1

VSA_RGB1.bas

Measurement of video parameters of RGB components using R&S VSA

```
10 SET 1,3: MOVE 350,300: AREA 410,90: SET 2,15
15 PRINT " [2J Please wait..."
20 Vsa=20: IEC TIME 8000
22 IEC OUT Vsa,"*RST"
23 IEC TERM 10: IEC TIME 8000
25 IEC OUT Vsa,"conf:meas:ref:sel:all off;*wai"
30 IEC OUT Vsa,"calc:aver:meas:count 0;*wai"
35 REM PRINT "Measurement with initialization of VSA ? yes/no"
40 REM INPUT X$: IF X$="yes" THEN 100 ELSE 190
100 PRINT "VSA Initialisation in Progress..."
105 IEC OUT Vsa,"conf:meas:gro:sel:all CLEAR;*wai"
110 IEC OUT Vsa,"conf:meas:gro:sel LBAA,ON;*wai"
115 IEC OUT Vsa,"conf:meas:gro:sel SAA,ON;*wai"
120 IEC OUT Vsa,"conf:meas:gro:sel TILT,ON;*wai"
125 IEC OUT Vsa,"conf:meas:gro:sel LNL,ON;*wai"
130 IEC OUT Vsa,"conf:meas:gro:sel SXAP,ON;*wai"
135 IEC OUT Vsa,"conf:meas:gro:sel SXAN,ON;*wai"
140 IEC OUT Vsa,"conf:meas:gro:sel SXGP,ON;*wai"
145 IEC OUT Vsa,"conf:meas:gro:sel SXGN,ON;*wai"
150 IEC OUT Vsa,"conf:meas:gro:sel LNLB,ON;*wai"
155 IEC OUT Vsa,"conf:meas:gro:sel LP,ON;*wai"
160 IEC OUT Vsa,"conf:meas:gro:sel LJPP,ON;*wai"
165 IEC OUT Vsa,"CONF:MEAS:TSIG:LINE T17C,34,TSIN,603,TSYN,17,TQU,50"
170 IEC OUT Vsa,"rout:ssel B;*wai"
175 IEC OUT Vsa,"STAT:VSAS LME;*wai"
180 IEC OUT Vsa,"conf:meas:gro sel;*wai"
190 PRINT " [2J"
195 REM first build up the measurement display
196 GOSUB 1000
200 IEC OUT Vsa,"rout:meas:isel A;*wai"
205 IEC OUT Vsa,"read:meas:par? LBAA;*wai"
210 IEC IN Vsa,X$: Alba=VAL(X$): IF Alba=0 THEN 205
215 IEC OUT Vsa,"read:meas:par? TILT;*wai"
220 IEC IN Vsa,X$: Atilt=VAL(X$)
225 IEC OUT Vsa,"read:meas:par? LNL;*wai"
230 IEC IN Vsa,X$: Alnl=VAL(X$)
235 IEC OUT Vsa,"read:meas:par? SXAP;*wai"
240 IEC IN Vsa,X$: Asxap=VAL(X$)
245 IEC OUT Vsa,"read:meas:par? SXAN;*wai"
250 IEC IN Vsa,X$: Asxan=VAL(X$)
255 IEC OUT Vsa,"read:meas:par? SXGP;*wai"
260 IEC IN Vsa,X$: Asxgp=VAL(X$)
265 IEC OUT Vsa,"read:meas:par? SXGN;*wai"
270 IEC IN Vsa,X$: Asxgn=VAL(X$)
275 IEC OUT Vsa,"read:meas:par? LNLB;*wai"
280 IEC IN Vsa,X$: Alnlb=VAL(X$)
300 PRINT " [10;45H";USING "####.#";1000*Alba
305 PRINT " [12;45H";USING "-##.#";100*Atilt
310 PRINT " [13;45H";USING "-##.#";100*Alnl
```

```

315 PRINT " [14;45H";USING "-###.##";Asxap
320 PRINT " [15;45H";USING "-###.##";Asxan
325 PRINT " [16;45H";USING "-####";1E9*Asxgp
330 PRINT " [17;45H";USING "-####";1E9*Asxgn
335 PRINT " [18;45H";USING "##.#";Alnb
340 'SET 1,3: MOVE 350,280: AREA 410,60: SET 2,155
400 IEC OUT Vsa,"rout:meas:isel B;*wai"
402 IEC OUT Vsa,"read:meas:par? LBAA;*wai"
404 IEC IN Vsa,X$: Blba=VAL(X$): IF Blba=0 THEN 402
406 IEC OUT Vsa,"read:meas:par? SAA"
408 IEC IN Vsa,X$: Bsaa=VAL(X$)
410 IEC OUT Vsa,"read:meas:par? TILT;*wai"
412 IEC IN Vsa,X$: Btilt=VAL(X$)
414 IEC OUT Vsa,"read:meas:par? LNL;*wai"
416 IEC IN Vsa,X$: Blnl=VAL(X$)
418 IEC OUT Vsa,"read:meas:par? SXAP;*wai"
420 IEC IN Vsa,X$: Bsxap=VAL(X$)
422 IEC OUT Vsa,"read:meas:par? SXAN;*wai"
424 IEC IN Vsa,X$: Bsxan=VAL(X$)
426 IEC OUT Vsa,"read:meas:par? SXGP;*wai"
428 IEC IN Vsa,X$: Bsxgp=VAL(X$)
430 IEC OUT Vsa,"read:meas:par? SXGN;*wai"
432 IEC IN Vsa,X$: Bsxgn=VAL(X$)
434 IEC OUT Vsa,"read:meas:par? LNLB;*wai"
436 IEC IN Vsa,X$: Blnb=VAL(X$)
438 IEC OUT Vsa,"read:meas:par? LP"
440 IEC IN Vsa,X$: Blp=VAL(X$)
442 IEC OUT Vsa,"read:meas:par? LJPP"
444 IEC IN Vsa,X$: Bljpp=VAL(X$)
500 PRINT " [10;55H";USING "####.#";1000*Blba
502 PRINT " [11;55H";USING "####.#";1000*Bsaa
505 PRINT " [12;55H";USING "-##.#";100*Btilt
510 PRINT " [13;55H";USING "-##.#";100*Blnl
515 PRINT " [14;55H";USING "-###.##";Bsxap
520 PRINT " [15;55H";USING "-###.##";Bsxan
525 PRINT " [16;55H";USING "-####";1E9*Bsxgp
530 PRINT " [17;55H";USING "-####";1E9*Bsxgn
535 PRINT " [18;55H";USING "##.#";Blnb
540 PRINT " [19;55H";USING "###.###";1E6*Blp
545 PRINT " [20;55H";USING "####";1E9*Bljpp
600 IEC OUT Vsa,"rout:meas:isel C;*wai"
605 IEC OUT Vsa,"read:meas:par? LBAA;*wai"
610 IEC IN Vsa,X$: Clba=VAL(X$): IF Clba=0 THEN 605
615 IEC OUT Vsa,"read:meas:par? TILT;*wai"
620 IEC IN Vsa,X$: Cttilt=VAL(X$)
625 IEC OUT Vsa,"read:meas:par? LNL;*wai"
630 IEC IN Vsa,X$: Clnl=VAL(X$)
635 IEC OUT Vsa,"read:meas:par? SXAP;*wai"
640 IEC IN Vsa,X$: Csxap=VAL(X$)
645 IEC OUT Vsa,"read:meas:par? SXAN;*wai"
650 IEC IN Vsa,X$: Csxan=VAL(X$)
655 IEC OUT Vsa,"read:meas:par? SXGP;*wai"
660 IEC IN Vsa,X$: Csxgp=VAL(X$)
665 IEC OUT Vsa,"read:meas:par? SXGN;*wai"
670 IEC IN Vsa,X$: Csxgn=VAL(X$)
675 IEC OUT Vsa,"read:meas:par? LNLB;*wai"
680 IEC IN Vsa,X$: Clnlb=VAL(X$)

```

```

700 PRINT " [10;65H";USING "####.#";1000*Clba
705 PRINT " [12;65H";USING "-##.#";100*Ctilt
710 PRINT " [13;65H";USING "-##.#";100*Clnl
715 PRINT " [14;65H";USING "-##.##";Csxap
720 PRINT " [15;65H";USING "-##.##";Csxan
725 PRINT " [16;65H";USING "#####";1E9*Csxgp
730 PRINT " [17;65H";USING "#####";1E9*Csxgn
735 PRINT " [18;65H";USING "##.#";Clnlb
740 GOTO 200
750 STOP
1000 REM print screen
1010 SET 2,3: MOVE 35,340: LABEL "R",2
1020 SET 2,4: MOVE 60,340: LABEL "G",2
1030 SET 2,9: MOVE 85,340: LABEL "B",2: SET 2,15
1040 MOVE 115,335: LABEL "Component Measurement with VSA",1
1050 PRINT " [97m"
1060 PRINT " [8;10HParameter";TAB(42);"Red";TAB(52);"Green";TAB(62);"Blue"
1070 PRINT " [97m"
1080 SET 1,3: MOVE 348,280: AREA 424,55: SET 2,15
1090 SET 1,4: MOVE 425,280: AREA 504,55: SET 2,15
1100 SET 1,9: MOVE 505,280: AREA 580,55: SET 2,15
1110 MOVE 348,280: DRAW 50,280: DRAW 50,55: DRAW 348,55
1120 PRINT " [10;10HLum Bar Ampl (abs)    mV"
1130 PRINT " [11;10HSync Ampl (abs)    mV"
1140 PRINT " [12;10HTilt                %/bar"
1150 PRINT " [13;10HLum NL                %"
1160 PRINT " [14;10HSin x/x Amplitude pos  dB/grat"
1170 PRINT " [15;10HSin x/x Amplitude neg  dB/grat"
1180 PRINT " [16;10HSin x/x Group Delay pos ns/grat"
1190 PRINT " [17;10HSin x/x Group Delay neg ns/grat"
1200 PRINT " [18;10HLum Noise Lumw (bar)   dB/bar"
1210 PRINT " [19;10HLine Period            us"
1220 PRINT " [20;10HLine Jitter pp        ns"
1230 RETURN

```

= ESC

Appendix 2

RGBTIME1.bas

Measurement of time offset using the R&S BASIC program.

```
10 PRINT " [2J"
15 MOVE 160,370
20 SET 1,3: LABEL "Time positions",1
22 MOVE 0,340
25 SET 1,3: LABEL " of RGB components measured with VSA",1
30 PRINT " [6;15HTest signal CODEC43 with CCIR17 in line 34"
40 PRINT " [8;0HGreen component with sync pulse is time reference"
50 PRINT "Connections at VSA:"
60 PRINT "Red at input A, Green at input B, Blue at input C"
70 Vsa=20: IEC TERM 10: IEC TIME 4000: V=0.01
75 IEC OUT Vsa,"sens:scop:filt1 off"
76 IEC OUT Vsa,"sens:scop:filt2 off"
77 IEC OUT Vsa,"sens:scop:filt3 off"
80 REM F is "READY" switch, D is "dot" switch
90 F=0: D=0
100 PRINT
110 REM PRINT "Measurement with VSA initialization ? yes / no"
120 REMINPUT X$: IF X$="yes" THEN 130 ELSE 390
130 PRINT "VSA initialization in progress..."
140 IEC OUT Vsa,"STAT:VSAS SCOP"
150 IEC OUT Vsa,"ROUT:SCOP:ISEL1 A"
153 IEC OUT Vsa,"ROUT:SCOP:ISEL3 C"
155 IEC OUT Vsa,"ROUT:SCOP:ISEL3 C"
160 IEC OUT Vsa,"ROUT:SSEL B"
170 IEC OUT Vsa,"DISP:MODE TRIP,ON"
180 IEC OUT Vsa,"DISP:WIND1:TRAC:X:LPOS 34,26us,1.5us"
190 IEC OUT Vsa,"DISP:WIND1:TRAC:Y:BOTT -0.1V:TOP 1.1V"
220 IEC OUT Vsa,"DISP:WIND3:TRAC:X:LPOS 34,26us,1.5us"
230 IEC OUT Vsa,"DISP:WIND3:TRAC:Y:BOTT -0.1V:TOP 1.1V"
240 IEC OUT Vsa,"CONF:SCOP:TRAC1:CURS2:TYPE PULS"
250 IEC OUT Vsa,"CONF:SCOP:TRAC1:CURS2:X:LPOS 34,26us,1.5us"
280 IEC OUT Vsa,"CONF:SCOP:TRAC3:CURS2:TYPE PULS"
290 IEC OUT Vsa,"CONF:SCOP:TRAC3:CURS2:X:LPOS 34,26us,1.5us"
300 IEC OUT Vsa,"CONF:SCOP:TRAC1:CURS1:TYPE LEV"
310 IEC OUT Vsa,"CONF:SCOP:TRAC1:CURS1:X:LPOS 34,26us,0us"
340 IEC OUT Vsa,"CONF:SCOP:TRAC3:CURS1:TYPE LEV"
350 IEC OUT Vsa,"CONF:SCOP:TRAC3:CURS1:X:LPOS 34,26us,0us"
390 PRINT " Time measurement in progress...";
400 T=26
410 IEC OUT Vsa,"CALC:AVER:SCOP:COUN 8"
420 IEC OUT Vsa,"ROUT:SCOP:ISEL B"
425 IEC OUT Vsa,"DISP:WIND2:TRAC:X:LPOS 34,26us,1.5us"
427 IEC OUT Vsa,"DISP:WIND2:TRAC:Y:BOTT -0.1V:TOP 1.1V"
430 IEC OUT Vsa,"CONF:SCOP:TRAC2:CURS1:TYPE LEV"
440 IEC OUT Vsa,"CONF:SCOP:TRAC2:CURS2:TYPE PULS"
450 IEC OUT Vsa,"CONF:SCOP:TRAC2:CURS1:X:LPOS 34,"+STR$(T)+"us,0us"
460 IEC OUT Vsa,"CONF:SCOP:TRAC2:CURS2:X:LPOS 34,26us,2.0us"
470 REM measure the cursor timing difference
475 IEC OUT Vsa,"READ:SCOP:TRAC2:CURS2? DIFF"
480 IEC IN Vsa,X$
483 IF D=1 THEN 490
```

```

485 PRINT ".,.";
490 GOSUB 620
500 IF F=1 THEN 740
510 GOSUB 550
530 GOTO 470
550 REM Cursor shift
560 V$=LEFT$(R$,1)
570 IF V$="-" THEN 590
580 T=T+V: GOTO 600
590 T=T-V
600 IEC OUT Vsa,"CONF:SCOP:TRAC1:CURS1:X:LPOS 34,"+STR$(T)+"us,0.0us"
610 RETURN
620 REM Separation of level/time difference
630 A=LEN(X$)
640 IF A=25 THEN B=12: C=12
650 IF A=27 THEN B=13: C=13
660 IF A=26 THEN K$=MID$(X$,13,1)
670 IF K$="," THEN B=12: C=13 ELSE B=13: C=12
680 REM IF A=25 THEN C=12
690 L$=LEFT$(X$,B)
700 R$=RIGHT$(X$,C)
710 IF F=1 THEN 730
715 Z=VAL(R$)
720 IF ABS(Z)<0.5E-9 THEN F=1
725 IF ABS(Z)>1E-8 THEN V=0.01 ELSE V=0.001
728 IF ABS(Z)>1E-7 THEN V=0.1
730 RETURN
740 PRINT " [17;3H Time offset between Red and Green components"
750 IEC OUT Vsa,"ROUT:SCOP:ISEL A"
760 IEC OUT Vsa,"READ:SCOP:TRAC1:CURS2? DIFF"
770 IEC IN Vsa,X$: GOSUB 620
780 PRINT " [17;60H";USING "-###";VAL(R$)*1E9;" ns"
790 PRINT " [19;3H Time offset between Blue and Green components"
800 IEC OUT Vsa,"ROUT:SCOP:ISEL C"
810 IEC OUT Vsa,"READ:SCOP:TRAC3:CURS2? DIFF"
820 IEC IN Vsa,X$: GOSUB 620
830 PRINT " [19;60H";USING "-###";VAL(R$)*1E9;" ns"
835 PRINT " [21;60H"
837 IEC OUT Vsa,"ROUT:SCOP:ISEL B": D=1: F=0: GOTO 470
840 STOP
850 END

```

= ESC

Additional Information

Our Application Notes are regularly revised and updated. Check for any changes at <http://www.rohde-schwarz.com>.

Please send any comments or suggestions about this Application Note to:

Broadcasting-TM-Applications@rohde-schwarz.com.