

Products: RS[®]CMU200 (B17), RS[®]SMIQ (B14, B15), RS[®]CMU-Z11, RS[®]NRP-Z21, RS[®] NRP-Z22, RS[®] NRP-Z23, RS[®] NRP-Z24, RS[®]NRP, RS[®]NRVD, RS[®]NRVS

3GPP Receiver Tests Under Fading Conditions with R&S[®]CMU200 and R&S[®]SMIQ

Application Note

This application note describes how to generate 3GPP (UTRA-FDD) signals for receiver tests under fading conditions for user equipment. The test setup requires an R&S[®]CMU200 Universal Radio Communication Tester with option R&S[®]CMU-B17 IQ-IF interface and an R&S[®]SMIQ Vector Signal Generator. The test setup can be calibrated with either a R&S[®]NRP-Zx USB power sensor or an NRP, NRVD, or NRVS Power Meter. To calibrate the baseband and RF path and configure performance tests according to the 3GPP test specification 34.121 easily, the program 3GFadLevCor is included.



Contents

1	Overview	3
2	Introduction to 3GPP Fading	4
3	3GPP Fading with CMU200 and SMIQ	6
	Test Setup	6
	Manual Correction Procedure	8
4	Software Installation	13
	Hardware Requirements	13
	Software Requirements	13
5	Software Description	14
	Menu	14
	File	14
	Devices	15
	Propagation Conditions	16
	Help	16
	Controls and Indicators	17
6	Testing UE Receiver Quality with BLER Measurements Under Fading Conditions and AWGN	19
	How To Use the Test Specification	19
	Correction and Test with 3GFadLevCor	22
	Correction	22
	Test	22
	Measuring BLER Characteristic	24
7	Additional Information	25
8	Ordering information	25

1 Overview

The signal strength and quality of signals received by 3GPP Base Stations (Node-B) and User Equipment (UE) is influenced by effects resulting from the movement of the UE, and the overlay of numerous delayed signals caused by reflections. The phenomenon is called fading and is classified in profiles such as Fine Delay, Moving Propagation and Birth-Death Propagation Fading. This application note describes how to connect an R&S®CMU200 Radio Communication Tester with IQ-IF interface option R&S®CMU-B17 to an R&S®SMIQ03B Signal Generator for generating 3GPP FDD signals suitable for tests under fading conditions according to the 3GPP test specification TS 34.121. The supplied program 3FadCalRf compensates the attenuation of an R&S®SMIQ03B when operated as external fading simulator connected to the CMU200 IQ loop. 3FadCalRf can also calculate the mathematical signal loss resulting from various fading profiles and noise influence and automatically adds an equivalent offset to the CMU200 RF power.

The following abbreviations are used in the text for R&S® test equipment:

CMU200	R&S®CMU200 Universal Radio Communication Tester
SMIQ	R&S®SMIQ Vector Signal Generator
NRP-Z11, NRP-Z21, etc.	R&S®NRP-Z11, R&S®NRP-Z21, etc. Power Sensors
NRP	R&S®NRP Power Meter
NRVD	R&S®NRVD Power Meter
NRVS	R&S®NRVS Power Meter
Rohde & Schwarz GmbH und Co. KG	R&S®

2 Introduction to 3GPP Fading

There are basically two factors that affect the quality of a received 3GPP signal.

A signal from the base station (Node B) usually makes its way to the UE via multiple paths. For test purposes, a variety of profiles simulate real-world fading:

- Pure Doppler which simulates direct transmission paths for which Doppler shift is occurring due to movement of the UE.
- Rayleigh Fading simulates a radio hop which arises as a result of scatter caused by obstacles in the signal path (buildings, etc.).

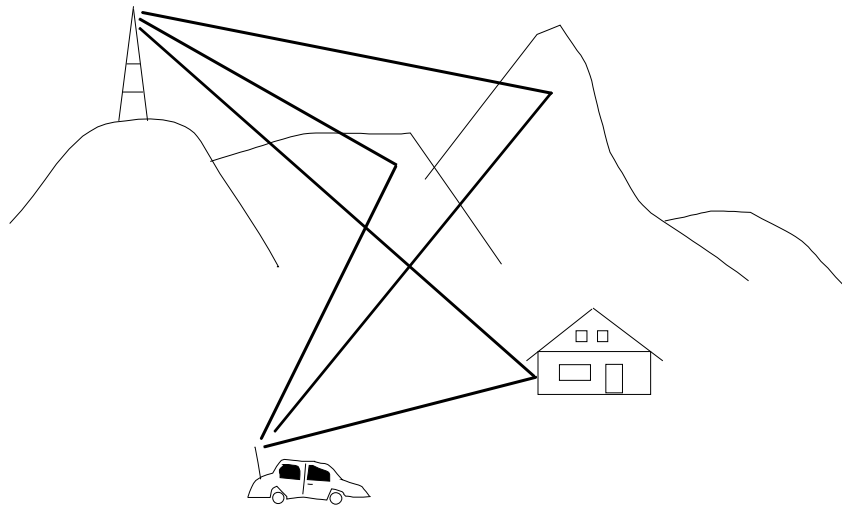

Fig. 1 Multi-path Fading

Delay variations (whether sudden or slow) become important with fast modulation standards such as 3GPP. Therefore two further propagation conditions were introduced in order to simulate the full range of influences affecting the receiver.

- Moving Propagation
- Birth Death Propagation

Since a UE only can decode the signal on one specific RF frequency at a time, the modulated signals on other frequencies simply appear as noise. The quality of the received signal is affected by the ratio of the signal power to the surrounding traffic noise level (Signal/Noise Ratio). This effect is simulated by including some Additive White Gaussian Noise (AWGN) to the signal.

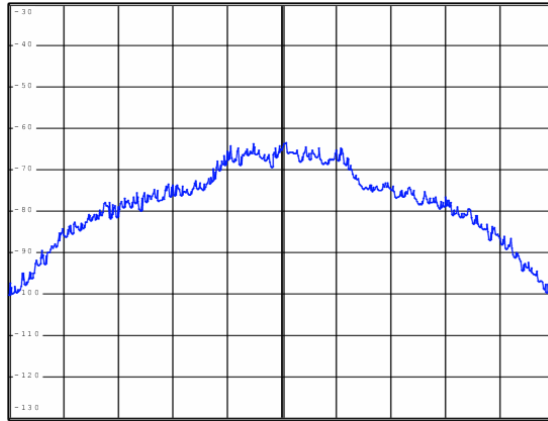

Fig. 2 Faded 3GPP signal + AWGN

The test specification for 3GPP User Equipment (TS 34.121) contains numerous test cases in order to guarantee wide ranging functionality. The fading or propagation conditions are classified as:

- **STATIC PROPAGATION** – For a UE located at a fixed point the received signal is merely overlaid by surrounding traffic noise (AWGN).
- **MULTI-PATH FADING PROPAGATION (Fine Delay)** – This simulates the effect that occurs when a UE is moving with a certain speed. The test specification 3GPP TS 34.121 defines 6 different cases that cover typical situations, e.g. pedestrian (3 km/h), cars (50 km/h) and trains (250 km/h). The signal is additionally overlaid by surrounding traffic noise.
- **MOVING PROPAGATION (Moving Delay)** – Simulates the gradual change of one moving path to a reference path which occurs while driving on a flat countryside with no other dramatic landscape changes such as entering a forest. The signal is additionally overlaid by surrounding traffic noise.
- **BIRTH-DEATH PROPAGATION** – Is the sudden cancellation of the direct path leaving only one reflected path left. This situation may occur when turning around a corner and leaving the basestation's line of sight. The signal is additionally overlaid by surrounding traffic noise.

The SMIQ requires both fading options SMIQ-B14 and SMIQ-B15 to simulate these effects according to the test specification 3GPP TS 34.121.

3 3GPP Fading with CMU200 and SMIQ

Test Setup

The specification TS 34.121 prescribes the following test setup variations for performance tests under fading conditions. For the static propagation test AWGN is added to the signal.

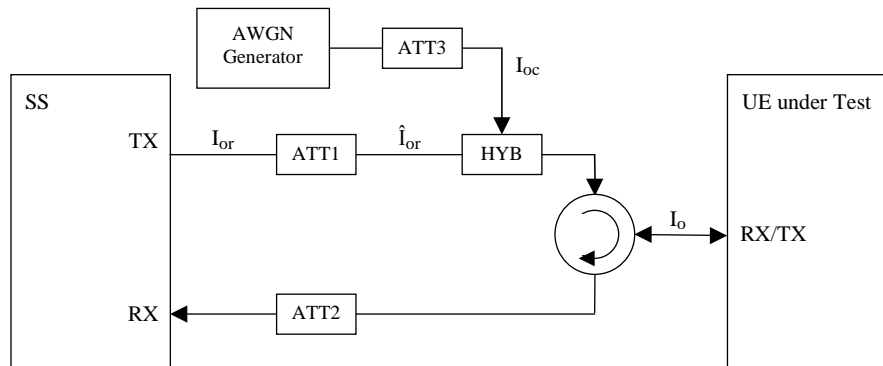

Fig. 3 Connection for Static Propagation Test

In the multi-path fading propagation test the signal is faded first, then AWGN is added to the faded signal.

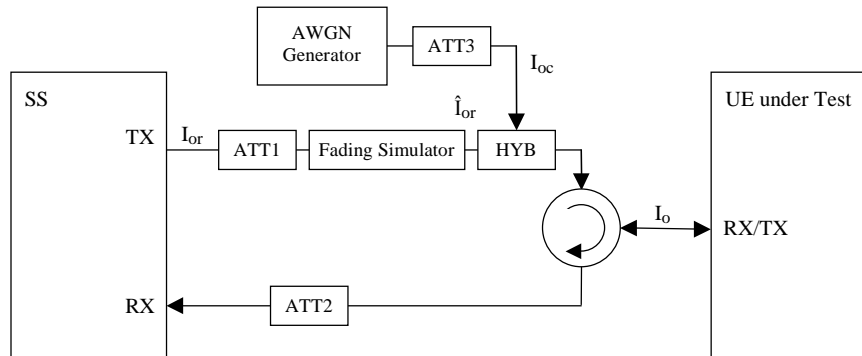

Fig. 4 Connection for Multi-path Fading Propagation Test

The same effect is achieved by simulating fading and AWGN on the baseband level inside the SMIQ. The 3GPP baseband signal generated by the CMU200 is fed to the SMIQ IQ baseband input via the CMU-B17 IQ/IF option. The SMIQ modulates the faded and AWGN signal to RF level and sends it to the UE via a directional coupler (e.g. Narda 3022 20dB). This setup prevents crosstalk between the downlink (DL) and uplink (UL) signals and also protects the SMIQ RF output from the UE output power (typically +27dBm).

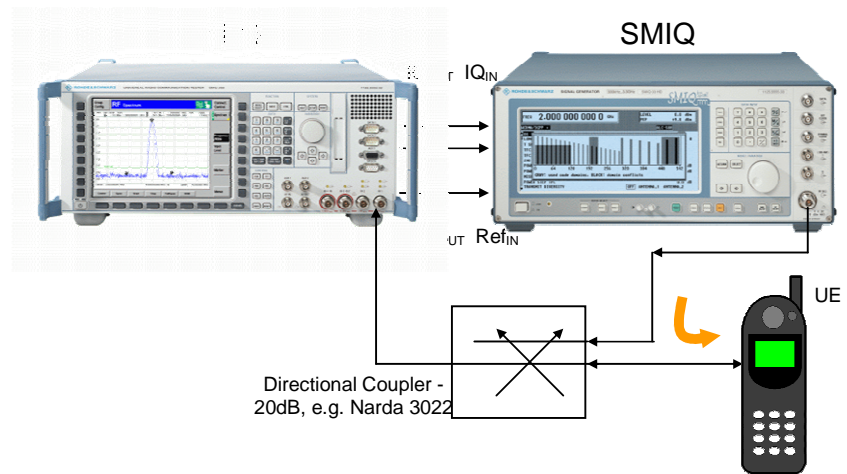

Fig. 5 Test setup

Block Error Rate (BLER) measurements for 3GPP react very sensitive to changes in the Signal / Noise Ratio. So unknown signals inside (wanted signal level $\hat{\rho}$) and outside (downlink cable loss) the external fading simulator SMIQ need to be precisely determined.

Manual Correction Procedure

This section shows how to manually correct the downlink cable loss $CABLELOSSDL$ and the wanted signal \hat{I}_{or} which can also be determined automatically with the program **3GFADLEVCOR**. The figure below shows which levels need to be compensated and the order of their determination.

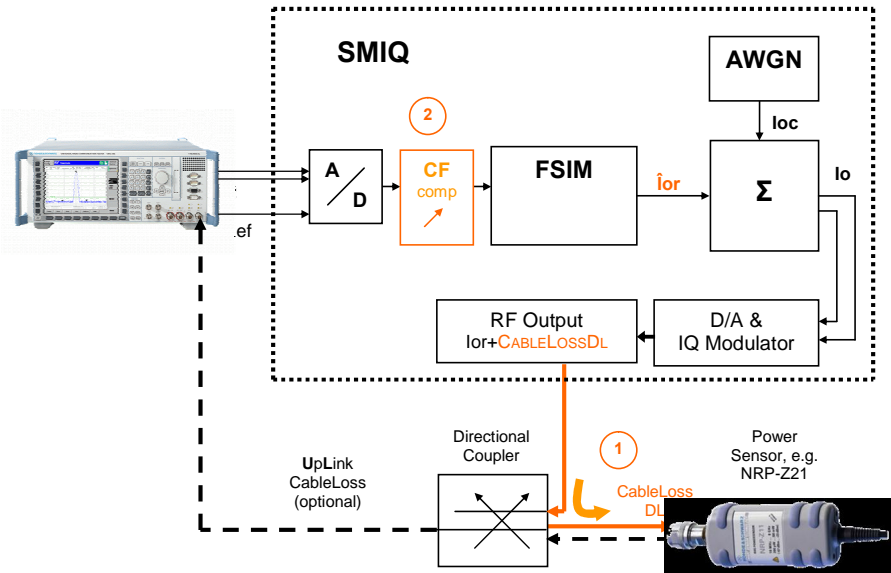

Fig. 6 Correction configuration

1. Correct DownLink (SMIQ -> UE) cable loss ($CABLELOSSDL$).
2. Correct the signal level \hat{I}_{or} . This is achieved by tweaking the SMIQ Crest Factor (CF) control. This control is intended to compensate for the Crest Factor of an unknown external signal fed to the SMIQ.

Note: If the UE power needs to be measured, the UpLink cable loss ($CableLossUI$) must be measured in a similar manner to the downlink cable loss.

The test specification TS34.121 for 3GPP User Equipment prescribes performance tests at frequencies for the lowest channel (10562 = 2112.4 MHz), medium channel (10675 = 2135 MHz) and highest channel (10838 = 2167.6 MHz). The cable loss is frequency dependent and needs to be corrected separately for all three frequencies. Following example is for the lowest frequency. The measurement in this example was performed with a NRP-Z21 power sensor and the program POWER VIEWER contained in the supporting driver package NRP Toolkit.

1. CMU configuration:

- RESET -> **ALL**
- MENU SELECT -> 3G UMTS USER EQUIPMENT -> WCDMAFDD -> SIGNALLING -> **BLER**
- DEDICATED CHANNEL -> **RMC**
- AF/RF -> RF INPUT -> **RF2**, RF OUTPUT -> **RF1**
- RF CHN. DOWNLINK -> **2112.4 MHz**
- CONNECT CONTROL -> 2 -> I/Q-IF -> **Fading**

2. NRP-Z21 configuration:

- Install the NRP-Z21 VXiPnp driver including the NRP Toolkit first, before connecting it to the PC or USB hub.
- Start the program **POWER VIEWER**.
- **ZERO** the NRP-Z21 power sensor (disconnect the sensor or turn OFF the SMIQ RF power first).



Fig. 7 Zero power sensor

- Set NRP-Z21 frequency -> **211e9 Hz**

3. SMIQ configuration:

- Press PRESET
- LEVEL -> LEVEL -> POWER RESOLUTION -> **0.01 dB**
- FREQ -> **2112.4 MHz**
- LEVEL -> **0.00 dBm**

4. Measure the SMIQ CW power with the NRP-Z21.

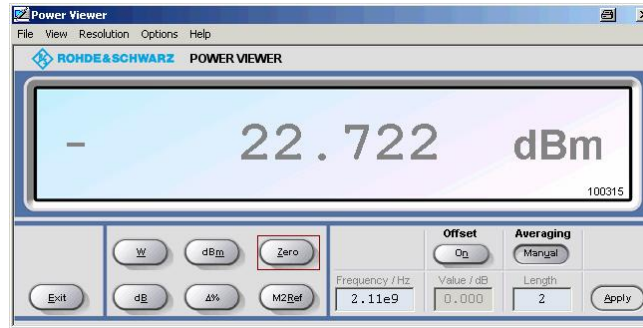

Fig. 8 Measure SMIQ CW power

5. Set SMIQ menu: LEVEL -> LEVEL -> OFFSET -> -22.72 dB (CABLELOSSDL).

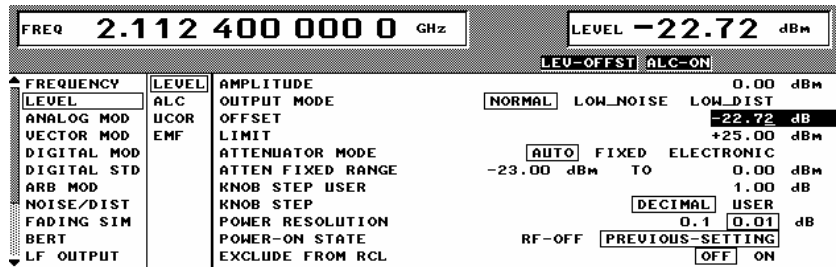

Fig. 9 SMIQ level offset

6. Set SMIQ nominal level with LEVEL -> -30.00 dBm.

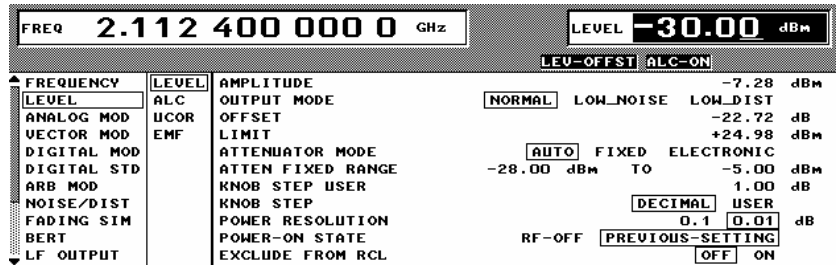

Fig. 10 SMIQ nominal level

7. The NRP-Z21 displays the nominal level.

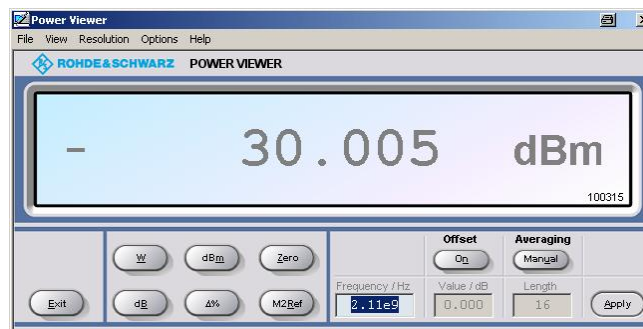

Fig. 11 Corrected cable loss

8. Set SMIQ:

- FADING SIM -> Fine Delay -> State -> **ON**
- PROFILE **PDOPP**
- DOPPLER FREQ **1600.0 Hz**
- PATH LOSS **0.0 dB**
- NOISE/DIST -> NOISE -> **ON**
- CARRIER/NOISE RATIO -> **30.00 dB**
- SYSTEM BANDWIDTH -> **3.84 MHz**

Note: Leaving AWGN ON during the correction causes the relative error

$$-30 \text{ dB} = 10 * \log (x)$$

$$x = 10e-3 = \mathbf{0.001 \text{ dB}}$$

which does not noticeably affect the measurement result. There may be a difference of < 0.2 dB compared to the level with AWGN OFF due to switch attenuations.

9. Turn SMIQ VECTOR MOD -> STATE -> **ON**

10. The NRP-Z21 displays the uncorrected signal level (\hat{I} or)

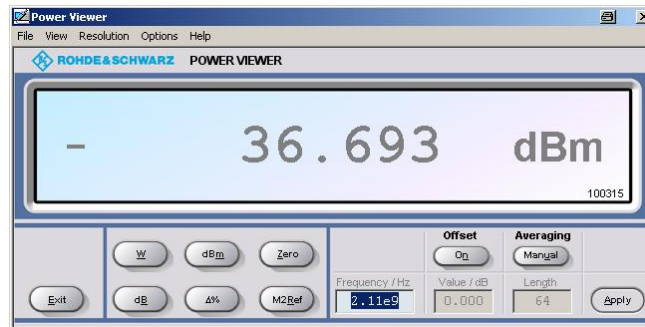

Fig. 12 Uncorrected signal level (\hat{I} or)

11. Enter the offset to the SMIQ nominal level:

VECTOR MOD -> CREST FACTOR -> **6.69 dB** (= -30 dBm + 36.693 dBm)

Tweak the Crest Factor if necessary to obtain the corrected signal level -30.00 dBm.

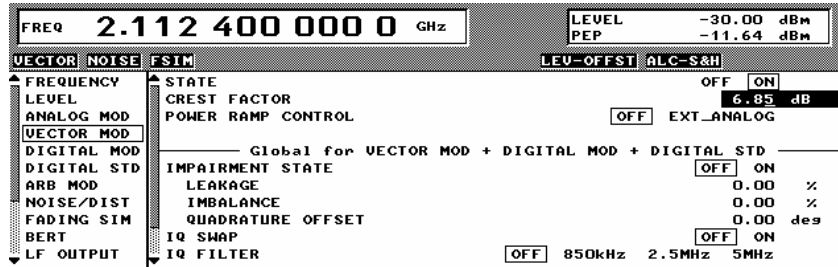

Fig. 13 Tweak Crest Factor

The NRP-Z21 should show a similar readout to:

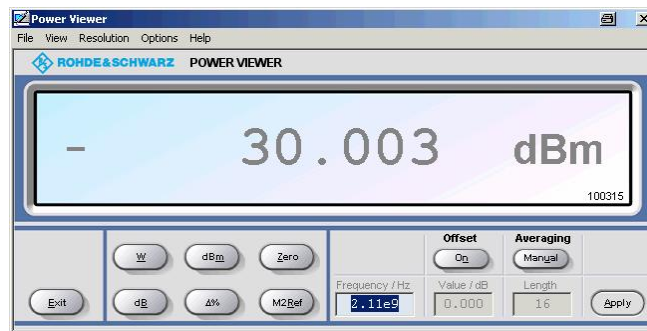

Fig. 14 Corrected signal level (for)

4 Software Installation

Hardware Requirements

The software runs on a PC with

CPU	Pentium 330MHz or better
RAM	128 MBytes or more
MONITOR	SVGA color monitor 800x600 or better
IEC/IEEE BUS	IEC/IEEE bus interface Rohde & Schwarz IEEE-488.2 bus interface PS-B4 , 1006.6207.04, or National Instruments AT-GPIB , PCI-GPIB or PCMCIA-GPIB card.

Software Requirements

WINDOWS 98SE/NT/2000/XP	Microsoft operating system
NI-488.2 v1.7 (or above)	IEC/IEEE – bus driver from National Instruments. See http://www.natinst.com for latest revision.
NI-VISA v3.0 (or above)	VISA driver from National Instruments. See http://www.natinst.com for latest revision.
MICROSOFT INSTALLER	Versions for Windows 95/98/NT are available at http://www.rohde-schwarz.com . Not required for Windows 2000/XP.

Note: In case only the NI-488.2 GPIB driver is installed but no VISA driver the program will react as if there were no device connected to the GPIB bus.

The following installation files are required to install the level correction software 3FADCALRF on the controlling PC.

3GFADLEVCOR v1.xx.MSI

DISTFILE.CAB

Execute **3GFADLEVCOR v1.xx.MSI** and select the installation directory. A new menu item **3GFADLEVCOR** is created in **START -> PROGRAM FILES**. The installation directory contains the files named below:

3GFADLEVCOR.EXE	Executable
3GFADLEVCOR.CFG	Configuration file
3GFADLEVCOR.CHM	Online help manual

5 Software Description

This section describes the program's menu items and controls. Start **3GFADLEVCOR.EXE** on the PC. The program's purpose is to set the CMU200 external generator attenuation to the calculated ExtAtten value so the CMU200 generator output level display shows the signal power actually applied to the UE.

Menu

File

All program and device specific data can be saved and loaded from a configuration file.

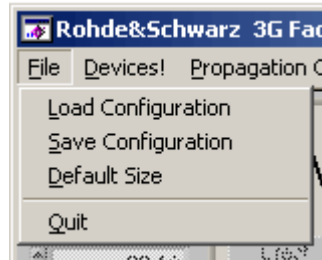

Fig. 15 Menu items

- **LOAD CONFIGURATION** - the default file extension is **.cfg*. The configuration file contains the following parameters:
 - X = last horizontal window position
 - Y = last vertical window position
 - CMU GPIB primary address
 - CMU GPIB sec. address of 3GPP signalling module
 - SMIQ GPIB primary address
 - Cable Loss
 - Signal / Noise Ratio
 - Width and Height of main window
- **SAVE CONFIGURATION** - the default file extension is **.cfg*. Similar file dialog as *Load Configuration*.
- **DEFAULT SIZE** – Resets program window to original size.

Devices

In the **DEVICES** menu the primary (**PAD**) and secondary non-signaling and signaling secondary addresses (**SAD**) according to the CMU200 settings must be selected. Initialize the CMU200 and SMIQ by pressing the corresponding **INIT** buttons.

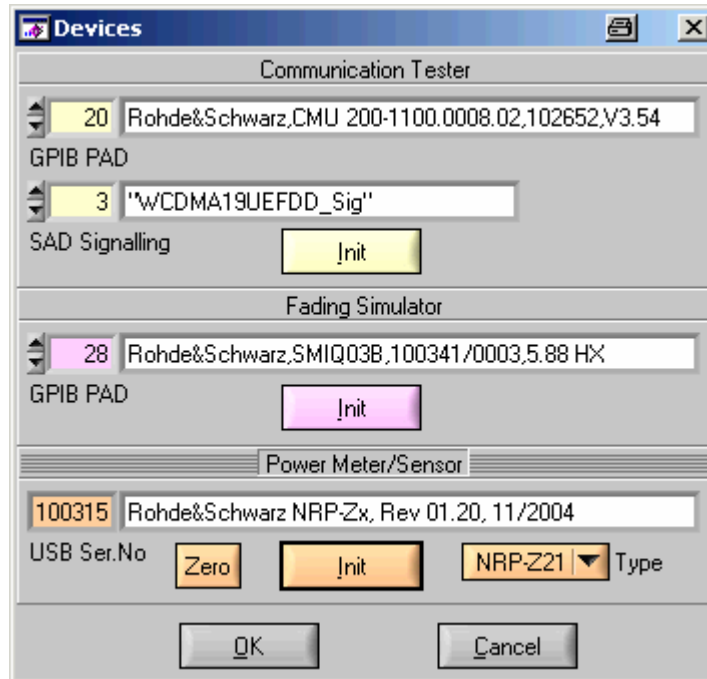

Fig. 16 Select devices

- CT (communication tester) **GPIB PAD** – GPIB primary address of the CMU. Range: 0 to 30.
- CT **SAD Signaling** – GPIB secondary address of the CMU200 option to be used for Measurement Mode. Range: 1 to 29.
- CT **INIT** – Checks for the presence of a device and displays the identification string of a device found in the text field.
- FS (Fading Simulator) **PAD** – GPIB primary address of the SMIQ. Range: 0 to 30.
- FS **INIT** – Checks for the presence of a device and displays the identification string of a device found in the text field. It also turns the fading and AWGN option ON and sets AWGN system bandwidth (SysBw) to 3.84MHz.
- PM (Power Meter/Sensor) **USB SER. NO** – A unique six digit number identifying a USB power sensor. If a power meter Type NRP, NRVD or NRVS is selected USB SER. NO is replaced by a **GPIB PAD** control for entering the primary GPIB address of the device.
- PM **TYPE** – Selects USB power sensors NRP-Z11, NRP-Z21, NRP-Z22, NRP-Z23 and NRP-Z24, or GPIB power meters NRP, NRVD and NRVS.
- **ZERO** – Performs a zeroing (calibration) of the power meter/sensor. The SMIQ RF output is turned OFF before, and ON after zeroing.

- **PM INIT** – Checks for the presence of a device and displays the identification string of a device found in the text field.

Note: A power meter / sensor is not mandatory to operate 3GFadLevCor. The power sensor / meter must be initialized before a correction can be performed (dimmed controls).

By pressing **OK** the program returns to the main window and sets the SMIQ RF frequency to the same frequency the CMU200 generator has in signaling mode. Numerous controls are un-dimmed, indicating correct device initialization.

Propagation Conditions

The menu **PROPAGATION CONDITIONS** select of static propagation (AWGN), multi-path fading propagation (**FINE DELAY**), moving propagation (**MOVING DELAY**) and Birth Death according to 3GPP Test Specification for User Equipment 34.121.

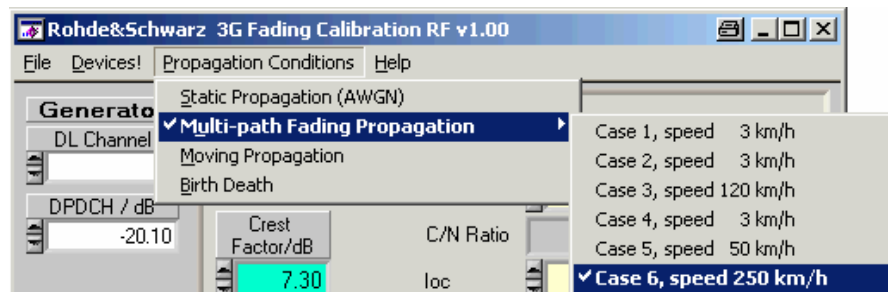

Fig. 17 Propagation conditions

Help

- **HELP** – displays online help
- **ABOUT** – displays revision, copyright and driver information

Controls and Indicators

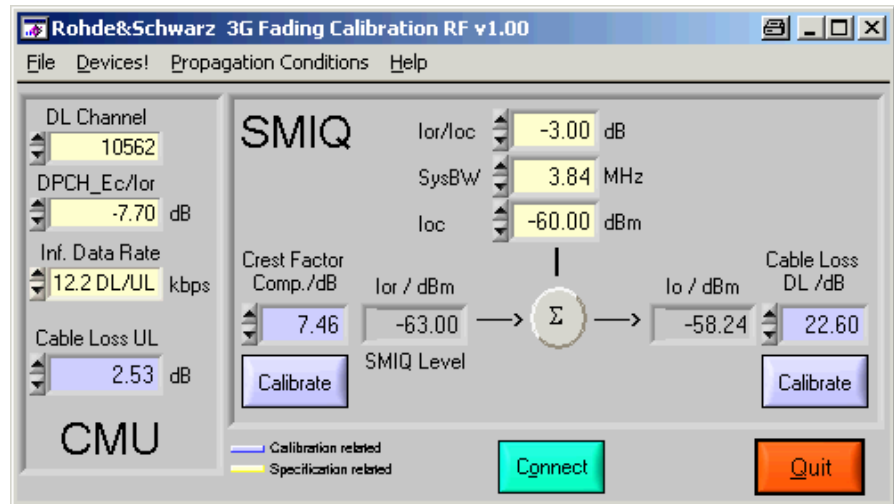

Fig. 18 Main Window

- **DL CHANNEL** – Control for the CMU200 generator DownLink Channel. Range 10562 to 10838 (= 2112.4 MHz to 2167.6 MHz)

$$f_{GEN} = (2112.4 + (Chan - 10562) * 0.2) MHz$$

The tests are usually performed at the lowest (2112.4 MHz), middle (2135 MHz) and highest (2167.6 MHz) frequencies of the 3GPP band.

- **DPDCH** – Control for the ratio of the DPDCH (Dedicated Physical Data Channel) power to the P-CPICH (Physical Common Pilot Channel) power in the CMU. Range -35 to +15 dB.
- **CABLE LOSS UPLINK** – the user specified attenuation for the cable from the UE to the CMU200 RF1 connector. The CMU200 **EXT ATTEN INPUT** is automatically set to **CABLE LOSS UL**.
- **CORRECT CL** – Performs a correction of the downlink cable loss including the directional coupler.
- **CREST FACTOR COMPENSATION** – Control for the $\hat{I}or$ gain which is necessary to compensate the Crest Factor of an external baseband signal (e.g. 6.69 dB, see page 12). It can be determined by pressing **CORRECT CF**.
- **CORRECT CF** – Determines the gain which is necessary to compensate the Crest Factor of an external baseband signal (see pages 8-12) and updates the CREST FACTOR COMP control.
- $\hat{I}OR$ – Indicator for the wanted signal RF level (SMIQ).
- $\hat{I}OR/Ioc$ – Control for Signal ($\hat{I}or$) / Noise (Ioc) Ratio as prescribed by the test specification.
- **SYSBW** – SMIQ AWGN system bandwidth control.

Note: The noise spectral density of SMIQ is flat within 1.4 times the set system bandwidth. This means, with a system bandwidth of 3.84MHz you obtain flat noise within 5.376 MHz. The 3GPP specification however requires $3.84 \text{ MHz} * 1.5 = 5.76 \text{ MHz}$ noise bandwidth. In our opinion, 5.376 MHz is sufficient for all hardware tests. For all cases, where a noise bandwidth of 5.76 MHz is mandatory, we suggest to set the system bandwidth of the SMIQ to $3.84 \text{ MHz} * 1.5 / 1.4 = 4.114 \text{ MHz}$.

- **CABLE LOSS DOWNLINK** – the attenuation for the cable from the SMIQ RF connector to the UE including the coupling loss for test adaptors as determined in the correction procedure (see pages 8-12) or by pressing **CORRECT CL**.
- **IOC** – Control for absolute AWGN power as defined in the 3GPP Test Specification TS 34.121.
- **CONNECT** – Turns SMIQ fading and AWGN OFF to ease UE registering and connection. If fading and AWGN is turned ON during this procedure the mobile may lose synchronization and drop the connection.

Note: For reliable registration and connection of your mobile, press the **CONNECT** button first. Then register your mobile phone for the CMU200 providing WCDMA network by turning it OFF and ON. The CMU200 shows that the registration has been successful by displaying a different window requesting you to press the **CONNECT UE** button for connection build-up. After the connection has been established press **OK** in the **MOBILE AND REGISTRATION** window which turns SMIQ fading and AWGN ON again. Now all conditions are met to perform a BER or BLER measurement.

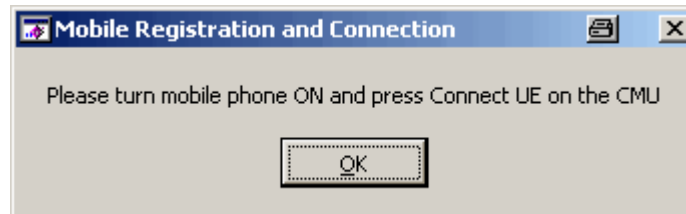

Fig. 19 Mobile Registration and Connection

6 Testing UE Receiver Quality with BLER Measurements Under Fading Conditions and AWGN

The receive characteristics of the Dedicated Channel (DCH) in different multi-path fading environments are determined by the **BLock Error Ratio** (BLER) values.

How To Use the Test Specification

The following example describes the relevant parameters for performing the test **7.3 DEMODULATION OF DCH IN MULTI-PATH FADING PROPAGATION CONDITIONS** with **CASE 2** and **TEST 5** (see table below taken from the test specification 3GPP TS 34.121).

Table 7.3.1.3: DCH parameters in multi-path fading propagation conditions (Case 2)

Parameter	Test 5	Test 6	Test 7	Test 8	Unit
Phase reference	P-CPICH				
\hat{I}_{or}/I_{oc}	-3	-3	3	6	dB
I_{oc}	-60				dBm / 3,84 MHz
Information Data Rate	12,2	64	144	384	kbps

PHASE REFERENCE – The CMU200 currently supports only P-CPICH and therefore cannot perform tests involving S-CPICH (e.g. 7.3.1.7 / 7.3.1.8 and 7.3.1.17 / 7.3.1.18).

\hat{I}_{or}/I_{oc} is the Signal to Noise Ratio (SNR) between the WCDMA Output Channel Power \hat{I}_{or} and the AWGN signal level I_{oc} . This value (e.g. Test 5 = -3dB) is entered in the **3GFADLEVCOR** program which updates the SMIQ **CARRIER/NOISE RATIO** accordingly. The minimum SMIQ C/N resolution is 0.05 dB. The SMIQ automatically takes the gain / loss of a fading profile into account.

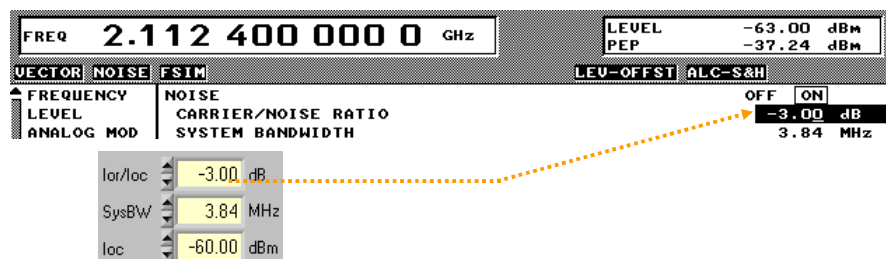

Fig. 20 C/N Ratio

I_{oc} is the absolute level of the AWGN interferer (e.g. -60dBm for Case 2, Test 5) at 3.84 MHz system bandwidth (SysBW).

INFORMATION DATA RATE is the data rate of the signal e.g. 12.2 kbps for Case 2, Test 5, CMU200 default value.

Table 7.3.1.4: DCH requirements in multi-path fading propagation conditions (Case 2)

Test Number	$\frac{DPCH_Ec}{I_{or}}$	BLER
5	-7,7 dB	10^{-2}
6	-6,4 dB	10^{-1}
	-2,7 dB	10^{-2}
7	-8,1 dB	10^{-1}
	-5,1 dB	10^{-2}
8	-5,5 dB	10^{-1}
	-3,2 dB	10^{-2}

$\frac{DPCH_Ec}{I_{or}}$ is the ratio of the Dedicated Pilot Channel to the Output Channel Power (e.g. -7.7dB for Case 2, Test 5).

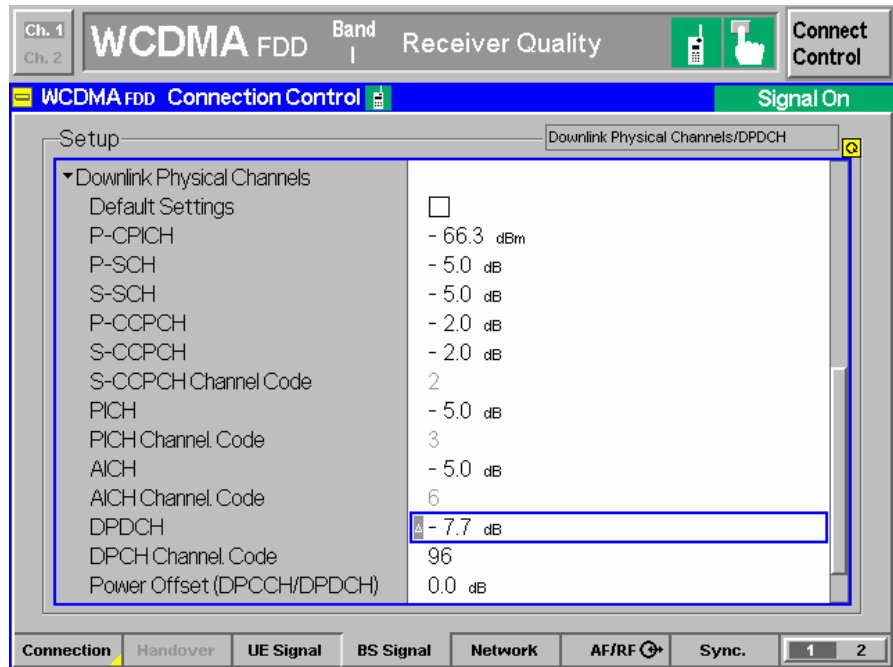

Fig. 21 DPDCH Level

BLER is the specified maximum measured Block Error Rate (e.g $10^{-2}=1\%$).

Table D.2.2.1: Propagation conditions for multi-path fading environments

Case 1, speed 3km/h		Case 2, speed 3 km/h		Case 3, speed 120 km/h	
Relative Delay [ns]	Average Power [dB]	Relative Delay [ns]	Average Power [dB]	Relative Delay [ns]	Average Power [dB]
0	0	0	0	0	0
976	-10	976	0	260	-3
		20000	0	521	-6
				781	-9

The required fading profile can be set with **3GFADLEV**COR in the menu **PROPAGATION CONDITIONS**.

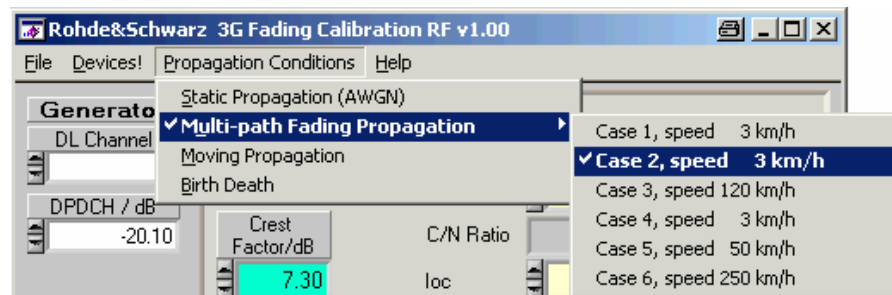

Fig. 22 Select Fading Profile

This sets up the SMIQ Fine Delay fading profile:

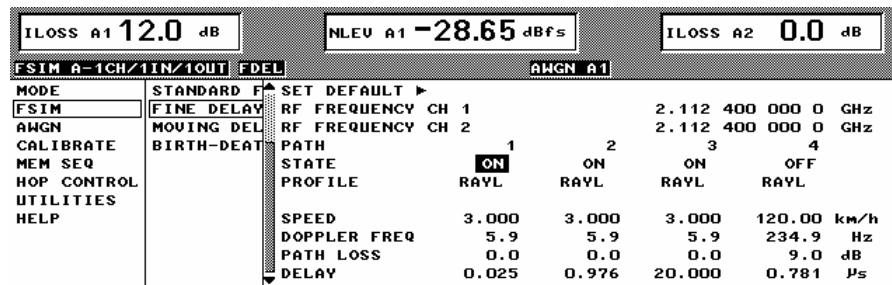

Fig. 23 SMIQ Fading Profile

Note: The minimum possible delay on the SMIQ is 25ns.

Correction and Test with 3GFadLevCor

This section contains a step by step guide to correct the **CABLE LOSS DL**, **CABLE LOSS UL**, and **CREST FACTOR COMP** with 3GFADLEVCOR and prepare and perform a BLER measurement under conditions of fading as prescribed in the test specification 3GPP 34.121.

Correction

1. Connect the devices as shown in Fig.6.
2. Start **3GFADLEVCOR.EXE** and initialize all the devices (CMU, SMIQ and power meter / sensor) by pressing the **INIT** buttons in the **DEVICES** menu.
3. Press the **CORRECT DL** button in **3GFADLEVCOR**.
4. Press the **CORRECT CF** button in **3GFADLEVCOR**.
5. Optionally measure the **CABLE LOSS UPLINK** and enter the value in the appropriate **3GFADLEVCOR** control.

Test

6. Connect the devices as shown in Fig.5.
7. Enter the desired **DOWNLINK CHANNEL** (e.g. 10562 = 2112.4 MHz). The SMIQ is automatically set to the same frequency.

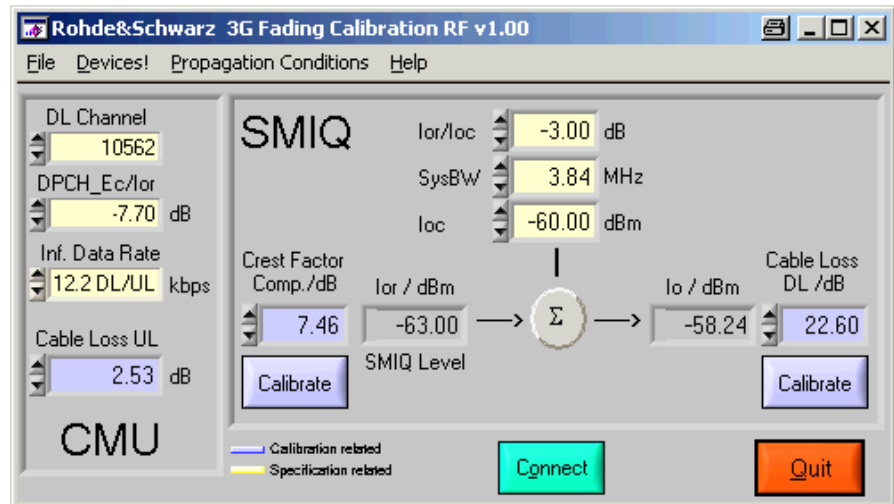

Fig. 24 3GFadLevCor Setup

8. In **3GFADLEVCOR** select the desired fading profile, e.g. **PROPAGATION CONDITIONS -> MULTI-PATH FADING PROPAGATION -> CASE 2, SPEED 3 KM/H**. The program automatically updates the dependent values.

9. On the CMU200 select the BLER test by choosing **MENU SELECT -> 3G UMTS USER EQUIPMENT -> WCDMA_{FDD}-UE -> SIGNALING -> RECEIVER QUALITY -> BER**. Press **ENTER** to confirm the selection.

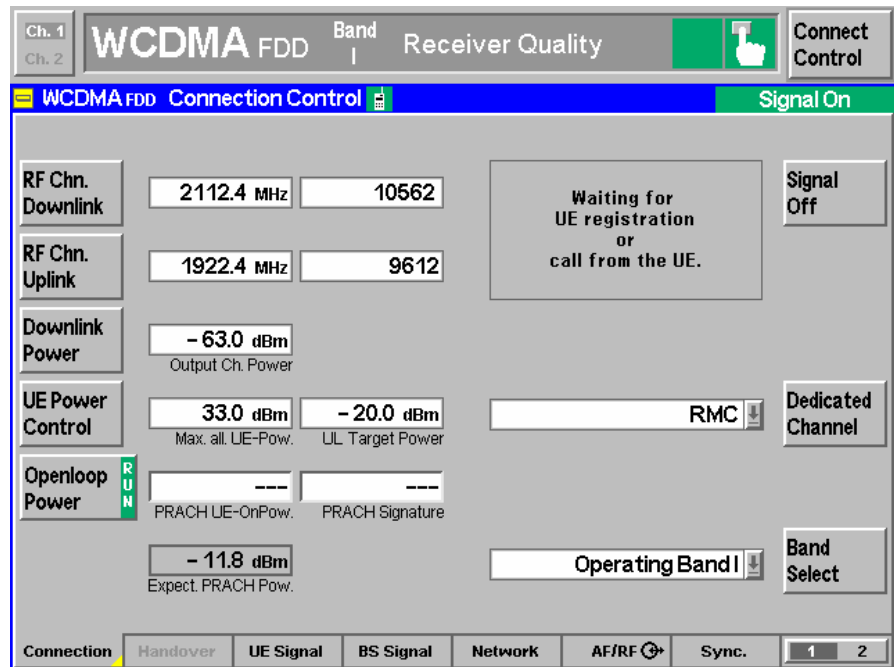

Fig. 25 WCDMAFDD Connection Control

10. Press the **CONNECT** button in **3GFADLEVCOR** to ease mobile registration and call establishment (turns SMIQ fading and AWGN OFF).

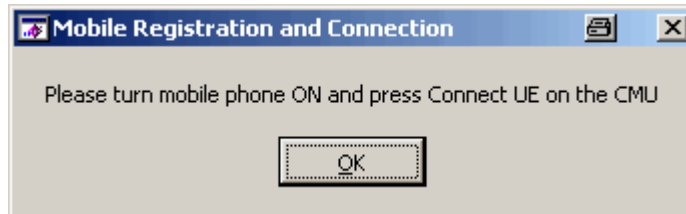

Fig. 26 Mobile Registration and Connection

11. Register the mobile by switching the power on.
12. Establish a connection by pressing **CONNECT UE** on the CMU.
13. In the **MOBILE REGISTRATION AND CONNECTION** window of **3GFADLEVCOR** press **Ok** to continue (turns SMIQ fading and AWGN ON).
14. The resulting BER / BLER / DBLER is displayed on the CMU.

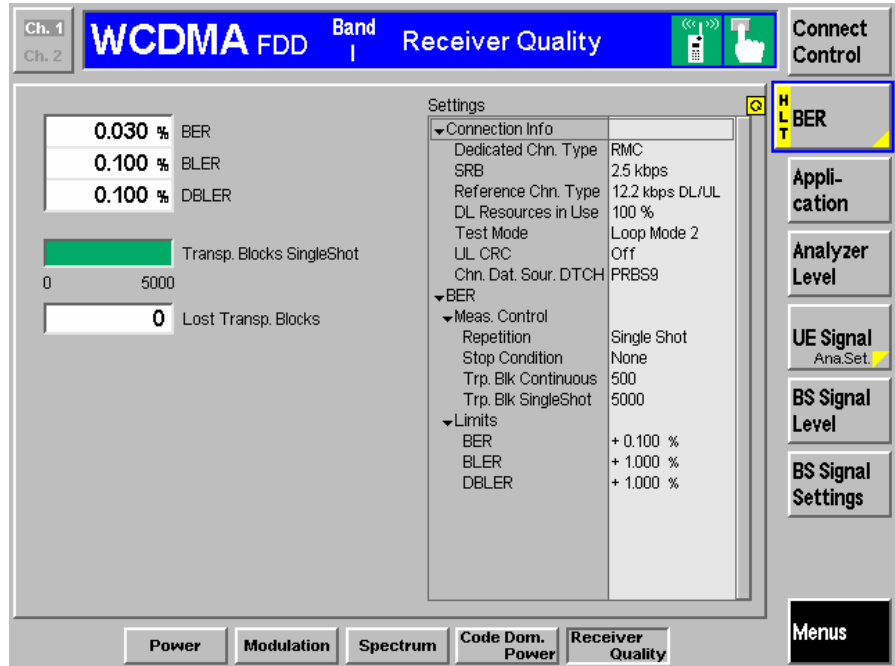

Fig. 27 BLER Measurement

Measuring BLER Characteristic

While the specification mainly applies for production tests, developers may need more information, such as the BLER vs. Ior/Ioc characteristic in order to classify devices more easily. The test below was configured as TS 34.121, Case 2, Test 5 with varying Ior/Ioc (-3...+12dB) and constant Ioc (-51 dBm). The measurement was performed with a CMU200, SMIQ and a standard 3GPP/UMTS mobile phone.

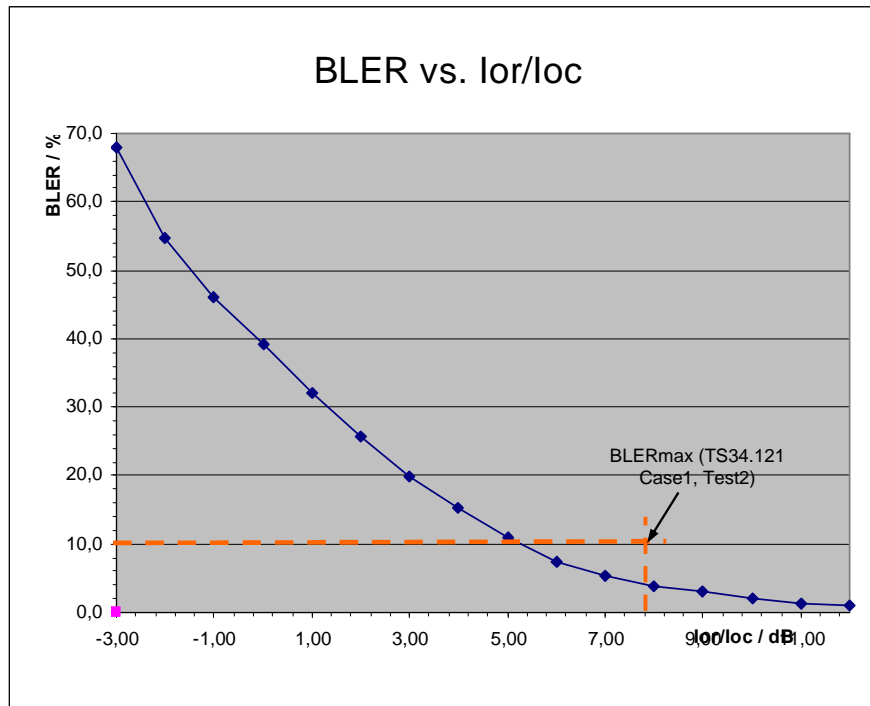

Fig. 28 BLER vs. Ior/Ioc

7 Additional Information

Please contact TM-Applications@rsd.rohde-schwarz.com for comments and further suggestions.

8 Ordering information

Communication Tester		
CMU 200		1100.0008.02
Vector Signal Generator		
SMIQ02B	(300 kHz to 2.2 GHz)	1125.5555.02
SMIQ03B	(300 kHz to 3.3 GHz)	1125.5555.03
SMIQ03HD	(300 kHz to 3.3 GHz)	1125.5555.33
SMIQ04B	(300 kHz to 4.4 GHz)	1125.5555.04
SMIQ06B	(300 kHz to 6.4 GHz)	1125.5555.06
Power Meter		
NRP	Power Meter	1143.8500.02
NRP-Z11	Power Sensor	1138.3004.02
NRP-Z21	Power Sensor	1137.6000.02
NRP-Z22	Power Sensor	1137.7506.02
NRP-Z23	Power Sensor	1137.8002.02
NRP-Z24	Power Sensor	1137.8502.02
NRVD	Power Meter	0857.8008.02
NRVS	Power Meter	1020.1809.02
Options		
CMU-B17	IQ-IF Interface	1100.6906.02
CMU-U65	Measurement DSP for WCDMA / CDMA200 - upgrade kit	1100.7402.02
CMU-B68	Layer-1 Board (3GPP/FDD,DL+UL)	1149.9809.02
CMU-B56	3GPP Signalling Unit	1150.1850.14
CMU-B21	Univ. Signalling Unit (3GPP Hardw.)	1100.5200.14
CMU-PK60	Softw. Package-3GPP/FDD/UE, TX-Test Gen. Band 1+2+3+4+5+6	1159.3355.02
SMIQ-B14	Fading simulator 6 path, mandatory	1085.4002.02
SMIQ-B15	2nd Fading simulator, mandatory	1085.4402.02
Accessories		
CMU-Z10	Antenna Coupler	1150.0801.02
CMU-Z11	Shielded Chamber for Mobile Stations	1150.1008.02



ROHDE & SCHWARZ

ROHDE & SCHWARZ GmbH & Co. KG · Mühlhofstraße 15 · D-81671 München · P.O.B 80 14 69 · D-81614 München
Telephone +49 89 4129 -0 · Fax +49 89 4129 - 13777 · Internet: <http://www.rohde-schwarz.com>

This application note and the supplied programs may only be used subject to the conditions of use set forth in the download area of the Rohde & Schwarz website.