

# IEEE 802.16m

## Technology Introduction, White Paper

IEEE 802.16m is an amendment to the released IEEE802.16-2009 Standard. The goal set out in 802.16m is to develop an advanced air interface to meet the requirements for IMT-Advanced next generation networks while still supporting legacy 802.16 OFDMA system.

This white paper will focus on some of the key features of 16m and provide comparisons to the 802.16-2009 OFDMA PHY (also referred to as 16e.) with explanations of the motivations behind for the advanced features in 802.16m

# Table of Contents

<b>1</b>	<b>Introduction .....</b>	<b>4</b>
<b>2</b>	<b>IMT Advanced.....</b>	<b>5</b>
<b>3</b>	<b>Differences between 802.16m and 802.16e .....</b>	<b>6</b>
3.1	Overview.....	6
3.2	Physical Layer .....	8
3.2.1	OFDMA parameters .....	8
3.2.2	Bandwidth and Bands.....	9
3.2.2.1	Targeted Bands .....	9
3.2.2.2	Multi carrier operation .....	9
3.2.2.3	Reduced guard bands.....	11
3.2.2.4	Use of 802.16m guard subcarriers .....	12
3.2.2.5	Practical scenarios of multi carrier operation.....	14
3.2.3	Frame structure .....	15
3.2.3.1	Legacy support.....	15
3.2.3.2	Superframe.....	18
3.2.3.3	FDD Frame Structure .....	19
3.2.3.4	TDD Frame Structure .....	20
3.2.4	Resource Units .....	21
3.2.4.1	Physical resource unit (PRU).....	22
3.2.4.2	PRU to LRU mapping .....	24
3.2.5	pilots in 802.16m .....	25
3.2.5.1	TDD pilots in the DL PRU .....	26
3.2.5.2	TDD pilots in the UL PRU .....	28
3.2.5.3	Common and dedicated pilots .....	28
3.2.6	MIMO.....	29
3.2.6.1	MIMO modes .....	30
3.2.6.2	MIMO architecture .....	31
3.2.6.3	MIMO Feedback .....	32
3.2.7	Control channels .....	33
3.2.7.1	DL control channels .....	33
3.2.7.2	UL control channels .....	35
3.3	MAC Layer.....	36

<b>3.4</b>	<b>Further Implementations in 802.16m.....</b>	<b>36</b>
<b>3.5</b>	<b>Certification.....</b>	<b>36</b>
<b>4</b>	<b>Measurements .....</b>	<b>37</b>
<b>5</b>	<b>Conclusion.....</b>	<b>37</b>
<b>6</b>	<b>References.....</b>	<b>37</b>
<b>7</b>	<b>Additional Information.....</b>	<b>37</b>
<b>8</b>	<b>Glossary.....</b>	<b>38</b>
<b>9</b>	<b>Index.....</b>	<b>40</b>

# 1 Introduction

The 802.16m standard is an amendment to the 802.16-2009 standard and the next step of the WiMAX™ air interface development after 802.16e. 802.16m was submitted as a worldwide IMT-Advanced standard to the ITU and meets their requirements.

The most important applications, of IMT-Advanced systems are:

- voice
- mobile Internet
- gaming

While voice has already been implemented in today's cellular systems with good Quality of Service (QoS), the new applications like mobile Internet and gaming require advanced support of the IMT-Advanced systems.

For mobile Internet, enormous data rates are required. The IMT-Advanced systems support 1Gbit/s in low mobility scenarios.

For gaming very fast system reaction times, which are usually measured with the round trip time (RTT) of a packet are required. The IMT-Advanced systems support round trip times of 10ms.

WiMAX offers also a QoS, which is required for voice applications. The coding of voice is not defined in the IEEE standard, as this is done in higher layers. The recommended voice coders for WiMAX are working perfectly.

To reach these requirements, 802.16m introduced:

- multicarrier operation for higher data rates
- extended MIMO support for higher data rates
- superframe structure for higher data rates

The 802.16m standard is currently under development and available as a draft. This means that changes, corrections, and additions are ongoing. However, it is possible to provide high level descriptions of the key PHY and MAC layer features. Note: 802.16m specifies only the PHY and the MAC and not the higher layers of the system.

## 2 IMT Advanced

The International Telecommunications Union (ITU) releases worldwide operation bands used by mobile Telecommunication systems. Currently the IMT-2000 systems are in operation. New applications and user demand for higher throughput are pushing operators to provide higher data rates using spectrally efficient technologies. ITU, therefore, is addressing these needs with IMT-Advanced systems. 802.16m and LTE-Advanced were submitted in October 2009, to answer the requirements for IMT-Advanced.

The IMT-Advanced requirement is a maximum data rate of 1GB/s in low mobility scenarios for the telecommunication system, which is reached by 802.16m and LTE-Advanced. Further requirements are for example the 100 MHz bandwidth support or the round trip time of 10ms.

Main Milestones for IMT-Advanced are:

Milestone	Date
Issued invitation to propose Radio Interface Technologies.	March 2008
ITU date for cutoff for submission of proposed Radio Interface Technologies.	October 2009
Cutoff date for evaluation report to ITU.	June 2010
Decision on framework of key characteristics of IMT Advanced Radio Interface Technologies.	October 2010
Completion of development of radio interface specification recommendations.	February 2011

**Table 1: IMT-Advanced Roadmap**

## 3 Differences between 802.16m and 802.16e

### 3.1 Overview

802.16m has implemented different features for reaching several goals. One of the major goals is the increase of the data rate, which is also described in the IMT-Advanced system requirements. For using the IMT FDD bands, another goal is the enhanced FDD support beginning in WiMAX from Release 1.5. Table 2 provides an overview of the key 802.16m PHY features while Table 3 shows the 802.16m general system requirements for IMT-Advanced.

Feature	IEEE 802.16m	IEEE 802.16e
MIMO / Antenna configuration	DL: 2x2 (baseline), 2x4, 4x2, 4x4, 8x8, 4x8 UL: 1x2 (baseline), 1x4, 2x4, 4x4	DL: <b>1x1 (baseline), 1x2, 2x1,</b> 2x2, 2x4, 4x2, 4x4, 8x8, 4x8 UL: <b>1x1 (baseline),</b> 1x2, 1x4, 2x4, 4x4
Operating bandwidth	5 to 20 MHz per carrier <b>carrier aggregation to achieve bandwidths up to 100 MHz</b>	5 to 20 MHz one carrier
Frame length	<b>Fixed Frame length 5ms with Superframes (20ms), including 4 Frames</b>	Variable Frame length 2ms up to 20ms, without Superframes
Duplex scheme	TDD, FDD, H-FDD (MS)	TDD, FDD, H-FDD (MS)

**Table 2: Physical System Requirements for 802.16m**

802.16e already supported TDD and over Hybrid FDD (H-FDD) also finally FDD. As 802.16m has already supported TDD and FDD from the beginning, H-FDD may not play an important role in 802.16m.

feature	IEEE 802.16m
backwards compatibility legacy support	802.16m only 802.16e only in the legacy mode 802.16e and 802.16m in parallel in the mixed mode LZone for legacy / 802.16e and MZone for 802.16m access
coexistence / interworking	flexible frame concept, Co Located Coexistence (CLC) for time sharing and handover capability to coexist and interwork with other radio access technologies
cell range and coverage	optimal performance up to 5 km graceful degradation up to 30 km connectivity up to 100 km
mobility	optimal performance up to 10 km/h (stationary, pedestrian) graceful degradation up to 120 km/h (vehicular) connectivity up to 350 km/h (high speed vehicular)
latency	user-plane: 10 ms (one-way packet transmit time) control-plane: 100 ms (idle to active time)
peak data rate	DL 300 Mbit/s / 20 MHz; DL: > 15.0 bps/Hz (4x4) UL 135 Mbit/s / 20 MHz ; UL: > 6.75 (2x4)
VoIP capacity	> 60 active users/MHz/sector (DL 2x2 and UL 1x2)

**Table 3: General System Requirements for 802.16m**

The 802.16e zone is also referred to as legacy zone (LZone).

The 802.16m roadmap is aligned with the IMT-Advanced roadmap. In detail the following 802.16m milestones are planned.

802.16m milestones	date
802.16m standard released	End 2010
profile certification start	End 2011
commercial launch	2012

**Table 4: 802.16m roadmap**

## 3.2 Physical Layer

This chapter describes the general parameters of The Advanced Air Interface (AAI) of the standard 802.16m compared to the standard 802.16e with a release 1.0 profile.

### 3.2.1 OFDMA parameters

The OFDMA parameters in 802.16m are the same as the defined profiles in 802.16e, which are shown in Table 5.

nominal channel bandwidth, $BW$ (MHz)			5	7	8.75	10	20
sampling factor, $n$			28/25	8/7	8/7	28/25	28/25
sampling frequency, $F_s$ (MHz)			5.6	8	10	11.2	22.4
FFT size, $N_{FFT}$			512	1024	1024	1024	2048
subcarrier spacing, $\Delta f$ (kHz)			10.94	7.81	9.77	10.94	10.94
useful symbol time, $T_b$ ( $\mu$ s)			91.4	128	102.4	91.4	91.4
CP ratio, $G=1/4$	OFDMA symbol time $T_s$ ( $\mu$ s)		114.286	160	128	114.286	114.286
	FDD	number of OFDMA symbols per 5ms frame	43	31	39	43	43
		idle time ( $\mu$ s)	85.694	40	8	85.694	85.694
	TDD	number of OFDMA symbols per 5ms frame	42	30	38	42	42
		TTG + RTG ( $\mu$ s)	199.98	200	136	199.98	199.98
CP ratio, $G=1/8$	OFDMA symbol time $T_s$ ( $\mu$ s)		102.857	144	115.2	102.857	102.857
	FDD	number of OFDMA symbols per 5ms frame	48	34	43	48	48
		idle time ( $\mu$ s)	62.857	104	46.40	62.857	62.857
	TDD	number of OFDMA symbols per 5ms frame	47	33	42	47	47
		TTG + RTG ( $\mu$ s)	165.714	248	161.6	165.714	165.714
CP ratio, $G=1/16$	OFDMA symbol time $T_s$ ( $\mu$ s)		97.143	136	108.8	97.143	97.143
	FDD	number of OFDMA symbols per 5ms frame	51	36	45	51	51
		idle time ( $\mu$ s)	45.71	104	104	45.71	45.71
	TDD	number of OFDMA symbols per 5ms frame	50	35	44	50	50
		TTG + RTG ( $\mu$ s)	142.853	240	212.8	142.853	142.853

**Table 5: 802.16m OFDMA parameters**

Only the cyclic prefix value of 1/32, which was supported in 802.16e is not used any more in 802.16m.



## 3.2.2 Bandwidth and Bands

802.16m targets today's frequency bands that are used in 802.16e as well as new bands, which are allocated in IMT systems, as described in 3.2.2.1 Targeted Bands

802.16e supported bandwidths up to 20 MHz. With carrier aggregation, 802.16m can use bandwidths up to 100 MHz as described in 3.2.2.2 Multi carrier operation.

Last but not least, the guard bands of the 802.16m system can be used for data transmission.

On one hand the guard band itself is reduced in 802.16m which is described in chapter 3.2.2.3 Reduced guard bands.

On the other hand the guard bands can be used completely, when the neighbor system is a WiMAX system, which is described in 3.2.2.4 Use of 802.16m guard subcarriers.

Finally this flexible usage of bands gives operators a huge number of possible implementations. As WiMAX has not currently defined example scenarios for the used bands, the chapter 3.2.2.5 Practical scenarios of multi carrier operation describes the current LTE-Advanced scenarios.

### 3.2.2.1 Targeted Bands

802.16e was already an official IMT-2000 standard. As the official candidate for IMT-Advanced, 802.16m can be used for IMT-2000 and IMT-Advanced, TDD and FDD bands.

The targeted frequency bands are:

- 450 MHz – 470 MHz (IMT-2000)
- 698 MHz – 960 MHz (also 802.16e R1.0 target)
- 1710 MHz – 2025 MHz (IMT-2000)
- 2110 MHz – 2200 MHz (IMT-2000)
- 2300 MHz – 2400 MHz (also 802.16e R1.0 target)
- 2500 MHz – 2690 MHz (also 802.16e R1.0 target)
- 3400 MHz – 3600 MHz (also 802.16e R1.0 target)

Through the use of the IMT frequency bands, WiMAX user terminals can have access all around the world.

### 3.2.2.2 Multi carrier operation

To increase the data rate, 802.16m adds a multi carrier operation so that an 802.16m base station and an 802.16m mobile station are able to use more than one carrier to transfer data. These carriers may be located contiguous or distributed. Multi carrier operation is also called multi band or multi carrier aggregation.

The multi carrier operation supports up to 100 MHz in contiguous or non contiguous scenarios.

The figure below shows an example of three contiguous and 3 non-contiguous carriers used for 802.16m.

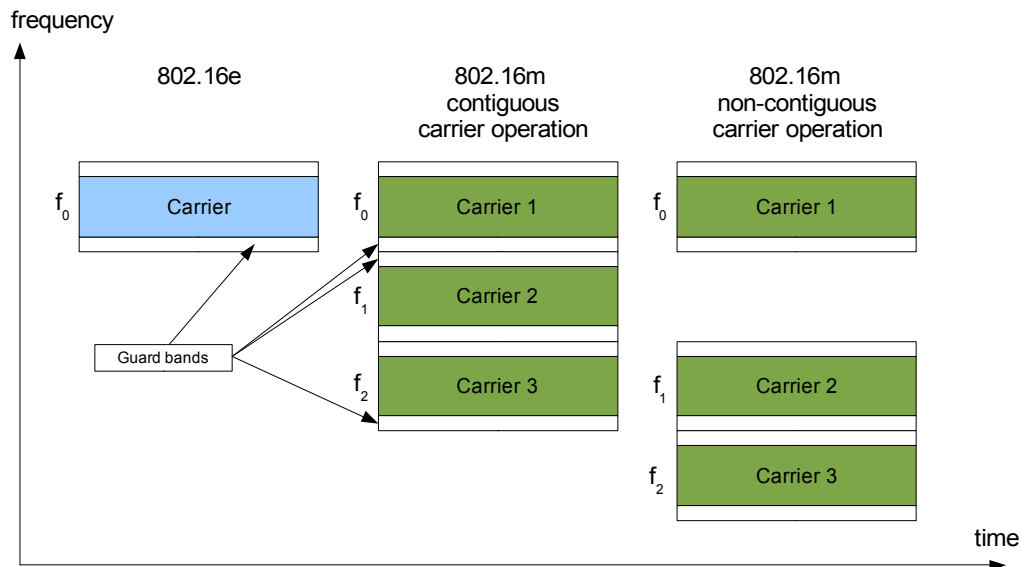

**Figure 1: Multicarrier operation of 802.16m vs. 802.16e single carrier operation**

Multi carrier operation increases the data rate. Additionally the guard bands of contiguous carriers can be used for data transmission, which is described in the next chapters.

### 3.2.2.3 Reduced guard bands

802.16m implemented two mechanisms for using the guard bands for data transmission.

First the guard bands are reduced by themselves, which is described in this chapter, and secondly the guard bands can be filled up with data carriers, which are described in the next chapters.

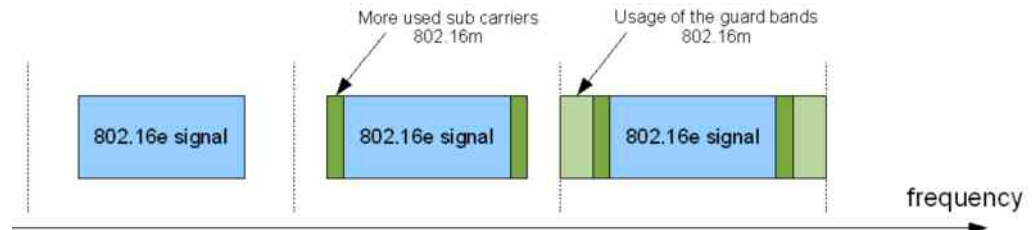

**Figure 2: different usage of the guard bands for data in 802.16m**

Table 6 shows the guard sub carriers and the used sub carriers of 802.16m, which have increased the data throughput of an 802.16m system compared to an 802.16e system. For the 10 MHz bandwidth, also the 802.16e number of guard carriers is listed (marked light blue).

Nominal channel bandwidth, <i>BW</i> (MHz)		5	7	8.75	10 (16m)	10 (16e)	20
Number of Guard Sub-Carriers	Left	40	80	80	80	92	160
	Right	39	79	79	79	91	159
Number of Used Sub-Carriers		433	865	865	865	841	1729
Number of Physical resource Unit (18x6) in a type-1 sub-frame		24	48	48	48	60 (cluster 14x2)	96

**Table 6: 802.16m guard bands**

By reducing the guard bands, the clusters of 802.16e (14 carriers) do not fit into the number of used sub carriers of 802.16m. This is one reason, why new physical resource units (PRUs) with 18 carriers have been defined. They fit into the new number of data carriers.

### 3.2.2.4 Use of 802.16m guard subcarriers

When two WiMAX bands are located contiguously (adjacent), 802.16m can use the guard band additionally for data transmission.

Figure 2 shows the guard band usage of 802.16m, when an 802.16e signal is adjacent and when an 802.16m signal is 802.16m supports a mixed mode operation between 802.16m and 802.16e, which is described in chapter: 3.2.3.1.

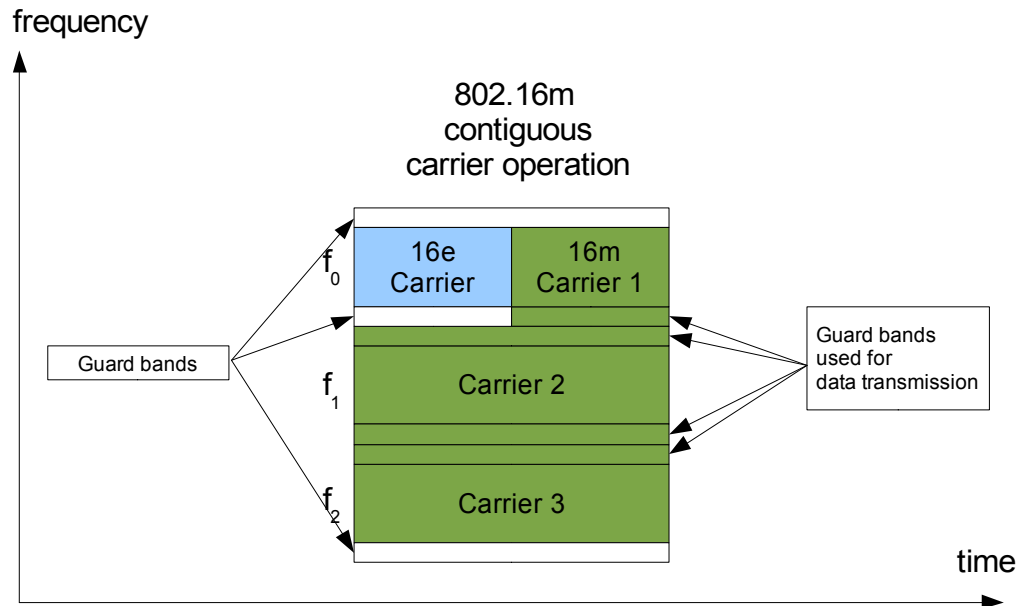
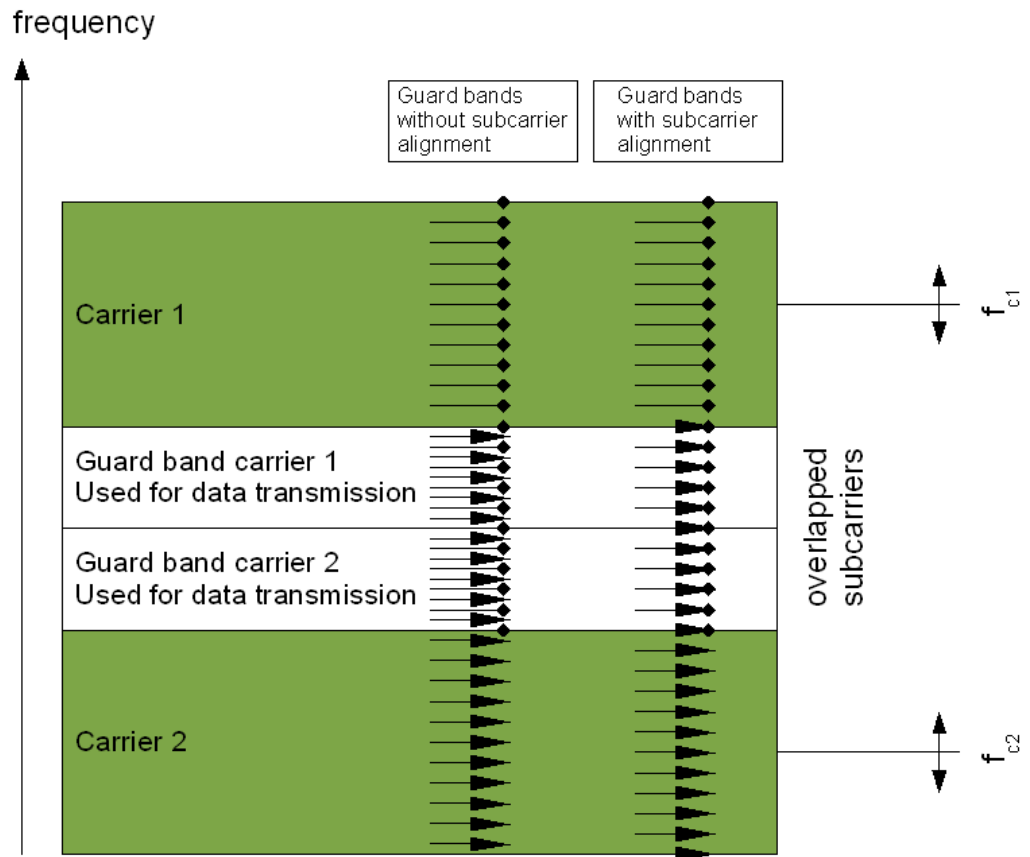

Figure 3: 802.16m multicarrier operation with usage of the guard bands

The guard bands between two contiguous 802.16m carriers can be used for data transmission.

The closer insight of the carrier allocation between two 16m bands, show the following figure inside the 802.16m draft standard.



**Figure 4: Alignment of the subcarriers in the guard band of 2 contiguous bands**

They want to align the carriers in the guard band of two contiguous bands in the frequency domain.

This alignment would help, if the calculation of two bands is done in one big FFT. Technically it also may also be useful, when every transmitter transmits the carriers up to band limit.

### 3.2.2.5 Practical scenarios of multi carrier operation

To increase the flexibility for operators and users, multi carrier operation is possible in one or many different frequency bands.

As WiMAX 802.16m has not yet specified multi carrier scenarios for practical use, LTE-Advanced deployment scenarios for multi carrier aggregation are shown here.

Out of the 11 scenarios for TDD and FDD operation, 4 have been selected with high priority. These are No 1, 2, 7 and 10 and in the following table marked as yellow.

Scenario No.	Deployment scenario	Transmission BWs	No of component carriers	Used Bands	Duplex modes
1	single band, contiguous allocation	UL: 40 MHz DL: 80 MHz	UL: contiguous 2x20 MHz DL: contiguous 4x20 MHz	3.5 GHz	FDD
2	single band, contiguous allocation	100 MHz	contiguous 5x20 MHz	2.3 GHz (Band 40)	TDD
3	single band, contiguous allocation	100 MHz	contiguous 5x20 MHz	3.5 GHz	TDD
4	single band, non-contiguous allocation	UL: 40 MHz DL: 80 MHz	UL: non-contiguous 20 + 20 MHz DL: non-contiguous 2x20 + 2x20 MHz	3.5 GHz	FDD
5	single band, non-contiguous allocation	UL: 10 MHz DL: 10 MHz	UL / DL: non-contiguous 5 + 5 MHz	900 MHz (Band 8)	FDD
6	multi band, non-contiguous allocation	80 MHz	non-contiguous 2x20 + 2x20 MHz	2.6 GHz (Band 38)	TDD
7	multi band, non-contiguous allocation	UL: 40 MHz DL: 40 MHz	UL / DL: non-contiguous 10 MHz Band 1 10 MHz Band 3 20 MHz Band 7	1.8 GHz (Band 3) 2.1 GHz (Band 1) 2.6 GHz (Band 7)	FDD
8	multi band, non-contiguous allocation	30 MHz	UL / DL: non-contiguous 15 MHz Band 1 15 MHz Band 3	1.8 GHz (Band 3) 2.1 GHz (Band 1)	FDD
9	multi band, non-contiguous allocation	UL: 20 MHz DL: 20 MHz	UL / DL: non-contiguous 10 MHz Band 1 10 MHz Band 3	800 MHz 900 MHz (Band 8)	FDD
10	multi band, non-contiguous allocation	90 MHz	non-contiguous 2x20 + 10 + 2x20 + 10 MHz	1.8 GHz (Band 39) 2.1 GHz (Band 34) 2.3 GHz (Band 40)	TDD
11	single band, contiguous allocation	UL: 20 MHz DL: 40 MHz	UL: contiguous 1x20 MHz DL: contiguous 2x20 MHz	2.6 GHz (Band 7)	FDD

**Table 7: multi carrier scenarios for LTE**

The physical parameters of each carrier can be measured independently, because each band has its own pilots with complete 802.16m signaling. For the case, that the guard bands are additionally used for data transmission, an Analysis of one carrier only may not be useful and feasible.

The newest developments in LTE-Advanced show a focus in the beginning on 2 carrier operation, so most companies may focus in the first step on a 2 carrier operation.

After the description of the frequency domain of the 802.16m signal, the frame structures, which describe the 802.16m signal in time domain, are the topic of the next chapter.

### 3.2.3 Frame structure

802.16m could simplify the frame structure compared to in 802.16e. The frame length in 802.16m is defined by the standard to be 5 ms. In 802.16e the frame length was flexibly from 2 ms to 20 ms. So the implementation can be done less flexible and more efficient.

With the 5 ms frame length, 802.16m supports coexistence to other network systems such as LTE, which uses 5ms and 10ms frame lengths.

For large data transmission, 802.16m introduced a superframe of 20 ms containing 4 frames with 5 ms, which is described in chapter: 3.2.3.3 Superframe.

A backwards compatibility to 802.16e (legacy) is supported in the 802.16m frame structure. As all 802.16e profiles from the WiMAX Forum have a 5 ms frame length, the frame length of 802.16e is in line with the frame length of 802.16m.

In the next chapters details of the frame structure is described.

#### 3.2.3.1 Preamble

The 802.16m PA-preamble sequence length is always 216 bit long. The sequence depends on the bandwidth and is defined in the standard. The 216 bit sequence is mapped on 216 BPSK subcarriers. The equation to determine the subcarrier allocation is  $2k+41$  (where  $k=0$  to 215) => ie they are the 216 odd numbered subcarriers from 41 to 471. The PA Preamble is then boosted by a value that depends on the FFT size (2.3999 if 512 FFT; 3.4143 if 1024 FFT; 5.1320 if 2048 FFT)

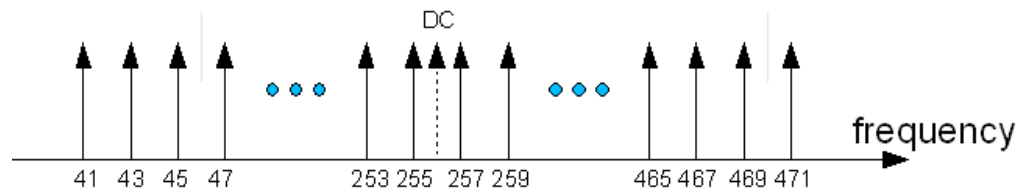
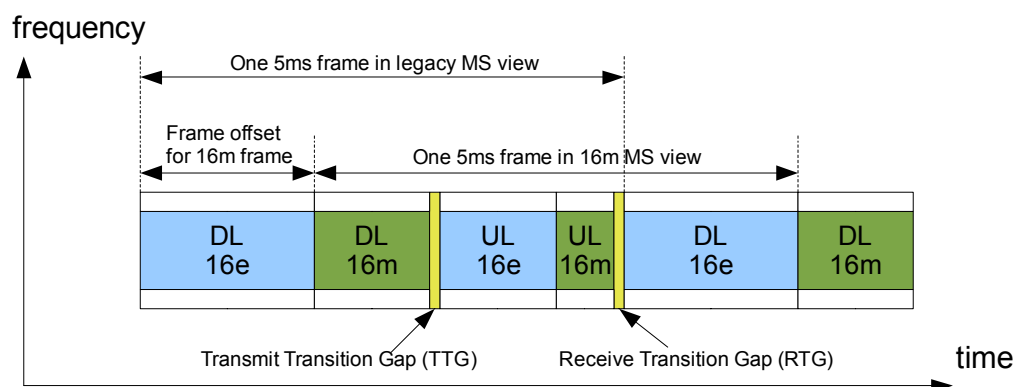

Figure 5:preamble 802.16m

### 3.2.3.2 Legacy support

The 802.16m mixed and legacy mode supports the backwards compatibility for 802.16e. In the legacy mode only 802.16e is supported, while in the mixed mode a parallel support of 802.16m and 802.16e can be applied for the first carrier. The 802.16e Zone is also referred to as legacy zone or LZone, the 802.16m Zone is also referred to as MZone.

Both, 802.16e and 802.16m have their own signaling procedures, like preamble and MAP and can work independent from each other.



**Figure 6: legacy support in 802.16m**

In the DL the first zone is the legacy zone followed by the 802.16m zone. In the UL, also the 802.16e signal is followed by the 802.16m Zone. Additionally TDM is supported in the UL, which is explained in the Figure 7.

The start of the 802.16e and 802.16m frames are separated.

The 802.16e frame starts with the legacy DL signal. The 802.16m frame starts with the 802.16m DL signal.

The frame length for both, 802.16m and 802.16e, is 5 ms.

The UL Zones of 802.16e and 802.16m may be organized in time division multiplex (TDM) or in frequency division multiplex (FDM).

The following figure shows the UL organized in TDM and FDM.



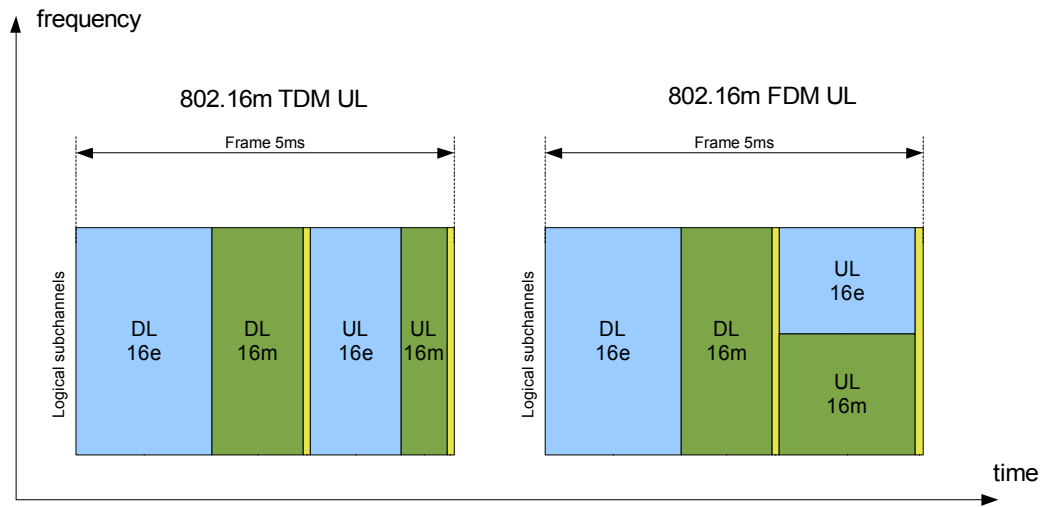

Figure 7: Legacy TDD with TDM and FDM UL

In the following figure a detailed overview about an 802.16m Legacy TDD frame is shown with FDM Uplink.

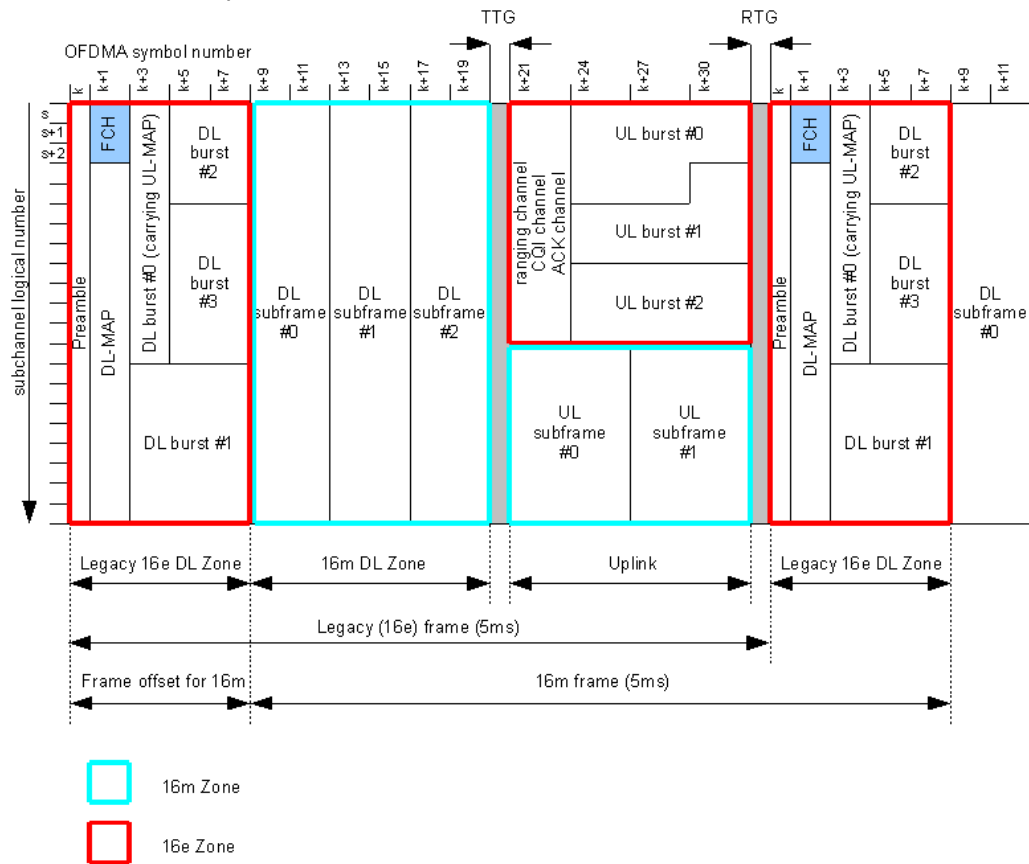
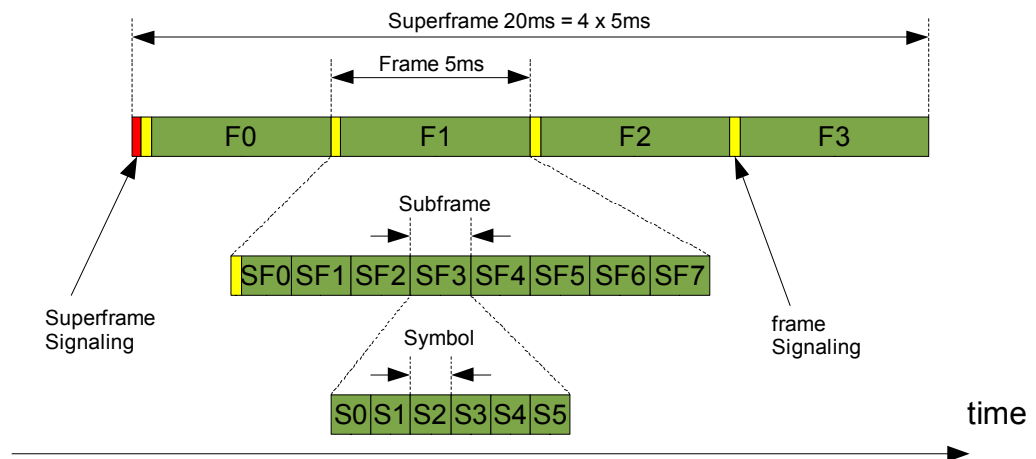

Figure 8: 802.16m TDD legacy frame with FDM UL

### 3.2.3.3 Superframe

802.16m introduced a new superframe structure for large data packages. A superframe (20ms) contains 4 single 5ms frames. So the control information can also be divided into long term and short term control information. Long term control information like the used carriers from the base station can be transmitted once in a superframe. Short term control information, like channel conditions, can be transmitted in each frame.

When legacy (802.16e) is implemented, the frame length of the 802.16e signals is 5 ms, while 802.16m can use additionally to the frame length of 5 ms the superframe length of 20 ms.



**Figure 9: superframe structure in 802.16m**

With the superframe structure, 802.16m can transmit some control information with larger repetition times. An example here is the antenna configuration of a BS. By doing so, the overhead can be reduced and the effective data rate can be increased.

### 3.2.3.4 FDD Frame Structure

802.16m supports TDD and FDD operation.

WiMAX started originally from TDD and has already gained a strong foothold in TDD operation. Having become a member of the IMT-2000 family, 802.16e continuously developed the FDD operation with Release 1.5 for the use of IMT-2000 FDD bands. 802.16m could further more enhance the FDD support.

The following example shows an FDD frame structure for 802.16m with a guard interval  $G=1/8$ . This frame structure is valid for the bandwidths 5, 10 and 20 MHz. The values for other FDD bandwidths are given in Table 6.

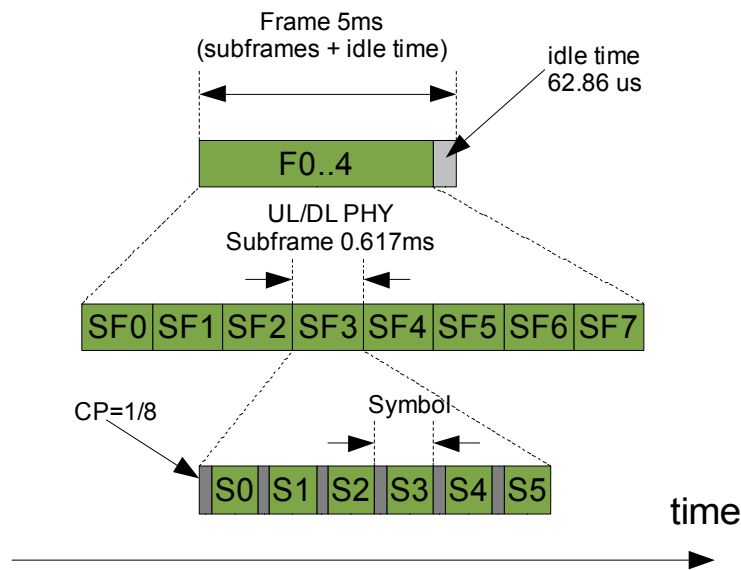

Figure 10: FDD frame structure of 802.16m for 5, 10 and 20 MHz

### 3.2.3.5 TDD Frame Structure

The following example shows a TDD frame structure for 802.16m with a guard interval  $G=1/8$ . This frame structure is valid for the bandwidths 5, 10 and 20 MHz. The DL:UL ratio for this example is 5:3 (DL + UL = 8).

The values for other TDD bandwidths are shown in Table 5.

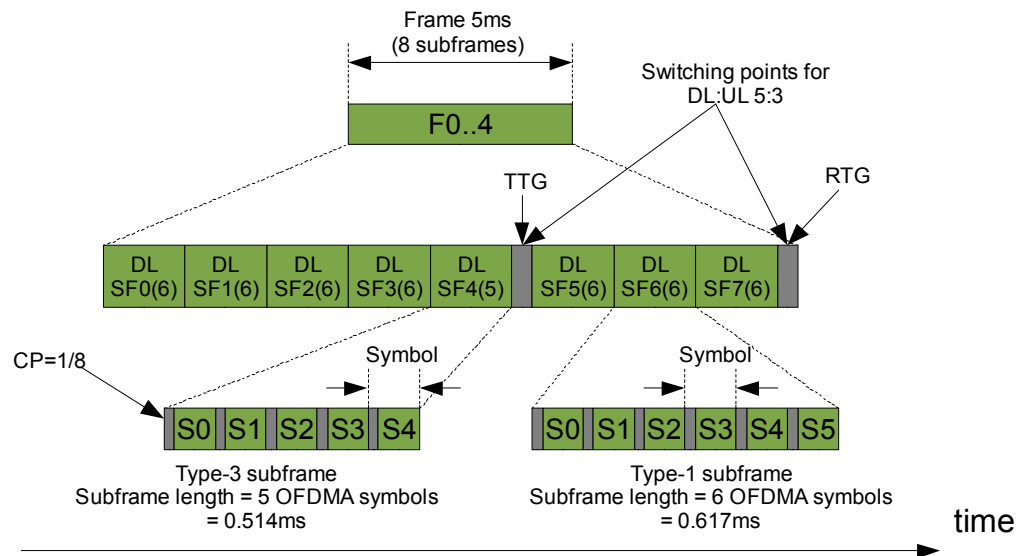

Figure 11: TDD frame structure of 802.16m for 5, 10 and 20 MHz

A frame may contain 5, 6, 7 or 8 subframes depending on bandwidth and CP. A subframe may contain 6, 7, 5 or 9 symbols (type-1, 2, 3, 4 subframes, respectively). Note that the type-4 subframe is only used in the uplink for the 8.75 MHz channel bandwidth when supporting a legacy 802.16e system.

TDD was the first and preferred duplex scheme from WiMAX. TDD has some advantages and disadvantages over FDD.

Advantages are:

- The relative DL and UL data rate is adjustable. This is especially reasonable for mobile internet applications. For voice, a synchronous DL / UL data rate is also applicable.
- UL and DL use the same frequency, channel sounding in one direction (UL) can also be used for the channel estimation of the reverse direction (DL).
- Only one band can be used for a complete transmission.

Disadvantages are:

- The implementation is more complex. The scheduling and interference has to be handled.
- Depending on the frame length, out of band spurious emissions appear.
- Between UL and DL a time gap has to be implemented, which reduces the data rate capacity.

With a fixed frame length of 5 ms with DL and UL included, the round trip time could reach values of 5 ms.

In the next chapter the basic resource unit in frequency (carriers) and time (symbols) is described.

### 3.2.4 Resource Units

802.16m implemented new physical resource units (PRU) for the DL and UL instead of tiles and slots like 802.16e. As 802.16m uses a smaller guard band, the number of data carriers shall be a multiple of the resource units in order to maximize the data throughput.

Also in time domain, the length of the signal has to be adjusted to the fixed 5 ms frame length. Defined signal times like Superframe header or guard times may have a different size in time like for TDD and FDD usage. So the resource units have to be adjustable in symbol length for maximizing the throughput. 802.16m introduced 4 different types of resource units in the Uplink and 3 different types of resource units in the Downlink with different symbol lengths, which are described in 3.2.4.1 Physical resource unit (PRU).

The Logical Resource Unit (LRU) has the same number of symbols and carriers (18) as the PRU. The PRU can be allocated to the LRU by mapping. LTE also uses Resource Units, which are different in size and uses a subframe length of 1ms.

### 3.2.4.1 Physical resource unit (PRU)

The logical resource unit (LRU) is the minimum and basic logical unit for resource allocation in the DL and UL. One LRU consists of 18 contiguous subcarriers ( $P_{sc}$ ) and 5, 6, 7 or 9 ( $N_{sym}$ ) consecutive OFDMA symbols. The 9 symbol length resource unit is defined for the Uplink only.

The physical resource unit (PRU) is equal in size to the LRU.

In Figure 12 the different PRU types with different symbol lengths are shown.

For more robustness against fading, the UL LRU can also be allocated to 3 distributed PRUs containing 6 subcarriers, which is shown in Figure 13.

802.16e supports other sizes for the PRU / LRU.

The PRU of 802.16m contains 18 carriers, while the 802.16e PRU or slot contains 14 carriers. As the total number of carriers has to be a multiple of the PRU, the PRU has to be changed. Be aware, that the wording of 802.16e with slots and tiles has changed to the wording in 802.16m with PRUs.

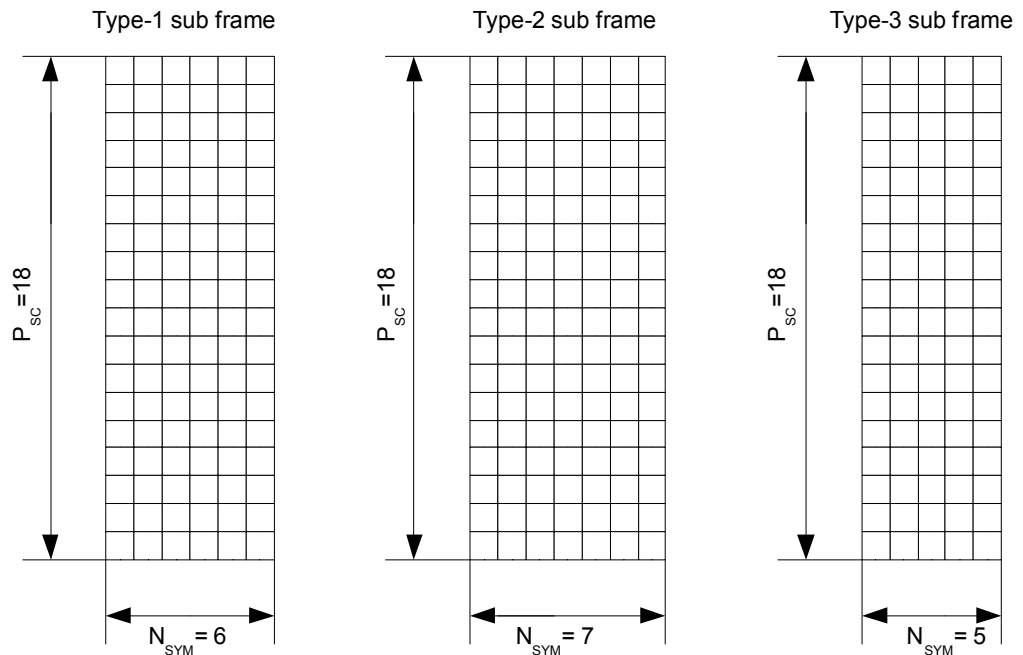
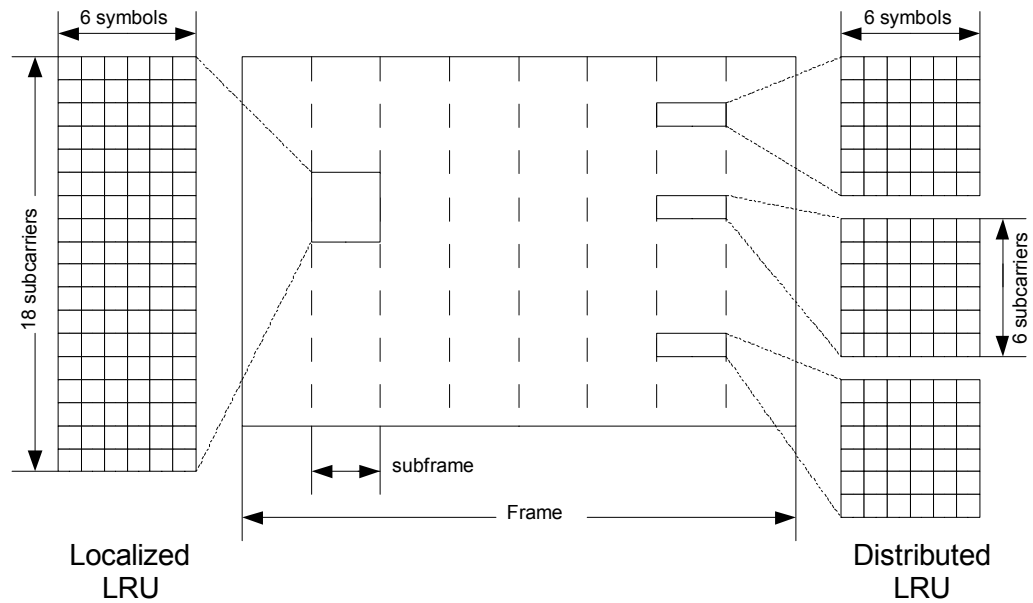

Figure 12: DL and UL physical resource unit

The physical Resource unit (PRU) consists of  $P_{sc} = 18$  contiguous subcarriers and  $N_{sym}$  consecutive OFDMA symbols with  $N_{sym} = 6, 7, 5, 9$  (type-1, 2, 3, 4 sub frame).

In the UL smaller PRUs are also defined, which are shown in Figure 13.



**Figure 13: UL logical resource units distributed and contiguous**

In the UL the LRU can be allocated distributed or contiguous in the frequency domain. When the UL LRU is allocated distributed, three similar PRUs are generated with different frequency partitions.

The figure below shows the distributed UL PRUs.

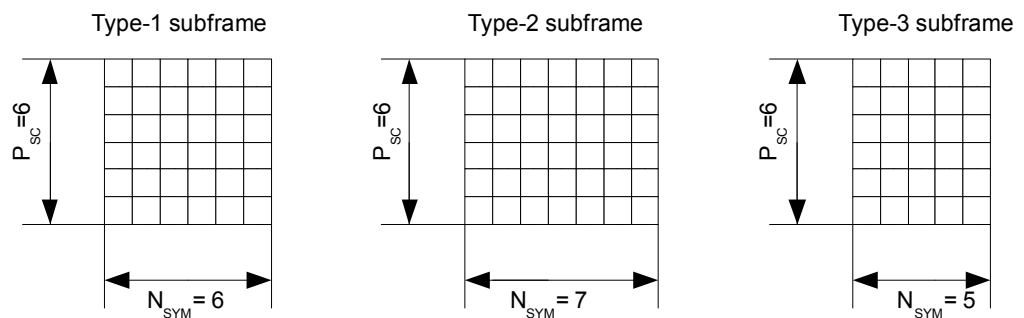

**Figure 14: UL physical resource unit partitions**

The contiguous logical resource unit achieves frequency selective gain and may be used for Beamforming.

The distributed logical resource unit achieves frequency diversity gain and may be used for transmissions with strong channel fading impact.

In this chapter the physical and logical resource units have been described. How they are mapped in relation to each other is described in the next chapter.

### 3.2.4.2 PRU to LRU mapping

The mapping between LRU and PRU describes different functionalities. Compared to 802.16e, 802.16m supports additionally fractional frequency reuse (FFR). By dividing the used frequencies into bands / partitions, the frequency reuse factor can be increased. FFR is also known as multi cell operation and in Figure 15 multi cell operation with FFR is illustrated.

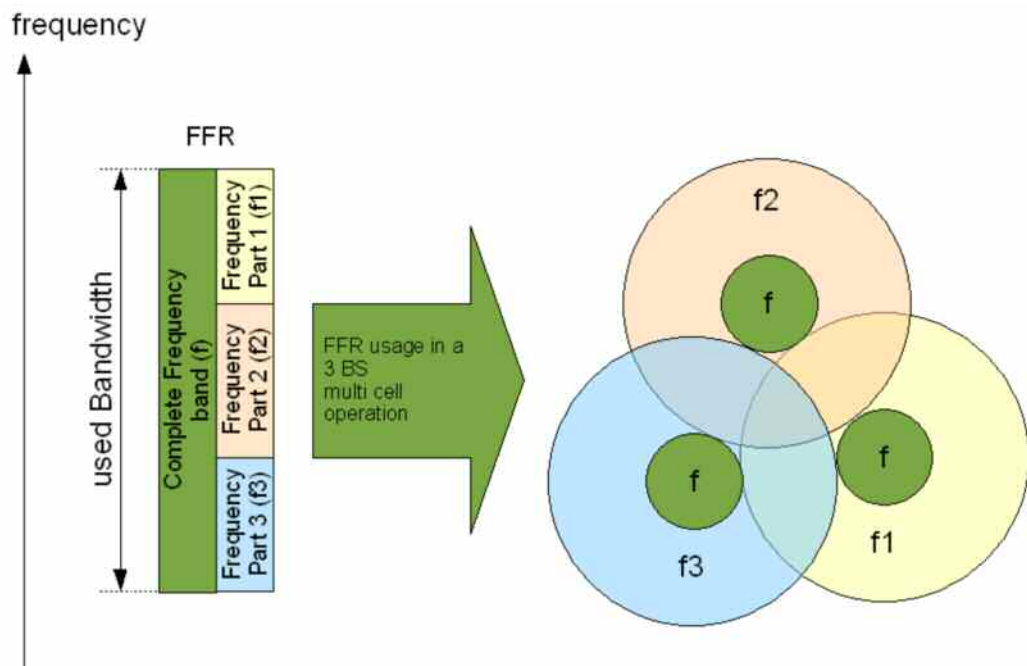

**Figure 15: multi cell operation with FFR**

In the multi cell operation, the frequency usage is optimized compared to the 802.16e system. As the used frequencies for multi cell operation do not change quickly, the mapping can be done with a slow algorithm. The outer permutation supports in mapping the slow changes, while the inner permutation is supporting the fast mapping algorithms, like needed in a fast multipath fading environment.

The mapping of 802.16m changed, because enhanced features are supported like fractional frequency reuse (FFR) and multicast / broadcast services. Additionally the size of the PRU changed compared to 802.16e.

In Figure 16 the mapping is illustrated with the outer permutation on the left and the inner permutation on the right.



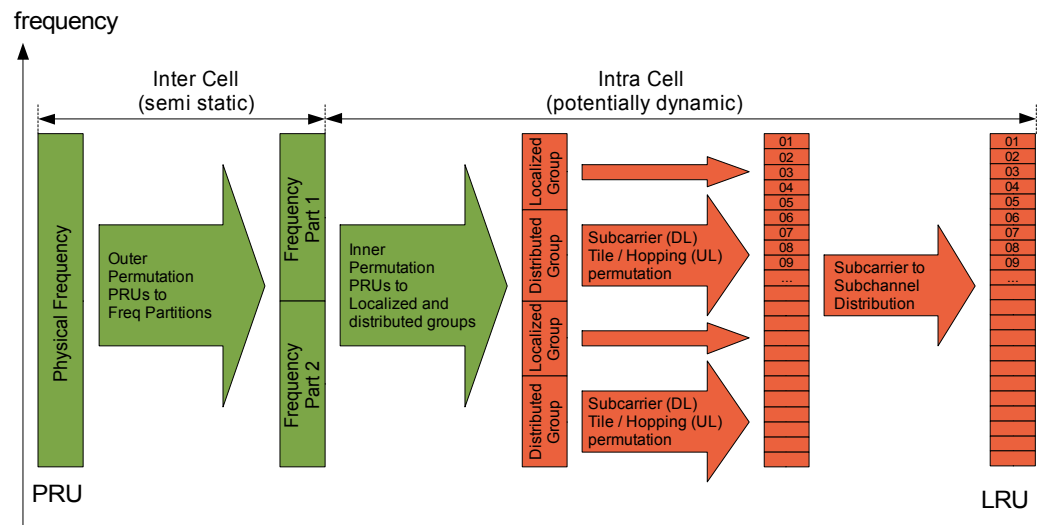

Figure 16: PRU to LRU mapping (DL, UL)

### 3.2.5 Pilots in 802.16m

The density of the pilots in frequency and time domain defines the maximum fading conditions like delay spread or Doppler under which the system still works. 802.16m implemented a fixed pilot pattern set per PRU. As the PRUs are very similar, the maximum channel fading conditions under which the system works are limited. The exception is the UL distributed pilot pattern, where the pilot density in the frequency domain is higher than in all other pattern sets.

Beside receiving channel information, the pilots are also located at different positions for distinguishing the different base stations or streams for MIMO.

Additionally the pilots in a dedicated area can be precoded for supporting e.g. Beamforming

In the next chapters the different pilot settings for 802.16m are described. As 802.16m also supports the 802.16e legacy mode, in the legacy Zone the pilot settings are the same as in 802.16e. 802.16e also supported a variable pilot set in FUSC. 802.16m does not support a variable pilot pattern set.

### 3.2.5.1 TDD pilots in the DL PRU

The distribution of the pilots is dependent on the number of BS antennas and on the neighbor cell pilot pattern. The pattern set 1 and 2 in Figure 17 are interlaced patterns for neighbor BSs. The pattern set 0 shows the pilot pattern set for one BS for 1 and 2 transmission streams.

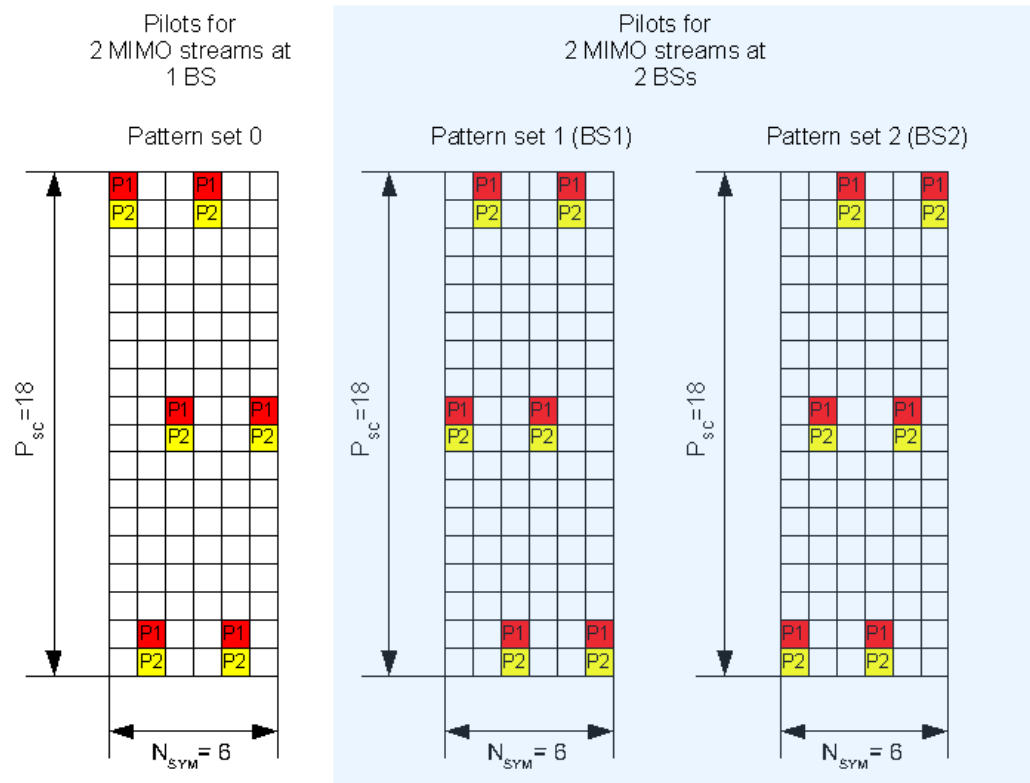

**Figure 17: DL pilot pattern for 1 and 2 transmission streams**

For subframes with different symbol length, symbols with pilots are added or deleted in the following way:

For type-2 subframes with 7 symbols, the 1<sup>st</sup> symbol is added as the 7<sup>th</sup> symbol.

For type-3 subframes with 5 symbols, the last symbol is deleted.

In the case of 4 transmission streams, the used pattern set is shown in the next figure.

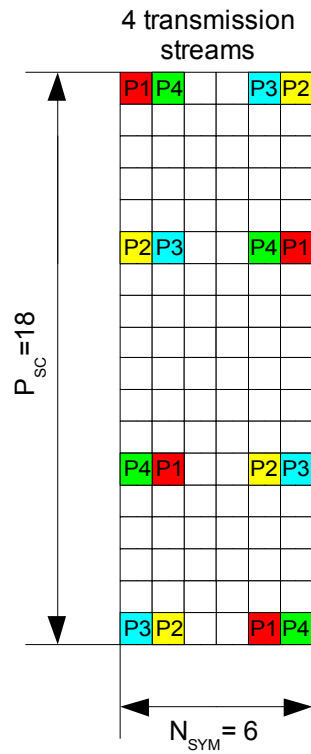

**Figure 18: DL pilot pattern for 4 transmission streams**

Also in this case, the pilot distribution for PRUs with different length is defined as followed:

For type-2 subframes with 7 symbols, the 3<sup>rd</sup> symbol is added as the 7<sup>th</sup> symbol.  
For type-3 subframes with 5 symbols, the 3<sup>rd</sup> symbol is deleted.

### 3.2.5.2 TDD pilots in the UL PRU

UL pilots are dedicated to each user. They can be precoded or Beamformed in the same way as the data subcarriers.

The LRU of the uplink may be sent contiguous or distributed

- **Contiguous LRU**

The pilot patterns for contiguous LRUs are the same as in the DL case (set 0).

- **Distributed LRU**

A distributed PRU is divided into 3 tiles of 6 subcarriers x  $N_{sym}$  symbols. By dividing the LRU, the pilot density increases compared to the contiguous LRU. The distributed pilot patterns are shown in the following Figure.

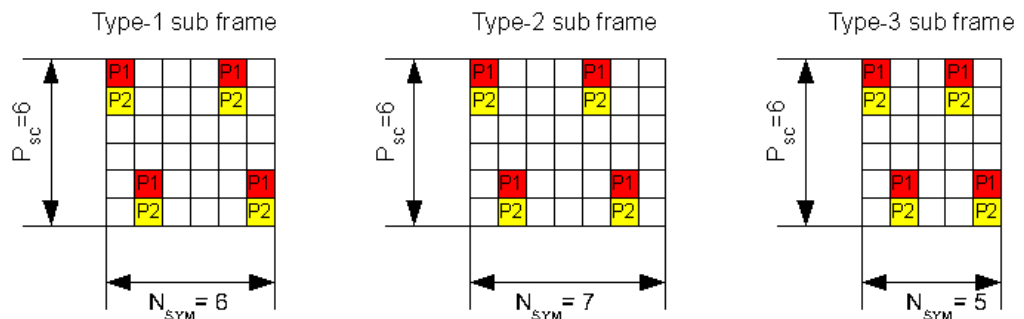

Figure 19: UL TDD pilot pattern

### 3.2.5.3 Common and dedicated pilots

802.16m also supports common and dedicated pilots. For both pilots, the pattern design is unified as shown above. So independent from the type, the pilot density is always the same.

- **Common pilots**

The common pilots are used by all mobile terminals and can not be Beamformed or Precoded. If common pilots are distributed, they are sent in all resource units.

- **Dedicated pilots**

The dedicated pilots can only be used by MSs associated with a specific resource allocation. They can be precoded or Beamformed in the same way as the data subcarriers.

With the dedicated pilot setting, enhanced MIMO support is possible for one dedicated resource unit.

### 3.2.6 MIMO

In 802.16m, the support of 2x2 MIMO is mandatory and a precoding Block has been introduced.

The enhanced MIMO support increases mainly the data rates, also required from IMT-Advanced.

The Precoding Block enables the modification of the symbols in Phase and Amplitude. So Beamforming and enhanced MIMO configurations are supported.

Additionally the wording of 802.16m and LTE is more similar, so some well known terms in WiMAX changed, such as, Matrix A or Matrix B.

802.16m wording	802.16e wording	Description
SU-MIMO	Matrix A, Matrix B, true MIMO	Increases the data rate per user
MU-MIMO	UL collaborative MIMO	Increases the data rate per cell
Beamforming	Beamforming	Increases the data rate per user / group

In addition to the mandatory support of MIMO in 802.16m, the coding possibilities have been enhanced. Vertical Encoding (VE) and Horizontal Encoding (HE) are supported. VE is used in single user (SU)-MIMO and all Antennas (Users / Layers) are coded together. HE is used in multi user (MU)-MIMO and all Antennas (Users / Layers) are coded separately.

802.16m supports open loop (OL) and closed loop (CL) modes.

Open-loop SU-MIMO is supported for 2, 4, and 8 TX antennas for transmit diversity and spatial multiplexing.

Closed-loop SU-MIMO using codebook-based precoding is supported for FDD and TDD. As in TDD the UL and DL use the same frequencies and sounding can also be implemented. 802.16m supports sounding-based precoding for TDD.

For MU-MIMO, 2 TX antennas can support up to 2 streams and users, while 4 and 8 TX can support up to 4 streams and users. For each physical resource unit (PRU) codebook-based precoding is used.

### 3.2.6.1 MIMO modes

The different MIMO configurations are defined in modes. The following table shows the different modes.

#### DL MIMO modes

Mode Index	Description	MIMO encoding format (MEF)	MIMO precoding
Mode 0	OL SU-MIMO (Tx diversity)	Space Frequency Block Coding (SFBC)	non-adaptive
Mode 1	OL SU-MIMO (SM)	Vertical Encoding (VE)	non-adaptive
Mode 2	CL SU-MIMO (SM)	Vertical Encoding (VE)	adaptive
Mode 3	OL MU-MIMO (SM)	Multi Layer Encoding (ME)	non-adaptive
Mode 4	CL MU-MIMO (SM)	Multi Layer Encoding (ME)	adaptive
Mode 5	OL SU-MIMO (Tx diversity)	Conjugate Data Reception (CDR)	non-adaptive

**Table 8: DL MIMO modes**

#### UL MIMO modes

Mode Index	Description	MIMO encoding format (MEF)	MIMO precoding
Mode 0	OL SU-MIMO	SFBC	non-adaptive
Mode 1	OL SU-MIMO (SM)	Vertical Encoding (VE)	non-adaptive
Mode 2	CL SU-MIMO (SM)	Vertical Encoding (VE)	adaptive
Mode 3	OL MU-MIMO (Collaborative SM)	Vertical Encoding (VE)	non-adaptive
Mode 4	CL MU-MIMO (Collaborative SM)	Vertical Encoding (VE)	adaptive

**Table 9: UL MIMO modes**

### 3.2.6.2 MIMO architecture

As 802.16m supports MIMO with full precoding, the implementation is made as shown in the following structure. One unique Block supports Precoding in a separate Block, which can modify the symbols in Phase and Amplitude. This gives the 802.16m system enhanced MIMO functionalities like Beamforming (BF). In Beamforming the dedicated pilots can also be precoded.

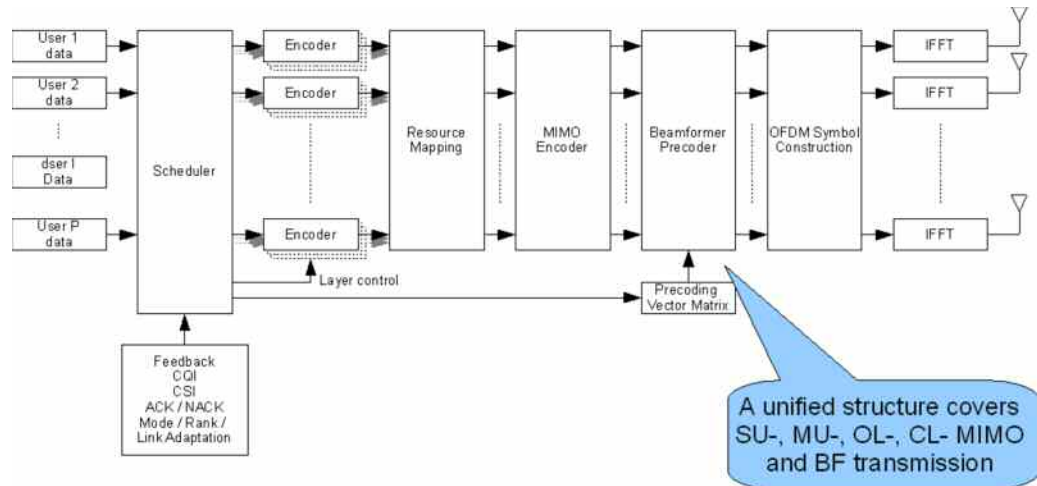

**Figure 20: MIMO architectural Implementation**

The different layers are defined by different data paths fed to the MIMO encoder.

- Vertical encoding (VE) is only used for one layer.
- Multi Layer encoding (ME) is used for multiple layers and necessary for MU-MIMO.

### 3.2.6.3 MIMO Feedback

The BS decides which MIMO mode is selected due to channel conditions and load in the cell. The feedback of the channel conditions is based on the following methods.

	Feedback methods	Feedback information
DL MIMO	<ul style="list-style-type: none"> <li>- Codebook-based</li> <li>- Uplink sounding (TDD)</li> <li>- Analog feedback (closed loop, direct transmission of channel coefficients)</li> </ul>	<ul style="list-style-type: none"> <li>- Sub band selection</li> <li>- STC rate</li> <li>- CQI</li> <li>- PMI report for serving cell</li> <li>- PMI report for neighboring cell</li> <li>- Stream index</li> <li>- Quantized spatial correlation matrix</li> <li>- Preferred operation mode (diversity / localized)</li> </ul>
UL MIMO	<ul style="list-style-type: none"> <li>- Codebook-based</li> <li>- Midamble-based (TDD)</li> <li>- Uplink sounding</li> </ul>	<ul style="list-style-type: none"> <li>- PMI report (BS to MS)</li> </ul>

**Table 10: MIMO Feedback**

Dependent on the channel conditions, a codebook Entry will be selected. The codebook entry defines the MIMO mode and the Precoding Vectors.



### 3.2.7 Control channels

The 802.16m Air Interface has its own synchronization and control signals. If 802.16e and 802.16m are in parallel operation, both control channels are transmitted in parallel.

#### 3.2.7.1 DL control channels

For reducing the Overhead, 802.16m introduced control mechanisms with different transmission intervals in the time domain for the DL.

So, control information, which does not change quickly like used bands of the BS can be transmitted with long time intervals, whilst control information which changes quickly can be updated more often like channel conditions.

The following table describes the different control channels.

Channel		Information
A-PREAMBLE	Advanced Preamble	Physical channel provides reference for time, frequency, and frame synchronization, RSSI estimation, channel estimation, and BS identification. One instance per superframe in fixed location
PA-PREAMBLE	Primary Advanced Preamble	Used for initial acquisition, superframe synchronization contains information like: Advanced BS Type, Section ID, BW, carrier configuration
SA-PREAMBLE	Secondary Advanced Preamble	Used for fine synchronization, cell / sector identification contains information like: channel estimation
SFH	Superframe Header	Contains essential system parameters and system configuration info. The SFH contains the P-SFH and the S-SFH. Located in first AAI subframe within a superframe
P-SFH	Primary Superframe Header	Transmitted in every superframe, fixed size of 5 symbols The P-SFH contains mainly short term control information
S-SFH	Secondary Superframe Header	May be transmitted over one or more superframes. Variable size, as indicated by P-SFH The S-SFH contains mainly long term control information like DUIC
A-MAP	Advanced MAP	Contains unicast service control information, i. e. resource assignment. May include scheduling assignment, power control info, HARQ ACK / NACK
E-MBS-MAP	Enhanced Multicast Broadcast Service MAP	Contains multicast service control information. Divided into cell-specific and non-cell-specific control channels

**Table 11: DL control channels**

The distribution of the primary and secondary Preamble inside of a superframe is shown in the picture below. The primary advanced Preamble is transmitted with the second frame, while the secondary advanced preamble is transmitted in the first, third and fourth frame.

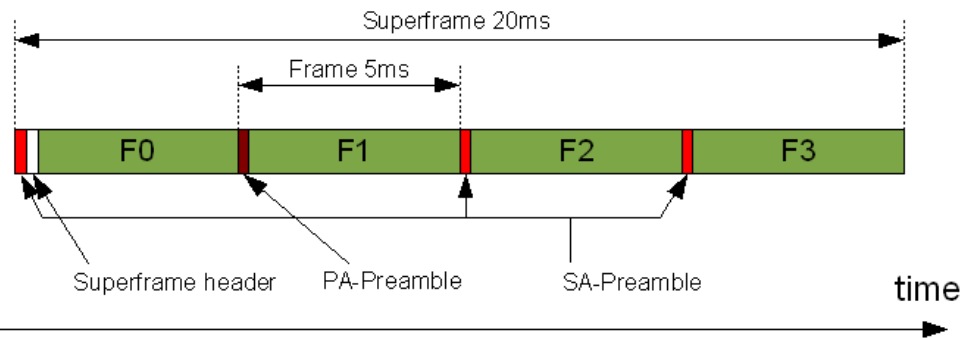

**Figure 21: distribution of the preambles in a superframe**

### 3.2.7.2 UL control channels

In the UL, the control mechanisms are the same as for 802.16e. The supported Codebook entries and from BS selected Precoding matrices for MIMO operation have been enhanced.

Channel	Information
UL Feedback Channel	<ul style="list-style-type: none"> <li>- Primary Fast Feedback Channel (P-FBCH)</li> <li>- Secondary Fast Feedback Channel (S-FBCH)</li> <li>- UL HARQ Feedback Channel (UL HARQ FBCH) (ACK/NACK)</li> </ul>
Ranging Channel	<ul style="list-style-type: none"> <li>- for UL-synchronization of the MS (initial entry and handover)</li> <li>- Ranging Channel for synchronized MS (periodic)</li> </ul>
BW REQ Channel	<ul style="list-style-type: none"> <li>- 3-step bandwidth request for sensitive services</li> <li>- 5-step bandwidth request for non-urgent services, fallback for 3-step BR</li> </ul>
Sounding Channel	<p>Closed-loop MIMO feedback</p> <p>The sounding channel occupies either specific UL sub-bands or the entire bandwidth over an OFDMA symbol.</p>
Channel quality indicators (CQI)	<ul style="list-style-type: none"> <li>- Channel quality feedback about channel conditions as seen by the user. This information is used by the base station for the link adaptation, resource allocation, power control, etc. There are two types of UL fast feedback control channels: primary and secondary fast feedback channels. The primary fast feedback channel provides wideband feedback information, including channel quality and MIMO feedback. The secondary fast feedback control channel carries narrowband CQI and MIMO feedback information.</li> </ul>
Power control	<ul style="list-style-type: none"> <li>- The base station controls the transmit power per subframe and per user in the DL and UL. The DL advanced MAP is power-controlled, based on the terminal UL channel quality feedback. The per-pilot-subcarrier and per-data-subcarrier power can jointly be adjusted for adaptive DL power control. The UL power control is supported to compensate the path loss, shadowing, fast fading and implementation loss, as well as to mitigate inter-cell and intra-cell interference levels. The UL power control includes open-loop and closed-loop power control mechanisms.</li> </ul>

**Table 12: UL control channels**

### 3.3 MAC Layer

The MAC (Media Access Control) Layer is also Part of the 802.16m draft standard. As the 802.16m PHY specifications are more preceded, this Application Note concentrates on the PHY layer.

### 3.4 Further Implementations in 802.16m

The 802.16m Draft standard also supports further functionalities which are implemented in PHY and MAC mechanisms.

These Functionalities include:

- Femto Base stations
- Multi Base station MIMO
- Relay stations
- Self Organizing Networks (SON)
- Location Based Service (LBS)
- Enhanced Multicast Broadcast Service (E-MBS)

Parts of these Implementations have already been specified in other standards like 802.16e mobile WiMAX or 802.16j Relay stations for mobile WiMAX.

### 3.5 Certification

The WiMAX Forum, with Release 2, will begin certifying devices with key 802.16m features.

## 4 Measurements

Rohde & Schwarz offers a full Test and Measurement Equipment Portfolio for 802.16e which represents the Legacy Mode of 802.16m.

This includes:

- Signal Generators
- Signal Analyzers
- Radio Communication Tester
- MIMO support
- Beamforming support in signal generation and signal analysis
- Fading support with realtime correlated channels for MIMO
- Radio conformance testers
- Drive tests

Rohde & Schwarz follows closely the standards development and provides solutions based on our platform equipment on time.

## 5 Conclusion

802.16m adds new functionality for reaching the IMT-Advanced Air Interface requirements. The additional features are mainly:

- Multicarrier operation with usable band widths up to 100 MHz
- MIMO support of 2x2 mandatory, up to 8x8 optional
- Enhanced Precoding support
- Superframes supported

These steps are a logical future development of the existing 802.16e standard. LTE-Advanced is also submitted as an IMT-Advanced Air Interface (AAI).

## 6 References

- IEEE 802.16m Draft 3
- IEEE 802.16e standard amendment
- IEEE 802.16-2009 standard
- ITU IMT-Advanced Requirements
- Systems Requirements Document

## 7 Additional Information

- LTE-Advanced Technology Introduction, Application Note 1MA169
- LTE-Advanced Signal Generation and Analysis, Application Note 1MA166
- [www.rohde-schwarz.com/technology/wimax](http://www.rohde-schwarz.com/technology/wimax)

## 8 Glossary

### A

A	Advanced
AAI	Advanced Air Interface
ACK	Acknowledged
AMC	Adaptive Modulation and Coding
ARQ	Automatic Repeat Request

### B

BF	Beamforming
BR	Bandwidth Request
BS	Base Station
BW	Bandwidth

### C

CDR	Conjugate Data Reception
CL	Closed Loop
CLC	Co Located Coexistence
CP	Cyclic Prefix
CQI	Channel Quality Indicator

### D

DL	Downlink
----	----------

### E

E	Enhanced
---	----------

### F

F	Frame
FBCH	Fast Feedback Channel
FCH	Frame Control Header
FDD	Frequency Division Duplex
FDM	Frequency Division Multiplex
FUSC	Fully Used Sub Carrier

### G

### H

H-FDD	Hybrid FDD
HARQ	Hybrid Automatic Repeat Request

### I

IEEE	Institute of Electrical and Electronics Engineers
IMT	International Mobile Telecommunications
ITU	International Telecommunications Union

### L

LBS	Location Based Service
LRU	Logical Resource Unit
LTE	Long Time Evolution
LZone	Legacy Zone

### M

MAC	Media Access Control
MBS	Multicast Broadcast Service
ME	Multi Layer Encoding
MIMO	Multiple In Multiple Out
MS	Mobile Station
MU-MIMO	Multi User MIMO
MZone	802.16m Zone

### N

NACK	Not Acknowledged
------	------------------

### O

OFDMA	Orthogonal Frequency Division Multiple Access
OL	Open Loop

### P

P	Primary
PA	Primary Advanced
Phy	Physical
PRU	Physical Resource Unit
PUSC	Partly Used Sub Carrier

### R

REQ	Request
RFC	Radio Frequency Carrier
RTG	Receive Transition Gap

**S**

S	Secondary
SA	Secondary Advanced
SC	Sub Carrier
SF	Super Frame or Sub Frame
SFBC	Space Frequency Block Coding
SFH	Super Frame Header
SON	Self Organizing Networks
STC	Space Time Coding
SU-MIMO	Single User MIMO

**T**

TDD	Time Division Duplex
TDM	Time Division Multiplex
TTG	Transmit Transition Gap

**U**

UL	Uplink
----	--------

**V**

VE	Vertical Encoding
----	-------------------

**W**

WiMAX™	Worldwide Interoperability of Microwave Access
WMF	WiMAX Forum®

“WiMAX Forum” is a registered trademark of the WiMAX Forum.  
“WiMAX,” the WiMAX Forum logo, “WiMAX Forum Certified,” and  
the WiMAX Forum Certified logo are trademarks of the WiMAX  
Forum.

## 9 Index

<b>B</b>	
bands.....	9
BW .....	35
<b>C</b>	
CP .....	8
<b>D</b>	
DL.....	33
<b>E</b>	
Enhanced Multicast Broadcast Service .....	36
<b>F</b>	
FDD.....	8
FDM.....	17
Femto .....	36
Frame.....	19
<b>I</b>	
IMT .....	5
ITU .....	5
<b>L</b>	
Location Based Service .....	36
LRU .....	24
<b>M</b>	
mapping.....	24
Multi Base station .....	36
Multicarrier Operation .....	9
MU-MIMO.....	29
<b>O</b>	
OFDMA.....	8
<b>P</b>	
pilot .....	25
PREAMBLE.....	33
PRU .....	21,22
<b>R</b>	
Relay .....	36
<b>S</b>	
sampling factor .....	8
Self Organizing Networks .....	36
SFH.....	33
subcarrier spacing .....	8
SU-MIMO .....	29
<b>T</b>	
TDD.....	8
TDM .....	17
<b>U</b>	
UL .....	35



**About Rohde & Schwarz**

Rohde & Schwarz is an independent group of companies specializing in electronics. It is a leading supplier of solutions in the fields of test and measurement, broadcasting, radiomonitoring and radiolocation, as well as secure communications. Established 75 years ago, Rohde & Schwarz has a global presence and a dedicated service network in over 70 countries. Company headquarters are in Munich, Germany.

**Environmental commitment**

- Energy-efficient products
- Continuous improvement in environmental sustainability
- ISO 14001-certified environmental management system

**Regional contact**

USA & Canada

USA: 1-888-TEST-RSA (1-888-837-8772)

from outside USA: +1 410 910 7800

[CustomerSupport@rohde-schwarz.com](mailto:CustomerSupport@rohde-schwarz.com)

East Asia

+65 65 13 04 88

[CustomerSupport@rohde-schwarz.com](mailto:CustomerSupport@rohde-schwarz.com)

Rest of the World

+49 89 4129 137 74

[CustomerSupport@rohde-schwarz.com](mailto:CustomerSupport@rohde-schwarz.com)

This white paper and the supplied programs may only be used subject to the conditions of use set forth in the download area of the Rohde & Schwarz website.

R&S® is a registered trademark of Rohde & Schwarz GmbH & Co. KG. Trade names are trademarks of the owners.

**Rohde & Schwarz GmbH & Co. KG**

Mühlhofstraße 15 | D - 81671 München

Phone + 49 89 4129 - 0 | Fax + 49 89 4129 - 13777

[www.rohde-schwarz.com](http://www.rohde-schwarz.com)