

# Making Spectrum Measurements with Rohde & Schwarz Network Analyzers

## Application Note

### Products:

R&S®ZVA	R&S®ZVT
R&S®ZVB	R&S®ZNB

This application note describes how to configure a Rohde & Schwarz Network Analyzer to make spectral measurements directly on a device under test.

---

## Table of Contents

<b>1</b>	<b>Introduction .....</b>	<b>3</b>
<b>2</b>	<b>Set-up of measurement .....</b>	<b>3</b>
<b>3</b>	<b>Spurious avoidance .....</b>	<b>4</b>
<b>4</b>	<b>Software preselector.....</b>	<b>7</b>
<b>5</b>	<b>Optimising number of points and bandwidth .....</b>	<b>8</b>
<b>6</b>	<b>Measurement example.....</b>	<b>9</b>
<b>7</b>	<b>Measurement on non-CW signals.....</b>	<b>11</b>
<b>8</b>	<b>Conclusion.....</b>	<b>12</b>

# 1 Introduction

Network analyzers are designed so that they can characterize unknown devices by stimulating a device with a known signal. From this they can then measure either the reflection or the transmissions characteristics and calculate the device's S-Parameters.

To characterize a device the network analyzer makes measurements in the frequency domain (frequency sweep). However, the result is a ratio of power to give the relative measurement of the reflection/transmission coefficient of the device.

Spectrum Analyzers also make measurements in the Frequency Domain but are direct measurements of power. They allow a sweep to be made to search for unknown signals like spurious signals or harmonics.

It is possible to use the receivers of the network analyzer to show a signal by displaying the absolute "Wave Quantity". This is the absolute power detected by any of the individual receivers within the network analyzer.

The following abbreviations are used in this document for R&S® test equipment:

- The R&S® ZVA Vector Network Analyzer is referred to as ZVA.
- The R&S® ZVB Vector Network Analyzer is referred to as ZVB.
- The R&S® ZNB Vector Network Analyzer is referred to as ZNB.
- The R&S® ZVT Vector Network Analyzer is referred to as ZVT.

## 2 Set-up of measurement

To understand how to set up the instrument prior to making a spectrum measurement we must first understand the concept of the RF test set of the Rohde & Schwarz network analyzers.

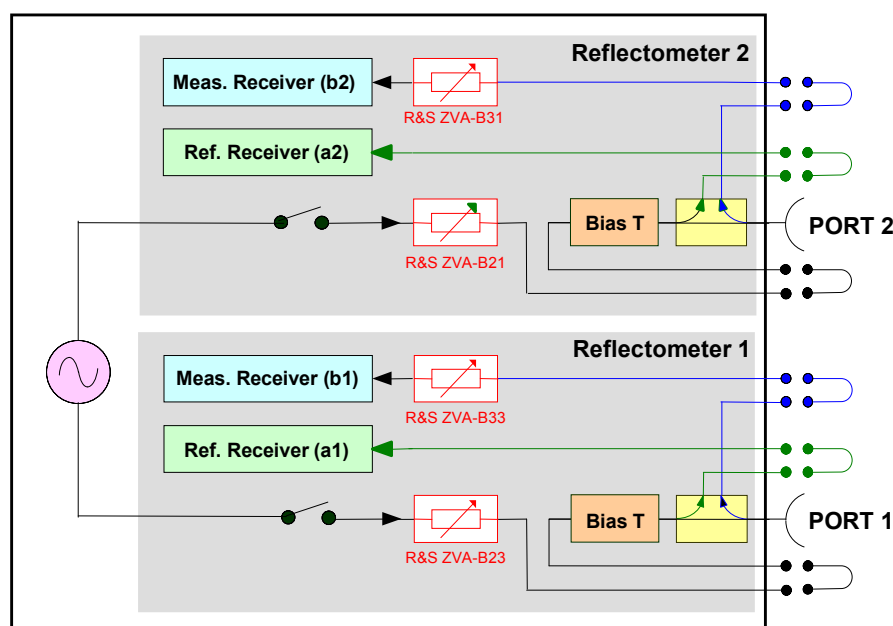


Figure 1 - ZVA RF Test Set with B16 Option

In Figure 1 we show the RF part of the test set for the ZVA including the ZVA-B16 direct access option. The layout for the R&S ZVB, ZVT and ZNB instruments are very similar. The main point that we want to focus on here is that if a signal is presented directly to Port 2 then we can make an absolute power measurement on the “MEAS” receiver “b2” (or “b1” if using Port 1). The user interface of the network analyzer allows this measurement to be displayed by selecting the measurement of “Wave Quantities”.

At this point we must highlight some differences about measurements with a spectrum analyzer and network analyzer:

### Spectrum Analyzer

- Coupled Functions
  - Couples IF bandwidth with measurement points (internal)
  - Number of measurement points is different to displayed points
  - Displayed point shows the defined mathematical value of a group of measured points
- Selective Front-end
  - Image frequencies rejected due to upconversion stage
  - Sometimes hardware preselector
  - Good for harmonic test because of fundamental suppression

### Network Analyzer

- Number of points and IF bandwidth independent (user selective)
- Only displayed points are measured
- Partially selective frontend
  - Down conversion to IF (about 20 MHz)
  - Image receiver window 40 MHz (=2\*IF)

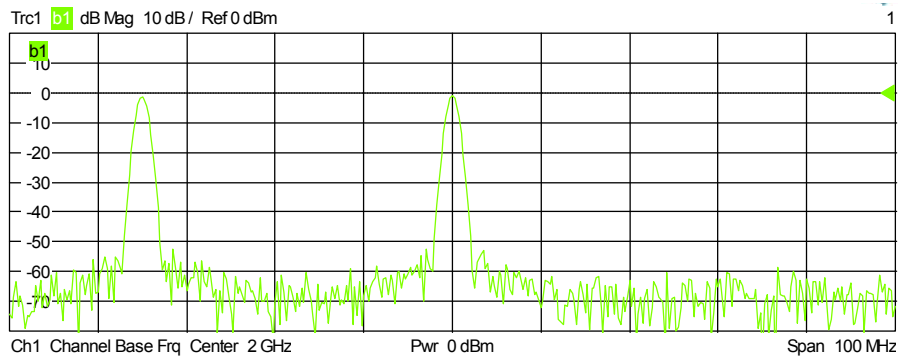
One of the main differences is that the network analyzer only has a partially frequency selective front end. This is because it does not have a dedicated preselector to remove unwanted image frequencies. Image frequencies are undesired frequencies which in a heterodyne receiver system are capable of producing the same IF.

Above, we wrote that the image window for the network analyzer is 40 MHz. This is derived because in a heterodyne receiver the IF can be derived by  $IF=RF_1-LO$  or  $IF=LO-RF_2$ .  $RF_1$  and  $RF_2$  are down converted with the same  $LO$  to the same IF. Therefore we have  $RF_1=LO+IF$  ( $RF>LO$ ) giving the wanted frequency and  $RF_2=LO-IF$  ( $RF<LO$ ) giving the unwanted image frequency. Thus  $RF_1-RF_2=2*IF$ , the received frequencies are separated by  $2*IF$ .

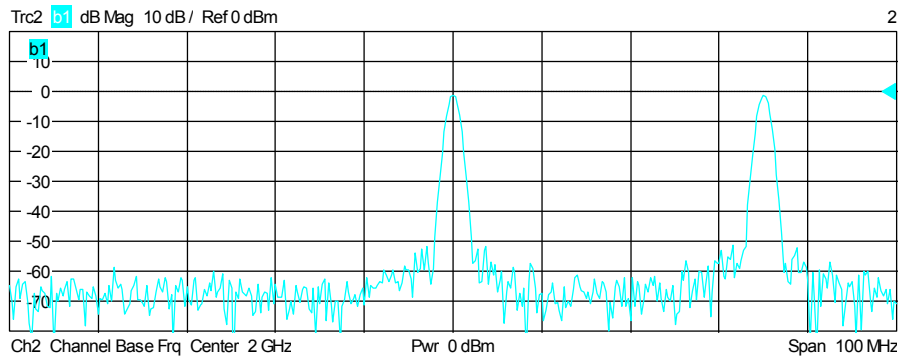
## 3 Spurious avoidance

Because of the image receiver window of around 40MHz, a signal that is measured is displayed twice, at it's original frequency and also at it's image frequency. With Rohde & Schwarz network analyzers it is possible to change the LO frequency to choose the position of the image frequency in respect to the RF signal.

The following two figures show how the position of the unwanted image signal is dependant upon the chosen LO frequency.

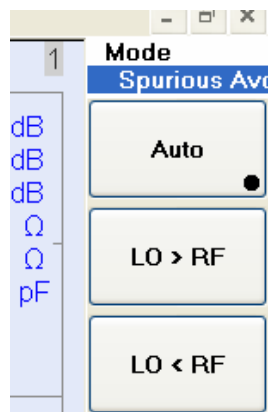


**Figure 2 - LO > RF**



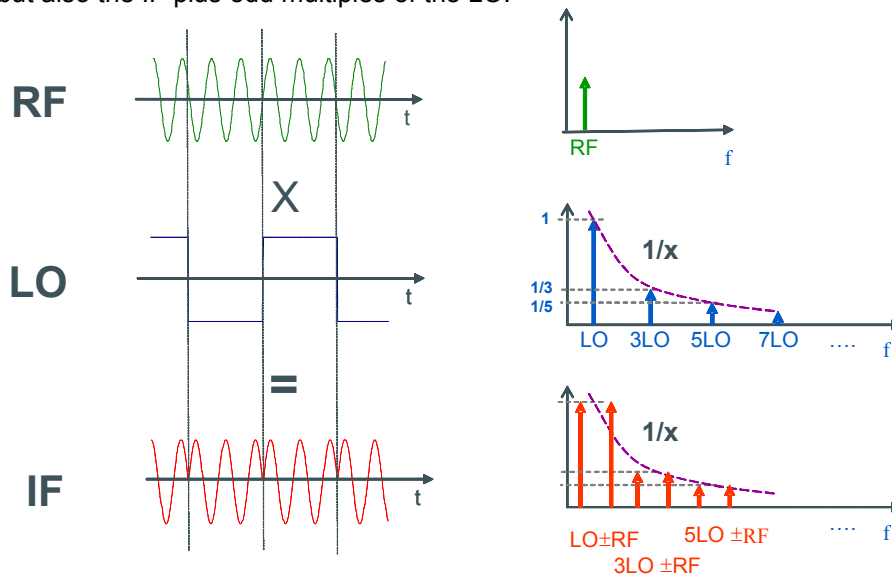
**Figure 3 - LO < RF**

In the MODE menu you can find the Spurious Avoidance mode. This allows the position of the LO to be changed. Toggling between both buttons shifts the image receiver window by  $4 \cdot IF$ .



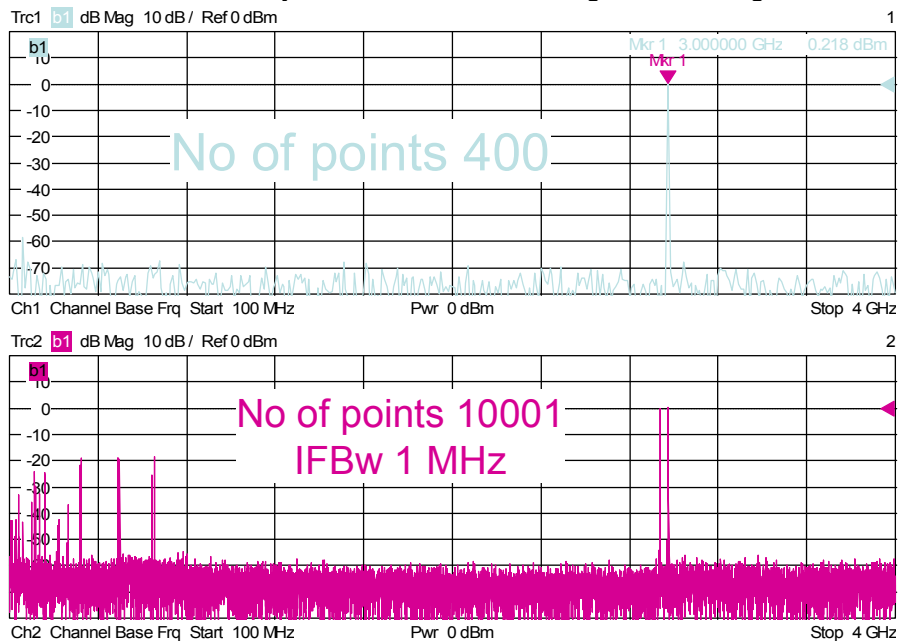
Other receiver windows are also present. The figure below shows the RF, LO and resultant IF frequency in both the time domain (t) and the frequency domain (f). Because of the mixing process within the heterodyne receiver of the network analyzer the IF is a multiplication of the RF and LO in the time domain. The spectrum of the RF signal is shifted by the LO frequency. The rectangular signal of the LO has a spectrum with several carriers, consisting of the largest at the LO frequency and other carriers at the odd harmonics.

This generates the IF signals  $LO \pm RF$  and  $n \cdot LO \pm RF$ , where n is the factor (odd multiples 1,3,5 etc). Therefore receiver windows can be found not just around the IF but also the IF plus odd multiples of the LO.



**Figure 4 – illustration of receiver image windows**

This can be seen when you look at a 3GHz CW signal with a larger number of points:

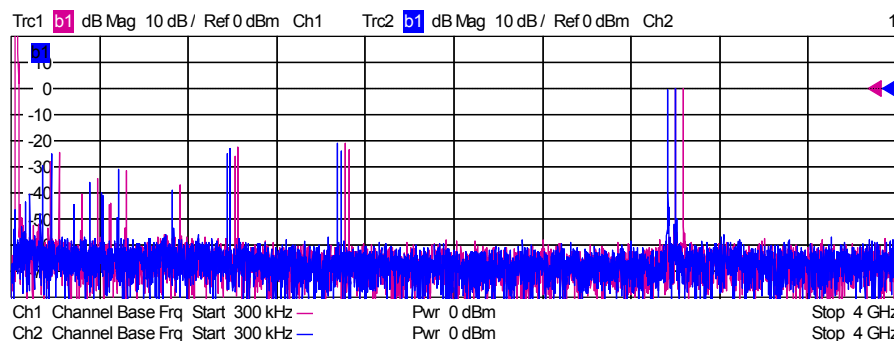


**Figure 5 – screenshot showing multiple signals at receiver input**

## 4 Software preselector

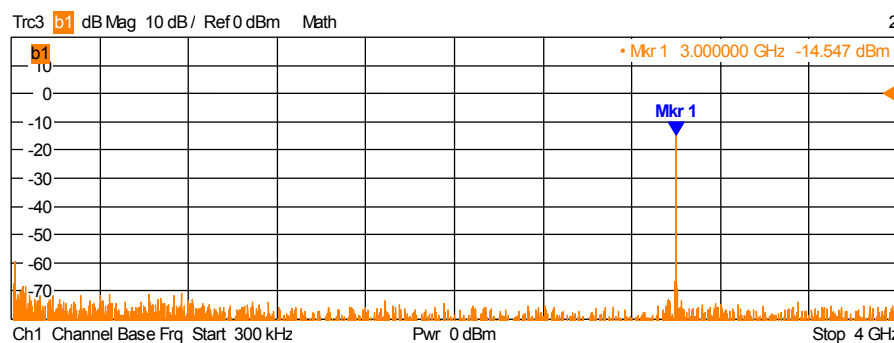
As the position of the spurs change when a different LO frequency is selected the wanted signal is always static, it is possible to apply a software preselector mathematically. This can be done in the user interface of the network analyzer using the trace mathematics feature.

Below, you can see a screenshot from the network analyzer applying a fixed signal at 3 GHz while sweeping the LO frequencies of the receivers of the b1 wave quantities. We have created two independent channels and assigned the two traces [Trc1] and [Trc2] to them. [Trc1] has been configured so that LO > RF have been selected in the spurious avoidance menu and [Trc2] for LO < RF. It is clear that we should only be able to see one frequency component at 3GHz. The others are spurious signals, but you can see that they move..



**Figure 6 - Two sweeps in separate channels with different LO settings**

By taking the minimum value at each frequency of each channel, using the formula,  $\text{Min}(\text{Trc1}, \text{Trc2})$  all unwanted signals are removed except for the one that is static and identical within both channels. The true signal at 3GHz is left.



**Figure 7 - Resultant spectrum sweep with trace math preselector enabled**

This can be configured in the [User Defined Math] function which resides in the [Trace Funct] menu shown below.

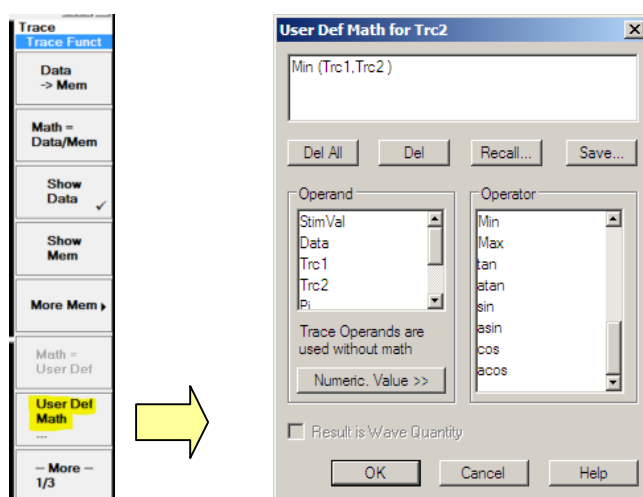


Figure 8 - Configuration of the trace math editor

## 5 Optimizing number of points and bandwidth

A modern network analyzer does not have a continuous ramp sweep from start to stop frequencies like a spectrum analyzer. It makes stepped measurements at selected frequency points based upon the chosen number of points in that sweep. Therefore, depending on the frequency step and the selected measurement bandwidth “holes” in the sweep can be created allowing for information to be missed.

Consideration should be given to the frequency step and the measurement bandwidth to ensure that there is sufficient overlap so that all information in the frequency range of the sweep can be captured.

Take a look at the following example:

If we take a 4 GHz span starting at 8 GHz and stopping at 12 GHz with 801 measurements points, the resulting frequency step size is 5 MHz. If then a measurement bandwidth of 10 kHz is chosen, there is a clear gap where we have no coverage of the measurement receiver and signals can be missed.

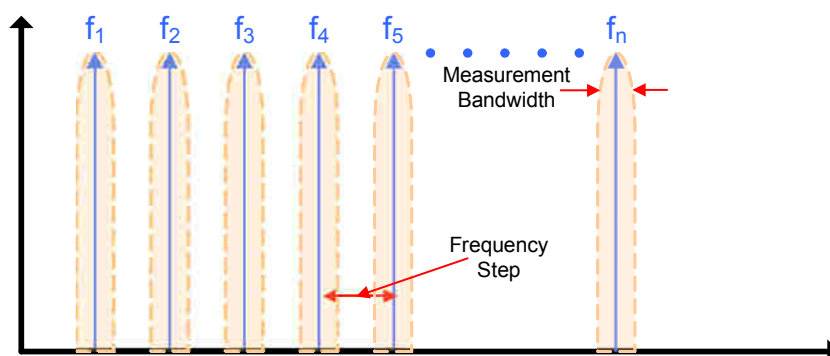


Figure 9 - Illustration of stepped frequency sweep

To achieve a good overlap of measurement points a frequency step should be chosen that is smaller than the used measurement bandwidth.

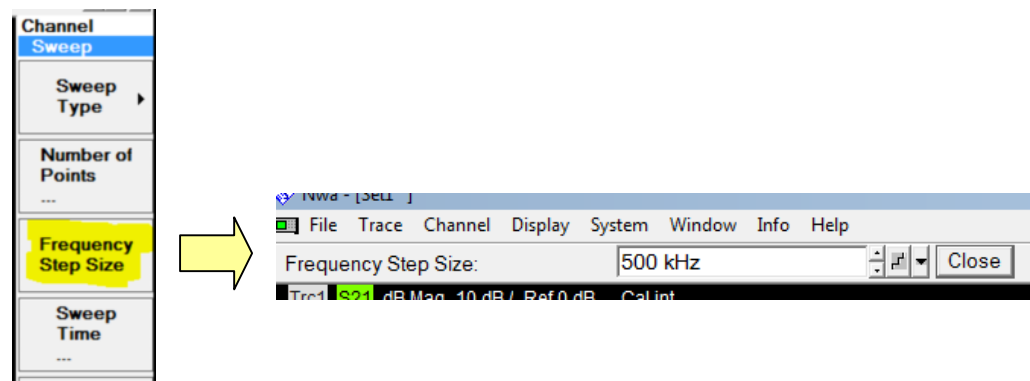


It is desirable to select the widest bandwidth possible for the measurement providing the required noise floor for the measurement. This has the desired effect of keeping the sweep time to a minimum and also increasing the width of the measurement receiver window resulting in the need for less data points.

The frequency step size can be calculated from the following:

$$\text{Frequency Step Size} = \frac{(f_{\text{Stop}} - f_{\text{Start}})}{\text{Number of points} - 1}$$

From this, the optimum number of points can be calculated to ensure that the frequency step size stays well within the desired measurement bandwidth. The frequency step size can be read out and defined directly from the network analyzer user interface in the [Channel Sweep] menu:



**Figure 10 - Menu to define the frequency step size**

As a rule of thumb, you should keep the frequency step size to around half of the measurement bandwidth. This way there is no possibility of both missing information or an error in the magnitude response. The displayed measurement bandwidths of the network analyzer define the 3 dB bandwidths of the measurement filter, so up to 3 dB error could be expected when the frequency step size comes close to the measurement bandwidth.

With a maximum number of 60,001 data points and a measurement bandwidth of 5 MHz, the maximum frequency span that can be measured is:

$$2.5 \text{ MHz} * 60,000 = 150 \text{ GHz}$$

## 6 Measurement example

In the following we take the example to use the ZVA network analyzer and make a spectrum measurement of a signal in the range of 7 GHz to 12 GHz. The application is to identify a spurious signal within the given frequency range and report a failure if a signal above -60 dBm is measured.

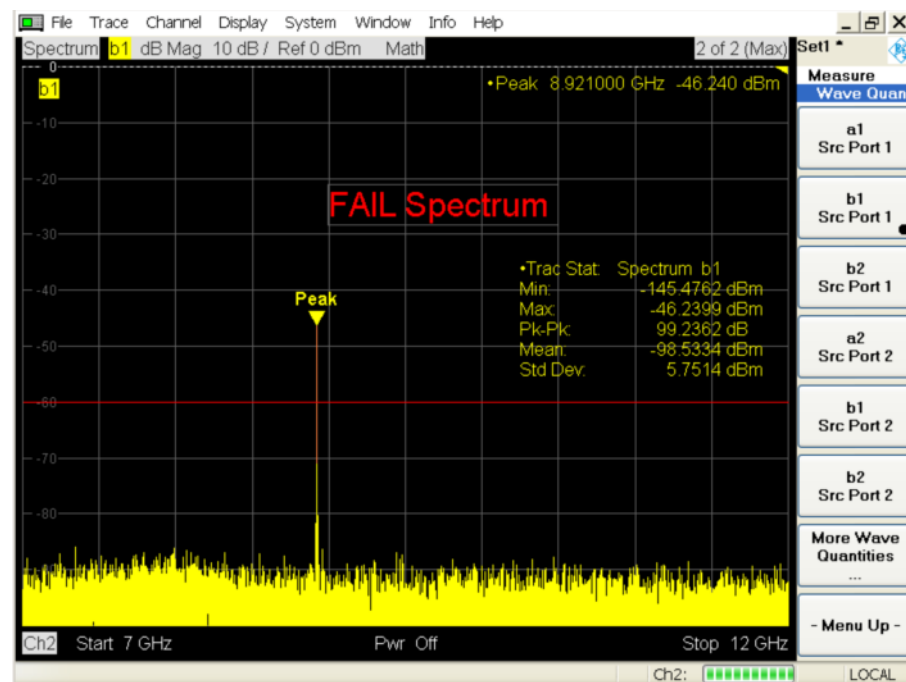
After setting up the appropriate channels and trace math described above, we start off with a measurement bandwidth of 1 MHz. This ensures that we have the fastest sweep time. With no signal present at Port 2 of the network analyzer, the system noise floor

can be identified. In this case for the ZVA network analyzer it is around -90 dBm; this is more than adequate for this application. Improvement in the noise floor can be achieved by reducing the measurement bandwidth at the cost of sweep time.

Additional improvements of around 10 dB can also be made by using the direct receiver inputs of the B16 option. However, this requires a power calibration to compensate for the removal of the test port coupler loss.

Next we must identify the correct number of points to ensure that continuous frequency coverage is achieved. For a 5 GHz span, 10,001 data points will give a frequency step size of 500 kHz. This leaves enough overlap with a 1 MHz measurement bandwidth. Lowering the measurement bandwidth will require more data points to ensure continuous frequency coverage.

At this point, we have optimized the setup and the network analyzer is ready to make the measurement. We can make the process of spurious signal identification easier by using a limit line set to the threshold value of -60 dBm. For automation, peak markers can also be used to jump to and identify the value of any spurious products. This is shown below in Figure 11.



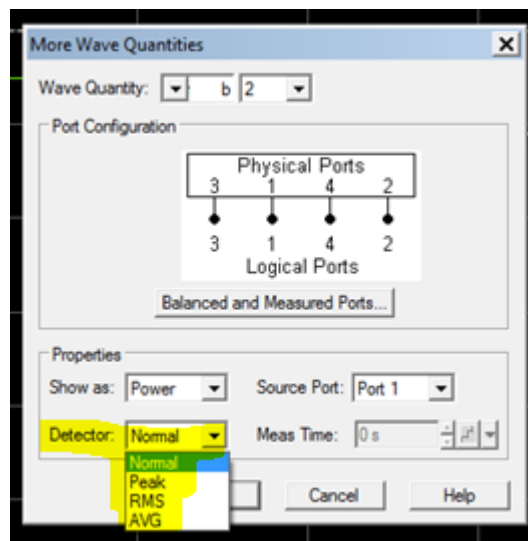
**Figure 11 - Example of spectrum measurement to identify spurious signals**

The above measurement is completed in under 800ms, including sweeps for both channels (LO>RF and LO<RF).

## 7 Measurement on non-CW signals

A network analyzer is usually optimized so that its receiver will measure its own CW stimulus signal. This is the 'Normal' mode that can be seen in the "Detector" settings of the [More Wave Quantities] dialog box (Figure 12). In this way the network analyzer makes one measurement at each data point and moves onto the next in the fastest way it can. This can be compared with a spectrum analyzer's 'Sample' detector.

Often non-periodic or modulated signals are required to be analyzed. On a spectrum analyzer care must be taken to choose the appropriate detector settings to analyze such signals. These same detectors are also available on the Rohde & Schwarz family of network analyzers.



**Figure 12 - Detector setting in Wave Quantities dialog**

If 'Peak', 'RMS' or 'AVG' detectors are selected then the algorithm used to calculate the displayed trace points is changed to include an observation time. This observation time can be defined in the 'Meas Time' dialog. This can be thought of as filling a bin of continuous measurement data for that defined period of time. Depending on the detector chosen then the desired data calculated from this bin is used to display a single measurement point in the following way:

**Peak** – searches through all the valid samples collected in the measurement bin, and selects the result with the maximum magnitude (maximum power) to display as the peak measurement value.

**RMS** – calculates the root mean square (RMS) of the linear magnitude of all valid samples collected in the measurement bin, and displays the result as the rms power value.

**AVG** – calculates the complex arithmetic mean value of all valid samples collected in the measurement bin, and displays the result as average power. Averaging tends to remove statistical fluctuations (e.g. noise contributions) from the measured signal.

## 8 Conclusion

We have seen how the Rohde & Schwarz network analyzers can be configured to make basic spectrum measurements. The network analyzer should never be considered as a complete replacement for a spectrum analyzer, as there are many more functions on a dedicated unit that can be useful. However, the software-preselected spectrum measurement technique described in this application note can be a convenient way of making basic spectrum measurements on devices where the network analyzer is already being used to characterize the S-Parameters of a device under test. In general, a spectrum analyzer will be faster at making measurements and have better front end sensitivity for detecting small signals.

But there is one advantage other than convenience. The Rohde & Schwarz 2-port network analyzers have four dedicated receivers while 4-port versions have eight receivers, whereas, a traditional spectrum analyzer only has one receiver. This can offer great flexibility and speed advantages when multiple devices have to be measured at the same time, or when there are multiple ports from a DUT that need to be monitored in parallel. The unique architecture of the Rohde & Schwarz network analyzers allows for the data on all receivers to be captured in parallel. This has the benefit that there is no time penalty when measuring multiple receiver inputs vs. a single input.

Improved absolute power accuracy can be achieved for receiver measurements by combining a receiver power calibration with the measured wave quantity. Please refer to the instrument's online help for more information on this feature.

### **About Rohde & Schwarz**

Rohde & Schwarz is an independent group of companies specializing in electronics. It is a leading supplier of solutions in the fields of test and measurement, broadcasting, radiomonitoring and radiolocation, as well as secure communications. Established more than 75 years ago, Rohde & Schwarz has a global presence and a dedicated service network in over 70 countries. Company headquarters are in Munich, Germany.

### **Environmental commitment**

- Energy-efficient products
- Continuous improvement in environmental sustainability
- ISO 14001-certified environmental management system



### **Regional contact**

Europe, Africa, Middle East

+49 89 4129 12345

[customersupport@rohde-schwarz.com](mailto:customersupport@rohde-schwarz.com)

North America

1-888-TEST-RSA (1-888-837-8772)

[customer.support@rsa.rohde-schwarz.com](mailto:customer.support@rsa.rohde-schwarz.com)

Latin America

+1-410-910-7988

[customersupport.la@rohde-schwarz.com](mailto:customersupport.la@rohde-schwarz.com)

Asia/Pacific

+65 65 13 04 88

[customersupport.asia@rohde-schwarz.com](mailto:customersupport.asia@rohde-schwarz.com)

This application note and the supplied programs may only be used subject to the conditions of use set forth in the download area of the Rohde & Schwarz website.

R&S® is a registered trademark of Rohde & Schwarz GmbH & Co. KG; Trade names are trademarks of the owners.

**Rohde & Schwarz GmbH & Co. KG**

Mühlendorfstraße 15 | D - 81671 München

Phone + 49 89 4129 - 0 | Fax + 49 89 4129 - 13777

[www.rohde-schwarz.com](http://www.rohde-schwarz.com)