



Products: ZVRE, ZVR, ZVCE, ZVC, ZVM, ZVK

Conversion Gain Measurements on Mixers with Different Input and Output Impedances

Application Note

This Application Note describes how to configure and calibrate R&S ZVR network analyzers for conversion gain measurements of devices with two ports that have different impedances. Thus accurate measurements on frequency-converting devices such as low noise converters of satellite receivers are possible.



Contents

1 Overview.....	2
2 ZVR Principles of Operation for Measurements on Mixers	2
3 RZVR Calibration for Measurements on Mixers.....	4
Power Calibration of the Generator	5
Power Calibration of the Receiver	6
4 Example.....	8
Configuring the Segmented Sweep.....	9
Calibrating the Generator and Receiver.....	10
Measurement	10
5 Appendix.....	13
6 Further Application Notes	14
7 Additional Information.....	15
8 Ordering Information.....	15

1 Overview

This Application Note describes how to configure and calibrate R&S ZVR network analyzers to perform conversion gain measurements on devices with two ports that have different impedances. Accurate measurements can now be made on frequency-converting devices with different input and output impedances, such as converters of satellite receivers.

2 Principles of Operation for Measurements on a Frequency-Converting Device

Ideal mixers are perfect multipliers that multiply the radio frequency (RF) input signal by a local oscillator (LO) signal. This produces the so called intermediate frequency (IF) signals at the mixer output.

$$IF = RF + LO \quad \text{and}$$

$$IF = |RF - LO|$$

Mixer conversion loss is defined to be the ratio of the complex RF input power P_{in} at frequency f_1 and the IF output power P_{out} at frequency f_2 .

$$Conversion\ loss = \frac{P_{in}}{P_{out}}$$

Mixer Measurements

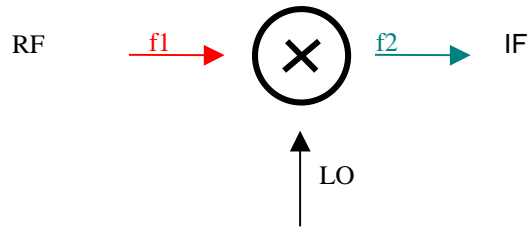

Fig. 2-1 Definition of the input and output signals of the mixer

Since the input and output frequencies of a mixer usually differ, it is not possible to determine the ratio of the input signal and the output signal by magnitude and phase, which would also be necessary for complete system-error correction. Instead, the magnitude of the RF input power and the magnitude of the IF output power at f_1 and f_2 respectively are determined to calculate a scalar ratio. If the mixer has different input and output impedances, one or both measurement ports must be fitted and calibrated with appropriate matching pads.

For measurements on frequency-converting devices with instruments of the R&S ZVR family, the generator is set to the RF input frequency f_1 , and all receivers to the converter's IF output frequency f_2 . Since all receivers use a common LO signal, the reference receiver a_1 cannot be used to measure the mixer's RF input power, a_1 , as it is the case with S-parameter measurements. Instead, the generator power is measured with the broadband level detector which is also used to control the generator output level (Fig. 2-2). The scalar power Pa_1 , determined by the detector, is, therefore, equal to the generator output level set in the network analyzer's source menu, this is why the conversion gain in the MEAS menu of the R&S ZVR is also designated b_2/Pa_1 .

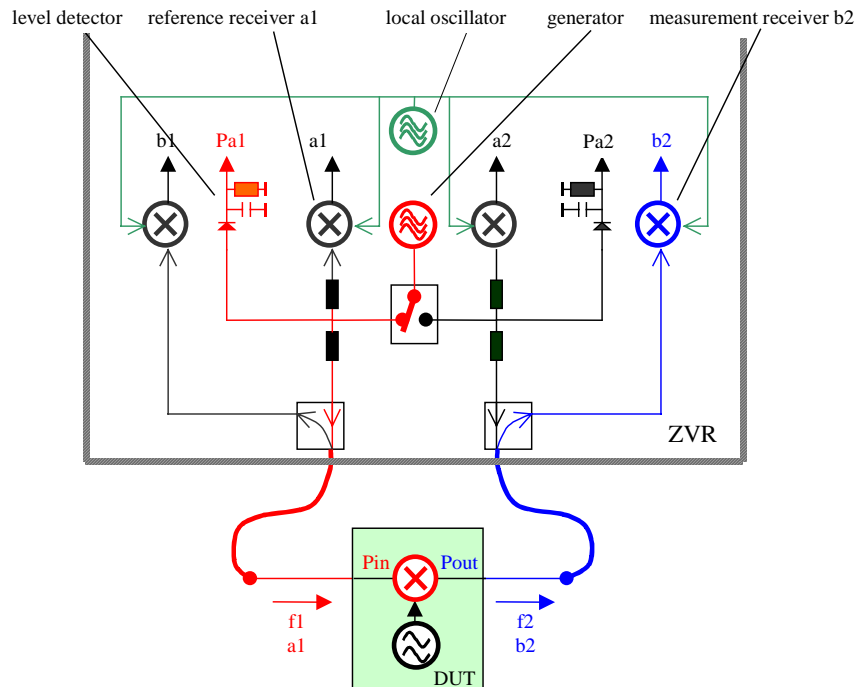

Fig. 2-2 Simplified block diagram of a ZVR setup for mixer measurements

3 ZVR Calibration for Measurements on Mixers

The accuracy of measurements on frequency-converting devices is determined primarily by the frequency response of the test setup, the linearity of the level detector and the matching of the measurement ports. At high frequencies in particular, the measurement error can be several dB. Errors due to the non-linearities of the selective measurement receiver b2 are usually negligible (see Appendix Fig. 5-1).

To improve the matching of the measurement ports, screw well-matched attenuators directly on to the ends of the measurement cables. If a high-quality, well-matched matching pad (e.g. R&S RAM) is used for impedance transformation at one of the measurement ports, only the 50 Ω port needs to be equipped with a well-matched attenuator. The additional loss caused by the attenuators and matching pads will of course influence the conversion gain measurement. A power calibration of the generator and the receiver makes it possible to determine and largely eliminate the influence of the complete test setup, and so also the losses caused by the attenuators and matching pads.

The Power Calibration Option R&S ZVR-B7 as well as the power meter and power sensor supported by this option are required to perform this power calibration. Because they are faster, diode sensors are preferred to thermal power sensors.

Instruments from the ZVR family support the following power meters for power calibration:

- R&S NRV
- R&S NRVS
- R&S NRVD
- Agilent HP 437
- Agilent HP 438
- Agilent E4417A
- Anritsu ML 2438A

Generator Power Calibration

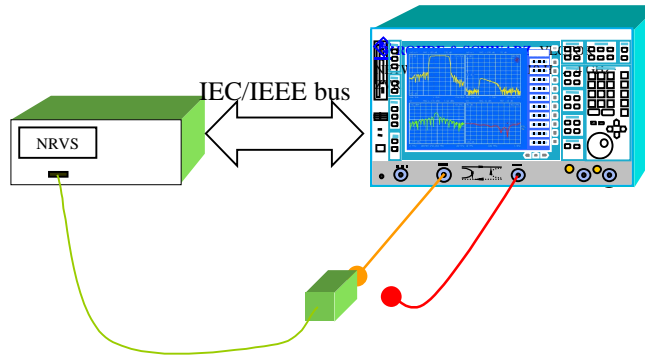

Fig. 3-1 Generator calibration using a power meter

To calibrate the generator, the power sensor is connected to the generator port in the measurement plane. The power meter is connected to the R&S ZVR via the IEEE system bus. For every frequency point, an automatic iteration process determines suitable correction values for the level detector of the analyzer's generator to set the required nominal level in the reference plane. If the generator power level is changed between calibration and measurement, accuracy depends on the linearity of the level detector Pa1 (see Appendix Fig 5-1).

Receiver Power Calibration

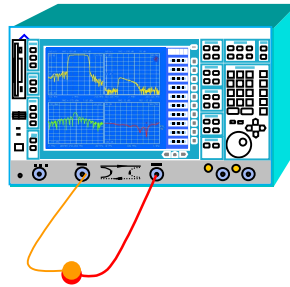

Fig. 3-2 Receiver calibration using the power-calibrated generator

The ZVR's power-calibrated generator is now a high-precision source to calibrate the R&S ZVR receiver b2 that has to be connected to the receiver in the measurement plane. The generator and receiver simultaneously sweep the same frequencies. At every frequency point, the ZVR compares the power measured by the b2 receiver to the power applied by the calibrated generator and determines receiver correction data from this difference. The absolute power measurement accuracy of the receiver (with an ideally matched and calibrated generator) mainly depends on the return loss of the DUT and the test port match. Receiver linearity errors are basically negligible over a wide level range.

Power calibration for Measurements on Frequency-Converting Devices

The power calibration for conversion gain measurements on mixers or converters requires several steps.

Power calibration for Mixers/Converters with the Same Input and Output Impedances

1. Calibrate the generator (strictly speaking the level detector) with the power meter at the RF input frequency and at the IF output frequency. The latter is necessary because the generator calibrated for the IF is also used to calibrate the receiver that is measuring the IF output signal. The frequency range to be calibrated, therefore, encompasses the whole RF and IF range.
2. Calibrate the receiver using the previously calibrated generator. The generator port and receiver port are connected back-to-back. The receiver is calibrated over the whole RF and IF frequency range as well.

Power calibration for Mixers/Converters with Different Input and Output Impedances

If impedances of both ports of the DUT are different, e.g. a 50 Ω input and a 75 Ω output)

1. Calibrate the generator and the receiver for the mixer output impedance. If, for example, the DUT has a 50 Ω input and a 75 Ω output, terminate the network analyzer's measurement ports with 75 Ω matching pads and calibrate the complete setup in a 75 Ω environment.
2. Remove the matching pad from the generator port and recalibrate the generator for the input impedance by using a 50 Ω power sensor connected to the generator port.

Two rules must be observed to achieve maximum measurement accuracy:

- **Use well-matched matching pads and attenuators**

The power calibration only eliminates the frequency response of the test setup, but not measurement errors due to test port mismatch. Make certain to use well-matched matching pads and attenuators directly in the measurement plane. If the same test setup is used to determine not only the conversion gain, but also the reflection coefficient of the converter, the attenuation at the appropriate port may not exceed 10 dB.

- **Use the segmented sweep for power calibration**

Since the power calibration must cover the RF and IF frequency ranges, a lot of test points between RF and IF would be "wasted" in a linear frequency sweep, especially in microwave applications. The spacing of the calibrated test points in the subsequently measured RF and IF bands would therefore be large. If a frequency is converted, from 38 GHz to 100 MHz for example, the frequency spacing is almost 19 MHz even if the maximum number of measurement points (2001) is used during calibration. The interpolation of correction values for subsequent test points may cause large measurement errors.

To avoid this problem, the instruments of the ZVR family (firmware 3.40 or higher) supports a power calibration using a segmented sweep. Up to 40

Mixer Measurements

different frequency segments can be defined in this sweep mode, and their points can be distributed almost arbitrarily along the frequency axis. Exactly those points that are subsequently used for measurements can be calibrated if two segments are selected, one for the RF input frequency and one for the IF output frequency, each with the same span and the same number of test points. Interpolation errors are, therefore, ruled out.

SWEEP SEGMENTS								
SEGM	START	STOP	POINTS	SRC PWR	TIME	AVG	IF BW	LOI
1	1000 MHz	2 GHz	201	-20 dBm	AUTO	1	10 kHz	+
2	11 GHz	12 GHz	201	-20 dBm	AUTO	1	10 kHz	+

For further details on power calibration, see Application Note [1EZ41_2](#), *Power Calibration of Vector Network Analyzer ZVR*.

4 Example

A converter with a constant LO (10 GHz) converts an RF signal with a frequency between 11 GHz to 12 GHz to an IF between 1 GHz and 2 GHz. The RF input impedance is 50 Ω, the IF output impedance 75 Ω.

RF	11 GHz to 12 GHz
LO (internal)	10 GHz
IF	1 GHz to 2 GHz; $f(\text{IF}) = f(\text{RF}) - f(\text{LO})$

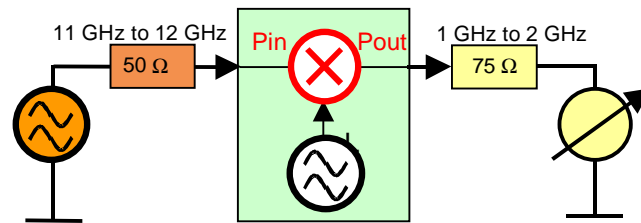

Fig. 4-2 Frequency converter with different input and output impedances

The following accessories are used for calibration and measurement:

Vector Network Analyzer	R&S ZVM
Power Calibration Option	R&S ZVR-B7
Mixer Measurements Option	R&S ZVR-B4
Matching Pads (50 Ω / 75 Ω)	R&S RAM (2x)
Attenuator	R&S DNF 6 dB
Power Meter	R&S NRVD
Power Sensor 50 Ω	R&S NRV-Z1
Power Sensor 75 Ω	R&S NRV-Z3

Configuring Segmented Sweeps

To prevent errors due to correction-data interpolation, use the segmented sweep for calibration. The first segment covers the frequency range of the IF output signal (1 GHz to 2 GHz), the second segment the RF input signal (10 GHz to 11 GHz). The frequency span and the number of test points for both segments are identical. The number of test points per segment must be identical to the number of test points for the subsequent measurement. This ensures that the test point grid for calibration and for measurement is exactly the same.

PRESET:																																					
SWEEP:	DEFINE SWEEP SEGMENTS INSERT NEW SEGMENT INSERT NEW SEGMENT																																				
<table border="1" style="width: 100%; border-collapse: collapse; margin: 10px auto;"> <thead> <tr style="background-color: #0056b3; color: white;"> <th colspan="9">SWEEP SEGMENTS</th> </tr> <tr style="background-color: #e0e0e0;"> <th>SEGM</th> <th>START</th> <th>STOP</th> <th>POINTS</th> <th>SRC PWR</th> <th>TIME</th> <th>AVG</th> <th>IF BW</th> <th>LO1</th> </tr> </thead> <tbody> <tr> <td>1</td> <td>1000 MHz</td> <td>2 GHz</td> <td>201</td> <td>-20 dBm</td> <td>AUTO</td> <td>1</td> <td>10 kHz</td> <td>+</td> </tr> <tr> <td>2</td> <td>11 GHz</td> <td>12 GHz</td> <td>201</td> <td>-20 dBm</td> <td>AUTO</td> <td>1</td> <td>10 kHz</td> <td>+</td> </tr> </tbody> </table>		SWEEP SEGMENTS									SEGM	START	STOP	POINTS	SRC PWR	TIME	AVG	IF BW	LO1	1	1000 MHz	2 GHz	201	-20 dBm	AUTO	1	10 kHz	+	2	11 GHz	12 GHz	201	-20 dBm	AUTO	1	10 kHz	+
SWEEP SEGMENTS																																					
SEGM	START	STOP	POINTS	SRC PWR	TIME	AVG	IF BW	LO1																													
1	1000 MHz	2 GHz	201	-20 dBm	AUTO	1	10 kHz	+																													
2	11 GHz	12 GHz	201	-20 dBm	AUTO	1	10 kHz	+																													
	↑ SEG SWEEP																																				

Calibrating the Generator and Receiver

1. In the measurement plane, screw 75 Ω matching pads to both ends of the measurement cable to perform the power calibration for the DUT output impedance (75 Ω).
2. Connect the power meter's IEEE bus to the IEC/IEEE system bus of the R&S ZVR (IEC/IEEE system bus).
3. Set the instrument-specific data of the power meter in the R&S ZVR's configuration menu.
4. Connect the 75 Ω sensor to the measurement plane (directly in front of the DUT input)
5. Calibrate the generator.

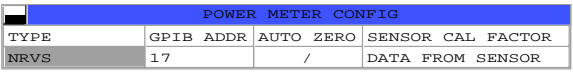
CAL:	START NEW POWER CAL POWER METER CONFIG
	
	NUMBER OF READINGS 1 CAL a1 <i>-20 dBm</i> TAKE CAL SWEEP

6. Connect the calibrated generator directly to the receiver via a well-matched, low-loss adapter (THROUGH from a 75 Ω calibration kit) to calibrate the receiver.

	CAL b2 POWER TAKE CAL SWEEP
--	--------------------------------

The generator and receiver (both 75 Ω) are now calibrated. The CAL a1 and CAL b2 enhancement labels are active.

7. Calibrate the generator for 50 Ω . The matching pad is removed and replaced with a well-matched attenuator. The 50 Ω sensor and port 1 are connected and the generator is then calibrated again. It is absolutely essential to use the output level you are going to use for subsequent measurements for the calibration too.

CAL:	CAL a1 <i>-20 dBm</i> TAKE CAL SWEEP
-------------	---

After the test system has been calibrated, connect the converter. The generator and receiver settings for conversion gain measurements are configured in mixer mode.

Mixer Measurements

Measurement

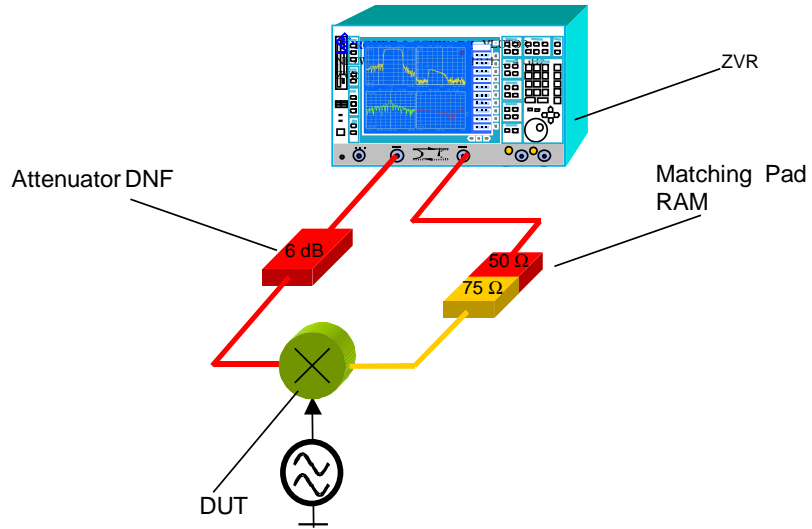
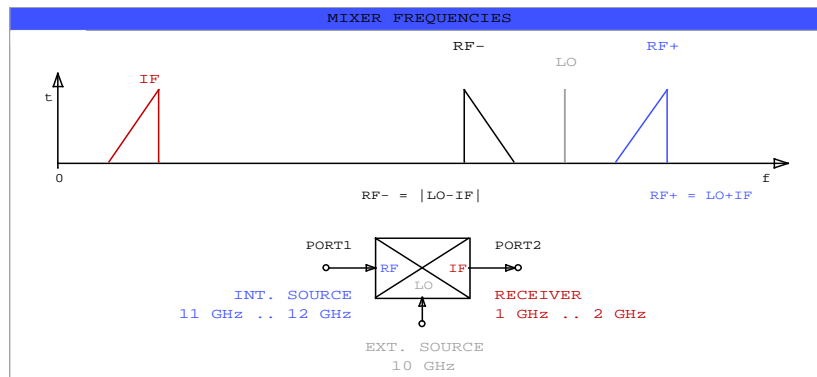

Fig. 4-3 Test setup

SWEEP	LIN SWEEP
MODE	FREQUENCY CONVERTERS DEFINE MIXER MEAS IF=BASE FREQUENCY
START 1 GHz	
STOP 2 GHz	
	FIXED LO 10 GHz SEL BAND (+) ↑ (to return to the higher-level softkey menu and switch off the configuration graphics) MIXER MEAS (activates the mixer measurement mode and automatically selects b2/Pa1)

The configuration-graphics display clearly shows the R&S ZVR settings. When you press ↑, the graphics cease to be displayed, but they can be recalled whenever you want by pressing DEFINE MIXER MEAS



Mixer Measurements

The measured conversion gain is displayed on the screen.

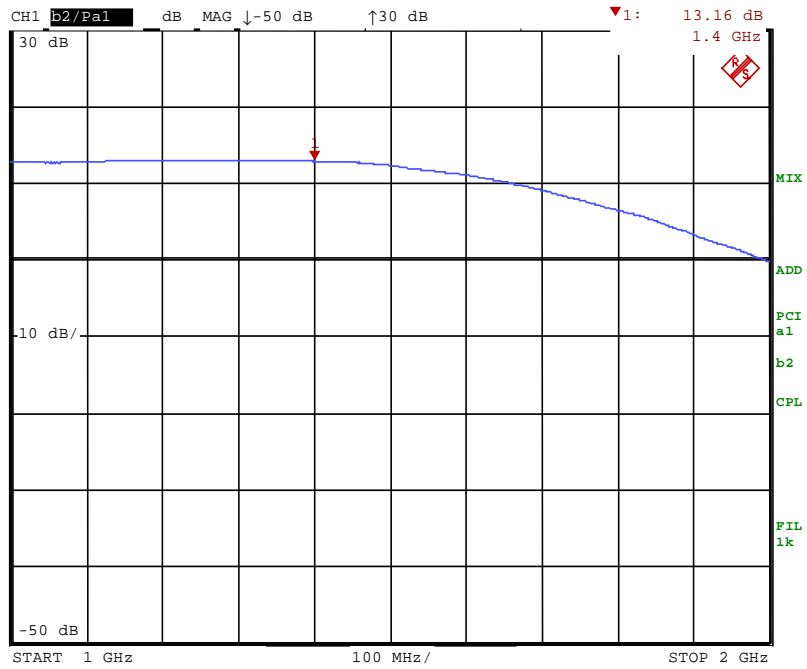

Fig. 4-4 Measured conversion gain of a converter

Because the frequency range and number of test points were different for calibration and measurement, the **Power Calibration Interpolated (PCI)** enhancement label shows that the test-point correction values are interpolated. This is not the case, of course – the algorithm is simply not smart enough to handle the situation.

5 Appendix

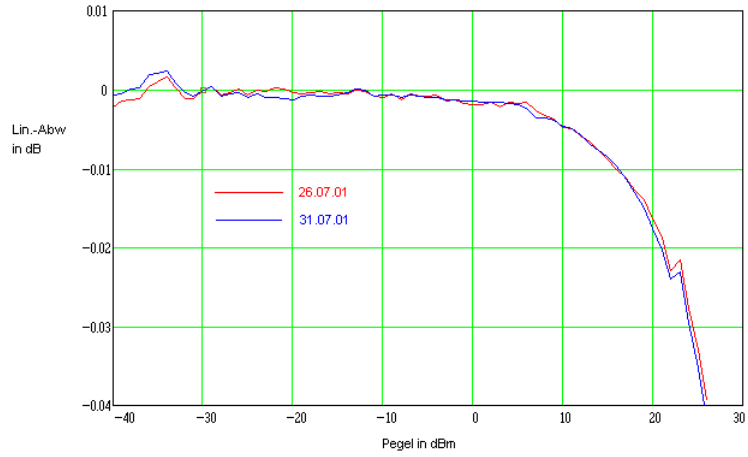

Fig. 5-1 Typical linearity of the receiver b2 at 50 MHz

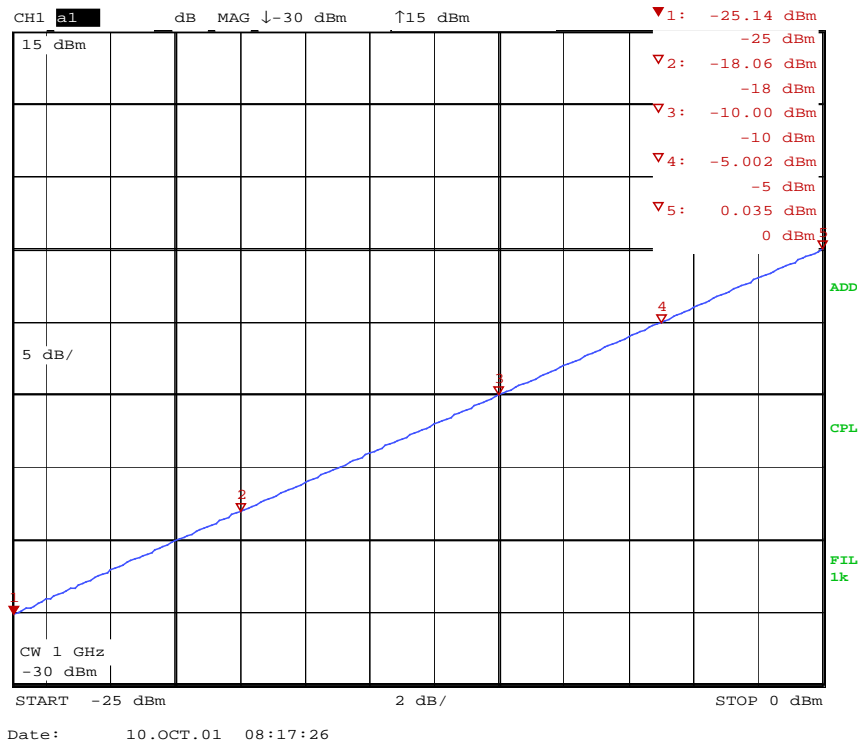

Fig. 5-2 Typical output-level linearity at 1 GHz

6 Further Application Notes

- [1] O. Ostwald: 3-Port Measurements with Vector Network Analyzer ZVR, Appl. Note 1EZ26_1E, 26 July 1996.
- [2] H.-G. Krekels: Automatic Calibration of Vector Network Analyzer ZVR, Appl. Note 1EZ30_2E, 30 August 1996.
- [3] O. Ostwald: 4-Port Measurements with Vector Network Analyzer ZVR, Appl. Note 1EZ25_1E, 10 October 1996.
- [4] T. Bednorz: Measurement Uncertainties for Vector Network Analysis, Appl. Note 1EZ29_1E, 21 October 1996.
- [5] P. Kraus: Measurements on Frequency-Converting DUTs using Vector Network Analyzer ZVR, Appl. Note 1EZ31_1E, 5 November 1996.
- [6] J. Ganzert: File Transfer between Analyzers FSE or ZVR and PC using MS-DOS Interlink, Appl. Note 1EZ34_1E, 25 April 1997.
- [7] J. Ganzert: Accessing Measurement Data and Controlling the Vector Network Analyzer via DDE, Appl. Note 1EZ33_1E, 28 April 1997.
- [8] O. Ostwald: Group and Phase Delay Measurements with Vector Network Analyzer ZVR, Appl. Note 1EZ35_1E, 10 July 1997.
- [9] O. Ostwald: Multiport Measurements using Vector Network Analyzer, Appl. Note 1EZ37_2E, 10 October 1997.
- [10] O. Ostwald: Frequently Asked Questions about Vector Network Analyzer ZVR, Appl. Note 1EZ38_3E, 19 January 1998.
- [11] A. Gleißner: Internal Data Transfer between Windows 3.1 / Excel and Vector Network Analyzer ZVR, Appl. Note 1EZ39_1E, 22 January 1998.
- [12] A. Gleißner: Power Calibration of Vector Network Analyzer ZVR, Appl. Note 1EZ41_2E, 10 March 1998.
- [13] O. Ostwald: Pulsed Measurements on GSM Amplifier SMD ICs with Vector Network Analyzer ZVR, Appl. Note 1EZ42_1E, 19 May 1998.
- [14] O. Ostwald: Time Domain Measurements using Vector Network Analyzer ZVR, Appl. Note 1EZ44_0E, 19 May 1998.
- [15] O. Ostwald: T-Check Accuracy Test for Vector Network Analyzers utilizing a Tee-junction, Appl. Note 1EZ43_0E, 3 June 1998.
- [16] J. Simon: Virtual Embedding Networks for Vector Network Analyzer ZVR, Appl. Note 1EZ45_0E, 23 September 1998.
- [17] J. Ganzert: Controlling External Generators and Power Meters with Network Analyzer ZVR, Appl. Note 1EZ46_0E, October 1998.
- [18] A. Gleißner: Using the Frequency Conversion Mode of Vector Network Analyzer ZVR, Appl. Note 1EZ47_0E, 18 January 1999.
- [19] O. Ostwald: Measurement Accuracy of Vector Network Analyzer ZVK Appl. Note 1EZ48_0E, 24 January 2001.
- [20] J. Simon: Reading and Modifying the Correction Data for System Errors and Power of a ZVR Vector Network Analyzer, Appl. Note 1EZ47_0E, 19 April 2001.

7 Additional Information

Comments and suggestions regarding this Application Note should be sent to TM-Applications@rsd.rohde-schwarz.com

8 Ordering Information

Vector Network Analyzer ZVK	10 MHz to 40 GHz	1127.8651.60
Vector Network Analyzer ZVM	10 MHz to 20 GHz	1127.8500.60
Vector Network Analyzer ZVC	20 kHz to 8 GHz	1127.8600.60/61/62
Vector Network Analyzer ZVCE	20 kHz to 8 GHz	1127.8600.50/52
Vector Network Analyzer ZVR	9 kHz to 4 GHz	1127.8551.61/62
Vector Network Analyzer ZVRE	9 kHz to 4 GHz	1127.8551.51/52
Vector Network Analyzer ZVRL	9 kHz to 4 GHz	1127.8551.14



ROHDE & SCHWARZ GmbH & Co. KG · Mühlendorfstraße 15 · D-81671 München · Postfach 80 14 69 · D-81614 München ·
Tel (089) 4129 - 0 · Fax (089) 4129 - 13777 · Internet: <http://www.rohde-schwarz.com>

This application note and the supplied programs may only be used subject to observance of the conditions of use set forth in the download area of the Rohde & Schwarz Website.